

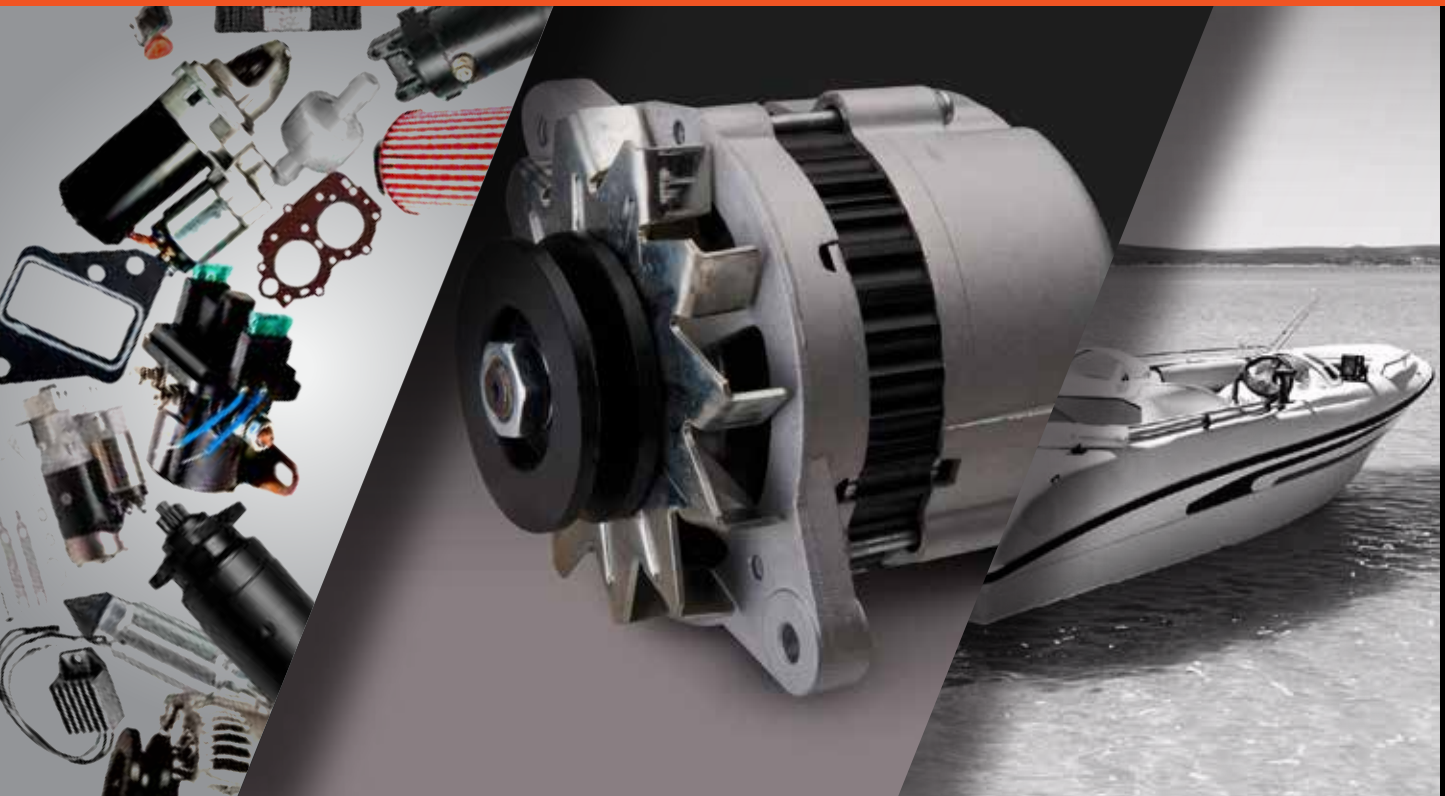

Sierra[®]

Marine Engine and Drive Parts

ENGINE & DRIVE PARTS • SWITCHES • INSTRUMENTATION • DIAGNOSTICS • SHIELDS HOSE



2014

SIERRA MARINE PARTS CATALOG

8028

Part #	Description	OEM	OEM Part Number
16-105-0340	3/4 Polyx Sanitation Hose 50' Coil		
16-105-0343	3/4 Polyx Sanitation Hose 10' Lgth		
16-105-0344	3/4 Polyx Sanitation Hose 12 1/2' Lgth		
16-350-1120	1 1/2 X 50 Fire-Acol Fuel Fill Type A2		
16-350-1123	1 1/2 X 10 Fire-Acol Fuel Fill Type A2		
16-350-1124	1 1/2 X 12 1/2' Fire-Acol Fuel Fill Type A2		
18-01422	Manual		
18-01707	Manual		
18-09002	Manual		
18-09006	Manual		
18-09202	Manual		
18-09400	Manual		
18-09602	Manual		
18-09606	Manual		
18-1076	Bellows	Volvo	3888916
18-1830	Water Seal Damper	Yamaha	663-44366-00
18-1831	Water Seal Damper	Yamaha	682-44366-00
18-1832	Water Seal Damper	Yamaha	682-44367-00
18-1833	Water Seal Damper	Yamaha	647-44366-00
18-1834	Water Seal Damper	Yamaha	682-44365-00
18-2446	Quick Drain / Fill Drain Plug Kit	Mercury / BRP	
18-2447	Quick Drain / Fill Drain Plug Kit		
18-3480	Water Pump Housing	Suzuki	17411-93901
18-3481	Water Pump Housing	Suzuki	17411-94421
18-3495	Diaphragm Kit	Suzuki	15170-93911
18-3496	Diaphragm Kit	Suzuki	15170-94320
18-3709	Prop Nut	Yamaha	647-45616-02
18-3773	Prop Nut	Yamaha	90171-10M01
18-4726	Valve Seal		
18-4727	Valve Spring		
18-4728	Valve Spring		
18-4729	Valve Retainer, Vortec		
18-4730	Valve Retainer		
18-4731	Valve Lock		
18-4732	Intake Valve (1.94)		
18-4733	Exhaust Valve (1.50)		
18-4734	Intake Valve (1.84)		
18-4735	Intake Valve (2.02)		
18-4736	Exhaust Valve (1.60)		
18-4737	Rocker Arm Stud		
18-5130	CDI	Yamaha	688-85540-16
18-5131	CDI	Yamaha/Mercury	695-85540-11 s/s to -12 / 43077T
18-5132	CDI	Yamaha	63V-85540-01
18-5183	Coil, Charge	Yamaha	63V-85520-00
18-5195	Coil, Ignition	Yamaha	689-81311-40
18-5300	Rotor		
18-5301	Tune-Up Kit		N/a
18-5302	Tune-Up Kit		N/a
18-5746	Stator Assy	Yamaha	6H3-85510-A0 s/s A1
18-59640	Alternator	Prestolite	
18-59700	Alternator	Volvo	3803227, -2, 834625-6, 841378-3, 841380, 841762, 63, 65, 66,
18-5982	Alternator	Cummins	216040, 3604234RX
18-6128A	Anode Kit	Volvo	
18-6128M	Anode Kit	Volvo	
18-6128Z	Anode Kit	Volvo	
18-6129A	Anode Kit	Volvo	
18-6129M	Anode Kit	Volvo	
18-6129Z	Anode Kit	Volvo	
18-6130	Anode	Volvo	
18-6131	Anode	Volvo	
18-6132A	Anode Kit	Yamaha	

Part #	Description	OEM	OEM Part Number
18-6132M	Anode Kit	Yamaha	
18-6133A	Anode Kit	Yamaha	
18-6133M	Anode Kit	Yamaha	
18-6134	Anode		
18-6135	Anode		
18-6136	Anode		
18-6137	Anode		
18-6200	Anode	Yanmar	27210-200200
18-6201	Anode	Yanmar	27210-200300
18-6811	Trim Motor	Yamaha	62X-43880-00-00, -01-00, -09-00
18-6812	Trim Motor	Yamaha	62X-43880-00-00, 62X-43880-01-00, 62X-43880-09-00
18-6813	Trim Motor	MerCruiser	14336A6, A8, A9, A15, A20, 88183A5, A8, A12, 865380A13, A25
18-6814	Trim Motor	OMC	984356
18-6815	Trim Motor	Johnson/Evinrude	5005831
18-6816	Trim Motor	OMC	172588, 173944
18-6817	Trim Motor	Volvo Penta	854525-3
18-6818	Trim Motor	Power Pole	PUMP SPN-F
18-6819	Trim Motor	Power Pole	PUMP PRO-F
18-6821	Trim Motor	Yamaha	688-43880-11-00, 6E5-43880-01-00, -02-00
18-6822	Trim Pump	Volvo Penta OMC	852928, 820545 172543, 382715
18-6823	Wiring Harness	Universal	Universal
18-6824	Starter	MerCruiser	50-60594A, A1, T01
18-6825	Starter	Mercury	50-86976
18-6826	Starter	Johnson/Evinrude	586768
18-6827	Starter	Suzuki	31100-94600, 31100-94601, 31100-94610
18-6828	Starter	Mercury	50-41583
18-6829	Starter	Mercury	50-852570, T, 50-857065, 50-859168, T, 859168, T
18-6831	Starter	Suzuki Hitachi	31100-90J00 S114-837, A
18-6832	Starter	Yamaha	60V-81800-00-00, 60X-81800-00-00
18-6833	Starter	Yamaha	69J-81800-00-00
18-6834	Starter	GM Engines	Universal
18-6835	Starter	GM Engines	Universal
18-6836	Trim Motor	Yamaha	6C5-43880-00-00
18-6837	Trim Motor	Honda Suzuki	36120-Zv5-822 38100-87J11, 38100-87J20
18-6838	Trim Motor	Volvo	3586765, 852928, 872449, 873051
18-6839	Starter	Volvo	1357199, -7, 3523301, -4, 5003564, -1
18-6840	Alternator	Mercury	50-897755T, 897755T
18-6841	Alternator	MerCruiser OMC	56045, 59755, 69729 983836, 988247
18-6842	Alternator	MerCruiser OMC	56045, 59755, 69729 983424, 836, 247
18-6843	Alternator	Mando Yamaha	A000b0341, TA000B0341 19-1400-10
18-6844	Alternator	MerCruiser Denso	834832, T2, 857006A3 101211-3460
18-6845	Alternator	Volvo	3862613, 3862665, 3884950
18-6846	Alternator	Volvo Penta	1502272, 3803270-2, 5001677, 845940, 72021, 872022, 872757, 873635, 873757, 873757-9, 873771,
18-6847	Alternator	Volvo	3862613, 2655301
18-6848	Alternator	Volvo Valeo	3862612, 2656299, A0002655299

Part #	Description	OEM	OEM Part Number
18-6849	Alternator	Yanmar Denso	119773-77200 101211-9940
18-6850	Battery Disconnect Relay	Universal	Universal
18-6851	Battery Isolator	Universal	Universal
18-6852	Battery Isolator	Universal	Universal
18-6853	Battery Isolator	Universal	Universal
18-6854	Battery Isolator	Universal	Universal
18-6855	Battery Isolator	Universal	Universal
18-6856	Battery Isolator	Universal	Universal
18-6857	Voltage Regulator	Yamaha PWC	63M-81960-00-00
18-6858	Voltage Regulator	Yamaha PWC	6H2-81960-00-00
18-6859	Solenoid	Sea-Doo	278-001-376, 278-001-802
18-6860	Solenoid Plug	Sea-Doo	
18-6861	Starter	Yamaha Hitachi	61A-81800-01-00, 61H-81800-01-00, 69L-81800-00-00/ S114-559B
18-6862	Starter	Yamaha	6M6-81800-10-00
18-6863	Starter	OMC	584605, 586275
18-6864	Starter	Mercury	50-819271, 50-820193A1
18-6865	Complete Trim Assembly	Honda, OMC, Suzuki, Tohatsu, Yamaha	Universal OMC 5005114 Suzuki 48600-94511-0ED
18-6866	Starter	Sea-Doo	278-000-576, 278-000-577, 278-001-038, 278-001-301
18-6867	Starter	Sea-Doo Denso	278-000-484, 278-000-485, 278-001-300, 278-001-935 228000-4550
18-6868	Starter	Sea-Doo Denso	278-000-186, 311, 316 995435 128000-4860, 61, 62, 63, 64
18-6869	Starter	Sea-Doo	278-001-497, 278-001-936
18-6870	Starter	Mercury	50-805833, T
18-6871	Trim Motor	Sea-Doo	278-001-292
18-6872	Starter	Volvo	233991, 240501, 837924, 842775, 843511, 847306-8, 881681
18-6873	Starter	Kawasaki Denso	21163-3715 21163-3719 428000-0081
18-6874	Voltage Regulator	Sea-Doo	278-001-581
18-6875	Trim Motor	Kawasaki PWC	21174-3703
18-6876	Voltage Regulator	Sea-Doo	278-001-554
18-6877	Starter	Honda PWC	31200-HW1-671
18-6878	Voltage Regulator	Sea-Doo	278-000-123
18-6879	Voltage Regulator	Sea-Doo	278-001-239
18-6880	Starter	Yanmar Hitachi	129573-77010, 171008-77010 S114-257, 257G, 483, 483A
18-6881	Trim Motor	Volvo Prestolite	852928, 872449, 873051
18-6904	Trim Motor	Kawasaki	21163-3720, 21163-3721
18-6905	Starter	Sea-Doo	290-888-993, 999, 420-888- 9933, -994, -996
18-6906	Starter	Yamaha PWC	64X-81800-00-00
18-6907	Starter	Yamaha PWC	6D3-81800-00-00
18-6908	Starter	Yamaha PWC	63M-81800-00-00
18-6909	Starter	Yamaha PWC	6S5-81800-00-00
18-6919	Starter	Arctic Cat PWC	3008-093, 3008-327, 3008- 462, 3008-536
18-6921	Starter	Yamaha PWC	60E-81800-00-00
18-6925	Alternator	Yanmar Hitachi	128270-77200 LR135-105
18-6926	Alternator	Yanmar	119836-77200, -2, -3 129612-77230

Part #	Description	OEM	OEM Part Number
18-6927	Alternator	Yanmar	119573-77200, 119573-77201, 129470-77200
18-6928	Alternator	Yanmar Hitachi	128170-77200, 77201, 77202 LR135-74, 74B
18-6929	Alternator	Yanmar Hitachi	119573-77200, 77201 129470-77200
LR180-03A, B, C			
18-6930	Starter	Yanmar	104211-77010, 77011
18-6931	Starter	Yanmar	119209-77010, 121120-77010, 77011, 77012, 124520-77010, 77011
18-6932	Starter	Yanmar	121370-77010, 129242-77010, 129698-77010
18-6934	Starter	Yanmar Hitachi	123500-77010, 124610-77010, -77019 424610-77010 S13-68, 68A, 68C, 86
18-6935	Starter	Yanmar	119225-77010, 77011, 119226-77010
18-6936	Starter	Yanmar	114361-77011, 114362-77010, 77011 114399-77010
18-6937	Starter	Yanmar Hitachi	128170-77010, 77010D S114-303, 303A
18-6938	Starter	Yanmar	119773-77010
18-6939	Starter	Yanmar	121254-77010, 77011, 77012, 77019, 129429-77010, 77011
18-6940	Starter	Mercury	50-825991A2
18-6941	Starter	Suzuki	31100-93J00, 96J00, 96J01
18-6942	Starter	Yamaha Hitachi	69W-81800-00-00 S114-682
18-6943	Starter	Mercury Yamaha	50-893894, 66M-81800-01-00, 02-00
18-6944	Starter	Bosch Caterpillar Perkins Volvo	0-001-109-035 163-3361 185086600 21323043, 3583555,
18-6945	Starter	Johnson Suzuki	5036972 31100-95J00, 95J01
18-6946	Starter	Mercuriser	50-8m8021116
18-6947	Starter	Mercuriser	50-805991
18-6948	Starter	Mercury	882571
18-6949	Starter	Mercuriser	50-831001961
18-6952	Alternator	Cummins Delco	214169, 3603853RX, 3920618 10459244, 1100077, 93 1100211, 74 1105474, 75, 76
18-6953	Alternator	Volvo	3803645, 8602629, 8602710, 14 8676496, 98, 8676499
18-6954	Starter	Mercury	50-831001671, 672, 50- 831002050, 051, 052
18-6955	Alternator	Caterpillar Prestolite Volvo	3001117 10-258, 110-258, 110-258A 849748-9
18-6956	Starter	Volvo	6209190
18-6957	Starter	Mercuriser	50-801333980, 50-854178, 50-855507
18-6958	Starter	Volvo	847308-4, 870998, 881682
18-6959	Starter	Honda	31200-Zy6-003, 31200-ZY9-003, 31200-ZY9A-0031,
18-6960	Alternator	Mercuriser Denso	821663, -1, A1 101211-3020, 3021

Part #	Description	OEM	OEM Part Number
18-7049	Needle Valve	Yamaha	61N-14392-00 s/s to 6L2-14392-00
18-7054	Needle Valve	Yamaha	6G1-14546-00 s/s to -01
18-7055	Needle Valve	Yamaha	6E5-14546-00
18-7056	Needle Valve	Yamaha	6H3-14590-00
18-7058	Carburetor Kit	Yamaha	63V-W0093-00
18-7059	Carburetor Kit	Yamaha	677-W0093-00 s/s to -04
18-7060	Needle Valve	Yamaha	692-14590-00
18-7063	Float	Yamaha	6L2-14385-00
18-7064	Float	Yamaha	63V-14985-00
18-7065	Float	Yamaha	647-14385-00
18-7066	Float	Yamaha	648-14385-00
18-7067	Float	Yamaha	6G1-14985-00
18-7068	Float	Yamaha	6E5-14385-01
18-7069	Float	Yamaha	6E5-14385-02
18-7073	Needle Valve	Yamaha	6E8-14390-12
18-7079	Needle Valve	Yamaha	626-14390-90
18-7083	Primer Bulb	Mercury	858763
18-7340	Fuel Pump	Yamaha	68V-13907-00 s/s to -03
18-7341	Fuel Pump	Yamaha	66K-13907-00
18-7342	Fuel Pump	Yamaha	68F-13907-00 s/s to -01
18-7343	Fuel Pump	Yamaha	60V-13907-00
18-7388	Diaphragm	Yamaha	6G1-24411-00
18-7389	Diaphragm	Yamaha	6E0-24411-00
18-7390	Diaphragm	Yamaha	63V-24411-00
18-7391	Diaphragm	Yamaha	692-24411-00
18-7392	Float	Yamaha	676-14985-01
18-7393	Float	Yamaha	6E7-14385-00
18-79910	Fuel Filter Assy	Yamaha	61N-24560-10
18-79960	Fuel Filter Element	Yanmar	104500-55710
18-79970	Fuel Filter	Yamaha	6BG-13915-00
18-79971	Oil Strainer, Electric	Yamaha	68F-13440-00
18-79972	Element, Filter (Carb Inlet)	Yamaha	67F-14371-01
18-79973	Fuel Filter	Yamaha	6C5-13915-00
18-79974	Oil Strainer	Yamaha	6J8-13411-00
18-79975	Oil Strainer	Yamaha	6E5-13411-00
18-79976	Oil Strainer	Yamaha	61A-13411-00
18-79977	Fuel Filter	Yamaha	6L5-24251-00
18-8925	Impeller	Yamaha	6AW-44352-00-00
18-8926	Impeller	Crusader	RP061022
18-9751-0	Power Trim And Steering Fluid 8 Oz. Bottle		
18-9751-2	Power Trim And Steering Fluid 1 Qt.		
18-99140	Head Gasket	Yamaha	63V-11181-A1 s/s to A2
18-99141	Cover Gasket	Yamaha	6H3-11193-A1
18-99142	Thermostat Gasket	Yamaha	6E9-12414-A0 s/s to A1
18-99143	Valve Seal Gasket	Yamaha	6H3-13621-A1
18-99144	Mixing Cover Gasket	Yamaha	6E7-14227-00
18-99145	Carburetor Gasket	Yamaha	677-14198-00 s/s to A1
18-99146	Float Chamber Gasket	Yamaha	677-14384-01
18-99147	Fuel Pump Gasket	Yamaha	6G1-24431-01
18-99148	Outer Exhaust Cover Gasket	Yamaha	688-41114-A0
18-99149	Water Pump Gasket	Yamaha	663-44316-A0
18-99150	Upper Casing Gasket	Yamaha	63V-45113-A1
18-99151	Upper Casing Gasket	Yamaha	688-45113-A0
18-99152	Lower Casing Gasket	Yamaha	683-45315-A0
18-99175	Powerhead Gasket Set	Yamaha	63V-W0001-00 s/s to 01
18-99176	Powerhead Gasket Set	Yamaha	6H3-W0001-02
18-ADA510	Mefi Neoprene Cable Bag		
18-ADA512	Generic Neoprene Cable Bag		
18-ADC199	Jack Screws For Stats Console		
18-ADC300E	Stats Master Cable 20'		
18-ADC415	Volvo Diesel Diagnostic Cable		
18-ADC417	Yanmar Diesel Diagnostic Cable		
18-ADC425	Mefi V-Vi Cable		

Part #	Description	OEM	OEM Part Number
18-SD100	Stats Kit-- Tester Only		
18-SD111	Mercury/Mercruiser/Mefi Upgrade Kit		
18-SD112	Brp Outboard Upgrade Kit		
18-SD113	Yamaha Outboard Upgrade Kit		
18-SD114	Suzuki Upgrade Kit		
18-SD115	Yamaha Pwc Upgrade Kit		
18-SD116	Kawasaki Pwc Upgrade Kit		
18-SD117	Seadoo Pwc Upgrade Kit		
18-SD118	Full Pwc Package		
18-SD119	Inboard/Outboard Package		
18-SD120	Volvo D3, D4, D6 Package	Volvo	
18-SD202	Complete Kit Plus		
18-SD405	Hydrospace/Benelli/Weber Upgrade Kit		
18-SD406	Volvo D3, D4, D6 Upgrade Kit		
18-SD407	Yanmar Diesel Upgrade Kit		
18-SD413	Mefi V-Vi Upgrade Kit		
35-SS655	Safe Skeg	Volvo	
35-SS670	Safe Skeg	Johnson/Evinrude	
35-SS680	Safe Skeg	Johnson/Evinrude	
35-SS685	Safe Skeg	Honda	
35-SS690	Safe Skeg	Yamaha	
35-SS715	Safe Skeg	Mercury	
69992D	Fuel Secondary Matrix		
69993D	Trim - Matrix		
69994D	Water Pressure - Matrix		
69995K	Harness - Tachometer To Smartcraft, 30		
69996K	Harness - Tachometer To Nmea, 30		
69997K	Harness - Tachometer To Speedometer, 48		
69998K	Terminator - Needed When No Speedometer Is Used		
69999K	Harness - Any 2 Gauge To Another, 8		
70000D	Tachometer, Matrix, Smartcraft		
70001D	Tachometer, Matrix, Nema 2000		
70002D	Speedometer - Matrix		
70003D	Fuel Primary Matrix		
70004D	Voltmeter - Matrix		
70005D	Oil Pressure - Matrix		
70006D	Water Tempature - Matrix		
781-310-035P	Speedo Gps, Lido, 35 Mph		
781-310-060P	Speedo Gps, Lido, 60 Mph		
781-579-060P	Speedo Gps, Amega, 60 Mph		
781-625-060P	Speedo Gps, White Premier Pro 60 Mph		
781-627-060P	Speedo Gps, Black Premier Pro 60 Mph		
781-683-060P	Speedo Gps, Arctic, 60 Mph		
781-684-060P	Speedo Gps, Eclipse, 60 Mph		
MP28850	Universal Cut-Off Switch Lanyard		
RK19210	Switch, Contura V On-Off Spst		
RK19220	Switch, Contura V On-Off-On Spdt		
RK19230	Switch, Contura V (On)-Off Spst		
RK19240	Switch, Contura V (On)-Off-(On) Dpdt		
RK19310	Switch, Contura V On-Off Illuminated Spst		
RK19320	Switch, Contura V On-Off-On Illuminated Spdt		
RK22100	Actuator, Black Contura Iii (2Ea)		
RK22110	Actuator, Gray Contura Iii (2Ea)		
RK22120	Acuator, Black Contura Iii W/Lens (2Ea)		
RK22130	Acuator, Gray Contura Iii W/Lens (2Ea)		
RK22140	Acuator, Black Contura Iii W/2 Lens (2Ea)		
RK22150	Acuator, Gray Contura Iii W/2 Lens (2Ea)		
RK22160	Actuator, Black Contura Ii (2Ea)		
Rk22170	Actuator, Red Contura Ii (2Ea)		
RK22180	Actuator, Black Contura V (2Ea)		
RK22190	Acuator, Black Contura V W/Lens (2Ea)		
RK22200	Acuator, Black Contura V W/2 Lens (2Ea)		
RK22290	Acuator Removal Tool		



All references to Original Equipment Manufacturers, their trade names, or their part numbers are for replacement part identification only. All Sierra Marine Products are designed to meet or exceed the OEM part they are intended to replace and are backed by the best warranty in the business.

TABLE OF CONTENTS

GAUGE SECTION

Ordering Information.....	2-3	Driftwood	10	Arctic.....	15
Eyebrow Bezels.....	4	Lido.....	8-9	Eclipse.....	16
GPS Speedometers.....	5	Sahara.....	11	Heavy Duty.....	17
Multi Gauges	5	Sterling	12	Senders	18
Matrix Gauges	4	Black Sterling.....	13	Sender Codes/Accessories	19-21
Premier Pro	6	Omega	14		
White Premier Pro	7				

SIERRA SWITCH & ELECTRICAL PRODUCTS (MARINE WORKS SECTION)

Audible Engine Warning System	52	Gas Filled Lift Supports and Accessories (Nautalift™)	23-24	Ring, Spade and Hook Terminals.....	57
Bait Well Light.....	58	Glove Box Locks/Latches	57-58	Terminal and Wiring Accessory Kits.....	57
Battery Cables.....	56	Ignition Switches.....	25-31	Waterproof Terminals and Connectors.....	57
Battery Isolators.....	56	Illumination Modules.....	35	Solenoid Switches	55
Battery Switches.....	56	Indicator Lights	43-44	Switch Buyers Guide	33
Battery Terminals.....	56	Junction Blocks.....	50	Test Clips.....	56
Bus Bars/Covers.....	49-50	Lanyards.....	32	Testers	57
Cigarette Lighter/Chart Light	52	Lever Switches	54	Toggle Switches.....	41-43
Circuit Breakers	52	Locks & Latches	60	Trailer Bearing Kits/Sets	57
Compartment Locks and Latches	57-58	Push Button Switches.....	45-46	Trailer Connectors	53-54
Contura® Switches.....	35-38	Push Pull Switches.....	44-45	Adapters.....	54
Cotter Pins.....	57	Replacement Knobs	34	Converters and Isolators.....	54
Docking Lights.....	60	Rocker Switches.....	38-40	Universal (Splice-In Style) Trailer Connectors.....	52-54
Electrical Tools and Testers	57	Rotary Switches (Roto Switch®) & Accessories	34	Heavy Duty Connectors	54
Emergency Engine Cutoff Switches	32	Solderless Terminals and Connectors.....	57-58	Molded Vinyl Connectors	53
Face and Boot Nuts.....	32,46,52	Electrical Accessories	58-59	Polarized Connectors.....	54
Fuse Blocks.....	47-48	Quick Disconnects, Butt Connectors & Bullet Terminals.....	57-58	Trailer Seals	54
Fuse Holders	50-52			Trim Motors	60
Fuse Kits.....	45			Trolling Motor Plugs.....	55
Fuses.....	46-47				

SHIELDS MARINE HOSE SECTION

Air Conditioner.....	88-89	Drain Hose.....	65-68	Live Well Hose.....	65-68
Bilge Hose	65-68	Exhaust Hose	70-74	Oil Hose.....	79
Brass Connectors	100	Fuel Hose	79-84	Potable Hose	75-78
Conduit	101	Gasket Material	102	Product Application Guide	61-64
Coolant/Engine Intake Hose.....	69-70	Hose Clamps.....	99	Sanitation Hose	85-87
		Hump Couplers.....	95-98	Ventilation Hose.....	88-89

GENERATOR PARTS SECTION

FUEL 103-104
 Air Filters 103
 Carb Kits 103
 Fuel Filters 103-104
 Senders 104
COOLING 105-110
 Impellers 105

Cooling (Cont.)
 Impeller Kits 105-106
 Thermostats 107-108
 Thermostat Gaskets 108-109
 Thermostat Kits 109-110
INTERNAL ENGINE... 111-112
 Oil Filters 111-112

OIL & LUBE 112
ELECTRICAL..... 112-113
 Alternators 113
 Hourmeters 112
 Solenoid 113
 Starters 113
APPLICATION GUIDE . 114-125

SIERRA MARINE SECTION

ACCESSORIES/MISCELLANEOUS 126-184

FUEL 126-149
 Bowl Wrench 130
 Carburetor to Carburetor
 Kit Interchange 146-149
 Carburetors 142-143
 Drain Bowls/O-Rings 127-129
 Fuel Connectors 135
 Fuel Filters 126-130
 Fuel Hose 144
 Fuel Line Assemblies 1131-134
 Fuel Pumps 139-140
 Fuel Water
 Separators/Brackets 126-128
 Intake Manifolds 142

Fuel (Cont.)
 International Fuel Products... 136-138
 Primer Bulbs 130
IGNITION..... 150-151
 Spark Plug Wire Sets 150-151

OIL FILTERS..... 152-158
 Oil Filters/Accessories 126-132

OIL & LUBE 159-164
 Bearing Grease 163
 Engine Care Products 163-164
 Engine Oil 159-162
 Gear Lube 163

Oil & Lube (Cont.)
 Spline Grease 163
 Spray Grease, White Lithium... 164
TOOLS & SHOP
SUPPLIES 164-184
 Clamp Assortments 167
 Hand Cleaners 167
 Engine Flushers 167
 Loctite™ Products 166-167
 Manuals, Seloc 175-177
 Oil Extractors 164
 Rust Removers 164
 STATS 178-184
 Safe-Skeg 174
 Tools 168-173

CHRIS-CRAFT® 479-491

COOLING..... 487-491
 Manifold Exploded Views 488
 Manifolds &
 Related Product 487-491

ELECTRICAL..... 484-485
 Solenoids 484
 Starters 484
 Voltage Regulators 484

FUEL 485-487
 Carburetor Kits and
 Related Products 485-486

Fuel (Cont.)
 Fuel Filters 126-130, 487
 Fuel Hose 486
 Fuel Pumps 486
 Fuel Water
 Separators/Brackets 126-130, 487

IGNITION..... 479-484
 Contact Sets 479-480
 Coils 483
 Condensers 480
 Conversion Kits 481-482

Ignition (Cont.)
 Distributor Caps 480
 Distributors 482-483
 Rotors 480
 Spark Plug Wire/Sets 481
 Tune-Up Kits 479

INTERNAL ENGINE..... 491
 Gaskets 491
 Head Gaskets 491
 Oil Filters 491

CHRYSLER/FORCE® 185-200

COOLING..... 193-194
 Impellers/Repair Kits 193
 Thermostats 193

DRIVE..... 198-200
 O-Rings 200
 Oil Seals 200
 Prop Nut Kits 200
 Seal Kits 199

ELECTRICAL..... 187-189
 Starters 188
 Trim & Tilt Motors 188
 Voltage Regulators 187

FUEL 189-192
 Carburetor Kits and
 Related Products 189
 Fuel Connectors 192
 Fuel Line Assemblies 192
 Fuel Pump Kits 189
 Fuel Water
 Separators/Brackets 126-128, 192
 Primer Bulbs 192

IGNITION..... 185-197
 Battery Cables 187
 Coils 185

Ignition (Cont.)
 Condensers 185
 Contact Sets 185
 Solenoids 185
 Spark Plug Wires/Sets 187
 Switch Boxes 185
 Tune Up Kits 185

INTERNAL ENGINE.. 195-198
 Bearing Carriers/Bearings 195
 Gaskets/ Sets 195-197
 Head Gaskets 196-197
 Pistons/Rings 195

CHRYSLER INBOARD® 492-508

COOLING..... 498-508

Exploded Views 500-505
 Impellers/Kits 498
 Manifolds &
 Related Product 500-508
 Thermostats 498
 Water Pumps 498

FUEL 497-498

Carburetor Kits and
 Related Products 497
 Flame Arrestors..... 498
 Fuel Hose..... 497
 Fuel Pumps..... 498
 Fuel Water
 Separators/Brackets 126-130,497

Ignition (Cont.)

Conversion Kits..... 493-494
 Distributor Caps 492-493
 Distributors..... 493
 Rotors 492
 Spark Plug Wires/Kits 493
 Tune Up Kits 492

ELECTRICAL..... 496

Alternators..... 496
 Solenoids 496
 Starters 496
 Voltage Regulators..... 496

IGNITION..... 492-495

Coils..... 494
 Condensers..... 492
 Contact Sets 492

INTERNAL ENGINE..... 498

Gaskets..... 498
 Oil Filters..... 498

CRUSADER® 509-534

COOLING..... 520-534

Exploded Views 522-529
 Impellers/Repair Kits 520-521
 Manifolds &
 Related Product 522-534
 Thermostats/Kits 521
 Water Pumps 521

Fuel (Cont.)

Carburetors 518
 Flame Arrestors..... 519
 Fuel Filters 126-130, 520
 Fuel Hose..... 519
 Fuel Pumps..... 519-520
 Fuel Water
 Separators/Brackets .126-130, 520

Ignition (Cont.)

Distributors..... 515-516
 Rotors 511-512
 Spark Plug Wires/Kits 514
 Tune Up Kits 509-511

ELECTRICAL..... 517-518

Solenoids 517
 Starters 517
 Voltage Regulators..... 518

IGNITION..... 509-517

Coils..... 516
 Condensers..... 511
 Contact Sets 511
 Conversion Kits..... 513-514
 Distributor Caps 512-513
 Ignition Modules..... 516

INTERNAL ENGINE..... 535

Gasket Sets/Gaskets 535
 Head Gaskets 535
 Oil Filters..... 535

FUEL 518-520

Carburetor Kits and
 Related Products 518-519

MODEL IDENTIFICATION

CHART 509

DIESEL 578-581

HIGH PERFORMANCE PRODUCTS 564-567

HONDA® 201-207

COOLING..... 203-206

Gaskets..... 205-206
 Impellers/Repair Kits 204-205
 Thermostats 203

ELECTRICAL..... 201

Starters 201
 Tilt/Trim Motors 201

IGNITION..... 201

Spark Plug Wire/Kits 201

DRIVE..... 207

Anodes 207
 Oil Seals..... 207
 Seal Kits..... 207
 Prop Nut Kits..... 207

FUEL 202-203

Fuel Connectors..... 203
 Fuel Filters/Kits 126-123, 202
 Fuel Line Assemblies 202
 Primer Bulbs 203

INTERNAL ENGINE.. 206-207

Bearings..... 206
 Oil Filters..... 207

MODEL IDENTIFICATION

CHART 201

INBOARD ACCESSORIES 473-478

Anodes 477
 Impellers/Kits 473-476
 Packing..... 478

Prop Nut Kits 478
 Stuffing Boxes 478
 Transmission Oil Coolers 476-477

Transmission Repair Kits..... 477
 Water Pumps..... 475

INDMAR® 536-538

INTERNAL ENGINE COMPONENTS 567-577

JABSCO PUMP® 473-474

JOHNSON/EVINRUDE® 208-299

COOLING.....229-241

Exploded Views 240
 Impellers/Kits 229-231
 Thermostats/Kits 239
 Water Pump
 Housings/Kits 231-236

DRIVE.....266-299

Anodes 289
 Bearings 279-280
 Carrier Bearings 285
 Drive Shafts 282
 Exploded Views 266-274
 Gears/Sets 284-285
 Lower Gearcase Assemblies ... 276
 Oil Seals 293-295
 O-Rings 296-295
 Prop Nuts/Kits 277
 Prop Shafts 283
 Seal Kits 289-292
 Shims 288
 Spacers/Washers 277
 Throttle Cables 288

ELECTRICAL.....216-221

Rectifiers/Regulators 218
 Solenoids 217
 Starters 220-221
 Stators & Timer Base 216
 Tilt/Trim Motors 216

FUEL221-229

Carburetor Kits and
 related products 221-223
 Clamp Assortment 229
 Fuel Connectors 228
 Fuel Filters 227
 Fuel Hose 228-229
 Fuel Line Assemblies 228
 Fuel Pumps/Kits 224-225
 Fuel Water Separators/
 Brackets 225-227
 Primer Bulbs 228

IGNITION.....209-215

Condensers 209
 Contact Sets 209

Ignition (Cont.)

Coils 210-211
 Power Packs 212-214
 Spark Plug Wires/Kits 215
 Switches 215
 Tune-Up Kits 209

INTERNAL ENGINE..242-264

Bearings/Kits 244-245
 Connecting Rods 244
 Crankshaft Seal Kits 248
 Gaskets/Sets 249-264
 Head Gaskets 254
 Hose 249
 Oil Filters 249
 Pistons/Rings 242-243

**MODEL IDENTIFICATION
 CHART208-209**

STARTER SYSTEM 264

Rewind Springs 264
 Starter Pawls 264
 Starter Rope 264

JOHNSON PUMP® 474-475

MALLORY® 867-868

MARINE POWER® 539

MCCULLOCH/SCOTT-ATWATER® 300

MERCUISER® 582-741

COOLING.....628-674

Exploded Views 632-633, 650-663
 Impellers/Kits 628, 630
 Manifolds and
 Related Products 664-671
 Molded Hose 641-644
 Oil/Temperature Senders 640
 Pulleys 628
 Serpentine Belts 649
 Thermostat Housings 634-635
 Thermostats/Kits 634
 V-Belts 645-646
 Water Pumps Kits 630-631
 Water Circulating Pumps 628

DRIVE.....695-741

Anodes 734-735
 Bearings/Kits 724-727
 Bellows 717
 Carrier Bearings 723-724
 Drive Shafts 724-723
 Engine Couplers 719-720
 Exhaust Protector Valves 737
 Exploded Views 698-707
 Gear Housing Assemblies 709
 Gears/Sets 710-711, 721
 Gimbal Bearings 713-714
 Lower Gear Cases 708-710
 O-Rings 739-741
 Oil Seals 738-739
 Outdrive Gasket Sets 696
 Pivot Pins 733
 Power Trim Cylinders/Kits 732

Drive (Cont.)

Power Trim Hoses 729-730
 Prop Nuts/Kits 728
 Prop Shafts 722
 Seal Kits 735-737
 Shift Cables/Kits 718-719
 Shift Spool Assemblies 723
 Shims/Kits 708
 Transom Seal Kits 716
 U-Joints 713
 Upper Gear Cases 709
 Upper Units/Kits 710-712
 Yokes/Yoke Assemblies ... 712-713

ELECTRICAL.....598-607

Alternators 604-605
 Solenoids 601-602
 Starters 598-601
 Trim/Tilt Motors 602-603
 Voltage Regulators 605

FUEL608-627

Carburetor Kits and
 related product 615-616
 Carburetors 611-612
 Electrical Fuel Pumps 620-621
 Flame Arrestors 620
 Fuel Filters 627
 Fuel Hose 615
 Fuel Water Separators/
 Brackets 624-627
 Fuel Injection Components.. 608-609
 Intake Manifolds 611

Fuel (Cont.)

Mechanical Fuel Pumps 621

IGNITION.....584-598

Coils 587-588
 Condensers 586
 Contact Sets 585-586
 Conversion Kits 587
 Distributor Caps 586-587
 Distributors 590-592
 Ignition Modules 588
 Rotors 586
 Spark Plug Wires/Kits 597-598
 Tune-Up Kits 584-585

INTERNAL ENGINE..675-696

Bearings 679-682
 Crankshaft/Timing
 Cover Seals 692
 Cylinder Head Assemblies 675
 Gaskets/Sets 684-694
 Head Gaskets 689
 Hydraulic Lifters 676
 Modular Gasket Sets 570-577
 Oil Filters 675
 Oil Pans 675
 Pistons/Rings 676-679
 Valve Stem Seals 683

**MODEL IDENTIFICATION
 CHART582-583**

MERCURY/MARINER® 301-393

COOLING.....335-336
 Impellers/Repair Kits..... 336-338
 Thermostats/Kits..... 335-336
 Water Pump
 Housings/Kits..... 337-338

DRIVE.....368-393
 Anodes..... 382-383
 Bearings/Kits..... 374-377
 Clutches..... 378-379
 Drive Shafts..... 378
 Exploded Views..... 368-373
 Gearcases/Housings..... 379-380
 Gears/Sets..... 378-379
 Manual Release Valve..... 308
 Oil Seals..... 368
 O-Rings..... 391
 Power Trim Hoses..... 381
 Prop Nuts/Kits..... 381
 Prop Shafts..... 378
 Seal Kits..... 383-387
 Spanner Nuts..... 380

ELECTRICAL.....308-321
 Alternators..... 317
 Relays..... 314
 Serpentine Belts..... 317
 Solenoids..... 313-314
 Starters..... 317-320
 Stators..... 310-311
 Tilt/Trim Motors..... 309-310
 Trigger Assemblies..... 311
 Voltage Regulators..... 313

FUEL.....321-335
 Air Filters..... 335
 Carburetor Kits and
 related products..... 321-326
 Fuel Connectors..... 331
 Fuel Filters..... 334-335
 Fuel Line Assemblies..... 329-330
 Fuel Pumps/Kits..... 327-329
 Fuel Water Separators/
 Brackets..... 332-334
 Primer Bulbs..... 330

IGNITION.....301-308
 Condensers..... 303
 Contact Sets..... 302-303
 Coils..... 303
 Spark Plug Wires/Kits..... 307-308
 Switch Boxes..... 303-304
 Switches..... 308
 Tune-Up Kits..... 302

INTERNAL ENGINE..347-366
 Bearings..... 350-351
 Gasket/Sets..... 353-365
 Head Gaskets..... 353-358
 Motor Mounts..... 353
 Oil Filters..... 353
 Pistons/Rings..... 347-349

**MODEL IDENTIFICATION
 CHART.....301-302**

STARTER SYSTEM..... 366
 Rewind Springs..... 366

NISSAN/TOHATSU® 394-396

OBERDORFER® 475-476

OMC STERNDRIVE/COBRA® 742-810

COOLING.....767-779
 Exploded Views..... 772-774
 Impellers/Kits..... 768-769
 Manifolds and
 related products..... 775-779
 Molded Hose..... 770
 Temperature Senders..... 769
 Thermostats/Kits..... 769-770
 V-Belts..... 771
 Water Circulating Pumps..... 767
 Water Pump Housings/Kits..... 769

DRIVE.....790-810
 Anodes..... 801-802
 Ball Gears / Sets..... 794
 Bearing Housings..... 798-799
 Bearings..... 795
 Bellows /Kits..... 793
 Carrier Bearings..... 798
 Drive Shafts..... 796-797
 Engine Couplers..... 794
 Exploded Views..... 790-791
 Gear Housings..... 792
 Gears/Sets..... 797
 Gimbal Bearings..... 792
 Oil Seals..... 806-807
 O-Rings..... 808-810
 Prop Nuts/Kits..... 800
 Prop Shafts..... 797

Drive (Cont.)
 Seal Kits..... 803-805
 Shafts..... 800
 Shims..... 792
 Shift Rods..... 799
 Trailering Clips..... 800
 Transom Seals..... 793
 U-Joints..... 793
 Yoke Assemblies..... 793

ELECTRICAL.....753-758
 Alternators/Rebuild Kits..... 757
 Relays..... 757
 Solenoids..... 755
 Starters..... 753-754
 Tilt/Trim Motors..... 757
 Voltage Regulators..... 757

FUEL.....758-767
 Carburetor Kits and
 related product..... 760-761
 Carburetors..... 759
 Flame Arrestors..... 763
 Fuel Filters..... 766-767
 Fuel Hose..... 763
 Fuel Injection Components..... 758
 Fuel Pumps..... 763-764
 Fuel Water Separators/
 Brackets..... 764-766

Fuel (Cont.)
 Hose Barbs..... 767
 Intake Manifolds..... 758

IGNITION.....742-751
 Coils..... 745
 Condensers..... 743
 Contact Sets..... 743
 Conversion Kits..... 746-747
 Distributor Caps..... 744
 Distributors..... 747-749
 Ignition Modules..... 744
 Rotors..... 743-744
 Spark Plug Wires/Kits..... 752
 Tune-Up Kits..... 742-743

INTERNAL ENGINE..780-789
 Bearings..... 782
 Crankshaft/Timing
 Cover Seals..... 782
 Cylinder Head Assemblies..... 780
 Gaskets/Sets..... 783-789
 Head Gaskets..... 785
 Hydraulic Lifters..... 781
 Modular Gasket Sets..... 570-577
 Oil Filters..... 780
 Pistons/Rings..... 781
 Valve Stem Seals..... 789

PERSONAL WATER CRAFT® 470-472

PLEASURECRAFT® 540-553

COOLING..... 449-551
 Exploded Views 550
 Impellers/Kits 549
 Manifolds and
 Related Products 550-551
 Thermostats/Kits 549
 Water Pumps 549

DRIVE..... 553
 Power Trim Hoses..... 553
 Prop Nuts/Kits 553

ELECTRICAL..... 546-547
 Alternators..... 547
 Solenoids 547
 Starters 547

FUEL 547-549
 Carburetor Kits and
 Related Products 548
 Fuel Filters 548
 Fuel Pumps..... 549
 Fuel Water
 Separators/Brackets 548

IGNITION..... 540-546
 Coils 545-546
 Condensers..... 541
 Contact Sets 541
 Conversion Kits..... 542
 Distributor Caps 542

Ignition (Cont.)
 Distributors..... 543-544
 Rotors 541
 Spark Plug Wires/Kits 544
 Tune Up Kits 540-541

INTERNAL ENGINE..... 553
 Gaskets/Sets..... 553
 Head Gaskets 553
 Oil Filters..... 553

**MODEL IDENTIFICATION
 CHART 540**

PRESTOLITE® 869

SHERWOOD PUMP® 476

SUZUKI® 397-409

COOLING..... 402-404
 Impellers/Kits 402-404
 Thermostat Gaskets..... 404
 Water Pump Gaskets..... 403-404

DRIVE..... 407-409
 Anodes 407
 Lower Unit Seal Kits..... 407-408
 O-Rings..... 408
 Oil Seals..... 408
 Prop Nuts/Kits 407

ELECTRICAL..... 397-398
 Starters 397-398
 Tilt/Trim Motors 398

FUEL 399-402
 Carburetor Kits..... 399-400
 Fuel Connectors..... 401-402
 Fuel Filters 400
 Fuel Line Assemblies..... 401
 Fuel Water
 Separators/Brackets 400
 Primer Bulbs 401

IGNITION..... 397
 Spark Plug Wires/Kits 397

INTERNAL ENGINE.. 405-406
 Bearings..... 405
 Connecting Rods 405
 Gaskets..... 405-406
 Head Gaskets 405-406
 Oil Filters..... 406
 Pistons/Rings..... 405

**MODEL IDENTIFICATION
 CHART 397**

UNIVERSAL 554-563

COOLING..... 556-563
 Exploded Views 556-561
 Manifolds and
 related products 556-563

ELECTRICAL..... 555
 Alternators..... 555

Electrical (Cont.)
 Solenoids 555
 Starters 555

FUEL 555
 Carburetor Kits..... 555
 Fuel Filters 555
 Fuel Hose..... 555

IGNITION..... 554
 Coils 554
 Condensers..... 554
 Contact Sets 554
 Distributor Caps 554
 Rotors 554
 Tune Up Kits 554

VOLVO-PENTA® 811-864

COOLING..... 834-846
 Exploded Views 838-839
 Gasket Sets 844
 Hose..... 837
 Impellers/Kits 835-836
 Manifolds and
 related product..... 838-843
 Molded Hose..... 844
 Thermostat Housings..... 844

Cooling (Cont.)
 Thermostats/Kits 844-846
 V-Belts..... 837
 Water Pump Kits 836
 Water Pumps 834

DRIVE..... 858-864
 Anodes 862-863
 Bellows/Kits..... 859

Drive (Cont.)
 Drive Plates..... 861
 Engine Couplers 858
 Exhaust Hose..... 859
 Gimbal Bearings 860
 O-Rings..... 864
 Oil Seals..... 864
 Power Trim Hoses..... 858
 Prop Nuts/Kits 861

VOLVO-PENTA® 811-864

Drive (Cont.)

Seal Kits..... **863-863**
 Trailing Clips..... **859**
 U-Joints..... **860**
 Yokes..... **860**

ELECTRICAL..... 821-826

Alternators..... **823-824**
 Relays..... **825**
 Solenoids..... **825**
 Starters..... **821-822**
 Tilt/Trim Motors..... **826**

ENGINE APPLICATION

GUIDE..... 811-814

FUEL..... 827-833

Air Filters..... **832**
 Carburetor Kits and
 related product..... **827-828**

Fuel (Cont.)

Carburetors..... **827-829**
 Electrical Fuel Pumps..... **829**
 Fuel Filters..... **830-833**
 Fuel Hose..... **829**
 Fuel Water Separators/
 Brackets..... **830-831**
 Intake Manifolds..... **827**
 Mechanical Fuel Pumps..... **829**
 Sensors..... **833**

IGNITION..... 815-821

Camshaft Sensor..... **817**
 Coils..... **816-817**
 Condensers..... **815**
 Contact Sets..... **815**
 Conversion Kits..... **819**
 Crankshaft Sensor..... **817**
 Distributor Caps..... **816**
 Distributors..... **818-819**

Ignition (Cont.)

Rotors..... **815-816**
 Spark Plug Wires/Kits..... **820-821**
 Tune Up Kits..... **815**

INTERNAL ENGINE.. 847-858

Air Filters..... **848**
 Bearings..... **851**
 Belts..... **847**
 Camshafts/Kits..... **847**
 Cylinder Head Assemblies..... **849**
 Gaskets/Sets..... **852-858**
 Head Gaskets..... **853-854**
 Hydraulic Lifters..... **850**
 Modular Gasket Sets..... **570-577**
 Oil Filters..... **848**
 Pistons/Rings..... **850**
 Valve Stem Seals..... **851**
 Valves..... **847**

YAMAHA® 410-469

COOLING..... 426-437

Impellers/Kits..... **426**
 Thermostats/Kits..... **436**
 Water Pump Housing/Kits.. **427-433**

DRIVE..... 453-469

Anodes..... **454**
 Carrier Bearings..... **454**
 Exploded Views..... **456-465**
 O-Rings..... **469**
 Oil Seals..... **469**
 Prop Nuts/Kits..... **454-455**
 Prop Shafts..... **453**
 Seal Kits..... **466-468**

ELECTRICAL..... 412-415

Starters..... **412-413**
 Tilt/Trim Motors..... **415**

FUEL..... 415-425

Carburetor Kits and
 Related Products..... **415-417**
 Fuel Connectors..... **425**
 Fuel Filters..... **423-424**
 Fuel Line Assemblies..... **425**
 Fuel Pump Diaphragms/Kits... **419-420**
 Fuel Pumps..... **419**
 Fuel Water Separators/
 Brackets..... **421-422**
 Primer Bulbs..... **425**

IGNITION..... 410-411

Coils..... **410**
 Ignition Switches..... **410**
 Spark Plug Wires/Kits..... **411**

INTERNAL ENGINE.. 438-453

Bearings/Kits..... **439**
 Connecting Rods/Kits..... **439**
 Gaskets/Sets..... **440-453**
 Head Gaskets..... **448**
 Oil Filters..... **439-440**
 Pistons/Rings..... **438-439**

MODEL IDENTIFICATION

CHART..... 410

YAMAHA STERNDRIVE® 865-866

INTERCHANGE SECTION

Capacity Charts..... **982-1012**
 Carburetor to Carburetor Kit
 Interchange..... **146-149**
 Competitive Interchange..... **886-896**
 Mallory Distributor Parts
 Guide..... **867-868**

Original Equipment Part No.
 Interchange Guide..... **897-926**
 Outboard Model to Year to
 Horsepower Guide..... **870-878**
 Part Number to Page Number Guide
 Electrical Products..... **928-931**

Part Number to Page Number Guide (Cont.)
 Gauges..... **927-928**
 Generator Parts..... **931-932**
 Shields..... **931**
 Sierra..... **932-981**
 Prestolite Distributor Parts Guide..... **869**





Premier Pro White Premier Pro Driftwood Lido Lido Pro

Fuel Gauge	2" 62718P	2" 62551P	2" 61549P	2" 65496P	2" 59655P
Hourmeter 10,000 hrs	2" 62719P	2" 62538P	2" 62952P	2" 65497P	2" 59416P
Oil Pressure Gauge (SW) 0-80 PSI	2" 62720P	2" 62542P	2" 61550P	2" 65501P	2" 59653P
Oil Pressure Gauge (SW) 0-100 PSI		2" 62543P		2" 65498P	
Water Pressure Kit (Outboard) 30 PSI	2" 62721P		2" 62960P	2" 65507P	2" 63523P
Water Pressure Kit (Outboard) 40 PSI		2" 67657P			
Water Pressure Kit (Outboard) 45 PSI					
GPS Speedo 35 MPH	3" 781-627-035P	3" 781-625-035P		781-310-035P	781-310-035P
GPS Speedo 60 MPH	781-627-060P	781-625-060P		781-310-060P	781-310-060P
GPS Speedo 80 MPH	3" 781-627-080P	3" 781-625-080P		781-310-080P	781-310-080P
GPS Speedo 120 MPH	3" 781-627-120P	3" 781-625-120P			
Speedo Kit 35 MPH (Pitot Type)				3" 61751P	3" 59713P
Speedo Kit 50 MPH (Pitot Type)			3" 61547P	3" 61752P	3" 61752P
Speedo Kit 60 MPH (Pitot Type)					
Speedo Kit 65 MPH (Pitot Type)	3" 62722P	3" 62546P	3" 62372P	3" 65510P	
Speedo Kit 70 MPH (Pitot Type)					
Speedo Kit 80 MPH (Pitot Type)	3" 62723P	3" 65626SSFP	3" 63516P	3" 65670P	3" 59649P
Tachometer, 0-6000 RPM O/B & 4 Cycle Gas	3" 62724P				
Tachometer, 0-7000 RPM O/B & 4 Cycle Gas		3" 62561P	3" 61546P	3" 65693P	3" 59737P
Tachometer, 0-8000 RPM O/B & 4 Cycle Gas	3" 62725P				
Tachometer 0-4000 RPM Diesel Alt		3" 62547P		3" 65671P	
Tach/Hour 0-7000 RPM O/B & 4 Cycle Gas		3" 62565P	3" 63941P	3" 65129P	
Tachometer - System check gauge			3" 62698P	3" 64477FP	
Water Temp (SW) 120-240°F	2" 62729P	2" 62540P	2" 61552P*	2" 65509P	2" 59654P
Water Temperature Kit (Outboards)	2" 62748P			2" 65508P	
Trim Gauge Evinrude/Johnson	2" 62726P	2" 62550P	2" 62373P	2" 65502P	
Trim Gauge Honda	2" 63531P		2" 62375P	2" 65503P	
Trim Gauge Mercury OB & IO, Mariner, Force, Cobra, Volvo DP & SX, Yamaha 2001 & Up	2" 62727P	2" 62549P	2" 61551P	2" 65504P	
Trim Gauge 2002 and newer Suzuki 4-Stroke	2" 62726P	2" 62550P	2" 62373P	2" 65502P	
Trim Gauge pre 2001 Yamaha outboards	2" 62728P			2" 65505P	2" 59657P
Voltmeter 12v	2" 62730P †	2" 62555P	2" 61548P	2" 65506P	2" 59656P
Voltmeter 24v		2" 62539P			
12V Battery Condition Indicator					
Engine Synchronizer Gauge	2" 84730P			2" 65495P	
System check gauge - Evinrude/Johnson				2" 65206SSP	
System check gauge - Suzuki				2" 65669SSP	
Ammeter 60-0-60					
4 Gauge Kits 65 MPH (Outboard)	62714P*				67669P
6 Gauge Kits 65 MPH (Sterndrive)	62715P*	67654P			67653P



- * **Twin Engine Outboard Add On Kit - Tachometer, Voltmeter**
- * **Twin Engine Inboard/Sterndrive Kit - Tachometer, Water Temperature, Oil Pressure, Voltmeter**
- * **Outboard kit - Tachometer, Speedometer (65 MPH with pitot tube), Fuel Gauge (compatible with common marine senders), and Voltmeter. Matching Trim Gauges, Hourmeters and Water Pressure or Temperature Kits are available separately. (Not for diesels.)**
- * **Sterndrive kit - Tachometer, Speedometer (65 MPH with pitot tube), Fuel Gauge, Water Temperature Gauge, Oil Pressure Gauge (all compatible with common marine senders), and Voltmeter. Matching Trim Gauges and Hourmeters are available separately for stern drive applications. (Not for diesels.)**
- * (100-220°F) range.
- * 0-3500 RPM.



Sahara	Sterling	Black Sterling	Omega	Arctic	Eclipse	Heavy Duty
2" 59707P	2" 63477P	2" 67021P	2" 57902P	2" 68365P	2" 68390P	2" 80150P
			2" 84760P	2" 68366P	2" 68391P	2" 82760P
2" 59705P	2" 63479P	2" 67022P	2" 57903P	2" 68367P	2" 68392P	2" 80180P
			2" 57929P		2" 68393P	2" 80181P
2" 69870P	2" 63481P		2" 61238P			
		2" 67382P	2" 68357P	2" 68369P	2" 68394P	
			3" 781-579-035P	3" 781-683-035P	3" 781-684-035P	
			781-579-060P	781-683-060P	781-684-060P	
			3" 781-579-080P	3" 781-683-080P	3" 781-684-080P	
3" 61826P		3" 67283P	3" 58342P	3" 68370P	3" 68395P	
3" 61163P		3" 68960P	3" 57898P			
						3" 80514P
3" 59704P	3" 63475P		3" 57900P	3" 68371P	3" 68396P	
		3" 67285P				
3" 63076P	3" 63476P		3" 57899P	3" 68372P	3" 68397P	
						3" 82288P
3" 59703P	3" 63473P	3" 67363P	3" 58255P	3" 68374P	3" 68399P	
			3" 68358P	3" 68373P	3" 68398P	3" 82302P*
	3" 63474P	3" 67364P	3" 68443P	3" 68375P	3" 68400P	
3" 61901P			3" 58935P			
2" 59706P	2" 63480P	2" 67020P	2" 57904P	2" 68376P	2" 68401P	2" 80590P
			2" 58862P*	2" 68377P	2" 68402P	
2" 61908P	2" 63483P	2" 67365P	2" 58431P	2" 68378P	2" 68403P	
2" 62369P	2" 64475P	2" 67855P	2" 68359P	2" 68379P	2" 68404P	
2" 59709P	2" 63482P	2" 67023P	2" 57905P	2" 68380P	2" 68405P	
2" 61908P	2" 63483P	2" 67365P	2" 58431P	2" 68378P	2" 68403P	
			2" 61748P	2" 68381P	2" 68406P	
2" 59708P	2" 63478P	2" 67019P	2" 57901P	2" 68383P	2" 68408P	2" 80134P †
						2" 80131P
			2" 68361P	2" 68384P	2" 68409P	
						2" 80730P
2" 66956P	2" 63585P		2" 65205P	2" 68385P	2" 68410P	
			2" 65668BMDP	2" 68386P	2" 68411P	
			2" 68356P	2" 68364P	2" 68389P	2" 80710P
65481P*			68362P*	68387P*	68412P*	
65485P*			68363P*	68388P*	68413P*	

* **Outboard Kit w/ Tach/Hr-** Tachometer/Hourmeter, Speedometer (65 MPH w/ Pitot Tube, Fuel Gauge (compatible with common marine senders), and Voltmeter.

* **Inboard/Stern Drive Kit** - Tachometer/Hourmeter, Speedometer (65 MPH w/ Pitot Tube, fuel Gauge, Water Temperature Gauge, Oil Pressure Gauge (all compatible with common marine senders), and Voltmeter

* Matching Trim Gauges are available separately. Not for diesels

† 8-16 VDC

MATRIX GAUGES — The Matrix gauge set is intended to operate on Mercury SmartCraft engines (max 4 engines/2 stations) utilizing the SmartCraft® protocol. The gauges operate on 12 volt systems and support single, dual, triple or quad engine applications. In a Matrix gauge set, the 3" tachometer is the master and connects directly to the SmartCraft data bus. All other gauges are slaves and connect to the tachometer RS-485 private bus (immune to electrical noise, more robust and reliable). The tachometer reads SmartCraft engine parameters and forwards them on the private bus for the slave gauges.



FEATURES:

- Smart Tachometer CANbus driven
- All 2" gauges receive data from tachometers
- LCD on Tachometer and Speedo displays all available data and alarms
- IP67 waterproof/ submersible housings (with Connector fitted)
- Dry Nitrogen filled to minimize fogging
- LED dimmable, automotive style backlighting (red)
- CANbus connectivity

SELECTION GUIDE:

GAUGE DESCRIPTION	SIZE	PART NO.
Speedometer w/ LCD US 90 MPH	3"	70002D
Fuel Primary	2"	70003D
Fuel Secondary	2"	69992D
Voltmeter 10 - 16 VDC	2"	70004D
Temperature 240F	2"	70006D
Water pressure 40 PSI	2"	69994D
Oil Pressure 80 PSI	2"	70005D
Trim	2"	69993D
Tachometer - Smartcraft	3"	70000D
Tachometer - NEMA 2000	3"	70001D

PART NO.	Description
69995K	Harness - Tachometer to Smartcraft, 30"
69996K	Harness - Tachometer to NMEA 2000, 30"
69997K	Harness - Tachometer to Speedometer, 48"
69998K	Terminator - Needed when no speedo is used
69999K	Harness - Any 2" gauge to another, 8"

EYEBROW BEZELS — Teleflex Eyebrow Bezels give any boat that sporty race boat look. Durable and corrosion proof these chrome plated bezels attach directly to the gauge. The bezels can be rotated to any angle allowing you to customize the look of your dash.

FEATURES:

- Directly attach to the gauge.
- No extra holes to drill.
- Can be set at any angle.
- Corrosion proof ABC/PVC construction.
- Buy individually or in 4 or 6 gauge sets.



SELECTION GUIDE:

PART NO.	DESCRIPTION	NOTE
69268P	2" Eyebrow Bezel	
69269P	3" Eyebrow Bezel	
69270P	5" Eyebrow Bezel	
69380P	4 Bezel Kit	For 4 gauge kit
69381P	6 Bezel Kit	For 6 gauge kit

All gauge products are only available in North America!

GPS SPEEDOMETERS — These GPS speedometers provide accurate speed over ground readings and heading information all in one attractive package. Available in various speed ranges to meet your application, the GPS speedometer is offered in a number of popular styles to match the colors in your boat like Premier Pro, White Premier Pro, Omega, Arctic and Eclipse instrument lines.



FEATURES:

- Available in speed ranges of 35 MPH, 80 MPH and 120 MPH.
- Included LCD heading display to show course over ground.
- Use our GPS antenna (sold separately) or connect to an existing NMEA 0183 GPS device – connectors included.
- Speed accuracy of +/-1 MPH (once moving).
- Heading accuracy of +/-1 degree (once moving).
- Ideal for slow speed applications like pontoon boats and for high speed performance boats where pitot tubes do not perform well.

SELECTION GUIDE:

PART NUMBER	GAUGE DESCRIPTION	SIZE	DIAL RANGE	SENDER CODE
Premier Pro: 781-627-035P 781-627-060P 781-627-080P 781-627-120P	35 MPH 60 MPH 80 MPH 120 MPH	3" 3" 3" 3"	0-35 MPH 0-60 MPH 0-80 MPH 0-120 MPH	GPS RECEIVER
White Premier Pro: 781-625-035P 781-625-060P 781-625-080P 781-625-120P	35 MPH 60 MPH 80 MPH 120 MPH	3" 3" 3" 3"	0-35 MPH 0-60 MPH 0-80 MPH 0-120 MPH	GPS RECEIVER
Omega: 781-579-035P 781-579-060P 781-579-080P	35 MPH 60 MPH 80 MPH	3" 3"	0-35 MPH 0-60 MPH 0-80 MPH	GPS RECEIVER
Arctic: 781-683-035P 781-683-060P 781-683-080P	35 MPH 60 MPH 80 MPH	3" 3"	0-35 MPH 0-60 MPH 0-80 MPH	GPS RECEIVER
Eclipse: 781-684-035P 781-684-060P 781-684-080P 68755P 68982P	35 MPH 60 MPH 80 MPH GPS Receiver GPS Receiver	3" 3" 3" 25" 4"	0-35 MPH 0-60 MPH 0-80 MPH	GPS RECEIVER
Lido Pro: 781-310-035P 781-310-060P 781-310-080P	35 MPH 60 MPH 80 MPH	3" 3" 3"	0-35 MPH 0-60 MPH 0-80 MPH	



All gauge products are only available in North America!

PREMIER PRO — A very popular OEM line, Premier features black dials with modern white and blue graphics. When lighted, white dial grads become red and pointer lights white. These instruments feature automotive type light-piping and a fog-resistant design for outstanding readability.



FEATURES:

- Full automotive type lighting, no “halo” around dial edges. When lit, white dial grads become red, pointer lights white.
- Black dial, white graduations/numerals (metrics in blue), white pointer staff.
- Scratch resistant curved glass lenses, with black, near-flush bezels.
- U.S. and metric scales, with ISO symbols, where appropriate.
- Optional add-on square bezels for modular appearance (See Gauge Accessories for details).
- Line includes standard ignition engine synchronizer kits including module.
- Fog-Resistant Design! Complies with SAE J-1810.

SELECTION GUIDE:

GAUGE DESCRIPTION	SIZE	DIAL RANGE	SENDER CODE	PART NUMBER
Engine Synchronizer Gauge:	2"	PORT-STBD.	REQUIRES "L"	84730P
Fuel Gauge:	2"	E-1/2-F	REQUIRES "F"	62718P
Hourmeter:	2"	10,000 Hrs.	NONE REQUIRED	62719P
Oil Pressure Gauge (Electric): Oil Pressure 80 PSI	2"	0-80 PSI	REQUIRES "C"	62720P
GPS Speedometer:				
35 MPH	3"	0-35 MPH	GPS RECEIVER	781-627-035P
60 MPH	3"	0-60 MPH		NEW 781-625-060P
80 MPH	3"	0-80 MPH		781-627-080P
120 MPH	3"	0-120 MPH		781-627-120P
Speedometer Kits:				
65 MPH (Pitot type)	3"	10-65 MPH	INCLUDES "G"	62722P
80 MPH (Pitot type)	3"	20-80 MPH	INCLUDES "G"	62723P
80 MPH (Pitot type) Head Only	3"	20-80 MPH		62723PH
Tachometers (Electric):				
O/B & 4-Stroke Gas Engines*	3"	0-6000 RPM	O/B ALT./COIL	62724P
O/B & 4-Stroke Gas Engines*	3"	0-8000 RPM	O/B ALT./COIL	62725P
Trim Gauges (Outboard, I/O):				
Evinrude/Johnson Outboards	2"	UP-DOWN	BY ENG. MFR	62726P
Honda Outboards	2"	UP-DOWN	BY ENG. MFR	63531P
Mariner/Merc/Cobra/Volvo DP, SX, Yamaha 2001 and on	2"	UP-DOWN	BY ENG. MFR	62727P
Suzuki 4-Stroke, 2002 to date	2"	UP-DOWN	BY ENG. MFR	62726P
Yamaha Outboards, pre 2001	2"	UP-DOWN	BY ENG. MFR	62728P
Voltmeter-12 Volt:	2"	8-16 VDC	NONE REQUIRED	62730P
Water Pressure Kit (Outboard):** (Each kit includes fittings and 20 feet of tubing)	2"	30 PSI	INCLUDES "WP"	62721P
Water Temp. Kit (Outboard):** (For all electric-start outboards)	2"	COLD-HOT	INCLUDES "J"	62748P
Water Temp. Gauge (I/O, I/B):	2"	120-240°F	REQUIRES "D"	62729P
4 Gauge Set, Fog Free				62714P
6 Gauge Set, Fog Free				62715P

*Mariner 30 & 40 HP (2-cylinder) engines require a module (Mercury P/N 17461A2) when using any of these tachometers. Not tested for non-original-equipment (aftermarket) ignition systems. Not for diesels.
 ** Adapter (P/N 61886P) is required for Yamaha.

All gauge products are only available in North America!

WHITE PREMIER PRO — Ideal for inboards, including diesels, Premier White features polished stainless steel bezels and clean white dials with modern black and blue graphics. When illuminated, black dial grads become red and pointer lights red. Automotive type light-piping and fog-resistant design combine for outstanding readability.



FEATURES:

- Full automotive type lighting, no “halo” around dial edges. When illuminated, white dial grads become red, pointer lights white.
- White dial, black graduations/numerals (metrics in blue), red pointer staff.
- Scratch resistant curved glass lenses, with polished stainless steel near-flush bezels.
- U.S. and metric scales, with ISO symbols, where appropriate.
- Optional add-on square bezels for modular appearance (See Gauge Accessories for details).
- Fog-Resistant Design! Complies with SAE J-1810.

SELECTION GUIDE:

GAUGE DESCRIPTION	SIZE	DIAL RANGE	SENDER CODE	PART NUMBER
Fuel Gauge:	2"	E-1/2-F	REQUIRES "F"	62551P
Hourmeter:	2"	10,000 Hrs.	NONE REQUIRED	62538P
Oil Pressure Gauges (Electric):				
Oil Pressure 80 PSI	2"	0-80 PSI	REQUIRES "C"	62542P
Oil Pressure 100 PSI	2"	0-100 PSI	REQUIRES "C"	62543P
GPS Speedometer:				
35 MPH	3"	0-35 MPH		781-625-035P
60 MPH	3"	0-60 MPH		781-625-060P
80 MPH	3"	0-80 MPH		781-625-080P
120 MPH	3"	0-120 MPH		781-625-120P
Speedometer Kits:				
65 MPH (Pitot type)	3"	10-65 MPH	INCLUDES "G"	62546P
65 MPH (Pitot type) Head Only	3"	10-65 MPH		62546PH
80 MPH (Pitot type)	3"	20-80 MPH	INCLUDES "G"	65626SSFP
Tachometer (Electric):				
O/B & 4-Stroke Gas Engines*	3"	0-7000 RPM	O/B ALT./COIL	62561P
Tachometer/Hourmeter (Electric):				
O/B & 4-Stroke Gas Engines*	3"	0-7000 RPM	O/B ALT./COIL	62565P
Tachometers (Electric):				
Diesel Alternator**	3"	0-4000 RPM	SEE "T"	62547P
Diesel Magnetic Pickup, 90-180 Teeth	3"	0-4000 RPM	REQUIRES "B"	62548P
Trim Gauges (Outboard, I/O):				
Evinrude/Johnson Outboards	2"	UP-DOWN	BY ENG. MFR	62550P
Mariner/Merc/Cobra/Volvo DP, SX, Yamaha 2001 and on	2"	UP-DOWN	BY ENG. MFR	62549P
Suzuki 4-Stroke, 2002 to date	2"	UP-DOWN	BY ENG. MFR	62550P
Voltmeters-12 & 24 Volt:				
12 Volt System	2"	8-18 VDC	NONE REQ'D	62555P
24 Volt System	2"	20-32 VDC	NONE REQ'D	62539P
Water Temp. Gauge (I/O, I/B):	2"	120-240°F	REQUIRES "D"	62540P
Water Pressure Kit, O/B	2"	40 PSI	INCLUDES "WP"	67657P
Instrument Set "INBOARD/STERNDRIVE" 6 Gauge set				67654P

* Mariner 30 & 40 HP (2-cylinder) engines require a module (Mercury P/N 17461A2) when using any of these tachometers. Not tested for non-original-equipment (aftermarket) ignition systems. Not for diesels.

** May require alternator tap.

All gauge products are only available in North America!

LIDO PRO — Hottest selling white dial line! A comprehensive family of instruments for most engine types, Lido features crisp white dials and fire-orange pointer tips. Red through-dial and white perimeter lighting provide great night readability. Excellent inboard coverage with engine sync gauges* and diesel alternator and magnetic pickup tachometers**.

*Module required, not included with gauge. **Magnetic Pickup sender available separately.



FEATURES:

- White dial, black numerals, black pointer with fire-orange tip.
- Scratch resistant curved glass lenses, with polished stainless steel, near-flush bezels.
- U.S. and metric scales, with ISO symbols.
- Optional add-on square bezels for modular appearance (See Gauge Accessories for details).
- White perimeter and red thru-dial lighting.
- Comprehensive line includes tachometers for diesel alternator and magnetic pickup PLUS synchronizer gauge (Suitable for gas or diesel engines with appropriate module. Module required, not included with gauge).

FOG RESISTANT GAUGE FEATURES:

- Fog-Resistant Design! Complies with SAE J-1810.

SELECTION GUIDE:

GAUGE DESCRIPTION	SIZE	DIAL RANGE	SENDER CODE	FOG RESISTANT
Engine Sync (gauge only)	2"	PORT-STBD.	REQUIRES "L"	
Fuel Gauge:	2"	E-1/2-F	REQUIRES "F"	59655P
Hourmeter:	2"	10,000 Hrs.	NONE REQ'D	59416P
Oil Pressure Gauges (Electric):				
Oil Pressure 80 PSI	2"	0-80 PSI	REQUIRES "C"	59653P
Oil Pressure 100 PSI	2"	0-100 PSI	REQUIRES "C"	
GPS Speedometer:				
35 MPH	3"	0-35 MPH		781-310-035P
60 MPH	3"	0-60 MPH		781-310-060P
80 MPH	3"	0-80 MPH		
Speedometer Kits:				
35 MPH (Pitot type)	3"	5-35 MPH	INCLUDES "G"	59713P
35 MPH (Pitot type) Head Only	3"	5-35 MPH		
50 MPH (Pitot type)	3"	10-50 MPH	INCLUDES "G"	61752FP
50 MPH (Pitot type) Head Only	3"	10-50 MPH		
65 MPH (Pitot type)	3"	10-65 MPH	INCLUDES "G"	
80 MPH (Pitot type)	3"	20-80 MPH	INCLUDES "G"	59649P
80 MPH (Pitot type) Head Only	3"	20-80 MPH		
Systems Check – Evinrude/Johnson:	2"	SYSTEM DATA	BY ENG. MFR.	
Tachometer (Electric):				
O/B & 4-Stroke Gas Engines*	3"	0-7000 RPM	O/B ALT./COIL	59737P
Systems Check – Evinrude/Johnson	3"	0-7000 RPM	O/B ALT./COIL	
Tachometer/Hourmeters (Electric):				
O/B & 4-Stroke Gas Engines*	3"	0-7000 RPM	O/B ALT./COIL	
Diesel Alternator**	3"	0-4000 RPM	SEE "T"	
Diesel Magnetic Pickup, 90-180 Teeth	3"	0-4000 RPM	REQUIRES "B"	
Trim Gauges (Outboard, I/O):				
Evinrude/Johnson Outboard	2"	UP-DOWN	BY ENG. MFR.	
Honda Outboards	2"	UP-DOWN	BY ENG. MFR.	
Mariner/Merc/Cobra/Volvo DP, SX, Yamaha 2001, and on	2"	UP-DOWN	BY ENG. MFR.	59657P
Suzuki 4-Stroke, 2002 to date	2"	UP-DOWN	BY ENG. MFR.	
Yamaha Outboards, pre 2001	2"	UP-DOWN	BY ENG. MFR.	
Voltmeter-12 Volt:	2"	8-18 VDC	NONE REQ'D	59656P
Warning Light Gauge – Suzuki:	2"	SYSTEM DATA	BY ENG. MFR.	
Water Pressure Kit (Outboard):***				
Each kit includes fittings and 20 feet of tubing)	2"	30 PSI	INCLUDES "WP"	63523P
Water Temp. Kit (Outboard):***				
(For all electric-start outboards)	2"	COLD-HOT	INCLUDES "J"	
Water Temp. Gauge (I/O, I/B):	2"	120-240°F	REQUIRES "D"	59654P
Instrument Set "OUTBOARD"	4 Gauge set			67669P
Instrument Set "INBOARD/STERNDRIVE"	6 Gauge set			67653P

All gauge products are only available in North America!

LIDO — Hottest selling white dial line! A comprehensive family of instruments for most engine types, Lido features crisp white dials and fire-orange pointer tips. Red through-dial and white perimeter lighting provide great night readability. Excellent inboard coverage with engine sync gauges* and diesel alternator and magnetic pickup tachometers**.

*Module required, not included with gauge. **Magnetic Pickup sender available separately.



FEATURES:

- White dial, black numerals, black pointer with fire-orange tip.
- Scratch resistant curved glass lenses, with polished stainless steel, near-flush bezels.
- U.S. and metric scales, with ISO symbols.
- Optional add-on square bezels for modular appearance (See Gauge Accessories for details).
- White perimeter and red thru-dial lighting.
- Comprehensive line includes tachometers for diesel alternator and magnetic pickup PLUS synchronizer gauge (Suitable for gas or diesel engines with appropriate module. Module required, not included with gauge).

SELECTION GUIDE:

GAUGE DESCRIPTION	SIZE	DIAL RANGE	SENDER CODE	PART NUMBER
Engine Sync (gauge only)	2"	PORT-STBD.	REQUIRES "L"	65495P
Fuel Gauge:	2"	E-1/2-F	REQUIRES "F"	65496P
Hourmeter:	2"	10,000 Hrs.	NONE REQ'D	65497P
Oil Pressure Gauges (Electric):				
Oil Pressure 80 PSI	2"	0-80 PSI	REQUIRES "C"	65501P
Oil Pressure 100 PSI	2"	0-100 PSI	REQUIRES "C"	65498P
GPS Speedometer:				
35 MPH	3"	0-35 MPH		
60 MPH	3"	0-60 MPH		
80 MPH	3"	0-80 MPH		
Speedometer Kits:				
35 MPH (Pitot type)	3"	5-35 MPH	INCLUDES "G"	61751P
35 MPH (Pitot type) Head Only	3"	5-35 MPH		61751PH
50 MPH (Pitot type)	3"	10-50 MPH	INCLUDES "G"	61752P
50 MPH (Pitot type) Head Only	3"	10-50 MPH		61752PH
65 MPH (Pitot type)	3"	10-65 MPH	INCLUDES "G"	65510P
80 MPH (Pitot type)	3"	20-80 MPH	INCLUDES "G"	65670P
80 MPH (Pitot type) Head Only	3"	20-80 MPH		65670PH
Systems Check – Evinrude/Johnson:	2"	SYSTEM DATA	BY ENG. MFR.	65206SSP
Tachometer (Electric):				
O/B & 4-Stroke Gas Engines*	3"	0-7000 RPM	O/B ALT./COIL	65693P
Systems Check – Evinrude/Johnson	3"	0-7000 RPM	O/B ALT./COIL	64477FP
Tachometer/Hourmeters (Electric):				
O/B & 4-Stroke Gas Engines*	3"	0-7000 RPM	O/B ALT./COIL	65129P
Diesel Alternator**	3"	0-4000 RPM	SEE "T"	65671P
Diesel Magnetic Pickup, 90-180 Teeth	3"	0-4000 RPM	REQUIRES "B"	65692P
Trim Gauges (Outboard, I/O):				
Evinrude/Johnson Outboard	2"	UP-DOWN	BY ENG. MFR.	65502P
Honda Outboards	2"	UP-DOWN	BY ENG. MFR.	65503P
Mariner/Merc/Cobra/Volvo DP, SX, Yamaha 2001, and on	2"	UP-DOWN	BY ENG. MFR.	65504P
Suzuki 4-Stroke, 2002 to date	2"	UP-DOWN	BY ENG. MFR.	65502P
Yamaha Outboards, pre 2001	2"	UP-DOWN	BY ENG. MFR.	65505P
Voltmeter-12 Volt:	2"	8-18 VDC	NONE REQ'D	65506P
Warning Light Gauge – Suzuki:	2"	SYSTEM DATA	BY ENG. MFR.	65669SSP
Water Pressure Kit (Outboard):*** Each kit includes fittings and 20 feet of tubing)	2"	30 PSI	INCLUDES "WP"	65507P
Water Temp. Kit (Outboard):*** (For all electric-start outboards)	2"	COLD-HOT	INCLUDES "J"	65508P
Water Temp. Gauge (I/O, I/B):	2"	120-240°F	REQUIRES "D"	65509P
Instrument Set "OUTBOARD"	4 Gauge set			
Instrument Set "INBOARD/STERNDRIVE"	6 Gauge set			

* Mariner 30 & 40 HP (2-cylinder) engines require a module (Mercury P/N 17461A2) when using any of these tachometers. Not tested for non-original-equipment (aftermarket) ignition systems. Not for diesels.

** May require alternator tap. *** Adapter (P/N 61886P) is required for Yamaha.

All gauge products are only available in North America!

DRIFTWOOD — Features light gray dials, clean black numerals and a black pointer hub with white staff. These instruments lend a sophisticated look to any dash. Combination blue through-dial and white perimeter lighting are included for excellent readability at night.

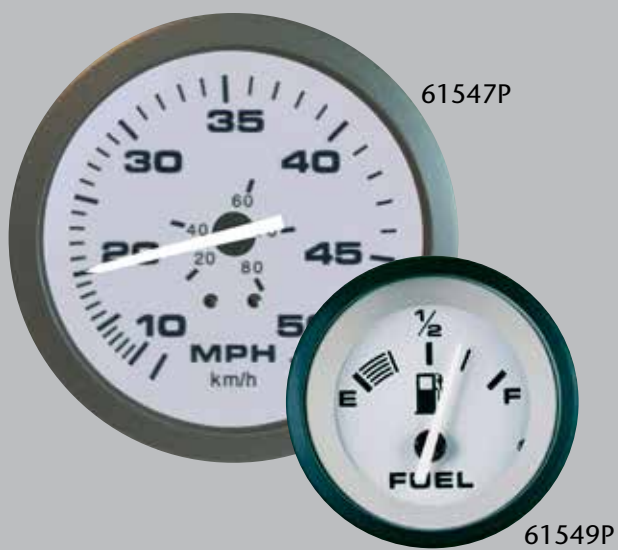

FEATURES:

- Light gray dial, black graduations/numerals, white pointer staff.
- Scratch resistant curved glass lenses, with black, near-flush bezels.
- White perimeter and blue thru-dial lighting.
- U.S. and metric scales, with ISO symbols, where appropriate.
- Optional add-on square bezels for modular appearance (See Gauge Accessories for details).

SELECTION GUIDE:

GAUGE DESCRIPTION	SIZE	DIAL RANGE	SENDER CODE	PART NUMBER
Fuel Gauge:	2"	E-1/2-F	REQUIRES "F"	61549P
Hourmeter:	2"	10,000 Hrs.	NONE REQ'D	62952P
Oil Pressure Gauge (Electric):	2"	0-80 PSI	REQUIRES "C"	61550P
Speedometer Kits:				
50 MPH (Pitot type)	3"	10-50 MPH	INCLUDES "G"	61547P
80 MPH (Pitot type)	3"	20-80 MPH	INCLUDES "G"	63516P
Tachometer (Electric):				
O/B & 4-Stroke Gas Engines*	3"	0-7000 RPM	O/B ALT./COIL	61546P
Systems Check – Evinrude/Johnson	3"	0-7000 RPM	O/B ALT./COIL	62698P
Tachometer/Hourmeter (Electric):				
O/B & 4-Stroke Gas Engines*	3"	0-7000 RPM	O/B ALT./COIL	63941P
Trim Gauges (Outboard, I/O):				
Evinrude/Johnson Outboard	2"	UP-DOWN	BY ENG. MFR.	62373P
Honda	2"	UP-DOWN	BY ENG. MFR.	62375P
Mariner/Merc/Cobra/Volvo DP, SX, Yamaha 2001 and on	2"	UP-DOWN	BY ENG. MFR.	61551P
Suzuki 4-Stroke, 2002 to date	2"	UP-DOWN	BY ENG. MFR.	62373P
Voltmeter-12 Volt:	2"	8-18 VDC	NONE REQ'D	61548P
Water Pressure Kit (Outboard):** (Kit includes fittings/20 feet of tubing)	2"	30 PSI	INCLUDES "WP"	62960P
Water Temp. Gauge (I/O, I/B):	2"	100-220°F	REQUIRES "D"	61552P

* Mariner 30 & 40 HP (2-cylinder) engines require a module (Mercury P/N 17461A2) when using any of these tachometers. Not tested for non-original-equipment (aftermarket) ignition systems. Not for diesels.

** Adapter (P/N 61886P) is required for Yamaha.

SAHARA — With crisp tan dials and fire-orange pointer tip, Sahara gives any dash the elegant OEM look. Combined red through-dial and white perimeter lighting provide great night readability. These aren't merely "close enough" — they're the real thing!



FEATURES:

- Tan dial and retainer, black graduations and numerals, black pointer with fire-orange tip.
- Scratch resistant curved glass lenses, with black matte, near-flush bezels.
- White perimeter and red thru-dial lighting.
- U.S. and metric scales, with ISO symbols, where appropriate.
- Optional add-on square bezels for modular appearance (See Gauge Accessories for details).

SELECTION GUIDE:

GAUGE DESCRIPTION	SIZE	DIAL RANGE	SENDER CODE	PART NUMBER
Fuel Gauge:	2"	E-1/2-F	REQUIRES "F"	59707P
Oil Pressure Gauge (Electric):	2"	0-80 PSI	REQUIRES "C"	59705P
Speedometer Kits:				
35 MPH (Pitot type)	3"	5-35 MPH	INCLUDES "G"	61826P
35 MPH (Pitot type) Head Only	3"	5-35 MPH		61826PH
50 MPH (Pitot type)	3"	10-50 MPH	INCLUDES "G"	61163P
65 MPH (Pitot type)	3"	10-65 MPH	INCLUDES "G"	59704P
65 MPH (Pitot type) Head Only	3"	10-65 MPH		59704PH
80 MPH (Pitot type)	3"	20-80 MPH	INCLUDES "G"	63076P
80 MPH (Pitot type) Head Only	3"	20-80 MPH		63076PH
Systems Check – Evinrude/Johnson:	2"	SYSTEM DATA	BY ENG. MFR.	66956P
Tachometer (Electric):				
O/B & 4-Stroke Gas Engines*	3"	0-7000 RPM	O/B ALT./COIL	59703P
Systems Check – Evinrude/Johnson	3"	0-7000 RPM	O/B ALT./COIL	61901P
Tach/Hourmeter 0-7000 RPM	3"	0-7000 RPM	O/B ALT./Coil	69743P
Trim Gauges (Outboard, I/O):				
Evinrude/Johnson Outboard	2"	UP-DOWN	BY ENG. MFR.	61908P
Honda Outboards	2"	UP-DOWN	BY ENG. MFR.	62369P
Mariner/Merc/Cobra/Volvo DP, SX, Yamaha 2001 and on	2"	UP-DOWN	BY ENG. MFR.	59709P
Suzuki 4-Stroke, 2002 to date	2"	UP-DOWN	BY ENG. MFR.	61908P
Voltmeter-12 Volt:	2"	8-18 VDC	NONE REQ'D	59708P
Water Pressure Kits (Outboard):** (Each kit includes fittings and 20 feet of tubing)	2"	30 PSI	INCLUDES "WP"	69870P
Water Temp. Gauge (I/O, I/B):	2"	120-240°F	REQUIRES "D"	59706P
Instrument Set "OUTBOARD"	4 Gauge set			65481P
Instrument Set "INBOARD/STERNDRIVE"	6 Gauge set			65485P
Twin Engine Add On IB/IO Gauge Kit	4 Gauge Set			69717P
Twin Engine Add On OBGauge Kit	2 Gauge set			69716P
Instrument Set OB w/Tach/Hr	4 Gauge Set			69703P
Instrument Set IB/IO w/Tach/Hr	6 Gauge set			69704P

* Mariner 30 & 40 HP (2-cylinder) engines require a module (Mercury P/N 17461A2) when using any of these tachometers. Not tested for non-original-equipment (aftermarket) ignition systems. Not for diesels.

** Adapter (P/N 61886P) is required for Yamaha.

All gauge products are only available in North America!

STERLING — Ideal for outboards and stern drives! With stainless steel bezels, brushed aluminum dials and black pointers, Sterling instruments give a bright, gleaming look to any dash. Perimeter lighting provided for night operation.



FEATURES:

- Brushed aluminum dial, black graduations/numerals, black pointer.
- Scratch resistant curved glass lenses, with polished stainless steel, near-flush bezels.
- Perimeter lighting.
- U.S. and metric scales, with ISO symbols, where appropriate.
- Optional add-on square bezels for modular appearance (See Gauge Accessories for details).

SELECTION GUIDE:

GAUGE DESCRIPTION	SIZE	DIAL RANGE	SENDER CODE	PART NUMBER
Fuel Gauge:	2"	E-1/2-F	REQUIRES "F"	63477P
Oil Pressure Gauge (Electric):	2"	0-80 PSI	REQUIRES "C"	63479P
Speedometer Kits:				
65 MPH (Pitot type)	3"	10-65 MPH	INCLUDES "G"	63475P
65 MPH (Pitot type) Head Only	3"	10-65 MPH		63475PH
80 MPH (Pitot type)	3"	20-80 MPH	INCLUDES "G"	63476P
80 MPH (Pitot type) Head Only	3"	20-80 MPH		63476PH
Systems Check – Evinrude/Johnson:	2"	SYSTEM DATA	BY ENG. MFR.	63585P
Tachometer (Electric):				
O/B & 4-Stroke Gas Engines*	3"	0-7000 RPM	O/B ALT./COIL	63473P
Tachometer/Hourmeter (Electric):				
O/B & 4-Stroke Gas Engines*	3"	0-7000 RPM	O/B ALT./COIL	63474P
Trim Gauges (Outboard, I/O):				
Evinrude/Johnson Outboard	2"	UP-DOWN	BY ENG. MFR.	63483P
Honda	2"	UP-DOWN	BY ENG. MFR.	64475P
Mariner/Merc/Cobra/Volvo DP, SX, Yamaha 2001 and on	2"	UP-DOWN	BY ENG. MFR.	63482P
Suzuki 4-Stroke, 2002 to date	2"	UP-DOWN	BY ENG. MFR.	63483P
Voltmeter-12 Volt:	2"	8-18 VDC	NONE REQ'D	63478P
Water Pressure Kit (Outboard):** (Kit includes fittings/20 feet of tubing)	2"	30 PSI	INCLUDES "WP"	63481P
Water Temp. Gauge (I/O, I/B):	2"	120-240°F	REQUIRES "D"	63480P

* Mariner 30 & 40 HP (2-cylinder) engines require a module (Mercury P/N 17461A2) when using any of these tachometers.

Not tested for non-original-equipment (aftermarket) ignition systems. Not for diesels.

** Adapter (P/N 61886P) is required for Yamaha.

All gauge products are only available in North America!

BLACK STERLING — With its rich luster and polish, Black Sterling instruments convey a look of utmost sophistication and add elegance to any dash. These instruments have fire-orange pointer tips and stainless graphics for a contemporary, ultra stylish look. Black Sterling instruments have clean, crisp black dials which highlight the stainless accents.



FEATURES:

- Scratch-resistant domed glass lens.
- Perimeter lit dial.
- Elite stainless steel bezel.
- Black pointer with fire orange tip.
- White graphics and black background on spun aluminum dial.
- Fits most stern drive and outboard applications.
- US and Metric scales where appropriate.

MULTI-GAUGE FEATURES:

- Combines 2 gauges in one.
- Saves dash space.
- Fog-Resistant Design! Complies with SAE J-1810.

SELECTION GUIDE:

GAUGE DESCRIPTION	SIZE	DIAL RANGE	SENDER CODE	PART NUMBER
Fuel Gauge	2"	E-1/2-F	REQUIRES "F"	67021P
Voltmeter	2"	8-18 VDC	NONE REQ'D	67019P
Water Temperature (Electric)	2"	100-240°F	REQUIRES "D"	67020P
Oil Pressure (Electric)	2"	0-80 PSI	REQUIRES "C"	67022P
35 MPH Speedometer Kit	3"	0-35 MPH	INCLUDES "G"	67283P
35 MPH Speedometer (Head Only)	3"	0-35 MPH		67283PH
50 MPH Speedometer	3"	0-50 MPH	INCLUDES "G"	68960P
50 MPH Speedometer (Head Only)	3"	0-50 MPH		68960PH
70 MPH Speedometer Kit	3"	0-70 MPH	INCLUDES "G"	67285P
Tachometer: O/B & 4 Cycle Gas	3"	0-7000 RPM	O/B ALT./COIL	67363P
Tach/LCD Hr, O/B & 4 Cycle Gas	3"	0-7000 RPM	O/B ALT./COIL	67364P
Trim: Honda	2"	UP-DOWN	BY ENG. MFR.	67855P
Trim: Mariner/Mercury Yamaha, 2001 to date	2"	UP-DOWN	BY ENG. MFR.	67023P
Trim: Evinrude/ Johnson Suzuki 4-Stroke, 2002 to date	2"	UP-DOWN	BY ENG. MFR.	67365P
O/B Water Pressure Kit	2"	0-40 PSI	INCLUDES "WP"	67382P
MULTI-GAUGE DESCRIPTION	SIZE	DIAL RANGE	SENDER CODE	PART NUMBER
Speedo/Fuel	3"	0-50 MPH E-1/2-F	REQUIRES "G" REQUIRES "F"	69073FP
Tach/Volt	3"	0-7000 RMP 8-18 VDC	O/B ALT./COIL NONE REQ'D	69074FP

* Mariner 30 & 40 HP (2-cylinder) engines require a module (Mercury P/N 17461A2) when using any of these tachometers. Not tested for non-original-equipment (aftermarket) ignition systems. Not for diesels.
 ** Adapter (P/N 61886P) is required for Yamaha.

All gauge products are only available in North America!

AMEGA — Hottest selling black dial line! Amega® Domed has clean-looking black dials with white and red graphics plus through-dial and perimeter lighting for great readability. Amega has been very popular, available in several styles since its debut in 1986.



FEATURES:

- Black dial, red graduations, white numerals, vivid white pointer staff.
- Scratch resistant curved glass lenses, with black, near-flush bezels.
- U.S. and metric scales, with ISO symbols, where appropriate.
- Perimeter and thru-dial lighting.
- A comprehensive array of outboard water pressure instrument kits.
- Optional add-on square bezels for modular appearance (See Gauge Accessories for details).

SELECTION GUIDE:

GAUGE DESCRIPTION	SIZE	DIAL RANGE	SENDER CODE	PART NUMBER
Fuel Gauge:	2"	E-1/2-F	REQUIRES "F"	57902P
Hourmeter:	2"	10,000 Hrs.	NONE REQ'D	84760P
Oil Pressure Gauges (Electric):				
Oil Pressure 80 PSI	2"	0-80 PSI	REQUIRES "C"	57903P
Oil Pressure 100 PSI	2"	0-100 PSI	REQUIRES "C"	57929P
GPS Speedometer:				
35 MPH	3"	0-35 MPH	GPS RECEIVER	781-579-035P
60 MPH	3"	0-60 MPH		781-579-060P
80 MPH	3"	0-80 MPH		781-579-080P
Speedometer Kits:				
35 MPH (Pitot type)	3"	5-35 MPH	INCLUDES "G"	58342P
35 MPH (Pitot type) Head Only	3"	5-35 MPH		58342PH
50 MPH (Pitot type)	3"	10-50 MPH	INCLUDES "G"	57898P
50 MPH (Pitot type) Head Only	3"	10-50 MPH		57898PH
65 MPH (Pitot type)	3"	10-65 MPH	INCLUDES "G"	57900P
65 MPH (Pitot type) Head Only	3"	10-65 MPH		57900PH
80 MPH (Pitot type)	3"	20-80 MPH	INCLUDES "G"	57899P
80 MPH (Pitot type) Head Only	3"	20-80 MPH		57899PH
Systems Check – Evinrude/Johnson:	2"	SYSTEM DATA	BY ENG. MFR.	65205P
Tachometer (Electric):				
O/B & 4-Stroke Gas Engines*	3"	0-7000 RPM	O/B ALT./COIL	58255P
Systems Check – Evinrude/Johnson	3"	0-7000 RPM	O/B ALT./COIL	58935P
Diesel Alt	3"	0-4000 RPM	ALTERNATOR	68358P
Force	3"	0-7000 RPM		69044P
Tachometer/Hourmeter (Electric):				
O/B & 4-Stroke Gas Engines*	3"	0-6000 RPM	O/B ALT./COIL	57897P
Tach/Hourmeter	3"	0-7000		68443P*
Trim Gauges (Outboard, I/O):				
Evinrude/Johnson Outboard	2"	UP-DOWN	BY ENG. MFR.	58431P
Honda	2"	UP-DOWN	BY ENG. MFR.	68359P
Mariner/Merc/Cobra/Volvo DP, SX, Yamaha 2001 and on	2"	UP-DOWN	BY ENG. MFR.	57905P
Yamaha PRE 2001	2"	UP-DOWN	BY ENG. MFR.	61748P
Suzuki 4-Stroke, 2002 to date	2"	UP-DOWN	BY ENG. MFR.	58431P
Voltmeter-12 Volt:	2"	8-18 VDC	NONE REQ'D	57901P
Warning Light Gauge – Suzuki:	2"	SYSTEM DATA	BY ENG. MFR.	65668BMDP
Water Pressure Kits (Outboard):**	2"	40 PSI	INCLUDES "WP"	68357P
(Each kit includes fittings and 20 feet of tubing)	2"	30 PSI	INCLUDES "WP"	61238P
Water Temp. Kit (Outboard):**				
(For all electric-start outboards)	2"	100-220°F	INCLUDES "J"	58862P
Water Temp. Gauge (I/O, I/B):	2"	120-240°F	REQUIRES "D"	57904P
Ammeter, Amega 60-0-60	2"			68356P
Battery Condition Indicator, 12 VDC			NONE REQ'D	68361P
Instrument Set "OUTBOARD"	4 Gauge set			68362P
Instrument Set "INBOARD/STERNDRIVE"	6 Gauge set			68363P
Twin Engine Add On IB/IO Gauge Kit	4 Gauge Set			69722P
Twin Engine Add On OB Gauge Kit	2 Gauge set			69721P
Instrument Set OB w/Tach/Hr	4 Gauge Set			69708P
Instrument Set IB/IO w/Tach/Hr	6 Gauge set			69709P

Mariner 30 & 40 HP (2-cylinder) engines require a module (Mercury P/N 17461A2) when using any of these tachometers. Not tested for non-original-equipment (aftermarket) ignition systems. Not for diesels.

** Adapter (P/N 61886P) is required for Yamaha.

All gauge products are only available in North America!

ARCTIC — Stylish white bezel design, black on white graphics, accurate and reliable, these tough instruments look good on all types of boats. Domed glass sheds water and resists scratching.



FEATURES:

- Instruments available for most outboards, stern drives and gasoline-powered inboards.
- Scratch-resistant domed glass lenses.
- Enhanced illumination: through-dial and perimeter lighting for excellent readability at night.
- Low-range speedometers.
- U.S. and metric scales, with ISO symbols, where appropriate.
- Optional add-on square bezels for modular appearance (See Gauge Accessories for details).

SELECTION GUIDE:

GAUGE DESCRIPTION	SIZE	DIAL RANGE	SENDER CODE	PART NUMBER
Ammeter	2"	60-0-60	REQUIRES "F"	68364P
Fuel Gauge	2"	(E-F)	NONE REQ'D	68365P
Hourmeter	2"	10,000 hrs		68366P
Eng Oil Pressure gauge 0-80 PSI	2"	0-80 PSI	REQUIRES "C"	68367P
Water Pressure Kits (Outboard): (Each kit includes fittings and 20 feet of tubing).	2"	0-40 PSI	INCLUDES "WP"	68369P
GPS Speedometer:				
35 MPH	3"	0-35 MPH	GPS RECEIVER	781-683-035P
60 MPH	3"	0-60 MPH		781-683-060P
80 MPH	3"	0-80 MPH		781-683-080P
Speedo Kit 0-35 mph (inc Pitot and Hose)	3"	5-35 MPH	INCLUDES "G"	68370P
Speedo Kit 0-65 mph (inc Pitot and Hose)	3"	10-65 MPH	INCLUDES "G"	68371P
Speedo Kit 0-80 mph (inc Pitot and Hose)	3"	20-80 MPH	INCLUDES "G"	68372P
Tachometer 0-4000 RPM Diesel Alt	3"	0-4000 RPM	ALTERNATOR	68373P
Tachometer 0-7000 RPM	3"	0-7000 RPM	O/B ALT./COIL	68374P
Tach/Hourmeter 0-7000 RPM Petrol/Gas	3"	0-7000 RPM	O/B ALT./COIL	68375P
I/O, I/B Water Temp Gauge	2"	120-240°F	REQUIRES "D"	68376P
Outboard Water Temp Kit (Cold-Hot)	2"	100-220°F	INCLUDES "J"	68377P
Trim, Evinrude/Johnson O/B	2"	UP-DOWN	BY ENG. MFR.	68378P
Trim, Honda	2"	UP-DOWN	BY ENG. MFR.	68379P
Trim, Mariner/Merc, Yamaha 2001	2"	UP-DOWN	BY ENG. MFR.	68380P
Trim, Yamaha Outboards, pre 2001	2"	UP-DOWN	BY ENG. MFR.	68381P
12v Voltmeter, 8-18 Volts	2"	8-18 VDC	NONE REQ'D	68383P
12 Battery Condition Indicator	2"		NONE REQ'D	68384P
System Check - Evinrude/Johnson	2"		BY ENG. MFR.	68385P
System Check - Suzuki	2"		BY ENG. MFR.	68386P
Instrument Set "OUTBOARD"	4 Gauge set			68387P
Instrument Set "INBOARD/STERNDRIVE"	6 Gauge set			68388P
Instrument Set OB w/Tach/Hr	4 Gauge Set			69710P
Instrument Set IB/IO w/Tach/Hr	6 Gauge set			69711P
Twin Engine Add On IB/IO Gauge Kit	4 Gauge Set			69724P
Twin Engine Add On OB Gauge Kit	2 Gauge set			69723P

All gauge products are only available in North America!

ECLIPSE — Smart white and blue graphics on a black dial background, these very low profile bezels follow the curve of the lense to eliminate water trapping. Design with domed glass sheds water and resists scratching.



FEATURES:

- Instruments available for most outboards, stern drives and gasoline-powered inboards.
- Scratch-resistant domed glass lenses.
- Perimeter lighting for excellent readability at night.
- U.S. and metric scales, with ISO symbols, where appropriate.
- Optional add-on square bezels for modular appearance (See Gauge Accessories for details).

SELECTION GUIDE:

GAUGE DESCRIPTION	SIZE	DIAL RANGE	SENDER CODE	PART NUMBER
Ammeter	2"	60-0-60	REQUIRES "F"	68389P
Fuel Gauge	2"	(E-F)	NONE REQ'D.	68390P
Hourmeter	2"	10,000 hrs		68391P
Eng Oil Pressure gauge 0-80 PSI	2"	0-80 PSI	REQUIRES "C"	68392P
Eng Oil Pressure gauge 0-100 PSI	2"	0-100 PSI	REQUIRES "C"	68393P
Water Pressure Kits (Outboard): (Each kit includes fittings and 20 feet of tubing).	2"	0-40 PSI	INCLUDES "WP"	68394P
GPS Speedometer:				
35 MPH	3"	0-35 MPH	GPS RECEIVER	781-684-035P
60 MPH	3"	0-60 MPH		 781-684-060P
80 MPH	3"	0-80 MPH		781-684-080P
Speedo Kit 0-35 mph (inc Pitot and Hose)	3"	5-35 MPH	INCLUDES "G"	68395P
Speedo Kit 0-65 mph (inc Pitot and Hose)	3"	10-65 MPH	INCLUDES "G"	68396P
Speedo Kit 0-80 mph (inc Pitot and Hose)	3"	20-80 MPH	INCLUDES "G"	68397P
Tachometer 0-4000 RPM Diesel Alt	3"	0-4000 RPM	ALTERNATOR	68398P
Tachometer 0-7000 RPM	3"	0-7000 RPM	O/B ALT./COIL	68399P
Tach/Hourmeter 0-7000 RPM Petrol/Gas	3"	0-7000 RPM	O/B ALT./COIL	68400P
I/O, I/B Water Temp Gauge	2"	120-240°F	REQUIRES "D"	68401P
Outboard Water Temp Kit (Cold-Hot) - includes "J"	2"	100-220°F	INCLUDES "J"	68402P
Trim, Evinrude/Johnson O/B	2"	UP-DOWN	BY ENG. MFR.	68403P
Trim, Honda	2"	UP-DOWN	BY ENG. MFR.	68404P
Trim, Mariner/Merc, Yamaha 2001	2"	UP-DOWN	BY ENG. MFR.	68405P
Trim, Yamaha Outboards, pre 2001	2"	UP-DOWN	BY ENG. MFR.	68406P
12v Voltmeter, 8-18 Volts	2"	8-18 VDC	NONE REQ'D.	68408P
12v Battery Condition Indicator	2"		NONE REQ'D.	68409P
System Check - Evinrude/Johnson	2"		BY ENG. MFR.	68410P
System Check - Suzuki	2"		BY ENG. MFR.	68411P
Instrument Set "OUTBOARD"	4 Gauge set			68412P
Instrument Set "INBOARD/STERNDRIVE"	6 Gauge set			68413P
Twin Engine Add On IB/IO Gauge Kit	4 Gauge Set			69726P
Twin Engine Add On OBGauge Kit	2 Gauge set			69725P
Instrument Set OB w/Tach/Hr	4 Gauge Set			69712P
Instrument Set IB/IO w/Tach/Hr	6 Gauge set			69713P

All gauge products are only available in North America!

HEAVY DUTY — A classic line for inboards including diesels, Heavy Duty includes mechanical water temperature and oil pressure gauges, ammeters, engine sync gauges* and a range of diesel tachometers, including a programmable tach/hourmeter.

*Module required, not included with gauge.



FEATURES:

- Classic white graphics and pointer on deep black faces.
- Low-profile polished stainless steel bezels.
- Perimeter lighting and scratch resistant glass lenses.
- Tachometers for diesels available.
- Several temperature and mechanical oil pressure gauges available.
- Programmable tach/hourmeter offered.
- Ideal replacement for Stewart-Warner® "Deluxe" instruments.
- Optional add-on square bezels for modular appearance (See Gauge Accessories for details).

SELECTION GUIDE:

GAUGE DESCRIPTION	SIZE	DIAL RANGE	SENDER CODE	PART NUMBER
Ammeters:				
Direct Reading 40 Amp Range	2"	40-0-40A	NONE REQ'D.	80712P
Direct Reading 60 Amp Range	2"	60-0-60A	NONE REQ'D.	80710P
Engine Synchronizer Gauge:	2"	Port-Starboard	REQUIRES "L"	80730P
Fuel Gauge:	2"	E-1/2-F	REQUIRES "F"	80150P
Hourmeter:	2"	10,000 Hrs.	NONE REQ'D.	82760P
Oil Pressure Gauges (Electric):				
Oil Pressure 80 PSI	2"	0-80 PSI	REQUIRES "C"	80180P
Oil Pressure 100 PSI	2"	0-100 PSI	REQUIRES "C"	80181P
Oil Pressure 100 PSI, Nylon, 24 Volt	2"	0-100 PSI	REQUIRES "C"	67353P
Oil Pressure Gauge (Mechanical, 1/8" NPT connection):				
Oil Pressure 100 PSI****	2"	0-100 PSI	****	82380P
Oil Temperature Gauge (Electric):				
Oil Temperature 320°F	2"	140-320° F	REQUIRES "E"	80596P
Speedometer Kit:				
60 MPH (Pitot Type)	3"	10-60 MPH	INCLUDES "G"	80514P
60 MPH (Pitot Type) Head Only	3"	10-60 MPH		80514PH
Tachometers (Electric):				
Diesel Alternator**	3"	0-3500 RPM	SEE "T"	82302P
Diesel Magnetic Pickup, 90-180 Teeth	3"	0-3500 RPM	REQUIRES "B"	82303P
Diesel Signaflex ***	3"	0-3500 RPM	SIGMAFLEX	82301P
O/B & 4-Stroke Gas Engines*	3"	0-6000 RPM	O/B ALT./COIL	82288P
Tachometer/Hourmeter (Electric, Programmable):				
Diesel, Low Frequency, 133-1248 HZ	3"	0-3500 RPM	"B", OR "T"	82430P
Water Temp. Gauge (Electric):				
Water Temp 240°F	2"	120-240°F	REQUIRES "D"	80590P
Water Temp 280°F, Nylon	2"	100-280	REQUIRES "P"	80593P
Water Temp. Gauges (Mechanical):				
Water Temp 265°F, with 72" Tube	2"	100-265° F	INCLUDES "Q"	82418P
Voltmeters-12 & 24 Volt:				
12 Volt System	2"	10-16 VDC	NONE REQ'D.	80134P
24 Volt System	2"	20-32 VDC	NONE REQ'D.	80131P
Vacuum Gauge, Mechanical, Nylon	2"	0-30 Hg.	****	82410P

* Mariner 30 & 40 HP (2-cylinder) engines require a module (Mercury P/N 17461A2) when using any of these tachometers. Not tested for non-original-equipment (aftermarket) ignition systems. Not for diesels.

** May require alternator tap

*** Signaflex senders and drive tips are for domestic diesel engines only (not for Lehman, Renault, Volvo, Yanmar, etc.)

**** Use suitable hose or tubing. NOT available from Teleflex.

All gauge products are only available in North America!



Illustration A
Oil Switch



Illustration B
Oil Pressure Sender



Illustration C
Temperature Sender



Illustration D
Temperature Switch



Illustration E
Safety Shut-Off Switch

PART NO.	STEWART WARNER PART NO.	FARIA PART NO.	MEDALLION PART NO.	DATCON PART NO.	VDO PART NO.	CRUSADER PART NO.	MERCURUISER PART NO.	VOLVO PART NO.	OMC PART NO.	VEETHREE TELEFLEX PART NO.	RANGE	THREAD SIZE	TERMINAL TYPE
----------	-------------------------	----------------	--------------------	-----------------	--------------	-------------------	----------------------	----------------	--------------	----------------------------	-------	-------------	---------------

OIL PRESSURE SWITCHES (ILLUSTRATION A)

OP22900	364L-F										6 psi Trip	1/8-27	10-32 stud
OP22891	364K-F										15 psi Trip	1/8-27	10-32 stud

OIL PRESSURE SENDERS (ILLUSTRATION B) - Code C

18-5899	279-A	90512	A-2547	02504-00	360 801	700425	815425T		982650	IA15001	80 psi	1/8-27	10-32 stud
OP24301	279B-F	90519	A-2547-1	02505-00	360 811		850362			IA15016	100 psi	1/8-27	10-32 stud
OP24891	82514	90511	A-2622	02504-01				872064		IA15003	80 psi DS	1/8-27	10-32 stud

TEMPERATURE SWITCHES (ILLUSTRATION D)

TS25111	83307				232011017039						200 Trip	1/2-14	1/4" blade
TS25101	83304				232011017088						200 Trip	3/8-18	1/4" blade

TEMPERATURE SENDERS (ILLUSTRATION C) - Code D

18-5896	362CZ-D	90401	B-936							52320S010	240°	1/8-27	10-32 stud
TS26611	362AN-D	90402	B-936-1							52320S004	240°	1/4-18	10-32 stud
TS26621	362AJ-D	90403	B-936-2				97257A 1			52320S009	240°	3/8-18	10-32 stud
TS26631	362AH-D	90404	B-936-3			700427	97258A 1		171960	52320S003	240°	1/2-14	10-32 stud
TS26651	362BD-D		A-2618-2								240° DS	1/4-18	10-32 stud
18-5897	352BC-D		A-2618-3					872068		52320S018	240° DS	3/8-18	10-32 stud
18-5898	362BB-D		A-2618-4							52320S017	240° DS	1/2-14	10-32 stud
18-7513								3862500			239°	1/8-27	
52320S26										52320S026	280°	3/8-18	10-32 stud

OIL PRESSURE SAFETY SHUT-OFF SWITCH (ILLUSTRATION E)

*OP72533												1/4-18	1/4" spade
-----------------	--	--	--	--	--	--	--	--	--	--	--	--------	------------

***3-wire hookup to starter, pump and ignition. I/O and inboard units require a method to shut off the electronic fuel pump when the engine fails or is shut down. This switch senses low oil pressure and shuts the fuel pump off.**

HOURLMETERS:



56966P
Hourmeter, Round



56967P
Hourmeter, Rect



69741P
Digital Analog Converter
Eliminates the need to replace the boats current analog gauges with expensive OEM digital gauges.



56968P
Small Engine Hourmeter
Replaces: Yamaha ENG-METER-2C-01
2 or 4 Stroke Gasoline
-No power or ground required



56969P
Small Engine Tach/Hourmeter
Fits 2 or 4 stroke, 2 Cylinders or Less
-No power or ground required

GAUGE ACCESSORIES:

Fuel Senders (Code F): 240-33 ohm Range

Code F

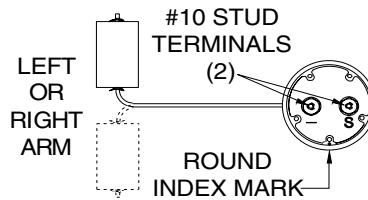
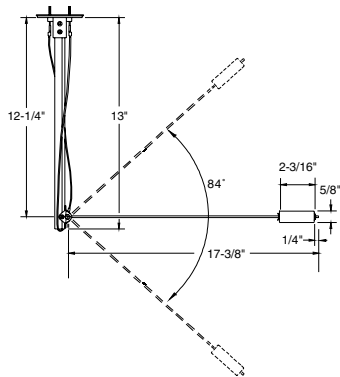

FLANGE MOUNTING DETAIL:

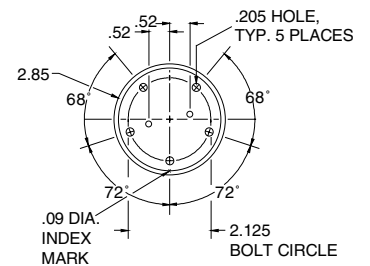

(Bend float arm as shown above for tanks less than 6" deep).

56948P
Sender, Fuel, Kit, w/Gauge,
4-24" Tank

90424P
Sender, Fuel, 4-24"
tankdepth

64082
Accessory, Fuel Sender Gasket

All gauge products are only available in North America!

Tachometer Accessories (B):

IH14767
Accessory, Tach
Harness, Evinrude,
Johnson



IH15105
Accessory, Mariner/
Merc O/B Tach
Harness



Code B

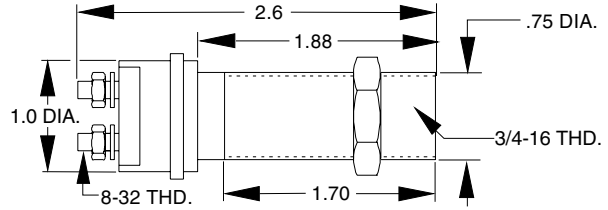

1507678P
Mag. Prox. Sender

Speedometer Senders and Accessories (Code G):



56973P
Pitot, 30-80 mph
Speedometers



59677P
Accessory, Pack O'Pitots
Package of 12

67437P
Accessory, Pitot
Hose Kit,
25' + Mnting Hdw.

56353P
Accessory, Pitot tubing, 30-80
mph, 100'

67457P
Pitot Tubing,
25'

Engine Synchronizer Module: (Code L):



1508370P
Eng Synch Module, 4-Cycle Gas

Code L

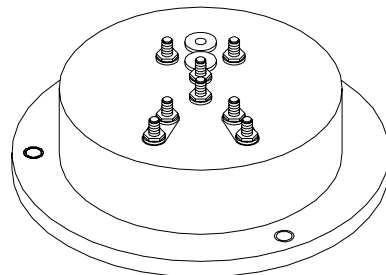

1471175
Accessory, Eng. Synch Harness

All gauge products are only available in North America!

Replacement Bulbs and Sockets:

<p>40102E007 Accessory, Lamp, Wedge Base, 24 volt</p>	<p>IA62995 Accessory, Light Kit, Wedge Base, 12VDC</p>	<p>1827871P Accessory, Bulb & Socket Kit</p>
--	---	---

Code Q:

Included with 82418P
Temperature (100°- 265°F, mechanical):

Fitting is 1/2-14 NPT thread
(Included with mechanical temperature gauge.)

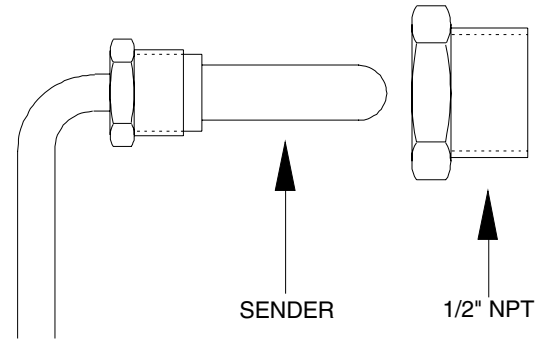

Code T:

Diesel Alternator Tachometers.....alternator

NOTE: Alternator must have an AC tap, usually marked "AC", "R" or "W". If such a tap is not present, a local alternator repair shop can usually add one.

You will need to know the number of magnetic poles in your alternator.

Consult the alternator maker or local alternator repair shop if you do not know this.

Also, you will have to calculate the pulley ratio from crankshaft to alternator.

Tachometers are factory calibrated for several combinations of poles and pulley ratios, but in almost all cases you will need a Portable Master Shop Tachometer for initial calibration.

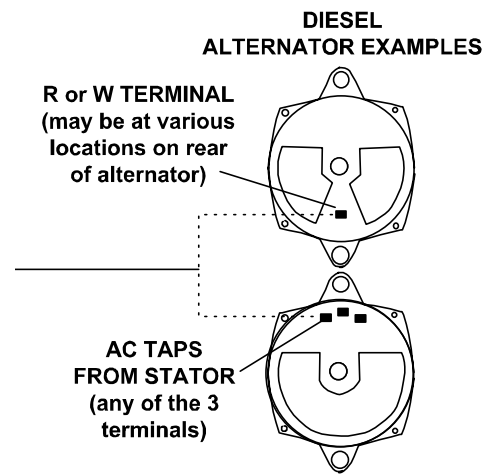

Code WP:

Water Pressure (0-15/0-30/0-40/0-60 PSI):
(Included with water pressure gauge kits, which contain the instrument, 20 feet of tubing and the parts shown at right.)

NOTE: For Yamaha, also order adapter P/N 61886P.

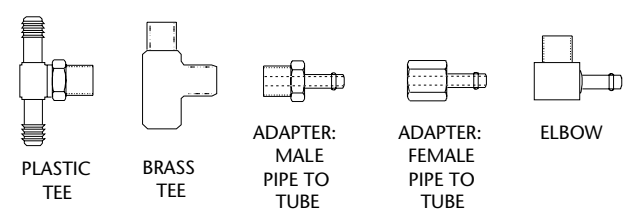

Miscellaneous Accessories:

<p>61886P Accessory, Yamaha Adapter for WP/Temp</p>	<p>6219371P Accessory, Dropping Resistor, 24-12V, 2" Gauges</p>	<p>IA17537 Accessory, Fuse Holder, Panel Mount</p>	<p>69269P Eyebrow Bezel, 3"</p>
<p>IA65476 Accessory, Aircraft Bezel, 2"</p>	<p>IA65477 Accessory, Aircraft Bezel, 3"</p>	<p>69268P Eyebrow Bezel, 2"</p>	<p>10860 Accessory, Gauge Blank</p>
<p>69270P Eyebrow Bezel, 6"</p>	<p>69380P Bezel Kit, For 4 Gauge Kit</p>	<p>69381P Bezel Kit, For 6 Gauge Kit</p>	

All gauge products are only available in North America!

Contact your local distributor for details.



CLEAR LINE OF SIGHT



GPS Speedometers

These GPS Speedometers provide accurate speed over ground readings and heading information all in one attractive package.



NAUTALIFT™ GAS LIFT SUPPORTS AND ACCESSORIES

Marine Grade Gas Filled Supports

- Annealed steel rods, nitride coated for corrosion resistance
- Engineered polymer rod ends
- Bronze bushings
- Multi-lobe internal seal
- Exact fit OEM replacement

Part No.	OE No.	Extended Length (inches)	Compressed Length (inches)	Rated (pounds)
GS62600	GSNI-4900-20	7.5	5.5	20
GS62610	GSNI-4900-40	7.5	5.5	40
GS62620	GSNI-4900-80	7.5	5.5	80
GS62630	GSNI-5000-20	10	7	20
GS62640	GSNI-5000-40	10	7	40
GS62650	GSNI-5000-60	10	7	60
GS62660	GSNI-5100-20	12	8.5	20
GS62670	GSNI-5100-30	12	8.5	30
GS62680	GSNI-5150-20	15	9.5	20
GS62690	GSNI-5150-30	15	9.5	30
GS62700	GSNI-5150-40	15	9.5	40
GS62710	GSNI-5150-60	15	9.5	60
GS62720	GSNI-5200-20	17	11	20
GS62730	GSNI-5200-30	17	11	30
GS62740	GSNI-5200-40	17	11	40
GS62750	GSNI-5200-60	17	11	60
GS62760	GSNI-5200-90	17	11	90
GS62770	GSNI-5300-20	20	12	20
GS62780	GSNI-5300-30	20	12	30
GS62790	GSNI-5300-40	20	12	40
GS62800	GSNI-5300-60	20	12	60
GS62810	GSNI-2300-80	20	12	80
GS62820	GSNI-2300-90	20	12	90
GS62830	GSNI-2300-120	20	12	120

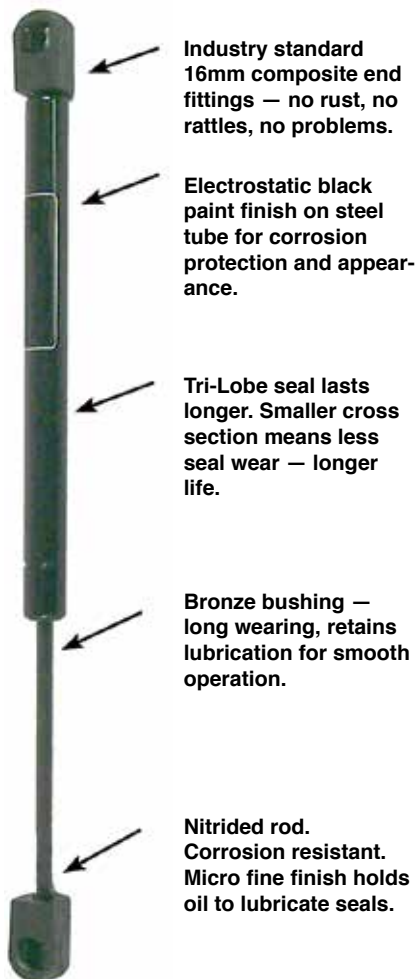

"NAUTALIFT™ STAINLESS STEEL GAS LIFT SUPPORTS"

Marine Grade Gas Filled Supports –

- Designed for demanding saltwater applications
- 316L Stainless Steel Rod and Cylinder
- Engineered polymer rod ends
- Bronze bushings
- Multi-lobe internal seal



Part No.	OE No.	Extended Length (inches)	Compressed Length (inches)	Rated (pounds)
GSS62600	GSSX--4900-20	7.5	5.5	20
GSS62610	GSSX--4900-40	7.5	5.5	40
GSS62630	GSSX--5000-20	10	7	20
GSS62640	GSSX--5000-40	10	7	40
GSS62670	GSSX--5100-30	12	8.5	30
GSS62680	GSSX--5150-20	15	9.5	20
GSS62700	GSSX--5150-40	15	9.5	40
GSS62710	GSSX--5150-60	15	9.5	60
GSS62720	GSSX--5200-20	17	11	20
GSS62740	GSSX--5200-40	17	11	40
GSS62750	GSSX--5200-50	17	11	50
GSS62760	GSSX--5200-90	17	11	90
GSS62770	GSSX--5300-20	20	12	20
GSS62780	GSSX--5300-30	20	12	30
GSS62790	GSSX--5300-40	20	12	40
GSS62800	GSSX--5300-60	20	12	60
GSS62820	GSSX--2300-90	20	12	90
GSS62830	GSSX--2300-120	20	12	120



GS62840
Black zinc plated steel flat bracket with 10mm ball stud. 2.25" wide.



GS62850
Stainless steel flat bracket with 10mm ball stud. 2.25" wide.



GS62860
Black zinc plated steel 90° angle bracket with 10mm ball stud. 2" wide, .65" base.



GS62870
Stainless steel 90° angle bracket with 10mm ball stud. 2" wide, .65" base.



GS62880
Black zinc plated steel 90° angle bracket with 10mm ball stud. 2" x 1.2" base.



GS62900
Stainless steel 90° angle bracket with 10mm ball stud. 2" x 1.2" base.



GS62910
Zinc plated steel 10mm ball stud with threaded shaft.



GS62920
Stainless steel 10mm ball stud with threaded shaft.



GS62890
Rod end with internal threads for either end of Nautalift gas filled lift supports. Unique construction makes installation easy and safe.

IGNITION SWITCHES FOR WORLD OUTBOARD MOTORS

- Exact OEM replacement installation
- Ideal for DFI, EFI and MPI engines
- Heavy duty potted construction
- Minimal bleed per circuit
- Molded umbrella type key



**MP51090
MP51092
IGNITION SWITCH**
3 Position Magneto – OFF- RUN-START
PUSH to Choke
Replaces: Mercury 87-17009A5



**MP52000
MP52002
IGNITION SWITCH**
3 Position Magneto – OFF- RUN-START
PUSH to Choke
Replaces: Mercury 87-88107A5



**MP51010 – CLAMSHELL
MP51012 – BULK 100 PCS/CTN
IGNITION SWITCH**
Suzuki 2 & 4 Stroke Outboards
Replaces: 37110-99E00
Colors on wires match factory color codes



**MP51020 – CLAMSHELL
MP51022 – BULK 100 PCS/CTN
IGNITION SWITCH**
Yamaha Control Box 2 & 4 stroke
Replaces: 703-82510-12-00
Colors on wires match factory color codes



**MP51030 – CLAMSHELL
MP51032 – BULK 100 PCS/CTN
IGNITION SWITCH**
Yamaha Dash Mount 2 Stroke
Dual Engine Application
Replaces: 61B-82510-01-00
Colors on wires match factory color codes



**MP51040 – CLAMSHELL
MP51042 – BULK 100 PCS/CTN
IGNITION SWITCH**
Yamaha Control Box 2 & 4 stroke
Push to Choke
Replaces: 703-82510-43-00
Colors on wires match factory color codes



**MP51050 – CLAMSHELL
MP51052 – BULK 100 PCS/CTN
IGNITION SWITCH**
Yamaha Dash Mount 2 & 4 Stroke
Dual Engine Application, Push to Choke
Replaces: 6K1-82510-06-00
Colors on wires match factory color codes

PART NUMBER		MAGNETO			CONVENTIONAL			TERMINAL TYPE				HOUSING MATERIAL			HARDWARE INCLUDED									
LONG HOUSING	SHORT HOUSING	PUSH TO CHOKE 4 POSITION ACC-OFF-IGN-START (CHOKE)	PUSH TO CHOKE 3 POSITION OFF-IGN-START (CHOKE)	MAGNETO 4-POSITION	MAGNETO 3-POSITION	4-POS. ACC. ACC-OFF-IGN-START	3-POSITION OFF-IGN-START	2-POSITION OFF-ON	NUMBER IN BOX DENOTES HOW MANY				BOSS/SCREW TYPE	DIE-CAST ZINC	POLYESTER	BRASS	BACK-UP NUT	BRASS BACK-UP NUT	KNURLED ALUMINUM	HEX BLACK PLASTIC	KNURLED BLACK RUBBER CAP	KNURLED CHROME RUBBER CAP	HEX CHROME	
MAXIMUM PANEL THICKNESS 1-1/8"	MAXIMUM PANEL THICKNESS 5/8"								WIRES ONLY	POTTED BASE	BLADE TYPE	THREADED STUD												SCREW TYPE
PART NO.	PART NO.																							
	UN12140					X					4			X		X		X						
	MP39010							X				2			X		X						X	
MP39020								X					2		X		X						X	
MP39040					X							5		X		X							X	
MP39060							X					3		X		X							X	
MP39080							X					3		X		X					X			
MP39100					X							5		X		X		X						
	MP39720			X							6			X		X			X					
	MP39740-1				X						5					X			X					
MP39120	MP39780						X					3		X		X		X						
	MP41030						X					3		X		X			X					
MP39200							X					3		X		X			X					
MP39700						X					4			X		X			X					
MP39730		X										6		X		X			X					
MP39770							X				3			X		X			X					
MP39800						X					4			X		X			X					
MP39820-1								X					2		X		X				X			
PUSH TO CHOKE	MP39710	X									7			X		X			X					
	MP39830				X							6		X		X			X					
	MP41020					X						4			X								X	
	MP41040					X						4		X		X			X					
	MP41122							X				2		X		X			X					
	MP39760		X									5	1	X					X					
	MP41000		X									6		X		X			X					
	MP41010		X									7		X		X			X					
	MP41070		X								6			X					X					
	MP41080		X									6	1	X		X			X					
MP41090		X									6			X		X			X					

IGNITION SWITCHES

Sierra offers the most complete selection of high quality polyester and brass ignition switches for the marine industry.

Marine grade glass-filled polyester switches

- Maximum corrosion protection – eliminates oxidation
- Inner seal between cylinder lock and contact plate
- Non-conductive housing eliminates potential shorts
- 20 Amp rating
- 2, 3 and 4 position switches
- Switches for magneto and conventional ignitions

Brass ignition switches

- Corrosion resistant construction
- Up to 15 Amp rating
- 2, 3 and 4 position switches
- Switches for magneto and conventional ignitions

4 POSITION CONVENTIONAL – ACCESSORY – OFF – RUN – START



MP39700 – CLAMSHELL
MP39702-1 – BULK 100 PCS

DESCRIPTION	
Material	Polyester
Length	Long: 1 1/8" maximum panel thickness
Terminal Type	4 Color Code Wires
Back Up Nut	Brass
Face Nut	Knurled black plastic w/rubber cap
Hole Size	7/8"
Rated;	
Ignition	15 Amp @ 12 VDV
Solenoid	30 Amp @ 12 VDC
Accessory	15 Amp @ 12 VDC



MP39800 – CLAMSHELL
MP39802 – BULK 100 PCS/CTN

DESCRIPTION	
Material	Polyester
Length	Long: 1 1/8" maximum panel thickness
Terminal Type	4 Blade
Back Up Nut	Brass
Face Nut	Hex black plastic face nut
Hole Size	7/8"
Rated;	
Ignition	15 Amp @ 12v DC
Solenoid	30 Amp @ 12v DC
Accessory	15 Amp @ 12v DC



MP41040 – CLAMSHELL
MP41042 – BULK 100 PCS/CTN

DESCRIPTION	
Material	Polyester
Length	Long: 1 1/8" maximum panel thickness
Terminal Type	4 Screw Tab
Back Up Nut	Brass
Face Nut	Knurled black plastic w/rubber cap
Hole Size	7/8"
Rated;	
Ignition	15 Amp @ 12v DC
Solenoid	30 Amp @ 12v DC
Accessory	15 Amp @ 12v DC

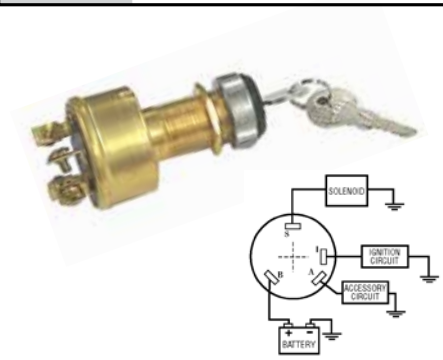

MP39070 – CLAMSHELL
MP39072 – BULK 100 PCS/CTN

DESCRIPTION	
Material	Brass
Length	Long: 1" maximum panel thickness
Terminal Type	4 Screw Tab
Back Up Nut	Brass
Face Nut	Knurled black chrome w/rubber cap
Hole Size	7/8"
Rated;	
Ignition	15 Amp @ 12v DC
Solenoid	30 Amp @ 12v DC
Accessory	15 Amp @ 12 VDC

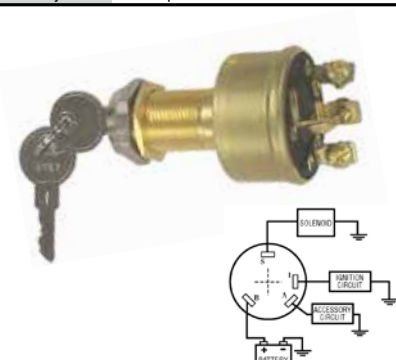

MP41020 – CLAMSHELL
MP41022 – BULK 100 PCS/CTN

DESCRIPTION	
Material	Brass
Length	Long: 1" maximum panel thickness
Terminal Type	4 Screw Tab
Back Up Nut	Brass
Face Nut	Hex Chrome Face Nut
Hole Size	7/8"
Rated;	
Ignition	15 Amp @ 12v DC
Solenoid	30 Amp @ 12v DC
Accessory	15 Amp @ 12 VDC

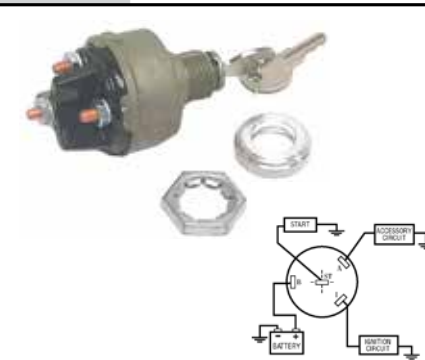

UN12140 – CLAMSHELL
UN12142 – BULK 100 PCS/CTN

DESCRIPTION	
Material	Die Cast Zinc
Length	Short: 5/8" maximum panel thickness
Terminal Type	4-Threaded stud
Back Up Nut	Die Cast Zinc
Face Nut	Knurled Chrome Face Nut
Hole Size	9/16"
Rated;	
Ignition	15 Amp @ 12v DC
Solenoid	30 Amp @ 12v DC
Accessory	15 Amp @ 12v DC

Wire color codes

- Red - Battery
- Black - Magneto Ground
- Yellow w/ Red Stripe - Solenoid
- Black w/ yellow stripe - Magneto
- Purple - Ignition
- Yellow w/Black Stripe - Choke
- Purple w/ white stripe - Accessory

3 POSITION CONVENTIONAL – OFF – RUN – START

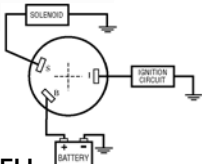

MP39060-1 – CLAMSHELL
MP39062-1 – BULK 100 PCS/CTN

DESCRIPTION	
Material	Brass
Length	Long: 1 1/8" maximum panel thickness
Terminal Type	3 Screw Tab
Back Up Nut	Brass
Face Nut	Hex Chrome Face Nut
Hole Size	7/8"
Rated;	
Ignition	15 Amp @ 12v DC
Solenoid	30 Amp @ 12v DC

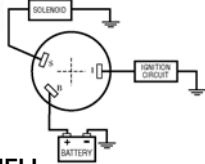

MP39080-1 – CLAMSHELL
MP39082-1 – BULK 100 PCS/CTN

DESCRIPTION	
Material	Brass
Length	Long: 1 1/8" maximum panel thickness
Terminal Type	3 Screw Tab
Back Up Nut	Brass
Face Nut	Knurled black plastic w/rubber cap
Hole Size	7/8"
Rated;	
Ignition	15 Amp @ 12v DC
Solenoid	30 Amp @ 12v DC

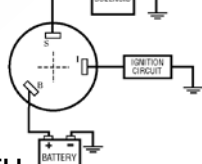

MP39120 – CLAMSHELL
MP39122 – BULK 100 PCS/CTN

DESCRIPTION	
Material	Polyester
Length	Long: 1 1/8" maximum panel thickness
Terminal Type	3 Screw Tab
Back Up Nut	Brass
Face Nut	Hex black plastic face nut
Hole Size	7/8"
Rated;	
Ignition	15 Amp @ 12v DC
Solenoid	30 Amp @ 12v DC

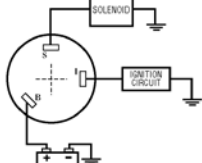

MP39780 – CLAMSHELL
MP39782 – BULK 100 PCS/CTN

DESCRIPTION	
Material	Polyester
Length	Short: 5/8" maximum panel thickness
Terminal Type	3 Screw Tab
Back Up Nut	Brass
Face Nut	Hex black plastic face nut
Hole Size	7/8"
Rated;	
Ignition	15 Amp @ 12v DC
Solenoid	30 Amp @ 12v DC

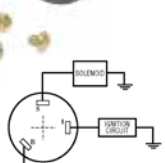

MP39200 – CLAMSHELL
MP39202 – BULK 100 PCS/CTN

DESCRIPTION	
Material	Polyester
Length	Long: 1 1/8" maximum panel thickness
Terminal Type	3 Screw Tab
Back Up Nut	Brass
Face Nut	Knurled black plastic w/rubber cap
Hole Size	7/8"
Rated;	
Ignition	15 Amp @ 12v DC
Solenoid	30 Amp @ 12v DC

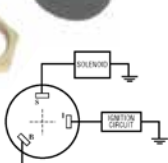

MP39770 – CLAMSHELL
MP39772 – BULK 100 PCS/CTN

DESCRIPTION	
Material	Polyester
Length	Long: 1 1/8" maximum panel thickness
Terminal Type	3 Blade
Back Up Nut	Brass
Face Nut	Knurled black plastic w/rubber cap
Hole Size	7/8"
Rated;	
Ignition	15 Amp @ 12v DC
Solenoid	30 Amp @ 12v DC

2 POSITION CONVENTIONAL – OFF-ON- USE WITH SEPARATE STARTER BUTTON

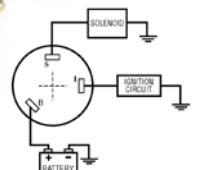

MP41030 – CLAMSHELL
MP41032 – BULK 100 PCS/CTN

DESCRIPTION	
Material	Polyester
Length	Short: 1 1/8" maximum panel thickness
Terminal Type	3 Screw Tab
Back Up Nut	Brass
Face Nut	Knurled black plastic w/rubber cap
Hole Size	7/8"
Rated;	
Ignition	15 Amp @ 12v DC
Solenoid	30 Amp @ 12v DC

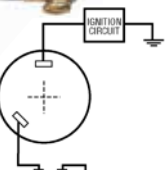

MP39010 - CLAMSHELL
MP39012 - BULK 100 PCS/ CTN

Description	
Material	Brass
Length	Short: 5/8" maximum panel thickness
Terminal Type	2 Screw Tab
Back Up Nut	Brass
Face Nut	Hex Chrome Face Nut
Hole Size	3/4"
Rated;	
Ignition	5 Amp @ 12 VDV

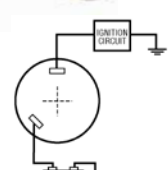

MP39020 – CLAMSHELL
MP39022 – BULK 100 PCS/CTN

DESCRIPTION	
Material	Brass
Length	Long: 1 1/8" maximum panel thickness
Terminal Type	2 Screw Terminal
Back Up Nut	Brass
Face Nut	Hex Chrome Face Nut
Hole Size	7/8"
Rated;	
Ignition	15 Amp @ 12v DC

2 POSITION CONVENTIONAL – OFF – ON – USE WITH SEPARATE STARTER BUTTON

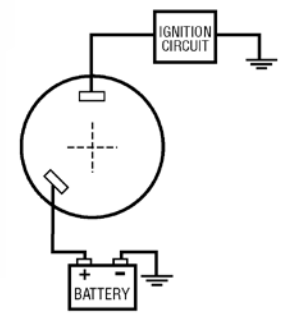

MP39820-1 – INDIVIDUAL BOX
MP39822-1 – BULK 100 PCS/CTN

DESCRIPTION	
Material	Brass
Length	Long: 1 1/8" maximum panel thickness
Terminal Type	2 Screw Terminal
Back Up Nut	Brass
Face Nut	Knurled Chrome Plated w/rubber cap
Hole Size	7/8"
Rated;	
Ignition	15 Amp @ 12v DC

4 POSITION MAGNETO – ACCESSORY – OFF – RUN – START

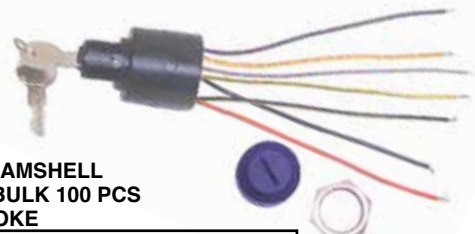

MP39710 - CLAMSHELL
MP39712-1 - BULK 100 PCS
PUSH TO CHOKE

DESCRIPTION	
Material	Polyester
Length	Short: 5/8" maximum panel thickness
Terminal Type	7 Color Code Wires
Back Up Nut	Brass
Face Nut	Knurled black plastic w/rubber cap
Hole Size	7/8"
Rated;	
Ignition	15 Amp @ 12 VDV
Solenoid	30 Amp @ 12 VDC
Accessory	15 Amp @ 12 VDC
Choke	7 Amp @ 12 VDC

For Outboard engines without choke circuit

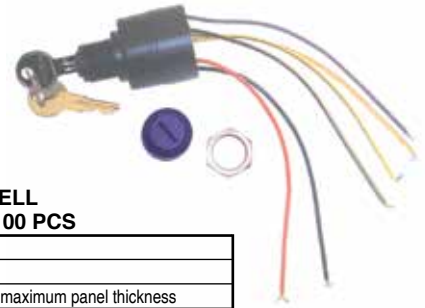

MP39720 - CLAMSHELL
MP39722-1 - BULK 100 PCS

DESCRIPTION	
Material	Polyester
Length	Short: 5/8" maximum panel thickness
Terminal Type	6 Color Code Wires
Back Up Nut	Brass
Face Nut	Knurled black plastic w/rubber cap
Hole Size	7/8"
Rated;	
Ignition	15 Amp @ 12 VDV
Solenoid	30 Amp @ 12 VDC
Accessory	15 Amp @ 12 VDC



MP41010 – CLAMSHELL
MP41012 – BULK 100 PCS/ CTN
PUSH TO CHOKE

DESCRIPTION	
Material	Polyester
Length	Short: 5/8" maximum panel thickness
Terminal Type	7 Screw Tab
Back Up Nut	Brass
Face Nut	Hex black plastic face nut
Hole Size	7/8"
Rated;	
Ignition	15 Amp @ 12v DC
Solenoid	30 Amp @ 12v DC
Choke	7 Amp @ 12v DC
Accessory	15 Amp @ 12v DC



MP41080 – CLAMSHELL
MP41082 – BULK 100 PCS/CTN
PUSH TO CHOKE

DESCRIPTION	
Material	Polyester
Length	Short: 5/8" maximum panel thickness
Terminal Type	6 Screw Tab, 1 Boss Screw
Back Up Nut	Plastic
Face Nut	Hex black plastic face nut
Hole Size	7/8"
Rated;	
Ignition	15 Amp @ 12v DC
Solenoid	30 Amp @ 12v DC
Choke	7 Amp @ 12v DC
Accessory	15 Amp @ 12v DC



MP39730 - CLAMSHELL
MP39732 - BULK 100 PCS

DESCRIPTION	
Material	Polyester
Length	Short: 5/8" maximum panel thickness
Terminal Type	6 tinned brass screw terminals
Back Up Nut	Brass
Face Nut	Knurled black plastic w/rubber cap
Hole Size	7/8"
Rated;	
Ignition	15 Amp @ 12 VDV
Solenoid	30 Amp @ 12 VDC
Accessory	15 Amp @ 12 VDC

Wire color codes

Red - Battery
 Black - Magneto Ground

Yellow w/ Red Stripe - Solenoid
 Black w/ yellow stripe - Magneto

Purple - Ignition
 Yellow w/Black Stripe - Choke

Purple w/ white stripe - Accessory

3 POSITION MAGNETO – OFF – RUN – START

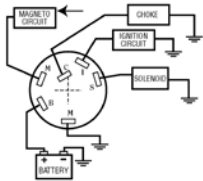

MP39760 – CLAMSHELL
MP39762 – BULK 100 PCS/CTN
PUSH TO CHOKE

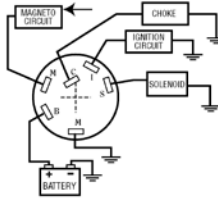

MP41000 – CLAMSHELL
MP41002 – BULK 100 PCS/CTN
PUSH TO CHOKE

For Outboard engines without choke circuit



MP39740-1 - CLAMSHELL
MP39742-1 - BULK 100 PCS

DESCRIPTION		DESCRIPTION		DESCRIPTION	
Material	Polyester	Material	Polyester	Material	Polyester
Length	Short: 5/8" maximum panel thickness	Length	Short: 5/8" maximum panel thickness	Length	Short: 5/8" maximum panel thickness
Terminal Type	5 Screw Tab, 1 Boss Screw	Terminal Type	6 Screw Tab	Terminal Type	5 Color Code Wires
Back Up Nut	Plastic	Back Up Nut	Brass	Back Up Nut	Plastic
Face Nut	Hex black plastic face nut	Face Nut	Hex black plastic face nut	Face Nut	Knurled black plastic w/rubber cap
Hole Size	7/8"	Hole Size	7/8"	Hole Size	7/8"
Rated;		Rated;		Rated;	
Ignition	15 Amp @ 12v DC	Ignition	15 Amp @ 12v DC	Ignition	15 Amp @ 12 VDV
Solenoid	30 Amp @ 12v DC	Solenoid	30 Amp @ 12v DC	Solenoid	30 Amp @ 12 VDC
Choke	7 Amp @ 12v DC	Choke	7 Amp @ 12v DC	Accessory	15 Amp @ 12 VDC



MP41070-2 – CLAMSHELL
MP41072-2 – BULK 100 PCS/CTN
PUSH TO CHOKE / MERCURY
CONTROL BOX APPLICATIONS
 (Colors on switch wires match factory color codes.)

DESCRIPTION	
Material	Polyester
Length	Short: 5/8" maximum panel thickness
Terminal Type	6 Color Coded Wire Leads/Potted
Back Up Nut	Not Required
Face Nut	Hex black plastic face nut
Hole Size	7/8"
Rated;	
Ignition	15 Amp @ 12v DC
Solenoid	30 Amp @ 12v DC
Choke	7 Amp @ 12v DC



MP41090 – CLAMSHELL
PUSH TO CHOKE
 (Colors on switch wires match factory color codes.)

DESCRIPTION	
Material	Polyester
Length	Short: 5/8" maximum panel thickness
Terminal Type	6 Color Coded Wires
Back Up Nut	Brass
Face Nut	Knurled black plastic w/rubber cap
Hole Size	7/8"
Rated;	
Ignition	15 Amp @ 12v DC
Solenoid	30 Amp @ 12v DC
Choke	7 Amp @ 12v DC

Wire color codes

Red - Battery
 Black - Magneto Ground

Yellow w/ Red Stripe - Solenoid
 Black w/ yellow stripe - Magneto

Purple - Ignition
 Yellow w/Black Stripe - Choke

Purple w/ white stripe - Accessory



**MP51090 - CLAMSHELL
MP51092 - BULK 100 PCS
PUSH TO CHOKE**

DESCRIPTION	
Material:	Polyester
Length:	Short 5/8" maximum panel thickness
Terminal Type:	6 Color Coded Wire Leads/Potted
Back up Nut:	Not Required
Face Nut:	Hex black plastic face nut
Hole Size:	7/8"
Rated;	
Ignition	15 Amp @ 12v DC
Solenoid	30 Amp @ 12v DC
Choke	7 Amp @ 12v DC



**MP52000 - CLAMSHELL
MP52002 - BULK 100 PCS
PUSH TO CHOKE**

DESCRIPTION	
Material:	Polyester
Length:	Short 5/8" maximum panel thickness
Terminal Type:	6 Color Coded Wire Leads/Potted
Back up Nut:	Plastic
Face Nut:	Hex black plastic face nut
Hole Size:	7/8"
Rated;	
Ignition	15 Amp @ 12v DC
Solenoid	30 Amp @ 12v DC
Choke	7 Amp @ 12v DC



**MP39090 - CLAMSHELL
MP39092 - BULK 100 PCS/CTN
PUSH TO CHOKE**

DESCRIPTION	
Material	Polyester
Length	Long: 1 1/8" maximum panel thickness
Terminal Type	6 Screw Tab
Back Up Nut	Anodized steel
Face Nut	Hex plastic face nut w/snap on rubber cap
Hole Size	7/8"
Rated;	
Ignition	15 Amp @ 12v DC
Solenoid	30 Amp @ 12v DC
Choke	7 Amp @ 12v DC

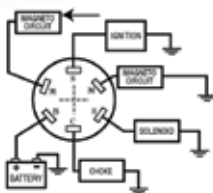

**MP39040 - CLAMSHELL
MP39042 - BULK 100 PCS/CTN**

DESCRIPTION	
Material	Brass
Length	Long: 1 1/8" maximum panel thickness
Terminal Type	5 Screw Tab
Back Up Nut	Brass
Face Nut	Hex Chrome Face Nut
Hole Size	7/8"
Rated;	
Ignition	10 Amp @ 12v DC
Solenoid	30 Amp @ 12v DC

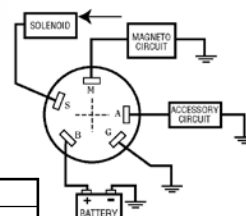

**MP39100 - CLAMSHELL
MP39102 - BULK 100 PCS/CTN**

DESCRIPTION	
Material	Polyester
Length	Long: 1 1/8" maximum panel thickness
Terminal Type	5 Screw Tab
Back Up Nut	Brass
Face Nut	Hex black plastic face nut
Hole Size	7/8"
Rated;	
Ignition	15 Amp @ 12v DC
Solenoid	30 Amp @ 12v DC

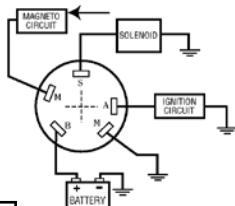

**MP39830 - CLAMSHELL
MP39832 - BULK 100 PCS/CTN**

DESCRIPTION	
Material	Polyester
Length	Long: 1 1/8" maximum panel thickness
Terminal Type	6 Screw Tab
Back Up Nut	Brass
Face Nut	Hex black plastic face nut
Hole Size	7/8"
Rated;	
Ignition	15 Amp @ 12v DC
Solenoid	30 Amp @ 12v DC
Choke*	7 Amp @ 12v DC



*Terminal to power separately controlled choke circuit

Wire color codes

Red - Battery
Black - Magneto Ground

Yellow w/ Red Stripe - Solenoid
Black w/ yellow stripe - Magneto

Purple - Ignition
Yellow w/Black Stripe - Choke

Purple w/ white stripe - Accessory

EMERGENCY ENGINE CUT-OFF SWITCHES

- Kills ignition when lanyard is pulled
- For use with conventional or magneto ignitions
- Unique design of MP40960 and MP40970 keeps plunger down when lanyard connected
- Seals out moisture
- Makes reconnection easier



NEW



MP28850
 Universal Cut-Off Switch Lanyard
 Replaces: Honda, Mercury, Mariner, BRP, Yamaha, Suzuki, OMC

MP28860
 Ignition Lanyard.
 Replaces: Yamaha 682-82556-00-00



MP28890
 Ignition Lanyard.
 Replaces: OMC 176288
 1996 and Newer



MP40950
 Emergency cut-off switch.



MP28880*
 Lanyard Replaces: OMC 432230.
 1995-Older



MP40960*
 Emergency cut-off switch with straight lanyard.



MP40970-1*
 Emergency cut-off switch with coiled lanyard.



MP40980*
 Spare lanyard for #MP40960.

MP40962
 "Bulk"- 100 pieces per carton
 Will provide a "normally open" or "normally closed" circuit.

MP40972-1
 "Bulk"- 100 pieces per carton
 Will provide a "normally open" or "normally closed" circuit.

MP40982
 "Bulk"- 100 pieces per carton



MP40990*
 Spare lanyard for #MP40970-1.



MP28870*
 Switch and lanyard Replaces: OMC 585134.



18-1282
 Lanyard & Clip.
 Replaces: OMC 398602
 Tiller Steer Models - ALL

MP40992
 "Bulk"- 100 pieces per carton

FACE AND BOOT NUTS



MP39190
WEATHER PROOF BOOT NUT
 Fits: All Sierra polyester ignition switches, 1996 & later. 13/16"-16 Thread. Rotating rubber seal. Seals out moisture and dust from lock cylinder



MP39270
FACENUT
 For polyester ignition switches MP39100 thru MP39120. Nut has extra long threads for positive engagement on mounting bushing for early (Pre-1995) style with 13/16"-20 thread ONLY!

* Clamshell

All switches are rated 20 Amp @ 12 Volts

	Style	Off-On Single Pole	Off-MOM On Single Pole	ON-OFF-ON Single Pole	ON-OFF-MOM ON Single Pole	MOM ON-OFF-MOM ON Single Pole	ON(#1)-OFF-ON(#1 & #2) Single Pole	ON-ON Single Pole	ON-OFF-ON Double Pole	MOM ON-OFF-MOM ON Double Pole	ON-OFF-MOM ON Double Pole	ON(#1)-OFF-ON(#1 & #2) Double Pole	OFF-ON (1 & 2) Double Pole	MOM OFF-ON (1 & 2) Double Pole
	ROTSWITCH	MP78710	MP78720	MP78730		MP78740	MP78820 & MP78830		MP78800					
	Standard Rocker	RK40140 RK40140W	RK40150 RK40150W	RK40170 RK40170W	RK40360	RK40350			RK40480	RK40470		RK19570		
	Weather Resistant Illuminated Std. Rocker	RK19500K RK19530K RK19510K RK19500A^ RK19530A^	RK19510A^	RK19520K	RK19520A^			RK19580K						
	Illuminated Std. Rocker	RK40100	RK40120	RK40110		RK40130								
	Illuminated Soft Spot Rocker	RK40370	RK40380	RK40390		RK40400								
	Weather Resistant Contura® II	RK19400-1	RK19410-1 RK19410RED	RK19420-1	RK19920-1	RK19430-1			RK19490-1	RK19480-1	RK19930-1		RK19560-1	RK19940-1
	Weather Resistant Illuminated Contura®	RK19440-1	RK19450-1	RK19460-1					RK19540-1	RK19550-1				
	Weather Resistant Contura® III Black & Gray	RK19680TP	RK19710TP			RK19750TP RK19790				RK19850TP				RK19870TP
	Weather Resistant Contura® III Black	RK19680	RK19720	RK19690		RK19760 RK19800				RK19860				RK19880
	Illuminated Contura® III Black & Gray	RK19700TP		RK19730TP	RK19770TP				RK19830TP	RK19810TP			RK19890TP	
	Weather Resistant Illuminated Contura® III Black	RK19700		RK19740	RK19780				RK19840	RK19820			RK19910	
	Standard Toggle	TG40020-1	TG40030-1	TG40040-1	TG40160-1	TG40050-1			TG40450-1	TG40460-1			TG40490	
	Weather Resistant Illuminated Std. Toggle			TG40010										
	Illuminated Std. Toggle	TG40060	TG40080	TG40070		TG40090								
	Tip Lit Toggle	TG40300	TG40310	TG40320	TG40340	TG40330			TG19520	TG19530				
	Heavy Duty 25 Amp Toggle	TG22000	TG22030	TG22010		TG22040			TG22020					
	Weather Resistant Toggle w/ Boot Nut	TG19560	TG19540	TG19550										

^ Letter designates lense color A=Amber, C=Clear, G=Green, R=Red, K=Kit containing all 4 colors

RotoSwitch® provides illumination with different colors providing immediate visual information of switch position.



RotoSwitch® Rotary Switches

- Unique ergonomic design, styling and performance in one design
- 20 AMP @ 12 Volts DC
- Durable cam design for long life
- UV stabilized thermoplastic housing
- Knob acts as umbrella - Silicone lip seal mates with stalk
- Separate light modules optional
- Replaces toggle or rocker switches with minimal panel alterations

RotoSwitch® offers unique styling and performance in one design.

	BULK ^① NUMBER	CLAMSHELL NUMBER	NUMBER OF BATTERY FEEDS	CIRCUITS "ON"			
				45° COUNTER CLOCKWISE	12 O'CLOCK	45° CLOCKWISE	90° CLOCKWISE
	MP78712 *MP59012	MP78710	1	—	OFF	#	—
	MP78722	MP78720	1	—	OFF	#1 (M)	—
	MP78732 *MP59032	MP78730	1	#1	OFF	#2	—
	MP59042	MP78740	1	#1 (M)	OFF	#2 (M)	—
	MP78802 *MP59102	MP78800	2	#1	OFF	#2	—
	MP78822 *MP59122	MP78820	1	#2	OFF	#1&2	—
	*MP59132	MP78830	1	—	OFF	#2	#1&2
	*MP59162	MP78860	1	OFF	#1	#2	#1&2

① Bulk - 100 pieces per carton. * Switch Only - No Knob (M)=MOMENTARY

Replacement Knobs. All include rubber umbrella seal. Original Ergotech design knob.

				<p>Mounting Accessories for RotoSwitch®.</p> <p>**MP78960 *MP78962 Anti-rotation collar. Use when installing non-illuminated RotoSwitches in very thin dash panels. This adapter prevents the switch from "slipping" if excessive force is used to actuate the switch.</p>
<p>**MP79730 *MP79732 Tan knob with light tube. Use with illumination module.</p>	<p>**MP79740 *MP79742 Black knob with black indicator.</p>	<p>**MP79760 *MP79762 Black knob with light tube. Use with illumination module.</p>	<p>*MP78372 Black knob with light tube for use with light module.</p>	

Illumination Module. Add flexibility and function to any installation of RotoSwitch® rotary switches. By using a variety of colored lenses, the status of each switch – "Off", "On-1", "On-2" – can instantly be determined.

<p>**MP78870 *MP78872</p>	<p>**MP78880 *MP78882</p>	<p>**MP78910 *MP78912</p>	<p>*MP78942 ①</p>	<p>**MP78950 *MP78952</p>

① Bulk - 100 pieces per carton ** Clamshell

Standard Weather Resistant Contura® V Rocker Switches



- Non-corrosive plastic construction
 - Protects against dust and prolonged spray to IP66 and IP68 standards
 - Meets UL 1500, ISO 8846 ignition protection requirements
 - Supplied with neoprene mounting gasket
 - Removable actuators
 - Brass blade terminals, silver contacts
- Rated: 20 amps @12 VDC

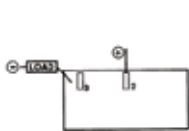

NEW

RK19210
ON-OFF SPST

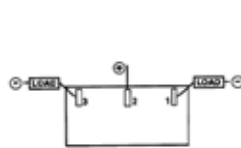

NEW

RK19220
ON-OFF-ON SPDT

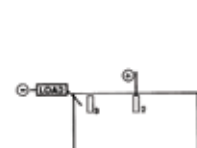

NEW

RK19230
MOM ON-OFF SPST

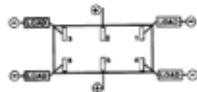

NEW

RK19240
MOM ON-OFF-MOM ON
DPDT

RK22180
ACTUATOR, BLACK
CONTURA V (2EA)

NEW

Illuminated Weather Resistant Contura® V Rocker Switches



- Non-corrosive plastic construction
 - Protects against dust and prolonged spray to IP66 and IP68 standards
 - Meets UL 1500, ISO 8846 ignition protection requirements
 - Supplied with neoprene mounting gasket
 - Illuminates red in "ON" position
 - Removable actuators
 - Brass blade terminals, silver contacts
- Rated: 20 amps @12 VDC

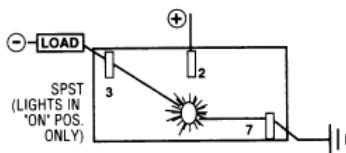

NEW

RK19310
ON-OFF SPST

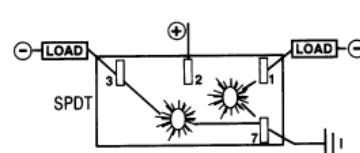

NEW

RK19320
ON-OFF-ON SPDT

RK22190
ACTUATOR, BLACK CONTURA V
WITH LENS (2EA)

NEW

RK22200
ACTUATOR, BLACK CONTURA V
WITH 2 LENS (2EA)

NEW



RK22290
ACTUATOR REMOVAL TOOL

NEW

Standard Weather Resistant Contura® III Rocker Switches



- Non-corrosive plastic construction
 - Protects against dust and prolonged spray to IP66 and IP68 standards
 - Meets UL 1500, ISO 8846 ignition protection requirements
 - Supplied with neoprene mounting gasket
 - Removable actuators
 - Brass blade terminals, silver contacts
- Rated: 20 amps @12 VDC



ON-OFF SPST

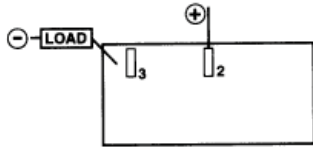

GRAY
RK19680TP

BLACK
RK19680
RK19680TP

ON-OFF-ON SPDT

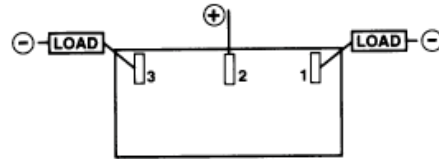

GRAY
RK19690TP

BLACK
RK19690
RK19690TP

MOM ON-OFF SPST

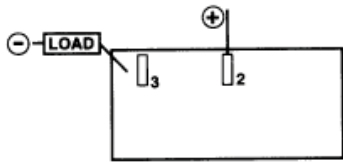

BLACK
**RK19720

TWO PADDLES (ONE GRAY, ONE BLACK)
RK19710TP

MOM ON-OFF-MOM ON SPDT

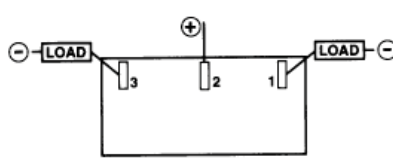

BLACK
**RK19760

TWO PADDLES (ONE GRAY, ONE BLACK)
RK19750TP

**MOM ON-OFF-MOM ON SPDT
BRIGHT/DIM**

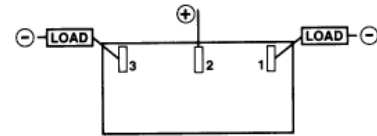

BLACK
**RK19800

MOM ON-OFF-MOM ON DPDT

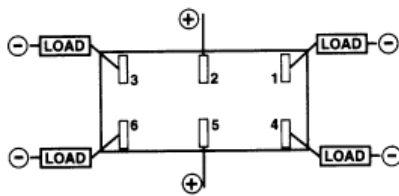

BLACK
**RK19860

TWO PADDLES
(ONE GRAY, ONE BLACK)
RK19850TP

MOM ON-OFF DPST

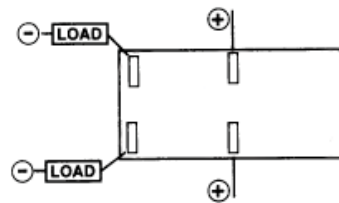

BLACK
**RK19880

TWO PADDLES
(ONE GRAY, ONE BLACK)
RK19870TP



RK22100
ACTUATOR, BLACK CONTURA III
(2EA)



RK22110
ACTUATOR, GRAY CONTURA III
(2EA)

** Clamshell

Illuminated Weather Resistant Contura® III Rocker Switches



- Non-corrosive plastic construction
 - Protects against dust and prolonged spray to IP66 and IP68 standards
 - Meets UL 1500, ISO 8846 ignition protection requirements
 - Supplied with neoprene mounting gasket
 - Illuminates red in "ON" position
 - Removable actuators
 - Brass blade terminals, silver contacts
- Rated: 20 amps @12 VDC



<p style="text-align: center;">OFF-ON SPST</p> <p style="text-align: center;">BLACK **RK19700</p> <p style="text-align: center;">TWO PADDLES (ONE GRAY, ONE BLACK) RK19700TP</p>	<p style="text-align: center;">MOM ON-OFF-ON SPDT</p> <p style="text-align: center;">BLACK **RK19780</p> <p style="text-align: center;">TWO PADDLES (ONE GRAY, ONE BLACK) RK19770TP</p>	<p style="text-align: center;">MOM ON-OFF-ON DPDT</p> <p style="text-align: center;">BLACK **RK19820</p> <p style="text-align: center;">TWO PADDLES (ONE GRAY, ONE BLACK) RK19810TP</p>
<p style="text-align: center;">OFF-ON DPST</p> <p style="text-align: center;">BLACK **RK19910</p> <p style="text-align: center;">TWO PADDLES (ONE GRAY, ONE BLACK) RK19890TP</p>	<p style="text-align: center;">ON-OFF-ON SPDT</p> <p style="text-align: center;">BLACK **RK19740</p> <p style="text-align: center;">TWO PADDLES (ONE GRAY, ONE BLACK) RK19730TP</p>	<p style="text-align: center;">ON-OFF-ON DPDT</p> <p style="text-align: center;">BLACK **RK19840</p> <p style="text-align: center;">TWO PADDLES (ONE GRAY, ONE BLACK) RK19830TP</p>
<p style="text-align: center;">NEW</p> <p style="text-align: center;">RK22120 ACTUATOR, BLACK CONTURA III WITH LENS (2EA)</p>	<p style="text-align: center;">NEW</p> <p style="text-align: center;">RK22130 ACTUATOR, GRAY CONTURA III WITH LENS (2EA)</p>	
<p style="text-align: center;">NEW</p> <p style="text-align: center;">RK22140 ACTUATOR, BLACK CONTURA III W/2 LENS (2EA)</p>	<p style="text-align: center;">NEW</p> <p style="text-align: center;">RK22150 ACTUATOR, GRAY CONTURA III W/2 LENS (2EA)</p>	

** Clamshell



Standard Weather Resistant Contura® II Rocker Switches

- Protects against dust and prolonged spray to IP66 and IP68 standards
 - Supplied with neoprene mounting gasket
 - Removable actuators
 - Brass blade terminals, silver contacts
- Rated: 20 amps @12 VDC

<p>**RK19400-1 OFF-ON SPST</p>	<p>**RK19410-1 OFF-MOM ON SPST</p>	<p>**RK19410-RED OFF-MOM ON SPST Red actuator - for horn</p>	<p>**RK19420-1 ON-OFF-ON SPDT</p>	<p>**RK19560-1 OFF-ON DPST Switch activates 2 circuits</p>
<p>**RK19920-1 Mom On-Off-On SPDT</p>	<p>**RK19930-1 Mom On-Off-On DPDT</p>	<p>**RK19940-1 Off-Mom On DPST</p>	<p>**RK19430-1 Mom On-Off-Mom On SPDT</p>	
<p>**RK19480-1 Mom On-Off-Mom On DPDT</p>	<p>**RK19490-1 On-Off-On DPDT</p>	<p>RK22160 ACTUATOR, BLACK CONTURA II (2EA)</p>	<p>RK22170 ACTUATOR, RED CONTURA II (2EA)</p>	



Illuminated Weather Resistant Contura® II Rocker Switches

- Non-corrosive plastic construction
 - Removable actuators
 - Brass blade terminals, silver contacts
- Rated: 20 amps @12 VDC

<p>**RK19440-1 Off-On SPST</p>	<p>**RK19450-1 Mom On - Off SPST</p>	<p>**RK19460-1 On-Off-On SPDT</p>	<p>**RK19540-1 On-Off-On DPDT</p>	<p>**RK19550-1 Mom On-Off-Mom On DPDT</p>
---	---	--	--	--



Standard Rocker Switches - with Black Actuators

- Non-corrosive plastic construction
 - Black actuators w/ black face plate
 - Silver contacts
 - Brass blade terminals
- Rated: 20 amps @ 12 VDC

<p>**RK40140 *RK40142 On-Off SPST</p>	<p>**RK40150 *RK40152 Mom On - Off SPST</p>	<p>**RK40170 *RK40172 On-Off-On SPDT</p>	<p>**RK40350 *RK40352 Mom On-Off-Mom On SPDT</p>
<p>**RK40470 *RK40472 Mom On-Off-Mom On DPDT</p>	<p>**RK40480 *RK40482 On-Off-On DPDT</p>	<p>**RK40360 *RK40362 On-Off-Mom On SPDT</p>	<p>**RK19570 *RK19572 On(1)-Off-On(1&2) DPDT</p>

*BULK - 100 pcs. per carton



**CLAMSHELL



Standard Rocker Switches - with White Actuators

- Non-corrosive plastic construction
- White actuators w/ black face plate
- Silver contacts
- Brass blade terminals

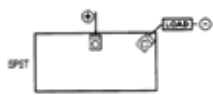
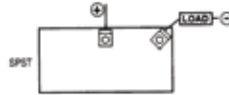
Rated: 20 amps @ 12 VDC

 <p>**RK40140W *RK40142W OFF-ON SPST</p>	 <p>**RK40150W *RK40152W OFF-MOM ON SPST</p>	 <p>**RK40170W *RK40172W ON-OFF-ON SPDT</p>
---	---	--



Illuminated Rocker Switches

- Dependent pilot light - illuminates in "on" position
- Non-corrosive plastic construction
- Silver contacts
- Brass blade terminals

Rated: 20 amps @ 12 VDC

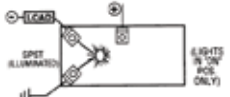
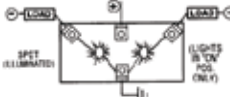
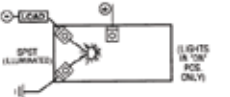
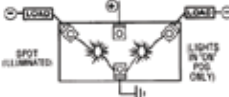
 <p>**RK40100 *RK40102 On-Off SPST</p>	 <p>**RK40110 *RK40112 On-Off-On SPDT</p>	 <p>**RK40120 *RK40122 Mom On - Off SPST</p>	 <p>**RK40130 *RK40132 Mom On-Off-Mom On SPDT</p>
---	--	--	--



Illuminated Rocker Switches - Soft Spot Light

- Independent pilot light - illuminates when panel lights ON
- Illuminates white when panel lights are ON, changes to red when switch is ON
- Soft spotlight helps preserve night vision
- Non-corrosive plastic construction
- Silver contacts
- Brass blade terminals

Rated: 20 amps @ 12 VDC

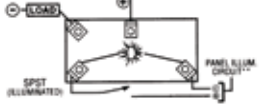
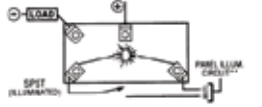
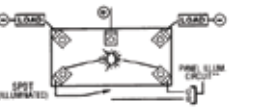
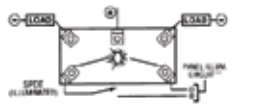

 <p>**RK40370 *RK40372 On-Off SPST</p>	 <p>**RK40380 *RK40382 Mom On - Off SPST</p>	 <p>**RK40390 *RK40392 On-Off-On SPDT</p>	 <p>**RK40400 *RK40402 Mom On-Off-Mom On SPDT</p>
---	---	---	--



Weather Resistant Illuminated Rocker Switches

- Certified to IP 66 and IP 68 - protected against dust, prolonged spray and submersion
- Supplied with neoprene mounting gasket
- Removable actuators
- Brass blade terminals, silver contacts
- Snap in lens of choice (Amber, Clear, Green Red)

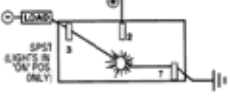
Rated: 20 amps @ 12 VDC

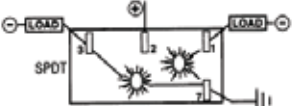
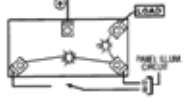
 <p>**RK19500K ROCKER SWITCH KIT OFF-ON SPST Dependent pilot light - illuminates in "on" position Includes 1 lens of each color</p>	 <p>**RK19510K ROCKER SWITCH KIT OFF-ON SPST Independent pilot light - illuminates when panel light is turned "on" Includes 1 lens of each color</p>	 <p>**RK19520K ROCKER SWITCH KIT ON-OFF-ON SPDT Dependent pilot lights - each light illuminates in "on" position Includes 2 lenses of each color</p>	 <p>**RK19530K ROCKER SWITCH KIT OFF-ON SPST One dependent pilot light - illuminates in "on" position. One independent pilot light - illuminates when panel lights "on" Includes 2 lenses of each color</p>
---	--	---	---

**BULK - 100 pcs. per carton **CLAMSHELL

Weather Resistant Illuminated Rocker Switches

ON-ON SPDT

*Dependent pilot lights - each light illuminates in "on" position

- Use to control circuit from 2 locations
- Certified to IP 66 and IP 68 - protected against dust, prolonged spray and submersion
- Supplied with neoprene mounting gasket
- Removable actuators
- Brass blade terminals, silver contacts
- Rated: 20 amps @ 12 VDC



****RK19580K**

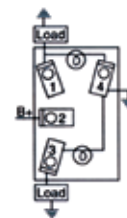

Snap in lens of choice
Kit includes 2 of each color
Amber Clear Green Red

Rocker Switch Mounting Brackets For Installing Two Or More Rocker Switches

- Fits Sierra Standard and Contura® Rocker Switches
- Sections snap together without tools
- Mounting hole for 2 end unit set - 2.02" (51.31 mm) wide x 1.90" (48.26 mm) high add 1.03" (26.16 mm) for additional sections



****UN19700**
Blank Cover



****UN19710**
1 Center section



****UN19720**
Two end sections



****UN19730**
2 Center sections



****UN19740**
1 End section



****UN19750**
Kit contains: 2 - **UN19740 End sections
1 - **UN19710 Center section
1 - **UN19700 Blank cover

Interior and RV Style Switches

Narrow Body Rocker Switches ON - OFF SPST

- For use in RK22070 panel
- Fits 7/16" X 1 1/4" cut out
- Blade Terminals
- 20 Amp @ 12 VDC



****RK21880** Non Illuminated
****RK21890** Glows Red in ON position

Narrow Body Rocker Switch ON - OFF SPST

- Fits .550" X 1.125" cut out
- Blade Terminals
- 10 Amp @ 12 VDC



****RK19640**
***RK19642**

Narrow Body Rocker Switch ON - OFF SPST

- Fits .550" x 1.125" cut out
- Blade Terminals
- 10 Amp @ 12 VDC
- Glows red in ON position



****RK19630**
***RK19632**

Surface Mount Illuminated Rocker Switches OFF-ON SPST

- Illuminates in ON position
- Mount in 1/2" round holes
- Brass blade terminals
- 16 Amp @ 12 VDC



****RK21420** Red
****RK21430** Green

Standard Toggle Switches



- Non-corrosive plastic construction
- Brass blade terminals, silver contacts
- 15/32" L x 15/32"-32 mounting stem
- Rated: 20 amps @ 12 VDC

<p>**TG40020-1 *TG4002252 ON-OFF SPST</p>	<p>**TG40030-1 *TG4003252 MOM ON-OFF SPST</p>	<p>**TG40040-1 *TG4004252 ON-OFF-ON SPDT</p>	<p>**TG40050-1 *TG4005252 MOM ON-OFF-MOM ON SPDT</p>
<p>**TG40160-1 *TG4016252 ON-OFF-MOM ON SPDT</p>	<p>**TG40450-1 *TG4045252 ON-OFF-ON DPDT</p>	<p>**TG40460-1 *TG4046252 MOM ON-OFF-MOM ON DPDT</p>	<p>**TG40490 *TG40492 ON(1)-OFF-ON(1&2) DPDT</p>

Illuminated Toggle Switches



- Non-corrosive plastic construction
- Illuminates white when panel lights are ON, changes to red when switch is ON
- Brass blade terminals, silver contacts
- 15/32" L x 15/32"-32 mounting stem
- Rated: 20 amps @ 12 VDC

<p>**TG40060 *TG40062 ON-OFF SPST</p>	<p>**TG40070 *TG40072 ON-OFF-ON SPDT</p>	<p>**TG40080 *TG40082 MOM ON-OFF SPST</p>	<p>**TG40090 *TG40092 MOM ON-OFF-MOM ON SPDT</p>
---	--	---	--

Tip Lit Toggle Switches



- Lights through tip of handle
- Non-corrosive plastic construction
- Illuminates white when panel lights are ON, changes to red when switch is ON
- Brass blade terminals, silver contacts
- 15/32" L x 15/32"-32 mounting stem
- Rated: 20 amps @ 12 VDC

<p>**TG40300 *TG40302 ON-OFF SPST</p>	<p>**TG40310 *TG40312 MOM ON-OFF SPST</p>	<p>**TG40320 *TG40322 ON-OFF-ON SPDT</p>	
<p>**TG40330 *TG40332 MOM ON-OFF-MOM ON SPDT</p>	<p>**TG40340 *TG40342 ON-OFF-MOM ON SPDT</p>	<p>**TG19520 *TG19522 ON-OFF-ON DPDT</p>	<p>**TG19530 *TG19532 MOM ON-OFF-MOM ON DPDT</p>

Weather Resistant Toggle Switch ON-OFF-ON SPDT



- Illuminates red in "on 1" position
- Illuminated white in "off" or "on 2" position
- O-ring seal in bushing seals out moisture and dirt
- Can be wired for independent or dependent illumination
- Rated: 20 amps @ 12 VDC

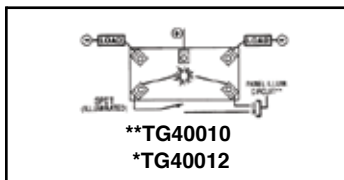

*BULK - 100 pcs. per carton **CLAMSHELL



Satin Chrome Tip Lit Toggle Switches

- Satin Chrome Handle with matching retaining ring
- Lights through tip of handle
- Non-corrosive plastic construction
- Illuminates white when panel lights are ON, changes to red when switch is ON
- Brass blade terminals, silver contacts
- 15/32" L X 13/32"-32 mounting stem
- Rated: 20 Amp @ 12 VDC

TG23000 Toggle Switch On-Off SPST	TG23010 Toggle Switch On-Off-On SPDT	TG23020 Toggle Switch On-Off-On DPDT	TG23030 Toggle Switch (On)-Off SPST	TG23040 Toggle Switch (On)-Off-(On) SPDT
---	--	--	---	--

Heavy Duty 25 Amp Toggle Switches



- Nickle Plated Brass Mounting Stem and Hardware
- Handle 11/16" (17.46mm) long
- Mounting Stem 15/32"-32 thread, 15/32" (11.81mm) long
- Fits panels up to 1/4" (6.35 mm) thick
- Rated : 25 A @ 12 VDC

 **TG22000 *TG22002 ON-OFF SPST	 **TG22010 *TG22012 ON-OFF-ON SPDT	 **TG22020 *TG22022 ON-OFF-ON DPDT	 **TG22030 *TG22032 MOM ON-OFF SPST	 **TG22040 *TG22042 MOM ON-OFF-MOM ON SPDT
---	--	--	---	--

Weather Resistant Toggle Switches

- Plasticized coating seals out moisture and dirt
- Nickel plated brass handle, mounting stem and hardware
- 10" L 16 gauge wire leads
- Handle 11/16" (17.46 mm) long
- Mounting stem 15/32"-32, 13/32" (10.31mm) long
- Fits panel up to 3/16" (4.76 mm) thick
- Includes MP39030 weather proof boot nut
- Rated: 15 amps @ 12 VDC

 **TG19560 *TG19562 OFF-ON SPST	 **TG19540 *TG19542 OFF-MOM ON SPST	 **TG19550 *TG19552 ON-OFF-ON SPDT
---	---	--

 **TG40000 *TG40002 ON-OFF SPST • Heavy duty all brass construction • Chrome plated bat handle • 3/8" L x 7/16"-28 mounting stem • 2 screw terminals Rated: 20 Amps @ 12 VDC	 **TG21020-1 *TG21022-1 ON-OFF SPST • Heavy duty die cast toggle switch • Chrome plated brass bat handle • 15/32" L x 15/32"-32 mounting stem • Sealed bushing • 2 screw terminals Rated: 35 Amps @ 12 VDC Rated: 20 Amps @ 125 VAC	 **TG21040 *TG21042 ON-OFF SPST • Heavy duty toggle switch • Chrome plated brass bat handle • 3/8" L x 15/32"-32 mounting stem • 2 screw terminals Rated: 35 Amps @ 12 VDC Rated: 20 Amps @ 125 VAC
---	--	---

 **TG21050-1 *TG21052-1 ON-OFF SPST • Heavy duty toggle switch • Chrome plated bat handle • 15/32" L x 15/32"-32 mounting stem • Two 6" wire leads Rated: 35 Amps @ 12 VDC Rated: 6 Amps @ 125 VAC	 **TG21070 *TG21072 ON-OFF SPST • Heavy duty toggle switch • Chrome plated brass bat handle • 15/32" L x 15/32"-32 mounting stem • 2 screw terminals Rated: 35 Amps @ 12 VDC Rated: 20 Amps @ 125 VAC	 **TG21080 *TG21082 ON-OFF-ON SPDT • Heavy duty toggle switch • Chrome plated brass bat handle • 3/8" L x 15/32"-32 mounting stem • 2 screw terminals Rated: 35 Amps @ 12 VDC Rated: 20 Amps @ 125 VAC
--	---	--

***BULK - 100 pcs. per carton **CLAMSHELL**

Heavy Duty 50 Amp Switches



- Super tough zinc die cast
 - Heavy copper screw terminals
 - Chrome plated plastic handle w/ metal core
 - 15/32" L x 15/32"-32 mounting stem
- Rated: 50 Amp @ 12 VDC

****TG21500**
***TG21502**
 ON-OFF SPST

****TG21590**
***TG21592**
 ON-OFF-ON SPST

****TG21600**
***TG21602**
 MOM ON-OFF-MOM ON SPDT

Duckbill Toggle Switches



- Non-corrosive plastic construction
 - Brass blade terminals
 - 1/2" mounting hole
 - Supplied with bezel nut and spacer ring
- Rated: 15 Amps @ 12 VDC



****TG21360**
***TG21362**
 ON-OFF SPST
 Glows Red in ON position

****TG21390**
***TG21392**
 ON-OFF SPST
 Glows Green in ON position

****TG21130**
***TG21132**
 ON-OFF SPST

****TG21140**
***TG21142**
 ON-OFF-ON SPDT

1" translucent plastic handle

1" black plastic handle



****MP39220**
***MP39222**
WEATHER PROOF BOOT NUT
 • For illuminated toggle switches (except Duckbill)
 • 1/2" boot seals out moisture yet allows illumination to show

****MP39030**
***MP39032**
WEATHER PROOF BOOT NUT
 (Gray)
 • For standard toggles w/ 15/32" mounting stem
 • Completely covers toggle handle
 • Seals out moisture & dirt
 • For toggle handles up to 1 1/4" long
 • Nickel plated brass nut



****MP39240**
***MP39242**
WEATHER PROOF BOOT NUT
 (Black)
 • For standard toggles w/ 15/32" mounting stem
 • Completely covers toggle handle
 • Seals out moisture & dirt
 • For toggle handles up to 1 1/4" long

****MP39280**
***MP39282**
WEATHER PROOF BOOT NUT
 (Black)
 • For standard toggles w/ 15/32" mounting stem
 • Completely covers toggle handle
 • Seals out moisture & dirt
 • For toggle handles up to 1 1/4" long
 • 2 piece construction chrome ring retains switch



Indicator Lights



****UN22100** Red
***UN22102**

****UN22110** Green
***UN22112**

****UN22120** Amber
***UN22122**

Small Indicator Lights
 12 VDC use only
 • 5/16" mounting hole
 • 5" tinned copper wire leads



****UN22150** Red
***UN22152**

****UN22160** Green
***UN22162**

Small Indicator Lights
 125 VAC use only
 • 5/16" mounting hole
 • 5" tinned copper wire leads



****UN21280** Red
***UN21282**

****UN21290** Green
***UN21292**

****UN21320** Amber
***UN21322**

Large Indicator Lights
12 VDC use only
• 1/2" mounting hole
• 4" tinned copper wire leads



• 12 VDC use only
• 17/32" Lenze
• Insulated plastic socket
• Chrome plated brass bezel
• 1 1/16"L x 3/4" mounting socket
• Replaceable bulb

****UN22190**
***UN22192**
PILOT LIGHT

Weather Resistant Push Pull Switches



****MP39380**
***MP39382**

OFF-ON SPST
• Solid brass construction
• Gasket sealed case
• 3/8" mounting bushing
• 2 screw terminals
• 3/4" chrome plated brass knob
• For panels up to 1" thick
Rated: 15 amp @ 12 VDC



• Solid brass construction
• Vinyl coated body to resist moisture
• Two 18 gauge x 12" wire leads
• 3/8" mounting bushing
• For panels up to 1" thick
Rated: 15 amp @ 12 VDC

****MP39390**
***MP39392**

OFF-ON SPST
with chrome plated plastic knob
****MP39390B**
***MP39392B**

OFF-ON SPST
with chrome plated brass knob

Heavy Duty Marine Push Pull Switches



****MP39510**
***MP39512**

OFF-ON SPST
• Pull for ON
• Solid brass construction
• 3/8" mounting bushing
• 2 screw terminals
• For panels up to 1" thick
• Cream plastic knob
Rated: 15 amp @ 12 VDC



****MP39520**
***MP39522**

OFF-ON SPST
• Pull for ON
• Solid brass construction
• 3/8" mounting bushing
• 2 screw terminals
• For panels up to 1" thick
• Chrome plated plastic knob
Rated: 15 amp @ 12 VDC



****MP39530**
***MP39532**

OFF-ON SPST
• Pull for ON
• Solid brass construction
• 3/8" mounting bushing
• 2 screw terminals
• For panels up to 1" thick
• Chrome plated solid brass knob
Rated: 15 amp @ 12 VDC



****MP39540**
***MP39542**

OFF-ON SPST
• Pull for ON
• Solid brass construction
• 3/8" mounting bushing
• 2 blade terminals
• For panels up to 1" thick
• Chrome finish plastic knob
Rated: 15 amp @ 12 VDC



****MP39600**
***MP39602**

OFF-ON (1 & 2) SPST
• Pull for ON - turns on two separate circuits
• Solid brass construction
• 3/8" mounting bushing
• 3 screw terminals
• For panels up to 1" thick
• Chrome plated solid brass knob
Rated: 15 amp @ 12 VDC



****MP39570**
***MP39572**

OFF-ON(1)-ON(1&2) SPDT
• First pull energizes #1
• Second pull energizes both circuits
• Solid brass construction
• 3/8" mounting bushing
• 3 screw terminals
• For panels up to 1" thick
• Chrome finish plastic knob
Rated: 15 amp @ 12 VDC



****MP39580**
***MP39582**

OFF-ON(1)-ON(1&2) SPDT
• First pull energizes #1
• Second pull energizes both circuits
• Solid brass construction
• 3/8" mounting bushing
• 3 screw terminals
• For panels up to 1" thick
• Chrome plated solid brass knob
Rated: 15 amp @ 12 VDC



****MP39590**
***MP39592**

OFF-ON(1)-ON(1&2) SPDT
• First pull energizes #1
• Second pull energizes both circuits
• Solid brass construction
• 3/8" mounting bushing
• 3 blade terminals
• For panels up to 1" thick
• Chrome finish plastic knob
Rated: 15 amp @ 12 VDC



****MP39610**
***MP39612**

OFF-ON(1)-ON(2&3) SPDT
• First pull energizes #1
• Second pull energizes two separate circuits
• For anchor/running lights or similar function
• Solid brass construction
• 3/8" mounting bushing
• 4 screw terminals
• For panels up to 1" thick
• Chrome finish plastic knob
Rated: 15 amp @ 12 VDC

***BULK - 100 pcs. per carton **CLAMSHELL**

****MP39620**
***MP39622**
 OFF-ON(1)-ON(2&3)
 SPDT

- First pull energizes #1
 - Second pull energizes two separate circuits
 - For anchor/running lights or similar function
 - Solid brass construction
 - 3/8" mounting bushing
 - 4 screw terminals
 - For panels up to 1" thick
 - Chrome plated solid brass knob
- Rated: 15 amp @ 12 VDC



****MP39640**
***MP39642**
 OFF-ON(1)-ON(2)
 SPDT

- First pull energizes #1
 - Second pull energizes circuit 2
 - Solid brass construction
 - 3/8" mounting bushing
 - 3 screw terminals
 - For panels up to 1" thick
 - Chrome plated solid brass knob
- Rated: 15 amp @ 12 VDC



****MP39400**
***MP39402**

- ON-ON SPST
- Used to control same circuit from two locations
 - Solid brass construction
 - 3/8" mounting bushing
 - 3 screw terminals
 - For panels up to 1" thick
 - Chrome plated solid brass knob
- Rated: 15 amp @ 12 VDC



****MP21460**
***MP21462**
PUSH ON - PUSH OFF

- Two 5" wire leads for easy connection
 - 3/8"L x 15/32" mounting stem
- Rated: 3 amps @ 125 VAC



Heavy Duty Push Button Switches Momentary ON-OFF SPST

- Corrosion resistant plastic construction
 - 1 7/16"L x 5/8" mounting stem
 - 2 boss screw terminals
- Rated: 30 Amp @ 12 VDC



****MP39160**
***MP39162**
 with rubber boot nut

****MP39180**
***MP39182**
 with std. chrome face nut

Heavy Duty Brass Push Button Switches Momentary ON-OFF SPST

- Solid brass construction
 - For starter, horn or other functions
 - 1 3/8"L x 5/8"-32 mounting stem
 - 2 boss screw terminals
- Rated: 35 amp @ 12 VDC



****MP39360**
***MP39362**
 with recessed plunger button
 prevents accidental actuation

****MP39410**
***MP39412**
 with large 15/16"
 anodized face nut
 and button



****MP39420**
***MP39422**
 with chrome
 plated brass face
 nut and button

Brass Push Button Switches Momentary ON-OFF SPST

- Solid brass construction
 - For starter, horn or other functions
 - 1 1/4"L x 5/8" mounting stem
 - 2 screw terminals (except MP39340)
- Rated: 20 amp @ 12 VDC



****MP39310**
***MP39312**
 with chrome plated brass
 face nut and button

****MP39320**
***MP39322**
 with rubber boot nut

****MP39340**
***MP39342**
 with rubber boot nut
 blade terminals



Compact Push Button Switches Momentary ON-OFF SPST

- **MP39300**
***MP39302**
 MOM ON-OFF SPST
- Large black plastic button
 - Chrome plated brass housing
 - For fog horns or sirens
 - Overall width 2 5/8"



****MP39680**
***MP39682**
 Black Button

****MP39690**
***MP39692**
 Red Button

****MP39670**
***MP39672**
 White Button



- Contoured plastic button
 - Chrome plated brass mounting stem
 - 1/2" Mounting hole
 - 2 brass blade terminals
- Rated 15 amp @ 12 VDC

****MP39350**
***MP39352**
PUSH BUTTON SWITCH
 MOM ON - OFF SPST
 • Solid brass construction
 • Weather resistant plasticized coating
 • Rubber boot nut
 • Two 12" L 18 gauge wire leads
 • Mounting bushing 15/16" L X 5/8"-32
 Rated: 10 amps @ 12 VDC



****UN42000**
***UN42002**
MOM ON - OFF SPST
 • Extra heavy duty die cast construction
 • Silver contacts
 • 2 boss screw terminals
 • Rubber boot nut
 Rated: 60 amp @ 12 VDC



****MP39260**
***MP39262**
WEATHER PROOF BOOT NUT
 Black
 • For push button switches
 • Chrome face nut
 • Seals out moisture & dirt
 • Tapered design



****MP39170**
***MP39172**
COVER
 Gray rubber cap
 for push button switches



****MP39140**
***MP39142**
COVER
 Black rubber cap
 for push button switches



FUSES

AGA GLASS TUBE FUSES
 1/4" X 5/8"

P/N	Rating	Per pack	P/N	Rating	Per pack
**FS79000	2 AMP	5	**FS79060	20 AMP	5
**FS79050	15 AMP	5	**FS79070	30 AMP	5

AGC GLASS TUBE FUSES
 1/4" X 1 1/4"

P/N	Rating	Per pack	P/N	Rating	Per pack
**FS79080	0.5 AMP	5	**FS79150	6 AMP	5
**FS79090	1 AMP	5	**FS79160	7.5 AMP	5
**FS79100	1.5 AMP	5	**FS79170	10 AMP	5
**FS79110	2 AMP	5	**FS79180	15 AMP	5
**FS79470	2.5 AMP	5	**FS79190	20 AMP	5
**FS79120	3 AMP	5	**FS79200	25 AMP	5
**FS79130	4 AMP	5	**FS79210	30 AMP	5
**FS79140	5 AMP	5	**FS79220	35 AMP	5

SFE GLASS TUBE FUSES

P/N	Rating	Size	Per pack
**FS79250	7.5 AMP	1/4" X 7/8"	5
**FS79260	9 AMP	1/4" X 7/8"	5
**FS79270	14 AMP	1/4" X 1"	5
**FS79280	20 AMP	1/4" X 1 1/4"	5
**FS79290	30 AMP	1/4" X 1 7/16"	5

AGU GLASS TUBE FUSES
 13/32" X 1 1/2"

P/N	Rating	Per pack
**FS79820	20 AMP	2
**FS79870	50 AMP	2

****FS79600**
 Emergency Fuse Kit Contains
 SIX fuses: 1 each SFE 9, 14,
 20 and AGC 10, 15, 30.





****FS79630**
 Bilge Pump and Accessory
 Fuse Kit Contains FIVE fuses:
 1 each AGC 5, 10, 15, 30
 amp, and 1 SFE 20 amp.





ATM and ATO Style Fuses

Color coded AMP ratings, plug in automotive style

 ATM STYLE FUSES 0.15 W x 0.429 H x 0.76 L	<table border="1" style="width: 100%; border-collapse: collapse;"> <thead> <tr> <th>Part Number</th> <th>Rating</th> <th>Color</th> <th>Pack</th> </tr> </thead> <tbody> <tr><td>**FS80000</td><td>2 AMP</td><td>GRAY</td><td>5</td></tr> <tr><td>**FS80010</td><td>3 AMP</td><td>VIOLET</td><td>5</td></tr> <tr><td>**FS80020</td><td>4 AMP</td><td>PINK</td><td>5</td></tr> <tr><td>**FS80030</td><td>5 AMP</td><td>TAN</td><td>5</td></tr> <tr><td>**FS80040</td><td>7.5 AMP</td><td>BROWN</td><td>5</td></tr> <tr><td>**FS80050</td><td>10 AMP</td><td>RED</td><td>5</td></tr> <tr><td>**FS80060</td><td>15 AMP</td><td>BLUE</td><td>5</td></tr> <tr><td>**FS80070</td><td>20 AMP</td><td>YELLOW</td><td>5</td></tr> <tr><td>**FS80080</td><td>25 AMP</td><td>CLEAR</td><td>5</td></tr> <tr><td>**FS80090</td><td>30 AMP</td><td>GREEN</td><td>5</td></tr> </tbody> </table>	Part Number	Rating	Color	Pack	**FS80000	2 AMP	GRAY	5	**FS80010	3 AMP	VIOLET	5	**FS80020	4 AMP	PINK	5	**FS80030	5 AMP	TAN	5	**FS80040	7.5 AMP	BROWN	5	**FS80050	10 AMP	RED	5	**FS80060	15 AMP	BLUE	5	**FS80070	20 AMP	YELLOW	5	**FS80080	25 AMP	CLEAR	5	**FS80090	30 AMP	GREEN	5	 **FS79680 ATM Fuse Kit Assortment
Part Number	Rating	Color	Pack																																											
**FS80000	2 AMP	GRAY	5																																											
**FS80010	3 AMP	VIOLET	5																																											
**FS80020	4 AMP	PINK	5																																											
**FS80030	5 AMP	TAN	5																																											
**FS80040	7.5 AMP	BROWN	5																																											
**FS80050	10 AMP	RED	5																																											
**FS80060	15 AMP	BLUE	5																																											
**FS80070	20 AMP	YELLOW	5																																											
**FS80080	25 AMP	CLEAR	5																																											
**FS80090	30 AMP	GREEN	5																																											

 ATO® STYLE FUSES 0.207 W X 0.752 H X 0.76 L	<table border="1" style="width: 100%; border-collapse: collapse;"> <thead> <tr> <th>Part Number</th> <th>Rating</th> <th>Color</th> <th>Pack</th> </tr> </thead> <tbody> <tr><td>**FS79480</td><td>1 AMP</td><td>BLACK</td><td>5</td></tr> <tr><td>**FS79490</td><td>2 AMP</td><td>GRAY</td><td>5</td></tr> <tr><td>**FS79500</td><td>3 AMP</td><td>VIOLET</td><td>5</td></tr> <tr><td>**FS79510</td><td>4 AMP</td><td>PINK</td><td>5</td></tr> <tr><td>**FS79520</td><td>5 AMP</td><td>TAN</td><td>5</td></tr> <tr><td>**FS79530</td><td>7.5 AMP</td><td>BROWN</td><td>5</td></tr> <tr><td>**FS79540</td><td>10 AMP</td><td>RED</td><td>5</td></tr> <tr><td>**FS79550</td><td>15 AMP</td><td>BLUE</td><td>5</td></tr> <tr><td>**FS79560</td><td>20 AMP</td><td>YELLOW</td><td>5</td></tr> <tr><td>**FS79570</td><td>25 AMP</td><td>CLEAR</td><td>5</td></tr> <tr><td>**FS79580</td><td>30 AMP</td><td>GREEN</td><td>5</td></tr> <tr><td>**FS79590</td><td>40 AMP</td><td>ORANGE</td><td>5</td></tr> </tbody> </table>	Part Number	Rating	Color	Pack	**FS79480	1 AMP	BLACK	5	**FS79490	2 AMP	GRAY	5	**FS79500	3 AMP	VIOLET	5	**FS79510	4 AMP	PINK	5	**FS79520	5 AMP	TAN	5	**FS79530	7.5 AMP	BROWN	5	**FS79540	10 AMP	RED	5	**FS79550	15 AMP	BLUE	5	**FS79560	20 AMP	YELLOW	5	**FS79570	25 AMP	CLEAR	5	**FS79580	30 AMP	GREEN	5	**FS79590	40 AMP	ORANGE	5	 **FS79690 ATO® Fuse Kit Assortment
Part Number	Rating	Color	Pack																																																			
**FS79480	1 AMP	BLACK	5																																																			
**FS79490	2 AMP	GRAY	5																																																			
**FS79500	3 AMP	VIOLET	5																																																			
**FS79510	4 AMP	PINK	5																																																			
**FS79520	5 AMP	TAN	5																																																			
**FS79530	7.5 AMP	BROWN	5																																																			
**FS79540	10 AMP	RED	5																																																			
**FS79550	15 AMP	BLUE	5																																																			
**FS79560	20 AMP	YELLOW	5																																																			
**FS79570	25 AMP	CLEAR	5																																																			
**FS79580	30 AMP	GREEN	5																																																			
**FS79590	40 AMP	ORANGE	5																																																			

MAXI™ Fuse Block	MAXI™ Fuses																																
<div style="display: flex; justify-content: space-between;"> <div style="width: 45%;"> <p>**FS81080 *FS81082</p> <ul style="list-style-type: none"> • Black Reinforced Polycarbonate • For Maxi™ fuses 30-80 A • Snap-on cover insulates conductive parts - meets ABYC & USCG requirements • Accepts 18-4 AWG wire from sides or bottom • Maximum voltage - 32 VDC • Meets SAE J1171 </div> <div style="width: 45%; text-align: center;">  </div> </div>	<div style="display: flex; justify-content: space-between;"> <div style="width: 45%;"> <ul style="list-style-type: none"> • Tin plated copper blades for corrosion protection • Visible indication of blown condition <p>Maximum voltage - 32 VDC</p> <table border="1" style="width: 100%; border-collapse: collapse;"> <thead> <tr> <th>Part number</th> <th>Rating</th> <th>Color</th> <th>Pack</th> </tr> </thead> <tbody> <tr><td>**FS81000</td><td>20 AMP</td><td>Yellow</td><td>1</td></tr> <tr><td>**FS81010</td><td>30 AMP</td><td>Green</td><td>1</td></tr> <tr><td>**FS81020</td><td>40 AMP</td><td>Orange</td><td>1</td></tr> <tr><td>**FS81030</td><td>50 AMP</td><td>Red</td><td>1</td></tr> <tr><td>**FS81040</td><td>60 AMP</td><td>Blue</td><td>1</td></tr> <tr><td>**FS81050</td><td>70 AMP</td><td>Amber</td><td>1</td></tr> <tr><td>**FS81060</td><td>80 AMP</td><td>Clear</td><td>1</td></tr> </tbody> </table> </div> <div style="width: 45%; text-align: center;">  </div> </div>	Part number	Rating	Color	Pack	**FS81000	20 AMP	Yellow	1	**FS81010	30 AMP	Green	1	**FS81020	40 AMP	Orange	1	**FS81030	50 AMP	Red	1	**FS81040	60 AMP	Blue	1	**FS81050	70 AMP	Amber	1	**FS81060	80 AMP	Clear	1
Part number	Rating	Color	Pack																														
**FS81000	20 AMP	Yellow	1																														
**FS81010	30 AMP	Green	1																														
**FS81020	40 AMP	Orange	1																														
**FS81030	50 AMP	Red	1																														
**FS81040	60 AMP	Blue	1																														
**FS81050	70 AMP	Amber	1																														
**FS81060	80 AMP	Clear	1																														

ATO/ATC Style Fuse Blocks				
	With Ground Bus Bar		Without Ground Bus Bar	
	Part Number	# of Gangs	Part Number	# of Gangs
<div style="display: flex; justify-content: space-between;"> <div style="width: 45%;"> <ul style="list-style-type: none"> • For ATO/ATC fuses • Interlocking modules snap together • 1/4" tin plated copper tab terminals • Flame resistant reinforced polyester base • Rated 30 Amps per circuit, 160 Amp total for block </div> <div style="width: 45%; text-align: center;">  </div> </div>	**FS40420	6	**FS40410	14
	*FS40422	6	*FS40412	14
	**FS40430	4	*FS56242	4
	*FS40432	4	*FS56232	6
	**FS40440	14	*FS56252	10
	*FS40442	14		
	**FS40450	8		
	*FS40452	8		
	**FS40740	10		
	*FS40742	10		

Ground Bus Bar for ATO/ATC Fuse Blocks	
	<p>**FS40730 *FS40732</p> <ul style="list-style-type: none"> • Replacement bus bar for Sierra ATO/ATC fuse blocks • 14 - 1/4" tin plated copper tab terminals

*BULK - 100 pcs. per carton **CLAMSHELL

Fuse Block for Glass Tube Fuses - Standard Fuse Blocks



- Use with SFE, AGC, or MDL fuses up to 20 Amp
- Heavy duty black molded base
- 8-32 terminal screws
- Tin plated brass fuse clips

Part Number	# of Gangs
*FS40502-1	2
**FS40510-1	4
*FS40512-1	4
**FS40520-1	6
*FS40522-1	6
**FS40530-1	8
*FS40532-1	8

Hot Feed/Common Ground Fuse Blocks



- Use with SFE, AGC, or MDL fuses up to 20 Amp
- Common bus bar connects hot side of fuses for power feed
- Separate bus bar for ground or unfused common hot feed
- Heavy duty black molded base
- 8-32 stud terminals for power/ground connection
- 1/4" Q.D. terminals for circuit hookup
- Tin plated brass fuse clips

Part Number	# of Gangs
**FS40630-1	4
*FS40632-1	4
**FS40640-1	6
*FS40642-1	6
*FS40652-1	8



- Use with SFE, AGC, or MDL fuses up to 20 Amp
- Common bus bar connects hot side of fuses for power feed
- Separate bus bar for ground or unfused common hot feed
- Heavy duty black molded base
- 8-32 terminal screws and stud terminals for power/ground connection
- Tin plated brass fuse clips

Part Number	# of Gangs
**FS40540	2
*FS40542-1	2
**FS40550-1	4
*FS40552-1	4
**FS40560-1	6
*FS40562-1	6
**FS40570-1	8
*FS40572-1	8

Hot Feed Fuse Blocks

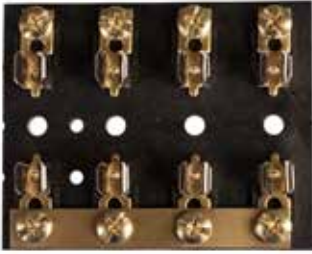

- Use with SFE, AGC, or MDL fuses up to 20 Amp
- Common bus bar connects hot side of fuses for power feed
- Heavy duty black molded base
- 8-32 terminal screws and stud terminal for power connection
- Tin plated brass fuse clips

Part Number	# of Gangs
**FS40590-1	4
*FS40592-1	4
**FS40600-1	6
*FS40602-1	6
**FS40610-1	8
*FS40612-1	8

*BULK - 100 pcs. per carton **CLAMSHELL

Corrosion Resistant Common Bus Bars

- Use as common hot feed or common ground block
- Tin plated copper bus
- Stainless steel studs & screws
- Large diameter nuts provide large electrical contact area
- Stainless steel screws with lock washers

150 Amp Common Bus

 <p>**FS46100 *FS46102</p> <ul style="list-style-type: none"> • 5 - 8-32 Screw Terminals • 2 - 10-24 Stud Terminals <p>Over all size - 4.13"Lx.75"Wx1.44"H</p>	 <p>**FS46150 *FS46152</p> <ul style="list-style-type: none"> • 4 - 10-24 Stud Terminals <p>Over all size - 4.13"Lx.75"Wx1.44"H</p>
 <p>**FS46200 *FS46202</p> <ul style="list-style-type: none"> • 10 - 8-32 Screw Terminals • 2 - 1/4"-20 Stud Terminals <p>Over all size - 6"Lx1.25"Wx1.44"H</p>	 <p>**FS46250 *FS46252</p> <ul style="list-style-type: none"> • 4 - 1/4"-20 Stud Terminals <p>Over all size - 6"Lx1.25"Wx1.44"H</p>
 <p>**FS46400 *FS46402</p> <ul style="list-style-type: none"> • 20 - 8-32 Screw Terminals • 2 - 1/4"-20 Stud Terminals <p>Over all size - 9 1/4"Lx1.25Wx1.44"H</p>	 <p>**FS46450 *FS46452</p> <ul style="list-style-type: none"> • 6 - 1/4"-20 Stud Terminals <p>Over all size - 9 1/4"Lx1.25Wx1.44"H</p>

250 Amp Common Bus

 <p>**FS46300 *FS46302</p> <ul style="list-style-type: none"> • 12 - 8-32 Screw Terminals • 2 - 1/4"-20 Stud Terminals <p>Over all size - 7.88"Lx1.5"Wx1.75"H</p>	 <p>**FS46350 *FS46352</p> <ul style="list-style-type: none"> • 4 - 1/4"-20 Stud Terminals <p>Over all size - 7.88"Lx1.5"Wx1.75"H</p>
---	--

600 Amp Common Bus

 <p>FS46551</p> <ul style="list-style-type: none"> • 4 X 3/8-16 stud terminals <p>Over all size - 7.00"L X 2"W X 2"H</p>	 <p>FS46561</p> <ul style="list-style-type: none"> • 8 X 3/8-16 stud terminals <p>Over all size - 11.375L X 2"W X 2"H</p>
--	---

Bus Bar Insulating Covers

- ABS cover designed to prevent accidental shorting

 <p>FSC46100 Fits FS46100, FS46150</p>	 <p>FSC46200 Fits FS46200, FS46250</p>	 <p>FSC46300 Fits FS46300, FS46350</p>
 <p>FSC46400 Fits FS46400, FS46450</p>	 <p>FSC46550 Fits FS46551</p>	 <p>FSC46560 Fits FS46561</p>

*BULK - 100 pcs. per carton **CLAMSHELL

Brass Bus Bars

* Use as common hot feed or common ground block
 * Brass terminal bar



****FS40750**
***FS40752**
 • 10 - 10-32 Screw Terminals
 • 2 - 1/4"-20 Stud Terminals
Overall size - 5.75"L x 1.25 W x 1.19"H



****FS40760**
***FS40762**
 • 20 10-32 Screw Terminals
 • 2 1/4"-20 Stud Terminals
Overall size - 8.81L x 1.24W x 1.19"H



****FS40720**
***FS40722**
 • 4 - 8-32 Screw Terminals
Overall size - 4.5"L x .5" W x 1"H

Dual Brass Bus Bars

* Combines negative and positive buses in one block
 * Brass terminal bar



****FS40660**
***FS40662**
 • 4 - 8-32 Screw Terminals
Overall size - 1.5"L x 1.5"W x .44"H



****FS40670**
***FS40672**
 • 8 - 8-32 Screw Terminals
Overall size - 3"L x 1.5"W x .44"H



****FS40680**
***FS40682**
 • 12 - 8-32 Screw Terminals
Overall size - 4.5"L x 1.5"W x .44"H



****FS40690**
***FS40692**
 • 16 - 8-32 Screw Terminals
Overall size - 6"L x 1.5"W x .44"H

Barrier Type Junction Blocks

• Each screw pair is 1 isolated circuit
 • Closed back insulates power from mounting circuit
 • Nickel plated brass bus bar



****FS45620**
***FS45622**
 • 4 Gang Block
 • 8 - 10-32 Screw Terminals
Overall size - 3.94"L x 1.312"W x 0.812"H



****FS45630**
***FS45632**
 • 6 Gang Block
 • 12 - 10-32 Screw Terminals
Overall size - 4.36"L x 1.312"W x 0.812"H



****FS45640**
***FS45642**
 • 8 Gang Block
 • 16 10-32 Screw Terminals
Overall size - 5.33"L x 1.312"W x 0.812"H



****FS45650**
***FS45652**
 • 10 Gang Block
 • 20 10-32 Screw Terminals
Overall size - 6.31"L x 1.312"W x 0.812"H

ATO/ATC Style Fuse Holders



****FS35870**
***FS35872**
FUSE HOLDER
 • Weather proof sealed case
 • 5" - 12 gauge wire leads
 • For ATO/ATC style fuses up to 30 amps







****FS69130**
***N-186913**
FUSE HOLDER
 • 5" - 12 gauge wire leads
 • For ATO/ATC style fuses up to 30 amps
 • Includes 30 amp fuse



****FS45410**
***FS45412**
FUSE HOLDER
 • 8" - 14 gauge wire loop
 • For ATO/ATC style fuses up to 20 amps

*BULK - 100 pcs. per carton **CLAMSHELL

Weather Resistant Glass Tube Style Fuse Holders

 <p>Weather Resistant Fuse Holder With Spare Fuse Compartment</p> <p>**FS69150 10 GA 8" wire loop w/ 2 30 Amp fuses **FS69160 12 GA 8" wire loop w/ 2 20 Amp fuses **FS69170 14 GA 8" wire loop w/ 2 15 Amp fuses **FS69180 16 GA 8" wire loop w/ 2 10 Amp fuses</p>		 <p>**FS69140 HEAVY DUTY FUSE HOLDER</p> <ul style="list-style-type: none"> • Weather resistant • 5" - 8 gauge wire leads • For 30 to 50 Amp AGC fuses
 <p>**FS45440 *FS45442 FUSE HOLDER</p> <ul style="list-style-type: none"> • Weather proof sealed case • 15" - 14 gauge wire loop • For up 20 amp SFE, AGC, MDL fuses 	 <p>**FS45460 *FS45462 FUSE HOLDER</p> <ul style="list-style-type: none"> • Weather proof sealed case • 15" - 14 gauge wire loop • Includes 20 amp SFE fuse 	 <p>**FS45470 *FS45472 FUSE HOLDER</p> <ul style="list-style-type: none"> • Weather proof sealed case • 15" - 10 gauge wire loop • Includes 30 amp SFE fuse

In-Line Glass Tube Style Fuse Holders

 <p>**FS45350 *FS45352 FUSE HOLDER</p> <ul style="list-style-type: none"> • Black plastic twist lock case • 8" - 14 gauge wire loop • Includes 20 amp SFE fuse 	 <p>**FS45360 *FS45362 FUSE HOLDER</p> <ul style="list-style-type: none"> • Red plastic twist lock case • 8" - 14 gauge wire loop • Includes 14 amp SFE fuse 	 <p>**FS45370 *FS45372 FUSE HOLDER</p> <ul style="list-style-type: none"> • Ivory plastic twist lock case • 8" - 14 gauge wire loop • Includes 9 amp SFE fuse
 <p>**FS45380 *FS45382 FUSE HOLDER</p> <ul style="list-style-type: none"> • Black plastic threaded case • 7" - 12 gauge wire loop • Includes 30 amp SFE fuse 	 <p>**FS45390 *FS45392 FUSE HOLDER</p> <ul style="list-style-type: none"> • Black plastic threaded case • 7" - 12 gauge wire loop • Includes 20 amp SFE fuse 	 <p>**FS45400 *FS45402 FUSE HOLDER</p> <ul style="list-style-type: none"> • White plastic twist lock case • 7" 16 gauge wire loop • For glass fuses up to 10 amp
 <p>**FS69100 FUSE HOLDER</p> <ul style="list-style-type: none"> • Black plastic twist lock case • 7" - 14 gauge wire loop • Includes 15 amp fuse 	 <p>**FS69110 FUSE HOLDER</p> <ul style="list-style-type: none"> • Black plastic twist lock case • 7" - 14 gauge wire loop • Includes 20 amp fuse 	 <p>**FS69120 FUSE HOLDER</p> <ul style="list-style-type: none"> • Heavy Duty • 12 gauge tinned copperwire • Includes 30 amp fuse

*BULK - 100 pcs. per carton **CLAMHELL

Panel Mount Glass Tube Style Fuse Holders

****FS22080**
***FS22082**
FUSE HOLDER

- Panel mount with red fuse label
- For glass fuses up to 20 amp
- For panels up to 5/16" thick



****FS45430**
***FS45432**
FUSE HOLDER

- Panel mount
- Weather resistant gasket sealed
- For AGC, MDL fuses
- For panels up to 5/16" thick



High Amperage Circuit Breakers

* Perfect for rigging trolling motors, windless, and other high amp electrical equipment

AUTO RESET

* INCLUDES STUD MOUNTING PLATE



CB42240 40 Amp
CB42250-1 50 Amp

MANUAL RESET

* INCLUDES STUD MOUNTING PLATE



CB43240 40 Amp
CB43250 50 Amp



CB60000
• Ignition Protected
• Waterproof
• Can be used as switch and circuit breaker
• Replaces Minnkota MKR-19
Rated - 60 A
Maximum voltage 42 VDC

Toggle Type Circuit Breakers

- High quality exact replacement on many top brands
- Color coded handles for quick identification of AC/DC
- White handles for DC, black handles for AC
- Clamshell packaging



Part Number	Amp Rating	Color
**CB40200	5	White
**CB40220	10	White
**CB40230	15	White
**CB40240	20	White
**CB40250	35	White
**CB40190	50	White
**CB40260	15	Black
**CB40270	20	Black
**CB40280	30	Black
**CB41240	40	Black

Push Button Resettable Circuit Breakers

- Replacement for popular panel mounted breakers
- Mounts in 3/8" hole
- White buttons for DC, black buttons for AC
- Use MP39210 for weatherproof boot nut



Part Number	Amp Rating	Color
**CB41100	3	White
**CB41200	5	White
**CB41210	10	White
**CB41220	15	White
**CB41230	20	White
**CB41200B	5	Black
**CB41210B	10	Black
**CB41220B	15	Black
**CB41230B	20	Black

Weather Proof Boot Nut



****MP39210**
• Seals out dirt and moisture
• For use with push button resettable circuit breakers

Combination Cigarette Lighter/Chart Light



****MP35650**
Includes element, case, socket, mounting bracket and hardware.

Audible Warning System



****MP41400**
COMPLETE AUDIBLE WARNING KIT
Contains:
****OP22900** Oil pressure switch 6PSI
TS25101 Temperature switch
MC33502 Buzzer switch
OP22891 Optional oil pressure switch 15 PSI
Loud warning buzzer alerts operator of dangerously high engine temperatures or low engine oil pressure. Kit includes instructions, oil pressure switch (set at 6 PSI) and temperature switch (set at 200° F).

4 Pole Flat Connectors

Shrouded connectors provide better protection against weather dirt and moisture. Unshrouded connectors are found on most OEM trailers. The plugs are interchangeable and can connect together.

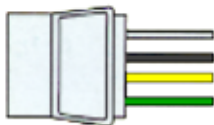

White Ground
Brown Tail, License, Marker Lamps
Yellow Left Turn Signal/Stop Lamp
Green Right Turn Signal/Stop Lamp

UNSHROUDED



Trailer Side

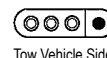

Tow Vehicle Side



SHROUDED



Trailer Side

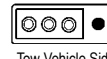

Tow Vehicle Side



Description	Set of Both Halves Part #	Tow Vehicle Side Part Number	Wire Length	Trailer Side Part Number	Wire Length
4 Pole Flat - Unshrouded	TC43654	NSS	4-12"	TC44054	4-12"
4 Pole Flat - Unshrouded	TC43674	TC44094	3-48", 1-18"	TC44054	4-12"
4 Pole Flat - Shrouded	TC43844	WH10180	4-12"	TC44254	4-12"
4 Pole Flat - Shrouded w/ splicers	TC43724				
4 Pole Flat - Shrouded		TC44224	3-48", 1-18"	TC44254	4-12"
4 Pole Flat - Shrouded rewire kit	TC43754	TC44224	3-48", 1-18"	NSS	4-20'
4 Pole Flat - Shrouded rewire kit w/ Splicers	TC43744	TC44224	3-48", 1-18"	NSS	4-20'
4 Pole Flat - Shrouded 5' Extension Harness	WH10350				
4 Pole Flat - Shrouded 25' rewire kit				WH10003	4-25'



**TC52000
TESTER**



**TC52100
TESTER**



**TC42884
TESTER**



**TC42984
DUST CAPS**
4 Pole Flat Dust Caps

Allows for quick and easy diagnosis of trailer/tow vehicle lighting problems; simply plug into vehicle trailer connector. LED lighting allows for each circuit to be quickly tested and evaluated.

5 Pole Flat Connectors

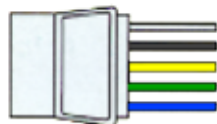

White Ground
Brown Tail, License, Marker Lamps
Yellow Left Turn Signal/Stop Lamp
Green Right Turn Signal/Stop Lamp
Blue Trailer Brake Solenoid



Description	Set of Both Halves Part #	Tow Vehicle Side Part Number	Wire Length	Trailer Side Part Number	Wire Length
5 Pole Flat - Unshrouded 18" Extension Harness	TC51000				
5 Pole Flat - Unshrouded		TC51100	5-48"	TC51200	5-70"

6 Pole Square Connectors

Similar to above except with 6 color coded wires to provide for 5 circuits PLUS ground.

Color codes are as follows:

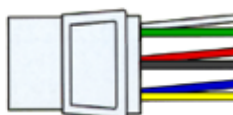

White Ground
Green Right Turn Signal
Red Stop Lamps
Brown Tail & License Lamps
Blue Auxiliary
Yellow Left Turn Lamp

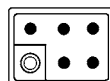

Trailer Side

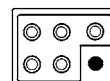







Tow Vehicle Side



Part #	Description	Tow Vehicle Side Replacement	Wire Length	Trailer Side Replacement	Wire Length
TC43924	Shrouded set of both halves.	Not sold separately	48"	Not sold separately	12"



Polarized Connectors

These polarized connector sets plug together only one way to prevent cross connections. Constructed of rugged plastic with molded-in terminals for durability. Wire connections are easy and fast with just a screwdriver. Soft, pliable rubber caps protect the rear of each connector. Dozens of uses. Sold only in mating pairs.

 <p>TC43604 2 Pole Polarized Round</p> <p>Trailer Side </p> <p>Tow Vehicle Side </p>	 <p>TC43614 3 Pole Polarized Round</p> <p>Trailer Side </p> <p>Tow Vehicle Side </p>	 <p>TC43624 4 Pole Polarized Round</p> <p>Trailer Side </p> <p>Tow Vehicle Side </p>	 <p>TC43634 2 Pole Polarized - Flat with 12" wires on each half.</p> <p>Trailer Side </p> <p>Tow Vehicle Side </p>	 <p>2-WIRE FLAT CONNECTOR WH10300 12", 16 GA, 2 Plugs Ready Wired #E301120 WH10310 60", 16 GA, 2 Plugs Ready-Wired #E302120</p>
---	--	--	---	---

Heavy Duty Connectors

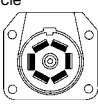
 <p>TC43084 4 Pole Round Connector</p> <p>Trailer Side </p>	 <p>TC43094 4 Pole Round Connector</p> <p>Tow Vehicle Side </p>	 <p>TC43354 6 Pole Round Connector</p> <p>Trailer Side </p>	 <p>TC43944 7 Pole RV Style Connector</p> <p>Trailer Side </p>
--	--	--	---





 <p>TC44984 7 Pole (Blade) RV Style Thermoplastic Converter Kit This kit is used on tow vehicle to convert any Sierra standard 4 pole flat connector to a 7 pole blade connector used on RV's.</p> <p>Tow Vehicle Side </p>	 <p>TC43904 Non-Strip Splicers Four blue non-strip splice connectors for making secure, permanent splices without stripping wires manually. Crimp with pliers and metal insert makes connection. Plastic top folds over to insulate connection.</p>	<h3>Electronic Taillight Converters</h3> <p>These reliable electronic devices enable tow vehicles and trailers with mismatched light systems to work together.</p>  <p>TC43504 Amber/Red to Red Taillight Converter Universal SPLICE-IN trailer converter for cars and trucks with separate stop and turn signals. Electronic taillight module converts tow vehicle's amber turn signal and red brake light into one combined red brake/turn signal on your trailer.</p>
---	--	--

Adapters

These adapters allow a tow vehicle with a 4, 6 or 7 pole socket to tow a trailer with a different configuration plug. Quality molded plastic connector stores in glove box when not in use.

 <p>TC50000 7 Pole RV Style Blade  to 5 pole flat - 18" extension harness </p>	 <p>TC51300 7 Pole RV Style Blade  to 5 pole flat </p>	 <p>TC42834 7 Pole RV Style Blade  to 6 Pole Pin </p>
 <p>TC42894 4 Pole Round  to 4 Pole Flat </p>	 <p>TC42904 6 Pole Round  to 4 Pole Flat </p>	 <p>TC42914 7 Pole RV Style Blade  to 4 Pole Flat </p>





 <p>WH10600 V-GROOVE FEMALE MOTOR SIDE TROLLING MOTOR SOCKET 12 Volt 6" - 8 gauge w/ butt connectors Use with WH10610</p>	 <p>WH10610 V-GROOVE MALE BOAT SIDE TROLLING MOTOR PLUG 12 Volt 6" - 8 gauge w/ butt connectors Use with WH10600</p>	 <p>WH10520 MALE BOAT SIDE TROLLING MOTOR PLUG 12 Volt 6" - 8 gauge w/ butt connectors Use with WH10530</p>
--	--	--

 <p>WH10530 FEMALE MOTOR SIDE TROLLING MOTOR SOCKET 12 Volt 6" - 8 gauge w/ butt connectors Use with WH10520</p>	 <p>WH10540 MALE BOAT SIDE TROLLING MOTOR PLUG 24 Volt 6" - 8 gauge w/ butt connectors Use with WH10550</p>	 <p>WH10550 FEMALE MOTOR SIDE TROLLING MOTOR SOCKET 24 Volt 6" - 8 gauge w/ butt connectors Use with WH10540</p>	 <p>WH10470 FEMALE BOAT SIDE TROLLING MOTOR SOCKET 12 Volt 6" - 10 gauge w/ butt connectors Use with WH10480</p>
--	---	---	--

 <p>WH10480 MALE MOTOR SIDE TROLLING MOTOR PLUG 12 Volt 6" - 10 gauge w/ butt connectors Use With WH10470</p>	 <p>WH10490 FEMALE BOAT SIDE TROLLING MOTOR SOCKET 24 Volt 6" - 10 gauge w/ butt connectors Use with WH10500</p>	 <p>WH10500 MALE MOTOR SIDE TROLLING MOTOR PLUG 24 Volt 6" - 10 gauge w/ butt connectors Use with WH10490</p>	 <p>WH10220 TRAILER SIDE CONNECTOR 24", 16 GA, 4/Pole Ready-Wired #M241120</p>
--	---	---	---

 <p>WH10320 3- WIRE FLAT CONNECTOR 12", 16 GA, 2 Plugs Ready Wired #E303120</p>	 <p>WH10160 DELUXE BRAIDED JUMPER 48", 16 GA 4/Pole Ready-Wired #B107300 (Car to Trailer)</p>	 <p>CARSIDE CONNECTOR WH10040 48", 16 GA 4/Pole Ready-Wired #B240010</p> <p>WH10230 48", 16GA 5/Pole Ready-Wired #M242010</p>	 <p>WH10240 TRAILER SIDE CONNECTOR 24", 16 GA 5/Pole Ready-Wired #M243120</p>
---	---	--	---

SOLENOIDS

 <p>BA58010 SOLENOID SWITCH * Weather resistant plastic coating * Composite mounting bracket * 12 V insulated Rated 85 A continuous duty</p>	 <p>BA58003 * Use as battery isolation switch * Steel housing copper contacts * 12 Volts insulated Continuous rating: 80 amp @ 12 VDC Intermittent rating: 750 amp make 100 amp break 10 seconds ON 30 minutes OFF</p>	 <p>18-5840 * Steel housing copper contacts * 12 Volts grounded Continuous rating: 85 amp @ 12 VDC</p>	 <p>BA58050 * Steel housing copper contacts * 12 Volts insulated Intermittent rating: 750 amp make 100 amp break 10 seconds ON 20 minutes OFF</p>	 <p>BA58020 * Motor reversing * Dynamic braking when both coils are in same electrical state *12/24V DC *Intermittent rating: 150A *Continuous rating: 75 amp (5 min.)</p>
--	--	--	---	--

LEVER SWITCHES

**MP38910
LEVER OPERATED
BATTERY DISCONNECT SWITCH**

Rated 175 A continuous, 800 A intermittent
 * 3/8" brass terminals
 * Chrome Plated Brass Lever
 * Includes faceplate



**UN19690
Replacement face plate**



**UN77310
BATTERY SWITCH**

Polyester housing is rust and corrosion proof. Removable plastic key for security. Two position switch "Off-On". Two 10MM X 1.5MM stud terminals. For panels up to 1.25 thick. Four mounting holes in a rectangle 1.3" and .8" on centers.



BATTERY ACCESSORIES

**UNIVERSAL BRASS
BATTERY TERMINALS**

Part No.	Contents
BT44490	1 Positive and 1 Negative Terminal Per Display/Pack
BT44501	10 Negative Terminals Per Box
BT44511	10 Positive Terminals Per Box



**BT44430
LEAD UNIVERSAL BATTERY
TERMINAL**



**UNIVERSAL BRASS
BATTERY TERMINALS**
BT44470 **BT44480**
 Neg. 5/16" Stud Pos. 3/8" Stud



BATTERY CABLES

Gauge cable with soldered lug terminals on each end to accept a 3/8" stud

Part No.	Size	Color	Gauge
BC88523	2'	red	4
BC88533	2'	black	4
BC88543	4'	red	2
BC88553	4'	black	2
BC88563	6'	red	2
BC88573	6'	black	2
BC88583	8'	red	1
BC88593	8'	black	1

**18-6850
BATTERY DISCONNECT RELAY**

Fits: Universal



**18-6851
BATTERY ISOLATOR**

Fits: Universal



**18-6852
BATTERY ISOLATOR**

Fits: Universal



**18-6853
BATTERY ISOLATOR**

Fits: Universal



**18-6854
BATTERY ISOLATOR**

Fits: Universal



**18-6855
BATTERY ISOLATOR**

Fits: Universal



**18-6856
BATTERY ISOLATOR**

Fits: Universal



TRAILER BEARINGS

TRAILER BEARING KITS

For Straight Spindles

18-1105 1" Bearing Kit
(BRG #L44643-L44610)

18-1106 1 1/16" Bearing Kit
(BRG #L44649-L44610)

18-1107 1 1/4" Bearing Kit
(BRG # LM67048-LM67010)

For Step Spindles

18-1109 1 1/4" & 3/4" Bearing Kit
(BRG #LM67048-LM67010, LM11949-LM11910)

18-1110 1 3/8" & 11/16" Bearing Kit
(BRG #L68149-L68111, L44649-L44610)



18-1100
STANDARD TRAILER BEARING DUST COVER
For Trailer Bearings
1.980 Dia.

PKG. OF 10



COTTER PINS

Part No.	Dimensions	Std. Pkg.
18-1199 ①	1/8 x 2	10
18-3748 ①	7/64 x 1 1/2	5
18-3746 ①	1/8 x 1	10
18-3747 ①	5/32 x 1 1/2	10



TRAILER BEARING SEALS

Part No.	O.D.	Dimensions	
		Shaft Size	Width
18-1175	1.785	1.125	.467
18-1176	1.783	1.250	.257
18-1177	2.330	1.500	.408
18-1178	2.566	1.750	.500

① This product is priced per piece. To order priced per package, please add a -9 to the part number.

Waterproof Terminals

16-14 GAUGE RING TERMINALS

STUD SIZE	WIRE GAUGE	INSUL COLOR	PACKAGE OF 10
8	16-14	Blue	EC63120
10	16-14	Blue	EC63130
1/4"	16-14	Blue	EC63140
5/16"	16-14	Blue	EC63190
3/8"	16-14	Blue	EC63200

12-10 GAUGE RING TERMINALS

STUD SIZE	WIRE GAUGE	INSUL COLOR	PACKAGE OF 10
8	12-10	Yellow	EC63720
10	12-10	Yellow	EC63240
1/4"	12-10	Yellow	EC63250
5/16"	12-10	Yellow	EC63260
3/8"	12-10	Yellow	EC63300



Waterproof Connectors

22-10 GAUGE BUTT CONNECTORS

WIRE GAUGE	INSUL COLOR	PACKAGE OF 10	100 PACK BOX
22-18	Red	EC64000	EC64000-100
16-14	Blue	EC64110	EC64110-100
12-10	Yellow	EC64230	EC64230-100



Ring Terminals



22-18 GAUGE RING TERMINALS

STUD SIZE	WIRE GAUGE	INSUL COLOR	PACKAGE OF 10	100 PACK BOX PART #
6	22-18	Red	EC04010	EC04010-100
8	22-18	Red	EC04020	EC04020-100
10	22-18	Red	—	EC04030-100
1/4"	22-18	Red	—	EC04040-100
5/16"	22-18	Red	—	EC04670-100
3/8"	22-18	Red	—	EC04680-100

16-14 GAUGE RING TERMINALS

STUD SIZE	WIRE GAUGE	INSUL COLOR	PACKAGE OF 10	100 PACK BOX PART #
6	16-14	Blue	—	EC04690-100
8	16-14	Blue	EC04120	EC04120-100
10	16-14	Blue	EC04130	EC04130-100
1/4"	16-14	Blue	EC04140	EC04140-100
5/16"	16-14	Blue	EC04190	EC04190-100
3/8"	16-14	Blue	EC04200	EC04200-100

12 - 10 GAUGE RING TERMINALS

STUD SIZE	WIRE GAUGE	INSUL COLOR	PACKAGE OF 10	100 PACK BOX PART #
6	12-10	Yellow	—	EC04710-100
8	12-10	Yellow	—	EC04720-100
10	12-10	Yellow	EC04240	EC04240-100
1/4"	12-10	Yellow	EC04250	EC04250-100
5/16"	12-10	Yellow	EC04260	EC04260-100
3/8"	12-10	Yellow	EC04300	EC04300-100

Quick Disconnects, Bullet, Butt and Spade Terminals

SPADE LUG TERMINALS

STUD SIZE	WIRE GAUGE	INSUL COLOR	PACKAGE OF 10	100 PACK BOX PART #
8	22-18	Red	EC04090	EC04090-100
10	22-18	Red	EC04100	EC04100-100
8	16-14	Blue	EC04210	EC04210-100
10	16-14	Blue	EC04220	EC04220-100
8	12-10	Yellow	—	EC04700-100
10	12-10	Yellow	—	EC04270-100



.250 QUICK DISCONNECTS

WIRE TYPE	WIRE GAUGE	INSUL COLOR	PACKAGE OF 10	100 PACK BOX PART #
Female	22-18	Red	EC04050	EC04050-100
Male	22-18	Red	EC04060	EC04060-100
Female	16-14	Blue	EC04150	EC04150-100
Male	16-14	Blue	—	EC04160-100
Female	12-10	Yellow	EC04280	EC04280-100
Male	12-10	Yellow	EC04290	EC04290-100
Fully Insul. Female	22-18	Red	—	EC04520-100
Fully Insul. Male	22-18	Red	—	EC04510-100
Fully Insul. Female	16-14	Blue	EC04500	EC04500-100
Fully Insul. Male	16-14	Blue	EC04490	EC04490-100



BUTT CONNECTORS

WIRE GAUGE	INSUL COLOR	PACKAGE OF 10	100 PACK BOX PART #
22-18	Red	EC04000	EC04000-100
16-14	Blue	EC04110	EC04110-100
12-10	Yellow	EC04230	EC04230-100



.157 BULLET TERMINALS

WIRE TYPE	WIRE GAUGE	INSUL COLOR	VISUAL PART #	PACK QTY	PACKAGE OF 10	100 PACK BOX PART #
Female	22-18	Red	—	—	EC04080	EC04080-100
Male	22-18	Red	—	—	—	EC04070-100
Female	16-14	Blue	—	—	EC04180	EC04180-100
Male	16-14	Blue	—	—	EC04170	EC04170-100
Set	16-14	Blue	EC01570	3 Sets	—	—



SET

SHRINK/PROTECTIVE FLEX TUBING



TYPE	DIA.	VISUAL PART #	PACK QTY	LENGTH
Flex Tubing	3/8"	EC01620	1	3'
Flex Tubing	1/2"	EC01630	1	3'
Shrink Tube	Assort.	EC01750	7	Assort.

CHARGING CLIP



PKG OF 2

AMP	RATING
30 Amp	EC06230

DURA-TUBE HEAT-SHRINK TUBING

PKG OF 25



EC10290	1 1/4" Long
For 10-20 GA. Wire	





NYLON CABLE CLAMPS



DIA.	VISUAL PART #	QTY
5/16"	EC01440	7
3/8"	EC01450	6
1/2"	EC01460	5

ALLIGATOR CLIPS/TEST LEADS

TYPE SIZE	PACKAGE OF 2
Clip	EC01360
Clip 2" w/screw term	EC01370
Clip 1-1/4" insulated	EC01380
Leads 30" long	EC01760

 EC01380	 EC01370
 EC01360	 EC01760



EC10250
3/4" TEST CLIPS
50 AMP
 Replaces: OMC 390926
 (One Pair)

ELECTRICAL TOOLS, TESTERS AND ASSORTMENTS



EC09040
DUAL VOLTAGE CIRCUIT TESTER
 Dual bulb tester for testing both 6 and 12 volt circuits. Also can be used to check spark plug wires. This is the most commonly used tester for trouble shooting auto, truck, van and boat wiring. Supplied with ground wire and clip. Packed one per card.



EC09090
DIGITAL MINI MULTIMETER
 This digital mini multimeter has the compact design and the functions you need for overall convenience. Its low price will surprise you!

- Protective holster included
- 3 1/2 digit LCD display
- 16 test ranges, 6 functions
- Battery included
- Fuse protected, removable safety leads and jacks

DC Volts: 0-200mV, 2000mV 20V, 200V, 500V
 AC Volts: 0-200V, 500V
 DC Amps: 0-2mA, 20mA, 200mA
 Ohms: 0-200W, 2000W, 20KW, 200KW, 2000KW
 Diode Test: 0-2000W
 Battery Test: 0-9v



EC01310
 175 of the most popular terminals in a shatterproof nylon box.



EC01350
 30 piece terminal assortment packed with crimp tool/wire cutter. Attractive 5 compartment clamshell fits neatly in tool box or glove compartment. Handy for emergencies. Perfect for the do-it-yourselfers.

CAM LOCKS
 Secure lockers, hatches, compartments and drawers.
 1001 uses. Five sizes available.

CL49300 Cam lock — 3/8" depth.
CL49310 Cam lock — 5/8" depth.
CL49320 Cam lock — 7/8" depth.
CL49330
 * **CL52422** Cam lock — 1-1/8" depth.
CL49330 KA
 * **CL49332** Cam lock — 1-3/8" depth.



LIFT LATCH/LOCKS
 Dozens of applications: bait lockers, fish wells, equipment lockers, hatches, storage compartments. Locking and nonlocking styles available. Plate/ring are stainless steel. Holes for #8 mounting screws are 1.5" (w) and 1.312 (h) on center.

MP49500 Nonlocking hatch lift only.
 Measures 2.16 x 1.90 x .25(h)

MP49550 Hatch lift plate with lock mounting hole and lock.
 Maximum depth 1-1/8". Measures 2.16 x 1.90 x .25(h)



*BULK - 100 pcs. per carton



MP49410
***MP49412**

- Turn to open mechanism – no finger pull
- Can be locked or left in latch only position
- Totally corrosion resistant
- Black glass reinforced polyester
- Supplied with 2 keys



MP49430
***MP49432**

- Turn to open mechanism – no finger pull
- Non-Locking version
- Totally corrosion resistant
- Black glass reinforced polyester



MP50560
***MP50562**

- Black sculpted knob
- Turn to open mechanism – no finger pull
- Can be locked or left in latch only position
- Totally corrosion resistant
- Black glass reinforced polyester
- Supplied with 2 keys



MP42402
BAIT WELL LIGHT

"Heavy Duty" Docking Lights

Protect your boat from damage while docking at night!

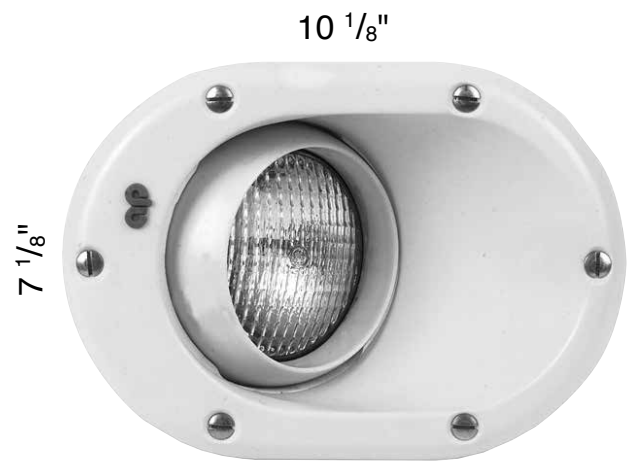

Recess 5 1/8"

- ✗ 30,000 cp. bulb illuminates below the deckline. Makes nighttime docking *SAFE & EASY!*
- ✗ Newly-designed housing is *FULLY* sealed! Water cannot enter hull through Docking Light! Old-style O-ring no longer needed to seal hull.
- ✗ *ALIGN & CHANGE* Eyeball from *EXTERIOR* of the hull. Just loosen set screw to align or change Eyeball.
- ✗ *ELIMINATES* the need for access to the rear of the installed Docking Light!
- ✗ New Eyeball *WILL* fit into "old-style" Docking Light housing!
- ✗ New-style housing will fit existing cut-out with only slight modification.
- ✗ Mil-Spec sealed *WATERPROOF/DUSTPROOF* rocker switch panel included.
- ✗ US Patent #5672004
- ✗ **Intended for Docking Only, Not for Continuous Use.**

Docking Lights

Part#	Description	Color	Watts
95001	12v Marine Docking Light Set - Incandescent Bulb	White	100
95002	12v Marine Replacement Light for 95001		
95013	28v Marine Docking Light Set - Incandescent Bulb	White	50
95004	28v Marine Replacement Light for 95013		
95021	12v Marine Docking Light Set - Incandescent Bulb	Black	100
95016	12v Marine Replacement Light for 95021		
Auxiliary Lights			
95011	12v Single Light Kit - Halogen Bulb	White	100
95026	12v Marine Docking Light Set - Halogen Bulb		
Parts			
95005	Housing	White	—

POWER POLE REPLACEMENT PUMPS



18-6818
TRIM MOTOR
 Replaces: Power Pole PUMP SPN-F
 Fits: Power Pole Sportsman Models



18-6819
TRIM MOTOR
 Replaces: Power Pole PUMP PRO-F
 Fits: Power Pole Pro Models

*BULK - 100 pcs. per carton



SHIELDS CODE NUMBERS

All Shields Marine Hoses are identified by a 9 digit code number.

Example:

16-120-0580

The first two digits identify the product as a Shields hose:
16 = Shields Hose

The second three digits identify the type of hose:
120 = Bilgeflex

The third three digits identify the size of the hose:
058 = 5/8"

The last digit identifies the package quantity as follows:

1	—	6' or 6 1/4' Length
2	—	9' Length
3	—	10' Length
4	—	12 1/2' Length
5	—	25' Length
6	—	50' Length
7	—	100' Length
8	—	75' Length
0	—	Standard Bulk Pack
0-xx	—	Special Bulk Length (Example: 0-36 = 3')



Product Application Guide

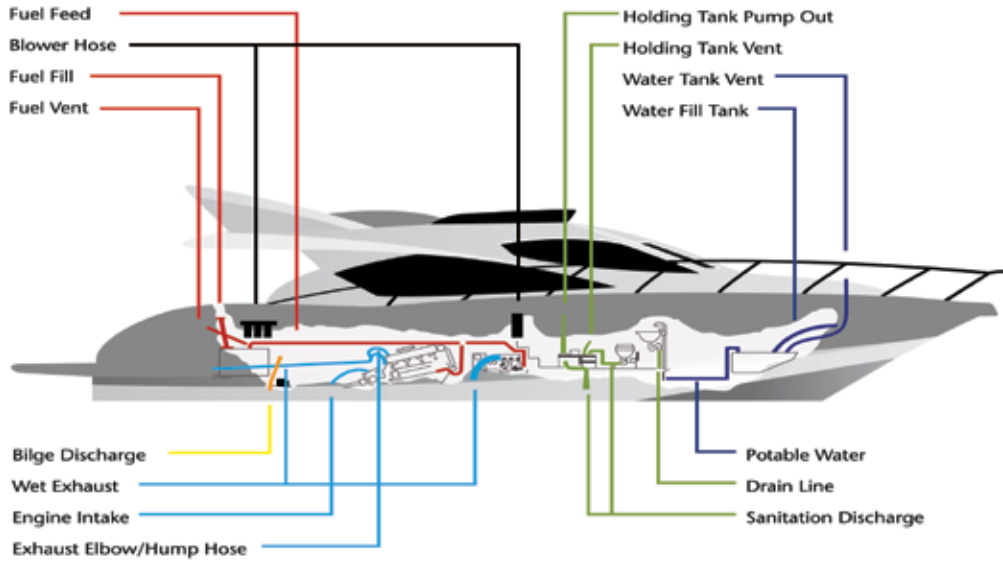

PRODUCT APPLICATION GUIDE KEY

- | | |
|---|---|
| EX — Designed to give excellent service | NA — Not available in size range |
| G — Designed to give good service in normal applications | 1 — Can easily be bent into tight radius |
| C — Product can give good service with proper installation, may not be suitable in all applications. | 2 — Can be bent into gradual radius |
| X — Not recommended | 3 — May kink in applications requiring bend radius |

SERIES NO.	NAME	PG. NO.	SIZE RANGE	APPLICATION						
				Submersible Bilge Pump	Remote Bilge Pump	Hand Bilge Pump	Livewell Inlet	Livewell Drain Above Water Line	Livewell Drain Below Water Line	Flexibility
 BILGE/LIVEWELL										
Series 120	Shields Bilgefex	65	5/8" - 1 1/2"	G	X	C	X	X	X	1
Series 123	Shields Bilgevac	65	3/4" - 1 1/8"	EX	G	EX	X	C	X	1
Series 140	Shields Vac Std.	66	1 1/4" - 1 1/2"	EX	EX	EX	G	G	C	1
Series 141	Shields Multiflex	67	5/8" - 3"	EX	G	EX	X	G	X	1
Series 142	Shields Vac Cuffs	66	1 1/4" - 1 1/2"							
Series 146	Shields Vac Extra Heavy Duty/Commercial Grade	67	5/8" - 3"	EX	EX	EX	EX	EX	EX	2
Series 147	Shields Vac H.D. Cuffs	66	1 1/2"							
Series 148	Shields Vac Extra Heavy Duty	68	5/8" - 1 1/2"	EX	EX	EX	EX	EX	EX	2
Series 149	Shields Livewell Hose	68	5/8" - 1 1/2"	EX	EX	EX	EX	EX	EX	1

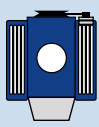
SERIES NO.	NAME	PG. NO.	SIZE RANGE	APPLICATION					
				Engine Intake	Generator Intake	Engine Coolant Hose Straight or Limited Bend	Engine Coolant Hose Severe Bend	Exhaust Water Injection	Flexibility
 ENGINE HOSE									
Series 130	Shields #1300 Heater Hose	69	1/2" - 3/4"	X	X	G	X	X	3
Series 135	Shields #1350 H.D. Water Hose	69	1/2" - 1"	X	C	G	X	G	3
Series 160	Shields #1600 Water Hose	69	3/8" - 1 1/4"	X	G	EX	X	G	2
Series 200	Shields Marine Exhaust	70	1/2" - 14"	X	C	EX	X	G	3
Series 202	Shields Nautiflex Silicone Exhaust Hose	71	1" - 14"	X	X	EX	X	C	3
Series 250	Shieldsflex II	72	1/2" - 8"	EX	EX	EX	EX	EX	2
Series 252	Shieldsaust - C	73	3/4" - 8"	EX	EX	EX	EX	EX	1
Series 262	Shields Corrugated Nautiflex Silicone Exhaust Hose	74	3/4" - 10"	EX	EX	EX	EX	EX	1

Product Application Guide (Cont.)

SERIES NO.	NAME	PG. NO.	SIZE RANGE	APPLICATION							
				Non-Pressurized Supply	Pressurized Supply		Water Tank Fill	Drain Lines Below Water Line	Drain Lines To Sump or Above Water Line	Water Tank Vent	Flexibility
					Hot	Cold					
	FRESH WATER SYSTEM/POTABLE										
Series 141	Shields Multiflex	75	5/8" - 3"	C	X	X	EX	X	EX	C	1
Series 148	Shields Vac Extra Heavy Duty	75	5/8" - 1 1/2"	N/A	X	X	EX	EX	EX	EX	2
Series 149	Shields Livewell Hose	76	5/8" - 1 1/2"	X	X	X	X	EX	EX	C	2
Series 150	Shields PVC Tubing — Clear	76	3/16" - 1 1/2"	G	X	X	C	X	G	G	3
Series 162	Shields All Clear Reinforced PVC — Red Tracer	77	3/8" - 1 1/2"	EX	EX	EX	G	G	G	G	2
Series 163	Shields Braided Wash Down Hose	77	5/8"								
Series 164	Shields Clear White Reinforced PVC — Blue Tracer	78	1/2" - 3/4"	EX	G	EX	N/A	G	G	G	3
Series 168	Shields Heavy Duty Reinforced PVC Tubing	78	1/4" - 1 1/2"	EX	EX	EX	G	EX	EX	EX	2

SERIES NO.	NAME	PG. NO.	SIZE RANGE	APPLICATION						
				Oil Tank Fill	Fuel Tank Fill	Fuel Feed Inboard/Outdrive	Fuel Feed Outboard	Fuel Tank Vent Inboard	Fuel Tank Vent Outboard	Flexibility
	FUEL SYSTEM									
Series 309	Shields Oil Tank Fill Hose	79	1 1/2"	EX	X	N/A	N/A	N/A	N/A	1
Series 315	Shields 315 - Silverado 2000	79	3/8" - 5/8"	N/A	N/A	X	EX	C	EX	2
Series 337	Shields Silverado 4000	80	5/16" - 3/8"	N/A	N/A	X	EX	N/A	N/A	1
Series 350	Shields FIRE-ACOL	81	1 5/8" - 2 3/8"	EX	EX	N/A	N/A	N/A	N/A	1
Series 351	Shields FIRE-ACOL-C	81	1 1/2"	EX	EX	N/A	N/A	N/A	N/A	1
Series 355	Shields Fuel Fill	82	1 1/2" - 2"	EX	EX	N/A	N/A	N/A	N/A	1
Series 365	Shields FIRE-ACOL-15	82	3/8" - 1/2"	N/A	N/A	EX	EX	N/A	N/A	1
Series 368	Shields Low Permeation Marine Fuel Hose	83	1/4" - 1/2"	N/A	N/A	EX	EX	N/A	N/A	1
Series 369	Shields FIRE-ACOL Fuel Vent Hose	83	5/8"	N/A	N/A	X	X	EX	EX	1
Fuel Accessories	Shields Brackets / Filters / Fuel Line Assemblies	84	-	-	-	-	-	-	-	-

SERIES NO.	NAME	PG. NO.	SIZE RANGE	APPLICATION					
				Toilet to Holding Tank	Holding Tank Pump Out	Holding Tank to Overboard Discharge	Toilet Water Inlet	Holding Tank Vent	Flexibility
	SANITATION SYSTEM								
Series 101	Shields Sanitation Hose	85	1" & 1 1/2"	EX	EX	EX	N/A	N/A	1
Series 105	Shields Poly X Sanitation Hose	85	1" & 1 1/2"	EX	EX	EX	N/A	N/A	1
Fittings	Shields For Series: 101, 105, 144, 148	85	3/4" - 1 1/2"						
Series 144	Shields Super PVC Sanitation	86	1" & 1 1/2"	EX	EX	EX	N/A	N/A	2
Series 146	Shields Vac Extra Heavy Duty/Industrial	86	5/8" - 3"	G	EX	G	EX	EX	2
Series 148	Shields Vac Extra Heavy Duty	87	5/8" - 1 1/2"	G/EX	EX	EX	EX	EX	2
Series 149	Shields Livewell	87	5/8" - 1 1/2"	G	G	G	EX	EX	2

SERIES NO.	NAME	PG. NO.	SIZE RANGE	APPLICATION		
				Blower Hose	A/C Duct	Exhaust Vent Stove Head
	VENTILATION/ AC DUCT					
Series 400	Shields Vinylvent	88	3" - 4"	EX	X	X
Series 402	Shields Vinylvent	88	3" - 4"	EX	X	X
Series 420	Shields Extra Heavy Duty Vinylvent	88	3" - 4"	EX	X	G
Series 450	Shields Fibervent	89	3" - 6"	EX	G	EX
Series 460	Shields AC Ducting Hose	89	3" - 7"	EX	EX	EX

Product Application Guide (Cont.)

SERIES NO.	NAME	PG. NO.	SIZE RANGE	APPLICATION				
				Straight Pipe Connector Less than 4 x I.D. of Hose	Straight Pipe Connector More than 4 x I.D. of Hose	Require Moderate Bend	Severe Bend	Flexibility
	 WET EXHAUST SYSTEM							
Series 200	Shields Marine Exhaust	90	1/2" - 14"	EX	C	X	X	3
Series 202	Nautiflex Silicone Exhaust Hose	91	1" - 14"	EX	C	X	X	3
Series 250	Shieldsflex II	92	1/2" - 8"	EX	EX	EX	C	2
Series 252	Shieldsaust - C	93	3/4" - 8"	EX	EX	EX	EX	1
Series 262	Corrugated Nautiflex Silicone Exhaust Hose	94	3/4" - 16"	EX	EX	EX	EX	1
Various	Hump Hose & Elbows	95-98	2" - 10"	See our selection for straight or angled connections				

SERIES NO.	NAME	PG. NO.	SIZE RANGE	APPLICATION
	MISCELLANEOUS			
	Exhaust Protector Valves	99	4" - 6"	Prevents water from entering exhaust system
	Hose Clamps	99	5/16" - 7"	Marine grade 316 stainless steel
	Exhaust Hose Clamps - T-Bolt Gand Clamps	99	1" - 14"	Designed to fit Shields Series: 200, 201, 210, 250, 252
	Ferrule Vise / Dies	100	1/4" - 1/2"	For making fuel line assemblies without clamps
Series 128	Flame Retardant Split Wire Conduit	101	1/4" - 2"	Provides chafing protection for wiring systems
Series 126	Shields Sternflex	101	2"	Provides protection for outboard rigging cables & hose
	Neoprene Sheet rubber	102	1/8" - 1/4"	Used under fuel tanks to comply with USCG requirements
Series 151	Speedometer Pitot Tubing	102	1/8" - 4mm	Connection from pitot to speedometer



SHIELDS BILGEFLEX



Shields Bilgeflex Hose is a single layer corrugated polyethylene hose. It is resistant to mild chemicals and salt water and there is a clamping cuff every foot. It is available in black or white (add B or W to suffix to specify color). This hose is primarily used for bilge pump discharge.

Do not attach to thru hull fitting below the water line.



I.D.	mm	Bend Radius	mm	Vac Rating	Wt. "C"	Code # *	Bulk Pack	m	50' (15.2m) R/O Ctn. Code #	Dist. Pkg. 9' (2.7M) Polypac Code #	6' (1.8M) Polypac Code #	25' (7.6M) R/O Ctn.
5/8"	15.9	1/2"	12.7	20	5	16-120-0580	600'	182.9	16-120-0586	16-120-0582	16-120-0581	—
3/4"	19.1	3/4"	19.1	20	6	16-120-0340	500'	152.4	16-120-0346	16-120-0342	16-120-0341	—
1 1/8"	28.6	1"	25.4	20	7	16-120-1180	300'	91.4	16-120-1186	16-120-1182	16-120-1181	—
1 1/4"	31.8	1 1/2"	38.1	20	10	16-120-1140	200'	61.0	16-120-1146	—	—	—
1 1/2"	38.1	2"	50.8	20	13	16-120-1120	150'	45.7	16-120-1126	—	—	16-120-1125

* Add B or W suffix to specify black or white

SHIELDS BILGEVAC



Shields Bilgevac Hose is a black PVC hose with a flexible vinyl helix. It is very flexible, abrasion resistant and is resistant to mild chemicals and saltwater. This hose is primarily used for bilge pump discharge and drains (sinks, shower, scupper, and livewell). **Do not attach to thru hull fitting below the water line.**

I.D.	mm	Bend Radius	mm	Wt. "C"	Bulk Pack 100' (30.5m) Coil Code #	Dist. Pkg. 50' (15.2m) R/O Ctn. Code #
3/4"	19.1	3/4"	50.8	8	16-123-0340	16-123-0346
1 1/8"	28.6	1"	76.2	16	16-123-1180	16-123-1186



SHIELDS VAC STANDARD

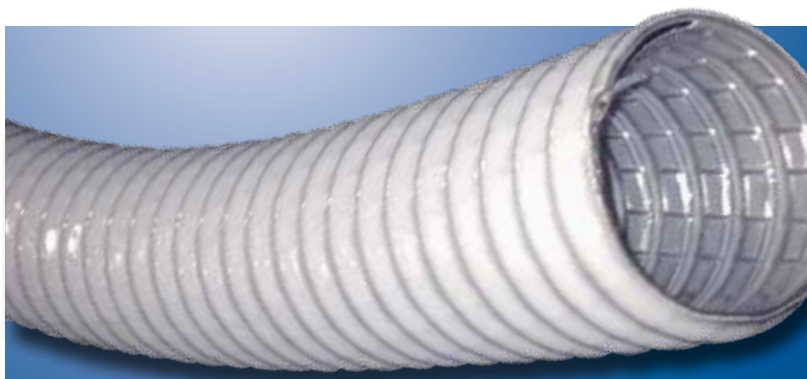

Shields Vac Standard Hose is PVC supported by vinyl covered steel wire and is very flexible. It is Nylon reinforced (1 ¼" and 1 ½" only) and is resistant to mild chemicals and saltwater. This hose is primarily used for bilge pump intake and discharge, diaphragm style hand operated bilge pump intake and discharge and drains (sinks, shower, and scupper). This hose uses 142 left hand thread cuffs. **Do not attach to thru hull fitting below the water line.**

I.D.	mm	Bend Radius	mm	Vac Rating	Wt. "C"	Bulk Pack Code #	Dist. Pkg. 50' (15.2m) R/O Ctn. Code #
1 ¼"	31.8	¾"	19.1	28	19	16-140-1140①	16-140-1146
1 ½"	38.1	¾"	19.1	28	23	16-140-1120①	16-140-1126

① 2 x 50' per box



SHIELDS VAC CUFFS

Shields Vac Cuffs provide added clamping protection for Shields Vac Hose. For watertight seal apply with sealing compound. Use with Series 140 & 141.

Size	mm	Wt. "C"	Code No.	For:	Thread
1 ¼"	31.8	12.5	16-142-1140	Series 140	Left Hand
1 ½"	38.1	13.0	16-142-1120	Series 140	Left Hand
1 ½"	38.1	13.0	16-147-1120	Series 141	Right Hand



SHIELDS MULTIFLEX



Shields Multiflex Hose has a clear FDA formula PVC with black vinyl helix. It is abrasion resistant, flexible and is resistant to mild chemicals and saltwater. This hose is primarily used for bilge pump discharge, potable water tank fill and drains (sinks, shower, livewell and scupper). This hose uses 147 right hand thread cuffs. **Do not attach to thru hull fitting below the water line. Do not use ethylene glycol based antifreeze in hose.**

I.D.	mm	Bend Radius	mm	Wt. "C"	Bulk Pack 100' (30.5m) Coil Code #	Dist. Pkg. 50' (15.2m) R/O Ctn. Code #	10' (3.1m) Length Code #
5/8"	15.9	1/2"	12.7	8	16-141-0580B	16-141-0586B	—
3/4"	19.1	3/4"	19.1	10	16-141-0340B	16-141-0346B	—
1"	25.4	7/8"	22.2	13	16-141-1000B	16-141-1006B	—
1 1/8"	28.6	1"	25.4	16	16-141-1180B	16-141-1186B	—
1 1/4"	31.8	1 1/2"	38.1	19	16-141-1140B	16-141-1146B	—
1 1/2"	38.1	2"	50.8	24	16-141-1120B	16-141-1126B	—
2"	50.8	5"	127.0	34	16-141-2000B	—	16-141-2003B
1 1/2"	38.1	2"	50.8	24	16-141-1120W	—	16-141-1123W

SHIELDS VAC EXTRA HEAVY DUTY - INDUSTRIAL GRADE



Shields Vac Extra Heavy Duty/Commercial Grade Hose has a smooth cover and clear FDA formula PVC with a white vinyl helix. It is rated for full vacuum and is resistant to mild chemicals and saltwater. This hose is primarily used for bilge pump intake and discharge, potable water tank fill, drains (sinks, shower, and scupper), livewell intake and drain, and sanitation (intake, vent and pump out). This hose is utilized for below the waterline connections. **Do not use ethylene glycol based antifreeze in hose. Do not use in pressurized water systems.**

I.D.	mm	Bend Radius	mm	Vac Rating	Wt. "C"	Bulk Pack 100' (30.5m) Coil Code #	50' (15.2m) R/O Ctn. Code #	Dist. Pkg. 10' (3.1m) Length Code #
5/8"	15.9	3	76.2	28	15	16-146-0580	16-146-0586	—
3/4"	19.1	3	76.2	28	16	16-146-0340	16-146-0346	—
1"	25.4	3	76.2	28	27	16-146-1000	16-146-1006	—
1 1/8"	28.6	4	101.6	28	25	16-146-1180	16-146-1186	—
1 1/4"	31.8	3	76.2	28	30	16-146-1140	16-146-1146	—
1 1/2"	38.1	4	101.6	28	40	16-146-1120	16-146-1126	—
2"	50.8	5	127.0	28	57	16-146-2000	—	16-146-2003
2 1/2"	63.5	7	177.8	28	74	16-146-2120	—	16-146-2123
3"	76.2	9	228.6	28	94	16-146-3000	—	16-146-3003

SHIELDS VAC EXTRA HEAVY DUTY/FDA

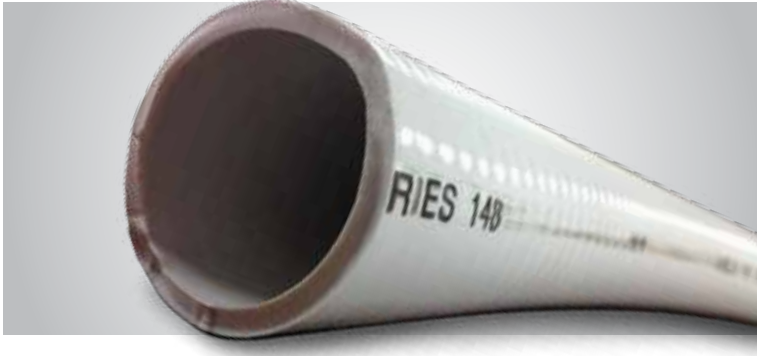

Shields Vac Extra Heavy Duty/FDA Hose has a smooth white FDA grade PVC with vinyl helix. It is rated for full vacuum and is resistant to mild chemicals, permeation, and saltwater. This hose is primarily used for bilge pump intake and discharge, drains (sinks, shower, and scupper), livewell intake and drain, potable water tank fill, and sanitation (toilet to holding tank, intake, self draining lines vent and pump out). This hose is resistant to odor permeation. **Do not use ethylene glycol based antifreeze in hose. Do not use in pressurized water systems.**

I.D.	mm	Bend Radius	mm	Vac Rating	Wt. "C"	Bulk Pack 100' (30.5m) Coil Code #	Dist. Pkg. 50' (15.2m) R/O Ctn. Code #	25' (7.6m) R/O Ctn. Code #
5/8"	15.9	3	76.2	28	15	16-148-0580W	16-148-0586W	—
3/4"	19.1	3	76.2	28	20	16-148-0340W	16-148-0346W	—
1"	25.4	3	76.2	28	27	16-148-1000W	16-148-1006W ①	—
1 1/8"	28.6	4	101.6	28	29	16-148-1180W	16-148-1186W	—
1 1/4"	31.8	4	101.6	28	31	16-148-1140W	16-148-1146W	—
1 1/2"	38.1	5	127.0	28	40	16-148-1120W	16-148-1126W ①	16-148-1125W

① **WARNING:** Lines containing raw sewage should be plumbed to be self-draining.

SHIELDS LIVEWELL HOSE



Shields Livewell Hose has a black smooth cover with vinyl helix. It is rated for full vacuum and is resistant to mild chemicals and saltwater. This hose is primarily used for bilge pump intake and discharge, drains (sinks, shower, and scupper), livewell intake and drain, and sanitation (intake and vent). This hose is utilized for below the waterline connections. **Do not use ethylene glycol based antifreeze in hose.**

I.D.	mm	Bend Radius	mm	Vac Rating	Wt. "C"	Bulk Pack 100' (30.5m) Coil Code #	Dist. Pkg. 50' (15.2m) R/O Ctn. Code #
5/8"	15.9	3	76.2	28	15	16-149-0580	16-149-0586
3/4"	19.1	3	76.2	28	16	16-149-0340	16-149-0346
1"	25.4	3	76.2	28	24	16-149-1000	16-149-1006
1 1/8"	28.6	4	101.6	28	25	16-149-1180	16-149-1186
1 1/4"	31.8	4	101.6	28	28	16-149-1140	16-149-1146
1 1/2"	38.1	5	127.0	28	39	16-149-1120	16-149-1126

SHIELDS 1300/1350 WATER/HEATER HOSE



Shields 1300/1350 Water/Heater Hose is fabric reinforced and has an EPDM tube and cover. This hose is primarily used for engine heater hose, heat exchanger, A/C circulation, and drain lines (sink, icebox, shower and livewell). It is resistant to mild chemicals, heat, cold, ozone and saltwater. The temperature ranges from -40°F – +212°F.

SHIELDS 1300 Water/Heater Hose

I.D.	mm	O.D.	mm	Working Pressure	Wt. "C"	Bulk Pack Code #	m	Bulk Pack 50' (15.2m) R/O Ctn. Code #	Dist. Pkg. 25' (7.6m) R/O Ctn. Code #
1/2"	12.7	3/4"	18.69	62 PSI	17	16-130-0120 (500' reel)	152.4	16-130-0126	—
5/8"	15.9	7/8"	22.3	62 PSI	21	16-130-0580 (500' reel)	152.4	16-130-0586	16-130-0585
3/4"	19.1	1"	25.48	50 PSI	26	16-130-0340 (500' reel)	152.4	16-130-0346	16-130-0345

SHIELDS 1350 HEAVY DUTY Water/Heater Hose

I.D.	mm	O.D.	mm	Working Pressure	Wt. "C"	Bulk Pack Code #	m	Dist. Pkg. 50' (15.2m) R/O Ctn. Code #
1/2"	12.7	13/16"	20.6	200 PSI	19	16-135-0120 (550' reel)	167.6	16-135-0126
5/8"	15.9	31/32"	24.59	200 PSI	26	16-135-0580 (450' reel)	137.2	16-135-0586
3/4"	19.1	1 1/64"	28.4	200 PSI	33	16-135-0340 (400' reel)	121.9	16-135-0346
1"	25.4	1 3/64"	36.6	150 PSI	52	16-135-1000 (300' reel)	91.4	16-135-1006

SHIELDS 1600 WATER/HEATER HOSE

Shields 1600 Water/Heater Hose has a good bend radius, is fabric reinforced, and has an EPDM tube and cover. This hose is primarily used for critical water connections, heat exchanger, toilet intake, small engine intake, bilge pump intake/discharge, and below water line drains and scuppers. It is resistant to mild chemicals, heat, cold, ozone and saltwater. The temperature ranges from -40°F – +190°F



I.D.	mm	O.D.	mm	Working Pressure	Wt. "C"	Bulk Pack Code #	m	Dist. Pkg. 50' (15.2m) R/O Ctn. Code #
3/8"	9.5	45/64"	17.8	250 PSI	17	16-160-0380B (500' reel)	152.4	16-160-0386B
1/2"	12.7	27/32"	21.3	250 PSI	22	16-160-0120B (450' reel)	137.2	16-160-0126B
5/8"	15.9	1"	25.4	250 PSI	28	16-160-0580B (400' reel)	121.9	16-160-0586B
3/4"	19.1	1 3/64"	28.8	250 PSI	34	16-160-0340B (300' reel)	91.4	16-160-0346B
1"	25.4	1 29/64"	36.8	200 PSI	52	16-160-1000B (250' reel)	76.2	16-160-1006B
1 1/4"	31.8	1 3/4"	44.5	200 PSI	62	16-160-1140B (200' reel)	61.0	16-160-1146B

SHIELDS MARINE EXHAUST/WATER HOSE (No Wire)



Shields Marine Exhaust / Water Hose is reinforced with 2 or 4 plies of synthetic cord and is made of black, heavy-walled synthetic rubber. This hose is primarily used for straight connections in wet exhaust systems and engine water circulation lines. It is resistant to engine heat, exhaust fumes, ozone, mild chemicals, antifreeze and saltwater. This hose also has double the ozone resistance required by SAEJ2006. The temperature ranges from -20°F – + 200°F continuous, +250°F intermittent. The hose meets SAE J2006 Type R1 standards.



This certification provides unbiased, third party confirmation worldwide that these Shields hoses meet the highest standards of production quality. Certification ensures the proper level of product safety and inspires user confidence.

Now double the ozone resistance required by SAEJ2006

I.D.	mm	O.D.	Ply	Wt. "C"	50' Coil Code #	12 1/2' Length Code #	6 1/4' Length Code #
1/2"	13	7/8"	2	24	16-200-0120	16-200-0124	16-200-0121
5/8"	16	1 1/32"	2	33	16-200-0580	16-200-0584	16-200-0581
3/4"	19	1 9/64"	2	37	16-200-0340	16-200-0344	16-200-0341
7/8"	22	1 17/64"	2	42	16-200-0780	16-200-0784	16-200-0781
1"	25	1 3/8"	2	48	16-200-1000	16-200-1004	16-200-1001
1 1/8"	28	1 1/2"	2	52	16-200-1180	16-200-1184	16-200-1181
1 1/4"	32	1 45/64"	2	60	16-200-1140	16-200-1144	16-200-1141
1 5/16"	33	1 47/64"	2	62	16-200-1560	16-200-1564	16-200-1561
1 3/8"	35	1 13/16"	2	66	16-200-1380	16-200-1384	16-200-1381
1 1/2"	38	1 15/16"	2	70	16-200-1120	16-200-1124	16-200-1121
1 5/8"	42	2 3/32"	2	77	16-200-1580	16-200-1584	16-200-1581
1 3/4"	45	2 13/64"	2	82	16-200-1340	16-200-1344	16-200-1341
1 7/8"	48	2 23/64"	2	96	16-200-1780	16-200-1784	16-200-1781
2"	51	2 31/64"	2	102	16-200-2000	16-200-2004	16-200-2001
2 1/8"	54	2 19/32"	2	107	16-200-2180	16-200-2184	16-200-2181
2 1/4"	58	2 3/4"	2	114	16-200-2140	16-200-2144	16-200-2141
2 3/8"	60	2 7/8"	2	132	16-200-2380	16-200-2384	—
2 1/2"	63	3"	2	136	16-200-2120	16-200-2124	16-200-2121
2 5/8"	67	3 3/32"	2	147	—	16-200-2584	16-200-2581
2 3/4"	70	3 17/64"	2	152	—	16-200-2344	16-200-2341
2 7/8"	73	3 7/16"	2	174	16-200-2780	16-200-2784	16-200-2781
3"	76	3 9/16"	2	182	16-200-3000	16-200-3004	16-200-3001
3 1/8"	80	3 45/64"	2	190	—	16-200-3184	16-200-3181
3 1/2"	90	4 3/32"	2	198	—	16-200-3124	16-200-3121
3 3/4"	95	4 9/32"	2	221	—	16-200-3344	16-200-3341
4"	102	4 17/32"	4	229	—	16-200-4004	16-200-4001
4 1/2"	114	5 1/8"	2	300	—	16-200-4124	16-200-4121
5"	127	5 5/8"	2	332	—	16-200-5004	16-200-5001
5 1/2"	140	6 3/16"	2	396	—	16-200-5124	16-200-5121
6"	152	6 11/16"	2	427	—	16-200-6004	16-200-6001
8"	203	8 25/32"	4	670	—	16-200-8004	—
10"	254	10 7/8"	4	934	—	16-200-10004	—
12"	305	12 7/8"	4	1095	—	16-200-12004	—
14"	350	14 7/8"	4	1430	—	16-200-14004*	—

* Special Order

SHIELDS NAUTIFLEX SILICONE EXHAUST HOSE



Shields Nautiflex Silicone Exhaust Hose has a blue silicone cover with a smooth finish for easy clean up. This hose is flexible, easy to install and has four plies of synthetic fabric. It also remains stable at elevated temperatures. This hose is primarily used for straight connections in the wet exhaust system and engine water circulation lines. The temperature ranges from -20°F – $+350^{\circ}\text{F}$. The hose meets SAE J2006 Type R1 and ISO 13363:2004 – Type 2 – Class B standards.

I.D.	mm	O.D.	Wt. "C"	3' (.9m) Length Code No.	6' (1.8m) Length Code No.	12' (3.7m) Length Code No.
1"	25	1 $\frac{3}{8}$ "	33.1	16-202-1000-36	16-202-1001	16-202-1004
1 $\frac{1}{8}$ "	28	1 $\frac{1}{2}$ "	37.2	16-202-1180-36	16-202-1181	—
1 $\frac{1}{4}$ "	32	1 $\frac{5}{8}$ "	41.3	16-202-1140-36	16-202-1141	16-202-1144
1 $\frac{3}{8}$ "	35	1 $\frac{3}{4}$ "	45.4	16-202-1380-36	16-202-1381	—
1 $\frac{1}{2}$ "	38	1 $\frac{7}{8}$ "	49.6	16-202-1120-36	16-202-1121	16-202-1124
1 $\frac{3}{4}$ "	45	2 $\frac{1}{8}$ "	57.8	16-202-1340-36	16-202-1341	—
2"	51	2 $\frac{3}{8}$ "	66.1	16-202-2000-36	16-202-2001	16-202-2004
2 $\frac{3}{8}$ "	60	2 $\frac{3}{4}$ "	78.5	16-202-2380-36	16-202-2381	16-202-2384
2 $\frac{1}{2}$ "	63	2 $\frac{7}{8}$ "	82.6	16-202-2120-36	16-202-2121	16-202-2124
2 $\frac{5}{8}$ "	67	2 $\frac{63}{64}$ "	86.8	16-202-2580-36	16-202-2581	16-202-2584
2 $\frac{3}{4}$ "	70	3 $\frac{1}{8}$ "	90.9	16-202-2340-36	16-202-2341	—
2 $\frac{7}{8}$ "	73	3 $\frac{1}{4}$ "	94.1	16-202-2780-36	16-202-2781	—
3"	76	3 $\frac{3}{8}$ "	99.2	16-202-3000-36	16-202-3001	16-202-3004
3 $\frac{1}{4}$ "	82	3 $\frac{1}{2}$ "	103.4	16-202-3140-36	16-202-3141	16-202-3144
3 $\frac{1}{2}$ "	90	3 $\frac{7}{8}$ "	115.7	16-202-3120-36	16-202-3121	16-202-3124
4"	102	4 $\frac{3}{8}$ "	132	16-202-4000-36	16-202-4001	16-202-4004
5"	127	5 $\frac{3}{8}$ "	165	16-202-5000-36	16-202-5001	16-202-5004
5 $\frac{1}{2}$ "	140	5 $\frac{7}{8}$ "	181.5	16-202-5120-36	—	—
6"	152	6 $\frac{3}{8}$ "	198	16-202-6000-36	16-202-6001	16-202-6004
8"	203	8 $\frac{3}{8}$ "	264	16-202-8000-36	—	—
10"	254	10 $\frac{3}{8}$ "	330	16-202-10000-36	—	—
12"	305	12 $\frac{3}{8}$ "	396	16-202-12000-36	—	—
14"	350	14 $\frac{5}{8}$ "	462	16-202-14000-36	—	—



SHIELDSFLEX II MARINE WATER/EXHAUST HOSE (w/ Wire)

Shieldsflex II Marine Water/Exhaust Hose has a black synthetic rubber tube and cover. It is reinforced with wire helix imbedded between plies of HD synthetic cord. It is resistant to exhaust fumes, ozone, mild chemicals, antifreeze and saltwater. This hose is abrasion and odor permeation resistant. It now has double the ozone resistance required by the SAEJ2006. Shieldsflex II is primarily used for engine intake, wet exhaust connections (use where bends or long lengths are required), bilge pump intake/discharge, scupper lines, toilet intake/discharge, and holding tank vent/pump out. The temperature ranges from -20° F – +200°F continuous, +250°F intermittent. The hose meets SAE J2006 Type R2 standards.

I.D.	mm	O.D.	Ply	Wt. "C"	50' (15.2m) Coil Code #	25' (7.6m) Cartons	12 1/2' (3.8m) Length Code #	6 1/4' (1.9m) Length Code #
1/2"	13	27/32"	2	24	16-250-0120	16-250-0125	16-250-0124	16-250-0121
5/8"	16	61/64"	2	28	16-250-0580	16-250-0585	16-250-0584	16-250-0581
3/4"	19	1 1/16"	2	32	16-250-0340	16-250-0345	16-250-0344	16-250-0341
7/8"	22	1 3/16"	2	36	16-250-0780	16-250-0785	16-250-0784	16-250-0781
1"	25	1 5/16"	2	40	16-250-1000	16-250-1005	16-250-1004	16-250-1001
1 1/8"	28	1 7/16"	2	44	16-250-1180	16-250-1185	16-250-1184	16-250-1181
1 1/4"	32	1 19/32"	2	50	16-250-1140	16-250-1145	16-250-1144	16-250-1141
1 5/16"	33	1 5/8"	2	51	16-250-1560	—	16-250-1564	16-250-1561
1 3/8"	35	1 23/32"	2	58	16-250-1380	16-250-1385	16-250-1384	16-250-1381
1 1/2"	38	1 53/64"	2	62	16-250-1120	16-250-1125	16-250-1124	16-250-1121
1 5/8"	42	2"	2	80	16-250-1580	—	16-250-1584	16-250-1581
1 3/4"	45	2 1/8"	2	88	16-250-1340	—	16-250-1344	16-250-1341
1 7/8"	48	2 19/64"	2	93	16-250-1780	—	16-250-1784	16-250-1781
2"	51	2 13/32"	2	99	16-250-2000	—	16-250-2004	16-250-2001
2 1/8"	54	2 17/32"	2	107	16-250-2180	—	16-250-2184	16-250-2181
2 1/4"	58	2 11/16"	2	127	16-250-2140	—	16-250-2144	16-250-2141
2 3/8"	60	2 3/4"	2	132	16-250-2380	—	16-250-2384	16-250-2381
2 1/2"	63	2 7/8"	2	137	16-250-2120	—	16-250-2124	16-250-2121
2 5/8"	67	3 1/16"	2	147	—	—	16-250-2584	16-250-2581
2 3/4"	70	3 3/16"	2	164	16-250-2340	—	16-250-2344	16-250-2341
2 7/8"	73	3 5/16"	2	170	16-250-2780	—	16-250-2784	16-250-2781
3"	76	3 7/16"	2	177	16-250-3000	—	16-250-3004	16-250-3001
3 1/8"	80	3 5/8"	2	200	16-250-3180	—	16-250-3184	16-250-3181
3 1/2"	90	4"	2	223	16-250-3120	—	16-250-3124	16-250-3121
4"	102	4 5/8"	2	269	16-250-4000	—	16-250-4004	16-250-4001
4 1/8"	105	4 47/64"	2	276	—	—	—	—
4 1/2"	114	5 3/32"	2	319	16-250-4120	—	16-250-4124	16-250-4121
5"	127	5 5/8"	2	398	16-250-5000	—	16-250-5004	16-250-5001
5 1/8"	130	5 3/4"	2	417	—	—	—	—
5 1/2"	140	6 3/16"	2	443	—	—	—	—
6"	152	6 21/32"	2	482	—	—	16-250-6004	16-250-6001
8"	203	8 25/32"	2	780	—	—	16-250-8004	—



Now double the ozone resistance required by SAEJ2006



This certification provides unbiased, third party confirmation worldwide that these Shields hoses meet the highest standards of production quality. Certification ensures the proper level of product safety and inspires user confidence.

SHIELDSAUST-C

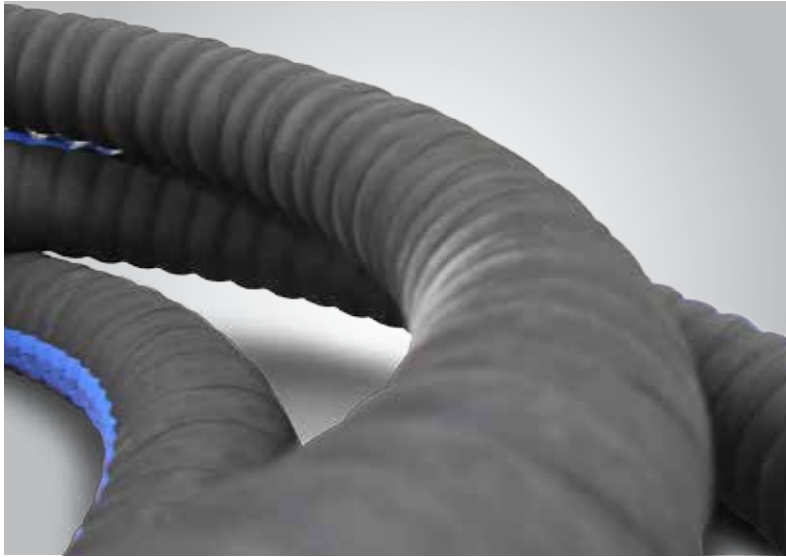

Now double the ozone resistance required by SAEJ2006

Shieldsaust – C Hose has a black synthetic rubber tube and cover. It is reinforced with double wire helix imbedded between plies of synthetic cord and is abrasion resistant. It is resistant to exhaust fumes, ozone, mild chemicals, antifreeze, and saltwater. This hose is primarily used for wet exhaust connections with significant bends, engine intake and scupper lines. The temperature ranges from -20°F to +200°F continuous, +250°F intermittent. The hose now has double the ozone resistance required by SAEJ2006. This hose meets SAE J2006 Type R2 standards.

I.D.	mm	O.D.	Ply	Wt. "C"	50' (15.2m) Coil Code #	12 1/2' (3.8m) Length Code #	6 1/4' (1.9m) Length Code #
3/4"	19	1 1/8"	2	27	16-252-0340	16-252-0344	16-252-0341
1"	25	1 11/32"	2	33	16-252-1000	16-252-1004	16-252-1001
1 1/4"	32	1 39/64"	2	45	16-252-1140	16-252-1144	16-252-1141
1 1/2"	38	1 15/16"	2	70	16-252-1120	16-252-1124	16-252-1121
1 5/8"	42	2 3/32"	2	80	16-252-1580	16-252-1584	16-252-1581
1 3/4"	45	2 7/32"	2	85	16-252-1340	16-252-1344	16-252-1341
1 7/8"	48	2 21/64"	2	91	16-252-1780	16-252-1784	16-252-1781
2"	51	2 7/16"	2	95	16-252-2000	16-252-2004	16-252-2001
2 1/8"	54	2 9/16"	2	100	—	16-252-2184	—
2 1/4"	58	2 23/32"	2	107	16-252-2140	16-252-2144	16-252-2141
2 3/8"	60	2 51/64"	2	110	16-252-2380	16-252-2384	16-252-2381
2 1/2"	63	2 59/64"	2	115	16-252-2120	16-252-2124	16-252-2121
2 3/4"	70	3 3/16"	2	126	16-252-2340	16-252-2344	16-252-2341
2 7/8"	73	3 5/16"	2	137	16-252-2780	16-252-2784	16-252-2781
3"	76	3 7/16"	2	143	16-252-3000	16-252-3004	16-252-3001
3 1/8"	80	3 19/32"	2	150	16-252-3180	16-252-3184	16-252-3181
3 1/2"	90	4 1/16"	2	200	16-252-3120	16-252-3124	16-252-3121
4"	102	4 9/16"	2	231	16-252-4000	16-252-4004	16-252-4001
4 1/8"	105	4 11/16"	2	238	—	16-252-4184	16-252-4181
4 1/2"	114	5 1/8"	2	278	—	16-252-4124	16-252-4121
5"	127	5 9/16"	2	300	16-252-5000	16-252-5004	16-252-5001
6"	152	6 9/16"	2	394	16-252-6000	16-252-6004	16-252-6001
8"	203	8 11/16"	2	607	—	16-252-8004	16-252-8001



This certification provides unbiased, third party confirmation worldwide that these Shields hoses meet the highest standards of production quality. Certification ensures the proper level of product safety and inspires user confidence.

SHIELDS NAUTIFLEX CORRUGATED SILICONE EXHAUST HOSE



Shields Nautiflex Corrugated Silicone

Exhaust Hose has a blue silicone tube and cover with a smooth finish for easy cleaning. The hose is wire reinforced and will not collapse under suction or in a bend. The corrugated cover allows the hose to bend for easy installation. The Nautiflex, two ply construction, has wire captured between fabric plies. This hose is primarily used for main engine exhaust, generator exhaust, engine coolant circulation, engine intake and generator intake. It is resistant to exhaust fumes, ozone, mild chemicals, antifreeze and saltwater. The hose remains stable at elevated temperatures. The temperatures ranges from -20°F – +350°F. This hose meets SAEJ2006 Type R2 and ISO 13362:2004 – Type 1 – Class B standards.

ID	mm	OD	WT "C"	10' (3.1m) length Code No.	12 1/2' (3.8m) Length Code No.	50' (15.2m) coil Code No.
3/4"	19	1 3/8"	34	—	16-262-0344	16-262-0340
1"	25	1 27/64"	42	—	16-262-1004	16-262-1000
1 1/8"	28	1 1/2"	46	—	16-262-1184	16-262-1180
1 1/4"	32	1 45/64"	52	—	16-262-1144	16-262-1140
1 3/8"	35	1 55/64"	60	—	16-262-1384	16-262-1380
1 1/2"	38	2"	71	—	16-262-1124	16-262-1120
1 5/8"	42	2 11/64"	74	—	16-262-1584	16-262-1580
1 3/4"	45	2 19/64"	78	—	16-262-1344	16-262-1340
1 7/8"	48	2 13/32"	82	—	16-262-1784	16-262-1780
2"	51	2 17/32"	87	—	16-262-2004	16-262-2000
2 1/8"	54	2 5/8"	94	—	16-262-2184	—
2 3/8"	60	2 7/8"	101	—	16-262-2384	16-262-2380
2 1/2"	63	3 3/64"	113	—	16-262-2124	16-262-2120
2 7/8"	73	3 7/16"	134	—	16-262-2784	16-262-2780
3"	76	3 35/64"	139	—	16-262-3004	16-262-3000
3 1/2"	90	4 19/64"	227	—	16-262-3124	16-262-3120
4"	102	4 49/64"	255	—	16-262-4004	16-262-4000
5"	127	5 3/4"	310	16-262-5003	—	16-262-5000
6"	152	6 15/16"	484	16-262-6003	—	—
8"	203	9 7/64"	768	16-262-8003	—	—
10"	254	11 17/64"	1136	16-262-10003	—	—

* Special Order

SHIELDS MULTIFLEX



Shields Multiflex Hose has a clear FDA formula PVC with black vinyl helix. It is abrasion resistant, flexible and is resistant to mild chemicals and saltwater. This hose is primarily used for bilge pump discharge, potable water tank fill and drains (sinks, shower, livewell and scupper). This hose uses 147 right hand thread cuffs. **Do not attach to thru hull fitting below the water line. Do not use ethylene glycol based antifreeze in hose.**

I.D.	mm	Bend Radius	mm	Wt. "C"	Bulk Pack 100' (30.5m) Coil Code #	Dist. Pkg. 50' (15.2m) R/O Ctn. Code #	10' (3.1m) Length Code #
5/8"	15.9	1/2"	12.7	8	16-141-0580B	16-141-0586B	
3/4"	19.1	3/4"	19.1	10	16-141-0340B	16-141-0346B	
1"	25.4	7/8"	22.2	13	16-141-1000B	16-141-1006B	
1 1/8"	28.6	1"	25.4	16	16-141-1180B	16-141-1186B	
1 1/4"	31.8	1 1/2"	38.1	19	16-141-1140B	16-141-1146B	
1 1/2"	38.1	2"	50.8	24	16-141-1120B	16-141-1126B	
2"	50.8	5"	127.0	34	16-141-2000B	-	16-141-2003B
1 1/2"	38.1	2"	50.8	24	16-141-1120W	-	16-141-1123W

SHIELDS VAC EXTRA HEAVY DUTY/FDA

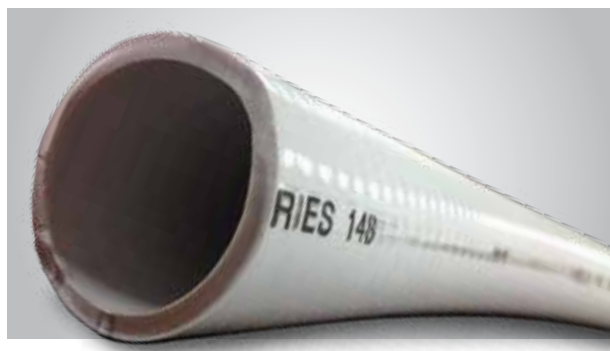

Shields Vac Extra Heavy Duty/FDA Hose has a smooth white FDA grade PVC with vinyl helix. It is rated for full vacuum and is resistant to mild chemicals, permeation, and saltwater. This hose is primarily used for bilge pump intake and discharge, drains (sinks, shower, and scupper), livewell intake and drain, potable water tank fill, and sanitation (toilet to holding tank, intake, self draining lines vent and pump out). This hose is resistant to odor permeation. **Do not use ethylene glycol based antifreeze in hose. Do not use in pressurized water systems.**

I.D.	mm	Bend Radius	mm	Vac Rating	Wt. "C"	Bulk Pack 100' (30.5m) Coil Code #	Dist. Pkg. 50' (15.2m) R/O Ctn. Code #	25' (7.6m) R/O Ctn. Code #
5/8"	15.9	3	76.2	28	15	16-148-0580W	16-148-0586W	—
3/4"	19.1	3	76.2	28	20	16-148-0340W	16-148-0346W	—
1"	25.4	3	76.2	28	27	16-148-1000W	16-148-1006W ①	—
1 1/8"	28.6	4	101.6	28	29	16-148-1180W	16-148-1186W	—
1 1/4"	31.8	4	101.6	28	31	16-148-1140W	16-148-1146W	—
1 1/2"	38.1	5	127.0	28	40	16-148-1120W	16-148-1126W ①	16-148-1125W

① **WARNING:** Lines containing raw sewage should be plumbed to be self-draining.

SHIELDS LIVEWELL HOSE



Shields Livewell Hose has a black smooth cover with vinyl helix. It is rated for full vacuum and is resistant to mild chemicals and saltwater. This hose is primarily used for bilge pump intake and discharge, drains (sinks, shower, and scupper), livewell intake and drain, and sanitation (intake and vent). This hose is utilized for below the waterline connections. **Do not use ethylene glycol based antifreeze in hose. Not for potable water.**

I.D.	mm	Bend Radius	mm	Vac Rating	Wt. "C"	Bulk Pack 100' (30.5m) Coil Code #	Dist. Pkg. 50' (15.2m) R/O Ctn. Code #
5/8"	15.9	3	76.2	28	15	16-149-0580	16-149-0586
3/4"	19.1	3	76.2	28	16	16-149-0340	16-149-0346
1"	25.4	3	76.2	28	24	16-149-1000	16-149-1006
1 1/8"	28.6	4	101.6	28	25	16-149-1180	16-149-1186
1 1/4"	31.8	4	101.6	28	28	16-149-1140	16-149-1146
1 1/2"	38.1	5	127.0	28	39	16-149-1120	16-149-1126

SHIELDS PVC TUBING - CLEAR

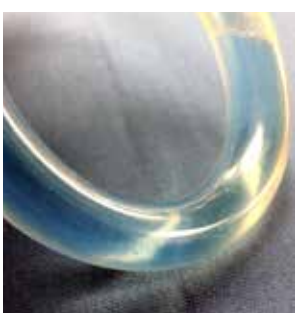
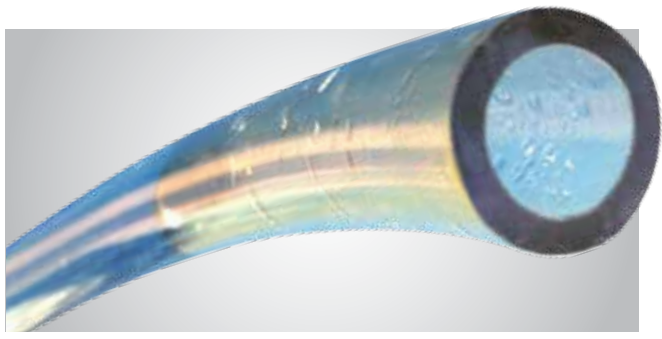

Shields Clear PVC Tubing has a single layer FDA formula vinyl. This hose is primarily used for non-pressurized potable water system supply and drain lines (sink, shower, icebox). This hose is NOT for use in hot water or pressurized water systems.

I.D.	mm	Wall	mm	Burst Pressure 70°	Wt. "C"	Code #	Bulk Pack	mm	100' (30.5m) R/O Ctn. Code #	Dist. Pkg. 50' (15.2m) R/O Ctn. Code #	25' (7.6m) Polypac Code #
3/16"	4.8	.062	1.6	65#	3	16-150-0360	750'	228.6	—	16-150-0366	16-150-0365
1/4"	6.4	.078	2.0	60#	4	16-150-0140	500'	152.4	16-150-0147	16-150-0146	16-150-0145
5/16"	7.9	.093	2.4	55#	5	16-150-0560	200'	61.0	16-150-0567	16-150-0566	16-150-0565
3/8"	9.5	.094	2.4	55#	6	16-150-0380	200'	61.0	—	16-150-0386	16-150-0385
1/2"	12.7	.11	2.8	45#	12	16-150-0120	200'	61.0	16-150-0127	16-150-0126	16-150-0125
5/8"	15.9	.11	2.8	40#	15	16-150-0580	200'	61.0	16-150-0587	16-150-0586	16-150-0585
3/4"	19.1	.11	2.8	35#	19	16-150-0340	200'	61.0	16-150-0347	16-150-0346	16-150-0345
1"	25.4	.125	3.2	20#	27	16-150-1000	100'	30.5	16-150-1007	16-150-1006	16-150-1005
1 1/8"	28.6	.125	3.2	20#	29	16-150-1180	100'	30.5	—	16-150-1186	—
1 1/4"	31.8	.125	3.2	20#	31	16-150-1140	100'	30.5	—	16-150-1146	16-150-1145
1 1/2"	38.1	.125	3.2	20#	34	16-150-1120	50'	15.2	—	16-150-1126	16-150-1125

SHIELDS ALL CLEAR PVC TUBING POLYESTER REINFORCED (Red-Tracer)



Shields Clear Polyester Reinforced Red Tracer PVC Tubing has a clear heavy wall FDA formula vinyl. It has a polyester braid reinforcement and 250 PSI burst pressure. This hose is primarily used for pressurized water system supply (hot or cold), drain lines (sink, shower, icebox), wash down pump connections and head intake.



I.D.	mm	O.D.	mm	Burst Pressure	Wt. "C"	Bulk Pack 250' (76.2m) Coil Code #	Dist. Pkg. 50' (15.2m) R/O Ctn. Code #	25' (7.6m) Polypac Code #	10' (3.1m) Polypac Code #
3/8"	9.5	9/16"	14.3	250#	7	16-162-0380	16-162-0386	16-162-0385	16-162-0383
1/2"	12.7	23/32"	18.3	250#	11	16-162-0120	16-162-0126	16-162-0125	16-162-0123
5/8"	15.9	27/32"	21.4	250#	14	16-162-0580	16-162-0586	16-162-0585	16-162-0583
3/4"	19.1	31/32"	24.6	250#	17	16-162-0340	16-162-0346	16-162-0345	16-162-0343
1"	25.4	1 5/16"	33.3	250#	24	16-162-1000	16-162-1006	16-162-1005	16-162-1003
1 1/8"	28.6	1 3/8"	34.9	250#	32	16-162-1180 ①	16-162-1186	—	—
1 1/4"	31.8	1 5/8"	41.3	250#	44	16-162-1140 ①	16-162-1146	—	—
1 1/2"	38.1	1 15/16"	49.2	250#	67	16-162-1120 ①	16-162-1126	—	—

① 100' roll

SHIELDS BRAIDED WASH DOWN HOSE

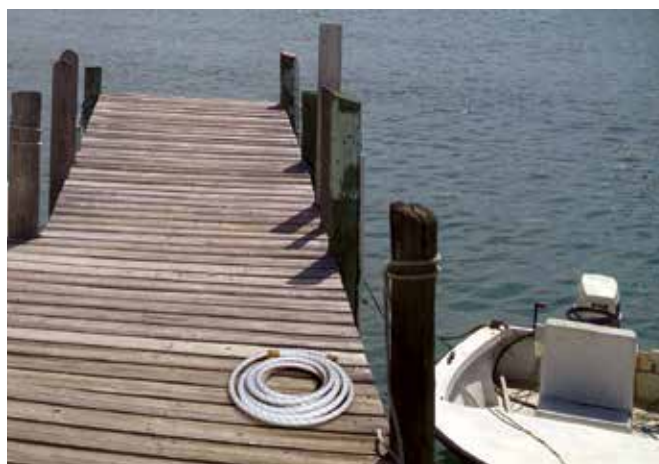

Shields Braided Wash Down Hose has a white FDA formula vinyl tube and clear vinyl cover. It has a polyester braid reinforcement and a 250 PSI burst pressure. This hose has brass ends, is lightweight and easy to handle. This hose is primarily used for dockside wash down and is safe for potable water.

I.D.	mm	Length	mm	Bulk Pack	Wt.	Code No.
5/8"	15.9	25'	7.6	5	3.25	16-163-0585
5/8"	15.9	50'	15.2	5	6.50	16-163-0586
5/8"	15.9	75'	22.9	5	9.75	16-163-0588
5/8"	15.9	100'	30.5	5	13.00	16-163-0587

SHIELDS CLEAR WHITE PVC TUBING POLYESTER REINFORCED (Blue-Tracer)

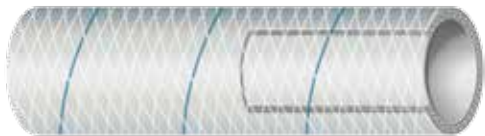

Clear White Blue Tracer PVC Tubing has a white FDA formula vinyl tube. It has a clear vinyl cover, polyester braid reinforcement and 250 PSI burst pressure. This hose is primarily used for pressurized water system supply (hot or cold), drain lines (sink, shower, icebox), wash down pump connections and head intake.



I.D.	mm	O.D.	mm	Burst Pressure	Wt. "C"	Bulk Pack 250' (76.2m) Coil Code #	50' (15.2m) R/O Ctn. Code #	Dist. Pkg. 25' (7.6m) Polypac Code #	10' (3.1m) Polypac Code #
1/2"	12.7	1 1/16"	17.5	250#	10	16-164-0120	16-164-0126	16-164-0125	16-164-0123
5/8"	15.9	1 3/16"	20.6	250#	13	16-164-0580	16-164-0586	16-164-0585	16-164-0583
3/4"	19.1	1 5/16"	23.8	250#	17	16-164-0340	16-164-0346	16-164-0345	16-164-0343

SHIELDS HEAVY DUTY POLYESTER REINFORCED PVC TUBING

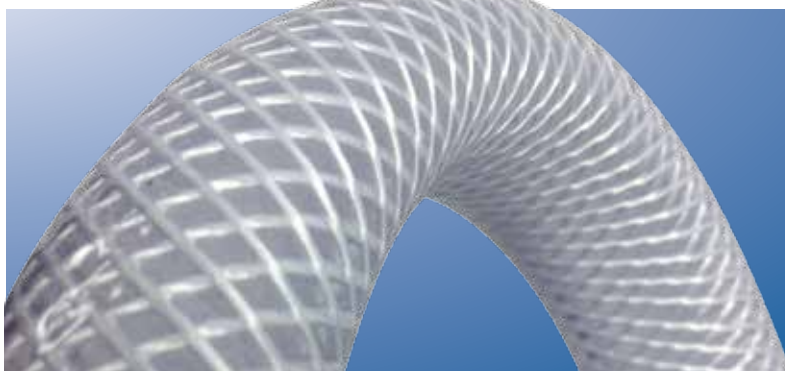
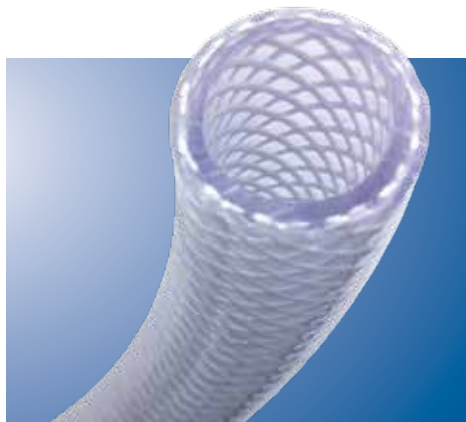

Shields Heavy-Duty Polyester Reinforced PVC Tubing has a clear extra heavy wall FDA formula vinyl. It has superior kink resistance and a polyester braid reinforcement. This hose is primarily used for pressurized water system supply (hot or cold), wash down pump connections and head intake.

I.D.	mm	O.D.	mm	Burst Pressure	Wt. "C"	Code #	Bulk Pack	Dist. Pkg. 50' (15.2m) R/O Ctn. Code #
1/4"	6.4	7/16"	11.1	750#	5.6	16-168-0140	300'	16-168-0146
3/8"	9.5	19/32"	15.1	750#	9.2	16-168-0380	300'	16-168-0386
1/2"	12.7	3/4"	19.1	600#	13.5	16-168-0120	300'	16-168-0126
5/8"	15.9	7/8"	22.2	600#	16.2	16-168-0580	300'	16-168-0586
3/4"	19.1	1 1/64"	25.8	450#	21.1	16-168-0340	300'	16-168-0346
1"	25.4	1 5/16"	33.3	325#	31.2	16-168-1000	200'	16-168-1006
1 1/4"	31.8	1 21/32"	42.1	300#	51	16-168-1140	100'	16-168-1146
1 1/2"	38.1	1 15/16"	49.2	300#	65	16-168-1120	100'	16-168-1126

SHIELDS OIL TANK FILL HOSE

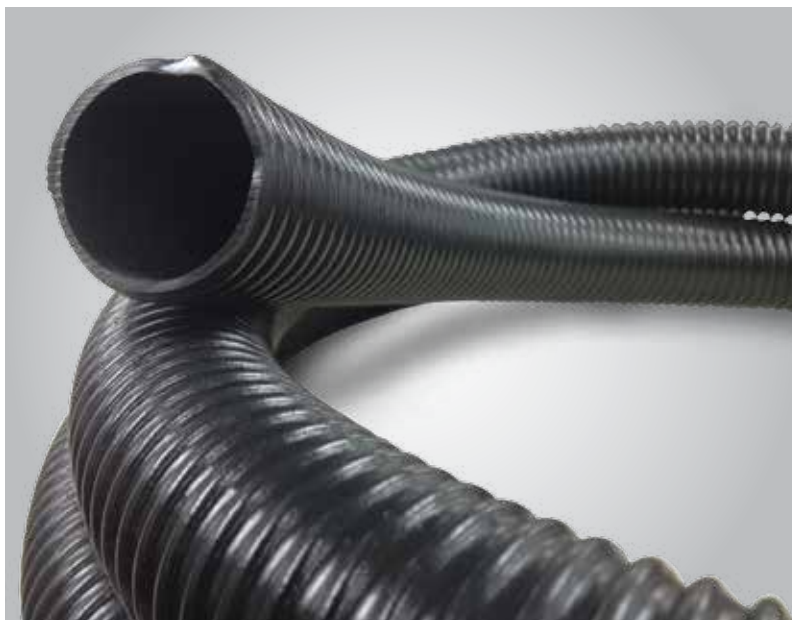

Shields Oil Tank Fill Hose has a nitrile/PVC blend for excellent oil resistance. It has a flexible corrugated design, smooth bore and a vinyl helix to prevent collapse. It also resists ozone and cold temperature cracking. This hose is primarily used for 2-cycle oil tank fill.

I.D.	mm	Bend Radius	mm	Wt "C"	Bulk Pack 100' (30.5m) Coils Code #	Dist. Pkg. 50" (15.2m) R/O Ctn. Code #	10' (3.1m) Ctn Code #
1 1/2"	38.1	4"	101.6	22	16-309-1120	16-309-1126	16-309-1123

SHIELDS SILVERADO 2000 FUEL VENT LINE



Silverado 2000 Fuel Vent Line is primarily used for fuel tank vent (outside the engine compartment) and is for pleasure boats only. The Temperature range is -5 F to +180 F. It meets SAE J1527 Type A2 standards.



I.D.	mm	O.D.	mm	Ply	Burst Pressure	Wt. "C"	Bulk Pack Code #	50' (15.2m) R/O Ctn. Code #	Dist. Pkg. 25' (7.6m) R/O Ctn. Code #	10' (3.1m) Polypac Code #
5/8"	15.9	29/32"	23.0	2	175#	24.0	16-315-0580 (250' reel)	16-315-0586	16-315-0585	16-315-0583

SHIELDS SILVERADO 4000 OUTBOARD FUEL LINE

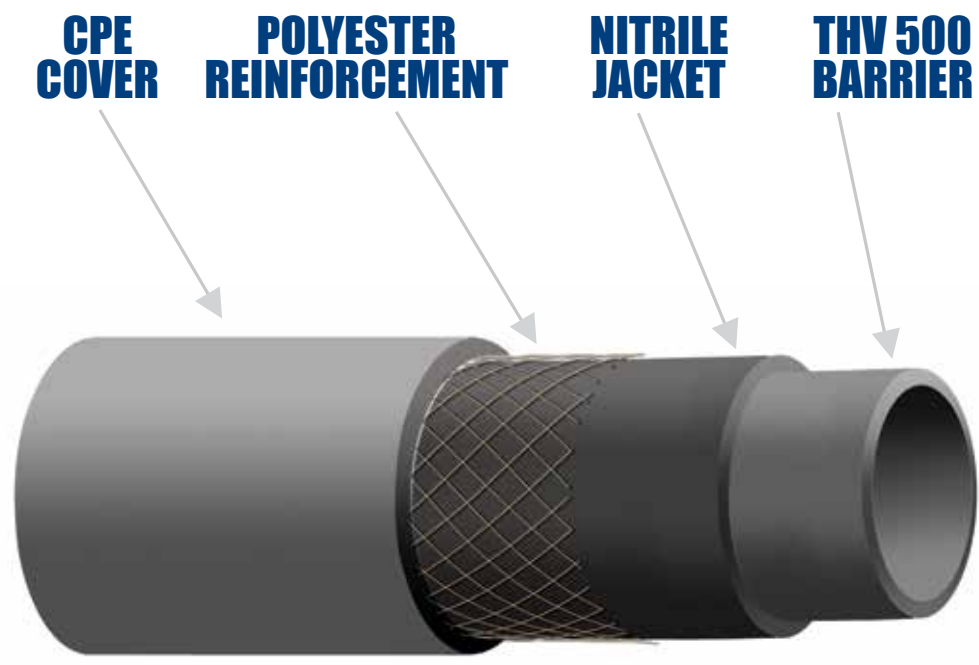

CONSTRUCTION

The series 337 fuel lines (Silverado 4000) is the best B1 fuel line in the market place. Utilizing a complex construction technique involving a THV500 barrier layer, a Nitrile jacket, Polyester reinforcement and a CPE cover; we are able to offer a hose that outperforms all competitors. The Silverado 4000 hose has a small O.D., is extremely flexible and easy to clamp. Not only does the Silverado 4000 meet all requirements it has become the only fuel line worthy to be utilized in Sierra’s fuel line assemblies.



Silverado 4000 Outboard Fuel Line is resistant to ethanol blended fuels. This hose is EPA and CARB compliant. Silverado 4000 has a THV barrier layer to prevent permeation, polyester reinforcement for strength and a weather and UV resistant CPE cover. The gray color keeps hose cooler and helps prevent vapor lock. This hose is for above deck primer bulb applications, and is not fire retardant.



Meets SAE J1527 Type B1-15

I.D.	mm	O.D.	mm	Wt. "C"	Bulk Pack Code #	50' (15.2m) R/O Ctn. Code #	Dist. Pkg. 25' (7.6m) R/O Ctn. Code #	10' (3.1m) Polypac Code #
5/16"	7.9	1/2"	12.75	7	16-337-0560	16-337-0566	16-337-0565	16-337-0563
3/8"	9.5	35/64"	13.72	7.65	16-337-0380	16-337-0386	16-337-0385	16-337-0383

SHIELDS FIRE-ACOL FUEL FILL HOSE

Shields Fire – Acol – Fuel Fill Hose resists gasoline/alcohol blends and is compounded for low permeation. Special compound resists cover deterioration due to alcohol fuel resting in hose. It is abrasion resistant and it is reinforced with wire helix imbedded between plies of HD synthetic cord. This imported hose is primarily used for fuel fill (gas or diesel) and is for pleasure boats only. The temperature range is -5°F to 180°F. It meets SAE J1527 Type A2 and ISO 7840 Type A2 NMMA/CE Type Accepted standards.

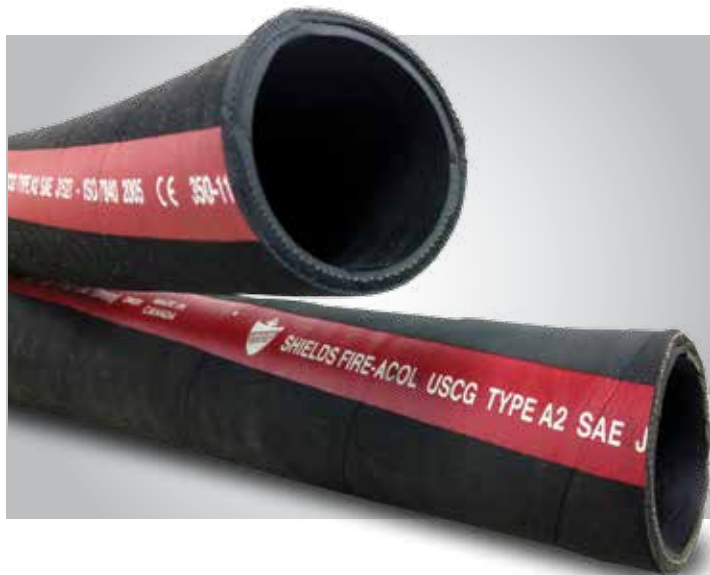

I.D.	mm	O.D.	mm	Ply	Burst Pressure	Wt. "C"	50' (15.2m) Coils Code #	12 1/2' (3.8m) Length Code #	12 1/2' (3.8m) Carton Code #	10' (3.1m) Length Code #	10' (3.1m) Carton Code #
1 1/2"	38	1 57/64"	48	2	90	77	16-350-1120	16-350-1124		16-350-1123	
1 5/8"	41.3	2 3/64"	52.0	2	90#	89	16-350-1580	16-350-1584	16-350-1584BX	16-350-1583	16-350-1583BX
1 7/8"	47.6	2 9/32"	58.0	2	90#	114	16-350-1780	16-350-1784	16-350-1784BX	16-350-1783	16-350-1783BX
2"	50.8	2 31/64"	63.1	2	90#	121	16-350-2000	16-350-2004	16-350-2004BX	16-350-2003	16-350-2003BX
2 3/8"	60.3	2 27/32"	72.2	2	90#	137	16-350-2380	16-350-2384	16-350-2384BX	16-350-2383	—

SHIELDS FIRE-ACOL "C" FUEL FILL HOSE



Shields Fire – Acol – "C" Fuel Fill Hose resists gasoline/alcohol blends and has a corrugated cover for extra flexibility. This hose is compounded for low permeation and is reinforced with a wire helix imbedded between plies of HD synthetic cord. It is also abrasion resistant. This hose is primarily used for extra flexible fuel fill (gas or diesel) and is for pleasure boats only. The temperature range is -5°F to 180°F. It meets SAE J1527 type A2 and NMMA Type Accepted standards.



I.D.	mm	O.D.	mm	Ply	Burst Pressure	Wt. "C"	Bulk Pack 50' (15.2m) Coils	Dist. Pkg.	
								12 1/2' (3.8m) Length	10' (3.1m) Length
1 1/2"	38.1	1 57/64"	48.0	2	90#	77	16-351-1120	16-351-1124	16-351-1123

SHIELDS FUEL FILL HOSE



Shields Fire – Acol – Fuel Fill Hose resists gasoline/alcohol blends and is compounded for low permeation. It is abrasion resistant and it is reinforced with wire helix imbedded between piles of HD synthetic cord. This imported hose is primarily used for fuel fill (gas or diesel) and is for pleasure boats only. It meets SAE J1527 Type A2 and ISO 7840 Type A2 NMMA/CE Type Accepted standards.

I.D.	mm	O.D.	mm	Ply	Burst Pressure	Wt. "C"	50' (15.2m) Coils Code #	12 1/2' (3.8m) Length Code #	12 1/2' (3.8m) Carton Code #	10' (3.1m) Length Code #	10' (3.1m) Carton Code #	25' (7.6m) Length Code #
1 1/2"	38.1	1 57/64"	48.0	2	90#	77	16-355-1120	16-355-1124	16-355-1124BX	16-355-1123	16-355-1123BX	16-355-1125
2"	51	2 31/64"	63.1	2	90#	111	16-355-2000	16-355-2004	16-355-2004BX	16-355-2003	16-355-2003BX	—

SHIELDS FIRE-ACOL 15 LOW PERMEATION FUEL HOSE

Shields Fire-Acol 15 – Low Permeation Fuel Hose has a special design NBR tube with an embedded plastic barrier layer to prevent permeation. The design of this hose provides easy coupling insertion and the NBR/PVC cover is weather and UV resistant. The hose is also polyester reinforced and fire-resistant. This hose is primarily used for fuel feed (gasoline up to 85% ethanol blended fuels/diesel/bio-diesel all blends). The temperature range is -20°F to 212°F.



I.D.	mm	O.D.	mm	Max WP	Wt. C	Bulk Pack 250' reel Code #	50' R/O Ctn. Code #	10' Polypac Code #
3/8"	9.5	49/64"	19.3	100	22	16-365-0380	16-365-0386	16-365-0383
1/2"	12.7	29/32"	22.86	100	27	16-365-0120	16-365-0126	16-365-0123

This hose complies with EPA and CARB very low permeation requirements. It meets USCG Type A1-15 requirements for pleasure boats, SAE J1527 Type A1-15, ISO 7840 Type A1, and NMMA/CE Type accepted standards

SHIELDS LOW PERMEATION MARINE FUEL HOSE



Shields Low Permeation Marine Fuel Hose has a plastic barrier veneer with an NBR outer layer tube to prevent permeation. This polyester reinforced hose complies with EPA and CARB very low permeation requirements and is weather/UV resistant. This hose is primarily used for fuel feed (gasoline up to 85% ethanol blended fuels/diesel/all bio-diesel blends). It meets USCG Type A1 – 15 requirements for pleasure boats and meets SAE J1527 Type A1-15, ISO 7840 Type A1, and NMMA/CE type accepted standards. The temperature ranges from -20°F to 212°F.



I.D.	mm	O.D.	mm	Max WP	Wt. C	Bulk Pack 250' reel Code #	50' R/O Ctn. Code #	25' R/O Ctn Code #	10' Polypac Code #
1/4"	6.4	35/64"	13.72	100	11	16-368-0140	16-368-0146	16-368-0145	16-368-0143
5/16"	7.9	5/8"	15.49	100	13	16-368-0560	16-368-0566	16-368-0565	16-368-0563
3/8"	9.5	11/16"	17.27	100	16	16-368-0380	16-368-0386	16-368-0385	16-368-0383
1/2"	12.7	13/16"	20.83	100	20	16-368-0120	16-368-0126	16-368-0125	16-368-0123

SHIELDS FIRE-ACOL FUEL VENT



Shields Fire-Acol Fuel Vent hose resists gasoline/alcohol blended fuel and is fire resistant. It features a weather/UV resistant NBR/PVC cover. This hose is primarily used for fuel vent lines (gasoline up to 85% ethanol blended fuels/diesel fuels). It meets USCG Type A2 requirements for pleasure boats and meets SAE J1527 Type A2, ISO 7840 Type A2 and NMMA/CE Type accepted standards. The temperature ranges from -20°F to 160°F.



I.D.	mm	O.D.	mm	Max WP	Wt. C	Bulk Pack 250' reel Code #	50' R/O Ctn. Code #	25' R/O Ctn Code #	10' Polypac Code #
5/8"	15.9	31/32"	24.38	50	25	16-369-0580	16-369-0586	16-369-0585	16-369-0583

FUEL FILTERS



Compact



Standard



Extra Capacity



Drain Bowl

AquaVue™ drain bowl style filters with see through plastic bowl or fire resistant metal bowl for below deck installation.

30 GPH for up to 115 HP motors
(Use with N-187774S head.)

Part #	Description	Rating
18-7928	Filter w/ AquaVue™ bowl	10 Micron
18-7929	Filter w/ Metal bowl	10 Micron
18-7866	Extra Capacity - 6"	10 Micron
18-7944	Short - 3.88"	10 Micron
18-7945	Long - 4.35"	10 Micron
18-7844	Short - 3.88"	21 Micron
18-7845	Long - 4.35"	21 Micron
18-7865	Compact Filter	10 Micron

Filters available in standard packs of 12.

FILTER FEATURES

Ethanol blended fuel absorbs more water and loosens more particulates than regular fuels. Proper filtration is required for every horsepower engine. Sierra fuel water separators remove over 98.8% of emulsified water from your gasoline. Sierra's 10 micron filters are over 90% efficient at removing particles as small as 10 micron. All filters flow at 90 GPH to feed even the hungriest motor. Sierra 10 micron filters are recommended to prevent damage to sensitive inboard and outboard fuel injection systems.

PRIMER BULBS CUSTOM FUEL LINE ASSEMBLIES

Sierra is a leading supplier of primer bulbs to the marine aftermarket. Our bulbs are molded in house. We use double check valves with viton balls and stainless steel springs.



- Sierra can fabricate custom assemblies for OEM applications.
- Any combination of hose and fittings is possible.
- Use type A hose to the splash well and type B hose to the engine.
- Customizable length.
- Inlet can be 3/8" with 5/16" outlet.
- Numerous OEM connectors available.



Part #	Description
18-8002EP-1	Primer bulb for 1/4" hose
18-8004EP-1	Primer bulb for 5/16" hose
18-8005EP-1	Primer bulb for 3/8" hose

BRACKETS

Sierra brackets are precision machined powder coated aluminum or marine grade stainless steel. They are available with 3/8" or 1/4" inlets.



Part # Bulk	Part # Boxed	Description	Standard Pack
N-187776	18-7776	3/8" Thread Stainless Steel	14
N-187777	18-7777	1/4" Thread Stainless Steel	14
N-187775	18-7775	3/8" Thread Aluminum	48
SUB-187852-1	18-7853-1	1/4" Thread Aluminum	48
N-187774S	18-7774	1/4" Thread Aluminum (Compact)	60
N-184264	18-4264	3/8" Pipe Plugs	—
5153R	18-4256	1/4" Pipe Plugs	—

SHIELDS SANITATION HOSE

Shields Sanitation Hose is kink resistant and flexible. It has an EPDM tube and cover, it is wire reinforced and has two fabric plies. This sanitation hose is resistant to toilet chemicals, odor permeation, ozone, salt water and heat. This hose is primarily used for toilet to holding tank, holding tank pump out, and maximum resistance to odor permeation.



I.D.	mm	O.D.	Ply	Burst Pressure	Wt. "C"	Bulk Pack 50' (15.2m) Coil Code #	Dist. Pkg. 12 1/2' (3.8m) Length Code #	25" (7.6mm) Coil Code #
1"	25	1 5/16"	2	200#	38	16-101-1000	16-101-1004	—
1 1/2"	38	1 55/64"	2	150#	55	16-101-1120	16-101-1124	16-101-1125

SHIELDS POLY X SANITATION HOSE



Shields Poly X Sanitation Hose has a lifetime warranty against odor permeation. This ultimate sanitation hose combines the flexibility of a rubber hose with the permeation resistance of polyurethane. Poly X can easily be slipped over most fittings and the polyurethane cover is extremely abrasion resistant. This hose has a glossy cover for easy clean up. This hose is primarily used for head to holding tank and holding tank pump out.

The tube is made of smooth, white NBR and is chemical and detergent resistant. The cover is comprised of smooth polyurethane and has a glossy cover. It is heat, weather, ozone and abrasion resistant.

I.D.	mm	O.D.	mm	Ply	Vac Rating	Wt "C"	50' (15.2m) Code #	12 1/2' (3.8m) Code #	10' (3.1m) Code #
3/4"	19	1 7/16"	33.7	2	28	38	16-105-0340	16-105-0344	16-105-0343
1"	25	1 21/64"	46.8	2	28	46	16-105-1000	16-105-1004	16-105-1003BX
1 1/2"	38	1 27/32"	46.8	2	28	66	16-105-1120	16-105-1124	16-105-1123BX

SHIELDS SANITATION HOSE FITTINGS

Fiberglass reinforced nylon fittings designed to fit Series 101, Series 105 and Series 144 and 148 hoses without heating or special tools. For use in sanitation systems, deck drain systems and water tank fill. Fittings are durable, chemical and fuel resistant, will not rust or cause electrolysis.

Style	Bulk Code #	Blister Pack Code #	Hose I.D.	mm	Thread
Straight Male	N800-0340	—	3/4"	19.1	3/4" MP
Straight Male	N800-1000	—	1"	25.4	1" MP
Straight Male	N800-1180	—	1 1/8"	28.6	1" MP
Straight Male	N800-1140	—	1 1/4"	31.8	1 1/4" MP
Straight Male	N800-1120	18-800-1120	1 1/2"	38.1	1 1/2" MP
Straight Female	N801-1120	18-801-1120	1 1/2"	38.1	1 1/2" FP
90 Degree Male	N802-1120	18-802-1120	1 1/2"	38.1	1 1/2" MP
90 Degree Female	N803-1120	18-803-1120	1 1/2"	38.1	1 1/2" FP
Hose Tee	N806-1120	18-806-1120	1 1/2"	38.1	N/A



SHIELDS SUPER PVC SANITATION HOSE



Shields Super PVC Sanitation Hose is smooth off white PVC with a vinyl helix. It contains an anti-fungus /bacterial agent to inhibit odor causing growth. It is resistant to mild chemicals, saltwater, and permeation. This hose is primarily used for toilet to holding tank (self draining lines) and holding tank pump out. It has a five year limited warranty. **Do not use ethylene glycol based anti-freeze in hose. CAUTION - Do not use for potable water.**

I.D.	mm	Bend Radius	mm	Vac Rating	Wt. "C"	Bulk Pack 100' (30.5m) Coil Code #	Dist. Pkg. 50' (15.2m) R/O Ctn. Code #
1"	25.4	3	76.2	28	27	16-144-1000	16-144-1006①
1 1/2"	38.1	5	127.3	28	40	16-144-1120	16-144-1126①

① **WARNING:** Lines containing raw sewage should be plumbed to be self-draining.

SHIELDS VAC EXTRA HEAVY DUTY - INDUSTRIAL GRADE



Shields Vac Extra Heavy Duty/Commercial Grade Hose has a smooth cover and clear FDA formula PVC with a white vinyl helix. It is rated for full vacuum and is resistant to mild chemicals and saltwater. This hose is primarily used for bilge pump intake and discharge, potable water tank fill, drains (sinks, shower, and scupper), livewell intake and drain, and sanitation (intake, vent and pump out). This hose is utilized for below the waterline connections. **Do not use ethylene glycol based antifreeze in hose. Do not use in pressurized water systems.**

I.D.	mm	Bend Radius	mm	Vac Rating	Wt. "C"	Bulk Pack 100' (30.5m) Coil Code #	50' (15.2m) R/O Ctn. Code #	Dist. Pkg. 10' (3.1m) Length Code #
5/8"	15.9	3	76.2	28	15	16-146-0580	16-146-0586	—
3/4"	19.1	3	76.2	28	16	16-146-0340	16-146-0346	—
1"	25.4	3	76.2	28	27	16-146-1000	16-146-1006	—
1 1/8"	28.6	4	101.6	28	25	16-146-1180	16-146-1186	—
1 1/4"	31.8	3	76.2	28	30	16-146-1140	16-146-1146	—
1 1/2"	38.1	4	101.6	28	40	16-146-1120	16-146-1126	—
2"	50.8	5	127.0	28	57	16-146-2000	—	16-146-2003
2 1/2"	63.5	7	177.8	28	74	16-146-2120	—	16-146-2123
3"	76.2	9	228.6	28	94	16-146-3000	—	16-146-3003

SHIELDS VAC EXTRA HEAVY DUTY/FDA

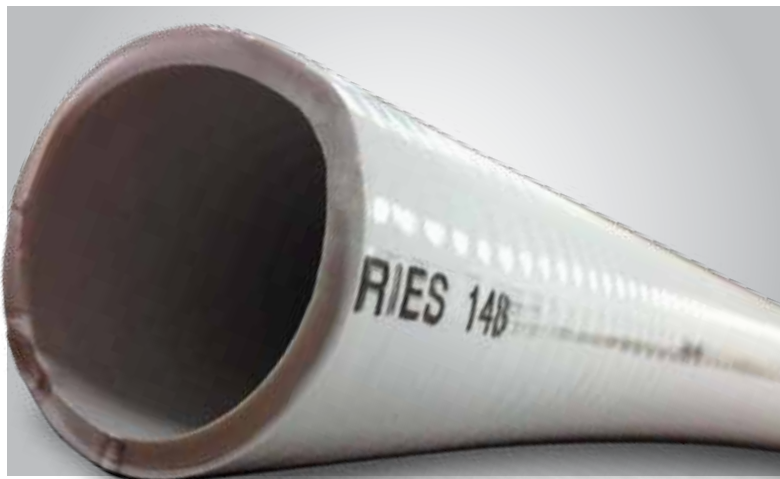

Shields Vac Extra Heavy Duty/FDA Hose has a smooth white FDA grade PVC with vinyl helix. It is rated for full vacuum and is resistant to mild chemicals, permeation, and saltwater. This hose is primarily used for bilge pump intake and discharge, drains (sinks, shower, and scupper), livewell intake and drain, potable water tank fill, and sanitation (toilet to holding tank, intake, self draining lines vent and pump out). This hose is resistant to odor permeation. **Do not use ethylene glycol based antifreeze in hose. Do not use in pressurized water systems.**

I.D.	mm	Bend Radius	mm	Vac Rating	Wt. "C"	Bulk Pack 100' (30.5m) Coil Code #	Dist. Pkg. 50' (15.2m) R/O Ctn. Code #	25' (7.6m) R/O Ctn. Code #
5/8"	15.9	3	76.2	28	15	16-148-0580W	16-148-0586W	—
3/4"	19.1	3	76.2	28	20	16-148-0340W	16-148-0346W	—
1"	25.4	3	76.2	28	27	16-148-1000W	16-148-1006W ①	—
1 1/8"	28.6	4	101.6	28	29	16-148-1180W	16-148-1186W	—
1 1/4"	31.8	4	101.6	28	31	16-148-1140W	16-148-1146W	—
1 1/2"	38.1	5	127.0	28	40	16-148-1120W	16-148-1126W ①	16-148-1125W

① **WARNING:** Lines containing raw sewage should be plumbed to be self-draining.

SHIELDS LIVEWELL HOSE



Shields Livewell Hose has a black smooth cover with vinyl helix. It is rated for full vacuum and is resistant to mild chemicals and saltwater. This hose is primarily used for bilge pump intake and discharge, drains (sinks, shower, and scupper), livewell intake and drain, and sanitation (intake and vent). This hose is utilized for below the waterline connections. **Do not use ethylene glycol based antifreeze in hose.**

I.D.	mm	Bend Radius	mm	Vac Rating	Wt. "C"	Bulk Pack 100' (30.5m) Coil Code #	Dist. Pkg. 50' (15.2m) R/O Ctn. Code #
5/8"	15.9	3	76.2	28	15	16-149-0580	16-149-0586
3/4"	19.1	3	76.2	28	16	16-149-0340	16-149-0346
1"	25.4	3	76.2	28	24	16-149-1000	16-149-1006
1 1/8"	28.6	4	101.6	28	25	16-149-1180	16-149-1186
1 1/4"	31.8	4	101.6	28	28	16-149-1140	16-149-1146
1 1/2"	38.1	5	127.0	28	39	16-149-1120	16-149-1126

SHIELDS 400/402 VINYLVENT



Shields Vinylvent Ducting Hose is PVC supported by anodized wire helix. It is resistant to UV and the ozone. This hose is primarily used for venting of bilge fumes.

I.D.	mm	O.D.	mm	Wt. "C"	Bulk Pack 50' (76.2m) Length Code # White	Dist. Pkg. 10' (3.1m) Polypac Code # White
3"	76.2	3 1/8"	79.4	8	16-400-3000	16-400-3003
4"	101.6	4 1/8"	104.8	10	16-400-4000	16-400-4003
3"	76.2	3 1/8"	79.4	8	16-402-3000	16-402-3003
4"	101.6	4 1/8"	104.8	10	16-402-4000	16-402-4003

SHIELDS EXTRA HEAVY DUTY VINYLVENT



Shields Extra Heavy Duty Vinylvent has an extra heavy PVC wall. It is supported by vinyl coated helical wire and is resistant to ozone, UV, and corrosion. It is flame resistant and meets the UL 94V standard. This hose is primarily used for venting of bilge fumes.



I.D.	mm	O.D.	mm	Wt. "C"	Code No.
3"	76	3 1/8"	79.4	17	16-420-3000
4"	102	4 1/8"	104.8	25	16-420-4000

Bulk Pack: 3" 6 x 50 4" 4 x 50

SHIELDS FIBERVENT



Shields Fibervent is vinyl coated, woven fiberglass hose. It is supported by vinyl coated helical wire and is resistant to ozone, UV, and corrosion. The hose is flame resistant and meets the UL 181 Class 1 standard. This hose is primarily used for venting of bilge fumes and A/C ducting hose. The temperature ranges from -20° F to +250° F.



Bulk	m	I.D.	mm	O.D.	mm	Rating	Vac Wt. "C"	Code No.
6 x 25'	1.8x7.6	3"	76.2	3 1/4"	82.6	20	13	16-450-3000
8 x 25'	2.4x7.6	4"	101.6	4 1/4"	108	20	15	16-450-4000
8 x 25'	2.4x7.6	5"	127	5 1/4"	133.4	20	17	16-450-5000
4 x 25'	1.2x7.6	6"	152.4	6 1/4"	158.8	20	19	16-450-6000

SHIELDS AIR CONDITIONER DUCTING HOSE



Shields Air Conditioner Ducting Hose has a smooth tube for maximum airflow. This is a vinyl coated, woven fiberglass hose and is supported by vinyl coated helical wire. It is resistant to ozone, UV, and corrosion. The hose is flame resistant and meets the UL 94-V-0 standard. This hose is primarily used for venting of bilge fumes and A/C ducting hose. The temperature ranges from -20° – +200°F



Bulk	m	I.D.	mm	O.D.	mm	Wt. "C"	Code No.
5 x 25'	1.5x7.6	3"	76	3 1/4"	82.5	22	16-460-3000
6 x 25'	1.8x7.6	4"	102	4 1/4"	108	24	16-460-4000
5 x 25'	1.5x7.6	5"	127	5 1/4"	133.4	32	16-460-5000
4 x 25'	1.2x7.6	6"	152	6 1/4"	158.8	36	16-460-6000
2 x 25'	.6x7.6	7"	178	7 1/4"	184.2	44	16-460-7000

SHIELDS MARINE EXHAUST/WATER HOSE (No Wire)



Shields Marine Exhaust / Water Hose is reinforced with 2 or 4 plies of synthetic cord and is made of black, heavy-walled synthetic rubber. This hose is primarily used for straight connections in wet exhaust systems and engine water circulation lines. It is resistant to engine heat, exhaust fumes, ozone, mild chemicals, antifreeze and saltwater. This hose also has double the ozone resistance required by SAEJ2006. The temperature ranges from -20°F – +200°F continuous, +250°F intermittent. The hose meets SAE J2006 Type R1 standards.

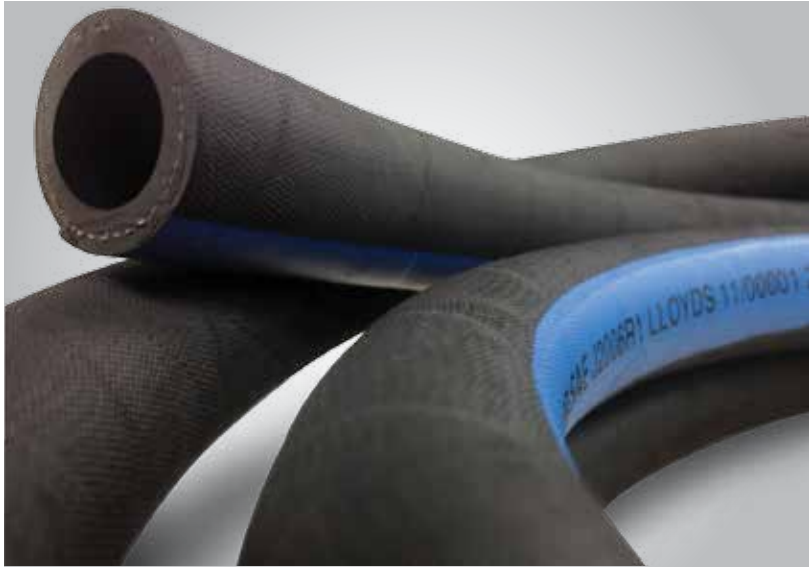

This certification provides unbiased, third party confirmation worldwide that these Shields hoses meet the highest standards of production quality. Certification ensures the proper level of product safety and inspires user confidence.

Now double the ozone resistance required by SAEJ2006

I.D.	mm	O.D.	Ply	Wt. "C"	50' Coil Code #	12 1/2' Length Code #	6 1/4' Length Code #
1/2"	13	7/8"	2	24	16-200-0120	16-200-0124	16-200-0121
5/8"	16	1 1/32"	2	33	16-200-0580	16-200-0584	16-200-0581
3/4"	19	1 9/64"	2	37	16-200-0340	16-200-0344	16-200-0341
7/8"	22	1 17/64"	2	42	16-200-0780	16-200-0784	16-200-0781
1"	25	1 3/8"	2	48	16-200-1000	16-200-1004	16-200-1001
1 1/8"	28	1 1/2"	2	52	16-200-1180	16-200-1184	16-200-1181
1 1/4"	32	1 45/64"	2	60	16-200-1140	16-200-1144	16-200-1141
1 5/16"	33	1 47/64"	2	62	16-200-1560	16-200-1564	16-200-1561
1 3/8"	35	1 13/16"	2	66	16-200-1380	16-200-1384	16-200-1381
1 1/2"	38	1 15/16"	2	70	16-200-1120	16-200-1124	16-200-1121
1 5/8"	42	2 3/32"	2	77	16-200-1580	16-200-1584	16-200-1581
1 3/4"	45	2 13/64"	2	82	16-200-1340	16-200-1344	16-200-1341
1 7/8"	48	2 23/64"	2	96	16-200-1780	16-200-1784	16-200-1781
2"	51	2 31/64"	2	102	16-200-2000	16-200-2004	16-200-2001
2 1/8"	54	2 19/32"	2	107	16-200-2180	16-200-2184	16-200-2181
2 1/4"	58	2 3/4"	2	114	16-200-2140	16-200-2144	16-200-2141
2 3/8"	60	2 7/8"	2	132	16-200-2380	16-200-2384	—
2 1/2"	63	3"	2	136	16-200-2120	16-200-2124	16-200-2121
2 5/8"	67	3 3/32"	2	147	—	16-200-2584	16-200-2581
2 3/4"	70	3 17/64"	2	152	—	16-200-2344	16-200-2341
2 7/8"	73	3 7/16"	2	174	16-200-2780	16-200-2784	16-200-2781
3"	76	3 9/16"	2	182	16-200-3000	16-200-3004	16-200-3001
3 1/8"	80	3 45/64"	2	190	—	16-200-3184	16-200-3181
3 1/2"	90	4 3/32"	2	198	—	16-200-3124	16-200-3121
3 3/4"	95	4 9/32"	2	221	—	16-200-3344	16-200-3341
4"	102	4 17/32"	4	229	—	16-200-4004	16-200-4001
4 1/2"	114	5 1/8"	2	300	—	16-200-4124	16-200-4121
5"	127	5 5/8"	2	332	—	16-200-5004	16-200-5001
5 1/2"	140	6 3/16"	2	396	—	16-200-5124	16-200-5121
6"	152	6 11/16"	2	427	—	16-200-6004	16-200-6001
8"	203	8 25/32"	4	670	—	16-200-8004	—
10"	254	10 7/8"	4	934	—	16-200-10004	—
12"	305	12 7/8"	4	1095	—	16-200-12004	—
14"	350	14 7/8"	4	1430	—	16-200-14004*	—

* Special Order

SHIELDS NAUTIFLEX SILICONE EXHAUST HOSE



Shields Nautiflex Silicone Exhaust Hose has a blue silicone cover with a smooth finish for easy clean up. This hose is flexible, easy to install and has four plies of synthetic fabric. It also remains stable at elevated temperatures. This hose is primarily used for straight connections in the wet exhaust system and engine water circulation lines. The temperature ranges from -20°F – $+350^{\circ}\text{F}$. The hose meets SAE J2006 Type R1 and ISO 13363:2004 – Type 2 – Class B standards.

I.D.	mm	O.D.	Wt. "C"	3' (.9m) Length Code No.	6' (1.8m) Length Code No.	12' (3.7m) Length Code No.
1"	25	1 ³ / ₈ "	33.1	16-202-1000-36	16-202-1001	16-202-1004
1 ¹ / ₈ "	28	1 ¹ / ₂ "	37.2	16-202-1180-36	16-202-1181	—
1 ¹ / ₄ "	32	1 ⁵ / ₈ "	41.3	16-202-1140-36	16-202-1141	16-202-1144
1 ³ / ₈ "	35	1 ³ / ₄ "	45.4	16-202-1380-36	16-202-1381	—
1 ¹ / ₂ "	38	1 ⁷ / ₈ "	49.6	16-202-1120-36	16-202-1121	16-202-1124
1 ³ / ₄ "	45	2 ¹ / ₈ "	57.8	16-202-1340-36	16-202-1341	—
2"	51	2 ³ / ₈ "	66.1	16-202-2000-36	16-202-2001	16-202-2004
2 ³ / ₈ "	60	2 ³ / ₄ "	78.5	16-202-2380-36	16-202-2381	16-202-2384
2 ¹ / ₂ "	63	2 ⁷ / ₈ "	82.6	16-202-2120-36	16-202-2121	16-202-2124
2 ⁵ / ₈ "	67	2 ⁶³ / ₆₄ "	86.8	16-202-2580-36	16-202-2581	16-202-2584
2 ³ / ₄ "	70	3 ¹ / ₈ "	90.9	16-202-2340-36	16-202-2341	—
2 ⁷ / ₈ "	73	3 ¹ / ₄ "	94.1	16-202-2780-36	16-202-2781	—
3"	76	3 ³ / ₈ "	99.2	16-202-3000-36	16-202-3001	16-202-3004
3 ¹ / ₄ "	82	3 ¹ / ₂ "	103.4	16-202-3140-36	16-202-3141	16-202-3144
3 ¹ / ₂ "	90	3 ⁷ / ₈ "	115.7	16-202-3120-36	16-202-3121	16-202-3124
4"	102	4 ³ / ₈ "	132	16-202-4000-36	16-202-4001	16-202-4004
5"	127	5 ³ / ₈ "	165	16-202-5000-36	16-202-5001	16-202-5004
5 ¹ / ₂ "	140	5 ⁷ / ₈ "	181.5	16-202-5120-36	—	—
6"	152	6 ³ / ₈ "	198	16-202-6000-36	16-202-6001	16-202-6004
8"	203	8 ³ / ₈ "	264	16-202-8000-36	—	—
10"	254	10 ³ / ₈ "	330	16-202-10000-36	—	—
12"	305	12 ³ / ₈ "	396	16-202-12000-36	—	—
14"	350	14 ⁵ / ₈ "	462	16-202-14000-36	—	—



SHIELDSFLEX II MARINE WATER/EXHAUST HOSE (w/ Wire)

Shieldsflex II Marine Water/Exhaust Hose has a black synthetic rubber tube and cover. It is reinforced with wire helix imbedded between plies of HD synthetic cord. It is resistant to exhaust fumes, ozone, mild chemicals, antifreeze and saltwater. This hose is abrasion and odor permeation resistant. It now has double the ozone resistance required by the SAEJ2006. Shieldsflex II is primarily used for engine intake, wet exhaust connections (use where bends or long lengths are required), bilge pump intake/discharge, scupper lines, toilet intake/discharge, and holding tank vent/pump out. The temperature ranges from -20° F – +200°F continuous, +250°F intermittent. The hose meets SAE J2006 Type R2 standards.

I.D.	mm	O.D.	Ply	Wt. "C"	50' (15.2m) Coil Code #	25' (7.6m) Cartons	12 1/2' (3.8m) Length Code #	6 1/4' (1.9m) Length Code #
1/2"	13	27/32"	2	24	16-250-0120	16-250-0125	16-250-0124	16-250-0121
5/8"	16	61/64"	2	28	16-250-0580	16-250-0585	16-250-0584	16-250-0581
3/4"	19	1 1/16"	2	32	16-250-0340	16-250-0345	16-250-0344	16-250-0341
7/8"	22	1 3/16"	2	36	16-250-0780	16-250-0785	16-250-0784	16-250-0781
1"	25	1 5/16"	2	40	16-250-1000	16-250-1005	16-250-1004	16-250-1001
1 1/8"	28	1 7/16"	2	44	16-250-1180	16-250-1185	16-250-1184	16-250-1181
1 1/4"	32	1 19/32"	2	50	16-250-1140	16-250-1145	16-250-1144	16-250-1141
1 5/16"	33	1 5/8"	2	51	16-250-1560	—	16-250-1564	16-250-1561
1 3/8"	35	1 23/32"	2	58	16-250-1380	16-250-1385	16-250-1384	16-250-1381
1 1/2"	38	1 53/64"	2	62	16-250-1120	16-250-1125	16-250-1124	16-250-1121
1 5/8"	42	2"	2	80	16-250-1580	—	16-250-1584	16-250-1581
1 3/4"	45	2 1/8"	2	88	16-250-1340	—	16-250-1344	16-250-1341
1 7/8"	48	2 19/64"	2	93	16-250-1780	—	16-250-1784	16-250-1781
2"	51	2 13/32"	2	99	16-250-2000	—	16-250-2004	16-250-2001
2 1/8"	54	2 17/32"	2	107	16-250-2180	—	16-250-2184	16-250-2181
2 1/4"	58	2 11/16"	2	127	16-250-2140	—	16-250-2144	16-250-2141
2 3/8"	60	2 3/4"	2	132	16-250-2380	—	16-250-2384	16-250-2381
2 1/2"	63	2 7/8"	2	137	16-250-2120	—	16-250-2124	16-250-2121
2 5/8"	67	3 1/16"	2	147	—	—	16-250-2584	16-250-2581
2 3/4"	70	3 3/16"	2	164	16-250-2340	—	16-250-2344	16-250-2341
2 7/8"	73	3 5/16"	2	170	16-250-2780	—	16-250-2784	16-250-2781
3"	76	3 7/16"	2	177	16-250-3000	—	16-250-3004	16-250-3001
3 1/8"	80	3 5/8"	2	200	16-250-3180	—	16-250-3184	16-250-3181
3 1/2"	90	4"	2	223	16-250-3120	—	16-250-3124	16-250-3121
4"	102	4 5/8"	2	269	16-250-4000	—	16-250-4004	16-250-4001
4 1/8"	105	4 47/64"	2	276	—	—	—	—
4 1/2"	114	5 3/32"	2	319	16-250-4120	—	16-250-4124	16-250-4121
5"	127	5 5/8"	2	398	16-250-5000	—	16-250-5004	16-250-5001
5 1/8"	130	5 3/4"	2	417	—	—	—	—
5 1/2"	140	6 3/16"	2	443	—	—	—	—
6"	152	6 21/32"	2	482	—	—	16-250-6004	16-250-6001
8"	203	8 25/32"	2	780	—	—	16-250-8004	—



Now double the ozone resistance required by SAEJ2006



This certification provides unbiased, third party confirmation worldwide that these Shields hoses meet the highest standards of production quality. Certification ensures the proper level of product safety and inspires user confidence.

SHIELDSAUST-C

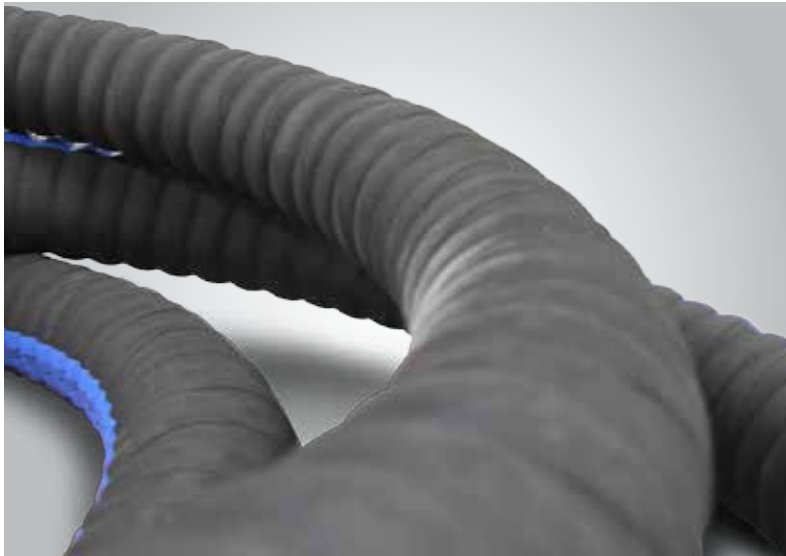

Now double the ozone resistance required by SAEJ2006

Shieldsaust – C Hose has a black synthetic rubber tube and cover. It is reinforced with double wire helix imbedded between plies of synthetic cord and is abrasion resistant. It is resistant to exhaust fumes, ozone, mild chemicals, antifreeze, and saltwater. This hose is primarily used for wet exhaust connections with significant bends, engine intake and scupper lines. The temperature ranges from -20°F to +200°F continuous, +250°F intermittent. The hose now has double the ozone resistance required by SAEJ2006. This hose meets SAE J2006 Type R2 standards.

I.D.	mm	O.D.	Ply	Wt. "C"	50' (15.2m) Coil Code #	12 1/2' (3.8m) Length Code #	6 1/4' (1.9m) Length Code #
3/4"	19	1 1/8"	2	27	16-252-0340	16-252-0344	16-252-0341
1"	25	1 11/32"	2	33	16-252-1000	16-252-1004	16-252-1001
1 1/4"	32	1 39/64"	2	45	16-252-1140	16-252-1144	16-252-1141
1 1/2"	38	1 15/16"	2	70	16-252-1120	16-252-1124	16-252-1121
1 5/8"	42	2 3/32"	2	80	16-252-1580	16-252-1584	16-252-1581
1 3/4"	45	2 7/32"	2	85	16-252-1340	16-252-1344	16-252-1341
1 7/8"	48	2 21/64"	2	91	16-252-1780	16-252-1784	16-252-1781
2"	51	2 7/16"	2	95	16-252-2000	16-252-2004	16-252-2001
2 1/8"	54	2 9/16"	2	100	—	16-252-2184	—
2 1/4"	58	2 23/32"	2	107	16-252-2140	16-252-2144	16-252-2141
2 3/8"	60	2 51/64"	2	110	16-252-2380	16-252-2384	16-252-2381
2 1/2"	63	2 59/64"	2	115	16-252-2120	16-252-2124	16-252-2121
2 3/4"	70	3 3/16"	2	126	16-252-2340	16-252-2344	16-252-2341
2 7/8"	73	3 5/16"	2	137	16-252-2780	16-252-2784	16-252-2781
3"	76	3 7/16"	2	143	16-252-3000	16-252-3004	16-252-3001
3 1/8"	80	3 19/32"	2	150	16-252-3180	16-252-3184	16-252-3181
3 1/2"	90	4 1/16"	2	200	16-252-3120	16-252-3124	16-252-3121
4"	102	4 9/16"	2	231	16-252-4000	16-252-4004	16-252-4001
4 1/8"	105	4 11/16"	2	238	—	16-252-4184	16-252-4181
4 1/2"	114	5 1/8"	2	278	—	16-252-4124	16-252-4121
5"	127	5 9/16"	2	300	16-252-5000	16-252-5004	16-252-5001
6"	152	6 9/16"	2	394	16-252-6000	16-252-6004	16-252-6001
8"	203	8 11/16"	2	607	—	16-252-8004	16-252-8001



This certification provides unbiased, third party confirmation worldwide that these Shields hoses meet the highest standards of production quality. Certification ensures the proper level of product safety and inspires user confidence.

SHIELDS NAUTIFLEX CORRUGATED SILICONE EXHAUST HOSE



Shields Nautiflex Corrugated Silicone

Exhaust Hose has a blue silicone tube and cover with a smooth finish for easy cleaning. The hose is wire reinforced and will not collapse under suction or in a bend. The corrugated cover allows the hose to bend for easy installation. The Nautiflex, two ply construction, has wire captured between fabric plies. This hose is primarily used for main engine exhaust, generator exhaust, engine coolant circulation, engine intake and generator intake. It is resistant to exhaust fumes, ozone, mild chemicals, antifreeze and saltwater. The hose remains stable at elevated temperatures. The temperatures ranges from -20°F – +350°F. This hose meets SAEJ2006 Type R2 and ISO 13362:2004 – Type 1 – Class B standards.

ID	mm	OD	WT "C"	10' (3.1m) length Code No.	12 1/2' (3.8m) Length Code No.	50' (15.2m) coil Code No.
3/4"	19	1 3/8"	34	—	16-262-0344	16-262-0340
1"	25	1 27/64"	42	—	16-262-1004	16-262-1000
1 1/8"	28	1 1/2"	46	—	16-262-1184	16-262-1180
1 1/4"	32	1 45/64"	52	—	16-262-1144	16-262-1140
1 3/8"	35	1 55/64"	60	—	16-262-1384	16-262-1380
1 1/2"	38	2"	71	—	16-262-1124	16-262-1120
1 5/8"	42	2 11/64"	74	—	16-262-1584	16-262-1580
1 3/4"	45	2 19/64"	78	—	16-262-1344	16-262-1340
1 7/8"	48	2 13/32"	82	—	16-262-1784	16-262-1780
2"	51	2 17/32"	87	—	16-262-2004	16-262-2000
2 1/8"	54	2 5/8"	94	—	16-262-2184	—
2 3/8"	60	2 7/8"	101	—	16-262-2384	16-262-2380
2 1/2"	63	3 3/64"	113	—	16-262-2124	16-262-2120
2 7/8"	73	3 7/16"	134	—	16-262-2784	16-262-2780
3"	76	3 35/64"	139	—	16-262-3004	16-262-3000
3 1/2"	90	4 19/64"	227	—	16-262-3124	16-262-3120
4"	102	4 49/64"	255	—	16-262-4004	16-262-4000
5"	127	5 3/4"	310	16-262-5003	—	16-262-5000
6"	152	6 15/16"	484	16-262-6003	—	—
8"	203	9 7/64"	768	16-262-8003	—	—
10"	254	11 17/64"	1136	16-262-10003	—	—

* Special Order

SHIELDS SILICONE COUPLERS

- SINGLE & DOUBLE HUMPW/ Reinforced Fabric



SINGLE HUMP

DOUBLE HUMP

Shields Single and Double Hump Couplers have a blue silicone cover with a smooth finish for easy clean up and are fabric reinforced. The couplers remain stable at elevated temperatures and provide angular and longitudinal vibration absorption in wet exhaust systems. Shields couplers correct slight offsets in pipes. They are resistant to exhaust fumes, ozone, mild chemicals, antifreeze and saltwater. The temperature range is -20°F to +350°F. It meets SAE J2006 Type R1 standards.

	I.D.	mm	Length	mm	Wt. Ea. (lbs)	Code No.
SINGLE	4"	102	6"	152	2	16-272-4000
	5"	127	6"	152	2	16-272-5000
	6"	152	8"	203	2	16-272-6000
	8"	203	8"	203	3	16-272-8000
	10"	254	12"	305	4	16-272-10000
DOUBLE	6"	152.4	14"	356	3	16-274-6000
	8"	203.2	14"	356	3	16-274-8000
	10"	254	14"	356	4	16-274-10000

SHIELDS SILICONE COUPLERS

- SINGLE & DOUBLE HUMP

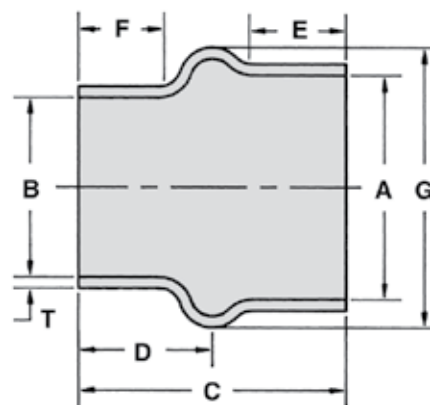

Hump Hose

Shields Silicone Single and Double Hump Couplers are very high temperature silicone exhaust connectors. The maximum operating temperature is 450°F (232°C). It meets SAE J2006 Type R1 standards.

Part Number	A	mm	B	mm	C	mm	D	mm	E	mm	F	mm	G	mm	T	mm
16-220S4000	4.00	102	4.00	102	5.25	133	2.63	67	2.00	51	2.00	51	5.25	133	.25	6
16-220S5000	5.00	127	5.00	127	6.00	152	3.00	76	2.25	57	2.25	57	6.10	155	.25	6
16-220S6000	6.00	152	6.00	152	6.00	152	3.00	76	2.25	57	2.25	57	7.38	188	.25	6

SHIELDS SILICONE ELBOWS - 45°

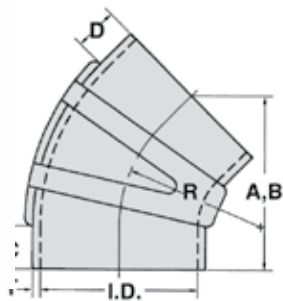

45° Elbow



Part Number	ID	mm	A	mm	B	mm	C	mm	D	mm	R	mm	T	mm
16-245S3000	3.0	76	5.5	140	5.5	140	1.6	41	1.6	41	3.75	95	.25	6
16-245S4000	4.0	102	5.5	140	5.5	140	1.46	37	1.46	37	4.25	108	.25	6
16-245S5000	5.0	127	5.5	140	5.5	140	1.36	35	1.36	35	4.5	114	.25	6
16-245S6000	6.0	152	6.5	165	6.5	165	1.74	44	1.74	44	5.0	127	.25	6

SHIELDS SILICONE ELBOWS - 90°

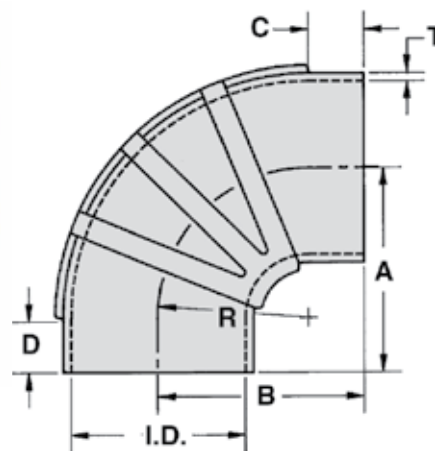

90° Elbow

Part Number	ID	mm	A	mm	B	mm	C	mm	D	mm	R	mm	T	mm
16-290S2000	2.0	51	3.5	88.9	3.5	89	1.5	38	1.5	38	2.0	51	.25	6
16-290S3000	3.0	76	5.45	138	5.25	133	1.5	38	1.5	38	3.75	95	.25	6
16-290S4000	4.0	102	5.75	146	5.75	146	1.25	32	1.25	32	4.5	114	.25	6
16-290S5000	5.0	127	6.12	155	6.12	155	1.75	45	1.75	45	4.74	120	.25	6
16-290S6000	6.0	152	6.75	171	6.75	171	1.75	45	1.75	45	5.0	127	.25	6
16-290S8000	8.0	203	8.5	216	8.5	216	2.0	51	2.0	51	6.5	165	.37	9

SHIELDS EPDM COUPLERS - SINGLE & DOUBLE HUMP

100% High temperature EPDM rubber. Maximum operating temperature 250° F (120° C).



Part Number	A	mm	B	mm	C	mm	D	mm	E	mm	F	mm	G	mm	T	mm
16-220-3000	3.00	76	3.00	76	5.25	133	2.62	67	1.87	48	1.87	48	4.50	114	.25	6
16-220-3120	3.50	89	3.50	89	5.25	133	3.00	76	2.25	57	2.25	57	5.00	127	.25	6
16-221-400x300	4.00	102	3.00	76	5.25	133	2.00	51	2.00	51	3.00	76	5.25	133	.25	6
16-220-4000	4.00	102	4.00	102	5.25	133	2.63	67	2.00	51	2.00	51	5.25	133	.25	6
16-220-4120	4.50	114	4.50	114	6.00	152	3.00	76	2.25	57	2.25	57	6.00	152	.25	6
16-221-500x400	5.00	127	4.00	102	6.00	152	3.00	76	2.12	54	1.81	46	6.25	159	.25	6
16-220-5000	5.00	127	5.00	127	6.00	152	3.00	76	2.25	57	2.25	57	6.10	155	.25	6
16-221-600x500	6.00	152	5.00	127	6.00	152	3.00	76	2.13	54	1.88	48	7.50	191	.25	6
16-220-6000	6.00	152	6.00	152	6.00	152	3.00	76	2.25	57	2.25	57	7.38	188	.25	6
16-221-800x600	8.00	203	6.00	152	6.00	152	1.75	45	1.95	50	3.00	76	9.50	241	.25	6
16-220-8000	8.00	203	8.00	203	8.00	203	4.00	102	3.00	76	3.00	76	10.37	263	.31	8
16-221-1000x800	10.00	254	8.00	203	6.00	152	3.00	76	2.00	51	1.75	45	11.50	292	.25	6
16-220-10000	10.00	254	10.00	254	6.00	152	3.00	76	2.00	51	2.00	51	11.50	292	.25	6

SHIELDS EPDM ELBOWS - 45°



Part Number	ID	mm	A	mm	B	mm	C	mm	D	mm	R	mm	T	mm
16-245-3000	3.0	76	5.5	140	5.5	140	1.6	41	1.6	41	3.75	95	.25	6
16-245-3120	3.5	89	5.5	140	5.5	140	2.0	51	2.0	51	4.0	102	.25	6
16-245-4000	4.0	102	5.5	140	5.5	140	1.46	37	1.46	37	4.25	108	.25	6
16-245-4120	4.5	114	5.06	129	5.06	129	1.5	38	1.5	38	3.5	89	.25	6
16-245-5000	5.0	127	5.5	140	5.5	140	1.36	35	1.36	35	4.5	114	.25	6
16-245-6000	6.0	152	6.5	165	6.5	165	1.74	44	1.74	44	5.0	127	.25	6
16-245-8000	8.0	203	8.06	205	8.06	205	2.0	51	2.0	51	6.5	165	.37	9
16-245-10000	10.0	254	10.5	267	10.5	267	2.25	57	2.75	70	8.5	216	.37	9

SHIELDS EPDM ELBOWS - 90°

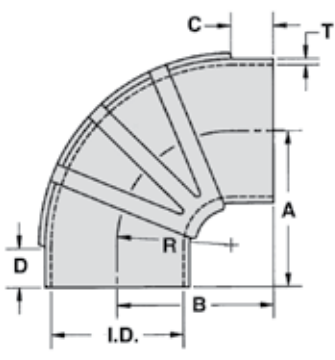

90° Elbow

Part Number	ID	mm	A	mm	B	mm	C	mm	D	mm	R	mm	T	mm
16-290-2000	2.0	51	3.5	88.9	3.5	89	1.5	38	1.5	38	2.0	51	.25	6
16-290-2120	2.5	64	4.0	102	4.0	102	1.5	38	1.5	38	2.5	64	.25	6
16-290-3000	3.0	76	5.45	138	5.25	133	1.5	38	1.5	38	3.75	95	.25	6
16-290-3120	3.5	89	5.5	140	5.5	140	1.5	38	1.5	38	4.0	102	.25	6
16-290-4000	4.0	102	5.75	146	5.75	146	1.25	32	1.25	32	4.5	114	.25	6
16-290-4120	4.5	114	5.5	140	5.5	140	2.0	51	2.0	51	3.5	89	.25	6
16-290-5000	5.0	127	6.12	155	6.12	155	1.75	45	1.75	45	4.74	120	.25	6
16-290-6000	6.0	152	6.75	171	6.75	171	1.75	45	1.75	45	5.0	127	.25	6
16-290-8000	8.0	203	8.5	216	8.5	216	2.0	51	2.0	51	6.5	165	.37	9

SHIELDS EPDM ELBOWS - 90° REDUCING ELBOW

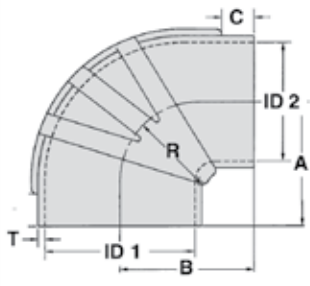

90° Reducing Elbow

Part Number	ID1	mm	ID2	mm	A	mm	B	mm	C	mm	D	mm	R	mm	T	mm
16-291-500x400	5.50	140	4.00	102	8.00	203	3.63	92	1.25	32	2.25	57	.20	5	.25	6
16-291-600x500	6.00	152	5.00	127	5.00	127	5.00	127	1.50	38	1.50	38	3.50	89	.25	6

Also available with series 720 T-bolt clamps. Order part number with "Kit" Suffix.

SHIELDS EXHAUST PROTECTOR VALVES

Specially compounded rubber flapper valves designed to prevent water from entering the exhaust system in following seas or when backing down. Made with weather resistant EPDM with U/V stabilizer.



Code #	Pipe Size	mm	O.E.M.	O.E. #
18-4456*	3"	76.2	Mercury	34765A1
18-4457*	4"	101.6	Mercury	12644A1
18-4458* ^①	5" or 6"	127 or 152.4	—	—
N-184456	3"	76.2	—	—
N-184457	4"	101.6	—	—
N-184458 ^①	5" or 6"	127 or 152.4	—	—

* Display Packaged

^① Must be cut at marks to fit 5" pipe
 18-#'s include stainless steel hose clamp.
 N-#'s are bulk flappers only

SHIELDS HOSE CLAMPS

All components are manufactured from marine grade 316 stainless steel. These clamps are designed to fit many applications from 5/16" to 7" diameter hoses.



Sierra No.	Bulk No.	Diameter Size	Std. No.
18-7307	N-187307	5/16" to 7/8"	006
18-7308	N-187308	9/16" to 1 1/16"	010
18-7309	N-187309	9/16" to 1 1/4"	012
18-7310	N-187310	1 1/16" to 1 1/2"	016
18-7311	N-187311	3/4" to 1 3/4"	020
18-7312	N-187312	1 1/16" to 2"	024
18-7313	N-187313	1 9/16" to 2 1/2"	032
18-7314	097R	2 9/16" to 3 1/2"	048
18-7315	590R	2 1/2" to 4 1/2"	064
18-7316 ^③	096R	3" to 5"	072
18-7317	N-187317	5" to 7"	104

^③ PKG OF 2

SHIELDS EXHAUST HOSE CLAMPS T-BOLT BAND CLAMPS



These exhaust hose clamps are designed to fit Shields series 200, 250, and are perfect for any application below the water line. The band is 316 stainless steel and is .025 thick by .75 wide. Other hardware includes an extra long 1/4" bolt and a nylon inset locknut. The bolt, nut and trunion are 18-8 (304) stainless steel. Maximum torque of 75 inch pounds.

Diameter Range	mm	Hose I.D.	mm	Wt. "C"	Code No.
1.18 - 1.47	30.0 - 37.3	1"	25.4	9.4	18-720-1000 ^②
1.70 - 2.03	43.2 - 51.6	1 1/2"	38.1	12.5	18-720-1120 ^②
2.27 - 2.67	57.7 - 67.8	2"	50.8	12.8	18-720-2000
2.68 - 3.34	68.1 - 84.8	2 1/2"	63.5	15.6	18-720-2120
3.10 - 3.76	78.7 - 95.5	3"	76.2	15.8	18-720-3000
3.59 - 4.25	91.2 - 108	3 1/2"	88.9	17.2	18-720-3120
4.18 - 4.84	106.2 - 122.9	4"	101.6	18.8	18-720-4000
4.25 - 4.91	108.0 - 124.7	4 1/8"	104.8	18.9	18-720-4180
4.75 - 5.41	120.7 - 137.4	4 1/2"	114.3	20	18-720-4120
4.68 - 5.34	118.9 - 135.6	4 1/2"	114.3	20	18-720-4120S *
5.30 - 5.96	134.6 - 151.4	5"	127.0	22	18-720-5000
5.18 - 5.84	131.6 - 148.3	5"	127.0	22	18-720-5000S *
5.75 - 6.41	146.1 - 162.8	5 1/2"	139.7	25	18-720-5120
5.68 - 6.34	144.3 - 161.0	5 1/2"	139.7	25	18-720-5120S *
6.38 - 7.04	162.1 - 178.8	6"	152.4	27	18-720-6000
6.18 - 6.84	157.0 - 173.7	6"	152.4	27	18-720-6000S *
8.42 - 9.08	213.9 - 230.6	8"	203.2	29	18-720-8000
8.18 - 8.84	207.8 - 224.5	8"	203.2	29	18-720-8000S *
10.45 - 11.11	265.4 - 282.2	10"	254.0	31	18-720-10000
10.18 - 10.84	258.6 - 275.3	10"	254.0	31	18-720-10000S *
12.38 - 13.04	314.5 - 331.2	12"	304.8	33	18-720-12000
12.18 - 12.84	309.4 - 326.1	12"	304.8	33	18-720-12000S *
14.50 - 15.16	368.3 - 385.1	14"	355.6	41.1	18-720-14000
14.30 - 14.96	363.2 - 380.0	14"	355.6	41.1	18-720-14000S *

^② Clamps for 1" and 1 1/2" are 5/8" wide

* Designed to fit Series 202 silicone exhaust hose



FERRULE VISE/DIES

Hand operated vise for making fuel line assemblies without clamps. Vise uses ordinary barbed fittings with series 700 solid brass ferrules. Makes professional looking leak proof fuel lines. Furnished with removable handle. Dies must be ordered separately. When ordering dies, please consult chart under brass ferrules to determine proper size.

Part #	Description
No. 18-J-662-xxx	Dies give longitudinal crimp.
No. 18-J-664-xxx	Dies give circular and longitudinal crimp.
No. 18-J-VISE	Vise (w/o dies)

* Special Order Only

45° SAE FEMALE SWIVEL

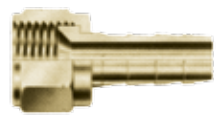

Code No.	Hose I.D.	Tube	Thread
18-502-1476	1/4"	1/4"	7/16-20
18-502-1412	1/4"	5/16"	1/2-20
18-502-5612	5/16"	5/16"	1/2-20
18-502-5658	5/16"	3/8"	5/8-18
18-502-3858	3/8"	3/8"	5/8-18
18-502-3834	3/8"	1/2"	3/4-16
18-502-1234	1/2"	1/2"	3/4-16
18-502-1278	1/2"	5/8"	7/8-14

Standard Package: 100 pieces

ADAPTER — MALE PIPE TO SAE 45° FLARE



Code No.	Tube	Pipe
18-600-1418	1/4"	1/8"
18-600-1414	1/4"	1/4"
18-600-5618	5/16"	1/8"
18-600-5614	5/16"	1/4"
18-600-3818	3/8"	1/8"
18-600-3814	3/8"	1/4"
18-600-3838	3/8"	3/8"
18-600-1212	1/2"	1/2"

Standard Package: 100 pieces

ADAPTER — MALE PIPE TO SAE 45° FLARE 90°



Code No.	Tube	Pipe
18-601-3814	3/8"	1/4"

MALE PIPE

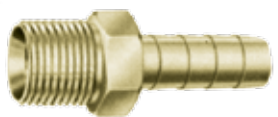

Bulk Pack Code No.	Hose Barb Sierra No.	Hose I.D.	Thread
18-500-1418	18-8043	1/4"	1/8"
18-500-1414	18-8042	1/4"	1/4"
18-500-5618	18-8054	5/16"	1/8"
18-500-5614	18-8055	5/16"	1/4"
18-500-3812	—	3/8"	1/2"
18-500-3818	18-8073	3/8"	1/8"
18-500-3814	18-8074	3/8"	1/4"
18-500-3838	18-8044	3/8"	3/8"
18-500-1238	—	1/2"	3/8"
18-500-1212	—	1/2"	1/2"
18-500-5838	18-8041	5/8"	3/8"
18-500-5834	—	5/8"	3/4"

STD. PKG. 100 STD. CTN. 12
(1 PER CARD)

SOLID BRASS FERRULES



Code No.	Hose Type	Die Set	Wt. "M"
18-700-5500	16-368-0140	550	—
18-700-6250	16-368-0560	625	—
18-700-6750	—	675	—
18-700-7000	16-368-0380	700	—
18-700-7250	—	725	—
18-700-7750	16-365-0380	775	—
18-700-8000	—	775	—
18-700-8250	16-368-0120	825	—
18-700-9250	—	900	—
18-700-1025	—	1025	39.5

SHIELDS FLAME RETARDANT SPLIT WIRE CONDUIT

Flame retardant polypropylene is black with a blue stripe. It provides chafing protection for wiring systems and is split longitudinally for easy access to harness. It has a temperature range of +275°F. It meets ABYC standard 8.15.19. and UL 94 V2.



I.D.	mm	Wt. "C"	Code #	Pack	m	Dist. Pkg.		
						100' (30.1m) R/O Ctn. Code #	50' (15.2m) R/O Ctn. Code #	50' (15.2m) Box Code #
1/4"	6.4	1.26	16-128-0140B	3200'	975	16-128-0147B	16-128-0146B	16-128-0146B-1
3/8"	9.5	1.58	16-128-0380B	1800'	549	16-128-0387B	16-128-0386B	16-128-0386B-1
1/2"	12.7	2.31	16-128-0120B	1100'	335	16-128-0127B	16-128-0126B	16-128-0126B-1
5/8"	15.9	2.94	16-128-0580B	750'	229	16-128-0587B	16-128-0586B	16-128-0586B-1
3/4"	19.1	3.47	16-128-0340B	450'	137	16-128-0347B	16-128-0346B	16-128-0346B-1
1"	25.4	5.78	16-128-1000B	300'	91	16-128-1007B	16-128-1006B	16-128-1006B-1
1 1/4"	31.8	9.24	16-128-1140B	200'	61	16-128-1147B	16-128-1146B	—
1 1/2"	38.1	15.23	16-128-1120B	100'	31	—	16-128-1126B	—
2"	50.8	21.00	16-128-2000B	100'	31	—	—	—

SHIELDS STERNFLEX



Shields Sternflex has a polyethylene co-polymer wall with an integral polyethylene helix. It is resistant to abrasion, crushing and UV. This hose is primarily used as a cover for the harness and for the hoses on the bracket mounted on outboard engines.



I.D.	mm	Bend Radius	mm	Wt. "C"	Bulk Pack 50' (15.2m) Length Code No.	Dist. Pkg. 10' (3.1m) Box Code No.
2"	50.8	3	76.2	39	16-126-2000B	16-126-2003B

RIGGING FLANGE



18-9761 - Part No.
N-189761 - Bulk Part No.

- U/V stabilized black plastic flange
- Use with Shields
2" Sternflex P/N 16-126-2000B

RIGGING HOSE KIT



18-9883 - Part No.

- Hides all engine cables and hoses
- Can be added to any style outboard
- Contains:
 - (1) U/V stabilized flange
 - 5' 2" Black Sternflex

SHIELDS NEOPRENE SHEET RUBBER

Solid Neoprene sheet rubber is designed for use under fuel tanks to comply with USCG requirements for air space. Also for gaskets, component padding and under wire straps. It can be custom cut to a variety of strips and shapes. It is offered in bulk rolls 36" wide x 10' long.



BULK SHEET

Thickness	mm	Width	mm	Length	mm	Code No.
1/8"	3.2	36"	914.4	10'	3.1	N18NEO60
3/16"	4.8	36"	914.4	10'	3.1	N316NEO60
1/4"	6.4	36"	914.4	10'	3.1	N14NEO60
3/8"	9.5	36"	914.4	10'	3.1	N38NEO60

DISTRIBUTOR BOXES

Thickness	mm	Width	mm	Length	mm	Code No.
1/8"	3.2	2"	50.8	10'	3.1	16-18X2X10
1/4"	4.8	2"	50.8	10'	3.1	16-14X2X10
3/8"	9.5	2"	50.8	10'	3.1	16-38X2X10
1/8"	3.3	1"	25.4	10'	3.1	16-18X1X10
1/4"	6.4	1"	25.4	10'	3.1	16-14X1X10
3/8"	9.7	1"	25.4	10'	3.1	16-38X1X10



SHIELDS SPEEDOMETER PITOT TUBING

This black vinyl tubing is HW reinforced with a polyester braid and provides a tight connection between your speedometer pickup (Pitot) and your speedometer.



Nominal I.D.	mm	Braid	Wt. "C"	Code #	Bulk Pack	mm	Dist. Pkg. 25' (7.6m) Polypac Code #
1/8" (.125")	3.2	0	2.2	16-151-0180	1500'	457.2	16-151-0185
4 mm (.157")	4.0	1	4.3	16-151-0180H.W.	300'	91.4	16-151-0185 H.W.



23-1100
AIR FILTER
Replaces: Kohler 267709
Fits: 3.5 CFZ, 4 CZ, 5 CFZ, 6.5 CZ



23-1101
AIR FILTER
Replaces: Westerbeke 39705
Fits: 8.0 BTDA(60Hz) / 6.0 BTDA(50Hz), 10.0 BTDA(60Hz) / 7.5 BTDA(50Hz), 12.5 BTDB(60Hz) / 9.4 BTDB(50Hz), 15.0 BTDC(60Hz) / 12.0 BTDC(50Hz)



23-1104
AIR FILTER
Replaces: Fischer Panda IC78.460.000B
Fits: PMS 4200, PMS04, PMS15, PMS 16 DP, PMS 20, PMS 22



23-1105
AIR FILTER
Replaces: Fischer Panda IC78.460.000A
Fits: PMS 8 Mini, PMS 8 DP, PMS 6500, PMS 12 DP, PMS 12 Mini



23-1102
AIR FILTER ELEMENT
Replaces: Northern Lights 24-22009
Fits: M843NW3: 12/10Kw, M844W3: 16/12KW, M844LW3: 20/16Kw



23-1103
AIR FILTER ELEMENT
Replaces: Northern Lights 24-28003
Fits: M673LD3: 5 / 4.5Kw, M673L3: 6/5Kw



23-1130
AIR FILTER
Replaces: Kohler 278857
Fits: 4 CCFOZ(variation 4), 4EFOZ(variation 4), 5 CCOZ(variation 4), 5EOZ(variation 4), 6.5 EFOZ(variation 4), 8EOZ(variation 4), 8EFOZ, 9 CCOZ, 9EOZ, 9EFOZ, 10EOZ, 6.5EFOZD, 7 EFOZD, 8EOZD, 8.5 EFOZD, 9 EOZD, 9EFOZD, 10EOZD



23-7200
CARB KIT
Replaces: Westerbeke 36450
Fits: 6.5 TWG(60Hz)/4.9 TWG(50Hz), 8.0 TWG(60Hz)/6.4 TWG(50Hz), 8.5 BTG(60Hz)/6.5 BTG(50Hz), 12.5 BTG(60Hz)/10.0 BTG(50Hz), 15.0 BTG/A(60Hz)/12.0 BTG/A(50Hz), 20.0 BEG(60Hz)/16.0 BEG(50Hz), 25.0 BEG(60Hz)/20.0 BEG(50Hz)



23-7201
CARB KIT
Replaces: Westerbeke 38100
Fits: 4.0 BCG(60Hz)/3.0 BCG(50Hz), 4.5 BCG(60Hz)/3.75 BCG(50Hz), 4.5 BCG(60Hz)/3.75 BCG(50Hz), 4.5 BCGTC(60Hz)/3.75 BCGTC(50Hz), 5.0 BCG(60Hz)/4.2 BCG(50Hz), 6.5 BCG(60Hz)/4.8 BCG(50Hz), 7.0 BCG(60Hz)/5.0 BCG(50Hz), 7.0 BCGA(60Hz)/5.0 BCGA(50Hz), 7.0 BCGB(60Hz)/6.0 BCGB(50Hz), 7.2 BCGTC(60Hz)/6.0 BCGTC(50Hz), 8.0 BEG(60Hz)/6.4 BEG(50Hz), 9.6 BCGTC(60Hz)/8.0 BCGTC(50Hz), 10.0 BEG(60Hz)/8.0 BEG(50Hz), 12.5 BEG(60Hz)/10.0 BEG(50Hz), 15.0 BEG(60Hz)/12.0 BEG(50Hz)



23-7202
CARB KIT
Replaces: Kohler GM24510
Fits: 4EF, 5E, 6EF, 7.3E, 5ECD, 4EFCD, 6EFCD and 7.3 ECD



23-7740
FUEL FILTER
Replaces: Kohler 252898
Fits: 11 CCFOZ (variation 2), 11.5 CCFOZ (variation 2), 11EFOZ (variation 2), 11.5EFOZ (variation 2), 13EOZ (variation 2), 13EFOZ (variation 2), 13.5 CCOZ (variation 2), 14 CCOZ (variation 2), 14EOZ (variation 2), 15 CCFOZ (variation 3), 15.5EOZ (variation 2), 16EFOZ (variation 3), 17.5EFOZ (variation 3), 18.5 CCOZ (variation 3), 19EFOZ (variation 3), 20 CCFOZ (variation 3), 20EOZ (variation 3), 20EFOZ (variation 3), 23EOZ (variation 3), 24 CCOZ (variation 3), 24EOZ (variation 3), 17EFOZD (variation 3), 17.5EFOZD (variation 3), 19EFOZD (variation 3), 20EFOZD (variation 3), 20EFOZD (variation 3), 23EOZD (variation 3), 24EOZD (variation 3)



23-7751
FUEL FILTER
Replaces: Kohler 229715
Fits: 4 CCFOZ, 4EFOZ, 5 CCOZ, 5EOZ, 6.5 EFOZ, 8EOZ, 6.5EFOZD, 8EOZD



23-7760

FUEL FILTER

Replaces: Onan A026K278, 149-2106
 Fits: MDKAU, MDKAV, MDKBG, MDKAW (Spacesaver), MDKAZ, MDKBD, MDKBE, MDKBF, MDKBD (w/ Isolated Ground), MDKBE (w/ Isolated Ground), MDKBF (w/ Isolated Ground), MDKAD/E/F



**23-7761
 FUEL FILTER**

Replaces: Kohler GM32359
 Fits: 7 EFOZD(variation 1), 8.5 EFOZD(variation 1), 9 EOZD(variation 1), 9EFOZD(variation 1), 10EOZD(variation 1), 11EFOZD(variation 3), 11.5EFOZD(variation 3), 13EOZD(variation 3), 13EFOZD(variation 3), 14 EOZD(variation 3), 15.5 EOZD(variation 3), 17 EFOZD(variation 1), 17.5EFOZD(variation 1), 19EFOZD(variation 1), 20EOZD(variation 1), 20EFOZD(variation 1), 23EOZD(variation 1), 24EOZD(variation 1), 23EFOZD, 27EFOZD, 28EOZD, 32EOZD



**23-7762
 FUEL FILTER**

Replaces: Kohler 267987
 Fits: 4EF, 5E, 6EF, 7.3E, 8E (GR4 Version), 10E (GR4 Version), 12.5E (GR4 Version)



**23-7764
 FUEL FILTER**

Replaces: Westerbeke 24363
 Fits: 15.0 BTD(60Hz) / 12.0 BTD(50Hz), 15.0 BTDA(60Hz) / 12.0 BTDA(50Hz), 15.0 BTDB(60Hz) / 12.0 BTDB(50Hz), 15.0 WTA(60Hz) / 12.0 WTA(50Hz), 20.0 BED(60Hz) / 16.0 BED(50Hz), 20.0 BEDA(60Hz) / 16.0 BEDA(50Hz), 20.0 WTA(60Hz) / 16.0 WTA(50Hz), 25.0 BED(60Hz) / 20.0 BED(50Hz), 25.0 WTA(60Hz) / 20.0 WTA(50Hz), 32.0 BED(60Hz) / 25.0 BED(50Hz), 32.0 BEDB(60Hz) / 25.0 BEDB(50Hz), 32.0 WTF(60Hz) / 25.0 WTF(50Hz)



**23-7780
 FUEL FILTER**

Replaces: Kohler GM34570
 Fits: 9 EFGD, 10 EG, 10 EGD, 13 EG, 13 EGD, 13 EGZ, 15 EG, 15 EGD, 15 EGZ



**23-7750
 FUEL FILTER ELEMENT**

Replaces: Onan 149-0428
 Fits: MDJA (Spec A-R), MDJB (Spec A-R), MDJC (Spec A-R), MDJE (Spec A), MDJF (Spec A)



**23-7720
 FUEL FILTER KIT**

Replaces: Westerbeke 35920, Onan 149-1445
 Fits: Westerbeke: 4.0 BCG(60Hz)/3.0 BCG(50Hz), 6.5 BCG(60Hz)/4.8 BCG(50Hz), 6.5 TWG(60Hz)/4.9 TWG(50Hz), 8.0 TWG(60Hz)/6.4 TWG(50Hz), 9.0 BTG(60Hz)/7.0 BTG(50Hz), 11.0 TWG(60Hz)/8.5 TWG(50Hz)



**23-7770
 FUEL FILTER KIT**

Replaces: Westerbeke 47006, 30200
 Fits several models. See application chart on page 114-125



**23-7771
 FUEL FILTER KIT**

Replaces: Kohler 249433
 Fits: 3.5 CFZ(Variation 2), 4 CZ(Variation 2), 5 CFZ(Variation 2), 6.5 CZ(Variation 2), 8E(Variation 2), 10E(Variation 2), 12.5E(Variation 2)



**23-1000
 GLOWPLUG (12 Volt)**

Replaces: Westerbeke 24353
 Fits: 4.4 BCD(60Hz), 4.4 WMD(60Hz) / 3.3 WMD(50Hz), 6.0 BCD(60Hz) / 4.5 BCD(50Hz), 7.7 WMD(60Hz) / 5.8 WMD(50Hz), 8.0 BTD(60Hz) / 6.0 BTD(50Hz), 8.0 BTDA(60Hz) / 6.0 BTDA(50Hz), 8.0 WMD(60Hz) / 6.0 WMD(50Hz), 10.0 BTD(60Hz) / 7.5 BTD(50Hz), 10.0 BTDA(60Hz) / 7.5 BTDA(50Hz), 11.0 BTD(60Hz) / 8.3 BTD(50Hz), 11.0 WMD(60Hz) / 8.3 WMD(50Hz), 12.5 BTD(60Hz) / 9.4 BTD(50Hz), 12.5 BTDA(60Hz) / 9.4 BTDA(50Hz), 12.5 BTDB(60Hz) / 9.4 BTDB(50Hz), 12.5 WMD(60Hz) / 9.4 WMD(50Hz), 15.0 BTD(60Hz) / 12.0 BTD(50Hz), 15.0 BTDA(60Hz) / 12.0 BTDA(50Hz), 15.0 BTDB(60Hz) / 12.0 BTDB(50Hz), 15.0 BTDC(60Hz) / 12.0 BTDC(50Hz), 15.0 WTA(60Hz) / 12.0 WTA(50Hz), 20.0 BED(60Hz) / 16.0 BED(50Hz), 20.0 BEDA(60Hz) / 16.0 BEDA(50Hz), 20.0 WTA(60Hz) / 16.0 WTA(50Hz), 25.0 BED(60Hz) / 20.0 BED(50Hz), 25.0 WTA(60Hz) / 20.0 WTA(50Hz), 32.0 BED(60Hz) / 25.0 BED(50Hz), 32.0 BEDB(60Hz) / 25.0 BEDB(50Hz), 32.0 WTF(60Hz) / 25.0 WTF(50Hz)



**23-5840
 TEMPERATURE SENDER**

Replaces: Westerbeke 35109
 Fits several models. See application chart on page 114-125



**23-5880
 OIL PRESSURE SENDER**

Replaces: Westerbeke 24132
 Fits several models. See application chart on page 114-125



**23-2000
IMPELLER**
Replaces: Westerbeke 33112
(Impeller Only)
Fits: 6.5 TWG(60Hz)/4.9 TWG(50Hz), 8.0 TWG(60Hz)/6.4 TWG(50Hz), 8.5 BTG(60Hz)/6.5 BTG(50Hz), 11.0 TWG(60Hz)/8.5 TWG(50Hz), 12.5 BTG(60Hz)/10.0 BTG(50Hz), 15.0 BTG(60Hz)/12.0 BTG(50Hz), 15.0 BTGA(60Hz)/12.0 BTGA(50Hz), 20.0 WTA(60Hz)/16.0 WTA(50Hz)



**23-2001
IMPELLER**
Replaces: Westerbeke 32620
(Impeller Only)
Fits: 4.0 BCG(60Hz)/3.0 BCG(50Hz), 4.5 BCG(60Hz)/3.75 BCG(50Hz), 4.5 BCGB(60Hz)/3.75 BCGB(50Hz), 4.5 BCGTC(60Hz)/3.75 BCGTC(50Hz), 6.5 BCG(60Hz)/4.8 BCG(50Hz), 7.0 BCG(60Hz)/5.0 BCG(50Hz), 7.0 BCGA(60Hz)/5.0 BCGA(50Hz), 7.0 BCGB(60Hz)/6.0 BCGB(50Hz), 7.2 BCGTC(60Hz)/6.0 BCGTC(50Hz), 9.0 BTG(60Hz)/7.0 BTG(50Hz), 9.6 BCGTC(60Hz)/8.0 BCGTC(50Hz), 3.0 WMD(60Hz)/2.4 WMD(50Hz), 3.8/4.2 BCDT(60Hz) / 3.5 BCDT(50Hz), 5.0 BCG(60Hz)/4.2 BCG(50Hz), 5.0 BCGA(60Hz)/5.2 BCGA(50Hz), 7.0 BCGC(60Hz)/5.9 BCGC(50Hz), 8.0 BEG(60Hz)/6.4 BEG(50Hz), 10.0 BEG(60Hz)/8.0 BEG(50Hz), 12.5 BEG(60Hz)/10.0 BEG(50Hz), 15.0 BEG(60Hz)/12.0 BEG(50Hz)



**23-2002
IMPELLER**
Replaces: Kohler 229826
Fits: 8E (SN 296899 and Up), 10E (SN 296899 and Up), 12.5E (SN 296899 and Up), 12.5CF (SN 296899 and Up), 15C, 16CF, 20C



**23-2003
IMPELLER**
Replaces: Kohler 250872, Jabsco 22799-0001
Fits: 8E (SN 296898 and Below), 10E (SN 296898 and Below), 12.5E (SN 296898 and Below), 12.5CF (SN 296898 and Below)



**23-2004
IMPELLER KIT**
Replaces: Kohler 359978(impeller only)
Fits Kohler Pump GM28487; Fits Models 4EF, 5E, 6EF, 7.3E, 4 EFCD, 5 ECD, 6 EFCD, 7.3 ECD,



**23-2005
IMPELLER KIT**
Replaces: Northern Lights 25-12009
(impeller only)



**23-3300
IMPELLER KIT**
Replaces: Onan 132-0349
Fits: MDKAW, MDKKB, MDKAW (Spacesaver), MDKAZ, MDKBD, MDKBE, MDKBF, MDKBD (w/ Isolated Ground), MDKBE (w/ Isolated Ground), MDKBF (w/ Isolated Ground)



**23-3301
IMPELLER KIT**
Replaces: Westerbeke 11907
Fits: 20.0 BEG(60Hz)/16.0 BEG(50Hz), 25.0 BEG(60Hz)/20.0 BEG(50Hz), 20.0 SBEG(60Hz)/16.0 SBEG(50Hz), 20.0 SBEGA(60Hz)/16.0 SBEGA(50Hz), 22.5 SBEG(60Hz)/18.7 SBEG(50Hz), 22.5 SBEGA(60Hz)/18.7 SBEGA(50Hz), 20.0 BED(60Hz)/16.0 BED(50Hz), 20.0 BEDA(60Hz)/16.0 BEDA(50Hz), 25.0 BED(60Hz)/20.0 BED(50Hz), 25.0 WTA(60Hz)/20.0 WTA(50Hz), 32.0 BED(60Hz)/25.0 BED(50Hz), 32.0 BEDA(60Hz)/25.0 BEDA(50Hz), 32.0 BEDB(60Hz)/25.0 BEDB(50Hz), 32.0 WTF(60Hz)/25.0 WTF(50Hz)



**23-3302
IMPELLER KIT**
Replaces: Westerbeke 33112
Fits: 6.5 TWG(60Hz)/4.9 TWG(50Hz), 8.0 TWG(60Hz)/6.4 TWG(50Hz), 8.5 BTG(60Hz)/6.5 BTG(50Hz), 11.0 TWG(60Hz)/8.5 TWG(50Hz), 12.5 BTG(60Hz)/10.0 BTG(50Hz), 15.0 BTG(60Hz)/12.0 BTG(50Hz), 15.0 BTGA(60Hz)/12.0 BTGA(50Hz), 20.0 WTA(60Hz)/16.0 WTA(50Hz)



**23-3303
IMPELLER KIT**
Replaces: Kohler 229826
Fits: Kohler Pump GM46962; Fits: Models 8E (SN 296899 and Up), 10E (SN 296899 and Up), 12.5E (SN 296899 and Up), 12.5CF (SN 296899 and Up), 15C, 16CF, 20C



**23-3304
IMPELLER KIT**
Replaces: Kohler 229955
Fits: 8E (SN 296898 and Below), 10E (SN 296898 and Below), 12.5E (SN 296898 and Below), 12.5CF (SN 296898 and Below)



**23-3305
IMPELLER KIT**
Replaces: Westerbeke 32620
Fits: 4.0 BCG(60Hz)/3.0 BCG(50Hz), 4.5CG(60Hz)/3.75 BCG(50Hz), 4.5 BCGB(60Hz)/3.75 BCGB(50Hz), 4.5 BCGTC(60Hz)/3.75 BCGTC(50Hz), 6.5 BCG(60Hz)/4.8 BCG(50Hz), 7.0 BCG(60Hz)/5.0 BCG(50Hz), 7.0 BCGA(60Hz)/5.0 BCGA(50Hz), 7.0 BCGB(60Hz)/6.0 BCGB(50Hz), 7.2 BCGTC(60Hz)/6.0 BCGTC(50Hz), 9.0 BTG(60Hz)/7.0 BTG(50Hz), 9.6 BCGTC(60Hz)/8.0 BCGTC(50Hz), 3.0 WMD(60Hz)/2.4 WMD(50Hz), 3.8/4.2 BCDT(60Hz) / 3.5 BCDT(50Hz)



23-3306
IMPELLER KIT
 Replaces: Westerbeke 46622
 Fits: 5.0 BCG(60Hz)/4.2 BCG(50Hz), 5.0 BCGA(60Hz)/5.2 BCGA(50Hz), 7.0 BCGC(60Hz)/5.9 BCGC(50Hz), 8.0 BEG(60Hz)/6.4 BEG(50Hz), 10.0 BEG(60Hz)/8.0 BEG(50Hz), 12.5 BEG(60Hz)/10.0 BEG(50Hz), 15.0 BEG(60Hz)/12.0 BEG(50Hz)



23-3307
IMPELLER KIT
 Replaces: Westerbeke 34440
 Fits: 4.0 BCD(60Hz), 4.4 BCD(60Hz), 4.4 WMD(60Hz)/3.3 WMD(50Hz), 5.0 BCD(60Hz)/4.0 BCD(50Hz), 5.0 BCDA(60Hz)/4.0 BCDA(50Hz), 5.0 BCDB(60Hz)/4.0 BCDB(50Hz), 6.0 BCD(60Hz)/4.5 BCD(50Hz), 7.6 BTD(60Hz)/5.7 BTD(50Hz), 7.7 WMD(60Hz)/5.8 WMD(50Hz), 8.0 BTD(60Hz)/6.0 BTD(50Hz), 8.0 BTDA(60Hz)/6.0 BTDA(50Hz), 8.0 WMD(60Hz)/6.0 WMD(50Hz), 10.0 BTD(60Hz)/7.5 BTD(50Hz), 10.0 BTDA(60Hz)/7.5 BTDA(50Hz), 11.0 BTD(60Hz)/8.3 BTD(50Hz), 11.0 WMD(60Hz)/8.3 WMD(50Hz), 12.5 BTD(60Hz)/9.4 BTD(50Hz), 12.5 BTDA(60Hz)/9.4 BTDA(50Hz), 12.5 BTDB(60Hz)/9.4 BTDB(50Hz), 12.5 WMD(60Hz)/9.4 WMD(50Hz), 15.0 BTDC(60Hz)/12.0 BTDC(50Hz)



23-3308
IMPELLER KIT
 Replaces: Kohler 352122
 Fits: 33EFOZ, 33 CFOZ, 40 CFOZ, 40EOZ, 40EFOZ, 50 COZ, 50 CFOZ, 50EOZ, 55EFOZ, 65 COZ, 65EOZ, 70EFOZ, 80EOZ, 80EFOZ, 99EOZ



23-3309
IMPELLER KIT
 Replaces: Onan 132-0436
 Fits: MDDCA, MDDCB, MDDCC, MDDCF, MDDCG, MDDCD, MDDCE, MDDCH, MDDCJ



23-3310
IMPELLER KIT
 Replaces: Onan 541-1519
 Fits: MDKKB, MDKBL, MDKBM, MDKBN, MDKAL/A/B



23-3311
IMPELLER KIT
 Replaces: Fischer Panda J009-46840
 Mase 80161
 Fits: AGTPM 4, PMS 4, IS 2.5, IS 4.0, IS 4.7, IS 7.1



23-3312
IMPELLER KIT
 Replaces: Fischer Panda J009-1027B-1
 Mase 92911
 Fits: IS 13.2, IS 10.2, IS 14.0, IS 19.0, IS 23.1T, PMS 15, PMS 16 DP, PMS 20, PMS 22, PMS 25, PMS 30, PMS 40, PMS 50



23-3313
IMPELLER KIT
 Replaces: Westerbeke 33104
 Fits: 15.0 BTD(60Hz) / 12.0 BTD(50Hz), 15.0 BTDA(60Hz) / 12.0 BTDA(50Hz), 15.0 BTDB(60Hz) / 12.0 BTDB(50Hz), 15.0 WTA(60Hz) / 12.0 WTA(50Hz)



23-3314
IMPELLER KIT
 Replaces: Kohler 359978
 Fits Kohler Pump GM28487; Fits Models 4EF, 5E, 6EF, 7.3E, 4 EFCD, 5 ECD, 6 EFCD, 7.3 ECD,

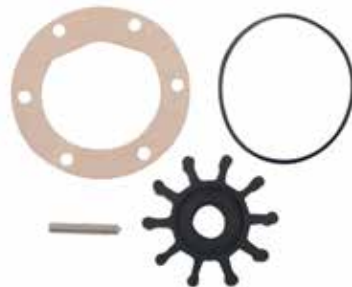

23-3315
IMPELLER KIT
 Replaces: Northern Lights 25-12009
 Fits: M673LD3, M673L3, M673LD2, M673L2



23-0400
QUAD RING
 Replaces: Northern Lights 25-12031



23-4005
SEA WATER PUMP BELT
 Replaces: Westerbeke 13810
 Fits: 32.0 BED(60Hz) / 25.0 BED(50Hz), 32.0 BEDA(60Hz) / 25.0 BEDA(50Hz), 32.0 BEDB(60Hz) / 25.0 BEDB(50Hz)



23-4006
SEA WATER PUMP BELT
 Replaces: Westerbeke 31152
 Fits: 20.0 BED(60Hz) / 16.0 BED(50Hz), 20.0 BEDA(60Hz) / 16.0 BEDA(50Hz), 20.0 WTA(60Hz) / 16.0 WTA(50Hz), 25.0 BED(60Hz) / 20.0 BED(50Hz)



23-4007
SEA WATER PUMP BELT
 Replaces: Westerbeke 30376
 Fits: 4.0 BCD(60Hz), 4.4 BCD(60Hz), 4.4 WMD(60Hz) / 3.3 WMD(50Hz), 5.0 BCD/BCDA/BCDB(60Hz) / 4.0 BCD/BCDA/BCDB(50Hz)



23-3600
THERMOSTAT
 Replaces: Westerbeke 24688
Temperature Rating: 180°
 Fits: 3.0 WMD(60Hz)/2.4 WMD(50Hz), 4.4 BCD(60Hz), 4.4 WMD(60Hz) / 3.3 WMD(50Hz), 7.7 WMD(60Hz) / 5.8 WMD(50Hz), 8.0 BTD(60Hz) / 6.0 BTD(50Hz), 8.0 BTDA(60Hz) / 6.0 BTDA(50Hz), 8.0 WMD(60Hz) / 6.0 WMD(50Hz), 10.0 BTD(60Hz) / 7.5 BTD(50Hz), 10.0 BTDA(60Hz) / 7.5 BTDA(50Hz), 11.0 BTD(60Hz) / 8.3 BTD(50Hz), 11.0 WMD(60Hz) / 8.3 WMD(50Hz), 12.5 BTD(60Hz) / 9.4 BTD(50Hz), 12.5 BTDA(60Hz) / 9.4 BTDA(50Hz), 12.5 BTDB(60Hz) / 9.4 BTDB(50Hz), 12.5 WMD(60Hz) / 9.4 WMD(50Hz), 12.6 BTD(60Hz) / 10.4 BTD(50Hz), 15.0 BTD(60Hz) / 12.0 BTD(50Hz), 15.0 BTDC(60Hz) / 12.0 BTDC(50Hz), 20.0 SBEG(60Hz) / 16.0 SBEG(50Hz), 20.0 SBEGA(60Hz) / 16.0 SBEGA(50Hz), 22.5 SBEG(60Hz) / 18.7 SBEG(50Hz), 22.5 SBEGA(60Hz) / 18.7 SBEGA(50Hz)



23-3601
THERMOSTAT
 Replaces: Westerbeke 35736
Temperature Rating: 140°
 Fits: 6.5 BCG(60Hz)/4.8 BCG(50Hz), 6.5 TWG(60Hz)/4.9 TWG(50Hz), 8.0 TWG(60Hz)/6.4 TWG(50Hz), 8.5 BTG(60Hz)/6.5 BTG(50Hz), 9.0 BTG(60Hz)/7.0 BTG(50Hz), 11.0 TWG(60Hz)/8.5 TWG(50Hz), 12.5 BTG(60Hz)/10.0 BTG(50Hz), 15.0 BTG/A(60Hz)/12.0 BTG/A(50Hz), 20.0 BEG(60Hz)/16.0 BEG(50Hz), 25.0 BEG(60Hz)/20.0 BEG(50Hz)



23-3602
THERMOSTAT
 Replaces: Westerbeke 37387
Temperature Rating: 140°
 Fits: 4.5 BCG(60Hz)/3.75 BCG(50Hz), 7.0 BCG(60Hz)/5.0 BCG(50Hz), 7.0 BCGA(60Hz)/5.0 BCGA(50Hz)



23-3603
THERMOSTAT
 Replaces: Westerbeke 39378
Temperature Rating: 160°
 Fits: 4.5 BCGB(60Hz)/3.75 BCGB(50Hz), 4.5 BCGTC(60Hz)/3.75 BCGTC(50Hz), 5.0 BCG(60Hz)/4.2 BCG(50Hz), 5.0 BCGA(60Hz)/5.2 BCGA(50Hz), 7.0 BCGB(60Hz)/6.0 BCGB(50Hz), 7.0 BCGC(60Hz)/5.9 BCGC(50Hz), 7.2 BCGTC(60Hz)/6.0 BCGTC(50Hz), 5.0 SBEG(60Hz)/4.0 SBEG(50Hz), 6.5 SBEG(60Hz) / 5.4 SBEG(50Hz)



23-3604
THERMOSTAT
 Replaces: Westerbeke 46097
Temperature Rating: 140°
 Fits: 8.0 BEG(60Hz)/6.4 BEG(50Hz), 10.0 BEG(60Hz)/8.0 BEG(50Hz), 12.5 BEG(60Hz)/10.0 BEG(50Hz), 15.0 BEG(60Hz)/12.0 BEG(50Hz)



23-3605
THERMOSTAT
 Replaces: Westerbeke 24690
Temperature Rating: 180°
 Fits: 8.0 SBEG(60Hz) / 6.4 SBEG(50Hz), 10.0 SBEG(60Hz) / 8.0 SBEG(50Hz), 12.5 SBEG(60Hz) / 10.0 SBEG(50Hz), 14.0 SBEG(60Hz) / 11.6 SBEG(50Hz), 15.0 BTDA(60Hz) / 12.0 BTDA(50Hz), 15.0 BTDB(60Hz) / 12.0 BTDB(50Hz), 20.0 BED(60Hz) / 16.0 BED(50Hz), 20.0 BEDA(60Hz) / 16.0 BEDA(50Hz), 20.0 WTA(60Hz) / 16.0 WTA(50Hz), 25.0 BED(60Hz) / 20.0 BED(50Hz)



23-3606
THERMOSTAT
 Replaces: Onan 309-0130
Temperature Rating: 143°
 Fits: MDJA, MDJB, MDJC, MDJE, MDJF, MJA, MJB, MJC



23-3607
THERMOSTAT
 Replaces: Kohler 352018
Temperature Rating: 195°
 Fits: 33EFOZ(Variation 1), 33 CFOZ(Variation 1), 40 CFOZ(Variation 1), 40EFOZ(Variation 1), 40EFOZ(Variation 1), 50 COZ(Variation 1), 50 CFOZ(Variation 1), 50EOZ(Variation 1), 55EFOZ(Variation 1), 65 COZ(Variation 1), 65EOZ(Variation 1), 70EFOZ(Variation 1), 80EOZ(Variation 1), 80EFOZ(Variation 1), 99EOZ(Variation 1), 100EFOZ(Variation 1), 125EOZ(Variation 1), 125EFOZ(Variation 1), 150EOZ(Variation 1)



23-3608
THERMOSTAT
 Replaces: Kohler 249930
Temperature Rating: 190°
 Fits: 4EF, 5E, 6EF, 7.3E, 8E, 10E, 12.5E, 12.5CF, 15C, 16CF, 20C



23-3609
THERMOSTAT
 Replaces: Kohler 252896
Temperature Rating: 170°
 Fits: 11 CCFZ, 11.5 CCFZ, 11EFOZ, 11.5EFOZ, 13EFOZ, 13EFOZ, 13.5 CCOZ, 14 CCOZ, 14 EOZ, 15.5EOZ, 16EFOZ, 17.5EFOZ, 18.5 CCOZ, 19EFOZ, 20 CCFZ, 20EOZ, 20EFOZ, 23EOZ, 24 CCOZ, 24EOZ



23-3610
THERMOSTAT
 Replaces: Kohler 267717
Temperature Rating: 180°
 Fits: 3.5 CFZ, 3.5 EFZ, 4 CZ, 4 ESZ, 5 CFZ, 5 EFZ, 6.5 CZ, 6.5 ESZ



23-0800
THERMOSTAT GASKET
 Replaces: Westerbeke 42260
 Fits: 4.5 BCG(60Hz)/3.75 BCG(50Hz), 4.5 BCGTC(60Hz)/3.75 BCGTC(50Hz), 7.0 BCG(60Hz)/6.0 BCG(50Hz), 7.2 BCGTC(60Hz)/ 6.0 BCGTC(50Hz), 9.6 BCGTC(60Hz)/8.0 BCGTC(50Hz)



23-0801
THERMOSTAT GASKET
 Replaces: Westerbeke 46124
 Fits: 5.0 BCG(60Hz)/4.2 BCG(50Hz), 5.0 BCGA(60Hz)/5.2 BCGA(50Hz), 7.0 BCGC(60Hz)/5.9 BCGC(50Hz), 5.0 SBCG(60Hz) / 4.2 SBEG(50Hz), 6.5 SBCG(60Hz) / 5.4 SBEG(50Hz)



23-0802
THERMOSTAT GASKET
 Replaces: Westerbeke 34196
 Fits: 4.0 BCG(60Hz)/3.0 BCG(50Hz), 6.5 BCG(60Hz)/4.8 BCG(50Hz), 8.0 TWG(60Hz)/6.4 TWG(50Hz), 9.0 BTG(60Hz)/7.0 BTG(50Hz), 11.0 TWG(60Hz)/8.5 TWG(50Hz), 6.0 BCD(60Hz) / 4.5 BCD(50Hz), 8.0 BTD(60Hz) / 6.0 BTD(50Hz), 10.0 BTD(60Hz) / 7.5 BTD(50Hz), 11.0 BTD(60Hz) / 8.3 BTD(50Hz), 12.5 BTD(60Hz) / 9.4 BTD(50Hz), 12.5 BTDA(60Hz) / 9.4 BTDA(50Hz), 12.6 BTD(60Hz) / 10.4 BTD(50Hz)



23-0803
THERMOSTAT GASKET
 Replaces: Westerbeke 33417
 Fits: 6.5 TWG(60Hz)/4.9 TWG(50Hz), 8.0 BEG(60Hz)/6.4 BEG(50Hz), 8.5 BTG(60Hz)/6.5 BTG(50Hz), 10.0 BEG(60Hz)/8.0 BEG(50Hz), 12.5 BEG(60Hz)/10.0 BEG(50Hz), 12.5 BTG(60Hz)/10.0 BTG(50Hz), 15.0 BEG(60Hz)/12.0 BEG(50Hz), 15.0 BTG/A(60Hz)/ 12.0 BTG/A(50Hz), 8.0 SBEG(60Hz) / 6.4 SBEG(50Hz), 10.0 SBEG(60Hz) / 8.0 SBEG(50Hz), 12.5 SBEG(60Hz) / 10.0 SBEG(50Hz), 14.0 SBEG(60Hz) / 11.6 SBEG(50Hz)



23-0804
THERMOSTAT GASKET
 Replaces: Westerbeke 33373
 Fits: 15.0 BTDA(60Hz) / 12.0 BTDA(50Hz), 15.0 BTDB(60Hz) / 12.0 BTDB(50Hz), 15.0 WTA(60Hz) / 12.0 WTA(50Hz), 20.0 BED(60Hz) / 16.0 BED(50Hz), 20.0 BEDA(60Hz) / 16.0 BEDA(50Hz), 20.0 WTA(60Hz) / 16.0 WTA(50Hz), 25.0 BED(60Hz) / 20.0 BED(50Hz), 25.0 WTA(60Hz) / 20.0 WTA(50Hz)



23-0805
THERMOSTAT GASKET
 Replaces: Westerbeke 40434
 Fits: 20.0 BEG(60Hz)/16.0 BEG(50Hz), 25.0 BEG(60Hz)/20.0 BEG(50Hz), 20.0 SBEG(60Hz) / 16.0 SBEG(50Hz), 20.0 SBEGA(60Hz) / 16.0 SBEG(50Hz), 22.5 SBEG(60Hz) / 18.7 SBEG(50Hz), 22.5 SBEGA(60Hz) / 18.7 SBEGA(50Hz)



23-0806
THERMOSTAT GASKET
 Replaces: Westerbeke 24323
 Fits: 4.4 BCD(60Hz), 4.4 WMD(60Hz) / 3.3 WMD(50Hz), 7.7 WMD(60Hz) / 5.8 WMD(50Hz), 8.0 WMD(60Hz) / 6.0 WMD(50Hz), 11.0 WMD(60Hz) / 8.3 WMD(50Hz), 12.5 WMD(60Hz) / 9.4 WMD(50Hz)



23-0807
THERMOSTAT GASKET
 Replaces: Westerbeke 33966
 Fits: 15.0 BTD(60Hz) / 12.0 BTD(50Hz)



23-0808
THERMOSTAT GASKET
 Replaces: Westerbeke 37922
 Fits: 4.5 BCG(60Hz)/3.75 BCG(50Hz), 7.0 BCG(60Hz)/ 5.0 BCG(50Hz), 7.0 BCGA(60Hz)/5.0 BCGA(50Hz)



23-0809
THERMOSTAT GASKET
 Replaces: Kohler 267718
 Fits: 3.5CFZ, 4CZ, 5CFZ, 6.5CZ



23-0810
THERMOSTAT GASKET
 Replaces: Kohler 229432
 Fits: 11CCFOZ(variation 1,6), 11.5CCFOZ(variation 1,6), 11EFOZ(variation 1,6), 11.5EFOZ(variation 1,6), 13EOZ(variation 1,6), 13EFOZ(variation 1,6), 13.5CCOZ(variation 1,6), 14CCOZ(variation 1,6), 14EOZ(variation 1,6), 15CCFOZ, 15.5EOZ(variation 1,6), 16EFOZ, 17.5EFOZ, 18.5CCOZ, 19EFOZ, 20CCFOZ, 20EOZ, 20EFOZ, 23EOZ, 24CCOZ, 24EOZ



23-0811
THERMOSTAT GASKET
 Replaces: Kohler 249865
 Fits: 11CCFOZ(variation 2,3,4,5), 11.5CCFOZ(variation 2,3,4,5), 11EFOZ(variation 2,3,4,5), 11.5EFOZ(variation 2,3,4,5), 13EOZ(variation 2,3,4,5), 13EFOZ(variation 2,3,4,5), 13.5CCOZ(variation 2,3,4,5), 14CCOZ(variation 2,3,4,5), 14EOZ(variation 2,3,4,5), 15.5EOZ(variation 2,3,4,5), 11EFOZD, 11.5EFOZD, 13EOZD, 13EFOZD, 14EOZD, 15.5EOZD, 17EFOZD, 17.5EFOZD, 19EFOZD, 20EOZD, 20EFOZD, 23EOZD, 24EOZD



23-0812
THERMOSTAT GASKET
 Replaces: Kohler 229433
 Fits: 11 CCFDZ, 11.5 CCFDZ, 11EFOZ, 11.5EFOZ, 13EOZ, 13EFOZ, 13.5 CCOZ, 14 CCOZ, 14 EOZ, 15 CCFDZ, 15.5EFOZ, 16EFOZ, 17.5EFOZ, 18.5 CCOZ, 19EFOZ, 20 CCFDZ, 20EOZ, 20EFOZ, 23EOZ, 24 CCOZ, 24EOZ, 11EFOZD, 11.5EFOZD, 13EFOZD, 14 EOZD, 15.5 EOZD, 17 EFOZD, 17.5EFOZD, 19EFOZD, 20EOZD, 20EFOZD, 23EOZD, 24EOZD



23-0813
THERMOSTAT GASKET
 Replaces: Kohler 229963
 Fits: 8E, 10E, 12.5E, 12.5CF, 15C, 16CF, 20C, 10EG, 13EG, 13EGZ, 15EG, 15EGZ, 4CCFOZ, 4EFOZ, 5CCOZ, 5EOZ, 6.5EFOZ, 8CCFOZ, 8EOZ, 8EFOZ, 9CCOZ, 9EOZ, 9EFOZ, 10EOZ, 23EFOZ, 27EFOZ, 28EOZ, 32EOZ, 6.5EFOZD, 7EFOZD, 8EOZD, 8.5EFOZD, 9EOZD, 9EFOZD, 10EOZD



23-0814
THERMOSTAT GASKET
 Replaces: Kohler 352031
 Fits: 33EFOZ(variation 1,2,3), 33CFOZ(variation 1,2,3), 40CFOZ(variation 1,2,3), 40EOZ(variation 1,2,3), 40EFOZ(variation 1,2,3), 50COZ(variatin 1,2,3), 50CFOZ(variation 1,2,3), 50EOZ(variation 1,2,3), 55EFOZ(variation 1,2,3), 65COZ(variation 1,2,3), 65EOZ(variation 1,2,3), 70EFOZ(variation 1,2,3), 80EOZ(variation 1,2,3), 80EFOZ(variation 1,2,3), 99EOZ(variation 1,2,3), 100EFOZ(variation 1,2,3), 125EOZ(variation 1,2,3), 125EFOZ(variation 1,2,3), 150EOZ(variation 1,2,3)



23-0830
THERMOSTAT GASKET
 Replaces: Northern Lights 11-10015
 Fits: Used with 35-12500 and 35-11000 thermostats



23-3650
THERMOSTAT KIT
 Replaces: Westerbeke 24688 & 24323
Temperature Rating: 180°
 Fits: 4.4 BCD(60Hz), 4.4 WMD(60Hz) / 3.3 WMD(50Hz), 7.7 WMD(60Hz) / 5.8 WMD(50Hz), 8.0 WMD(60Hz) / 6.0 WMD(50Hz), 11.0 WMD(60Hz) / 8.3 WMD(50Hz), 12.5 WMD(60Hz) / 9.4 WMD(50Hz)



23-3651
THERMOSTAT KIT
 Replaces: Westerbeke 35736 & 34196
Temperature Rating: 140°
 Fits: 4.0 BCG(60Hz)/3.0 BCG(50Hz), 6.5 BCG(60Hz)/4.8 BCG(50Hz), 8.0 TWG(60Hz)/6.4 TWG(50Hz), 9.0 BTG(60Hz)/7.0 BTG(50Hz), 11.0 TWG(60Hz)/8.5 TWG(50Hz)



23-3652
THERMOSTAT KIT
 Replaces: Westerbeke 35736 & 33417
Temperature Rating: 140°
 Fits: 6.5 TWG(60Hz)/4.9 TWG(50Hz), 8.5 BTG(60Hz)/6.5 BTG(50Hz), 12.5 BTG(60Hz)/10.0 BTG(50Hz), 15.0 BTG/A(60Hz)/12.0 BTG/A(50Hz)



23-3653
THERMOSTAT KIT
 Replaces: Westerbeke 24688 & 34196
Temperature Rating: 180°
 Fits: 8.0 BTD(60Hz) / 6.0 BTD(50Hz), 10.0 BTD(60Hz) / 7.5 BTD(50Hz), 11.0 BTD(60Hz) / 8.3 BTD(50Hz), 12.5 BTD(60Hz) / 9.4 BTD(50Hz), 12.5 BTDA(60Hz) / 9.4 BTDA(50Hz), 12.6 BTD(60Hz) / 10.4 BTD(50Hz)



23-3654
THERMOSTAT KIT
 Replaces: Westerbeke 39378 & 42260
Temperature Rating: 160°
 Fits: 4.5 BCGB(60Hz)/3.75 BCGB(50Hz), 4.5 BCGTC(60Hz)/3.75 BCGTC(50Hz), 7.0 BCGB(60Hz)/6.0 BCGB(50Hz), 7.2 BCGTC(60Hz) / 6.0 BCGTC(50Hz), 9.6 BCGTC(60Hz)/8.0 BCGTC(50Hz)



23-3655
THERMOSTAT KIT
 Replaces: Westerbeke 39378 & 46124
Temperature Rating: 160°
 Fits: 5.0 BCG(60Hz)/4.2 BCG(50Hz), 5.0 BCGA(60Hz)/5.2 BCGA(50Hz), 7.0 BCGC(60Hz)/5.9 BCGC(50Hz), 5.0 SBGC(60Hz) / 4.0 SBEG(50Hz), 6.5 SBGC(60Hz) / 5.4 SBGC(50Hz)



23-3656
THERMOSTAT KIT
 Replaces: Westerbeke 46097 & 33417
Temperature Rating: 140°
 Fits: 8.0 BEG(60Hz)/6.4 BEG(50Hz), 10.0 BEG(60Hz)/8.0 BEG(50Hz), 12.5 BEG(60Hz)/10.0 BEG(50Hz), 15.0 BEG(60Hz)/12.0 BEG(50Hz)



23-3657
THERMOSTAT KIT
 Replaces: Westerbeke 24690 & 33417
Temperature Rating: 180°
 Fits: 8.0 SBEG(60Hz) / 6.4 SBEG(50Hz), 10.0 SBEG(60Hz) / 8.0 SBEG(50Hz), 12.5 SBEG(60Hz) / 10.0 SBEG(50Hz), 14.0 SBEG(60Hz) / 11.6 SBEG(50Hz)



23-3658
THERMOSTAT KIT
 Replaces: Westerbeke 24688 & 33966
Temperature Rating: 180°
 Fits: 15.0 BTD(60Hz) / 12.0 BTD(50Hz)



23-3659
THERMOSTAT KIT
 Replaces: Westerbeke 37387 & 37922
Temperature Rating: 140°
 Fits: 4.5 BCG(60Hz)/3.75 BCG(50Hz), 7.0 BCG(60Hz)/5.0 BCG(50Hz), 7.0 BCGA(60Hz)/5.0 BCGA(50Hz)



23-3660
THERMOSTAT KIT
 Replaces: Westerbeke 24690, 33373
Temperature Rating: 180°
 Fits: 15.0 BTDA(60Hz) / 12.0 BTDA(50Hz), 15.0 BTDB(60Hz) / 12.0 BTDB(50Hz), 15.0 WTA(60Hz) / 12.0 WTA(50Hz), 20.0 BED(60Hz) / 16.0 BED(50Hz), 20.0 BEDA(60Hz) / 16.0 BEDA(50Hz), 20.0 WTA(60Hz) / 16.0 WTA(50Hz), 25.0 BED(60Hz) / 20.0 BED(50Hz), 25.0 WTA(60Hz) / 20.0 WTA(50Hz)

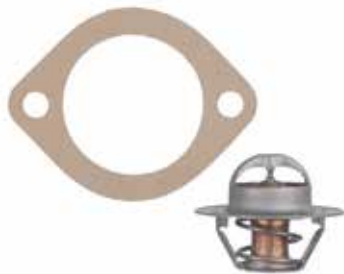

23-3661
THERMOSTAT KIT
 Replaces: Westerbeke 35736, 40434
Temperature Rating: 140°
 Fits: 20.0 BEG(60Hz)/16.0 BEG(50Hz), 25.0 BEG(60Hz)/20.0 BEG(50Hz),



23-3662
THERMOSTAT KIT
 Replaces: Westerbeke 24688, 40434
Temperature Rating: 180°
 Fits: 20.0 SBEG(60Hz) / 16.0 SBEG(50Hz), 20.0 SBEGA(60Hz) / 16.0 SBEGA(50Hz), 22.5 SBEG(60Hz) / 18.7 SBEG(50Hz), 22.5 SBEGA(60Hz) / 18.7 SBEGA(50Hz)



23-3663
THERMOSTAT KIT
 Replaces: Kohler 267717, 267718
Temperature Rating: 180°
 Fits: 3.5 CFZ, 4 CZ, 5 CFZ, 6.5 CZ



23-3664
THERMOSTAT KIT
 Replaces: Kohler 249970, 29963
Temperature Rating: 190°
 Fits: 8E, 10E, 12.5E, 12.5CF, 15C, 16CF, 20C, 10 EG, 13 EG, 13 EGZ, 15 EG, 15 EGZ



23-3665
THERMOSTAT KIT
 Replaces: Kohler 252896, 229432
Temperature Rating: 170°
 Fits: 11 CCFOZ(Variation 1,6), 11.5 CCFOZ(Variation 1, 6), 11EFOZ(Variation 1, 6), 11.5EFOZ(Variation 1, 6), 13EFOZ(Variation 1, 6), 13EFOZ(Variation 1, 6), 13.5 CCOZ(Variation 1, 6), 14 CCOZ(Variation 1, 6), 14 EOZ(Variation 1, 6), 15.5EOZ(Variation 1, 6), 16EFOZ, 17.5EFOZ, 18.5 CCOZ, 19EFOZ, 20 CCFOZ, 20EOZ, 20EFOZ, 23EOZ, 24 CCOZ, 24EOZ



23-3666
THERMOSTAT KIT
 Replaces: Kohler 352018, 352031
Temperature Rating: 195°
 Fits: 33EFOZ(Variation 1), 33 CFOZ(Variation 1), 40 CFOZ(Variation 1), 40EOZ(Variation 1), 40EFOZ(Variation 1), 50 COZ(Variation 1), 50 CFOZ(Variation 1), 50EOZ(Variation 1), 55EFOZ(Variation 1), 65 COZ(Variation 1), 65EOZ(Variation 1), 70EFOZ(Variation 1), 80EOZ(Variation 1), 80EFOZ(Variation 1), 99EOZ(Variation 1), 100EFOZ(Variation 1), 125EOZ(Variation 1), 125EFOZ(Variation 1), 150EOZ(Variation 1)



23-2700
DISTRIBUTOR CAP
 Replaces: Westerbeke 40859
 Fits: 20.0 BEG(60Hz)/16.0 BEG(50Hz), 25.0 BEG(60Hz)/20.0 BEG(50Hz), 20.0 SBEG(60Hz) / 16.0 SBEG(50Hz), 20.0 SBEGA(60Hz) / 16.0 SBEGA(50Hz), 22.5 SBEG(60Hz) / 18.7 SBEG(50Hz), 22.5 SBEGA(60Hz) / 18.7 SBEGA(50Hz)



23-2701
DISTRIBUTOR CAP
 Replaces: Westerbeke 34113
 Fits: 6.5 TWG(60Hz)/4.9 TWG(50Hz), 8.0 TWG(60Hz)/6.4 TWG(50Hz), 11.0 TWG(60Hz)/8.5 TWG(50Hz), 8.5 BTG(60Hz)/6.5 BTG(50Hz), 12.5 BTG(60Hz)/10.0 BTG(50Hz), 15.0 BTG/A(60Hz)/12.0 BTG/A(50Hz)



23-2702
DISTRIBUTOR CAP
 Replaces: Westerbeke 35608
 Fits: 6.5 BCG(60Hz)/4.8 BCG(50Hz), 9.0 BTG(60Hz)/7.0 BTG(50Hz)



23-2703
DISTRIBUTOR CAP
 Replaces: Westerbeke 46592
 Fits: 8.0 BEG(60Hz)/6.4 BEG(50Hz), 10.0 BEG(60Hz)/8.0 BEG(50Hz), 12.5 BEG(60Hz)/10.0 BEG(50Hz), 15.0 BEG(60Hz)/12.0 BEG(50Hz), 8.0 SBEG(60Hz) / 6.4 SBEG(50Hz), 10.0 SBEG(60Hz) / 8.0 SBEG(50Hz), 12.5 SBEG(60Hz) / 10.0 SBEG(50Hz), 14.0 SBEG(60Hz) / 11.6 SBEG(50Hz)



23-4500

PLUG WIRE SET

Replaces: Westerbeke 43060

Fits: 4.5 BCGB(60Hz)/3.75 BCGB(50Hz), 4.5 BCGTC(60Hz)/3.75 BCGTC(50Hz), 4.5 BCGTE(60Hz)/3.75 BCGTE(50Hz), 5.0 BCG(60Hz)/4.2 BCG(50Hz), 5.0 BCGA(60Hz)/5.2 BCGA(50Hz), 7.0 BCGB(60Hz)/6.0 BCGB(50Hz), 7.0 BCGC(60Hz)/5.9 BCGC(50Hz), 7.0 BCGD(60Hz)/5.8 BCGD(50Hz), 7.2 BCGTC(60Hz)/6.0 BCGTC(50Hz), 9.6 BCGTC(60Hz)/8.0 BCGTC(50Hz), 9.6 BCGTE(60Hz)/8.0 BCGTE(50Hz)



23-4501

PLUG WIRE SET

Replaces: Westerbeke 46596

Fits: 8.0 BEG(60Hz)/6.4 BEG(50Hz), 10.0 BEG(60Hz)/8.0 BEG(50Hz), 12.5 BEG(60Hz)/10.0 BEG(50Hz), 15.0 BEG(60Hz)/12.0 BEG(50Hz), 8.0 SBEG(60Hz) / 6.4 SBEG(50Hz), 10.0 SBEG(60Hz) / 8.0 SBEG(50Hz), 12.5 SBEG(60Hz) / 10.0 SBEG(50Hz), 14.0 SBEG(60Hz) / 11.6 SBEG(50Hz)



23-2800

ROTOR

Replaces: Westerbeke 34093

Fits: 6.5 TWG(60Hz)/4.9 TWG(50Hz), 8.0 TWG(60Hz)/6.4 TWG(50Hz), 8.5 BTG(60Hz)/6.5 BTG(50Hz), 11.0 TWG(60Hz)/8.5 TWG(50Hz), 12.5 BTG(60Hz)/10.0 BTG(50Hz), 15.0 BTG/A(60Hz)/12.0 BTG/A(50Hz)



23-2801

ROTOR

Replaces: Westerbeke 35610

Fits: 4.0 BCG(60Hz)/3.0 BCG(50Hz)



23-2802

ROTOR

Replaces: Westerbeke 40860

Fits: 20.0 BEG(60Hz)/16.0 BEG(50Hz), 25.0 BEG(60Hz)/20.0 BEG(50Hz), 20.0 SBEG(60Hz) / 16.0 SBEG(50Hz), 20.0 SBEGA(60Hz) / 16.0 SBEGA(50Hz), 22.5 SBEG(60Hz) / 18.7 SBEG(50Hz), 22.5 SBEGA(60Hz) / 18.7 SBEGA(50Hz)



23-2803

ROTOR

Replaces: Westerbeke 43050

Fits: 4.5 BCGB(60Hz)/3.75 BCGB(50Hz), 4.5 BCGTC(60Hz)/3.75 BCGTC(50Hz), 5.0 BCG(60Hz)/4.2 BCG(50Hz), 5.0 BCGA(60Hz)/5.2 BCGA(50Hz), 7.0 BCGB(60Hz)/6.0 BCGB(50Hz), 7.0 BCGC(60Hz)/5.9 BCGC(50Hz), 7.2 BCGTC(60Hz)/6.0 BCGTC(50Hz), 8.0 BEG(60Hz)/6.4 BEG(50Hz), 9.6 BCGTC(60Hz)/8.0 BCGTC(50Hz), 10.0 BEG(60Hz)/8.0 BEG(50Hz), 12.5 BEG(60Hz)/10.0 BEG(50Hz), 15.0 BEG(60Hz)/12.0 BEG(50Hz), 5.0 SBCG(60Hz) / 4.0 SBEG(50Hz), 6.5 SBCG(60Hz) / 5.4 SBCG(50Hz), 8.0 SBEG(60Hz) / 6.4 SBEG(50Hz), 10.0 SBEG(60Hz) / 8.0 SBEG(50Hz), 12.5 SBEG(60Hz) / 10.0 SBEG(50Hz), 14.0 SBEG(60Hz) / 11.6 SBEG(50Hz)



23-2804

ROTOR

Replaces: Westerbeke 42201

Fits: 4.5 BCG(60Hz)/3.75 BCG(50Hz), 7.0 BCG(60Hz)/5.0 BCG(50Hz), 7.0 BCGA(60Hz)/5.0 BCGA(50Hz), 9.0 BTG(60Hz)/7.0 BTG(50Hz), 6.5 BCG(60Hz)/4.8 BCG(50Hz)



23-7800

OIL FILTER

Replaces: Westerbeke 36918

Fits several models. See application chart on page 114-125



23-7801

OIL FILTER

Replaces: Westerbeke 35595

Notern Lights 24-0200

Fits: 4.0 BCG(60Hz)/3.0 BCG(50Hz), 6.5 BCG(60Hz)/4.8 BCG(50Hz), 9.0 BTG(60Hz)/7.0 BTG(50Hz), M753, M753G, M753K, M753W, M753W2, M773, LW2



23-7802

OIL FILTER

Replaces: Westerbeke 48078

Fits: 3.0 BPMG (60Hz)



23-7803

OIL FILTER

Replaces: Kohler 326817

Fits: 8E, 10E, 12.5E



23-7804

OIL FILTER

Replaces: Onan 185-7444,

(Fits: MDKAU, MDKBH)

Fischer Panda 15853-99170

Fits: PMS 8 MINI, PMS 8 DP, PMS 4200, PMS 6500, PMS 12 DP, PMS 12 Mini



23-7820

OIL FILTER

Replaces: Kohler 279449

Fits: 12.5CF, 15C, 16CF, 20C



**23-7821
OIL FILTER**
Replaces: Kohler 359771
Fits: 4EF, 5E, 6EF, 7.3E



**23-7822
OIL FILTER**
Replaces: Kohler 229678
Fits: 4 CCFZ, 4 EFOZ, 5 CCOZ, 5 EOZ, 6.5 EFOZ, 8 EOZ



**23-7823
OIL FILTER**
Replaces: Kohler 267714
Fits: 3.5 CFZ, 3.5 EFZ, 4 CZ, 4 ESZ, 5 CFZ, 5 EFZ, 6.5 CZ, 6.5 ESZ



**23-7824
OIL FILTER**
Replaces: Kohler GM47465
Fits: 7 EFOZD(Var 1), 8.5 EFOZD(Var 1), 9 EOZD(Var 1), 9 EFOZD (Var 1), 10 EOZD(Var 1), 11 EFOZD, 11.5 EFOZD, 13 EOZD, 13 EFOZD, 14 EOZD, 15.5 EOZD, 17 EFOZD, 17.5 EFOZD, 19 EFOZD, 20 EOZD, 20 EFOZD, 23 EOZD, 24 EOZD



**23-7825
OIL FILTER**
Replaces: Westerbeke 35828
Fits: 11.0 BTD(60Hz) / 8.3 BTD(50Hz), 12.5 BTD(60Hz) / 9.4 BTD(50Hz), 12.5 BTDA(60Hz) / 9.4 BTDA(50Hz), 12.5 WMD(60Hz) / 9.4 WMD(50Hz), 15.0 BTD(60Hz) / 12.0 BTD(50Hz), 15.0 BTDA(60Hz) / 12.0 BTDA(50Hz), 15.0 BTDB(60Hz) / 12.0 BTDB(50Hz)



**23-7826
OIL FILTER**
Replaces: Westerbeke 40154
Fits: 20.0 BED(60Hz) / 16.0 BED(50Hz), 20.0 BEDA(60Hz) / 16.0 BEDA(50Hz), 25.0 BED(60Hz) / 20.0 BED(50Hz), 25.0 WTA(60Hz) / 20.0 WTA(50Hz), 32.0 BED(60Hz) / 25.0 BED(50Hz), 32.0 BEDA(60Hz) / 25.0 BEDA(50Hz)



**23-7840
OIL FILTER**
Replaces: Onan 122-0810
Fits: MDKBD, MDKBE, MDKBF, MDKBD (w/ Isolated Ground), MDKBE (w/ Isolated Ground), MDKBF (w/ Isolated Ground), MDKAD/E/F



**23-7841
OIL FILTER**
Replaces: Onan 122-0185
Fits: MDJB, MDJC, MDJE, MDJF, MJA, MJB, MJC



**23-7842
OIL FILTER**
Replaces: Onan 185-5835
Fits: MDKAV, MDKBG, MDKAW (Spacesaver), MDKAZ, MDKAL/A/B, MDKBK, MDKBL, MDKBM, MDKBN

As with Marine Engines, Generators require routine maintenance and changing of engine oil is critical to maintaining and extending their useful life. With the addition of many oil filters for the Marine Generator market, Sierra offers several grades of oil for the gasoline and diesel Generator applications. These oils are specifically formulated for the Marine Industry to provide excellent lubrication and corrosion protection. All of these oils are backed by Sierra's Industry Leading Warranty.

Part#	Description	Case	
		Qty	Qty
18-9420-2	10W30 4-Stroke	Qt.	12
18-9400-2	25W40 4-Stroke	Qt.	12
18-9553-2	15W40 Diesel Oil	Qt.	12
18-9410-2	SAE 30 Full Syn.	Qt.	12



**56966P
HOURMETER**
Round



**56967P
HOURMETER**
Rectangular



**23-6400
ANODE**
Replaces:
Westerbeke 11885, Kohler 260085
Fits several models. See application chart on page 114-125



**23-6401
ANODE**
Replaces: Onan 130-4434
Fits: MDKAV, MDKBG, MDKAW (Spacesaver), MDKAZ, MDKBD, MDKBE, MDKBF, MDKBD (w/ Isolated Ground), MDKBE (w/ Isolated Ground), MDKBF (w/ Isolated Ground), MDKBH, MDKBK, MDKBL, MDKBM, MDKBN, MDKBP, MDKBR, MDKBS, MDKBV, MDKBT, MDKBU



**23-6402
ANODE**
Replaces: Onan 130-6228
Fits: MDDCA, MDDCB, MDDCC, MDDCF, MDDCG, MDDCD, MDDCE, MDDCH, MDDCJ



**23-5800
SOLENOID**
Replaces: Westerbeke 24639
Fits: 3.0 WMD(60Hz)/2.4 WMD(50Hz), 4.0 BCD(60Hz), 4.4 BCD(60Hz), 4.4 WMD(60Hz) / 3.3 WMD(50Hz), 5.0 BCD/BCDA/BCDB(60Hz) / 4.0 BCD/BCDA/BCDB(50Hz), 6.0 BCD(60Hz) / 4.5 BCD(50Hz), 7.6 BTD(60Hz) / 5.7 BTD(50Hz), 7.7 WMD(60Hz) / 5.8 WMD(50Hz), 8.0 BTD(60Hz) / 6.0 BTD(50Hz), 8.0 BTDA(60Hz) / 6.0 BTDA(50Hz), 8.0 WMD(60Hz) / 6.0 WMD(50Hz), 10.0 BTD(60Hz) / 7.5 BTD(50Hz), 10.0 BTDA(60Hz) / 7.5 BTDA(50Hz), 11.0 BTD(60Hz) / 8.3 BTD(50Hz), 11.0 WMD(60Hz) / 8.3 WMD(50Hz), 12.5 BTD(60Hz) / 9.4 BTD(50Hz), 12.5 BTDA(60Hz) / 9.4 BTDA(50Hz), 12.5 BTDB(60Hz) / 9.4 BTDB(50Hz), 12.5 WMD(60Hz) / 9.4 WMD(50Hz), 15.0 BTD(60Hz) / 12.0 BTD(50Hz), 15.0 BTDA(60Hz) / 12.0 BTDA(50Hz), 15.0 BTDB(60Hz) / 12.0 BTDB(50Hz), 15.0 BTDC(60Hz) / 12.0 BTDC(50Hz), 15.0 WTA(60Hz) / 12.0 WTA(50Hz), 20.0 BED(60Hz) / 16.0 BED(50Hz), 20.0 BEDA(60Hz) / 16.0 BEDA(50Hz), 20.0 WTA(60Hz) / 16.0 WTA(50Hz), 25.0 BED(60Hz) / 20.0 BED(50Hz), 25.0 WTA(60Hz) / 20.0 WTA(50Hz), 32.0 BED(60Hz) / 25.0 BED(50Hz), 32.0 BEDA(60Hz) / 25.0 BEDA(50Hz), 32.0 BEDB(60Hz) / 25.0 BEDB(50Hz), 32.0 WTF(60Hz) / 25.0 WTF(50Hz)



**23-5900
ALTERNATOR**
Replaces: Westerbeke 30594
Fits: 4.4 BCD(60Hz), 4.4 WMD(60Hz)/3.3 WMD(50Hz), 6.0 BCD(60Hz)/ 4.5 BCD(50Hz), 7.7 WMD(60Hz)/5.8 WMD(50Hz), 8.0 BTD(60Hz)/ 6.0 BTD(50Hz), 8.0 WMD(60Hz)/6.0 WMD(50Hz), 10.0 BTD(60Hz)/ 7.5 BTD(50Hz), 11.0 BTD(60Hz)/8.3 BTD(50Hz), 12.5 BTD(60Hz)/9.4 BTD(50Hz), 12.5 BTDA(60Hz)/9.4 BTDA(50Hz), 12.5 WMD(60Hz)/ 9.4 WMD(50Hz), 15.0 BTD(60Hz)/12.0 BTD(50Hz)



**23-4000
ALTERNATOR BELT**
Replaces: Westerbeke 39181
Fits: 20.0 BED(60Hz) / 16.0 BED(50Hz), 20.0 BEDA(60Hz) / 16.0 BEDA(50Hz), 25.0 BED(60Hz) / 20.0 BED(50Hz)



**23-4001
ALTERNATOR BELT**
Replaces: Westerbeke 11672
Fits: 15.0 BTDA(60Hz) / 12.0 BTDA(50Hz), 15.0 BTDB(60Hz) / 12.0 BTDB(50Hz), 20.0 WTA(60Hz) / 16.0 WTA(50Hz)



**23-4002
ALTERNATOR BELT**
Replaces: Westerbeke 30592
Fits: 6.5 TWG(60Hz)/4.9 TWG(50Hz), 8.0 TWG(60Hz)/6.4 TWG(50Hz), 11.0 TWG(60Hz)/8.5 TWG(50Hz), 6.0 BCD(60Hz) / 4.5 BCD(50Hz), 7.7 WMD(60Hz) / 5.8 WMD(50Hz), 8.0 WMD(60Hz) / 6.0 WMD(50Hz), 11.0 BTD(60Hz) / 8.3 BTD(50Hz)



**23-4003
ALTERNATOR BELT**
Replaces: Westerbeke 45232
Fits: 7.6 BTD(60Hz) / 5.7 BTD(50Hz), 8.0 BTDA(60Hz) / 6.0 BTDA(50Hz), 10.0 BTDA(60Hz) / 7.5 BTDA(50Hz), 12.5 BTDB(60Hz) / 9.4 BTDB(50Hz), 15.0 BTDC(60Hz) / 12.0 BTDC(50Hz)



**23-4004
ALTERNATOR BELT**
Replaces: Westerbeke 30475
Fits: 12.5 BTG(60Hz)/10.0 BTG(50Hz), 15.0 BTG/A(60Hz)/12.0 BTG/A(50Hz), 8.0 BTD(60Hz) / 6.0 BTD(50Hz), 10.0 BTD(60Hz) / 7.5 BTD(50Hz), 12.5 BTD(60Hz) / 9.4 BTD(50Hz), 12.5 BTDA(60Hz) / 9.4 BTDA(50Hz), 12.5 WMD(60Hz) / 9.4 WMD(50Hz), 15.0 BTD(60Hz) / 12.0 BTD(50Hz)



**23-5600
STARTER**
Replaces: Westerbeke 30593
Fits: 4.4 WMD(60Hz)/3.3 WMD(50Hz), 7.7 WMD(60Hz)/5.8 WMD(50Hz), 8.0 BTDA(60Hz)/6.0 BTDA(50Hz), 8.0 WMD(60Hz)/6.0 WMD(50Hz), 10.0 BTDA(60Hz)/7.5 BTDA(50Hz), 11.0 BTD(60Hz)/8.3 BTD(50Hz), 11.0 WMD(60Hz)/8.3 WMD(50Hz), 12.5 BTD(60Hz)/9.4 BTD(50Hz), 12.5 BTDA(60Hz)/9.4 BTDA(50Hz), 12.5 BTDB(60Hz)/9.4 BTDB(50Hz), 12.5 WMD(60Hz)/9.4 WMD(50Hz), 12.6 BTD(60Hz)/10.4 BTD(50Hz), 15.0 BTD(60Hz)/12.0 BTD(50Hz), 15.0 BTDA(60Hz)/12.0 BTDA(50Hz), 15.0 BTDB(60Hz)/12.0 BTDB(50Hz), 15.0 BTDC(60Hz)/12.0 BTDC(50Hz)



**23-5601
STARTER**
Replaces:
Westerbeke 34552
SAE J1171 Certified
Fits: 4.0 BCG(60Hz)/3.0 BCG(50Hz), 4.4 BCD(60Hz), 4.5 BCG(60Hz)/3.75 BCG(50Hz), 4.5 BCGB(60Hz)/3.75 BCGB(50Hz), 4.5 BCGTC(60Hz)/ 3.75 BCGTC(50Hz), 5.0 BCD/BCDA/BCDB(60Hz)/4.0 BCD/BCDA/BCDB(50Hz), 6.5 BCG(60Hz)/4.8 BCG(50Hz), 7.0 BCG(60Hz)/5.0 BCG(50Hz), 7.0 BCGA(60Hz)/5.0 BCGA(50Hz), 7.0 BCGB(60Hz)/6.0 BCGB(50Hz), 7.2 BCGTC(60Hz)/6.0 BCGTC(50Hz), 7.6 BTD(60Hz)/5.7 BTD(50Hz), 8.0 BTD(60Hz)/6.0 BTD(50Hz), 8.0 BEG(60Hz)/6.4 BEG(50Hz), 8.5 BTG(60Hz)/6.5 BTG(50Hz), 9.0 BTG(60Hz)/7.0 BTG(50Hz), 9.6 BCGTC(60Hz)/8.0 BCGTC(50Hz), 10.0 BTD(60Hz)/7.5 BTD(50Hz) 10.0 BEG(60Hz)/8.0 BEG(50Hz), 12.5 BEG(60Hz)/10.0 BEG(50Hz), 12.5 BTG(60Hz)/10.0 BTG(50Hz), 15.0 BEG(60Hz)/12.0 BEG(50Hz), 15.0 BTG/A(60Hz)/12.0 BTG/A(50Hz), 8.0 SBEG(60Hz) / 6.4 SBEG(50Hz), 10.0 SBEG(60Hz) / 8.0 SBEG(50Hz), 12.5 SBEG(60Hz) / 10.0 SBEG(50Hz), 14.0 SBEG(60Hz) / 11.6 SBEG(50Hz)

Model	OEM	Starter	Alternator	Fuel Filter	Impeller	Impeller Kit	Thermostat
3.0 WMD(60Hz)/2.4 WMD(50Hz)	Westerbeke	—	—	23-7770	23-2001	23-3305	23-3600
3.8/4.2 BCDT(60Hz) / 3.5 BCDT(50Hz)	Westerbeke	—	—	—	23-2001	23-3305	—
4.0 BCD(60Hz)	Westerbeke	—	—	23-7770	—	23-3307	—
4.4 BCD(60Hz)	Westerbeke	23-5601	23-5900	—	23-2001	23-3307	23-3600
4.4 WMD(60Hz) / 3.3 WMD(50Hz)	Westerbeke	23-5600	23-5900	23-7770	—	23-3307	23-3600
5.0 BCD/BCDA/BCDB(60Hz) / 4.0 BCD/BCDA/BCDB(50Hz)	Westerbeke	23-5601	—	23-7770	—	23-3307	—
5.0 BCDR(60Hz) / 4.0 BCDR(50Hz)	Westerbeke	—	—	—	—	—	—
6.0 BCD(60Hz) / 4.5 BCD(50Hz)	Westerbeke	—	23-5900	23-7770	—	23-3307	23-3600
7.6 BTD(60Hz) / 5.7 BTD(50Hz)	Westerbeke	23-5601	—	23-7770	—	23-3307	—
7.7 WMD(60Hz) / 5.8 WMD(50Hz)	Westerbeke	23-5600	23-5900	23-7770	—	23-3307	23-3600
8.0 BTD(60Hz) / 6.0 BTD(50Hz)	Westerbeke	23-5601	23-5900	23-7770	—	23-3307	23-3600
8.0 BTDA(60Hz) / 6.0 BTDA(50Hz)	Westerbeke	23-5600	—	23-7770	—	23-3307	23-3600
8.0 BCDT(60Hz) / 7.0 BCDT(50Hz)	Westerbeke	—	—	23-7770	—	—	—
8.0 WMD(60Hz) / 6.0 WMD(50Hz)	Westerbeke	23-5600	23-5900	23-7770	—	23-3307	23-3600
10.0 BTD(60Hz) / 7.5 BTD(50Hz)	Westerbeke	23-5601	23-5900	23-7770	—	23-3307	23-3600
10.0 BTDA(60Hz) / 7.5 BTDA(50Hz)	Westerbeke	23-5600	—	23-7770	—	23-3307	23-3600
11.0 BTD(60Hz) / 8.3 BTD(50Hz)	Westerbeke	23-5600	23-5900	23-7770	—	23-3307	23-3600
11.0 WMD(60Hz) / 8.3 WMD(50Hz)	Westerbeke	23-5600	—	23-7770	—	23-3307	23-3600
12.5 BTD(60Hz) / 9.4 BTD(50Hz)	Westerbeke	23-5600	23-5900	23-7770	—	23-3307	23-3600
12.5 BTDA(60Hz) / 9.4 BTDA(50Hz)	Westerbeke	23-5600	23-5900	23-7770	—	23-3307	23-3600
12.5 BTDB(60Hz) / 9.4 BTDB(50Hz)	Westerbeke	23-5600	—	23-7770	—	23-3307	23-3600
12.5 WMD(60Hz) / 9.4 WMD(50Hz)	Westerbeke	23-5600	23-5900	23-7770	—	23-3307	23-3600
12.6 BTD(60Hz) / 10.4 BTD(50Hz)	Westerbeke	23-5600	—	23-7770	—	—	23-3600
15.0 BTD(60Hz) / 12.0 BTD(50Hz)	Westerbeke	23-5600	23-5900	23-7764	—	23-3313	23-3600
15.0 BTDA(60Hz) / 12.0 BTDA(50Hz)	Westerbeke	23-5600	—	23-7764	—	23-3313	23-3605
15.0 BTDB(60Hz) / 12.0 BTDB(50Hz)	Westerbeke	23-5600	—	23-7764	—	23-3313	23-3605
15.0 BTDC(60Hz) / 12.0 BTDC(50Hz)	Westerbeke	23-5600	—	23-7770	—	23-3307	23-3600
15.0 WTA(60Hz) / 12.0 WTA(50Hz)	Westerbeke	—	—	23-7764	—	23-3313	23-3605
20.0 BED(60Hz) / 16.0 BED(50Hz)	Westerbeke	—	—	23-7764	—	23-3301	23-3605
20.0 BEDA(60Hz) / 16.0 BEDA(50Hz)	Westerbeke	—	—	23-7764	—	23-3301	23-3605
20.0 WTA(60Hz) / 16.0 WTA(50Hz)	Westerbeke	—	—	23-7764	23-2000	23-3302	23-3605
25.0 BED(60Hz) / 20.0 BED(50Hz)	Westerbeke	—	—	23-7764	—	23-3301	23-3605
25.0 WTA(60Hz) / 20.0 WTA(50Hz)	Westerbeke	—	—	23-7764	—	23-3301	23-3605
32.0 BED(60Hz) / 25.0 BED(50Hz)	Westerbeke	—	—	23-7764	—	23-3301	—
32.0 BEDA(60Hz) / 25.0 BEDA(50Hz)	Westerbeke	—	—	23-7764	—	23-3301	23-3605
32.0 BEDB(60Hz) / 25.0 BEDB(50Hz)	Westerbeke	—	—	—	—	23-3301	—
32.0 WTF(60Hz) / 25.0 WTF(50Hz)	Westerbeke	—	—	23-7764	—	23-3301	—
3.0 BPGM (60Hz)	Westerbeke	—	—	23-7770	—	—	—
4.0 BCG(60Hz)/3.0 BCG(50Hz)	Westerbeke	23-5601	—	23-7720	23-2001	23-3305	23-3601
4.5 BCG(60Hz)/3.75 BCG(50Hz)	Westerbeke	23-5601	—	—	23-2001	23-3305	23-3602
4.5 BCGB(60Hz)/3.75 BCGB(50Hz)	Westerbeke	23-5601	—	—	23-2001	23-3305	23-3603
4.5 BCGTC(60Hz)/3.75 BCGTC(50Hz)	Westerbeke	23-5601	—	—	23-2001	23-3305	23-3603
4.5 BCGTE(60Hz) / 3.75 BCGTE(50Hz)	Westerbeke	—	—	—	—	—	—
5.0 BCG(60Hz)/4.2 BCG(50Hz)	Westerbeke	—	—	23-7770	23-2001	23-3306	23-3603

Thermostat Kit	Oil Filter	Air Filter	Thermostat Gasket	Anode	Carburetor Kit	Glow Plug	Temperature Sender	Oil Pressure Sender	Solenoid
—	23-7800	—	—	23-6400	—	—	23-5840	23-5880	23-5800
—	—	—	—	—	—	—	—	—	—
—	23-7800	—	—	—	—	—	23-5840	23-5880	23-5800
23-3650	23-7800	—	23-0806	23-6400	—	23-1000	23-5840	23-5880	23-5800
23-3650	23-7800	—	23-0806	23-6400	—	23-1000	23-5840	23-5880	23-5800
—	23-7800	—	—	23-6400	—	—	23-5840	23-5880	23-5800
—	23-7800	—	—	—	—	—	—	—	—
—	23-7800	—	23-0802	23-6400	—	23-1000	23-5840	23-5880	23-5800
—	23-7800	—	—	—	—	—	—	23-5880	23-5800
23-3650	23-7800	—	23-0806	—	—	23-1000	23-5840	23-5880	23-5800
23-3653	23-7800	—	23-0802	—	—	23-1000	23-5840	23-5880	23-5800
—	23-7800	23-1101	—	—	—	23-1000	23-5840	23-5880	23-5800
—	23-7800	—	—	23-6400	—	—	—	—	—
23-3650	23-7800	—	23-0806	—	—	23-1000	23-5840	23-5880	23-5800
23-3653	23-7800	—	23-0802	23-6400	—	23-1000	23-5840	23-5880	23-5800
—	23-7800	23-1101	—	—	—	23-1000	23-5840	23-5880	23-5800
23-3653	23-7825	—	23-0802	—	—	23-1000	23-5840	23-5880	23-5800
23-3650	23-7800	—	23-0806	23-6400	—	23-1000	23-5840	23-5880	23-5800
23-3653	23-7825	—	23-0802	—	—	23-1000	23-5840	23-5880	23-5800
23-3653	23-7825	—	23-0802	—	—	23-1000	23-5840	23-5880	23-5800
—	23-7800	23-1101	—	—	—	23-1000	23-5840	23-5880	23-5800
23-3650	23-7825	—	23-0806	—	—	23-1000	23-5840	23-5880	23-5800
23-3653	23-7800	23-1101	23-0802	23-6400	—	—	—	—	—
23-3658	23-7825	—	23-0807	—	—	23-1000	23-5840	—	23-5800
23-3660	23-7825	—	23-0804	—	—	23-1000	23-5840	—	23-5800
23-3660	23-7825	—	23-0804	—	—	23-1000	23-5840	—	23-5800
—	23-7800	23-1101	—	—	—	23-1000	23-5840	—	23-5800
23-3660	—	—	23-0804	—	—	23-1000	23-5840	—	23-5800
23-3660	23-7826	—	23-0804	—	—	23-1000	23-5840	—	23-5800
23-3660	23-7826	—	23-0804	—	—	23-1000	23-5840	—	23-5800
23-3660	—	—	23-0804	—	—	23-1000	23-5840	—	23-5800
23-3660	23-7826	—	23-0804	—	—	23-1000	23-5840	—	23-5800
23-3660	23-7826	—	23-0804	—	—	23-1000	23-5840	—	23-5800
—	23-7826	—	—	—	—	23-1000	23-5840	—	23-5800
—	23-7826	—	—	—	—	—	23-5840	—	23-5800
—	23-7826	—	—	—	—	23-1000	23-5840	—	23-5800
—	23-7826	—	—	—	—	23-1000	23-5840	—	23-5800
—	23-7802	—	—	—	—	—	—	—	—
23-3651	23-7801	—	23-0802	23-6400	23-7201	—	23-5840	—	—
23-3659	23-7800	—	23-0808	23-6400	23-7201	—	23-5840	—	—
23-3654	23-7800	—	23-0800	23-6400	23-7201	—	—	—	—
23-3654	23-7800	—	23-0800	23-6400	23-7201	—	—	—	—
—	23-7800	—	—	—	—	—	—	—	—
23-3655	23-7800	—	23-0801	23-6400	23-7201	—	—	—	—

Model	OEM	Starter	Alternator	Fuel Filter	Impeller	Impeller Kit	Thermostat
5.0 BCGA(60Hz)/5.2 BCGA(50Hz)	Westerbeke	—	—	23-7770	23-2001	23-3306	23-3603
6.5 BCG(60Hz)/4.8 BCG(50Hz)	Westerbeke	23-5601	—	23-7720	23-2001	23-3305	23-3601
6.5 TWG(60Hz)/4.9 TWG(50Hz)	Westerbeke	—	—	23-7720	23-2000	23-3302	23-3601
7.0 BCG(60Hz)/5.0 BCG(50Hz)	Westerbeke	23-5601	—	—	23-2001	23-3305	23-3602
7.0 BCGA(60Hz)/5.0 BCGA(50Hz)	Westerbeke	23-5601	—	—	23-2001	23-3305	23-3602
7.0 BCGB(60Hz)/6.0 BCGB(50Hz)	Westerbeke	23-5601	—	—	23-2001	23-3305	23-3603
7.0 BCGC(60Hz)/5.9 BCGC(50Hz)	Westerbeke	—	—	23-7770	23-2001	23-3306	23-3603
7.0 BCGD(60Hz) / 5.8 BCGD(50Hz)	Westerbeke	—	—	23-7770	23-2001	23-3306	—
7.2 BCGTC(60Hz)/6.0 BCGTC(50Hz)	Westerbeke	23-5601	—	23-7770	23-2001	23-3305	23-3603
8.0 BEG(60Hz)/6.4 BEG(50Hz)	Westerbeke	23-5601	—	23-7770	23-2001	23-3306	23-3605
8.0 TWG(60Hz)/6.4 TWG(50Hz)	Westerbeke	—	—	23-7720	23-2000	23-3302	23-3601
8.5 BTG(60Hz)/6.5 BTG(50Hz)	Westerbeke	23-5601	—	—	23-2000	23-3302	23-3601
8.5 BTGA(60Hz) / 6.8 BTGA(50Hz)	Westerbeke	—	—	—	23-2000	23-3302	23-3601
9.0 BTG(60Hz)/7.0 BTG(50Hz)	Westerbeke	23-5601	—	23-7720	23-2001	23-3305	23-3601
9.6 BCGTC(60Hz)/8.0 BCGTC(50Hz)	Westerbeke	23-5601	—	—	23-2001	23-3305	23-3603
10.0 BEG(60Hz)/8.0 BEG(50Hz)	Westerbeke	23-5601	—	23-7770	23-2001	23-3306	23-3605
11.0 TWG(60Hz)/8.5 TWG(50Hz)	Westerbeke	—	—	23-7720	23-2000	23-3302	23-3601
12.5 BEG(60Hz)/10.0 BEG(50Hz)	Westerbeke	23-5601	—	23-7770	23-2001	23-3306	23-3605
12.5 BTG(60Hz)/10.0 BTG(50Hz)	Westerbeke	23-5601	—	—	23-2000	23-3302	23-3601
15.0 BEG(60Hz)/12.0 BEG(50Hz)	Westerbeke	23-5601	—	23-7770	23-2001	23-3306	23-3605
15.0 BTG/A(60Hz)/12.0 BTG/A(50Hz)	Westerbeke	23-5601	—	—	23-2000	23-3302	23-3601
20.0 BEG(60Hz)/16.0 BEG(50Hz)	Westerbeke	—	—	—	—	23-3301	23-3601
25.0 BEG(60Hz)/20.0 BEG(50Hz)	Westerbeke	—	—	—	—	23-3301	23-3601
5.0 SBEG(60Hz) / 4.0 SBEG(50Hz)	Westerbeke	—	—	23-7770	23-2001	23-3306	23-3603
6.5 SBEG(60Hz) / 5.4 SBEG(50Hz)	Westerbeke	—	—	23-7770	23-2001	23-3306	23-3603
8.0 SBEG(60Hz) / 6.4 SBEG(50Hz)	Westerbeke	23-5601	—	23-7770	23-2001	23-3306	23-3605
10.0 SBEG(60Hz) / 8.0 SBEG(50Hz)	Westerbeke	23-5601	—	23-7770	23-2001	23-3306	23-3605
12.5 SBEG(60Hz) / 10.0 SBEG(50Hz)	Westerbeke	23-5601	—	23-7770	23-2001	23-3306	23-3605
14.0 SBEG(60Hz) / 11.6 SBEG(50Hz)	Westerbeke	23-5601	—	23-7770	23-2001	23-3306	23-3605
18.0 SBEG	Westerbeke	—	—	—	—	—	—
18.0 SBEGA	Westerbeke	—	—	—	—	—	—
20.0 SBEG(60Hz) / 16.0 SBEG(50Hz)	Westerbeke	—	—	23-7770	—	23-3301	23-3600
20.0 SBEGA(60Hz) / 16.0 SBEGA(50Hz)	Westerbeke	—	—	23-7770	—	23-3301	23-3600
22.5 SBEG(60Hz) / 18.7 SBEG(50Hz)	Westerbeke	—	—	23-7770	—	23-3301	23-3600
22.5 SBEGA(60Hz) / 18.7 SBEGA(50Hz)	Westerbeke	—	—	23-7770	—	23-3301	23-3600
5.5 EDC(60Hz) / 5.0 EDC(50Hz)	Westerbeke	—	—	23-7770	—	—	—
7.6 EDT(60Hz) / 5.7 EDT(50Hz)	Westerbeke	—	—	23-7770	—	—	—
8.0 EDT(60Hz) / 6.0 EDT(50Hz)	Westerbeke	—	—	23-7770	—	—	—
10.0 EDT(60Hz) / 7.5 EDT(50Hz)	Westerbeke	—	—	23-7770	—	—	—
11.5 EDT(60Hz) / 9.2 EDT(50Hz)	Westerbeke	—	—	23-7770	—	—	—
12.5 EDT(60Hz) / 9.4 EDT(50Hz)	Westerbeke	—	—	23-7770	—	—	—
12.6 EDT(60Hz) / 10.4 EDT(50Hz)	Westerbeke	—	—	23-7770	—	—	—
15.0 EDT(60Hz) / 12.0 EDT(50Hz)	Westerbeke	—	—	23-7770	—	—	—
4 CCFOZ	Kohler	—	—	23-7751	23-2002(SN 296899 & Up) 23-2003(SN 296898 & below)	23-3303(SN 296899 & Up) 23-3304(SN 296898 & below)	—

Thermostat Kit	Oil Filter	Air Filter	Thermostat Gasket	Anode	Carburetor Kit	Glow Plug	Temperature Sender	Oil Pressure Sender	Solenoid
23-3655	23-7800	—	23-0801	23-6400	—	—	—	—	—
23-3651	23-7801	—	23-0802	23-6400	23-7201	—	23-5840	—	—
23-3652	23-7800	—	23-0803	23-6400	23-7200	—	23-5840	—	—
23-3659	23-7800	—	23-0808	23-6400	23-7201	—	23-5840	—	—
23-3659	23-7800	—	23-0808	23-6400	23-7201	—	23-5840	—	—
23-3654	23-7800	—	23-0800	23-6400	23-7201	—	—	—	—
23-3655	23-7800	—	23-0801	23-6400	—	—	—	—	—
—	23-7800	—	—	23-6400	—	—	—	—	—
23-3654	23-7800	—	23-0800	23-6400	23-7201	—	—	—	—
23-3656	23-7800	—	23-0803	23-6400	23-7201	—	23-5840	23-5880	—
23-3651	23-7800	—	23-0802	23-6400	23-7200	—	23-5840	—	—
23-3652	23-7800	—	23-0803	23-6400	23-7200	—	23-5840	23-5880	—
—	23-7800	—	—	23-6400	23-7200	—	—	—	—
23-3651	23-7801	—	23-0802	23-6400	—	—	23-5840	—	—
23-3654	23-7800	—	23-0800	23-6400	23-7201	—	—	—	—
23-3656	23-7800	—	23-0803	23-6400	23-7201	—	23-5840	23-5880	—
23-3651	23-7800	—	23-0802	23-6400	—	—	23-5840	—	—
23-3656	23-7800	—	23-0803	23-6400	23-7201	—	23-5840	23-5880	—
23-3652	23-7800	—	23-0803	23-6400	23-7200	—	23-5840	23-5880	—
23-3656	23-7800	—	23-0803	23-6400	23-7201	—	23-5840	23-5880	—
23-3652	23-7800	—	23-0803	23-6400	23-7200	—	23-5840	23-5880	—
23-3661	23-7800	—	23-0805	23-6400	23-7200	—	23-5840	23-5880	—
23-3661	23-7800	—	23-0805	23-6400	23-7200	—	23-5840	23-5880	—
23-3655	23-7800	—	23-0801	23-6400	—	—	—	—	—
23-3655	23-7800	—	23-0801	23-6400	—	—	—	—	—
23-3657	23-7800	—	23-0803	23-6400	—	—	—	—	—
23-3657	23-7800	—	23-0803	23-6400	—	—	—	—	—
23-3657	23-7800	—	23-0803	23-6400	—	—	—	—	—
23-3657	23-7800	—	23-0803	23-6400	—	—	—	—	—
—	23-7800	—	—	—	—	—	—	—	—
—	23-7800	—	—	—	—	—	—	—	—
—	23-7800	23-1101	—	23-6400	—	—	—	—	—
—	23-7800	23-1101	—	23-6400	—	—	—	—	—
—	23-7800	23-1101	—	23-6400	—	—	—	—	—
—	23-7800	23-1101	—	23-6400	—	—	—	—	—
—	23-7800	23-1101	—	23-6400	—	—	—	—	—
—	23-7800	23-1101	—	23-6400	—	—	—	—	—
—	23-7822	23-1130(Var 4)	23-0813	—	—	—	—	—	—

Model	OEM	Starter	Alternator	Fuel Filter	Impeller	Impeller Kit	Thermostat
4EFOZ	Kohler	—	—	23-7751	23-2002(SN 296899 & Up) 23-2003(SN 296898 & below)	23-3303(SN 296899 & Up) 23-3304(SN 296898 & below)	—
5 CCOZ	Kohler	—	—	23-7751	23-2002(SN 296899 & Up) 23-2003(SN 296898 & below)	23-3303(SN 296899 & Up) 23-3304(SN 296898 & below)	—
5EOZ	Kohler	—	—	23-7751	23-2002(SN 296899 & Up) 23-2003(SN 296898 & below)	23-3303(SN 296899 & Up) 23-3304(SN 296898 & below)	—
6.5 EFOZ	Kohler	—	—	23-7751	23-2002(SN 296899 & Up) 23-2003(SN 296898 & below)	23-3303(SN 296899 & Up) 23-3304(SN 296898 & below)	—
8EOZ	Kohler	—	—	23-7751	23-2002(SN 296899 & Up) 23-2003(SN 296898 & below)	23-3303(SN 296899 & Up) 23-3304(SN 296898 & below)	—
8EFOZ	Kohler	—	—		23-2002(SN 296899 & Up) 23-2003(SN 296898 & below)	23-3303(SN 296899 & Up) 23-3304(SN 296898 & below)	—
8CCFOZ	Kohler	—	—		23-2002(SN 296899 & Up) 23-2003(SN 296898 & below)	23-3303(SN 296899 & Up) 23-3304(SN 296898 & below)	—
9CCOZ	Kohler	—	—		23-2002(SN 296899 & Up) 23-2003(SN 296898 & below)	23-3303(SN 296899 & Up) 23-3304(SN 296898 & below)	—
9EOZ	Kohler	—	—		23-2002(SN 296899 & Up) 23-2003(SN 296898 & below)	23-3303(SN 296899 & Up) 23-3304(SN 296898 & below)	—
9EFOZ	Kohler	—	—		23-2002(SN 296899 & Up) 23-2003(SN 296898 & below)	23-3303(SN 296899 & Up) 23-3304(SN 296898 & below)	—
10EOZ	Kohler	—	—		23-2002(SN 296899 & Up) 23-2003(SN 296898 & below)	23-3303(SN 296899 & Up) 23-3304(SN 296898 & below)	—
11 CCFOZ	Kohler	—	—	23-7740(Var 2)	23-2003	23-3304	23-3609
11.5 CCFOZ	Kohler	—	—	23-7740(Var 2)	23-2003	23-3304	23-3609
11EFOZ	Kohler	—	—	23-7740(Var 2)	23-2003	23-3304	23-3609
11.5EFOZ	Kohler	—	—	23-7740(Var 2)	23-2003	23-3304	23-3609
13EOZ	Kohler	—	—	23-7740(Var 2)	23-2003	23-3304	23-3609
13EFOZ	Kohler	—	—	23-7740(Var 2)	23-2003	23-3304	23-3609
13.5 CCOZ	Kohler	—	—	23-7740(Var 2)	23-2003	23-3304	23-3609
14 CCOZ	Kohler	—	—	23-7740(Var 2)	23-2003	23-3304	23-3609
14 EOZ	Kohler	—	—	23-7740(Var 2)	23-2003	23-3304	23-3609
15 CCFOZ	Kohler	—	—	23-7740(Var 3)	23-2003	23-3304	23-3609
15.5EOZ	Kohler	—	—	23-7740(Var 2)	23-2003	23-3304	23-3609
16EFOZ	Kohler	—	—	23-7740(Var 3)	23-2003	23-3304	23-3609
17.5EFOZ	Kohler	—	—	23-7740(Var 3)	23-2003	23-3304	23-3609
18.5 CCOZ	Kohler	—	—	23-7740(Var 3)	23-2003	23-3304	23-3609
19EFOZ	Kohler	—	—	23-7740(Var 3)	23-2003	23-3304	23-3609
20 CCFOZ	Kohler	—	—	23-7740(Var 3)	23-2003	23-3304	23-3609
20EOZ	Kohler	—	—	23-7740(Var 3)	23-2003	23-3304	23-3609
20EFOZ	Kohler	—	—	23-7740(Var 3)	23-2003	23-3304	23-3609
23EOZ	Kohler	—	—	23-7740(Var 3)	23-2003	23-3304	23-3609
24 CCOZ	Kohler	—	—	23-7740(Var 3)	23-2003	23-3304	23-3609
24EOZ	Kohler	—	—	23-7740(Var 3)	23-2003	23-3304	23-3609
6.5EFOZD	Kohler	—	—	23-7751	23-2002	23-3303	—
7 EFOZD	Kohler	—	—	23-7761(Var 1)	23-2002	23-3303	—
8EOZD	Kohler	—	—	23-7751	23-2002	23-3303	—
8.5 EFOZD	Kohler	—	—	23-7761(Var 1)	23-2002	23-3303	—
9 EOZD	Kohler	—	—	23-7761(Var 1)	23-2002	23-3303	—
9EFOZD	Kohler	—	—	23-7761(Var 1)	23-2002	23-3303	—
10EOZD	Kohler	—	—	23-7761(Var 1)	23-2002	23-3303	—
11EFOZD	Kohler	—	—	23-7761(Var 1)	23-2003	23-3304	—
11.5EFOZD	Kohler	—	—	23-7761(Var 1)	23-2003	23-3304	—
13EOZD	Kohler	—	—	23-7761(Var 1)	23-2003	23-3304	—
13EFOZD	Kohler	—	—	23-7761(Var 1)	23-2003	23-3304	—

Model	OEM	Starter	Alternator	Fuel Filter	Impeller	Impeller Kit	Thermostat
14 EOZD	Kohler	—	—	23-7761(Var 1)	23-2003	23-3304	—
15.5 EOZD	Kohler	—	—	23-7761(Var 1)	23-2003	23-3304	—
17 EFOZD	Kohler	—	—	23-7740(Var 3), 23-7761(Var 1)	23-2003	23-3304	—
17.5EFOZD	Kohler	—	—	23-7740(Var 3), 23-7761(Var 1)	23-2003	23-3304	—
19EFOZD	Kohler	—	—	23-7740(Var 3), 23-7761(Var 1)	23-2003	23-3304	—
20EOZD	Kohler	—	—	23-7740(Var 3), 23-7761(Var 1)	23-2003	23-3304	—
20EFOZD	Kohler	—	—	23-7740(Var 3), 23-7761(Var 1)	23-2003	23-3304	—
23EFOZ		—	—	—	23-2002	23-3303	—
23EOZD	Kohler	—	—	23-7740(Var 3), 23-7761(Var 1)	23-2003	23-3304	—
23EFOZD	Kohler	—	—	23-7761	23-2002	23-3303	—
24EOZD	Kohler	—	—	23-7740(Var 3), 23-7761(Var 1)	23-2003	23-3304	—
27EFOZ		—	—	—	23-2002	23-3303	—
27EFOZD	Kohler	—	—	23-7761	23-2002	23-3303	—
28EOZ		—	—	—	23-2002	23-3303	—
28EOZD	Kohler	—	—	23-7761	23-2002	23-3303	—
32EOZ		—	—	—	23-2002	23-3303	—
32EOZD	Kohler	—	—	23-7761	23-2002	23-3303	—
33EFOZ	Kohler	—	—	—	—	23-3308	—
33 CFOZ	Kohler	—	—	—	—	23-3308	23-3607
40 CFOZ	Kohler	—	—	—	—	23-3308	23-3607
40EOZ	Kohler	—	—	—	—	23-3308	—
40EFOZ	Kohler	—	—	—	—	23-3308	—
50 COZ	Kohler	—	—	—	—	23-3308	23-3607
50 CFOZ	Kohler	—	—	—	—	23-3308	23-3607
50EOZ	Kohler	—	—	—	—	23-3308	—
55EFOZ	Kohler	—	—	—	—	23-3308	—
65 COZ	Kohler	—	—	—	—	23-3308	23-3607
65EOZ	Kohler	—	—	—	—	23-3308	—
70EFOZ	Kohler	—	—	—	—	23-3308	—
80EOZ	Kohler	—	—	—	—	23-3308	—
80EFOZ	Kohler	—	—	—	—	23-3308	—
99EOZ	Kohler	—	—	—	—	23-3308	—
100EFOZ	Kohler	—	—	—	—	—	—
125EOZ	Kohler	—	—	—	—	—	—
125EFOZ	Kohler	—	—	—	—	—	—
150EOZ	Kohler	—	—	—	—	—	—
3.5 CFZ	Kohler	—	—	23-7771(Var 2)	23-2003(SN 296898 & below)	—	23-3610
3.5 EFZ	Kohler	—	—	—	—	—	23-3610
4 CZ	Kohler	—	—	23-7771(Var 2)	23-2003(SN 296898 & below)	—	23-3610
4EF	Kohler	—	—	23-7762	23-2004	23-3314	23-3608
4EFCD	Kohler	—	—	—	—	—	—
4EFKD	Kohler	—	—	—	—	—	—
4 ESZ	Kohler	—	—	—	—	—	23-3610
5 CFZ	Kohler	—	—	23-7771(Var 2)	23-2003(SN 296898 & below)	—	23-3610
5ECD	Kohler	—	—	—	23-2004	23-3314	—
5 EFZ	Kohler	—	—	23-7762	—	—	23-3610
5EKD	Kohler	—	—	—	—	—	—
5E	Kohler	—	—	23-7762	23-2004	23-3314	23-3608
6EF	Kohler	—	—	23-7762	23-2004	23-3314	23-3608
6EFCD	Kohler	—	—	—	23-2004	23-3314	—
6EFKD	Kohler	—	—	—	—	—	—
6.5 CZ	Kohler	—	—	23-7771(Var 2)	23-2003(SN 296898 & below)	—	23-3610
6.5 ESZ	Kohler	—	—	23-7762	—	—	23-3610
7.3E	Kohler	—	—	23-7762	23-2004	23-3314	23-3608
7.3ECD	Kohler	—	—	—	23-2004	23-3314	—
7.3EKD	Kohler	—	—	—	—	—	—
8E	Kohler	—	—	23-7762(GRS Ver), 23- 7771(Var 2) Inline	23-2002 (296899 & Up), 23- 2003 (296898 & below)	23-3303 (SN 296899 & Up), 23-3304 (SN 296898 & below)	23-3608
8EFKD	Kohler	—	—	—	—	—	—
9EFGD	Kohler	—	—	23-7780	—	—	—
10E	Kohler	—	—	23-7762(GRS Ver), 23- 7771(Var 2) Inline	23-2002 (296899 & Up), 23- 2003 (296898 & below)	23-3303 (SN 296899 & Up), 23-3304 (SN 296898 & below)	23-3608
10EG	Kohler	—	—	23-7780	—	—	—
10EGD	Kohler	—	—	23-7780	—	—	—

Model	OEM	Starter	Alternator	Fuel Filter	Impeller	Impeller Kit	Thermostat
10EKD	Kohler	—	—	—	—	—	—
11EFGD	Kohler	—	—	—	—	—	—
12.5E	Kohler	—	—	23-7762(GRS Ver), 23-7771(Var 2) Inline	23-2002 (296899 & Up), 23-2003 (296898 & below)	23-3303 (SN 296899 & Up), 23-3304 (SN 296898 & below)	23-3608
12.5CF	Kohler	—	—	—	23-2002 (296899 & Up), 23-2003 (296898 & below)	23-3303 (SN 296899 & Up), 23-3304 (SN 296898 & below)	23-3608
13EG	Kohler	—	—	23-7780	—	—	—
13EGZ	Kohler	—	—	23-7780	—	—	—
13EGD	Kohler	—	—	—	—	—	—
15C	Kohler	—	—	—	23-2002	23-3303	23-3608
15EG	Kohler	—	—	23-7780	—	—	—
15EGD	Kohler	—	—	23-7780	—	—	—
15EGZ	Kohler	—	—	23-7780	—	—	—
16CF	Kohler	—	—	—	23-2002	23-3303	23-3608
17.5CF	Kohler	—	—	—	—	—	—
20C	Kohler	—	—	—	23-2002	23-3303	23-3608
MDKAU	Onan	—	—	23-7760	—	—	—
MDKAV	Onan	—	—	23-7760	—	23-3300	—
MDKBG	Onan	—	—	23-7760	—	23-3300	—
MDKAW (Spacesaver)	Onan	—	—	23-7760	—	23-3300	—
MDKAZ	Onan	—	—	23-7760	—	23-3300	—
MDKBD	Onan	—	—	23-7760	—	23-3300	—
MDKBE	Onan	—	—	23-7760	—	23-3300	—
MDKBF	Onan	—	—	23-7760	—	23-3300	—
MDKBD (w/ Isolated Ground)	Onan	—	—	23-7760	—	23-3300	—
MDKBE (w/ Isolated Ground)	Onan	—	—	23-7760	—	23-3300	—
MDKBF (w/ Isolated Ground)	Onan	—	—	23-7760	—	23-3300	—
MDKBH	Onan	—	—	—	—	—	—
MDKBK	Onan	—	—	—	23-2000	23-3310	—
MDKBL	Onan	—	—	—	23-2000	23-3310	—
MDKBM	Onan	—	—	—	23-2000	23-3310	—
MDKBN	Onan	—	—	—	23-2000	23-3310	—
MDKBP	Onan	—	—	—	—	—	—
MDKBR	Onan	—	—	—	—	—	—
MDKBS	Onan	—	—	—	—	—	—
MDKBV	Onan	—	—	—	—	—	—
MDKBT	Onan	—	—	—	—	—	—
MDKBU	Onan	—	—	—	—	—	—
MDDCA	Onan	—	—	—	—	23-3309	—
MDDCB	Onan	—	—	—	—	23-3309	—
MDDCC	Onan	—	—	—	—	23-3309	—
MDDCF	Onan	—	—	—	—	23-3309	—
MDDCG	Onan	—	—	—	—	23-3309	—
MDDCD	Onan	—	—	—	—	23-3309	—
MDDCE	Onan	—	—	—	—	23-3309	—
MDDCH	Onan	—	—	—	—	23-3309	—
MDDCJ	Onan	—	—	—	—	23-3309	—
MDJA	Onan	—	—	23-7750 (Spec A-R)	—	—	23-3606
MDJB	Onan	—	—	23-7750 (Spec A-R)	—	—	23-3606
MDJC	Onan	—	—	23-7750 (Spec A-R)	—	—	23-3606
MDJE	Onan	—	—	23-7750 (Spec A)	—	—	23-3606
MDJF	Onan	—	—	23-7750 (Spec A)	—	—	23-3606
MJA	Onan	—	—	—	—	—	23-3606
MJB	Onan	—	—	—	—	—	23-3606
MJC	Onan	—	—	—	—	—	23-3606
MDKAD/E/F	Onan	—	—	23-7760	—	—	—
MDKAL/A/B	Onan	—	—	—	23-2000	23-3310	—
AGTPM 4	Fischer Panda	—	—	—	23-2001	23-3311	—
PMS 4	Fischer Panda	—	—	—	23-2001	23-3311	—
PMS 8 Mini	Fischer Panda	—	—	—	23-2001	23-3305	—
PMS 8 DP	Fischer Panda	—	—	—	23-2001	23-3305	—
PMS 4200	Fischer Panda	—	—	—	23-2001	23-3305	—
PMS 6500	Fischer Panda	—	—	—	23-2001	23-3305	—
PMS 12 DP	Fischer Panda	—	—	—	23-2001	23-3305	—
PMS 12 Mini	Fischer Panda	—	—	—	23-2001	23-3305	—
PMS 15	Fischer Panda	—	—	—	—	23-3312	—

Model	OEM	Starter	Alternator	Fuel Filter	Impeller	Impeller Kit	Thermostat
PMS 16 DP	Fischer Panda	—	—	—	—	23-3312	—
PMS 20	Fischer Panda	—	—	—	—	23-3312	—
PMS 22	Fischer Panda	—	—	—	—	23-3312	—
PMS 25	Fischer Panda	—	—	—	—	23-3312	—
PMS 30	Fischer Panda	—	—	—	—	23-3312	—
PMS 40	Fischer Panda	—	—	—	—	23-3312	—
PMS 50	Fischer Panda	—	—	—	—	23-3312	—
M673LD3	Northern Lights	—	—	—	23-2005	23-3315	—
M673L3	Northern Lights	—	—	—	23-2005	23-3315	—
M673LD2	Northern Lights	—	—	—	23-2005	23-3315	—
M673L2	Northern Lights	—	—	—	23-2005	23-3315	—
M753	Northern Lights	—	—	—	—	—	—
M753G	Northern Lights	—	—	—	—	—	—
M753K	Northern Lights	—	—	—	—	—	—
M753W	Northern Lights	—	—	—	—	—	—
M753w2	Northern Lights	—	—	—	—	—	—
M773L	Northern Lights	—	—	—	—	—	—
M773LW2	Northern Lights	—	—	—	—	—	—
M773LW3: 9/7Kw	Northern Lights	—	—	—	—	—	—
M843	Northern Lights	—	—	—	—	—	—
M843N	Northern Lights	—	—	—	—	—	—
M843NK	Northern Lights	—	—	—	—	—	—
M843NK2	Northern Lights	—	—	—	—	—	—
M843NW	Northern Lights	—	—	—	—	—	—
M843NW2	Northern Lights	—	—	—	—	—	—
M843NW3	Northern Lights	—	—	—	—	—	—
M844	Northern Lights	—	—	—	—	—	—
M844K	Northern Lights	—	—	—	—	—	—
M844L	Northern Lights	—	—	—	—	—	—
M844LK	Northern Lights	—	—	—	—	—	—
M844LW	Northern Lights	—	—	—	—	—	—
M844LW2	Northern Lights	—	—	—	—	—	—
M844W	Northern Lights	—	—	—	—	—	—
M844W2	Northern Lights	—	—	—	—	—	—
M844W3: 16/12KW	Northern Lights	—	—	—	—	—	—
M844LW3: 20/16Kw	Northern Lights	—	—	—	—	—	—
M844NK2	Northern Lights	—	—	—	—	—	—
M844LK2	Northern Lights	—	—	—	—	—	—
M844NW2	Northern Lights	—	—	—	—	—	—
M844NW3	Northern Lights	—	—	—	—	—	—
ML844	Northern Lights	—	—	—	—	—	—
ML844K	Northern Lights	—	—	—	—	—	—
ML844L	Northern Lights	—	—	—	—	—	—
ML844LK	Northern Lights	—	—	—	—	—	—
M864K	Northern Lights	—	—	—	—	—	—
M864W	Northern Lights	—	—	—	—	—	—
M864W3: 25/20Kw	Northern Lights	—	—	—	—	—	—
M16C	Northern Lights	—	—	—	—	—	—
M20CL	Northern Lights	—	—	—	—	—	—
M20CR	Northern Lights	—	—	—	—	—	—
IS 2.5	Mase					23-3311	
IS 4.0	Mase					23-3311	
IS 4.7	Mase					23-3311	
IS 7.1	Mase					23-3311	
IS 13.2	Mase						
IS 8.1	Mase			23-7751			
IS 10.2	Mase					23-3312	
IS 14.0	Mase					23-3312	
IS 15.6T	Mase						
IS 19.0	Mase					23-3312	
IS 23.1T	Mase					23-3312	
IS 28.0	Mase						
IS 31.0	Mase						
IS 42.0	Mase						

Thermostat Kit	Oil Filter	Air Filter	Thermostat Gasket	Anode	Carburetor Kit	Glow Plug	Temperature Sender	Oil Pressure Sender	Solenoid
—	23-7842	23-1104	—	—	—	—	—	—	—
—	—	23-1104	—	—	—	—	—	—	—
—	23-7842	23-1104	—	—	—	—	—	—	—
—	—	—	—	—	—	—	—	—	—
—	—	—	—	—	—	—	—	—	—
—	—	—	—	—	—	—	—	—	—
—	—	—	—	—	—	—	—	—	—
		23-1103							
		23-1103							
		23-1103							
		23-1103							
—	23-7801	—	—	—	—	—	—	—	—
—	23-7801	—	—	—	—	—	—	—	—
—	23-7801	—	—	—	—	—	—	—	—
—	23-7801	—	—	—	—	—	—	—	—
—	23-7801	—	—	—	—	—	—	—	—
—	23-7801	—	—	—	—	—	—	—	—
—	23-7801	—	—	—	—	—	—	—	—
—	23-7801	—	—	—	—	—	—	—	—
—	23-7801	—	—	—	—	—	—	—	—
—	23-7801	—	—	—	—	—	—	—	—
—	23-7801	—	—	—	—	—	—	—	—
—	23-7801	23-1102	—	—	—	—	—	—	—
—	23-7801	—	—	—	—	—	—	—	—
—	23-7801	23-1102	—	—	—	—	—	—	—
		23-1102							
—	23-7801	—	—	—	—	—	—	—	—
—	23-7801	—	—	—	—	—	—	—	—
—	23-7801	—	—	—	—	—	—	—	—
—	23-7801	—	—	—	—	—	—	—	—
—	23-7801	—	—	—	—	—	—	—	—
—	23-7801	23-1102	—	—	—	—	—	—	—
—	23-7801	—	—	—	—	—	—	—	—
—	23-7801	23-1102	—	—	—	—	—	—	—
—	23-7801	23-1102	—	—	—	—	—	—	—
—	23-7801	23-1102	—	—	—	—	—	—	—
—	23-7801	23-1102	—	—	—	—	—	—	—
—	23-7801	23-1102	—	—	—	—	—	—	—
—	23-7801	23-1102	—	—	—	—	—	—	—
—	23-7801	23-1102	—	—	—	—	—	—	—
—	23-7801	—	—	—	—	—	—	—	—
—	23-7801	—	—	—	—	—	—	—	—
—	23-7801	—	—	—	—	—	—	—	—
—	23-7801	—	—	—	—	—	—	—	—
—	23-7801	—	—	—	—	—	—	—	—
—	23-7801	—	—	—	—	—	—	—	—
—	23-7801	—	—	—	—	—	—	—	—
—	23-7801	—	—	—	—	—	—	—	—
—	23-7801	—	—	—	—	—	—	—	—
—	23-7801	—	—	—	—	—	—	—	—
—	23-7801	—	—	—	—	—	—	—	—
—	23-7801	—	—	—	—	—	—	—	—
—	23-7801	—	—	—	—	—	—	—	—
—	23-7801	—	—	—	—	—	—	—	—
—	23-7801	—	—	—	—	—	—	—	—
—	23-7801	—	—	—	—	—	—	—	—
—	23-7801	—	—	—	—	—	—	—	—

FUEL WATER SEPARATORS

Sierra fuel water separators remove over 99.8% of emulsified water from your gasoline. Sierra's 10 micron filters are over 90% efficient at removing particles as small as 10 micron. All filters flow @ 90 GPH to feed even the hungriest motor. Sierra 10 micron filters are recommended to prevent damage to sensitive inboard, sterndrive and outboard fuel injection systems.



Includes Bracket, Filter & 2 pipe plugs*

- UNIVERSAL DESIGN -

FUEL WATER SEPARATOR BRACKETS

Part #	Thread	Material	Replaces
18-7777	1/4"	Stainless Steel	Yamaha MAR-FLTHD-SS-12
18-7776	3/8"	Stainless Steel	
18-7853-1	1/4"	Aluminum	Mercury 89876A3 Yamaha MAR-FLTHD-AL-12
18-7775	3/8"	Aluminum	

FILTERS

Part #	Description	Micron Rating	Replaces
18-7944	Short - 3.875"	10	Mercury - 35-807172, 35-802893Q
18-7945	Long - 4.35"	10	Mercury - 35-802893Q Yamaha - ABB-FUELF-IL-TR
18-7866	High Capacity - 6"	10	Yamaha - MAR-FUELF-IL-TR
18-7967	V6 EFI 1995-Earlier with sensor	10	Mercury - 35-18458Q3
18-7968	V6 EFI 1996-Up with sensor	10	Mercury - 35-18458Q4
18-7844	Short - 3.875"	21	Mercury - 35-807172, 35-802893Q
18-7845	Long - 4.35"	21	Mercury - 35-802893Q Yamaha - ABB-FUELF-IL-TR

FUEL WATER SEPARATOR KITS

Part #	Kit Type	Micron Rating	Contents	Replaces
18-7983-1	1/4" Aluminum (Short Filter)	10	1 - 18-7944 & 1 - 18-7853-1	Mercury - 35-802893A4, Q4, 35-60494A4
18-7982-1	1/4" Aluminum (Tall Filter)	10	1 - 18-7945 & 1 - 18-7853-1	
18-7966-1	1/4" Aluminum (High Capacity Filter)	10	1 - 18-7866 & 1 - 18-7853-1	Yamaha - MAR-SEPAR-AT-OR
18-7986-1	3/8" Aluminum (Tall Filter)	10	1 - 18-7945 & 1 - 18-7775	
18-7984-1	1/4" Stainless Steel (Tall Filter)	10	1 - 18-7945 & 1 - 18-7777	Yamaha - MAR-SPRTR-HD-SS
18-7985-1	3/8" Stainless Steel (Tall Filter)	10	1 - 18-7945 & 1 - 18-7776	
18-7848-1	1/4" Aluminum (Short Filter)	21	1 - 18-7844 & 1 - 18-7853-1	Mercury - 35-802893A4, Q4, 35-60494A4
18-7852-1	1/4" Aluminum (Tall Filter)	21	1 - 18-7845 & 1 - 18-7853-1	Yamaha - MAR-SEPAR-AT-OR
18-7775-1	3/8" Aluminum (Tall Filter)	21	1 - 18-7845 & 1 - 18-7775	
18-7777-1	1/4" Stainless Steel (Tall Filter)	21	1 - 18-7845 & 1 - 18-7777	Yamaha - ABB-SPRTR-HD-SS
18-7776-1	3/8" Stainless Steel (Tall Filter)	21	1 - 18-7845 & 1 - 18-7776	

3/8" Pipe Plugs - 18-4264
1/4" Pipe Plugs - 18-4256



*Each kit contains 2 brass pipe plugs

FUEL WATER SEPARATOR KITS - BONUS PACK CONTAINS SPARE FILTER

Part #	Kit Type	Micron Rating	Contents
18-7983-2	1/4" Aluminum	10	2 - 18-7944 & 1 18-7853-1
18-7982-2	1/4" Aluminum	10	2 - 18-7945 & 1 18-7853-1
18-7848-2	1/4" Aluminum	21	2 - 18-7844 & 1 18-7853-1
18-7852-2	1/4" Aluminum	21	2 - 18-7845 & 1 18-7853-1

SIERRA AquaVue™ & METAL COLLECTION BOWL FUEL WATER SEPARATOR KITS

Sierra AquaVue™ and metal collection bowl separator filters allow water to be drained from the filter to extend service life. Use the AquaVue™ collection bowl for outboard, above deck installations. USCG regulations require the use of the flame resistant metal collection bowl below deck.



*Each kit contains 2 brass pipe plugs

10 MICRON FILTER KITS WITH COLLECTION BOWLS

Part #	Kit Type	Contents
18-7932	1/4" Aluminum w/ AquaVue™ collection bowl	1 - 18-7919 & 1 18-7853-1 1 - 18-7922
18-7951	1/4" Aluminum w/ metal collection bowl	1 - 18-7919 & 1 18-7853-1 1 - 18-7924
18-7937	1/4" Stainless Steel w/ AquaVue™ collection bowl	1 - 18-7919 & 1 18-7777 1 - 18-7922
18-7938	1/4" Stainless Steel w/ metal collection bowl	1 - 18-7919 & 1 18-7777 1 - 18-7924

REPLACEMENT BOWLS

Part #	Description	Replaces
18-7922	AquaVue™ Collection Bowl	Suzuki 99105-20004-BWL
18-7924	Metal Collection Bowl	Yamaha MAR-10171-00-10

REPLACEMENT ELEMENTS & ELEMENT BOWL ASSEMBLIES

Part #	Description	Replaces
18-7919	Spin on replacement	Mercury 35-809097 Yamaha MAR-24563-00-00 Racor S3213
18-7928	Filter & AquaVue™ Collection Bowl Mercury/Yamaha Style Contains: 18-7919 , 18-7922	Racor B32013
18-7929	Filter & Metal Collection Bowl Mercury/Yamaha Style Contains: 18-7919 , 18-7924	Mercury 35-809100 Racor B32020MAM
18-0179	Bowl O-Ring Standard Metal and AquaVue™ Collection Bowl	Racor RK22244
18-7394	Bowl O-Ring Mini 10 AquaVue™ Collection Bowl	Racor RK10012
18-9884	Bowl Wrench	Racor RK22628

3/8" Pipe Plugs - 18-4264
1/4" Pipe Plugs - 18-4256

**COMPACT BRACKET & SEPARATOR KIT FOR OUTBOARDS UP TO 115HP
10 MICRON FILTRATION FOR SMALL OUTBOARD MOTORS**

**18-7965-1
10 MICRON COMPACT
SEPARATOR KIT**
Replaces: Yamaha
MAR-MINIF-LT-AS
Contains:
1 - 18-7774 bracket
1 - 18-7865 filter



**18-7774
COMPACT ALUMINUM BRACKET**



**18-7865
REPLACEMENT FILTER**
Replaces: Yamaha MAR-MINIF-IL-TR



**18-79906
FUEL FILTER**
For: Racor style Mini-10



**18-7987
AquaVue™ BOWL**
For: Racor style Mini-10



**18-7988
COLLECTION BOWL**
For: Racor style Mini-10



OMC REPLACEMENT FUEL FILTERS

**18-7920
10 MICRON REPLACEMENT FILTER**
Replaces: OMC 771839,
Racor S3214, Mercury 35-809099



**18-7941
FILTER & AquaVue™ BOWL**
OMC style
Contains: 18-7920, 18-7922



**18-7943
FILTER & METAL BOWL**
OMC style
Contains: 18-7920, 18-7924



**18-7946
10 MICRON REPLACEMENT FILTER**
Replaces: OMC 502905
OMC thread



**18-7846
21 MICRON REPLACEMENT FILTER**
Replaces: OMC 502905
OMC thread



**18-7930
FUEL FILTER**
Replaces: OMC 173326
For: 1977-83 Fuel system with add on filter kit



VOLVO STYLE FUEL WATER SEPARATOR KITS

**18-8149
HIGH CAPACITY
FUEL WATER SEPARATING FILTER
10 MICRON**
Replaces: Volvo 3847644
For use with side-by-side fuel pump applications.



**18-7990-1
21 MICRON
SEPARATOR KIT**
Contains:
1 - 18-7778 &
1 - 18-7789



**18-7991-1
10 MICRON
SEPARATOR KIT**
Contains:
1 - 18-7778 &
1 - 18-7989



**18-7778
VOLVO ALUMINUM
REPLACEMENT BRACKET**
Replaces: Volvo 3850861

10 MICRON REPLACEMENT FILTERS		
Part #	Description	Replaces
18-7989	Volvo SX/EFI Cobra EFI	Volvo 3851218-2, 3852413, 3862228 OMC 502906

21 MICRON REPLACEMENT FILTERS		
Part #	Description	Replaces
18-7789	Volvo SX/EFI Cobra EFI	Volvo 3851218-2, 3852413 OMC 502906

REPLACEMENT ELEMENTS & ASSEMBLIES FOR RACOR FILTER KITS



ELEMENT & BOWL KITS

Part #	Description	Contains
18-7969	Filter & Metal Bowl	18-7948 , 18-7924
18-7994	Filter & AquaVue™ Bowl	18-7948 , 18-7922

REPLACEMENT ELEMENT ONLY

Part #	Element for Racor	Replaces
18-7947	120RRAC01	Honda 17670-ZW1-030GH Racor S3240 Suzuki 99105-20006
18-7948	320RRAC01	Honda 17670-ZW1-801AH Mercury 35-886638 Racor S3227 Suzuki 99105-20005
18-7949	660RRAC02	Racor S3232

REPLACEMENT BOWL

Part #	Description	Replaces
18-7987	AquaVue™ Mini Bowl	Racor RK 10222 Suzuki 99105-20006-BWL
18-7988	Mini Metal Bowl	—

BOWL WRENCH

18-9884	Bowl Wrench	Racor RK22628
---------	-------------	---------------

DIESEL FUEL FILTERS



18-7931
Replaces:
Detroit Diesel 5574508
8V-92, 8V-71



18-7934
Replaces:
Cerlist Diesel 1512904
Model M



18-7935
Replaces:
Fram CCS 1136
Fram FCS 1136 Filter Bracket



18-7970
Replaces: Cerlist Diesel
1512903
Model 3M



18-79960
Fuel Filter Element
Replaces: Yanmar
104500-55710
Fits: All GM Series, YM Series,
HM Series, QM Series



18-7939
Replaces: Generac
Generators 10257778



18-7940
Replaces:
Volvo 838593,
3588378,
860874
For: KAD32P, TAM-
D42WJ, KAD43P/44P/300,
KAMD43P/44P/300, KAMD42A, KAD42A,
KAMD42P, KAD42P, MD22L-A, MD22A-A, TMD22A-A,
MD22L-B, MD22P-B, TMD22-B, TMD22P-C, TAM-
D22P-B, TAMD42B, KAMD42B, KAD42B, TMD31L,
TAMD31P/L/M/S, AD31P/L, TMD41L, TAMD41P/L/M/H,
TMD41B, TAMD41B, D41B, AD41B (SN 2204141573
& Up), TMD41D, TAMD41D, D41D, AD41D, D41 (SN
2204141572 & Below), MD40, TMD40, TAMD40,
AQAD40, KAD32P, TAMD42WJ, KAD43P/44P/300,
KAMD43P/44P/300



18-7942
Replaces:
Volvo 466987,
3825133
For: MD100A, TMD100A,
MD100B, MD120A,
TMD120A, TAMD120A,
MD120B, TMD120B, TAM-
D120B, MD70B, TMD70B,
TAMD70B, THAMD70B,
AQAD70B, MD70C, TM-
D70C, TAMD70C, AQD70C,
TAMD60A, TAMD60B, TAMD60C, D5/D7 MARINE
GENSET, D5A-T, D5A-TA, D7A-T, D7A-TA, D7C-TA,
D63 MARINE, D71/73 MARINE, KAD32P, TAMD42WJ,
KAD43P/44P/300, KAMD43P/44P/300, TAMD103A,
TAMD61A, TAMD62A, TAMD71A, TAMD72A,
TAMD72P, TAMD72WJ, TAMD74, TAMD75 MARINE,
TMD102A, TAMD102A, TAMD102D, TAMD122A,
TAMD122A, TAMD122P, TMD31L, TAMD31P/L/M/S,
AD31P/L, TMD41L, TAMD41P/L/M/H



18-7858
Replaces: Volvo
858201
For CAV Type Unit
For: AQ120B, 125A, B, 131A,
140A, 145A, B, 151, BB, 140, 145A



18-7873
Replaces:
Mercruiser 35-808275
For models: D7.3/270 Bravo &
MIE Diesel Engines (1994-96)



18-8124
Replaces: Volvo 829913
For: 2001, 2001B, 2002, 2002B,
2003, 2003B/T/TB, AQD2B,
MD11C/D, MD17C/D, MD1B,
MD2B, MD3B, MD5A/B/C, MD7/B

18-8125

Replaces: Volvo 3583443
For: D4-180i-B, D4-180i-C, D4-210A-A, D4-210A-B,
D4-210i-A, D4-210i-B, D4-225A-B, D4-225A-C, D4-225i-
B, D4-225i-C, D4-260A-A, D4-260A-B, D4-260A-C,
D4-260D-B, D4-260D-C, D4-260i-A, D4-260i-B, D4-260i-
C, D4-300A-A, D4-300A-C, D4-300D-A, D4-300D-C,
D4-300i-A, D4-300i-C, D6-280A-A, D6-280A-B,
D6-280i-A, D6-280i-B, D6-310A-A, D6-310A-B, D6-310D-
A, D6-310D-B, D6-310i-A, D6-310i-B, D6-330A-B,
D6-330A-C, D6-330D-B, D6-330D-C, D6-330i-B, D6-330i-
C, D6-350A-A, D6-350A-B, D6-370A-B, D6-370A-C,
D6-370D-A, D6-370D-B, D6-370D-C, D6-370i-A,
D6-370i-B, D6-370i-C, D6-435D-A, D6-435D-C, D6-435i-
A, D6-435i-C



18-8126
Replaces: Volvo 861477
For: D1-13 A, D1-13 B, D1-20 A, D1-20 B,
D1-30 A, D1-30 B, D2-40 A, D2-40 B, D2-55
A, D2-55 B, D2-55 C, D2-55 D, D2-55
E, D2-55F, D2-75 A, D2-75 B, D2-75 C,
D2-75F, MD2010A, MD2010B, MD2020A,
MD2020B, MD2030A, MD2030B,
MD2040A, MD2040B

FUEL FILTERS



FUEL FILTER
18-7723
 Fits: 1/4" and 5/16" hose
18-7724
 Fits: 3/8" and 7/16" hose



18-7828-1
FUEL FILTER
 Small Capacity for 1/4" Fuel Line



Display Package

FUEL FILTERS

Part #	Replaces	Application:
18-7829	Mercury 35-16494, 35-816296, T, Q, 35-816296K03	1/4" Large Capacity (For 1/4" Fuel Line)
18-7830	Mercury 35-16494-1, 35-816296 1, T1, Q2 Johnson/Evinrude 398327	5/16"
18-7831	Mercury 802128A1, Johnson/Evinrude 398319	3/8"



18-7856-1
FUEL FILTER
 Replaces: A.C. Delco GF-61
 For 5/16" Fuel Line



18-7857-1
FUEL FILTER
 Replaces: A.C. Delco GF-61P
 For 3/8" Fuel Line



18-7790
FUEL FILTER KIT
 Complete Kit Contains: Housing, Replaceable Element & Fittings for 1/4", 5/16", & 3/8" Fuel Lines



18-7791
FUEL FILTER ELEMENT
 Replacement element for 18-7790 filter kit



18-9884
BOWL WRENCH
 Replaces: Racor RK22628
 Fits Sierra, Racor and other aftermarket filter bowls

PRIMER BULBS



- Meets current EPA regulations in effect 1/1/2011 of 15 g/m2/24 hrs.
- Both EPA/CARB certified
- Utilizes Fluoroelastomer (FKM) material for traditional look and operation.



18-8002EP-1
PRIMER BULB ASSEMBLY
 1/4" I.D.



18-8004EP-1
18-8004-10EP-1
PRIMER BULB ASSEMBLY
 Replaces: Mercury 89396A38, 89396Q38 Johnson/Evinrude 174511
 5/16" I.D.



18-8005EP-1
18-8005-10EP-1
PRIMER BULB ASSEMBLY
 Replaces: Mercury 13330A3, 13330Q, Johnson/Evinrude 174512
 3/8" I.D.

SILVERADO 4000 COMPLETE FUEL LINE ASSEMBLIES



- Premium Rubber Fuel Line
 - Polyester braid
 - Weather resistant CPE cover
 - Flexible THV barrier layer
- Updated packaging
- Best hose on the market-resists kinking and easy to clamp

CHRYSLER / FORCE

8' LENGTH COMPLETE FUEL LINE ASSEMBLIES

3/8"
FUEL LINE ASSEMBLY

18-8011EP-1 *SILVERADO 4000 Premium*

OE# FS409752



*



18-8071
TANK
CONNECTOR
(SOLD SEPARATELY)



18-8005EP-1
PRIMER
BULB



18-8062
FUEL
CONNECTOR



*

FUEL LINE ASSEMBLY COMPONENTS

HONDA

9' LENGTH COMPLETE FUEL LINE ASSEMBLIES

3/8"
FUEL LINE ASSEMBLY

18-81042EP-1 *SILVERADO 4000 Premium* OE# 17700-ZW9-010
17700-ZW9-020



*



18-80400
TANK
CONNECTOR
(SOLD SEPARATELY)



18-80401
FUEL
CONNECTOR



18-8005EP-1
PRIMER
BULB



18-80403
FUEL
CONNECTOR



*

FUEL LINE ASSEMBLY COMPONENTS

Honda Fuel Application: 8, 9.9, 15, 25, 30, 40, 50, 75, 90, 115, 130 HP (2001-02)

JOHNSON / EVINRUDE

8' LENGTH COMPLETE FUEL LINE ASSEMBLIES

3/8" High Flow
FUEL LINE ASSEMBLY

18-8009EP-1 *SILVERADO 4000 Premium*

OE# 398549



*



18-8063
TANK
CONNECTOR
(SOLD SEPARATELY)



18-8092
FUEL
CONNECTOR



18-8005EP-1
PRIMER
BULB



18-8092
FUEL
CONNECTOR



*

FUEL LINE ASSEMBLY COMPONENTS

Fits: All V8, 1984 & later V6, 1985 & later 120 HP, 140 HP outboards, 2 HP (1 cyl.) - 75 HP (3 cyl.) (1976-02)

* Tanks and Engines for picture purpose only.

JOHNSON / EVINRUDE (Cont.)

8' LENGTH COMPLETE FUEL LINE ASSEMBLIES

3/8"
FUEL LINE ASSEMBLY

18-8014EP-1 *SILVERADO 4000 Premium*

OE# 174509



18-8074
HOSE BARB
(SOLD SEPARATELY)



18-8005EP-1
PRIMER
BULB



18-8092
FUEL
CONNECTOR



*

FUEL LINE ASSEMBLY COMPONENTS
Fits: All V6 & V8 (1976-02)

MERCURY / MARINER

8' LENGTH COMPLETE FUEL LINE ASSEMBLIES

3/8"
FUEL LINE ASSEMBLY

18-8010EP-1 *SILVERADO 4000 Premium*



18-8068
18-8082
TANK
CONNECTOR
(SOLD SEPARATELY)



18-8084
FUEL
CONNECTOR



18-8005EP-1
PRIMER
BULB



18-8083
FUEL
CONNECTOR



*

FUEL LINE ASSEMBLY COMPONENTS

8' LENGTH COMPLETE FUEL LINE ASSEMBLIES

3/8"
FUEL LINE ASSEMBLY

18-8012EP-1 *SILVERADO 4000 Premium*

OE# 32-858114Q08,
32-858114K08



18-8074
HOSE BARB



18-8005EP-1
PRIMER
BULB



18-8073
HOSE BARB



*

FUEL LINE ASSEMBLY COMPONENTS

Has 1/8" NPT threaded fitting on engine end and 1/4" NPT threaded fitting on the tank end. Primer bulb is included in this 8ft. (2.44 m) assembly. Fits various applications using the older style twist type disconnects at the engine end and either a bayonet or thread-in fitting on the tank end.

8' LENGTH COMPLETE FUEL LINE ASSEMBLIES

3/8"
FUEL LINE ASSEMBLY

18-8024EP-1 *SILVERADO 4000 Premium*

OE# 32-858104Q08,
32-858104K08



18-8074
HOSE BARB



18-8005EP-1
PRIMER
BULB



18-8076
FUEL
CONNECTOR



*

FUEL LINE ASSEMBLY COMPONENTS

Has standard quick connect type fitting on engine end and 1/4" NPT threaded fitting on the tank end. Primer bulb is included in this 8 ft. (2.44 m) assembly. Fits Force 40 HP and larger (1993 & Newer), Force 9.9/15/25HP (1998), and all Mercury/Mariner outboards using clip on type disconnect at engine ends and a tank with threaded fuel pickup fitting.

8' LENGTH COMPLETE FUEL LINE ASSEMBLIES

3/8"
FUEL LINE ASSEMBLY

18-8025EP-1 *SILVERADO 4000 Premium*

OE# 32-858105Q08,
32-858105K08



18-8068
18-8082
TANK
CONNECTOR
(SOLD SEPARATELY)



18-8084
FUEL
CONNECTOR



18-8005EP-1
PRIMER
BULB



18-8076
FUEL
CONNECTOR



*

FUEL LINE ASSEMBLY COMPONENTS

Has standard quick connect type fitting on engine end and bayonet style fitting on the tank end. Primer bulb is included in this 8 ft. (2.44 m) assembly. Fits Force 40 HP and larger (1993 & Newer), Force 9.9/15/25HP (1998), and all Mercury/Mariner outboards using clip-on type disconnect at the engine end and an older style tank with bayonet type connection.

* Tanks and Engines for picture purpose only.

MERCURY / MARINER (Cont.)

8' LENGTH COMPLETE FUEL LINE ASSEMBLIES

3/8"
FUEL LINE ASSEMBLY

18-8016EP-1 *SILVERADO 4000 Premium*

OE# 32-858109Q12,
32-858109K12



18-80402
TANK
CONNECTOR
(SOLD SEPARATELY)



18-8091
FUEL
CONNECTOR

18-8005EP-1
PRIMER
BULB

18-8076
FUEL
CONNECTOR



*

*

FUEL LINE ASSEMBLY COMPONENTS

Has double sealed quick connect type fitting on tank end and clip-on type quick connect on engine end. Primer bulb is included in this 8ft. (2.44m) assembly. Fits Force 40 HP and larger (1993 & Newer), Force 9.9/15/25HP (1998) and all Mercury Mariner outboards using clip-on type disconnects at both tank and engine ends

12' LENGTH COMPLETE FUEL LINE ASSEMBLIES

3/8"
FUEL LINE ASSEMBLY

18-8023EP-1 *SILVERADO 4000 Premium*

OE# 32-857103Q12,
32-857103K12



18-8074
HOSE BARB

18-8005EP-1
PRIMER
BULB

18-8073
HOSE BARB



*

*

FUEL LINE ASSEMBLY COMPONENTS

Has 1/8" NPT threaded fitting on engine end and 1/4" NPT threaded fitting on the tank end. Primer bulb is included in this 12ft. (2.44 m) assembly. Fits various applications using the older style twist type disconnects at the engine end and either a bayonet or thread-in fitting on the tank end.

NISSAN / TOHATSU

8' LENGTH COMPLETE FUEL LINE ASSEMBLIES

3/8"
FUEL LINE ASSEMBLY

18-8027EP-1 *SILVERADO 4000 Premium*



18-8078
TANK
CONNECTOR
(SOLD SEPARATELY)



18-8079
FUEL
CONNECTOR

18-8005EP-1
PRIMER
BULB

18-8088
FUEL
CONNECTOR



18-8089
FUEL
CONNECTOR
(SOLD SEPARATELY)



*

*

FUEL LINE ASSEMBLY COMPONENTS

SUZUKI

8' LENGTH COMPLETE FUEL LINE ASSEMBLIES

3/8"
FUEL LINE ASSEMBLY

18-8018EP-1 *SILVERADO 4000 Premium*

OE# 65700-95513



18-8078
TANK
CONNECTOR
(SOLD SEPARATELY)



18-8079
FUEL
CONNECTOR

18-8005EP-1
PRIMER
BULB

18-8079
FUEL
CONNECTOR



*

*

FUEL LINE ASSEMBLY COMPONENTS

8' LENGTH COMPLETE FUEL LINE ASSEMBLIES

3/8"
FUEL LINE ASSEMBLY

18-8019EP-1 *SILVERADO 4000 Premium*



18-8071
TANK
CONNECTOR
(SOLD SEPARATELY)



18-8062
FUEL
CONNECTOR

18-8005EP-1
PRIMER
BULB

18-8062
FUEL
CONNECTOR



*

*

FUEL LINE ASSEMBLY COMPONENTS

* Tanks and Engines for picture purpose only.

SUZUKI (Cont.)

6' LENGTH COMPLETE FUEL LINE ASSEMBLIES

3/8"
FUEL LINE ASSEMBLY

18-8035EP-1 *SILVERADO 4000 Premium*

OE# 65700-87J10



18-8078
TANK
CONNECTOR
(SOLD SEPARATELY)



18-80405
FUEL
CONNECTOR

18-8005EP-1
PRIMER
BULB

18-80404
FUEL
CONNECTOR



*

*

FUEL LINE ASSEMBLY COMPONENTS
Fits: DF25-140 HP (2000-05)

YAMAHA

8' LENGTH COMPLETE FUEL LINE ASSEMBLIES

3/8"
FUEL LINE ASSEMBLY

18-8017EP-1 *SILVERADO 4000 Premium*

OE# 6YL-24306-60-00



18-8077-1
TANK
CONNECTOR
(SOLD SEPARATELY)



18-80415
FUEL
CONNECTOR

18-8005EP-1
PRIMER
BULB

18-80415
FUEL
CONNECTOR



*

*

FUEL LINE ASSEMBLY COMPONENTS
Fits: F75-F250 and 115-300 HP

UNIVERSAL

8' LENGTH FUEL LINE ASSEMBLIES

5/16"
FUEL LINE ASSEMBLY

18-8013EP-1 *SILVERADO 4000 Premium*



18-8004EP-1
PRIMER
BULB



*

*

FUEL LINE ASSEMBLY COMPONENTS

8' LENGTH FUEL LINE ASSEMBLIES

3/8"
FUEL LINE ASSEMBLY

18-8015EP-1 *SILVERADO 4000 Premium*



18-8005EP-1
PRIMER
BULB



*

*

FUEL LINE ASSEMBLY COMPONENTS

12' LENGTH COMPLETE FUEL LINE ASSEMBLIES

5/16"
FUEL LINE ASSEMBLY

18-8032EP-1 *SILVERADO 4000 Premium*



18-8004EP-1
PRIMER
BULB



*

*

FUEL LINE ASSEMBLY COMPONENTS

* Tanks and Engines for picture purpose only.



HOSE BARBS

HOSE BARB APPLICATION					
Part #	Mercury O.E. #	OMC O.E. #	Barb	NPT	Conn. Type
18-8041	—	—	5/8"	3/8"	Male
18-8042	—	—	1/4"	1/4"	Male
18-8043	—	—	1/4"	1/2"	Male
18-8044	—	—	3/8"	3/8"	Male
18-8054	22-63186	—	5/16"	1/8"	Male
18-8055	22-63187	173311	5/16"	1/4"	Male
18-8073	—	—	3/8"	1/8"	Male
18-8074	—	173312	3/8"	1/4"	Male
18-8093	—	—	1/4"	1/4"	Female
18-8094	—	—	5/16"	1/4"	Female
18-8095	—	—	3/8"	1/4"	Female
18-8108	—	—	3/8"	3/8"	Male
18-8109	—	—	5/16"	3/8"	Male



**18-8045
REDUCING NIPPLE
FITTING**
1/8" x 1/4" NPT HEX



**18-4256
PIPE PLUG**
1/4" Threads



**18-4264
PIPE PLUG**
3/8" Threads



**18-8046
FUEL TANK ELBOW**
1/8" NPT x 1/4" NPT
90°



**18-8047
FUEL TANK ELBOW**
1/4" NPT Threads
90°



**18-8067
PKG. OF 2
18-8110
18-8110-9①**
Bulk Pack of 12 (18-8067)
FUEL ELBOW
3/8" Barb with
1/4" NPT Thread
90°



**18-1651
SHUT OFF VALVE**
2 way 1/4" FNPT Male/Male
Shut off Valve



**18-1652
SHUT OFF VALVE**
2 way 1/4" FNPT Male/
Female Shut off Valve



**18-1653
SHUT OFF VALVE**
2 way 1/4" FNPT Female/
Female Shut off Valve



**18-1650
SHUT OFF VALVE**
3 way 1/4" FNPT Valve



**18-1655
SHUT OFF VALVE**
3 way 1/4" FNPT Valve w/
Detent



**18-1656
SHUT OFF VALVE**
3 way 3/8" FNPT Valve w/
Detent

PKG. OF 10



SNAPPER CLAMPS				
PART #	O.E.	O.E. #	CLAMP RANGE	CLAMP SIZE
18-8020 ①	Mercury J/E	54-41582-7 322652	.538 - .608	8
18-8021 ①	J/E	911616	.597 - .665	10
18-8034 ①	J/E	329654	.670 - .780	12
18-8200 ①	J/E	322653	.360 - .406	2
18-8201 ①	J/E	124249	.410 - .468	4
18-8202 ①	J/E	322654	.475 - .536	6
18-8203 ①	J/E	329653	.750 - .875	14
18-8204 ①	J/E	324825	.875 - .975	19



FUEL LINE
★ Universal
★ Vinyl

10' Length	50' Roll	I.D.	O.D.
18-8150-10	18-8150	1/8"	1/4"
18-8151-10	18-8151	3/16"	5/16"
18-8152-10	18-8152	1/4"	3/8"

**50' Reels ALCOHOL RESISTANT
SAE J1527 USCG Type B1-15**



**FUEL LINE HOSE
SILVERADO 3000**

16-331-0566 **16-331-0386**
5/16" I.D. 3/8" I.D.
Replaces: J/E 333341 Replaces: J/E 125115

**50' Reels ALCOHOL RESISTANT
SAE J1527 Type B1-15 and ISO 8469**



**FUEL LINE HOSE
SILVERADO 4000**

16-337-0566 **16-337-0386**
5/16" I.D. 3/8" I.D.

① Priced per Package

FUEL LINE HOSE

MADE FROM AN ALCOHOL RESISTANT COMPOUND — 50' REELS



FUEL LINE HOSE
16-331-0566 16-331-0386
5/16" I.D. 3/8" I.D.



18-8048 BLEEDER HOSE
.090 I.D. x .220 O.D.
Similar to Mercury
32-99130122, 32-892024122
18-8050
.0625 I.D. x .190 O.D.
Similar to Mercury 32-9938779



18-8051 FUEL LINE HOSE
for OMC Pressurized Systems
Replaces: J/E 322656
(Double)



18-8052 FUEL LINE HOSE
3/16" I.D.
Non-Pressurized Systems
Replaces: J/E 122838

PRIMER BULBS



- Nitrile construction.
- Manufactured for countries that do not need EPA/CARB compliancy.
- Resistant to alcohol laden fuels.



18-8002S PRIMER BULB ASSEMBLY
1/4" I.D.



18-8004S 18-8004-10S PRIMER BULB ASSEMBLY
Replaces: Mercury 89396A38, 89396Q38
Johnson/Evinrude 174511
5/16" I.D.



18-8005S 18-8005-10S PRIMER BULB ASSEMBLY
Replaces: Mercury 13330A3, 13330Q,
Johnson/Evinrude 174512
3/8" I.D.

SILVERADO 4000 COMPLETE FUEL LINE ASSEMBLIES



- Eight of the most popular numbers, utilizing the Silverado 4000 line and the non-domestic primer bulb.
- Updated packaging.

HONDA

9' LENGTH COMPLETE FUEL LINE ASSEMBLIES

3/8" FUEL LINE ASSEMBLY

18-81042S SILVERADO 4000 Premium

OE# 17700-ZW9-010 17700-ZW9-020



*



18-80400 TANK CONNECTOR
(SOLD SEPARATELY)



18-80401 FUEL CONNECTOR



18-8005S PRIMER BULB



18-80403 FUEL CONNECTOR

*

FUEL LINE ASSEMBLY COMPONENTS

Honda Fuel Application: 8, 9.9, 15, 25, 30, 40, 50, 75, 90, 115, 130 HP (2001-02)

* Tanks and Engines for picture purpose only.

JOHNSON / EVINRUDE

8' LENGTH COMPLETE FUEL LINE ASSEMBLIES

3/8" High Flow
FUEL LINE ASSEMBLY

18-8009S *SILVERADO 4000 Premium*

OE# 398549



18-8063
TANK
CONNECTOR
(SOLD SEPARATELY)



18-8092
FUEL
CONNECTOR



18-8005S
PRIMER
BULB



18-8092
FUEL
CONNECTOR



FUEL LINE ASSEMBLY COMPONENTS

Fits: All V8, 1984 & later V6, 1985 & later 120 HP, 140 HP outboards, 2 HP (1 cyl.) - 75 HP (3 cyl.) (1976-02)

*

*

8' LENGTH COMPLETE FUEL LINE ASSEMBLIES

3/8"
FUEL LINE ASSEMBLY

18-8014S *SILVERADO 4000 Premium*

OE# 174509



18-8074
HOSE BARB
(SOLD SEPARATELY)



18-8005S
PRIMER
BULB



18-8092
FUEL
CONNECTOR



FUEL LINE ASSEMBLY COMPONENTS

Fits: All V6 & V8 (1976-02)

*

*

MERCURY / MARINER

8' LENGTH COMPLETE FUEL LINE ASSEMBLIES

3/8"
FUEL LINE ASSEMBLY

18-8010S *SILVERADO 4000 Premium*



18-8068
18-8082
TANK
CONNECTOR
(SOLD SEPARATELY)



18-8084
FUEL
CONNECTOR

18-8005S
PRIMER
BULB

18-8083
FUEL
CONNECTOR



FUEL LINE ASSEMBLY COMPONENTS

*

*

8' LENGTH COMPLETE FUEL LINE ASSEMBLIES

3/8"
FUEL LINE ASSEMBLY

18-8016S *SILVERADO 4000 Premium*

OE# 32-858109Q12,
32-858109K12



18-80402
TANK
CONNECTOR
(SOLD SEPARATELY)



18-8091
FUEL
CONNECTOR

18-8005S
PRIMER
BULB

18-8076
FUEL
CONNECTOR



FUEL LINE ASSEMBLY COMPONENTS

Has double sealed quick connect type fitting on tank end and clip-on type quick connect on engine end. Primer bulb is included in this 8ft. (2.44m) assembly. Fits Force 40 HP and larger (1993 & Newer), Force 9.9/15/25HP (1998) and all Mercury Mariner outboards using clip-on type disconnects at both tank and engine ends

* Tanks and Engines for picture purpose only.

YAMAHA

8' LENGTH COMPLETE FUEL LINE ASSEMBLIES

^{3/8"}
FUEL LINE ASSEMBLY

18-8017S *SILVERADO 4000 Premium*

OE# 6YL-24306-60-00



*



18-8077-1
TANK
CONNECTOR
(SOLD SEPARATELY)



18-80415
FUEL
CONNECTOR

18-8005S
PRIMER
BULB

18-80415
FUEL
CONNECTOR



*

FUEL LINE ASSEMBLY COMPONENTS

Fits: F75-F250 and 115-300 HP

UNIVERSAL

8' LENGTH FUEL LINE ASSEMBLIES

^{5/16"}
FUEL LINE ASSEMBLY

18-8013S *SILVERADO 4000 Premium*



*



18-8004S
PRIMER
BULB

FUEL LINE ASSEMBLY COMPONENTS



*

8' LENGTH FUEL LINE ASSEMBLIES

^{3/8"}
FUEL LINE ASSEMBLY

18-8015S *SILVERADO 4000 Premium*



*



18-8005S
PRIMER
BULB

FUEL LINE ASSEMBLY COMPONENTS



*

12' LENGTH COMPLETE FUEL LINE ASSEMBLIES

^{5/16"}
FUEL LINE ASSEMBLY

18-8032S *SILVERADO 4000 Premium*



*



18-8004S
PRIMER
BULB

FUEL LINE ASSEMBLY COMPONENTS



*

* Tanks and Engines for picture purpose only.



18-7254
Replaces: Chrysler 3745414



18-7255
Replaces: Chrysler 3745415



18-7256
Replaces: Mercruiser 32722,
Crusader 32722



18-7258
Replaces: OMC 380986
GM 6414989



18-7260



18-7264
Replaces: Chrysler 2279913,
1736073



18-7265
Replaces: Chris-Craft
16.83-08758, FI8308762



18-7266
Replaces: Ford DJL 9350A



18-7267
Replaces:
Mercruiser 62092, 62092T
OMC 982063



18-7268
Replaces: OMC 981650
Volvo 3855276
Dual Diaphragm requires sight glass



18-7270
Replaces: Crusader 21140



18-7272
Replaces: Crusader 97039



18-7274
Replaces: Mercruiser 86246,
86246T, OMC 509409



18-7275
Replaces: Mercruiser 86247,
86247T, OMC 509410



18-7278
Replaces: Mercruiser 86234A4,
86234A05, OMC 985602,
985603, 982240, 509395



18-7281
Replaces: Volvo 826493



18-7282
Replaces: Mercruiser 42725A3,
OMC 509407



18-7283
Replaces: Mercruiser
97401A2, 97401A8, 861678A1,
OMC 509404

ALL SIERRA FUEL PUMPS INCLUDE MOUNTING GASKET



18-7284
Replaces: Mercruiser 41141A2, 862077A1, OMC 509408



18-7286
Replaces: Volvo 841161



18-7288-1
Replaces: Mercruiser 812454A1, 862048A1



18-7289
Replaces: OMC 982997



18-7326
ELECTRIC FUEL PUMP
Replaces: Mercruiser 805656A2
OMC/Volvo 3858261, 3850809, 3854620, 3857986



18-7330
ELECTRIC FUEL PUMP
Replaces: OMC/Volvo 3857650, 3855958, 988037, 3854280



18-7331
ELECTRIC FUEL PUMP
Replaces: OMC/Volvo 3858714, 3850810, 3857985



18-7332
ELECTRIC FUEL PUMP
Includes bracket and mounting hardware
43 GPH – 7 PSI Max. – 1/4 NPSF for 3/8 hose
– operates with both gasoline and diesel fuel - 24 Volt only



18-7333
ELECTRIC FUEL PUMP
UNIVERSAL
12V, 72GPH at 5.75 PSI, 1/4" NPSF for 3/8" hose, for use with gasoline and diesel fuel.

Year	Engine	Application	OE #	#'s Superseded from	Part #
Mercruiser					
1996	262/4.3L	Low Pressure Supply Pump For F.I. System	805656A2		18-7326
1996	262/4.3L	Carbureted w/electric pump - Low PSI	805656A2		18-7326
1992-93	262/4.3L	Carbureted w/electric pump - Low PSI	805656A2		18-7326
OMC					
1992-94	262/4.3L	Low Pressure	3858261	3850809,3850810,3857985	18-7326
1997-98	350/5.7L, 454/7.4L, & 502/8.2L	Engines w/MPI - High Pressure	3857650		18-7330
1996	454/7.4L & 502/8.2L	Engines w/MPI - High Pressure	3857650		18-7330
1993-94	4.3L thru 5.8L	Low pressure electric fuel pump	3858261	3850809	18-7326
1992-1994	454/7.4L & 502/8.2L	GM Mark V Eng. - Low Pressure	3858714	3850810, 3857985	18-7331
Volvo-Penta					
1994-99	262/4.3L (HU-WT)	High Pressure pump	3857650		18-7330
1994-99	262/4.3L GL/GS (All)	Carbureted - Low Pressure	3858261	3850809	18-7326
1994-99	262/4.3L GI (HU-WT)	W.Elec. Pump - Low Pressure	3858261	3850809	18-7326
1994-99	454/7.4L & 502/8.2L (HU-WT)	Low pressure system	3858714	3850810, 3857985	18-7331
1993-99	350/5.7L, 454/7.4L, & 502/8.2L	Engines w/MPI - High Pressure	3857650		18-7330
1996-99	454/7.4L & 502/8.2L (HU-WT)	Engines w/MPI - High Pressure	3857650		18-7330
1994-99	5.0L thru 5.8L	Low pressure electric fuel pump	3858261	3850809	18-7326
1994-99	454/7.4L & 502/8.2L (HU-WT)	GM Mark V Eng. - Low Pressure	3858714	3850810, 3857985	18-7331
1992-93	454/7.4L	GM Mark V Eng. - Low Pressure	3858714	3850810, 3857985	18-7331

ALL SIERRA FUEL PUMPS INCLUDE MOUNTING GASKET

Many fuel pumps are often used on similar engines. In order to identify the correct fuel pump for your application, it is necessary to determine the position of the inlet, outlet and separator fitting (where applicable) in relation to the rocker arm. The angle between the rocker arm and the fuel inlet is expressed in terms of clock position. Place pump with rocker arm in the 12 o'clock position. The rocker arm must be held behind the fuel pump body. (The bottom of the fuel pump body must face you.) Observe the relationship of the fuel inlet to the rocker arm. This position is the clock position of the pump. Examples of this in the outline drawing below show that if the fuel inlet is at position "A", it is considered a 6 o'clock pump, if at position "B". a 3 o'clock pump, and at position "C" an 8 o'clock pump.

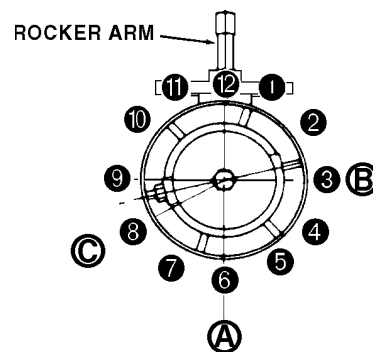

AC STYLE FUEL PUMPS

Engines Manufactured Before February 1, 1979

CLOCK POSITION

ENGINE	APPLICATION	FLANGE I.D.#	INLET	OUTLET	SEPARATOR	PART #
GM153,230,250,292, (4&6 cyl)	Crusader, Mercruiser,OMC	6790	8	4	—	18-7256
Hercules B,D,J,JXD, Series, M Series	Chris-Craft , US Marine, Owens Yacht	7241	6	9	—	—
GM225, PB-V215 (V-6)	OMC, Palmer	40001	8	4	—	18-7258
GM-V-8,283,307,327,350,409	Chris-Craft, Owens, Universal,Crusader	40155	9	3	10	18-7260
GM V-8 307,350	OMC	40778	4	10	9	—
Chrysler V-8 273,318,340,360	Chrysler	40781	4	8	—	18-7264

Engines Manufactured After January 31,1979

Chrysler V-8 318,360	Chrysler	6766	4	8	4	18-7254
Chrysler V-8 361,400,413,440	Chrysler	6767	4	8	4	18-7255
GM V-8 305,350,400	Mercruiser, OMC, Chris-Craft	41412	9	3	9	18-7265
Ford V-8 302,351	Ford, Mercruiser, Commander	41413	5	4	4	18-7266
Ford V-8 302	OMC, Mercruiser, Pleasurecraft, Thermo-Electron	41414	7	5	4	18-7267
GM V-8 305,307,350,400	Harman, OMC, Thermo-Electron (5.25-6.5 PSI)	41415	7	5	8	18-7268*
GM V-8 454	Mercruiser	41416	9	8	7	—
GM V-8 305,350,400	Thermo-Electron (5.75-7PSI)	41417	7	5	8	18-7270
GM V-8 454	Thermo-Electron	41418	3	9	8	18-7271
GM V-8 283,305,350,400	Chris-Craft,Crusader,Hardin, Thermo-Electron (5.75-6.5 PSI)	41419	3	9	8	18-7272
GM V-8 305,350,400	Mercruiser	41421	10	9	7	18-7274
GM V-8 454	Hawk, Mercruiser	41422	9	3	7	18-7275

*18-7268 – Dual Diaphragm requires sight glass

CARTER STYLE FUEL PUMPS

ENGINE	APPLICATION	FLANGE I.D. #	INLET	OUTLET	SIGHT TUBE CONNECTION	PART #
GM (4 & 6 cyl) 153,181,250,225	Chris-Craft, Indmar, Marine Power, Mercruiser, OMC	60032	8	4	3	18-7278
GM V-8 305,350	Volvo Penta	6973	9	11	9	18-7281
For Inline (4 cyl) 120, 140, 3.0L, 224 CID	Mercruiser	60337	8	3	8	18-7282
GM V-6 262/4.36	OMC	60201	2	4	9	18-7289
GM V-8 305,350	Mercruiser, Panther	60600	10	9	4	18-7283
GM V-6 231,262	Hardin, Mercruiser	60315	8	3	8	18-7284
XP Stamped Steel Pump	Volvo Penta AQ120B (spec# 867465), AQ125A/B, AQ131A/B/C/D, AQ140A (spec# 867464), BB140A, AQ145A, BB145A, AQ151A/B/C, AQ171A/C, AQ230A/B, AQ250A/B, AQ251A	60029	3	6	11	18-7286



18-7627
INTAKE MANIFOLD
Small-block GM with vortec cylinder heads

18-7628
INTAKE MANIFOLD
Small-block GM with vortec cylinder heads
Brass lined water jackets for salt water applications

ALL SIERRA CARBURETORS INCLUDE BASE GASKET

- Precision remanufactured to meet or exceed OEM specifications
- Re-calibrated and re-engineered to maximize fuel efficiency and performance
- All carburetors are flow tested throughout the entire throttle range
- Fuel mixture and idle settings are pre-set to ensure that only minor idle and choke adjustments are necessary during installation
- All bases are resurfaced and throttle shaft bushings replaced

UNIVERSAL CARBURETORS



18-7635
CARBURETOR
(REMANUFACTURED)
300 CFM Holley 2V



18-7636
CARBURETOR
(REMANUFACTURED)
500 CFM Holley 2V



18-7637
CARBURETOR
(REMANUFACTURED)
600 CFM Holley 4V



18-7638
CARBURETOR
(REMANUFACTURED)
600 CFM Holley 4V-side inlet



18-7640
CARBURETOR
(REMANUFACTURED)
Universal Q-jet with electric choke

MERCURISER CARBURETORS

**NEW CASTING
NON-REMANUFACTURED**



18-7373N
MERCARB 2V
CARBURETOR
Replaces:
Mercruiser 3310-864941A01
2002-2004 4.3L engines (s/n
OM615000-OW300012



18-7615N
Q-JET CARBURETOR
Replaces: 1347-816373A4,
1347-804624R1,
1347-804624R02



18-7603-1
CARBURETOR
(REMANUFACTURED)
2 Barrel - Rochester
Replaces: Mercruiser
1347-818622, 1376-5659A1,
1347-818622 1,
1347-818622R02,
Rochester 7044185



18-7604-1
CARBURETOR
(REMANUFACTURED)
4 Barrel - Rochester
Replaces: Mercruiser 3304-9354A2,
1347-804623R02



**18-7605-1
CARBURETOR
(REMANUFACTURED)**
4 Barrel - Rochester
Replaces: Mercruiser 1347-9661A3,
1347-804623A1, 1347-804623R02,
Rochester 17057283, 17057285,
17059291, 17059292, 17080564, 17080565



**18-7607-1
CARBURETOR
(REMANUFACTURED)**
Replaces: Rochester 17082403
For: Rochester Carb: Crusader 454



**18-7608-1
CARBURETOR
(REMANUFACTURED)**
2 Barrel - Rochester
Replaces: Mercruiser 1347-818620,
1347-818620 1, 1347-818620R02,
Rochester 7040080, 7040083, 7040089,
7042183, 7043183, 7043184, 17059057,
17059052



**18-7609-1
CARBURETOR
(REMANUFACTURED)**
2 Barrel - Rochester
Replaces: Mercruiser 1347-818619,
1347-818619 1, 1347-818619 1R02,
Rochester 7036543, 7040082, 7041369,
7043182, 7044182, 17059054



**18-7610-1
CARBURETOR
(REMANUFACTURED)**
2 Barrel - Rochester
Replaces: Mercruiser 1347-818621,
1347-818621 1, 1347-818621 1R02
Rochester 17081060



**18-7611-2
CARBURETOR
(REMANUFACTURED)**
2 Barrel - Rochester
Replaces: Mercruiser 3310-807312A1,
3310-807312R02



**18-7613-1
CARBURETOR
(REMANUFACTURED)**
4 Barrel - Carter (Weber)
Replaces: Mercruiser
3310-806969A1, 3310-806969R01

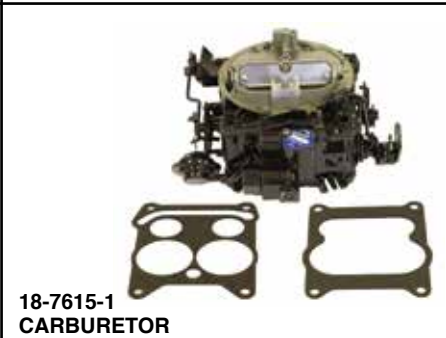

**18-7615-1
CARBURETOR
(REMANUFACTURED)**
4 Barrel - Rochester
Replaces: Mercruiser 1347-816373A4,
1347-804624R1, 1347-804624R02,
Rochester 17057298, 17059280,
17059288, 17080561, 17085013



**18-7616-1
CARBURETOR
(REMANUFACTURED)**
4 Barrel - Rochester
Replaces: Mercruiser 1347-8288A1,
1347-804626R02, Rochester 1708563,
17057287, 17059287, 17059290, 17080560



**18-7639
CARBURETOR
(REMANUFACTURED)**
Replaces: 3310-864943A01
Mercarb-5.7L 2V 1998 and newer 5.7L
(OL010337-OW300754) & 5.7L MIE
(OL002003-OW090899)



**18-7617-1
CARBURETOR
(REMANUFACTURED)**
4 Barrel - Rochester
Replaces: Mercruiser 1347-
9863A3, 1347-804625R1,
1347-804625R02
Rochester 17059280



**18-7618-1
CARBURETOR
(REMANUFACTURED)**
4 Barrel - Rochester
Replaces: Mercruiser 1347-
8289A1, 1347-804624R1,
1347-804624R02,
Rochester 17059289,
7044291, 17080561,
17080562



**18-7619-1
CARBURETOR
(REMANUFACTURED)**
4 Barrel - Rochester
Replaces: Mercruiser
1347-9142A2, 1347-8460 A3,
Rochester 17081299, 17083522,
17059283, 17059298

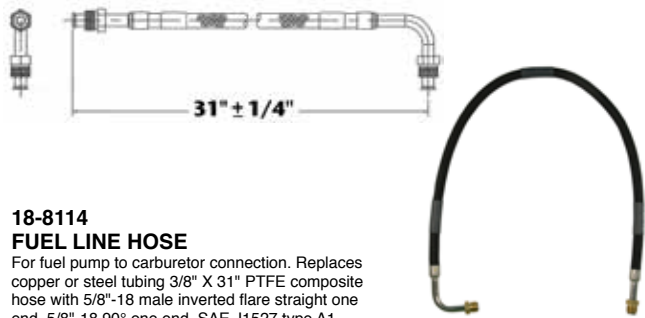

18-8114 FUEL LINE HOSE
 For fuel pump to carburetor connection. Replaces copper or steel tubing 3/8" X 31" PTFE composite hose with 5/8"-18 male inverted flare straight one end, 5/8"-18 90° one end. SAE J1527 type A1

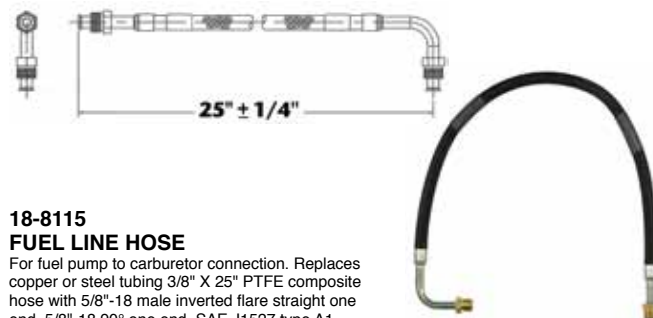

18-8115 FUEL LINE HOSE
 For fuel pump to carburetor connection. Replaces copper or steel tubing 3/8" X 25" PTFE composite hose with 5/8"-18 male inverted flare straight one end, 5/8"-18 90° one end. SAE J1527 type A1

MERCURUISER CARBURETOR APPLICATION

Model	Year	# of Cyl.	Beginning Serial #	Ending Serial #	Original Carb. #	Replacement Carb. #	Mfg. Carb.	Carb Code & Model	Carb #
90	1970-1971	L4	2851424	3225967	1351-4263A1	1347-818619 1	7040082	R2/2GC	18-7609-1
90	1972	L4	3225868	3226957	1351-4263A2	1347-818619 1	7041369	R2/2GC	18-7609-1
110	1963-1966	L4	1357370	2044033	1336-2076	—	7036543	R2/2GC	18-7609-1
120	1972-1973	L4	3377341	3770649	1351-4263A3	1347-818619 1	7041369	R2/2GC	18-7609-1
120	1974-1975	L4	3770650	4469865	1351-5202A1	1347-818619 1	7043182	R2/2GC	18-7609-1
120	1976-1978	L4	4469866	5192048	1351-6065A2	1347-818619 1	7044182	R2/2GC	18-7609-1
120	1979-1982	L4	5192049	6229717	1351-7354A1	1347-818619 1	17059054	R2/2GC	18-7609-1
120/2.5L	1983-1989	L4	6229718	OC853255	1351-8480A2	1348-818621 1	17081060	R2/2GC	18-7610-1
140	1970	L4	2816417	2911439	1351-4032A1	1347-818620 1	7040080	R2/2GC	18-7608-1
140	1970-1973	L4	2911440	3771644	1351-4293A1	1347-818620 1	7040084	R2/2GC	18-7608-1
140	1974-1978	L4	3771645	5157668	1351-5203A1	1347-818620 1	7043184	R2/2GC	18-7608-1
140	1979-1982	L4	5157669	6229717	1351-7355A1	1347-818620 1	17059052	R2/2GC	18-7608-1
140/3.0L	1983-1989	L4	6229718	OC856556	1351-8480A2	1348-818621 1	17081060	R2/2GC	18-7610-1
165 (6 Cyl)	1970-1972	L6	2770032	3354791	1351-4282A1	1347-818620 1	7040083	R2/2GC	18-7608-1
165 (6 Cyl)	1972-1973	L6	3354702	3774864	1351-4871A1	1347-818620 1	7042183	R2/2GC	18-7608-1
165 (6 Cyl)	1974-1978	L6	3774865	5178958	1351-5204A1	1347-818620 1	7043183	R2/2GC	18-7608-1
488	—	—	6170297	1347-8460 6916778	1347-9142A2	—	17059283 17059298 17083522 17081299	R4/4ME	18-7619-1
165 (6 Cyl)	1979-1981	L6	5178959	5813433	1351-7356A1	1347-818620 1	17059050	R2/2GC	18-7608-1
180/1903.7LX	—	—	6916779	Later	1347-8460 1347-9142A2	—	17059283 17059298 17083522 17081299 17083522	R4/4ME R4/4ME	18-7619-1
205/4.3LX	1985-1991	V-6	OA331455	OD714369	3304-9354A2	3304-9354A2	N/A	R4/4MV	18-7604-1
898/200/5.0L	1987-95	V-8	OB525982	OF600999	1389-9670A2	3310-807312A1	N/A	M2/MERCARB	18-7611-2
888	1971-1977	V-8	3108723	4887829	1376-5659A1	1376-818622 1	7044185	R2/2GC	18-7603-1
228	1977-1978	V-8	4765100	5069430	1347-6427A1	1347-9661A3	17057282	R4/4MV	18-7605-1
228 TR & MIE	1977-1978	V-8	4765100	5069430	1347-6438A1	1347-9661A3	17057283	R4/4MV	18-7605-1
228	1978-1981	V-8	5069431	6021783	1347-7361A1	1347-9661A3	17059292	R4/4MV	18-7605-1
228	1982	V-8	6021784	6218461	1347-8296A4	1347-9661A3	17080565	R4/4MV	18-7605-1
223/230/5.0LX	1983-1995	V-8	6218462	OF600999	1347-9661A3	1347-9661A3	17080565	R4/4MV	18-7605-1
228 MIE	1978-1982	V-8	5069431	6040745	1347-7364A1	1347-9661A3	17059291	R4/4MV	18-7605-1
230 MIE	1982-1987	V-8	6040746	OB788151	1347-8290A1	1347-9661A3	17080564	R4/4MV	18-7605-1
255 MIE (GM)	1975-1978	V-8	4175500	4924564	1347-5732A1	1347-8289A1	7044291	R4/4MV	18-7618-1
255 MIE (GM)	1978	V-8	4924565	5195908	1347-7062A1	1347-8289A1	17059289	R4/4MV	18-7618-1
255 MIE (GM)	1979-1980	V-8	5195909	5907057	1347-7365A1	1347-8289A1	17059289	R4/4MV	18-7618-1
260 MIE	1980-1986	V-8	5907058	OB522505	1347-8289A1	1347-8289A1	17080562	R4/4MV	18-7618-1
260/5.7MIE	1987-1993	V-8	OB522506	OF024999	1347-966A4	1347-816373A4	17080561	R4/4MV	18-7615-1
255	1975-1976	V-8	41745500	4767999	1347-5732A1	1347-8289A1	7044291	R4/4MV	18-7618-1
260	1978	V-8	4908850	5060805	1347-6492A1	1347-816373A4	17057298	R4/4MV	18-7615-1
260	1978-1982	V-8	5060806	6024393	1347-7362A1	1347-816373A4	17059288	R4/4MV	18-7615-1
260	1982-1986	V-8	6024393	OB525981	1347-8292A4	1347-816373A4	17080561	R4/4MV	18-7615-1
260/5.7L ALPHA	1987-1993	V-8	OB525982	OF000454	1347-9662A4	1347-816373A4	17080561	R4/4MV	18-7615-1
5.7L (2BBL)	1996-1997	V-8	OF601000	OK999999	3310-807312A1	3310-807312A1	—	M2/MERCARB	18-7611-1
5.7L (Gen II)	1998-2004	V-8	OL010037	OW300754	3310-864943101	3310-864943101	N/A	M2/MERCARB	18-7639
5.7L BRAVO (w/o High Rise Intake)	1987-1991	V-8	OB525982	OD617327	1347-9662A4	1347-816373A4	17080561	R4/4MV	18-7615-1
5.7L BRAVO (w/ High Rise Intake)	1987-1991	V-8	OB525982	OD617327	1347-8289A1	1347-8289A1	17080562	R4/4MV	18-7618-1
350 MAGNUM ALPHA	1986-1991	V-8	OA635178	OD617327	1347-8289A1	1347-8289A1	17080562	R4/4MV	18-7618-1
5.7L SKI	1985-1993	V-8	OA338533	OF025099	1347-9415T	1347-9415T	17085013	R4/4MV	18-7615-1
5.7L SKI (2BBL)	1996-1997	V-8	OF775200	OK999999	3310-807312A1	3310-807312A1	—	M2/MERCARB	18-7611-2
300MR/TRS	1985-1986	V-8	6668677	OB430367	1347-7498A7	1347-7498A7	17059280	R4/4MV	18-7615-1
330 MCM	1977-1978	V-8	4623115	5027230	1347-6493A1	1347-8291A3	17057287	R4/4MV	18-7616-1
330 MCM	1977-1981	V-8	5027231	6083144	1347-7363A1	1347-8291A3	17059290	R4/4MV	18-7616-1
330 MCM	1982-1987	V-8	6083145	OB816540	1347-8291A3	1347-8291A3	1708563	R4/4MV	18-7616-1
330 MIE	1977-1978	V-8	4623115	5226384	1347-6493A1	1347-8288A1	17057287	R4/4MV	18-7616-1
330 MIE	1979-1980	V-8	5226385	5889913	1347-7366A1	1347-8288A1	17059287	R4/4MV	18-7616-1
340/7.4L MIE	1981-1992	V-8	5889914	OD715493	1347-8288A1	1347-8288A1	17080560	R4/4MV	18-7616-1
7.4L MIE	1995-1997	V-8	OF350000	OK999999	3310-806969A1	3310-806969A1	9780	WEBER	18-7613-1
7.4L BRAVO I/II	1988-1991	V-8	OB771113	OD603117	1347-8291A3	1347-8291A3	17080563	R4/4MV	18-7616-1
7.4L BRAVO I/II	1995-1997	V-8	OF352000	OK999999	3310-806969A1	3310-806969A1	9780	WEBER	18-7613-1
7.4L BRAVO III	1996-1997	V-8	OF800700	OK999999	3310-806969A1	3310-806969A1	9780	WEBER	18-7613-1
370/400	1978-1987	V-8	4179554	OB714586	1347-7498A2	1347-9863A3	17059280	R4/4MV	18-7617-1
454 MAG ALPHA	1986-1988	V-8	OA631894	OB785148	1347-8291A3	1347-8291A3	17080563	R4/4MV	18-7616-1
454 MAG BRAVO	1988-1992	V-8	OB721206	OD808068	1347-7498A2	1347-9863A3	17059280	R4/4MV	18-7617-1

ALL SIERRA CARBURETORS INCLUDE BASE GASKET

**NEW CASTING
NON-REMANUFACTURED**



**18-7615N
Q-JET CARBURETOR**
Replaces: 1347-816373A4,
1347-804624R1,
1347-804624R02



**18-7608-1
CARBURETOR
(REMANUFACTURED)**
2 Barrel Rochester
Replaces: OMC 381668, 980528,
982219, 982217



**18-7609-1
CARBURETOR
(REMANUFACTURED)**
2 Barrel Rochester
Replaces: OMC 382733, 980530,
982217, 984180, 381494, 772831



**18-7615-1
CARBURETOR
(REMANUFACTURED)**
4 Barrel Rochester
Replaces: OMC 981705, 982223, 983855,
981359, 981564, 985822, 981803, 981428



**18-7605-1
CARBURETOR
(REMANUFACTURED)**
4 Barrel Rochester
Replaces: OMC 382821, 383766, 384194



**18-7619-1
CARBURETOR
(REMANUFACTURED)**
For V-8, 305 & 350 CID
Models: AQ225B, C, D, E, F, 225 A,B,
BB225 A, AV, B, C, 290 A, AQ260A, B,
260 A, AV, B, C, 501 A/M S4A, 570 M S4A

OMC STERN DRIVE CARBURETOR APPLICATION

Model	Year	OMC Carburetor #	MFG Carburetor #	Carb Code & Model	Part #
80	1968-69	382733, 772831	7028085, 17059053, 17086064, 17087311	R2, 2GC	18-7609-1
90	1970-71	382733, 772831	7028085, 17059053, 17086064, 17087311	R2, 2GC	18-7609-1
120 (400 Series)	1972-86	381668, 980528, 982219	7044186, 17059056	R2, 2GC	18-7608-1
140 (400 Series)	1973-85	979821, 980530, 982217, 984180	17086107	R2, 2GC	18-7608-1
155	1967-72	772831	7026180	R2, 2GC	18-7609-1
165	1972-76	979821, 980530	17086107	R2, 2GC	18-7609-1
185	1989	984180	17086064	R2, 2GC	18-7609-1
200	1966-68	381494	7025187	R2, 2GC	18-7609-1
210	1968-72	382821, 383766	7028282, 7028280	R4, 4MV	18-7605-1
215, 225, 230	1971-76	382821	7028280	R4, 4MV	18-7605-1
230 (800 Series)	1979-89	981705, 982223	17057290, 17059285, 17059286, 17086117	R4, 4MV	18-7615-1
245	1972-75	384194	7040284	R4, 4MV	18-7605-1
250	1970-74	384194	7040284	R4, 4MV	18-7605-1
260 (800 Series)	1975-76	384194	7040284	R4, 4MV	18-7605-1
260 (800 Series)	1979-89	982223	17057290, 17059285, 17059286, 17086117	R4, 4MV	18-7615-1
2.5L, 3.0L	1982-86	982219, 982217	17059056, 17059053	R2, 2GC	18-7608-1
3.0L	1987-90	984180	17086064	R2, 2GC	18-7608-1
3.8L (4V)	1979-85	983855	17082515, 17085010	R4, 4MV	18-7615-1
4.3L (4V)	1979-89	983855	17082515, 17085010	R4, 4MV	18-7615-1
5.0L (GM)(4V)	1979-89	982223	17057290, 17059285, 17059286, 17086117	R4, 4MV	18-7615-1
5.7L (4V)	1979-89	982223	17057290, 17059285, 17059286, 17086117	R4, 4MV	18-7615-1
305, 350 CI, I/B	1977-83	981359, 982215, 981564, 982223	17057290, 17059285, 17059286, 17086117	R4, 4MV	18-7615-1
350 (4V)	1988-89	985822	17057290, 17059285, 17059286, 17086117	R4, 4MV	18-7615-1
454 CI, I/B	1977-78	981803, 981428	17057290, 17059285, 17059286, 17086117	R4, 4MV	18-7615-1

**18-7039
CARB KIT**
Contains adjustable needles & seats



**18-7095
CARB KIT**



CARBURETOR TO CARBURETOR KIT INTERCHANGE

Carburetor #	Carb. Kit #	Float #	Carburetor #	Carb. Kit #	Float #	Carburetor #	Carb. Kit #	Float #
INBOARD			CARTER/WEBER (Cont.)			HOLLEY (Cont.)		
CARTER/WEBER								
2617	18-7725	—	9662	18-7748	—	R-6407A	18-7096	18-7206
2618	18-7725	—	9663	18-7748	—	R-6647A	18-7728	—
2669	18-7025	—	9665	18-7748	—	R-6647AAA	18-7728	—
2853	18-7022	18-7201	9666	18-7748	—	R-6576A	18-7096	18-7206
2911	18-7725	—	9772	18-7748	—	R-7036A	18-7081	18-7206
2912	18-7725	—	9773	18-7748	—	R-7128A	18-7017	—
2935	18-7725	—	9774	18-7748	—	R-7159A	18-7017	—
2955	18-7022	—	9776	18-7748	—	R-7163A	18-7017	—
3035	18-7725	—	9776	18-7748	—	R-9392A	18-7096	—
3041	18-7022	18-7201	9777	18-7748	—	R-9393A	18-7729	—
3116	18-7022	18-7201	9780	18-7748	—	R-9394A	18-7729	—
3117	18-7725	—	9782	18-7748	—	R-50399A	18-7729	—
3157	18-7725	—	9665S	18-7748	—	R-50399-1A	18-7729	—
3195	18-7725	—	9772SA	18-7748	—	R-50405A	18-7729	—
3204	18-7022	18-7201	9776S	18-7748	—	R-50405-1A	18-7729	—
3205	18-7025	—	9776SA	18-7748	—	R-50417A	18-7236	—
3212	18-7726	—	9776SB	18-7748	—	R-50417-1A	18-7236	—
3213	18-7091	—	9779S	18-7748	—	R-50418A	18-7729	—
3214	18-7091	—	9780S	18-7748	—	R-50419A	18-7729	—
3285	18-7022	18-7201	FORD			R-50419-1A	18-7237	—
3314	18-7022	18-7201	C9FF-9510-D	18-7096	18-7206	R-50419-2A	18-7237	—
3354	18-7022	18-7201	C9FF-9510-E	18-7096	18-7206	R-50461A	18-7236	—
3355	18-7725	—	D1FF-9510-LA	18-7081	18-7206	R-50461-1A	18-7236	—
3389	18-7725	—	D1FF-9510-MA	18-7096	18-7206	R-50462A	18-7729	—
3390	18-7725	—	D1FF-9510-NA	18-7096	18-7206	R-50462-1A	18-7729	—
3392	18-7091	—	D1JJ-9510-B	18-7081	18-7206	R-50463A	18-7237	—
3543	18-7091	—	D2JL-9510-C	18-7096	18-7206	R-50463-1A	18-7237	—
3660	18-7022	—	D2JL-9510-E	18-7096	18-7206	R-50464A	18-7017	—
3887	18-7022	18-7201	D3JL-9510-S	18-7081	18-7206	R-50467A	18-7236	—
3951	18-7080	—	D4JL-9510-F	18-7017	—	R-50467-1A	18-7236	—
3971	18-7080	—	D4JL-9510-G	18-7017	—	R-50468A	18-7729	—
3979	18-7726	—	D4JL-9510-J	18-7017	—	R-50468-1A	18-7729	—
3980	18-7089	—	E0JL-9510-CA	18-7096	—	R-50469A	18-7245	—
3981	18-7726	—	E8JL-9510-DA	18-7017	—	R-50469-1A	18-7245	—
4157	18-7022	18-7201	E9JL-DA	18-7017	—	R-50470A	18-7017	—
4207	18-7080	—	F1JL-AA	18-7236	—	R-50483A	18-7727	—
4208	18-7080	—	F1JL-EA	18-7727	—	R-80262A	18-7729	—
4268	18-7726	—	F1JL-BA	18-7729	—	R-80263A	18-7236	—
4394	18-7080	—	F1JL-CA	18-7245	—	R-80264A	18-7729	—
4476	18-7091	—	F1JL-EA	18-7727	—	R-80265A	18-7237	—
4695	18-7023	—	HOLLEY			R-80311A	18-7241	—
4699	18-7089	—	R-4397A	18-7096	—	R-80311-1A	18-7241	—
6117	18-7023	—	R-4473A	18-7096	18-7206	R-80311-2A	18-7241	—
6130	18-7089	—	R-4473AAS	18-7096	18-7206	R-80312A	18-7238	—
6212	18-7089	—	R-4607A	18-7096	18-7206	R-80312-1A	18-7238	—
6310	18-7022	—	R-4608A	18-7096	18-7206	R-80313A	18-7246	—
6446	18-7092	—	R-4608AAS	18-7096	18-7206	R-80313-1A	18-7246	—
9263	18-7091	—	R-6150A	18-7081	18-7206	R-80315A	18-7237	—
9264	18-7091	—	R-6151A	18-7096	18-7206	R-80315-1A	18-7237	—
9661	18-7749	—	R-6151AAA	18-7096	18-7206	R-80316A	18-7246	—
9770	18-7749	—	R-6152A	18-7096	18-7206	R-80316-1A	18-7246	—
9781	18-7749	—	R-6152AAA	18-7096	18-7206	R-80318A	18-7017	—
9770SA	18-7749	—	R-6317A	18-7081	18-7206	R-80318-1A	18-7017	—
9781S	18-7749	—	R-6317-1A	18-7081	18-7206	R-80319A	18-7245	—
9600	18-7748	—				R-80319-1A	18-7245	—

CARBURETOR TO CARBURETOR KIT INTERCHANGE (Cont.)

Carburetor #	Carb. Kit #	Float #	Carburetor #	Carb. Kit #	Float #	Carburetor #	Carb. Kit #	Float #
HOLLEY (Cont.)			MERCURY MARINE (Cont.)			ROCHESTER (Cont.)		
R-80320A	18-7236	—	1347-6438A1	18-7072	18-7201	17057132	18-7076	18-7202
R-80320-1A	18-7236	—	1347-6492A1	18-7072	18-7201	17057133	18-7086	18-7202
R-80321A	18-7246	—	1347-6493A1	18-7072	18-7201	17057134	18-7086	18-7202
R-80321-1A	18-7246	—	1347-7062A1	18-7072	18-7201	17057138	18-7086	18-7202
R-80328A	18-7239	—	1347-7361A1	18-7095	18-7201	17057139	—	18-7202
R-80328-1A	18-7239	—	1347-7362A1	18-7095	18-7201	17057282	18-7072	18-7201
R-80328-2A	18-7239	—	1347-7363A1	18-7095	18-7201	17057283	18-7072	18-7201
R-80330A	18-7241	—	1347-7364A1	18-7095	18-7201	17057287	18-7072	18-7201
R-80330-1A	18-7241	—	1347-7365A1	18-7095	18-7201	17057290	18-7095	18-7201
R-80378A	18-7242	—	1347-7366A1	18-7095	18-7201	17057292	18-7072	18-7201
R-80378-1A	18-7242	—	1347-7498A2	18-7095	18-7201	17057295	18-7072	18-7201
R-80382A	18-7244	—	1347-7498A7	18-7095	18-7201	17057298	18-7072	18-7201
R-80382-1A	18-7244	—	1347-8288A1	18-7095	18-7201	17057299	18-7072	18-7201
R-80383A	18-7245	—	1347-8289A1	18-7095	18-7201	17058280	18-7072	18-7201
R-80383-1A	18-7245	—	1347-8290A1	18-7095	18-7201	17059050	18-7070	18-7200
R-80385A	18-7246	—	1347-8291A3	18-7095	18-7201	17059051	18-7086	18-7200
R-80386A	18-7244	—	1347-8292A4	18-7095	18-7201	17059052	18-7070	18-7200
R-80386-1A	18-7244	—	1347-8296A4	18-7095	18-7201	17059053	18-7070	18-7200
R-80390A	18-7243	—	1347-8460A3	18-7077	18-7201	17059054	18-7070	18-7200
R-80364	18-7729	—	1347-9142A2	18-7095	18-7201	17059055	—	18-7200
R-80434	18-7730	—	1347-9415T	18-7095	18-7201	17059056	—	18-7200
R-80444A	18-7241	—	1347-9661A3	18-7095	18-7201	17059057	18-7086	18-7200
R-84018AA	18-7039	—	1347-9662A4	18-7095	18-7201	17059058	18-7086	18-7200
R-84022AA	18-7040	—	1347-9863A3	18-7095	18-7201	17059059	18-7086	18-7202
R-84023AA	18-7039	—	1351-3635A1	18-7070	18-7200	17059060	18-7086	18-7200
R-84024AA	18-7040	—	1351-4032A1	18-7070	18-7200	17059280	18-7095	18-7201
R-84026AA	18-7040	—	1351-4263A1	18-7070	18-7200	17059283	18-7095	18-7201
R-84026-1AA	18-7040	—	1351-4263A2	18-7070	18-7200	17059285	18-7095	18-7201
R-84026-2AA	18-7040	—	1351-4263A3	18-7070	18-7200	17059286	18-7095	18-7201
R-84028AA	18-7039	—	1351-4282A1	18-7070	18-7200	17059287	18-7095	18-7201
R-84037AA	18-7040	—	1351-4293A1	18-7070	18-7200	17059287	18-7095	18-7201
R-84038AA	18-7039	—	1351-4293A1	18-7070	18-7200	17059288	18-7095	18-7201
R-84039AA	18-7039	—	1351-4871A1	18-7070	18-7200	17059289	18-7095	18-7201
R-84040AA	18-7040	—	1351-5202A1	18-7070	18-7200	17059290	18-7095	18-7201
R-84041AA	18-7070	—	1351-5203A1	18-7070	18-7200	17059291	18-7095	18-7201
R-84042AA	18-7040	—	1351-5204A1	18-7070	18-7200	17059292	18-7095	18-7201
R-84044AA	18-7039	—	1351-6065A2	18-7070	18-7200	17059293	18-7095	18-7201
R-84044-1AA	18-7039	—	1351-7354A1	18-7070	18-7200	17059294	18-7095	18-7201
R-84046A	18-7727	—	1351-7355A1	18-7070	18-7200	17059295	18-7095	18-7201
R-84046AA	18-7039	—	1351-7356A1	18-7070	18-7200	17059295	18-7095	18-7201
			1351-8480A2	18-7070	18-7200	17059296	18-7095	18-7201
			1356-4066	18-7096	18-7206	17059298	18-7095	18-7201
			1356-4642	18-7081	18-7206	17065977	18-7072	18-7201
			1356-5155	18-7096	18-7206	17080050	18-7086	18-7200
			1356-5169	18-7096	18-7206	17080350	—	18-7202
			1376-5659A1	18-7075	18-7202	17080560	18-7095	18-7201
			1376-5659A2	18-7075	18-7202	17080561	18-7095	18-7201
			1376-5744A1	18-7075	18-7202	17080562	18-7095	18-7201
			1376-5990A1	18-7076	18-7202	17080563	18-7095	18-7201
			1376-6152A1	18-7075	18-7202	17080564	18-7095	18-7201
			1376-6491A1	—	18-7202	17080565	18-7095	18-7201
			1376-8295A3	—	18-7202	17081060	18-7070	18-7200
			1389-815396A2	18-7098-1	18-7202	17081299	18-7077	18-7201
			1389-815397A2	18-7098-1	18-7202	17082403	18-7095	18-7201
			1389-8488A2	18-7097	18-7202	17083110	18-7086	18-7200
			1389-8489A5	18-7097	18-7202	17083515	18-7095	18-7201
			1389-8490A2	18-7097	18-7202	17083522	18-7095	18-7201
			1389-9562A1	18-7098-1	18-7202	17084001	18-7095	18-7201
			1389-9563A1	18-7098-1	18-7202	17084516	18-7095	18-7201
			1389-9564A1	18-7098-1	18-7202	17085008	18-7086	18-7200
			1389-9670A2	18-7098-1	18-7202	17085010	18-7072	18-7201
			3300-8886A2	18-7095	18-7201	17085013	18-7095	18-7201
			3304-9353A2	18-7097	18-7202	17086064	18-7070	18-7200
			3304-9354A2	18-7095	18-7201	17086069	18-7095	18-7201
			3304-9565A1	18-7098-1	18-7202	17086107	18-7086	18-7200
						17086115	18-7095	18-7201
						17086116	18-7095	18-7201
						17086117	18-7095	18-7201
						17087311	18-7070	18-7200
						17087311	18-7095	18-7201
						17057131	18-7086	18-7202
						7013071	18-7019	—

CARBURETOR TO CARBURETOR KIT INTERCHANGE (Cont.)

Carburetor #	Carb. Kit #	Float #	Carburetor #	Carb. Kit #	Float #	Carburetor #	Carb. Kit #	Float #
ROCHESTER (Cont.)			ROCHESTER (Cont.)			OUTBOARD		
7015087	—	18-7200	7040284	18-7072	18-7201	Carburetor #	Carb. Kit #	Needle & Seat #
7015088	—	18-7200	7041187	—	18-7200	TILLOTSON		
7015089	—	18-7200	7041280	18-7072	18-7201	AJ-50A	18-7013	18-7057
7015090	18-7019	—	7041285	18-7072	18-7201	AJ-52A	18-7013	18-7057
7015091	18-7019	—	7041369	18-7070	18-7200	AJ-53A	18-7013	18-7057
7015097	—	18-7200	7041831	18-7072	18-7201	AJ-53AT	18-7013	18-7057
7015098	—	18-7200	7042181	—	18-7200	AJ-54A	18-7013	18-7057
7019082	18-7070	18-7200	7042183	18-7070	18-7200	AJ-54AT	18-7013	18-7057
7019084	18-7019	—	7043182	18-7070	18-7200	AJ-55AO	18-7013	18-7057
7020082	—	18-7200	7043183	18-7070	18-7200	AJ-55AT	18-7013	18-7057
7020084	18-7019	—	7043184	18-7070	18-7200	AJ-56A	18-7013	18-7057
7020085	18-7019	—	7043259	—	18-7201	AJ-56AB	18-7013	18-7057
7020087	18-7078	—	7043282	—	18-7201	AJ-57A	18-7013	18-7057
7020088	18-7070	18-7200	7044182	18-7070	18-7200	CO-10A	18-7037	18-7057
7020991	18-7078	—	7044185	18-7075	18-7202	CO-10B	18-7037	18-7057
7020992	18-7070	18-7200	7044186	—	18-7200	CO-11A	18-7037	18-7057
7020993	18-7070	18-7200	7044187	18-7075	18-7202	CO-1A	18-7037	18-7057
7020994	18-7071	—	7044283	18-7072	18-7201	CO-2A	18-7037	18-7057
7020995	18-7078	—	7044284	18-7072	18-7201	CO-3A	18-7037	18-7057
7020996	18-7071	—	7044286	18-7072	18-7201	CO-4A	18-7037	18-7057
7023080	—	18-7200	7044287	18-7072	18-7201	CO-4B	18-7037	18-7057
7023084	18-7078	—	7044288	18-7072	18-7201	CO-4C	18-7037	18-7057
7023085	18-7078	—	7044289	18-7072	18-7201	CO-4D	18-7037	18-7057
7023088	18-7078	—	7044290	18-7072	18-7201	CO-5A	18-7037	18-7057
7023089	18-7078	—	7044291	18-7072	18-7201	CO-6A	18-7037	18-7057
7023181	18-7078	—	7045197	18-7076	18-7202	CO-6B	18-7037	18-7057
7023183	18-7078	—	7045282	—	18-7201	CO-6C	18-7037	18-7057
7023186	—	18-7200	7045283	18-7072	18-7201	CO-7A	18-7037	18-7057
7023188	—	18-7200	SOLEX			CO-7B	18-7037	18-7057
7024083	18-7071	—	44PA1	18-7000	—	CO-7C	18-7037	18-7057
7024084	18-7078	—	44PHN-3	18-7001	—	CO-8A	18-7037	18-7057
7024086	18-7078	—	VOLVO-PENTA			CO-9A	18-7037	18-7057
7024087	18-7071	—	826359-2	18-7095	18-7201	KA-10A	18-7013	18-7057
7024089	18-7071	—	826414-5	18-7086	18-7202	KA-10AT	18-7013	18-7057
7024180	18-7071	—	826415-2	18-7095	18-7201	KA-11A	18-7013	18-7057
7024181	18-7071	—	826442-6	18-7095	18-7201	KA-11AT	18-7013	18-7057
7024182	18-7078	—	835556-2	18-7095	18-7201	KA-12A	18-7013	18-7057
7024188	—	18-7200	841667-9	18-7086	18-7202	KA-12AT	18-7013	18-7057
7025082	18-7070	18-7200	856138-3	18-7072	18-7201	KA-13A	18-7013	18-7057
7025180	18-7078	—	856236-5	18-7040	—	KA-13AT	18-7013	18-7057
7025183	18-7071	—	841047-4	18-7095	18-7201	KA-14A	18-7013	18-7057
7025184	18-7071	—	841048-2	18-7086	18-7202	KA-14AT	18-7013	18-7057
7025188	18-7070	18-7200	841313-0	18-7095	18-7202	KA-15A	18-7013	18-7057
7025564	18-7078	—	M875398-0	18-7085	—	KA-16A	18-7013	18-7057
7025638	18-7071	—	ZENITH			KA-16AT	18-7013	18-7057
7025662	18-7071	—	34VN	18-7008	—	KA-17A	18-7013	18-7057
7025756	18-7078	—	8963, A-J	18-7732	—	KA-17AT	18-7013	18-7057
7026084	18-7070	—	8983, A-H	18-7732	—	KA-18A	18-7013	18-7057
7026088	18-7070	18-7200	12091, A	18-7732	—	KA-18AT	18-7013	18-7057
7027080	18-7072	18-7201	12206	18-7732	—	KA-19A	18-7013	18-7057
7027081	18-7072	18-7201	ZENITH-STROMBERG			KA-19AT	18-7013	18-7057
7027083	18-7072	18-7201	C1865F	18-7085	—	KA-20A	18-7013	18-7057
7027088	18-7072	18-7201	C1865R	18-7085	—	KA-21A	18-7013	18-7057
7028085	18-7070	18-7200	C3040F	18-7085	—	KA-21AT	18-7013	18-7057
7028086	18-7070	18-7200	C3040R	18-7085	—	KA-21B	18-7013	18-7057
7028188	18-7070	18-7200	C3098F	18-7085	—	KA-21BT	18-7013	18-7057
7028280	18-7072	18-7201	C3098R	18-7085	—	KA-21C	18-7013	18-7057
7028282	18-7072	18-7201	C3200F	18-7085	—	KA-21CT	18-7013	18-7057
7029280	18-7072	18-7201	C3200R	18-7085	—	KA-21D	18-7013	18-7057
7029285	18-7072	18-7201	C3201F	18-7085	—	KA-21DT	18-7013	18-7057
7036543	18-7070	18-7200	C3201M	18-7085	—	KA-22A	18-7013	18-7057
7036646	18-7070	18-7200	C3201R	18-7085	—	KA-22B	18-7013	18-7057
7037082	18-7072	18-7201	C3231F	18-7085	—	KA-22C	18-7013	18-7057
7040080	18-7070	18-7200	C3231R	18-7085	—	KA-23A	18-7013	18-7057
7040080	18-7070	18-7200	C3232F	18-7085	—	KA-24A	18-7013	18-7057
7040081	18-7070	18-7200	C3232M	18-7085	—	KA-24AT	18-7013	18-7057
7040082	18-7070	18-7202	C3232R	18-7085	—	KA-25A	18-7013	18-7057
7040083	18-7070	18-7200				KA-26A	18-7013	18-7057
7040084	18-7070	18-7200						
7040283	18-7072	18-7201						

CARBURETOR TO CARBURETOR KIT INTERCHANGE (Cont.)

Carburetor #	Carb. Kit #	Float #	Carburetor #	Carb. Kit #	Float #	Carburetor #	Carb. Kit #	Needle & Seat #
TILLOTSON(Cont.)			TILLOTSON(Cont.)			TILLOTSON(Cont.)		
KA-26B	18-7013	18-7057	KD-6BT	18-7013	18-7057	WB-8A	18-7037	18-7057
KA-27A	18-7013	18-7057	KD-7A	18-7013	18-7057	WB-8B	18-7037	18-7057
KA-2A	18-7013	18-7057	KD-7B	18-7013	18-7057	WB-8C	18-7037	18-7057
KA-2AT	18-7013	18-7057	RD-10A	18-7037	18-7057	WB-8D	18-7037	18-7057
KA-5A	18-7013	18-7057	TC-1A	18-7037	18-7057	WB-9A	18-7037	18-7057
KA-5A	18-7013	18-7057	TC-1B	18-7037	18-7057	WB-9B	18-7037	18-7057
KA-7A	18-7013	18-7057	WB-10A	18-7037	18-7057	WB-9C	18-7037	18-7057
KA-7B	18-7013	18-7057	WB-10B	18-7037	18-7057	WB-9D	18-7037	18-7057
KA-8A	18-7013	18-7057	WB-10C	18-7037	18-7057	WM-16	18-7021	18-7061
KA-8AT	18-7013	18-7057	WB-10D	18-7037	18-7057	WM-17	18-7021	18-7061
KA-9A	18-7013	18-7057	WB-10E	18-7037	18-7057	WALBRO		
KA-9AT	18-7013	18-7057	WB-11A	18-7037	18-7057	WM-23	18-7021	18-7061
KB-10A	18-7013	18-7057	WB-11B	18-7037	18-7057	WMD-1	18-7021	18-7061
KB-11A	18-7013	18-7057	WB-12A	18-7037	18-7057	WMK-1	18-7021	18-7061
KB-12A	18-7013	18-7057	WB-12B	18-7037	18-7057	WMK-2	18-7021	18-7061
KB-14A	18-7013	18-7057	WB-13A	18-7037	18-7057	WMK-3	18-7021	18-7061
KB-3A	18-7013	18-7057	WB-13B	18-7037	18-7057	WMK-4	18-7021	18-7061
KB-3AT	18-7013	18-7057	WB-13C	18-7037	18-7057	WMK-5	18-7021	18-7061
KB-4A	18-7013	18-7057	WB-13D	18-7037	18-7057	WMK-7	18-7021	18-7061
KB-5A	18-7013	18-7057	WB-14A	18-7037	18-7057	WMK-8	18-7021	18-7061
KB-6A	18-7013	18-7057	WB-14B	18-7037	18-7057	WMK-9	18-7021	18-7061
KB-6B	18-7013	18-7057	WB-15A	18-7037	18-7057	WMK-10	18-7021	18-7061
KB-7A	18-7013	18-7057	WB-15B	18-7037	18-7057	WMK-11	18-7021	18-7061
KB-7B	18-7013	18-7057	WB-15C	18-7037	18-7057	WMK-12	18-7021	18-7061
KB-8A	18-7013	18-7057	WB-15D	18-7037	18-7057	WMK-13	18-7021	18-7061
KB-9A	18-7013	18-7057	WB-16A	18-7037	18-7057	WMK-14	18-7021	18-7061
KC-10A	18-7013	18-7057	WB-16B	18-7037	18-7057	WMK-15	18-7021	18-7061
KC-10AT	18-7013	18-7057	WB-16C	18-7037	18-7057	WMK-18	18-7021	18-7061
KC-11A	18-7013	18-7057	WB-16D	18-7037	18-7057	WMK-19	18-7021	18-7061
KC-11AT	18-7013	18-7057	WB-17A	18-7037	18-7057	WMK-20	18-7021	18-7061
KC-13A	18-7013	18-7057	WB-17B	18-7037	18-7057	WMK-21	18-7021	18-7061
KC-14A	18-7013	18-7057	WB-17C	18-7037	18-7057	WMK-22	18-7021	18-7061
KC-14AT	18-7013	18-7057	WB-19A	18-7037	18-7057	WMK-24	18-7021	18-7061
KC-15A	18-7013	18-7057	WB-19B	18-7037	18-7057	WMK-25	18-7021	18-7061
KC-15AT	18-7013	18-7057	WB-19C	18-7037	18-7057	WMK-26	18-7021	18-7061
KC-1A	18-7013	18-7057	WB-19D	18-7037	18-7057	WMK-27	18-7021	18-7061
KC-1AT	18-7013	18-7057	WB-1A	18-7037	18-7057	WMK-28	18-7021	18-7061
KC-2A	18-7013	18-7057	WB-1B	18-7037	18-7057	WMK-29	18-7021	18-7061
KC-2AT	18-7013	18-7057	WB-1C	18-7037	18-7057	WMK-30	18-7021	18-7061
KC-3A	18-7013	18-7057	WB-20A	18-7037	18-7057	WMK-31	18-7021	18-7061
KC-3AT	18-7013	18-7057	WB-20B	18-7037	18-7057	WMK-32	18-7021	18-7061
KC-4A	18-7013	18-7057	WB-21A	18-7037	18-7057	WMK-35	18-7021	18-7061
KC-5A	18-7013	18-7057	WB-21B	18-7037	18-7057	WMK-36	18-7021	18-7061
KC-5AT	18-7013	18-7057	WB-21C	18-7037	18-7057	WMK-38	18-7021	18-7061
KC-5B	18-7013	18-7057	WB-22A	18-7037	18-7057	WMK-39	18-7021	18-7061
KC-5BT	18-7013	18-7057	WB-23A	18-7037	18-7057	WMK-40	18-7021	18-7061
KC-5BTA	18-7013	18-7057	WB-24A	18-7037	18-7057	WMK-41	18-7021	18-7061
KC-5C	18-7013	18-7057	WB-25A	18-7037	18-7057	WMK-41-1A	18-7021	18-7061
KC-5CT	18-7013	18-7057	WB-26A	18-7037	18-7057	WMK-41-1B	18-7021	18-7061
KC-5CTA	18-7013	18-7057	WB-26B	18-7037	18-7057	WMK-41-3A	18-7021	18-7061
KC-6A	18-7013	18-7057	WB-27A	18-7037	18-7057	WMK-41-3B	18-7021	18-7061
KC-6AT	18-7013	18-7057	WB-27B	18-7037	18-7057	WO-8A-1	—	18-7061
KC-7A	18-7013	18-7057	WB-28A	18-7037	18-7057	WO-8A-2	—	18-7061
KC-7AT	18-7013	18-7057	WB-2A	18-7037	18-7057	WO-8A-3	—	18-7061
KC-7B	18-7013	18-7057	WB-2B	18-7037	18-7057	WO-8A-4	—	18-7061
KC-7BT	18-7013	18-7057	WB-2C	18-7037	18-7057	WO-8A-5	—	18-7061
KC-8A	18-7013	18-7057	WB-30A	18-7037	18-7057	WO-8A-6	—	18-7061
KC-9A	18-7013	18-7057	WB-31A	18-7037	18-7057	WO-9-1	—	18-7061
KC-9B	18-7013	18-7057	WB-3A	18-7037	18-7057	WO-9-2	—	18-7061
KC-9C	18-7013	18-7057	WB-3B	18-7037	18-7057	WO-9-3	—	18-7061
KD-1A	18-7013	18-7057	WB-3C	18-7037	18-7057	WO-9-4	—	18-7061
KD-1B	18-7013	18-7057	WB-4A	18-7037	18-7057	WO-9-5	—	18-7061
KD-1BR	18-7013	18-7057	WB-4B	18-7037	18-7057	WO-9-6	—	18-7061
KD-2A	18-7013	18-7057	WB-4C	18-7037	18-7057	WO-9A-1	—	18-7061
KD-4A	18-7013	18-7057	WB-5A	18-7037	18-7057	WO-9A-2	—	18-7061
KD-5A	18-7013	18-7057	WB-5B	18-7037	18-7057	WO-9A-3	—	18-7061
KD-6A	18-7013	18-7057	WB-6A	18-7037	18-7057	WO-9A-4	—	18-7061
KD-6AT	18-7013	18-7057	WB-7A	18-7037	18-7057	WO-9A-5	—	18-7061
KD-6B	18-7013	18-7057	WB-7B	18-7037	18-7057	WO-9A-6	—	18-7061

PREMIUM MARINE SPARK PLUG WIRE LEADS



OE style boots provide a sealed barrier against heat, dirt and moisture.

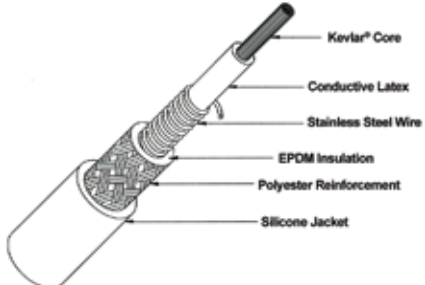

**Premium Marine Wire Leads
Magnetic Suppression Core
Manufactured for your
specific application**

- Kevlar® core for maximum durability and long life.
- Durable stainless steel wound conductor for maximum horsepower and engine performance.
- Premium silicone jacketing and boots for the ultimate in high temperature protection.
- Superior RFI suppression for the most sensitive electronic system.
- Corrosion resistant stainless steel spark plug and distributor terminals for maximum conductivity.

FLAGSHIP, INDMAR, MARINE POWER AND MASTERCRAFT

Model	Ignition Type	Cyl.	Part #	Model	Ignition Type	Cyl.	Part #
181 / 3.0L	Conventional	4	18-8800-1	454 / 7.4L	Conventional	8	18-8803-2
181 / 3.0L	EST, EFI	4	18-8811-1	454 / 7.4L	Conventional	8	18-8817-1 ②
262 / 4.3L	Conventional	6	18-8801-1	454 / 7.4L	EST	8	18-8824-1 ②
262 / 4.3L	EST, EFI	6	18-8810-1	454 / 7.4L	EST, EFI	8	18-8820-1
302 / 5.0L	Conventional	8	18-8803-2 ①	502 / 8.2L	Conventional	8	18-8803-2
350 / 5.7L	Conventional	8	18-8803-2	502 / 8.2L	Conventional	8	18-8817-1 ②
350 / 5.7L	EST, EFI	8	18-8820-1	502 / 8.2L	EST, EFI	8	18-8820-1
351 / 5.8L	Conventional	8	18-8803-2 ①				

① 1974:Model FF and R only

② 1974:Model R1 only

MERCURISER

Models	Cyl.	OE #	Ignition Type	Part #
ALL	4	84-816761Q13	Digital	18-8811-1
120 (153 CID)	4	84-816761Q5	Conventional	18-8800-1
140 (181 CID)	4	84-816761Q5	Conventional	18-8800-1
150	L6	84-816761Q8	Conventional	18-8809-1
160	L6	84-816761Q8	Conventional	18-8809-1
165	L6	84-816761Q8	Conventional	18-8809-1
185 CID	V6	84-816761Q7	Conventional	18-8801-1
198 GM	8	84-816761Q9, 84-816761Q10	Conventional	18-8803-2
224 CID	4	84-816761Q6	Conventional	18-8808-2
225 FORD	8	84-816761Q9, 84-816761Q10	Conventional	18-8803-2
225 GM	8	84-816761Q9, 84-816761Q10	Conventional	18-8803-2
228 GM	8	84-816761Q9, 84-816761Q10	Conventional	18-8803-2
229 CID	V6	84-816761Q7	Conventional	18-8801-1
233 FORD	8	84-816761Q9, 84-816761Q10	Conventional	18-8803-2
250 GM	8	84-816761Q9, 84-816761Q10	Conventional	18-8803-2
255 FORD	8	84-816761Q9, 84-816761Q10	Conventional	18-8803-2
260 GM	8	84-816761Q9, 84-816761Q10	Conventional	18-8803-2
260 TR	8	84-816761Q4 / 84-816761Q3, 84-816608Q61	Thunderbolt	18-8804-1
262 CID	V6	84-816761Q16	Thunderbolt	18-8810-1
280 GM	8	84-816761Q9, 84-816761Q10	Conventional	18-8803-2
305 CID LH	8	84-816761Q4 / 84-816761Q3, 84-816608Q61	Thunderbolt	18-8804-1
305 CID RH	8	84-816761Q4 / 84-816761Q3, 84-816608Q61	Thunderbolt	18-8804-1
320 EFI	8	84-816761Q4 / 84-816761Q3, 84-816608Q61	Thunderbolt	18-8804-1
330	8	84-816761Q9, 84-816761Q10	Conventional	18-8803-2
330 TR	8	84-816761Q4 / 84-816761Q3, 84-816608Q61	Thunderbolt	18-8804-1
350 CID LH	8	84-816761Q4 / 84-816761Q3, 84-816608Q61	Thunderbolt	18-8804-1
350 CID RH	8	84-816761Q4 / 84-816761Q3, 84-816608Q61	Thunderbolt	18-8804-1
350 MAG	8	84-816761Q4 / 84-816761Q3, 84-816608Q61	Thunderbolt	18-8804-1
350 MAG SKI	8	84-816761Q4 / 84-816761Q3, 84-816761Q17	Thunderbolt	18-8821-1
350 MAG BRAVO MPI & GEN +	8	84-816608Q71	Delco HEI	18-8836-1
350 MAG MPI MIE (GEN +)	8	84-816608K68	Delco HEI	18-8832-1
350 MAG MPI MIE (GEN +)	8	84-816608Q83	Mercury HEI	18-8834-1
350 MAG EFI SKI	8	84-816608K68	Delco HEI	18-8832-1
350 MAG MPI SKI (GEN +)	8	84-816608Q71	Delco HEI	18-8836-1
BLACK SCORPION SKI (GEN+) 350CID	8	84-816608K68	Delco HEI	18-8832-1
BLACK SCORPION SKI (GEN+) 350CID	8	84-816608Q81	Delco HEI	18-8822-1
MX 6.2 BLACK SCORPION SKI	8	84-816608Q81	Delco HEI	18-8822-1
370	8	84-816761Q9, 84-816761Q10	Conventional	18-8803-2
400	8	84-816761Q9, 84-816761Q10	Conventional	18-8803-2
420	8	84-816761Q4 / 84-816761Q3, 84-816608Q61	Thunderbolt	18-8804-1
420	8	84-847701Q7	Thunderbolt	18-8837-1
425	8	84-847701Q7	Thunderbolt	18-8837-1
440	8	84-816761Q9, 84-816761Q10	Conventional	18-8803-2

MERCURISER (Cont.)

Models	Cyl.	OE #	Ignition Type	Part #
454 CID	8	84-816761Q4 / 84-816761Q3, 84-816608Q61	Thunderbolt	18-8804-1
454 MAG	8	84-816761Q4 / 84-816761Q3, 84-816608Q61	Thunderbolt	18-8804-1
454 EFI, Mag MPI and Horizn MIE	8	84-816608K68	Delco HEI	18-8832-1
454 Hi Perf	8	84-816608Q78	Thunderbolt	18-8824-1
460	8	84-816761Q9, 84-816761Q10	Conventional	18-8803-2
465	8	84-847701Q7	Thunderbolt	18-8837-1
496	8	84-881698	Distributorless	18-8838-1
500	8	84-847701Q7	Thunderbolt	18-8837-1
500 Bulldog	8	84-847701Q7	Thunderbolt	18-8837-1
502 Mag	8	84-816608K68	Delco HEI	18-8832-1
502 EFI & Mag MPI	8	84-816608K68	Delco HEI	18-8832-1
525SC	8	84-847701Q7	Thunderbolt	18-8837-1
600SC	8	84-847701Q7	Thunderbolt	18-8837-1
800SC	8	84-847701Q7	Thunderbolt	18-8837-1
888 FORD	8	84-816761Q9, 84-816761Q10	Conventional	18-8803-2
898 GM	8	84-816761Q9, 84-816761Q10	Conventional	18-8803-2
2.5L	4	84-816761Q5	Conventional	18-8800-1
3.0L	4	84-816761Q5	Conventional	18-8800-1
3.0LX	4	84-816761K14	Delco EST	18-8833-1
3.7L	4	84-816761Q6	Conventional	18-8808-2
3.7XL	4	84-816761Q6	Conventional	18-8808-2
4.3L	V6	84-816761Q16	Thunderbolt	18-8810-1
4.3XL	V6	84-816761Q16	Thunderbolt	18-8810-1
4.3L EFI(TBI)	V6	84-816761Q16	Thunderbolt	18-8810-1
4.3L MPI	V6	84-816608Q82	Delco HEI	18-8835-1
5.0L	8	84-816761Q4 / 84-816761Q3, 84-816608Q61	Thunderbolt	18-8804-1
5.0L IB	8	84-816761Q4 / 84-816761Q3, 84-816608Q61	Thunderbolt	18-8804-1
5.0LX	8	84-816761Q4 / 84-816761Q3, 84-816608Q61	Thunderbolt	18-8804-1
5.0L Alpha & Bravo(Gen+)	8	84-816761Q3, 84-816761Q4, 84-816761Q17	Thunderbolt	18-8821-1
5.0L MIE MPI	8	84-863656A1	Delco HEI	18-8828-1
5.7L	8	84-816761Q4 / 84-816761Q3, 84-816608Q61	Thunderbolt	18-8804-1
5.7L IB	8	84-816761Q4 / 84-816761Q3, 84-816608Q61	Thunderbolt	18-8804-1
5.7L SKI	8	84-816761Q12	Conventional	18-8802-1
7.4L	8	84-816761Q4 / 84-816761Q3, 84-816608Q61	Thunderbolt	18-8804-1
7.4L IB	8	84-816761Q4 / 84-816761Q3, 84-816608Q61	Thunderbolt	18-8804-1

OMC/OMC COBRA

Engine	Cyl.	Year	Part #	OE #	Engine	Cyl.	Year	Part #	OE #
2.3L	4	1987-90	18-8807-1	503747	200	8	1979-81	18-8802-1	503752, 503755
2.5L	4	1982-86	18-8800-1	503748	225	8	1978	18-8802-1	503752, 503755
3.0L	4	1982-90	18-8800-1	503748	225	8	1976	18-8802-1	503752, 503755
3.0L/3.0L HO	4	1991-92	18-8814-1	503749	230	8	1979-81	18-8802-1	503752, 503755
3.8L	V6	1981-86	18-8801-1	503750	230 IB LH	8	1976	18-8802-1	503752, 503755
4.3L	V6	1985-90	18-8801-1	503750	230 IB RH	8	1976	18-8802-1	503752, 503755
5.0L	8	1982-88	18-8802-1	503752, 503755	235	8	1975-77	18-8805-1	
5.0L	8	1989-90	18-8806-1		240	8	1978	18-8805-1	
5.7L	8	1982-89	18-8802-1	503752, 503755	250	8	1979	18-8805-1	
5.7L King Cobra	8	1988	18-8802-1	503752, 503755	260	8	1979-81	18-8802-1	503752, 503755
5.8L	8	1989-90	18-8806-1		260 LH	8	1976	18-8802-1	503752, 503755
7.5L	8	1987	18-8803-2	503752	260 IB RH	8	1976	18-8802-1	503752, 503755
King Cobra	8	1987	18-8803-2	503752	262 King Cobra	V6	1989	18-8801-1	503750
80	4	1968-69	18-8800-1	503748	305 CID IB LH	8	1979-82	18-8802-1	503752, 503755
100	4	1972-73	18-8800-1	503748	305 CID IB RH	8	1977-82	18-8802-1	503752, 503755
110	4	1964	18-8800-1	503748	305 CID IB RH	8	1979-82	18-8802-1	503752, 503755
120	4	1965-74	18-8800-1	503748	305 CID IB LH	8	1977-82	18-8802-1	503752, 503755
120	4	1974-81	18-8800-1	503748	350 CID IB RH	8	1977-82	18-8802-1	503752, 503755
140	4	1973-74	18-8800-1	503748	350 CID IB RH	8	1979-82	18-8802-1	503752, 503755
140	4	1974-81	18-8800-1	503748	350 King Cobra	8	1989	18-8802-1	503752, 503755
140 Jet	4	1973	18-8800-1	503748	370 King Cobra	8	1988	18-8803-2	503752
175	8	1975-77	18-8805-1		454 CID IB	8	1979-82	18-8802-1	503752, 503755
185	8	1978-80	18-8802-1	503752, 503755	460 King Cobra	8	1988-89	18-8803-2	503752
190	8	1975-77	18-8805-1						

VOLVO-PENTA

Model	Cyl.	OE#	Part #	Model	Cyl.	OE#	Part #	Model	Cyl.	OE#	Part #
AQ120B	4	875571	18-8813-1	AQ225B,D	8	8757166-7	18-8802-1	AQ290A	8	8757166-7	18-8823-1
AQ125A,B	4	875571	18-8813-1	AQ225B,D	8	8757166-7	18-8823-1	AQ311A,B	8	8757166-7	18-8802-1
AQ131A-D	4	875571	18-8813-1	AQ231A,B	8	8757166-7	18-8802-1	AQ311A,B	8	8757166-7	18-8823-1
AQ140A	4	875571	18-8813-1	AQ231A,B	8	8757166-7	18-8823-1	BB140A	4	875571	18-8813-1
AQ145A,B	4	875571	18-8813-1	AQ240A	8	8757166-7	18-8802-1	BB145A	4	875571	18-8813-1
AQ151A-C	4	875571	18-8813-1	AQ240A	8	8757166-7	18-8823-1	BB225A-C	8	8757166-7	18-8802-1
AQ175A	V6	876532-3	18-8801-1	AQ255A-F	8	8757166-7	18-8802-1	BB225A-C	8	8757166-7	18-8823-1
AQ190A	8	8757166-7	18-8802-1	AQ255A-F	8	8757166-7	18-8823-1	BB231A	8	8757166-7	18-8802-1
AQ190A	8	8757166-7	18-8823-1	AQ260A,B	8	8757166-7	18-8802-1	BB231A	8	8757166-7	18-8823-1
AQ200B-F	8	8757166-7	18-8802-1	AQ260A,B	8	8757166-7	18-8823-1	BB260A-C	8	8757166-7	18-8802-1
AQ200B-F	8	8757166-7	18-8823-1	AQ271A-D	8	8757166-7	18-8802-1	BB260A-C	8	8757166-7	18-8823-1
AQ205A	V6	876532-3	18-8801-1	AQ271A-D	8	8757166-7	18-8823-1	BB261A	8	8757166-7	18-8802-1
AQ211A	8	8757166-7	18-8802-1	AQ290A	8	8757166-7	18-8802-1	BB261A	8	8757166-7	18-8823-1
AQ211A	8	8757166-7	18-8823-1								

① 1974:Model FF and R only ④ Model M only ⑦ Direct Drive Model w/closed cooling ⑨ 1990 (2 BBL) carb
 ② 1974:Model R1 only ⑤ Models w/o closed cooling ⑧ 1990 Models 302BMRPWS ⑩ 7mm Wire Set
 ③ 1975:Model A1 only ⑥ V-Drive model w/closed cooling and 302BPRP WS ⑪ For Models with Mallory Side Terminal Design

OIL FILTERS

Sierra oil filters are engineered with premium grade materials that will not only withstand but excel in the extreme environment of the Marine world. Sierra ensures the excellent performance of their filters by:

- Epoxy coating all canisters for corrosion resistance.
- Using a heavy-wall steel canister for further corrosion protection.
- Using high-efficiency filter media that meets or exceeds the OE's filtration.
- Backed by Sierra's industry leading warranty.

DIESEL OIL FILTERS

 <p>18-0032 Replaces: Volvo: 847741</p>	 <p>18-0033 Replaces: Volvo: 478736</p>	 <p>18-0034 Replaces: Volvo: 477556</p>
 <p>18-0035 Replaces: Volvo: 3582732 Full Flow</p>	 <p>18-0036 Replaces: Volvo: 3582733 Bypass</p>	 <p>18-7871 Replaces: Mercruiser: 35-805809</p>
 <p>18-7880 Replaces: Caterpillar: 1R-0658 Volvo-Penta: 466634</p>	 <p>*18-7884 Replaces: Universal: 299381 Volvo-Penta: 834337 Thread Spec: 3/4" x 16NPT</p>	 <p>*18-7886 Replaces: Perkins: 2654403 Thread Spec: 3/4" x 16NPT</p>
 <p>18-7899 Replaces: Detroit Diesel: 25010495</p>	 <p>*18-7910 Replaces: Westerbeke: 30220 Yanmar: 124450-35100 Thread Spec: 20mm x 1.5</p>	 <p>*18-7917 Replaces: Yanmar: 124450-35110, 124550-35110, 171056-35110, 171056-35111 Thread Spec: 20mm x 1.5</p>
 <p>*18-7925 Replaces: Westerbeke: 21235 Thread Spec: 3/4" x 16NPT</p>	 <p>*18-7926 Replaces: Volvo: 423135, 4785974 Thread Spec: 1" x 12NPT</p>	 <p>18-7927 Replaces: Caterpillar: 1R-0714 Thread Spec: 1 1/8" x 16NPT</p>

* Anti-Drain-Back Valve

Valve eliminates dry starts, prevents oil from draining back into crankcase during engine shutdown.

STERNDRIVE & INBOARD OIL FILTERS



***18-7824-1**
Short GM
 Replaces:
 Chris-Craft: 16.81-08746
 Crusader: 201104, Indmar: 50-1001
 Mercruiser: 35-802885Q, 32716,
 866340Q02, Q03, 866340K01,
 Mercruiser Vazer, OMC: 173232, 778864
 Pleasurecraft: R077002
 Volvo-Penta: 835440
 Yamaha: YSC-10231-20-0C
Thread Spec: 13/16" x 16NPT



***18-7875**
Long Ford
 Replaces:
 Chris-Craft: 16.81-06536
 Chrysler: 1851658, Crusader: 9002514
 Mercruiser: 60565, 35-802886Q
 OMC: 173231, 502900
 Pleasurecraft: R077001
 Yamaha: YSC-16231-20-0C
Thread Spec: 3/4" x 16NPT



***18-7876**
Long GM
 Replaces:
 Mercruiser: 35-16595T1, Q, 52731,
 35-802885Q, 14957
 OMC: 173233, 502901, Volvo: 3850559
 Yamaha: YSC-10231-20-0C
Thread Spec: 13/16" x 16NPT



***18-7878-1**
Short Ford
 Replaces:
 Chrysler: 3549957, L-19, L-1008
 Mercruiser: 803470
 OMC: 502904
 Volvo: 430143, 1266286, 3517857
Thread Spec: 3/4" x 16NPT



***18-7879**
V-6 GM
 Replaces:
 Chrysler: L-319
 Mercruiser: 35-802884Q, 41815,
 35-883702Q, K
 OMC: 173834, 502903
 Volvo: 841750
Thread Spec: 18mm x 1.5

4 CYCLE OUTBOARD OIL FILTERS



18-7758
 Replaces:
 Mercury: 35-877761K01, 35-877761Q01
Thread Spec: 22mm x 1.5



***18-7895**
 Replaces:
 Johnson/Evinrude: 778888, 5035703
 Suzuki: 16510-93J00
Thread Spec: 3/4" x 16NPT



***18-7896**
 Replaces:
 Johnson/Evinrude: 778886, 5033539
 Suzuki: 16510-61A20-MHL
Thread Spec: 3/4" x 16NPT



***18-7897**
 Replaces:
 Johnson/Evinrude: 778887, 5033919
 Suzuki: 16510-82703
Thread Spec: 3/4" x 16NPT



18-7901
 Replaces:
 Mercury: 825467A1, 825467T1
 Yamaha: 6G8-13440-00-00



***18-7902**
 Replaces:
 Yamaha: 3FV-13440-00-00
Thread Spec: 20mm x 1.5

* Anti-Drain-Back Valve
 Valve eliminates dry starts, prevents oil from draining back into crankcase during engine shutdown.



18-7903
 Replaces:
 Johnson/Evinrude: 5033102, 763364
 Suzuki: 16510-05240



***18-7905**
 Replaces:
 Suzuki: 16510-96J00
Thread Spec: 20mm x 1.5



***18-7906-1**
 Replaces:
 Yamaha: 69J-13440-00-00
 Mercury: 35-822626T7, Q15
Thread Spec: 3/4" x 16NPT



***18-7909**
 Replaces:
 Honda: 15400-POH-305PE,
 15400-POH-305, 15400-ZJI-004,
 15400-PLM-A01PE
Thread Spec: 20mm x 1.5



***18-7911-1**
 Replaces:
 Honda: 15400-PFB-007
 Nissan: 3R0076150M
 Yamaha 5GH-13440-00-00
Thread Spec: 20mm x 1.5



***18-7913**
 Replaces:
 Honda 15400-PFB-014
 Mercury: 35-822626Q1, Q03
Thread Spec: 20mm x 1.5



***18-7914**
 Replaces:
 Mercury: 35-822626Q2, Q04
Thread Spec: 20mm x 1.5



***18-7915-1**
 Replaces:
 Johnson/Evinrude: 778885, 5031411
 Suzuki: 16510-87J00
Thread Spec: 3/4" x 16NPT



***18-7916**
 Replaces:
 Johnson/Evinrude: 434839
Thread Spec: 3/4" x 16NPT



***18-7918**
 Replaces:
 Mercury: 35-883701K01, 35-877769K01
Thread Spec: 24mm x 1.5



***18-7921**
 Replaces:
 Mercury: 35-896546T, 35-877767K01
Thread Spec: 24mm x 1.5



***18-7954**
 Replaces: Yamaha N26-13440-00-00
 Fits: F350
Thread Spec: 3/4" x 16NPT



18-7974
 Replaces:
 Volvo: 3827069
Thread Spec: 18mm x 1.5



18-8003
 Replaces:
 Volvo: 8692305



**18-8700
 OIL FILTER**
 Replaces: 5GH-13440-20
 Fits: F15(2006-12), F20(2006-12),
 F25(2009-12), F40(2008-12), F50(2005-12),
 F60(2005*-12), F70(2010-12), T25(2009-12),
 T50(2005-12), T60(2005-12)

* Anti-Drain-Back Valve

Valve eliminates dry starts, prevents oil from draining back into crankcase during engine shutdown.

Application Chart for Sterndrive & Outboard Oil Filters

Albin				Evinrude/Johnson (Bombardier) Cont.				
Model	Replaces	Part #		40HP	1999-2006	5031411, 778885 18-7915-1		
AD-21	3875827	18-7878-1		50HP	1999-2006	5031411, 778885 18-7915-1		
B & W Lathrop				60HP	2002-2006	5031411, 778885 18-7915-1		
Model	Replaces	Part #		70HP	2001-2006	5031411, 778885 18-7915-1		
130155		18-7875		90HP	2003-2006	778886, 5033539 18-7896		
Caterpillar				115HP	2003-2006	778886, 5033539 18-7896		
Model	Replaces	Part #		140HP	2003-2006	778887, 5033919 18-7897		
3304, 3306, D330	1R-0658	18-7880		200HP	2004-2006	778888, 5035703 18-7895		
3116, 3116TA, 3208, 3208T, 3208TA	1R-0714	18-7927		225HP	2004-2006	778888, 5035703 18-7895		
Chris-Craft				Flagship				
Model	Replaces	Part #		Model	Replaces	Part #		
307G, 305K, 307K	16.81-08746	18-7824		150FA, 220FF, 250FA, 400FA, 425FAJ, 650FAJ, 950FAJ		18-7824		
Chrysler						18-7876 ②		
Model	Replaces	Part #		292, 300, 307, 327, 350, 482		18-7824 ①		
(Chrysler-Volvo) 100, 110, 120, 130, 165, 170		18-7878-1 ①		Ford				
125, 150, 155, 175, Fury 190, 195, 200, 210, 225, 235, 250, 260, 280, 300, 330, 335, 375, 525, CM6-55, CMC-55NA, M-170A, M-225A, M-225D, M-273A, M-273B, M-273BO/D, LM-318, LM-318A, LM-318B, M-318B, M-318C, M-383B, M-413B, M-413D, M-413E, M-440B, M-440D, Model 340, M-80, M-81, Super Crown 145, 150, Imperial 290, 325, Jet II, Jet III, Jet IV, Super Bee, Super Bee II, Super Bee III, V-8 Engines 1962-on	1851658	18-7875		Model	Replaces	Part #		
V-6 GM	L-319	18-7879		CSG850M WSG858M, LSG875M, SSD-655, -655M, -655MT, (5.5 Liter), 140(2.3L) FOUR, 170, 200 Six, 240 Six, 300 Six, 302 (5.0L), 351 (5.8L), 460 (7.5L), 2711E, 2712E, 2713E, 2714E, 2715E (diesel)		18-7875		
3.7L, 5.2L	3549957, L-19, L1008	18-7878-1		254 (DSD-442 4.2 Liter), 362 (DSD-659 5.9 Liter) 91—V4, 104 V4, 380 (DSD-662 6.2 Liter)		18-7875 18-7878-1		
Commander				GM				
Model	Replaces	Part #		Model	Replaces	Part #		
225, 340 Clevor		18-7875		6-194 (1962-67), 6-230 (1963-68), V8-305 (1976-78), V8-307 (1970-73), V8-350 (1970-87), V8-366 (1970-87), V8-400 (1971-72, 1975-83), V8-454 (1973-87), V8-267 (1979-81), V8-305 (1979-87), V8-350 (1978-81), V8-400 (1974-77)		18-7876 ② 18-7824 ①		
Crusader				Greenwich				
Model	Replaces	Part #		Model	Replaces	Part #		
150, 160, 165, CH185, 210, CH220, CH270, 350, CH350	201104	18-7824		Porpoise (w/IH V8-275B)		18-7875		
SS330	201104	18-7824 ② 18-7824 ①		Honda				
220 Conqueror, 255 Conqueror, 255 Conqueror Jet, 250 ('71), 300 Scorpion, 460	9002514	18-7875		Models	Years	SS Number	Replace	Part #
220, 300, 320, 325		18-7878-1		BF8D, BFP8D	2001-Current	15400-PFB-004	15400-PFB-014	18-7913
Daytona				BF9D, BFP9D	2001-Current	15400-PM3-004	15400-PFB-014	18-7913
Model	Replaces	Part #		BF15D, BFP15D	2003-Current	15400-PM3-405	15400-PFB-014	18-7913
200, 292, 300, 350, 400, 427, 427A, 427B		18-7876 ② 18-7824 ①		BF20D	2003-Current	15400-PJ7-015	15400-PFB-014	18-7913
Detroit Diesel				BF25A	1998-Earlier	15400-PJ7-005	15400-PFB-014	18-7913
Model	Replaces	Part #		BF30A	1998-Earlier	15400-PJ7-005	15400-PFB-014	18-7913
2-71 (142), 3-71 (213), 4-53 (212), 4-71 (284), 6V-53 (318), 6-71 (426), 6-71E (426), 671N (426), 6-71T (426), 6V-71 (426), 6V-71T (426), 6V-92 (552), 6V-92T (522), 8V-71 (568), 8V-71T (568), 8V-92 (736), 8V-92T (736), 12V-71 (1788), 12V-71T (1788), 12V-149 (1788), 16V-71 (1136), 16V-71T (1136), 16V-92 (1472), 16V-92T (1472), 16V-149 (2384) Series	25010495	18-7899		BF35AM	1998-Earlier	15400-PJ7-005	15400-PFB-014	18-7913
Evinrude/Johnson (Bombardier)				BF40A	1998-Earlier	15400-PJ7-005	15400-PFB-014	18-7913
Models	Year	Replaces	Part #	BF45AM	1998-Earlier	15400-PJ7-005	15400-PFB-014	18-7913
10HP	1995-2001	434839 OMC Built	18-7916	BF50A	1998-Earlier	15400-PJ7-005	15400-PFB-014	18-7913
15HP	1995-2001	434839 OMC Built	18-7903	BF25	1999-Current	15400-ZW4-003	15400-PFB-007	18-7911-1
10HP	2002-2007	5033102, 763364	18-7903	BF30	1999-Current	15400-ZW4-003	15400-PFB-007	18-7911-1
15HP	2002-2007	5033102, 763364	18-7903	BF40	1999-Current	15400-ZW4-003	15400-PFB-007	18-7911-1
25HP	2000-2007	5031411, 778885	18-7915-1	BF50	1999-Current	15400-ZW4-003	15400-PFB-007	18-7911-1
30HP	2000-2001	5031411, 778885	18-7915-1	BF75, BF90	1997-Current	15400-P0H-305PE	15400-PLM-A01PE	18-7909
30HP	2004-2005	5031411, 778885	18-7915-1	BF115, BF130	1999-Current	15400-P0H-305	15400-PLM-A01PE	18-7909
Hydro-Marine				BF135, BF150	2004-Current	15400-ZJ1-004	15400-PLM-A01PE	18-7909
Model	Replaces	Part #		BF200, BF225	2002-Current	15400-ZJ1-999AH	15400-PLM-A01PE	18-7909
All Models (Knecht FO335/1)		18-7875		Hydro-Marine				

① Short Filter ② Long Filter

Indmar

Model	Replaces	Part #
250		18-7875
275 (SP), 300 (SP), 350-2, 350-4, 350(SP), 454-2, 454-4, 400 (SP)		18-7876 ② 18-7824 ①

Interceptor

Model	Replaces	Part #
IV4-80, OV4-80, OV6-100 (Taurus), 80, 85, 100, 110, 120, (1960-on), 140, 190, 200, 210, Interceptor 160, Interceptor 165		18-7878-1

Lehman

Model	Replaces	Part #
Models (w/Ford 242), (w/Ford 254), (w/Ford 363), (w/Ford 380), (Lehman 2N50)		18-7875

Marine Power, Inc.

Model	Replaces	Part #
3.0L, 350 (5.7L) 454 (7.4L) ENPACK	0905-000-0	18-7876 ② 18-7824 ①
350 (5.7L) 454 (7.4L) SPORTPAC	0904-000-0	18-7875

Mercuriser

Models	Cyl.	Year	Replaces	Part #
D7.3L Diesel	8	1994-99	35-805809T	18-7871
60 HP	4	1965-68	35-803470, Q	18-7878-1
80 HP	4	1966-69	35-803470, Q	18-7878-1
Vazer 1.6L	L4	2007-Up	35-866340K01,Q3	18-7824
110 (153 CID) ④ ⑤	L4	1963-66	35-866340K01,Q3	18-7824
120 (153 CID) ④ ⑤	L4	1964-82	35-866340K01,Q3	18-7824
120 (153 CID) ④ ⑤	L4	1983-86	35-866340K01,Q3	18-7824
140 (181 CID) ④ ⑤	L4	1968-82	35-866340K01,Q3	18-7824
140 (181 CID) ④ ⑤	L4	1982-86	35-866340K01,Q3	18-7824
150 (230 CID)	L6	1964-66	35-16595Q, T1	18-7876
160 (250 CID)	L6	1967-69	35-16595Q, T1	18-7876
165 (250 CID)	L6	1970-81	35-16595Q, T1	18-7876
185 CID	V6	1985-87	35-883702K, Q	18-7879
198 GM	8	1977	35-16595Q, T1	18-7876
224 CID (470) (485) (488) ④ ⑤	L4	1976-84	35-866340K01,Q3	18-7824
224 CID (3.7L, 3.7LX, 165, 170, 180, 190) ④ ⑤	L4	1985-89	35-866340K01,Q3	18-7824
225 FORD ③	8	1973-74	35-802886Q	18-7875
228 GM	8	1977-84	35-16595Q, T1	18-7876
229 CID	V6	1983-84	35-883702K, Q	18-7879
233 FORD ③	8	1975-76	35-802886Q	18-7875
250 GM	8	1968-69, 1977	35-16595Q, T1	18-7876
255 FORD ③	8	1975-76	35-802886Q	18-7875
260 GM ④ ⑤	8	1978-86	35-866340K01,Q3	18-7824
260 GM MIE ④ ⑤	8	1981-86	35-866340K01,Q3	18-7824
260 GM MIE & MCM ④ ⑤	8	1987	35-866340K01,Q3	18-7824
262 CID (175, 180, 205, 4.3L/LX, MAG) ④	V6	1985-98	35-883702K, Q	18-7879
262 CID (4.3L/LX/LXH, EFI, MPI, TBI) ④	V6	1999-UP	35-883702K, Q	18-7879
280 GM ④ ⑤	8	1975-76	35-866340K01,Q3	18-7824
320 EFI ④ ⑤	8	1987-89	35-866340K01,Q3	18-7824
330 ④	8	1977-81	35-16595Q, T1	18-7876
330 ④ ⑤	8	1982-87	35-866340K01,Q3	18-7824
350 MAG ④	8	1986-87	35-16595Q, T1	18-7876
350 MAG ④ ⑤	8	1987-95	35-866340K01,Q3	18-7824
350 MAG SKI ④ ⑤	8	1991-UP	35-866340K01,Q3	18-7824
350 MAG BRAVO MPI & GEN +	8	1995-UP	35-866340K01,Q3	18-7824
350 MAG MPI MIE (GEN +)	8	1998-UP	35-866340K01,Q3	18-7824
350 MAG EFI SKI	8	1994-97	35-866340K01,Q3	18-7824
350 MAG MPI SKI (GEN +)	8	1998-UP	35-866340K01,Q3	18-7824
BLACK SCORPION SKI (GEN+) 350CID	8	1996-UP	35-866340K01,Q3	18-7824
370 (454 CID) ④	8	1978-87	35-16595Q, T1	18-7876
400 (454 CID) ④	8	1980-86	35-16595Q, T1	18-7876
420 (454 CID) ④	8	1987-89	35-16595Q, T1	18-7876
440 (454 CID) ④	8	1983-86	35-16595Q, T1	18-7876
454 MAG	8	1986-UP	35-866340K01,Q3	18-7824
454 EFI, Mag MPI and Horizin MIE	8	1994-UP	35-866340K01,Q3	18-7824
460 ④	8	1983-86	35-16595Q, T1	18-7876
496	8	All	35-866340K01,Q3	18-7824
502 Mag	8	1990-97	35-866340K01,Q3	18-7824
502 EFI & Mag MPI	8	1998-UP	35-866340K01,Q3	18-7824

Mercuriser (Cont.)

Models	Cyl.	Year	Replaces	Part #
888 FORD	8	1971-77	35-802886Q	18-7875
898 GM ④	8	1977-84	35-16595Q, T1	18-7876
2.5L (153 CID) ④ ⑤	L4	1987-89	35-866340K01,Q3	18-7824
3.0L (181 CID) ④ ⑤	L4	1987-UP	35-866340K01,Q3	18-7824
3.0LX (181 CID) ④ ⑤	L4	1990-97	35-866340K01,Q3	18-7824
3.7L/LX	L4	1988-89	35-866340K01,Q3	18-7824
4.3L/LX ⑤	V6	1988-98	35-883702K, Q	18-7879
4.3L/XL, EFI, TBI, MPI ⑤	V6	1998-UP	35-883702K, Q	18-7879
5.0L ④ ⑤	8	1988-UP	35-866340K01,Q3	18-7824
5.0L IB ④ ⑤	8	1987-95	35-866340K01,Q3	18-7824
5.0LX ④ ⑤	8	1988-95	35-866340K01,Q3	18-7824
5.0L EFI	8	1998-01	35-866340K01,Q3	18-7824
5.0L MIE MPI	8	2002-UP	35-866340K01,Q3	18-7824
5.7L	8	1998-UP	35-866340K01,Q3	18-7824
5.7L IB ④ ⑤	8	1988-UP	35-866340K01,Q3	18-7824
5.7L SKI ④ ⑤	8	1985-UP	35-866340K01,Q3	18-7824
7.4L ④ ⑤	8	1988-UP	35-866340K01,Q3	18-7824
7.4L IB ④ ⑤	8	1988-UP	35-866340K01,Q3	18-7824

Mercury

Models	Year	Replaces	Serial #	Part #
8HP Bodensee (323cc)	2001-2004	P086824-P325499	35-822626Q1, Q3	18-7913
8HP Bodensee (232cc)	1995-1998	H000058-H017099	825467T1, A1	18-7901
8HP Bodensee (232cc)	1999-2000	G760300-T178499	825467T1, A1	18-7901
9.9HP (232cc)	1995-1998	H000058-H017099	825467T1, A1	18-7901
9.9HP (323cc)	1999-UP	G760300-1B226999	35-822626Q1, Q3	18-7913
25HP	1998	G590000-G760299	35-822626Q1, Q3	18-7913
25HP	1999-UP	G760300-1B226999	35-822626Q2, Q04	18-7914
30HP	1999-UP	G760300-T408999	35-822626Q2, Q04	18-7914
40HP (3 cyl)	2001-UP	T409000-UP	35-822626Q2, Q04	18-7914
40HP (4 cyl)	1998-UP	G231123-UP	35-822626Q2, Q04	18-7914
45HP Bodensee	1996-2000	G231123-T178499	35-822626Q2, Q04	18-7914
50HP	2001-UP	T178500-UP	35-822626Q2, Q04	18-7914
50HP Bigfoot	1996-2000	G231123-T178499	35-822626Q2, Q04	18-7914
60HP	2001-UP	T178500-UP	35-822626Q2, Q04	18-7914
75HP TBI, EFI	1999-UP	G960500-UP	35-822626Q2, Q04	18-7914
80HP	2006-UP	1B227000-UP	35-822626Q04	18-7914
90HP	1999-UP	G960500-UP	35-822626Q2, Q04	18-7914
115HP EFI	2001-UP	T178500-1B226999	35-822626Q2, Q04	18-7914
135 Verado	ALL	1B227000-UP	35-896546T	18-7921
150 Verado	ALL	1B227000-UP	35-896546T	18-7921
175 Verado	ALL	1B227000-UP	35-896546T	18-7921
200 Verado	ALL	T980000-1B226999	35-883701K01	18-7918
225HP EFI	2003-UP	T653945-UP	35-822626T7, Q15	18-7906-1
225 Verado	ALL	1B227000-UP	35-883701K01	18-7918
250 Verado	ALL	T801000-UP	35-883701K01	18-7918
275 Verado	ALL	T801000-UP	35-883701K01	18-7918

Mohawk

Model	Replaces	Part #
V8-302, V8-351		18-7875

Nissan/Tohatsu

Model	Year	Replaces	Part #
9.9-30HP	All	3R0076150M	18-7911-1

OMC

Engine	Cyl.	Year	Replaces	Part #
2.3L	L4	1987-90	173231	18-7875
2.5L	L4	1982-86	173232	18-7824
3.0L/				
3.0L HO	L4	1982-98	173232	18-7824
3.8L	V6	1981-85	173834	18-7879
4.3L	V6	1985-98	173834	18-7879
5.0L	8	1982-88	173233	18-7876
5.0L	8	1993-96	173231	18-7875
5.0L	8	1998	502901	18-7876
5.7L	8	1982-92	173233	18-7876
5.7L	8	1996-98	502901	18-7876
5.8L	8	1989-96	173231	18-7875
7.5L	8	1987	173231	18-7875
100	L4	1972-73	173232	18-7824
120	L4	1965-81	173232	18-7824
140	L4	1973-81	173232	18-7824
155	V6	1968-72		18-7923
165	L6	1972-76	173233	18-7876
170	8	1974	173233	18-7876
175	8	1975-77	173231	18-7875

① Short Filter ② Long Filter ③ V-Drive model use 18-7878-1
 ④ Optional use 5" tall 18-7876 for additional filtration, Not For Remote Mount, check clearance for fit, 18-7824 = 4" tall ⑤ 18-7824 can be used on remote filter mount applications

OMC (Cont.)					Volvo-Penta (Gasoline)				
Engine	Cyl.	Year	Replaces	Part #	Model	Replaces	Cyl.	Part #	
185	8	1978-80	173231	18-7875	230A/B	2366286-2, 430143-8, 3517857-3	L4	18-7878-1	
190	8	1974-77	173231	18-7875	250A/B	2366286-2, 430143-8, 3517857-3	L4	18-7878-1	
200	8	1979-81	173233	18-7876	251A	2366286-2, 430143-8, 3517857-3	L4	18-7878-1	
M-100, M-200 (460 CID)	4	1961-70	502904	18-7878-1	3.0GL/GS	835440-9	L4	18-7824	
225	8	1972-76, 1978	381767	18-7876	4.3Gi/GL/GS	—	V6	18-7879	
230	8	1979-81	173233	18-7876	430A/B	—	V6	18-7879	
235	8	1971-77	381767	18-7876	431A/B	—	V6	18-7879	
240	8	1978	173231	18-7875	432A	—	V6	18-7879	
245	8	1972-75	381767	18-7876	434A	—	V6	18-7879	
250	8	1979	173231	18-7875	5.0Fi/FL	—	8	18-7875	
260	8	1979-81	173233	18-7876	5.7Gi/GL	835440-9	8	18-7824	
					5.8Fi/FL	—	8	18-7875	
					5.8FSi	—	8	18-7875	
Onan					500A/B	835440-9	8	18-7824	
Model			Replaces	Part #	501A/B	835440-9	8	18-7824	
JA, JB, JB (Ind. eng.), JC gen., JC (Ind. eng.), MJA, MJB, MJC, J-30, J-60, J-120, RDJF, RJC, DJA, DJB, DJC, MDJA, MDJB, MDJC, RDJC, DJ-30, DJ-60, DJ-120, JD-130, MDJ-30, MDJ-130, 6MDJB-37, 15MDJC-3R, 3.0 DJA, DJE, 6.0 DJB, MDJE, MDJF, NH, 7.5 MDJE, 15MDJF, 15 MDJ-3R, 705 MDJE-3R, 150 MDJF, DJB Gen. (Standard)			122-0185	18-7878-1	570A/MS4A	835440-9	8	18-7824	
EF				18-7875	571A	835440-9	8	18-7824	
Onan (Generator Sets) 3.0 Aux. (w/MDJA diesel eng.)			122-0185	18-7878-1	572A	835440-9	8	18-7824	
Palmer					7.4Gi/GL/Gsi	835440-9	8	18-7824	
Model			Replaces	Part #	740A/B	835440-9	8	18-7824	
AD-21				18-7878-1	8.2GL	835440-9	8	18-7824	
P302, P351, P460, PA190, PA220, PA255				18-7875	AQ100	2366286-2, 430143-8, 3517857-3	L4	18-7878-1	
Perkins					AQ110	2366286-2, 430143-8, 3517857-3	L4	18-7878-1	
Model			Replaces	Part #	AQ115AB	2366286-2, 430143-8, 3517857-3	L4	18-7878-1	
4.154M, 4.154/165, 4.203, 4.236, 4.236, 4A236, 4.248, 4.300, A4300, A4.318 (Except A4-318), 6.247, 6.354, 6.354M, T6.354, T6.354M, HT6.354, HT6.354M, 6.3544, T6(.354, ST6.3544 Ranger 4 Series: 6.372, 6/152, 3/152Y, 3AB152, 4.107, 4.107M, 4.108, A4-212, AG4-212, 6.354.2			2654403	18-7886 ①	AQ120/B	2366286-2, 430143-8, 3517857-3	L4	18-7878-1	
Pleasurecraft					AQ125A/B	2366286-2, 430143-8, 3517857-3	L4	18-7878-1	
Model			Replaces	Part #	AQ130A/B/C/D	2366286-2, 430143-8, 3517857-3	L4	18-7878-1	
PCM Model 200, 220, 250, 8200, 8240			R-077001	18-7875	AQ131A/B/C/D	2366286-2, 430143-8, 3517857-3	L4	18-7878-1	
PCM Model 230, 280, 300, 350			R-077002	18-7824 ②	AQ140A	2366286-2, 430143-8, 3517857-3	L4	18-7878-1	
Ranger					AQ145A/B	2366286-2, 430143-8, 3517857-3	L4	18-7878-1	
Model			Replaces	Part #	AQ151A/B/C	2366286-2, 430143-8, 3517857-3	L4	18-7878-1	
85, 110				18-7878-1 18-7904	AQ170A/B/C	2366286-2, 430143-8, 3517857-3	L4	18-7878-1	
Suzuki					AQ171A/C	2366286-2, 430143-8, 3517857-3	L4	18-7878-1	
Model	Year	Replaces		Part #	AQ175A	—	V6	18-7879	
DF9.9, DF15	1996-06	16510-05240		18-7903	AQ190A	—	8	18-7875	
DF25, DF30	2000-06	16510-87J00		18-7915	AQ200B/C/D/F	835440-9	8	18-7824	
DF40, DF50, DF60, DF70	1999-06	16510-87J00		18-7915	AQ205A	—	V6	18-7879	
DF90, DF115	2001-06	16510-61A01		18-7896	AQ211A	835440-9	8	18-7824	
DF140	2002-04	16510-82703		18-7897	AQ225B/C/D/E/F	835440-9	8	18-7824	
DF150, DF175	2006	16510-93J00		18-7895	AQ231A	835440-9	8	18-7824	
DF200, DF225, DF250	2004-07	16510-93J00		18-7895	AQ231B	835440-9	8	18-7824	
DF200, DF225, DF250	2008	16510-96J00		18-7905	AQ240A	—	8	18-7875	
DF150, DF175, DF300	2007 & Up	16510-96J00		18-7905	AQ255A/B	835440-9	8	18-7824	
Universal					AQ260A/B	835440-9	8	18-7824	
Model			Replaces	Part #	AQ271A/B/C/D	835440-9	8	18-7824	
16510-82703 Strato King V8-350				18-7878-1 18-7884	AQ280A	835440-9	8	18-7824	
M-15 1Cyl., 2 Cyl., 3 Cyl,				18-7882 ③ 18-7883 ④	AQ290A	835440-9	8	18-7824	
Volvo-Penta (Diesel)					AQ311A/B	835440-9	8	18-7824	
Model			Replaces	Part #	AQ60F	2366286-2, 430143-8, 3517857-3	8	18-7878-1	
120AHC			423135-3, 4785974-9	18-7926	AQ90	2366286-2, 430143-8, 3517857-3	L4	18-7878-1	
2001,B				18-7884	AQ95/A	2366286-2, 430143-8, 3517857-3	L4	18-7878-1	
2002,B				18-7884	BB100	2366286-2, 430143-8, 3517857-3	L4	18-7878-1	
2003,B, TB				18-7884	BB115A/B/C	2366286-2, 430143-8, 3517857-3	L4	18-7878-1	
AD31A/B/D/P/XD			2366286-2, 430143-8, 3517857-3	18-7878-1	BB140A	2366286-2, 430143-8, 3517857-3	L4	18-7878-1	
AQ70B/C			423135-3, 4785974-9	18-7926	BB145A	2366286-2, 430143-8, 3517857-3	L4	18-7878-1	
AQAD30A			2366286-2, 430143-8, 3517857-3	18-7878-1	BB165A	2366286-2, 430143-8, 3517857-3	L4	18-7878-1	
AQAD31A			2366286-2, 430143-8, 3517857-3	18-7878-1	BB170A/B/C	2366286-2, 430143-8, 3517857-3	L4	18-7878-1	
AQD2B				18-7884	BB225A/B/C	835440-9	8	18-7824	
AQD21AB, 32A			3827069	18-7974	BB231A	835440-9	8	18-7824	
D100BHC/BRC			423135-3, 4785974-9	18-7926	BB260A/B/C	835440-9	8	18-7824	

① Short Filter ② Long Filter ③ V-Drive model use 18-7878-1

④ Optional use 5" tall 18-7876 for additional filtration, Not For Remote Mount, check clearance for fit, 18-7824 = 4" tall

⑤ 18-7824 can be used on remote filter mount applications

Volvo-Penta (Diesel) (Cont.)		
Model	Replaces	Sierra #
D41B	423135-3, 4785974-9	18-7926
D70HC/CRC	423135-3, 4785974-9	18-7926
KAD32P	423135-3, 4785974-9	18-7926
KAD42B/P/PA	423135-3, 4785974-9	18-7926
KAD43P/44P/300	423135-3, 4785974-9	18-7926
KAMD42A/B/P	423135-3, 4785974-9	18-7926
KAMD43P/44P/300	423135-3, 4785974-9	18-7926
MD100A/B	423135-3, 4785974-9	18-7926
MD11C		18-7884
MD11D		18-7884
MD120A/B	423135-3, 4785974-9	18-7926
MD17C		18-7884
MD17D		18-7884
MD1B		18-7884
MD2		18-7884
MD2B		18-7884
MD21A/B	3827069	18-7974
MD30A	2366286-2, 430143-8, 3517857-3	18-7878-1
MD31A	2366286-2, 430143-8, 3517857-3	18-7878-1
MD32A	3827069	18-7974
MD3B		18-7884
MD5A		18-7884
MD5B		18-7884
MD5C		18-7884
MD6A		18-7884
MD6B		18-7884
MD70B/A	423135-3, 4785974-9	18-7926
MD7A		18-7884
MD7B		18-7884
T70CRC	423135-3, 4785974-9	18-7926
TAD120BHC/CHC	423135-3, 4785974-9	18-7926
TAMD120A/B	423135-3, 4785974-9	18-7926
TAMD30A	2366286-2, 430143-8, 3517857-3	18-7878-1
TAMD31B/D/PL	2366286-2, 430143-8, 3517857-3	18-7878-1
TAMD40A/B	423135-3, 4785974-9	18-7926
TAMD41A/B/D	423135-3, 4785974-9	18-7926
TAMD42B/WJ	423135-3, 4785974-9	18-7926
TAMD60A/B/C	423135-3, 4785974-9	18-7926
TAMD61A, 62A, 63LA, 63PA	3827069	18-7974
TAMD70B/C	423135-3, 4785974-9	18-7926
TAMD71A/B, 72A, 73P-A, 73WJ-A, 74A-A, 74A-B, 74C-A, 74C-B, 74P-B, 75P-A	3827069	18-7974
TD11AHC	423135-3, 4785974-9	18-7926
TD120A/ARC/BHC/BRC	423135-3, 4785974-9	18-7926
THAMD70B/C	423135-3, 4785974-9	18-7926
TMD100A	423135-3, 4785974-9	18-7926
TMD120A/B	423135-3, 4785974-9	18-7926

Volvo-Penta (Diesel) (Cont.)			
Model	Replaces	Sierra #	
TMD30A	2366286-2, 430143-8, 3517857-3	18-7878-1	
TMD31A	2366286-2, 430143-8, 3517857-3	18-7878-1	
TMD31B	2366286-2, 430143-8, 3517857-3	18-7878-1	
TMD31D	2366286-2, 430143-8, 3517857-3	18-7878-1	
TMD31L-A	2366286-2, 430143-8, 3517857-3	18-7878-1	
TMD41B	423135-3, 4785974-9	18-7926	
TMD41L-A	423135-3, 4785974-9	18-7926	
TMD70B/C	423135-3, 4785974-9	18-7926	

Waukesha		
Model	Replaces	Part #
155, 165, 185, 215, 255, 302, 351		18-7875

Westerbeke		
Model	Replaces	Part #
L25(12)	21235	18-7925
Four-60, Four-91, Four-154, BR-30, BR-45, Performer-6, WPDS-10, WPDS-20		18-7875
D60, D80, 10 TWO, 13A, 18, 21 (A), 27 (A), 33, 41G, W70G	30220	18-7910

Yamaha			
Model	Year	Replaces	Part #
F9.9/T9.9	2006-2007	5GH-13440-00-00	18-7911-1
F9.9/T9.9	1990-2005	6G8-13440-00-00	18-7901
F15	1998-1999	3FV-13440-00-00	18-7902
F15	2000-2007	5GH-13440-00-00	18-7911-1
F25	1998-1999	3FV-13440-00-00	18-7902
F25/T25	2000-2006	5GH-13440-00-00	18-7911-1
F30	2001-2006	5GH-13440-00-00	18-7911-1
F40	1999-2000	3FV-13440-00-00	18-7902
F40	2001-2006	5GH-13440-00-00	18-7911-1
F50/T50	1995-1999	3FV-13440-00-00	18-7902
F50/T50	2000-2005	5GH-13440-00-00	18-7911-1
F60/T60	2002-2005	5GH-13440-00-00	18-7911-1
F75/F90	2003-2006	5GH-13440-00-00	18-7911-1
F80/F100	1999	3FV-13440-00-00	18-7902
F80	2000-2003	5GH-13440-00-00	18-7911-1
F100	2000-2002	5GH-13440-00-00	18-7911-1
F115	2001-2006	5GH-13440-00-00	18-7911-1
F150	2004-2006	69J-13440-00-00	18-7906-1
F200/F225	2002-2006	69J-13440-00-00	18-7906-1
F250	2005-2006	69J-13440-00-00	18-7906-1
F350	2008-UP	N26-13440-00-00	18-7954

Yanmar		
Model	Replaces	Part #
2QM, 2QM15, 2QM20, 3QM, 3QM30, 3HM, 3HM(F), 3HM35, 3HM35(F)	124450-35110, 124550-35110, 171056-35110, 171056-35111	18-7917
1GM, 1GM10, 2GM, 2GMF, 2GM20, 2GM20F, 3GM, 3GMF, 3GM30, 3GM30F	124450-35100	18-7910

OIL DRAIN KITS

For easy installation this kit includes:

- 42" hose with hose hanger
- Universal oil pan replacement plug
- End cap



- Makes changing your oil a snap and without the mess!
- Permanently mounts to bottom of oil pan to make changing oil more convenient.
- Drains 4 quarts of oil in less than 15 minutes without a pump.
- Fittings on hose machined from corrosion resistant brass.
- Assembly sized to pass through most common hull drains.

Part #	Description	Application
18-7891	For: GM, Chrysler & Most Ford	Oil Pans 1/2" — 20 Threads
18-7892	For: European Made Volvo	Engines 3/4" — 16 Threads

NEW

18-2446
FILL/DRAIN KIT — OUTBOARD
 Fits: Johnson/Evinrude & Mercury Gearcase

NEW

18-2447
FILL/DRAIN KIT — STERN DRIVE
 Fits: Stern Drive Gearcase

OUTBOARD 4-CYCLE OIL DISPLAY

18-9497

10W-40 FC-W SEMI-SYNTHETIC

Includes:

- Corrugated display with graphics
- One case of quart bottles (18-9551-2)
- One case of gallon bottles (18-9551-3)

18-9498

10W-30 FC-W PREMIUM BLEND

Includes:

- Corrugated display with graphics
- One case of quart bottles (18-9420-2)
- One case of gallon bottles (18-9420-3)

18-9495

Display Only



TC-W3 DISPLAY

18-9496

FULL SYNTHETIC TC-W3

Includes:

- Corrugated display with graphics
- One case of quart bottles (18-9540-2)
- One case of gallon bottles (18-9540-3)

18-9499

PREMIUM BLEND TC-W3

Includes:

- Corrugated display with graphics
- One case of quart bottles (18-9500-2)
- One case of gallon bottles (18-9500-3)

18-9494

Display Only



TC-W3



Sierra TC-W3 is a high performance lubricant that has been manufactured and designed to meet and exceed all (Domestic & Import) engine manufacturers warranties. Exceeds JASO, ISO, API and NMMA, for advanced generation 2 cycle lubricants.

- Ideal for oil injection systems or pre-mix applications.
- Significantly reduced aquatic toxicity to fish compared to other outboard oils on the market today.
- Reduces ring sticking, deposit formation and exhaust port blockage. Less friction allowing for easier starting.
- Formulated to improve performance and extend engine life by reducing wear on critical engine components.
- Ideal for today's high horsepower outboards that demand maximum performance.
- Excellent performance with lower quality fuels.
- Exceeds the industry standards established in 1997.
- Guaranteed and backed by our famous Sierra comprehensive warranty. (Will not void your engine manufacturer's warranty)

PREMIUM BLEND TC-W3			
Part No.	Description		
18-9500-1	Pint (12 per case) (473ml)		
18-9500-2	Quart (12 per case) (946ml)		
18-9500-2P	84 case pallet (Qt.)		
18-9500-3	Gallon (6 per case) (3.78L)		
18-9500-3P	36 case pallet (Ga.)		
18-9500-4	2.5 Gallon (2 per case) (9.46L)		
18-9500-4P	42 case pallet (2.5 Ga.)		
18-9500-7	55 Gallons (208L)		
18-9500-7P	4 - 55 Gallon drum pallet		

DIRECT INJECTION, TC-W3			
Part No.	Description	OE	OE No.
18-9530-3	Gallon (3.78L)	Mercury Optimax Yamaha HPDI BRP Ficht, DI	92-858037K01 LUB-2STRK-M1-4 764354
18-9530-3P	36 Case Pallet (Gal)		
18-9530-6	16 Gallon (61L)		
18-9530-7	55 Gallon Drum	Mercury Optimax Yamaha HPDI BRP Ficht, DI	92-858039K01 LUB-2STRK-M1-55 777228

FULL SYNTHETIC TC-W3 2-STROKE OUTBOARD			
Part No.	Description	OE	OE No.
18-9540-2	Quart (964ml)	BRP E-Tec/Universal	—
18-9540-3	Gallon (3.78L)	BRP E-Tec/Universal	764357
18-9540-3P	36 Case Pallet (Gal)		
18-9540-7	55 Gal. Drum	BRP E-Tec/Universal	777120

See OE Cross Reference Chart on Pages 982-1012

25W-50 FC-W SEMI-SYNTHETIC MARINE ENGINE OIL

25W-50 FC-W MARINE ENGINE OIL

- For use in supercharged Mercury Verado.
- Offered in liter, 4 liter and 16 gallon containers.
- Semi-Synthetic formulation for superior protection under high loads and operating stress.
- NMMA FC-W® Certified/API-SL.



SIERRA 25W-50 MARINE ENGINE OIL

Part No.	Mercury No.	Description	Case Qty.
18-9552-3	92-858084K01	4 Liter (4.2224 qt.)	6
18-9552-8	—	1 Liter (1.0556 qt.)	12
18-9552-6	—	16 Gallon (61L)	

10W-40 FC-W SEMI-SYNTHETIC MARINE ENGINE OIL

10W-40 FC-W SEMI-SYNTHETIC ENGINE OIL

- Direct Suzuki replacement oil.
- Semi-Synthetic formulation for superior protection under high loads and operating stress.
- Offered in quart, gallon, 16 gallon and 55 gallon drums.
- NMMA FC-W® Certified/API-SL.



SIERRA 10W-40 FC-W MARINE ENGINE OIL

Part No.	Suzuki No.	Description	Case Qty.
18-9551-2	990C0-10W40-1QT	Quart (946ml)	12
18-9551-3	990C0-10W40-1GL	Gallon (3.785L)	6
18-9551-6		16 Gallon (61L)	
18-9551-7		55 Gallon (208L)	

15W-40 DIESEL ENGINE OIL

15W-40 DIESEL ENGINE OIL

- Meets the following manufactures specifications: Volvo VDS-3; Cummins CES20078, CES20077, CES20076; Detroit Diesel DDC93D214; CAT ECF-2, ECF-1; Global DHD-1.
- Increased detergency to fight soot and carbon deposits.
- Certified to API CI-4+ Rating. Meets the highest standards of diesel oil in the marine industry.



15W-40 DIESEL ENGINE OIL

Part No.	Mercury No.	Volvo No.	Description	Case Qty.
18-9553-2	—	40005011	Quart (946ml)	12
18-9553-3	—	40005012	Gallon (3.785L)	6
18-9553-5	—	40005013	5 Gallon (18.95L)	
18-9553-6	—	—	16 Gallon (61L)	
18-9553-7	—	40005014	55 Gallon (208L)	

See OE Cross Reference Chart on Pages 982-1012

10W-30 FC-W 4 STROKE MARINE OUTBOARD ENGINE OIL

10W-30 4 STROKE MARINE OUTBOARD ENGINE OIL is a highly refined petroleum product formulated with premium base stock and highly refined additives. Specifically formulated to meet or exceed the tough requirements of the Marine 4-Stroke motor manufacturers, Mercury, Yamaha, Johnson-Evinrude, Suzuki and Honda.

- Excellent anti-wear characteristics
- Reduces friction
- Formulated to offer maximum corrosion protection
- Reduces sludge keeps engine cleaner for better efficiency
- Low temperature viscosity offers better cold starting
- Meets and exceeds quality performance API SJ, CF-2, CH-4, NMMA FC-W® Certified

SIERRA 10W30 4 STROKE MARINE OUTBOARD ENGINE OIL			
Part No.	Mercury No.	Description	Case Qty.
18-9420-2	92-802833Q1	Quart (946ml)	12
18-9420-3	92-802835Q1	Gallon (3.785L)	6
18-9420-7	92-802836A1	55 Gallon (208L)	



25W-40 FC-W 4 STROKE MARINE STERN DRIVE ENGINE OIL

25W-40 4 STROKE MARINE STERN DRIVE ENGINE OIL has been formulated to provide excellent lubrication and corrosion protection. Stern drive and inboard engines operate under high load and running stresses. This product is developed for the marine environment and will out perform standard 4-cycle automotive engine oils. Sierra's 25W-40 oil offers excellent detergency, anti-oxidants, antiwear, and corrosion protection. The benefits to your engine are reduced wear to the internal components, protection of internal parts from corrosion, cleaner pistons, and prevention of ring sticking. Excellent low temperature operating properties. Meets or exceeds quality performance API SJ, CF-4, CH-4. **Recommended for use in Mercruiser and OMC.**

- NMMA FC-W® Certified

SIERRA 25W40 4 STROKE MARINE STERN DRIVE ENGINE OIL			
Part No.	Mercruiser No.	Description	Case Qty.
18-9400-2	92-802837Q1	Quart (946ml)	12
18-9400-4	92-857389A1	5 Quart (4.7 L)	4
18-9400-7	92-802841A1	55 Gallon (208L)	



25W40 FC-W SYNTHETIC BLEND ENGINE OIL

This 4-cycle oil is blended with premium grade synthetic and mineral based stock combined with superior designed additives formulated for the stress endured by sterndrive and inboard engines.

- Superior corrosion protection
- Advanced lubrication for reduction of wear to internal engine components.
- Outstanding friction reduction and wear protection.
- Removes thermal breakdown under high RPM's, extreme temperatures and loads.
- Extensively tested for outstanding performance.
- NMMA FC-W® Certified/API-SL.

SYNTHETIC BLEND MERCUISER STERNDRIEVE ENGINE OIL			
Part No.	Mercruiser No.	Description	Case Qty.
18-9440-2	92-883724K01	Quart (946ml)	12
18-9440-2P	92-883724K01	84 Case Pallet (Qt.)	12
18-9440-4	92-883725K01	5 Quart (4.7 L)	4
18-9440-4P	92-883725K01	36 Case Pallet (5Qt.)	4
18-9440-7	92-858057K01	55 Gallon (208L)	



See OE Cross Reference Chart on Pages 982-1012

25W40 FC-W SYNTHETIC BLEND 4-STROKE OUTBOARD OIL

This oil is blended with premium grade synthetic and mineral based stock combined with superior designed additives formulated for the extreme rigors of the marine environment.

- Superior corrosion protection.
- Advanced lubrication for reduction of wear to internal engine components.
- Minimized piston ring deposits.
- Extensively tested for outstanding performance.
- NMMA FC-W® Certified/API-SL.



SYNTHETIC BLEND 4-STROKE OUTBOARD OIL 25W40			
Part No.	Mercury No.	Description	Case Qty.
18-9440-3	92-883723K01	4 Liter (4.2224 qt.)	6
18-9440-8	92-883722K01	1 Liter (1.0556 qt.)	12

SAE 30 FULL SYNTHETIC MARINE ENGINE OIL

A special blend of synthetic base oil and a balanced additive system that exceeds the FC-W requirements for marine engine oil.

- Recommended for gasoline and diesel inboard and sterndrive engines.
- Superior engine protection during startups, operation and storage.
- Reduces friction and wear for extended engine life.
- Longer lubrication effectiveness than mineral oils.
- Reduces oil consumption and improves fuel economy.
- API-CF/SL.



FULL SYNTHETIC ENGINE OIL SAE 30			
Part No.	Volvo No.	Description	Case Qty.
18-9410-2	3842343	1 Quart (946ml)	12
18-9410-4	3842344*	5 Quarts (4.7L)	4
18-9410-7	3858061	55 Gallon (208L)	

* Convenient 5 qt Container

SYNTHETIC OIL 10W30 FC-W

Formulated specifically for 4-stroke outboard and sterndrive engine technology. A special blend of synthetic base oil and a balanced additive system that exceeds the FC-W requirements for marine engine oils. Recommended for use in both outboard and sterndrive applications. Offers faster lubrication at start up in low temperatures, excellent protection at high temperatures, and greater resistance to oxidation for lower oil consumption.

- NMMA FC-W® Certified/API-SL.



10W30 SYNTHETIC MARINE ENGINE LUBRICANT			
Part No.	Volvo No.	Description	Case Qty.
18-9690-2	—	1 Quart (946ml)	12
18-9690-3	—	1 Gallon	6

NMMA FC-W Certified for use in 4 stroke OB and stern drive applications

See OE Cross Reference Chart on Pages 982-1012

GEAR LUBE



SYNTHETIC GEAR LUBE is specifically formulated to optimize gear life by reducing friction and providing superior wear protection in severe operating conditions. The unique synthetic formulation is shear stable and resists oxidation to ensure high performance over a wide range of ambient operating temperatures.

- API GL-5/MIL-L-210E

Part No.	Volvo No.	Description	Case Qty.
18-9680-2	1141679	1 Quart (946ml)	12
18-9680-5	1141681	5 Gallon	
18-9680-7	1141682	55 Gallon	

SIERRA HI-PERFORMANCE “SYNTHETIC BLEND” LOWER UNIT GEAR LUBE

- Synthetic blended marine formulation reduces operating friction for increased performance and protection of gears, bearings and other gear case components.
- Recommended for use in high performance and high load operating conditions in both outboard and I/O lower units.
- Sierra Hi-Performance gear lube has been designed to surpass the performance of the O.E. Hi-Performance gear lubricants . . . for the finest product available demand Sierra Hi-Performance gear lube.
- GL-5 Rated

Replaces: Mercury (Quicksilver) Hi-Performance Blend
 OMC (System Matched) Ultra-HPF Blend
 Yamaha (Yamalube) LUB-GEARL-11-00

Part #	Description
18-9650-0	10 Oz. Tube (12 per case) (283.5g)
18-9650-2	Quart (12 per case) (946ml)
18-9650-2P	84 case pallet (Qt.)
18-9650-5	5 Gallons (18.95L)
18-9650-5P	36 - 5 Gallon container pallet
18-9650-7	55 Gallons (208L)
18-9650-7P	4-55 Gallon drum pallet

SIERRA PREMIUM LOWER UNIT GEAR LUBE

- Recommended for all general marine applications requiring a GL-5 class lubricant.
- Ideal for replacing all old hypoid 90 application needs.
- Formulated for use in freshwater or saltwater conditions and all standard marine applications.
- Reduces friction and protects gears, bearings and other gearcase components.

Replaces: Mercury (Quicksilver) Premium Blend
 OMC (System Matched) Hi-Vis Lubricant
 Yamaha (Yamalube) LUB-GEARL-11-04

Part #	Description
18-9600-0	10 Oz. Tube (12 per case) (283.5g)
18-9600-9	Kit Contains: (1) 18-9786 and (2) 18-9600-0
18-9600-2	Quart (12 per case) (946ml)
18-9600-2P	84 case pallet (Qt.)
18-9600-5	5 Gallons (18.95L)
18-9600-5P	36 - 5 Gallon container pallet
18-9600-7	55 Gallons (208L)
18-9600-7P	4 - 55 Gallon drum pallet



18-9600-9 GEAR LUBE KIT

— Contains —

Part #	Description	Qty.
18-9786	Lower Unit Fill Tube	1
18-9600-0	10 oz. Tube Lower Unit Gear Lube	2

SIERRA TYPE “C” GEAR LUBE

- Formulated for older model outboards and I/O's equipped with electric shift.
- Reduces friction and protects gears, bearings and other gearcase components.

Replaces: OMC (System Matched) Premium Blend

Part #	Description
18-9620-0	10 Oz. Tube (12 per case) (283.5g)
18-9620-2	Quart (12 per case) (946ml)
18-9620-2P	84 case pallet (Qt.)
18-9620-5	5 Gallons (18.95L)
18-9620-5P	36 - 5 Gallon container pallet

ENGINE CARE PRODUCTS

18-9730-1 LITHIUM SPRAY GREASE (WHITE) 12 Oz. (340g)

- Multi-purpose spray lubricant for Marine applications
- Ideal for lubricating shift components and miscellaneous applications where a light grease lubricant is required
- Water and heat resistant
- Prevents corrosion



PREMIUM MARINE BEARING GREASE

- Specifically formulated for marine applications
- Premium lithium formulation for optimum corrosion protection in freshwater and saltwater applications
- Ideal for marine trailer wheel bearing, universal joints, and outdrive pivot joints

Part No.	Description
18-9710-0	10 Oz. Tube (283.5g) (12 per case)
18-9710-1	15 Oz. Cartridge (397g) (10 per case)
18-9700-2*	3 Oz. (85.05g) Cartridge (Pkg. of 2)
18-9700-4*	3 Oz. (85.05g) Cartridge (Pkg. of 4)

Display Packaged



18-9200 SPLINE GREASE

Replaces: Mercury 92-81639A4
 Specialty grease used in the assembly of engine yokes and couplers



MARINE RUST REMOVER
18-9068 18-9069
(1 Gallon) (5 Gallons)
(3.785L) (18.95L)



- Non-toxic, environmentally safe water based rust remover.
- Restores metals to like new condition.
- Will not harm metals, rubber, plastic, PVC, Viton, most paints and un-rusted steel.

FOGGING OIL
18-9550-0 18-9550-3
(12 Oz.) (1 Gallon)
(340g) (3.78L)
 (12 per case) (6 per case)



- Protects internal engine components from rust and corrosion
- Specifically formulated for seasonal storage of outboard and sterndrive engines
- Ideal for all 2-cycle and 4-cycle engines
- Sierra engine storage oil provides a protective chemical film over surface without leaving a greasy residue or a smoky discharge

GASOLINE PERFORMANCE ADDITIVE FUEL STABILIZER AND STABILIZER

- Promotes quick starting
- Keeps carburetor and fuel system clean
- Reduces gum and varnish build up
- Improves engine performance
- Stabilizes gasoline without ethanol up to 24 months[Ⓛ]
- 1/4 oz. per gallon for everyday use or 1/2 oz. for storage

- 18-9013**
8 oz. (237 ml.)
- 18-9065**
16 oz. (473 ml.)
- 18-9024**
32 oz. (946 ml.)
Replaces:
Mercury 92-817529A12, 92-78383A12,
OMC 174275, 175068, 775613
- 18-9080**
Universal (1 gal. 6 per case)



18-9493 eGuard Counter Display

- Double sided header provides specific information for "In-Season" and "Off-Season" use.
- Compact size, saves counter space.
- Holds twelve 8oz. eGuard bottles.

[Ⓛ] Stabilization for gasoline containing ethanol will vary.

eGuard — ETHANOL TREATMENT

- Stabilizes E10 gasoline for up to 12 months.
- Prevents fuel system corrosion from water attracted by E10 fuels.
- Cleans fuel system and improves performance.
- Contains a non-alcohol water remover that helps to reduce the chance of phase separation.
- Bottled in easy to use precision measuring package.
- Safe for use in all gasoline powered engines including generators and outdoor power equipment.
- Safe for use in both 2-cycle and 4-cycle engines.
- Prevents gum and varnish formation for optimum performance and quick starts.

- 18-9775**
8 oz.
- 18-9776**
1 quart
- 18-9777**
1 gallon



- 18-9751-0**
8 FL. OZ (237 mL)
- 18-9751-2**
1 QT. (946 mL)
- POWER TRIM & STEERING FLUID**

18-9750-0 POWER TRIM & TILT FLUID
10 Oz. (283.5g)

- (12 per case)
- Formulated for high operating pressure
 - Anti-foam additives assure uniform flow with reduced air contamination in hydraulic systems
 - Designed for heavy duty use at high operating pressures in applications subject to varied temperature ranges
 - Provides proper lubrication and corrosion protection for internal hydraulic components



18-9570-0 CARBON FREE AEROSOL
12 oz. Aerosol (340g)

- Specially designed to improve engine performance and efficiency
- Thoroughly removes gum, varnish and carbon deposits
 - Cleans intake ports, valves, pistons and combustion chambers
 - Frees sticky rings
 - Designed for regular maintenance of 2 and 4 cycle engines



18-9580-3 COMBUSTION CLEAN
12 oz. (340g)

- Formulated to improve engine performance and efficiency
- Dissolves gum and varnish from fuel system
 - Removes internal carbon deposits
 - Frees sticky rings
 - Displaces moisture
 - Stabilizes fuel during storage
 - Designed for use in 2 and 4 cycle marine engines



18-52104 OIL EXTRACTOR

- For Quick, Easy & Clean Oil Changes**
- This 8.8 Liter (2.3 Gallon) capacity air operated extractor can be used to remove a wide range of fluids, such as engine oil, brake fluid, antifreeze and more
 - Built-in shut-off valve to prevent overfilling
 - This unit can be used away from the air source by creating a vacuum, closing off both shut-off valves, then take to where it's needed
 - Comes complete with 5 feet of flexible hose, two rigid dipstick tubes, and a brake bleeding kit



18-52204 OIL EXTRACTOR

- For Quick, Easy & Clean Oil Changes**
- Large 8.8 Liter (2.3 Gallon) capacity not only can extract fluids, but is capable of dispensing too! Simply move the bi-directional valve and this unit will create a vacuum or move the valve the other direction and it creates pressure to dispense the fluid.
 - Built-in shut-off valve to prevent overfilling
 - Comes complete with 5 feet of flexible hose and two rigid dipstick tubes





**18-3597
BILGE PUMP KIT**
Includes: 400 GPH bilge pump,
10 ft. of 3/4" bilge hose, 2 hose
clamps and through hull fittings.



**18-9778
OIL FILTER WRENCH**
Size: 2-7/16" thru 3"
Fits small outboard filters



**18-9789
OIL FILTER WRENCH**
Size: 2-9/16" thru 3-1/4"



**18-9790
OIL FILTER WRENCH**
Size: 3-5/16" thru 3-3/4"



**18-9780
FLEX FILL SPOUT**
Pouring device for quart bottles



**18-9781
OIL PUMP**
• Ideal for "do-it-yourself" owners
• Quart size application is perfect for
most marine drives
• Includes lube fitting for domestic lower
units with flexible fill line



LOWER UNIT FILL TUBE
18-9786 **18-9787**
(Standard) **(Import)**

- Flush & fill tool for small gearcases
requiring the 10 ounce tube package
- Ideal for "do-it-yourself" in home
maintenance
- Includes appropriate lower unit fitting
for specific applications



**18-9794
GEAR LUBE ADAPTER**
For: Nissan, Yamaha, Honda, Tohatsu
For use with Sierra quart pumps
or lower unit fill tubes



**18-9795
GEAR LUBE ADAPTER**
For: Suzuki lower unit
For use with Sierra quart pumps
or lower unit fill tubes



**18-9784
BARREL PUMP**
For: 16 thru 55 gallon drum



**18-9788
LUBE PUMP**
5 Gallon (18.95L)
For filling lower units on outboards and stern drives.
Designed for use with our 18-9600-5, 18-9620-5
and 18-9650-5



GREASE GUNS
18-9782 **18-9783***
14 Oz. **3 Oz.**
Heavy duty all steel construction for dependable,
long service life.
* Display Packaged



**18-9804
GREASE GUN**
• Designed for hand operated or pneumatic grease guns
• Ideal for hard to reach grease fittings
• 12 inch length
• Heavy duty with flex hose



**18-9785
EASY LUBER**
• Ideal for quick and easy lube jobs using squeeze
tubes
• Compact size, perfect for under seat and tackle
box storage
• Use with all 10 oz. grease tubes



**18-0116
GASKET MATERIAL**
Synthaseal non-asbestos: Excellent oil resistance:
Designed to seal rough surfaces: Will withstand 350° F.



18-9031
BELLOWS ADHESIVE
 Replaces: Mercury 92-86166
 2 Fluid oz.



37643
THREADLOCKER
 Medium Strength



37701
THREADLOCKER
 High Strength



38653
LOCTITE®
THREADLOCKER
Removable
 Low Strength
 6 ml.
 Replaces: OMC 384848
 Color: Purple
APPLICATION:
 For 1/4" or smaller fasteners. Armature screws, float chamber screws, leaf valve screws, jet screws. A medium strength threadlocker that seals against leakage and can be disassembled with ordinary tools.



37477
LOCTITE®
THREADLOCKER
Removable 36 ml.
 Replaces:
 OMC 500421
 Color: Blue
APPLICATION:
 Ignition component screws, fuel pump screws. Prevents loosening due to shock and vibration. Prevents rust lock.



37478
LOCTITE®
THREADLOCKER
Permanent
 Heavy Duty -36 ml.
 Replaces:
 Mercury 92-809819
 OMC 388517, 500422
 Color: Red
APPLICATION:
 For use on U-Joints, grease extension tubes, etc. High strength threadlocker is for use on fasteners which are normally not removed for service. (May need to heat to 400°F (204°C) to remove)



37479
LOCTITE®
THREADLOCKER
Permanent
 High Strength 36 ml.
 Replaces: OMC 500423
 Mercury 92-809820
 Color: Red
APPLICATION:
 High strength, permanent threadlocker for heavy duty applications. (MASTER PACK 10)



37509
LOCTITE®
KLEAN 'N PRIME™
 4.5 oz.
 Replaces: Mercury
 92-59327-1
 OMC 384884
 Color: Green
APPLICATION:
 Cleans parts, activates surfaces and speeds cure. For use with Threadlockers, Bearing Mount, High Strength Retaining Compound, Gasket Maker and Pipe Sealant with Teflon.



22423
LOCTITE® FLANGE
SEALANT KIT
 Replaces:
 Mercury Master Gasket
 92-12564-1, 92-12564 2
 OMC 324073, 327361
 Yamaha 90790-74001-00
 Color: Red
 Used to make, coat or repair gaskets in minutes. Can be used in place of cut gaskets.



22355
ODC FREE CLEANER
 12 oz.
 Replaces: OMC 390905
 Color: Clear
APPLICATION:
 Clean parts before reassembly. Removes dirt, oil and solvent. Leaves no residue. Solvent is non-flammable and low-toxicity. Cold degreaser.



79040
LOCTITE® CHISEL™
GASKET REMOVER
 18 oz.
 Replaces: OMC Gasket
 Remover 390928
 Color: Milky White/Clear
APPLICATION:
 Remove old gaskets, paint and grime with Gasket Remover. Strips off hard carbon deposits. Eliminates harsh scraping that may damage a flange surface.



37467
LOCTITE® ULTRA
BLACK SILICONE
 80 ml. Tube
 Color: Black
APPLICATION:
 Seal, caulk and insulate electrical connections. Best general purpose sealant for sealing flanges, valve covers and flexible joints. Operating temperature to 400°F (204°C).



37394
LOCTITE®
GASKET MAKER
 50 ml.
 Color: Red
APPLICATION: Gel sealant can be used in place of cut gaskets to seal cylinder block to crankcase half on many current Outboard, Inboard and I/O models. Used to make, coat or repair gaskets in minutes.



1525607
LOCTITE®
GASKET SEALANT
 16 fluid oz.
 Replaces: Mercury 92-802881A 1,
 92-34227 1 (Perfect Seal)
 OMC 317201, 508235
 (Gasket Sealing Compound)
 A slow drying, non-hardening brush-top sealant. Gasoline, oil and grease resistant.



37566
LOCTITE®
ANTI-SEIZE™
 1 lb. can w/brush
 Color: Gray
APPLICATION: Use on mechanical joints and external moving parts such as starter bushings, prop shaft splines and battery terminals. Dresses exhaust gaskets. Coats and protects metal parts. Lubricates threads, gears, chains, cables, pulleys, rollers and pivots to temperatures up to 1600°F. (871°C) Heavy-duty, temperature resistant compound fortified with graphite and metallic flake. Will not evaporate or harden.



**56507
LOCTITE® PIPE SEALANT**

Replaces: OMC 910048
Color: White
APPLICATION:
Seals steering line connectors. Helps prevent loss of hydraulic fluids, fuels, water, gas or air. Use on fittings, valves and plugs.
PST 6ML with Teflon®



**37534
LOCTITE® DIELECTRIC GREASE**

9.76 ml
Replaces: Mercruiser 92-41669-1, 92-823506 1
Color: Clear
APPLICATION: Protects ignition and electrical connectors, distributor caps, spark plug boots and boat trailer electrical connections against salt, dirt and corrosion.

FAST ORANGE® HAND CLEANER



**18-9020
1 Gal. Pump
PUMICE**

**18-9023
1 Gal. Pump
SMOOTH**

Color: White
APPLICATION: A natural waterless hand cleaner that leaves hands with a clean orange scent. Quickly removes grime and grease. Biodegradable.



**18-9125
OETIKER CLAMP KIT**

Replaces: Johnson Evinrude 787133, 787145

Part #	Johnson Evinrude #	Oetiker #	Description	
18-9141	787145	14100082	Oetiker Jaw Pincers	
Nominal OD				
Part #	Johnson Evinrude #	Oetiker #	Inches	mm
18-9126-9	346930	16700004	3/8"	9.5
18-9127-9	348838	16700006	13/32"	10.5
18-9128-9	349516	16700007	7/16"	11.3
18-9129-9	347107	16700010	1/2"	13.3
18-9130-9	347108	16700011	17/32"	13.8
18-9131-9	346931	16700012	35/64"	14
18-9132-9	346785	16700013	9/16"	14.5
18-9133-9	346786	16700016	5/8"	15.7
18-9134-9	348839	16700017	11/16"	17
18-9135-9	346151	16700024	1 3/16"	21
18-9136-9	346152	16700031	1"	25.6
18-9137-9	346153	16700037	13/16"	30.1
18-9138-9	349759	16700040	1 1/4"	31.6
18-9139-9	349729	16700053	1 5/8"	41
18-9140-9	346150	16700020	22/32"	18.5

All clamps are standard package of 10. Each package of 10 is available individually.



**18-9145
OETIKER CLAMP KIT**

Replaces: Yamaha YB-6AW04-A

Fits: All F115-F350 and HPDI Models. Kit includes 18-9146-9 replaces: Yamaha YB-6AW04-3 19.8 mm clamp and 18-9133-9 replaces: Yamaha YB-6AW04-1 15.7 mm clamp. Package of 10, available individually.



**18-8997
DUAL FEED FLUSH - ROUND CUPS**

Universal
Fits most engines up to 115 H.P.



**18-8998
ENGINE FLUSHER - RECTANGULAR CUPS**

Universal
Fits most engines 120 H.P. and UP



**18-8999
DUAL FEED FLUSH - RECTANGULAR CUPS**

Universal
Fits most engines 120 H.P. and UP



**18-9009
INBOARD FLUSHER**

Universal
Fits most inboard engines

**18-9010
MOTOR FLUSHER**
Replaces: Mercury 73971A2, 44357A2, 44357Q2 (Heavy Duty)

- High quality EPDM rubber cups
- Corrosion resistant dicromate finish
- Installs in seconds
- Use with a standard garden hose
- Hose connector complete with rubber washer
- No tools required

Flushes cooling system of salts and sediments and allows engine to idle for tuning and engine adjustment in your own driveway. Simply slip attachment over the engine's side water intakes. Coated spring steel arms clamp suction cup securely over the engine's side water intakes.





**18-9876
SHIM GAUGE BAR**
Replaces: 349957
For: 40 HP, V-8 with thru hub exhaust



**18-9806E
SHIFT CABLE TOOL**
Replaces: Mercury Marine 91-12037
Description: Installs and removes shift cables on MC-I, R-MR, Alpha One, Alpha One/Gen II drive units. Use with 18-2190 and 18-2190E cables.



**18-9807
SHIFT CABLE ADJUSTMENT TOOL**
Replaces: Mercury Marine 91-12427
Description: Attaches over the shift cable, used for proper Bravo drive unit shift cable adjustment at the shift plate.



**18-9874
DRIVE SHAFT PRELOAD TOOL**
Replaces: Mercury Marine 91-14311A2
Description: Preloads drive shaft bearing when checking pinion height and backlash on MC-I, R-MR, Alpha One, Alpha One/Gen II drive units and outboards.



**18-9808
NEEDLE BEARING DRIVER**
Replaces: Mercury Marine 91-15755T
Description: Installs needle bearings in MC-I, R-MR, Alpha One, and Alpha One/Gen II bearing carriers



**18-9803
SPANNER NUT WRENCH**
Replaces: Mercury Marine 91-17256
Description: Removes and installs driveshaft bearing retainer on MC-I, R-MR, Blackhawk, all Bravo and all Alpha drive units.



**18-9809
BEARING CARRIER RETAINER TOOL**
Replaces: Mercury Marine 91-17257
Description: Loosens and tightens bearing carrier retainer on Bravo Two drives.



**18-9810
SHIFT CABLE ANCHOR
ADJUSTMENT TOOL**
Replaces: Mercury Marine 91-17262A1
Description: Used to install shift cable core wire on all Bravo drive units.



**18-9812
BEARING & SEAL
INSTALLATION TOOL**
Replaces: Mercury Marine 91-17275A1
Description: Installs shifter shaft bushings on all Bravo drive units.



**18-9813
SHIFT HANDLE TOOL**
Replaces: Mercury Marine 91-17302
Description: Positions and removes shifter shaft on all Bravo drive units.



**18-9814
PLATE/PULLER BAR**
Replaces: Mercury Marine 91-29310
Description: Used as a guide to remove and install gimbal bearing on MC-I, R-MR, Alpha One, Blackhawk and all Bravo drives.



**18-9817
SHIFT SHAFT BUSHING TOOL**
Replaces: Mercury Marine 91-31107T
Description: Removes and installs the shift shaft bushing in the gear case of MC-I, R-MR and Alpha One drive units and outboards.



**18-9818
OIL SEAL DRIVER**
Replaces: Mercury Marine 91-31108T
Description: Installs oil seals in the bearing carrier of MC-I, R-MR, Alpha One drive units and outboards.



**18-9821
DRIVER HEAD**
Replaces: Mercury Marine 91-32325T
Description: Installs gimbal bearing in MC-I, R-MR, Alpha One, Alpha One/Gen II, Blackhawk and all Bravo drive units.

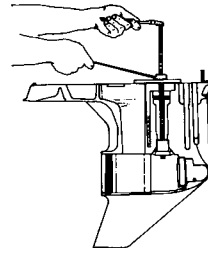

**18-9820
INSTALLATION TOOL KIT**
Replaces: Mercury Marine 91-31229A7
Description: removes and installs bearings in MC-I, R-MR, Alpha One, Alpha One Gen II and all Bravo gear cases.

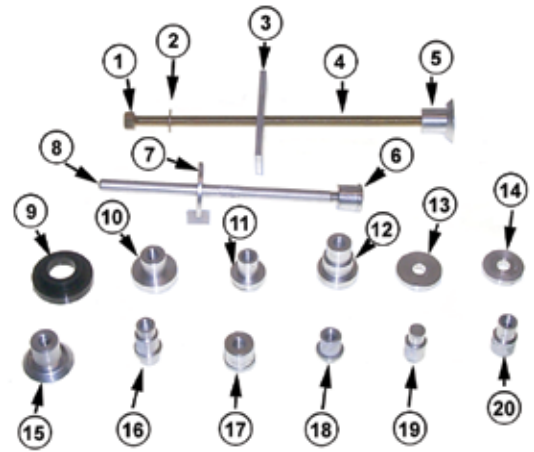

— CONTAINS —



**18-9823
DRIVER HEAD**
Replaces: Mercury Marine 91-33489
Description: Installs the small roller bearing in the gimbal housing of MC-I, R-MR and Alpha One drive units.

Part #	O.E. #	Description	Part #	O.E. #	Description
1	NSS 11-24156	Puller Nut	11	18-9837 91-38628T	Puller/Driver Head
2	NSS 12-34961	Puller Washer	12	18-9808 91-15755T	Needle Bearing Driver
3	18-9814 91-29310	Puller Plate	13	18-9830 91-36571T	Pilot Washer
4	18-9819 91-31229	Puller Shaft	14	18-9836 91-37350	Washer
5	18-9821 91-32325T	Driver Head	15	18-9849 91-52394	Bearing Puller
6	18-9848 91-52393	Driver	16	18-9832 91-37292	Bearing Puller
7	18-9815 91-37324	Pilot Plate	17	18-9822 91-32336	Driver Head
8	18-9835 91-37323	Driver Rod	18	18-9829 91-36569T	Driver Head
9	18-9816 91-30366T1	Mandrel	19	18-9833 91-37311	Driver Head
10	18-9828 91-36379	Driver Head	20	18-9834 91-37312	Driver Head



**18-9824
DRIVER HEAD**
Replaces: Mercury Marine 91-33491
Description: Installs needle bearing in forward gear and removes and installs seals and bearing in gimbal housing of MC-I, R-MR and Alpha One drive units.



**18-9825
DRIVER HEAD**
Replaces: Mercury Marine 91-33492T
Description: Removes and installs lower swivel pin needle bearing in gimbal ring on MC-I, R-MR and Alpha One drive units.



**18-9826
BEARING CUP DRIVER**
Replaces: Mercury Marine 91-33493T
Description: Installs upper drive shaft bearing cup in drive shaft housing of MC-I, R-MR and Alpha One drive units.



**18-9827
BEARING CUP DRIVER**
Replaces: Mercury Marine 91-34379T
Description: Installs drive shaft bearing cup in gear housing of MC-I, R-MR, Alpha One drive units and outboards.



**18-9829
DRIVER HEAD**
Replaces: Mercury Marine 91-36569
Description: Removes pinion bearing from MC-I, R-MR and Alpha One drive units.



**18-9830
PILOT WASHER**
Replaces: Mercury Marine 91-36571
Description: Used as a guide to install pinion bearing in MC-I, R-MR and Alpha One drive units.



**18-9831
BEARING CUP DRIVER**
Replaces: Mercury Marine 91-36577
Description: Installs forward gear bearing cup in gear housing of MC-I, R-MR and Alpha One drive units.



**18-9835
DRIVER ROD**
Replaces: Mercury Marine 91-37323
Description: Used with various drivers to install bearings on Alpha One, Gen II and Bravo One and Two gear cases.



**18-9837
PULLER/DRIVER HEAD**
Replaces: Mercury Marine 91-38628T
Description: Installs pinion bearing on MC-I, R-MR and Alpha One drive units.



**18-9838
U-JOINT ADAPTER**
Replaces: Mercury Marine 91-38756
Description: Supports yoke when disassembling u-joint on all drive units.



**18-9839
BEARING CUP DRIVER**
Replaces: Mercury Marine 91-38918T
Description: Installs bearing cup in top cover of drive shaft housing of MC-I, R-MR, Alpha One drive units and outboards.



**18-9840
PULLER**
Replaces: Mercury Marine 91-38919
Description: Removes swivel pins from R-MR and Alpha One gimbal rings.



**18-9841
DRIVE SHAFT SHIMMING TOOL**
Replaces: Mercury Marine 91-42840T
Description: Shims pinion gear on Bravo One drives.



**18-9842
DRIVE SHAFT RETAINER WRENCH**
Replaces: Mercury Marine 91-43506T
Description: Removes and installs threaded bearing retainer on Alpha stern drives and outboards.



**18-9843
CLAMP PLATE**
Replaces: Mercury Marine 91-43559
Description: Holds preload while checking backlash and bearing preload on Bravo One and Two drive units.



**18-9864
INSTALLER ASSEMBLY**
Replaces: Mercury Marine 91-43578A1
Description: Installs Bravo transom assembly bushings, bearings and seals.



**18-9844
TAPERED INSERT TOOL**
Replaces: Mercury Marine 91-43579
Description: Installs tapered insert retainer into water inlet hose on all Bravo drive units.



**18-9845
SEAL DRIVER**
Replaces: Mercury Marine 91-43591T
Description: Installs upper drive shaft oil seal on Alpha One and Alpha One/Gen II drive units.



**18-9846
SEAL DRIVER**
Replaces: Mercury Marine 91-44110
Description: Installs oil seals in water pump base on Alpha One and Alpha One/Gen II drive units and outboards.



**18-9847
BELLOWS EXPANDER TOOL**
Replaces: Mercury Marine 91-45497A1
Description: Installs exhaust bellows on MC-I, R-MR, Alpha One, Bravo One and Two and Blackhawk drive units.



**18-9850
BACKLASH INDICATOR**
Replaces: Mercury Marine 91-53459
Description: Checks gear backlash on TR, TRS, MC-I, R-MR, Alpha One, Alpha One/Gen II and Bravo One and Two drive units.



**18-9851
OIL SEAL DRIVER**
Replaces: Mercury Marine 91-55916
Description: Installs oil seals in TR and Bravo One and Two drive unit bearing carrier.



**18-9852
BEARING DRIVER**
Replaces: Mercury Marine 91-55918
Description: Installs needle bearings in Bravo One and Two and TR drive unit bearing carrier.



**18-9853
PINION GEAR SHIMMING TOOL**
Replaces: Mercury Marine 91-56048T, 91-56048001
Description: Measures pinion height of MC-I, R-MR, Alpha One and Alpha One/Gen II drive units.

 <p>18-9854 DRIVE SHAFT ADAPTER Replaces: Mercury Marine 91-56775T Description: Provides a wrench surface to turn the drive shaft on MC-I, R-MR, Alpha One, Alpha One/Gen II drive units and outboards.</p>	 <p>18-9855 DRIVEN GEAR SHIMMING TOOL Replaces: Mercury Marine 91-60523 Description: Measures upper drive gear clearance on MC-I, R-MR, Alpha One and Alpha One/Gen II drive units.</p>	 <p>18-9856 DRIVE GEAR SHIMMING TOOL Replaces: Mercury Marine 91-60526T Description: Measures upper drive gear clearance on MC-I, R-MR, Alpha One, Alpha One/Gen II drive units.</p>
 <p>18-9857 PINION NUT ADAPTER Replaces: Mercury Marine 91-61067A3 Description: Holds pinion nut when removing pinion gear and drive shaft on MC-I, R-MR, Alpha One drive units and outboards.</p>	 <p>18-9858 BEARING CARRIER RETAINER WRENCH Replaces: Mercury Marine 91-61069T Description: Removes and installs bearing carrier retainer nuts on Bravo One and Two, MC-I, R-MR, Alpha One, Alpha One/Gen II, TRS drive units and outboards.</p>	 <p>18-9868 DRIVE SHAFT ADAPTER Replaces: Mercury Marine 91-61077 Description: Provides a wrench surface to turn the propeller shaft on MC-I, R-MR, Alpha One, Alpha One/Gen II, Bravo One and TRS drive units.</p>
 <p>18-9859 PULLER Replaces: Mercury Marine 91-63616 Description: Removes upper swivel shaft on MC-I, R-MR, Alpha One, Alpha One/Gen II, Bravo One, Two and Three and Blackhawk gimbal rings.</p>	 <p>18-9860 BEARING DRIVER Replaces: Mercury Marine 91-63638T Description: Removes and installs lower drive shaft pinion bearing on TR and Bravo One and Two drive units.</p>	 <p>18-9861 HINGE PIN TOOL Replaces: Mercury Marine 91-78310 Description: Removes and installs hinge pins from all Mercury Marine drive units.</p>
 <p>18-9869 UPPER DRIVE SHAFT HOUSING SEAL DRIVER Replaces: Mercury Marine 91-817570T Description: Installs seals in Alpha One/Gen II upper drive shaft housing.</p>	 <p>18-9870 SLEEVE INSTALLATION TOOL Replaces: Mercury Marine 91-818162 Description: Installs the aluminum sleeve in the u-joint bellows of all Bravo, Alpha One/Gen II, Blackhawk drive units and outboards.</p>	 <p>18-9871 SLEEVE REMOVAL TOOL Replaces: Mercury Marine 91-818169T Description: Removes the aluminum sleeve from the u-joint bellows of all Bravo, Alpha One/Gen II and Blackhawk drive units.</p>
 <p>18-9872 PUMP ALIGNMENT TOOLS Replaces: Mercury Marine 91-821571A1 Description: Aligns Alpha One/Gen II water pump during installation.</p>	 <p>18-9863 BEARING DRIVER Replaces: Mercury Marine 91-89865 Description: Installs bearing carrier seals on Bravo One and Two drive units.</p>	 <p>18-9866 DIAL INDICATOR HOLDING TOOL Replaces: Mercury Marine 91-89897 Description: Secures dial indicator to gear housing when checking backlash on MC-I, R-MR, Alpha One, TR, TRS drive units and outboards.</p>



18-9865
DRIVE SHAFT BEARING TOOL
 Replaces: Mercury Marine 91-90774
 Description: Presses bearing cone onto Alpha One/Gen II drive shaft housing pinion gear.



18-9875
PULLER ASSEMBLY
 Replaces: Mercury Marine 91-90244A1
 Description: Removes and installs drive shaft housing bearings and sleeves on all Bravo drive units.



18-9800
COMPRESSION TESTER
 Description: Perfect for hard to reach bottom spark plug holes on older Mercury models.



18-9801
MULTI METER/DVA TESTER
 Replaces: Mercury Marine 91-99750A1
 Description: Tests electrical and ignition systems. Consists of a VOA meter with built-in direct voltage adapter.



18-9802
TIMING LIGHT
 Replaces: Mercury Marine 91-99379
 Description: Checks ignition timing. Powered by two "D" cell batteries, portable.



18-4442
ENGINE ALIGNMENT TOOL
 Description: Used to verify engine alignment on all MC-I, R-MR, Alpha One and Alpha One/Gen II.



18-9849
BEARING PULLER
 Replaces: Mercury Marine 91-52394
 Description: Removes and installs bearings in MC-I, R-MR, Alpha One, Alpha One/Gen II, all Bravo and outboard gear cases.



18-9862
BEARING DRIVER
 Replaces: Mercury Marine 91-87119
 Description: Installs driveshaft bearing onto driveshaft.



18-9873
BEARING DRIVER
 Replaces: Mercury Marine 91-813653
 Description: Installs u-joint oil seal into bearing carrier, also used to pilot the puller rod for gear housing needle bearing installation on Bravo One and Two drive units.



18-9815
PILOT PLATE
 Replaces: Mercury Marine 91-37324
 Description: Removes and installs bearings in MC-I, R-MR, Alpha One, Alpha One/Gen II, all Bravo and outboard gear cases.



18-9816
MANDREL
 Replaces: Mercury Marine 91-30366T1
 Description: Removes and installs bearings in MC-I, R-MR, Alpha One, Alpha One/Gen II, all Bravo and outboard gear cases.



18-9819
PULLER SHAFT
 Replaces: Mercury Marine 91-31229
 Description: Removes and installs bearings in MC-I, R-MR, Alpha One, Alpha One/Gen II, all Bravo and outboard gear cases.



18-9822
DRIVER HEAD
 Replaces: Mercury Marine 91-32336
 Description: Removes and installs bearings in MC-I, R-MR, Alpha One, Alpha One/Gen II, all Bravo and outboard gear cases.



18-9828
DRIVER HEAD
 Replaces: Mercury Marine 91-36379
 Description: Removes and installs bearings in MC-I, R-MR, Alpha One, Alpha One/Gen II, all Bravo and outboard gear cases.



18-9832
BEARING PULLER
 Replaces: Mercury Marine 91-37292
 Description: Removes and installs bearings in MC-I, R-MR, Alpha One, Alpha One/Gen II, all Bravo and outboard gear cases.



**18-9833
DRIVER HEAD**
Replaces: Mercury Marine 91-37311
Description: Removes and installs bearings in MC-I, R-MR, Alpha One, Alpha One/Gen II, all Bravo and outboard gear cases.



**18-9834
DRIVER HEAD**
Replaces: Mercury Marine 91-37312
Description: Removes and installs bearings in MC-I, R-MR, Alpha One, Alpha One/Gen II, all Bravo and outboard gear cases.



**18-9848
DRIVER**
Replaces: Mercury Marine 91-52393
Description: Removes and installs bearings in MC-I, R-MR, Alpha One, Alpha One/Gen II, all Bravo and outboard gear cases.

**18-9880
COMPLETE TOOL PACKAGE**

Part #	O.E. #	Description	Part #	O.E. #	Description
18-9806	91-12037	Shift Cable Tool	18-9846	91-44110	Seal Driver
18-9807	91-12427	Shift Cable Adjustment Tool	18-9847	91-45497A1	Bellows Expander Tool
18-9874	91-14311A2	Drive Shaft Preload Tool	18-9850	91-53459	Backlash Indicator Rod
18-9803	91-17256	Bearing Retainer Wrench	18-9851	91-55916	Oil Seal Driver
18-9809	91-17257	Bearing Carrier Retainer Tool	18-9852	91-55918	Bearing Driver
18-9810	91-17262A1	Shift Cable Anchor Adjustment Tool	18-9853	91-56048	Pinion Gear Shimming Tool
18-9812	91-17275A1	Bearing And Seal Installation Tool	18-9854	91-56775	Drive Shaft Adapter
18-9813	91-17302	Shift Handle Tool	18-9855	91-60523	Shimming Tool-Drive Gear
18-9817	91-31107	Shift Shaft Bushing Tool	18-9856	91-60526	Shimming Tool-Drive Gear
18-9818	91-31108	Oil Seal Driver	18-9857	91-61067A3	Pinion Nut Adapter
18-9820 ①	91-31229A7	Bearing Removal And Installation Tool Assembly	18-9858	91-61069	Bearing Carrier Retainer Wrench
18-9823	91-33489	Bearing Driver	18-9868	91-61077	Propeller Shaft Adapter
18-9824	91-33491	Needle Bearing Driver	18-9859	91-63616	Puller Head
18-9825	91-33492	Bearing Cup Driver	18-9860	91-63638	Bearing Driver
18-9826	91-33493	Bearing Cup Driver	18-9861	91-78310	Hinge Pin Tool
18-9827	91-34379	Bearing Cup Driver	18-9869	91-817570	Upper Drive Shaft Housing Seal Driver
18-9831	91-36577	Bearing Cup Driver	18-9870	91-818162	Sleeve Installation Tool
18-9838	91-38756	U-Joint Adapter	18-9871	91-818169	Sleeve Removal Tool
18-9839	91-38918	Bearing Cup Driver	18-9872	91-821571A1	Water Pump Alignment Pins
18-9840	91-38919	Puller Head	18-9863	91-89865	Bearing Carrier Seals & Bearing Cup Driver
18-9841	91-42840	Drive Shaft Pinion Gear Shimming Tool	18-9866	91-89897	Dial Indicator Holding Tool
18-9842	91-43506	Drive Shaft Bearing Retainer Wrench	18-9865	91-90774	Drive Tool
18-9843	91-43559	Clamp Plate	18-9875	91-90244A1	Puller Drive Assembly
18-9864	91-43578A1	Bushing/Bearing/Seal Driver	18-9800		Compression Tester
18-9844	91-43579	Tapered Insert Tool	18-9801	91-99750	Multi-Meter/DVA Tester
18-9845	91-43591	Seal Driver	18-9802		Timing Light
			18-4442		Alignment Tool

① 18-9820 contents of this kit can be seen on page 140



STARTER ROPE
(200' Spools)

Part #	Desc.	Replaces:
18-4911	5/32" X 200'	OMC 322236
18-4913	3/16" X 200'	OMC 316705
18-4914	1/8" X 200'	OMC 316706



**18-4904
STARTER
HANDLE & ROPE**
#4.5 (9/64") Rope
Handle Only: 18-4901



CABLE BOOT
18-4454 For 3" Hole
18-4455 For 4 1/2" Hole

Safe-Skeg

Whether you are looking to protect your new skeg, repair your damaged one or even just add some shine. Safe-Skeg is made of 316 Marine Grade Stainless Steel Construction and installation takes minutes.

- Material Thickness: 1.5mm, 50% thicker than the competition.
- Drain Hole to protect against corrosion and freeze-up.
- Brilliantly polished with seamless design.
- Skid Plate not necessary due to extra thickness in material.



Motor	Horsepower	Stroke	Year Range	Part #
Evinrude/Johnson	150-175-185-200-225	2	1986-2003	35-SS630
Evinrude/Johnson	90-100-115-120-140	2	1980-2001	35-SS635
Evinrude/Johnson	75 & 90 (E-TEC) 150-200 DCX & DPX (E-TEC) 225-250 DPL Blue (E-TEC)	2	2002-2008 2004 & Up 2004 & Up	35-SS670
Evinrude/Johnson	60, 70, 90, 115, 140 (by Suzuki) Suzuki 90, 115, 140	4	1999-2003; 2003 & Up	35-SS680
Force Outboard	70 - 90 HP (by Mercury)	2	1998-2002	35-SS625
Force Outboard	70-75	2	1991-1997	35-SS650
Honda	135,150,200,225	4	2004 & Up	35-SS685
Mercruiser	Pre Alpha #1 Drives		1973-1984	35-SS600
Mercruiser	Alpha 1 Drives		1985-1990	35-SS605
Mercruiser	Alpha 1 Generation II Drives		1991-Present	35-SS610
Mercruiser	Bravo 1 & 3 Drives		1990-Present	35-SS615
Mercury/Mariner	225	2	1996-2004	35-SS660
Mercury/Mariner	135-150-175-200	2 & 4	1978-2005	35-SS620
Mercury	150	4	2012 & Up	35-SS715
Suzuki Outboard	150-175-200-225	2	1986-2002	35-SS645
Volvo	DP Drives 1996-2007; SX Drives 2007 & Up			35-SS655
Volvo Penta	SX Drives (Single Prop)		1995-2006	35-SS665
Yamaha	115-130 2 Stroke 115-130 4 Stroke	2 4	2003 & Up 2000 & Up	35-SS690
Yamaha Outboard	200-225-250-300	2 & 4	2003-Present	35-SS695
Yamaha Outboard	60-70-80-90-100	2 & 4	2002-Present	35-SS700
Replacement Hardware Installation Kit				35-SSKIT1



18-01000
CHRYSLER
OUTBOARDS,
ALL ENGINES
 Covers all 3.5-150 HP,
 1 to 4-cylinder models.
 1962-1984



18-01100
FORCE
OUTBOARDS,
ALL ENGINES
 Covers all 3.5-150 HP,
 1 to 5-cylinder models.
 1984-1999



18-01200
HONDA
OUTBOARDS,
ALL ENGINES
 Covers all 2-130 HP,
 1 to 4-cylinder models.
 1978-2001



18-01202
HONDA
OUTBOARDS,
1-4 CYL. & V6
 Covers all 2.0-225 HP,
 1 to 4-cylinder and V6
 Models, including Jet Drives.
 2002-2008



18-01301
JOHNSON/EVINRUDE
OUTBOARDS,
1-3 CYL. & V4
 Covers all 1.5-125 HP,
 1 to 3-cylinder models and V4
 models.
 1958-1972



18-01302
JOHNSON/EVINRUDE
OUTBOARDS,
1-2 CYL.
 Covers all 1.25-60 HP,
 1 to 2-cylinder models.
 1971-1989



18-01308
JOHNSON/EVINRUDE
OUTBOARDS,
3, 4 & 6 CYL.
 Covers all 60-235 HP,
 3-cylinder, V4 and V6
 models.
 1973-1991



18-01311
JOHNSON/EVINRUDE
OUTBOARDS,
ALL V-ENGINES
 Covers all 65-300 HP,
 V4, V6 and V8 engines,
 includes jet drives.
 1992-2001



18-01312
JOHNSON/EVINRUDE
OUTBOARDS,
ALL INLINE ENGINES
 Covers all inline engines
 1.25-70HP,
 2-stroke and 4-stroke
 models.
 1990-2001



18-01313
EVINRUDE
 Covers all engines
 2 & 4 Stroke
 2002-2012



18-01314
JOHNSON
OUTBOARDS,
2 & 4-STROKE
 Covers all engines. 2.5-250
 HP, 2-Stroke and 4-Stroke
 Models
 2002-2007



18-09202
KAWASAKI
 1992-97



18-01402
MARINER
OUTBOARDS,
3-4 & 6 CYL
 Covers all 3 and 4-cylinder,
 in-line 6 and V6 models,
 including fuel injected units.
 1977-1989



18-01404
MERCURY
OUTBOARDS,
1-2 CYL
 Covers all 2-40 HP,
 1 and 2-cylinder models.
 1965-1989



18-01406
MERCURY
OUTBOARDS,
3-4 CYL
 Covers all 40-115 HP,
 3 and 4-cylinder models.
 1965-1989



18-01408
MERCURY OUTBOARDS,
6 CYL
 Covers all 90-300 HP, in-line 6 and V6 models, including fuel injected units. Also includes MR drives.
 1965-1989



18-01416
MERCURY/MARINER OUTBOARDS,
ALL ENGINES
 Covers all 2.5-275 HP, 1 to 4-cylinder and V6, 2 stroke models. Includes jet drives.
 1990-2000



18-01418
2 STROKE MERCURY OUTBOARDS
 2.5-250 HP
 2001-2005



18-01500
NISSAN/TOHATSU OUTBOARDS
 Covers all 2.5-140 HP, 2-Stroke and 4-Stroke Engines, including EFI & TLDI.
 1992-2009



18-01600
SUZUKI OUTBOARDS,
ALL ENGINES
 Covers all 2-225 HP, 1 and 4-cylinder, V-4 and V-6 models, including fuel injection and jet drives.
 1988-2003



18-01602
SUZUKI ALL 4 STROKES
 1996-2007



18-01701
YAMAHA OUTBOARDS, ALL 2 & 4 STROKE MODELS
 Covers all 2-250 hp, 1-4 cylinder, V4 and V6 Models 2 and 4 Stroke Models, including Jet Drives. Only Seloc manuals include Skill Level Ratings (1-4 wrenches) based upon the degree of difficulty along with Special Tool icons where an OEM or electronic testing tool is required to perform the specific procedure.
 1984-1996



18-01703
YAMAHA OUTBOARDS, ALL 2 STROKE MODELS
 Covers all 2-250 HP, 1-4 Cylinder, V4 and V6 Models 2 Stroke Models, including Jet Drives. Only Seloc manuals include Skill level Ratings (1-4 wrenches) based upon the degree of difficulty along with Special Tool icons where an OEM or electronic testing tool is required to perform the specific procedure.
 1997-2003



18-03200
MERCURUISER STERN DRIVE
 Covers Type 1, Alpha/MR and Bravo I and II units powered by Ford and GM 4-cylinder, V6 and V8 engines.
 1964-1991



18-03206
MERCURUISER STERN DRIVE
 Covers all engines and drive units, including transmissions.
 1992-2001



18-03208
MERCURUISER
 Mercruiser gasoline engines including inboards, drive and transmission
 2001-06



NEW
18-01422
MERCURY & MARINER
 Covers: All 4-Stroke Engines
 2005-11



18-03400
OMC STERN DRIVE
 Covers all stern drive units powered by Ford and GM 4-cylinder, V6 and V8 engines.
 1964-1986



18-03404
OMC COBRA STERN DRIVE
 Covers all stern drive units powered by Ford and GM 4-cylinder, V6 and V8 engines.
 1985-1998



NEW
18-09400
POLARIS
 1992-97



18-09002
**SEA-DOO/
 BOMBARDIER**
 1992-97



18-09006
**SEA-DOO/
 BOMBARDIER**
 Covers: All 4-Stroke Models
 2002-11



18-03600
**VOLVO/PENTA STERN
 DRIVES**
 Covers all stern drive units
 powered by Ford, GM or
 Volvo 4-cylinder, V6 and V8
 engines.
 1968-1991



18-03602
**VOLVO/PENTA STERN
 DRIVES**
 Covers all stern drive units
 powered by Volvo 4-cylinder
 engines.
 1992-1993



18-03606
**VOLVO/PENTA STERN
 DRIVES**
 Covers all gasoline engines
 and drive systems.
 1992-2003



18-03608
VOLVO
ALL GAS ENGINES
 Fits: Volvo Sterndrives
 2003-2007



18-01707
YAMAHA
 Covers: All 4-Stroke Engines
 2005-10



18-09602
YAMAHA
 1992-97



18-09606
YAMAHA
 Covers: All 4-Stroke Models
 2002-11



18-01705
YAMAHA O/B
 Yamaha, Mercury & Mariner
 4 Stroke
 outboard engines
 Covers all 2.5-225 HP,
 1-4 cylinder, and V6
 models, including Jet
 Drives. 768 pages
 1995-04



18-07400
YANMAR INBOARDS
 Covers all QM, GM/HM JH
 and JH2 diesel models.
 1975-1998

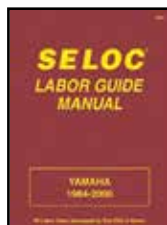

1984-2000

18-04550
LABOR MANUAL, YAMAHA
 Thousands of operations with freshwater and saltwater
 flat rate times developed from actual teardowns and time
 studies. All service operations are easily accessible by
 engine size, by year and by system. Each labor guide
 comes with an introductory section on how to better
 manage and increase profit in your service operation.

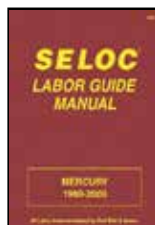

1980-2000

18-04600
LABOR MANUAL, MERCURY
 Thousands of operations with fresh-water and saltwater
 flat rate times developed from actual teardowns and time
 studies. All service operations are easily accessible by
 engine size, by year and by system. Each labor guide
 comes with an introductory section on how to better
 manage and increase profit in your service operation.



Introducing:

STATS

SIERRA TOUCH AND TEST SYSTEM

STATS is the perfect solution for performing diagnostics on your marine engine. This self contained system requires no additional computer hardware to operate and works with most popular engine brands. The console integrates an easy to use touch screen with a left/right tactile user interface to create an efficient user experience.

- ECU Identification
- Reads Fault Codes
- Clears Fault Codes
- Displays Live Data
- Performs Engine Systems Tests
- Stationary Tests
- Service Info
- Vibration Proof
- Splash Proof
- Service Reset
- Component Actuation
- Internet Software Updates
- Print & Save Service Results
- USB, PC Interface
- Number Of Hours Engine Has Run



18-SD102
STATS Diagnostic System Complete Kit
 For: Mercury/Mercuriser/MEFI, BRP, Yamaha, Suzuki



18-SD103
STATS Diagnostic System Complete Kit
 For: Mercury/Mercuriser/MEFI, BRP, Yamaha



18-SD104
STATS Diagnostic System Complete Kit
 For: Mercury/Mercuriser/MEFI, BRP, Suzuki



18-SD105
STATS Diagnostic System Complete Kit
 For: Mercury/Mercuriser/MEFI, Yamaha



18-SD106
STATS Diagnostic System Complete Kit
 For: Mercury/Mercuriser/MEFI



18-SD107
STATS Diagnostic System Complete Kit
 For: BRP



18-SD108
STATS Diagnostic System Complete Kit
 For: Yamaha



18-SD109
STATS Diagnostic System Complete Kit
 For: Suzuki



18-SD110
STATS Diagnostic System Complete Kit
 For: SeaDoo/Yamaha/Kawasaki



NEW

**18-SD118
FULL PWC PACKAGE**

Fits: Sea-Doo, Yamaha PWC, Kawasaki, Hydrospace/
Benelli/Weber PWC



NEW

**18-SD119
INBOARD/OUTBOARD PACKAGE**

For: Mercury/Mercruiser/MEFI I-IV, BRP Outboard,
Yamaha Outboard, Suzuki Outboard, Volvo Diesel,
Yanmar Diesel



NEW

**18-SD120
VOLVO D3, D4, D6 PACKAGE**



NEW

**18-SD202
Complete Kit Plus**

For: Mercury/Mercruiser/MEFI I-IV, BRP Outboard,
Yamaha Outboard, Suzuki Outboard, Volvo Diesel,
Yanmar Diesel, Sea-Doo, Yamaha PWC, Kawasaki PWC,
Hydrospace/Benelli/Weber PWC



NEW

**18-SD100
STATS KIT-- TESTER ONLY**

Tester and basic cables included (Will require purchase
of Software Upgrade kits for use)



NEW

**18-SD101
STATS Diagnostic System Complete Kit**

For: Mercury/Mercruiser/MEFI, BRP,
Yamaha, Suzuki, Seadoo, Kawasaki, Yamaha PWC.



**18-ADA500
STATS Tester (Console)**



**18-ADA501
STATS Carry Case**



**18-ADA502
STATS Tester (Console) Neoprene Case**



18-ADA503
STATS Dongle Case

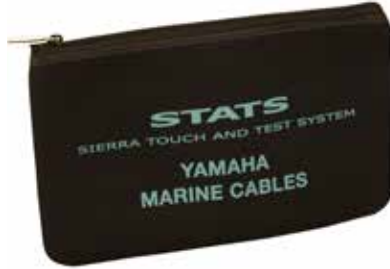

18-ADA504
STATS Yamaha Neoprene Carry Case



18-ADA505
STATS Mercury/Mercruiser/MEFI Carry Case



18-ADA506
STATS BRP/Seadoo Neoprene Carry Case



18-ADA507
STATS Kawasaki Neoprene Carry Case



18-ADA508
STATS Suzuki Neoprene Carry Case



18-ADA510
MEFI NEOPRENE CABLE BAG



18-ADA512
STATS VOLVO NEOPRENE BAG



18-ADC400
STATS Dongle A Universal



18-ADC401
STATS Dongle B Seadoo 4 Tech Engines



18-ADC409
STATS Dongle C Seadoo DI Engines



18-ADC412
STATS Dongle D BRP DESS (2 Stroke)



18-ADC152
STATS Power Cable (AC)



18-ADC450
STATS Power Cable (12v)



18-ADC153
STATS USB Cable



18-ADC300
STATS Master Cable

18-ADC300E
STATS MASTER CABLE 20'



18-ADC402
STATS BRP Safety Key Programming Cable



18-ADC403
STATS Yamaha
Diagnostic Cable



18-ADC404
STATS BRP
Diagnostics Cable



18-ADC406
STATS Kawasaki
T-In Power Cable



18-ADC407
STATS Mercury
Diagnostic Cable



18-ADC408
STATS BRP
T-In Power Cable



18-ADC410
STATS Mercury
Outboard Cable



18-ADC414
STATS Kawasaki
Power Cable (4-Stroke)



18-ADC415
VOLVO DIESEL DIAGNOSTIC CABLE



18-ADC416
STATS Kawasaki
Fitch DI Cable



18-ADC417
YANMAR DIESEL DIAGNOSTIC CABLE



18-ADC418
STATS Yamaha
Remote Programming
Cable



18-ADC419
STATS Kawasaki
Key Programming Cable



18-ADC420
vSTATS Suzuki
4 Pin Diagnostic Cable



18-ADC421
STATS Suzuki
8 Pin Diagnostic Cable



18-ADC422
STATS BRP
DESS Diagnostic Cable



18-ADC423
STATS Johnson Evinrude Diagnostic
Cable



18-ADC424
STATS Mercruiser / MEFI Diagnostic
Cable



18-ADC425
MEFI V-VI CABLE



18-ADC199
JACK SCREWS FOR STATS CONSOLE



ENGINE ADD ON UPGRADE KITS

Upgrade your STATS console to perfectly suit your needs.

With our Engine Add On Software Kits you can purchase only the software that you require.

18-SD111	MERCURY/MERCUISER/MEFI
18-SD112	BRP
18-SD113	YAMAHA OUTBOARD
18-SD114	SUZUKI
18-SD115	YAMAHA PWC
18-SD116	KAWASAKI
18-SD117	SEA DOO
18-SD405	HYDROSPACE/BENELLI/WEBER
18-SD406	VOLVO D3, D4, D6
18-SD407	YANMAR DIESEL
18-SD413	MEFI V-VI UPGRADE KIT



**18-5013
TUNE-UP KIT**
— CONTAINS —
Part # Desc. O.E.#
18-5149 Contact Set F12044
18-5169 Condenser F12042-1



**18-5149
CONTACT SET**
Replaces: F12044



**18-5150
CONTACT SET**
Replaces: FA305310-2,
817764A2



**18-5169
CONDENSER**
Replaces: F12042-1



**18-5241
CONDENSER**
Replaces: F12181-1



**18-5803
SOLENOID**
Replaces: F177917



**18-5835
SOLENOID**
Replaces: 89-803822T,
89-F460917-1, F460917-1,
89-817109A3
For: Early model 35-150 HP



**18-5834
SOLENOID**
Replaces: 89-817109A2
For: 75 HP (3 cyl.) S/N G127500 & UP



**18-5775
SWITCH BOX**
Replaces: 332-7778A6,
332-7778A9



**18-5881
SWITCH BOX**
Replaces: 332-5772A7



**18-5790
SWITCH BOX ASSEMBLY**
Replaces: 18495A26



**18-5870
STATOR**
Replaces: 398-832075A4



**18-5873
STATOR & KIT**
Replaces: 398-832075A6
For: 100, 115, 125 HP



① 18-5186D Display Package
IGNITION COIL
Replaces: 339-7370A13,
339-7370B13, 339-832757B4

COIL AND STATOR APPLICATION

Year	HP	S/N	Coil	Stator	Year	HP	S/N	Coil	Stator
1992-95	40/50	E000001-E138599	18-5186	—	1990-95	120	ALL	18-5186	—
1996-99	40/50	E138600-E369299	—	18-5870	1994-95	120	E065487-E138599	18-5186	18-5873
1991-95	70	E000001-E138599	18-5186	—	1994-95	Sport Jet 120	E095088-E141088	18-5186	18-5873
1996-99	75	E138600-up	—	18-5870	1996-99	120	E138600-up	—	18-5870
1991-95	90	E000001-E138599	18-5186	—	1989-94	150	ALL	18-5186	—
1996-99	90	E138600-up	—	18-5870					

CHRYSLER IGNITION

HP	Model	Contact Set	Condenser	Tune-Up Kit	Starter Solenoid	HP	Model	Contact Set	Condenser	Tune-Up Kit	Starter Solenoid
4.5	42HA	—	18-5241	—	N/A		94H1F	—	18-5241	—	N/A
4.9	44HA,44/45HB,HC,HD	—	18-5241	—	N/A	9.9 ④	94/95HA	—	18-5241	—	18-5803
5	52/53HA	—	18-5241	—	N/A	9.9 ⑤	94/95HA-HE	—	18-5241	—	N/A
5	54/55HA,HB,HC,HD	—	18-5241	—	N/A	10 ①	102/103HD,H8B	—	18-5241	—	—
6	60HA,62/63HA-HH,H9M	—	18-5241	—	N/A		108/109HA,H8B	—	18-5241	—	—
6	64HA-HC,H0F,H1G,H2H,H8D,H9E	—	18-5241	—	N/A	10	102/103/104/105HA,HB,HC	—	18-5241	—	N/A
7	72/73HA	—	18-5241	—	N/A	12.9 ①	122/123H9E,128/129H9A	—	18-5241	—	—
8	82/83HA-HH,H9K	—	18-5241	—	N/A		122/123/124/125HA,HC,HD	—	18-5241	—	N/A
9.9	92H1H,H1J,H2J,H3K	—	18-5241	—	N/A	15	152H1G,H1H,H2H,H3J	—	18-5241	—	N/A
9.9 ②	92/93H9F,98/99H9A	—	18-5241	—	N/A			—	18-5241	—	N/A
9.9	92/93HA-HE,H0G,	—						—	18-5241	—	N/A

① Items ending in "D" are Display Packaged - Regular number is Non-Display

APPLICATION CONTINUED ON NEXT PAGE

CHRYSLER IGNITION

HP	Model	Contact Set	Condenser	Tune-Up Kit	Starter Solenoid	HP	Model	Contact Set	Condenser	Tune-Up Kit	Starter Solenoid
15	152/153HA,HB,HOF	—	18-5241	—	N/A	45 ②	450 thru 457HA,HC-HH	18-5149	18-5169	18-5013	18-5803
15 ①	152/153HC,H8D,H9E	—	18-5241	—	—	45 ①	450 thru 457HC-HH	18-5162	N/A	N/A	18-5803
15	154/155HA,154HB	—	18-5241	—	N/A	45	450/451HK,452/453HC-HJ,H8K	18-5149	18-5169	18-5013	—
15 ①	158/159HA,H8B,H9C	—	18-5241	—	—	45	456/7H0L,HJ,H1M,H9K,457H3P,H2N	18-5162	—	—	18-5803
20	202H2N,202/203HA-HG,H0L	—	18-5241	—	N/A	45	458/459HA,HG	18-5162	N/A	N/A	18-5803
20 ①	202/203H1M,H9K	—	18-5241	—	—	45 ③	458/459HA-HF	18-5162	—	—	18-5803
20	204/205HA-HG	—	18-5241	—	N/A	45 ①	458/459HA-HF	18-5162	N/A	N/A	18-5803
20 ①	206/207H9B	—	18-5241	—	—	45 ②	458/459HA-HF	18-5149	18-5169	18-5013	18-5803
25	252H1F,H2F,H3G,252/253H8C	—	18-5241	—	N/A	45	459H0J,H9H	18-5162	—	—	18-5803
25 ②	252/253HB,H8D,254/255HB	—	18-5241	—	N/A	45	464HA	18-5149	18-5169	18-5013	18-5803
25	252/253/254/255HA	—	18-5241	—	N/A	50	503H3A,507H1A,H2B,H2C,H3D,R3E	18-5162	—	—	18-5803
25 ③	252/253/254/255HB,256/257HA	18-5162	—	—	—	55	551HA	18-5162	—	—	18-5803
25 ②	256/257HA,H8C	—	18-5241	—	N/A	55 ②	554 thru 559HA,HC-HG	18-5149	18-5169	18-5013	18-5803
30 ②	302/303H9C,HB	—	18-5241	—	N/A	55 ③	554 thru 559HA,HC-HG	18-5162	—	—	18-5803
30	302/303/304/305HA	—	18-5241	—	N/A	55 ①	554 thru 559HA,HC-HG	18-5162	N/A	N/A	18-5803
30 ③	302/303/304/305HB,306/607HA	18-5162	—	—	—	70	706/707HA,HC-HF	18-5150	N/A	N/A	18-5803
30 ②	304/305HB,306/607HA	—	18-5241	—	N/A	75	756/757HA	18-5150	N/A	N/A	18-5803
35 ②	350/351HK,H8L,356/357HK,H8M	—	18-5241	—	N/A	85	856/857HA,HC,HD,HE	18-5150	N/A	N/A	18-5803
35 ③	350/351/354/355HC-HH	18-5162	—	—	18-5803	90	906/907HA	18-5150	N/A	N/A	18-5803
35 ②	350/351/354/355HC-HH	18-5149	18-5169	18-5013	18-5803	105	1056/1057HA-HF,1058HA, HB, HC	18-5150	N/A	N/A	18-5803
35 ①	350/351/354/355HH,356/357HF	18-5162	N/A	N/A	18-5803	105	1058HD,1059HD	N/A	N/A	N/A	18-5803
35 ③	350/351/356/357HK	18-5162	—	—	—	120	1206/1207HA-HF,1208 HA, HB, HC	18-5150	N/A	N/A	18-5803
35	350/352/353/354/355HA,352/353HF	18-5149	18-5169	18-5013	18-5803	120	1208HD,1209HD	N/A	N/A	N/A	18-5803
35	352/353HC-HE,HG-HJ,H2P,H8K,H9L	18-5149	18-5169	18-5013	—	130	1306/1307HA	18-5150	N/A	N/A	18-5803
35	353H0M,H1N	18-5149	18-5169	18-5013	—	135	1356/1357HA,1358HA, HB, HC	18-5150	N/A	N/A	18-5803
35 ②	356/357HA-HF	18-5149	18-5169	18-5013	18-5803	135	1358HD,1359HD	N/A	N/A	N/A	18-5803
35 ③	356/357HA-HF	18-5162	—	—	18-5803	150	1508HA	18-5150	N/A	N/A	18-5803
35	360/361HA,HB	18-5149	18-5169	18-5013	—	① Magnapower ignition (w/alternator & C-D Unit) ② Magneto ignition (no alternator) ③ Standard ignition (w/alternator) ④ 94 HA S/N 3299 & below, 95HA S/N 3124 ⑤ 95HA S/N 3300 & up, 95HA S/N 3125 & up					
45 ③	450 thru 457HA,HC-HH	18-5162	—	—	18-5803						

FORCE IGNITION

Year	Model	Serial #	Contact Set	Condenser	Solenoid	Switch Box	Year	Model	Serial #	Contact Set	Condenser	Solenoid	Switch Box
1984-87	9.9/15	N/A	—	18-5241	—	—	1991-95	90	E000001-E138599	—	—	—	18-5790
1996-99	40/50	E138600-E369299	—	—	18-5834②	—	1996-99	90	E138600-up	—	—	18-5834②	—
1984-87	50	N/A	18-5162	—	18-5803	—	1993-94	Sport Jet 90	E023150-E033710	N/A	N/A	—	18-5775
1988	50	N/A	—	—	18-5803①	—	1991D-1992C&1993,1994	120	E000001-E093699	N/A	N/A	—	18-5881
1991B, 1992C	70	E000001-E039023	18-5162	—	18-5803	18-5790	1995	120	E093700-E138599	N/A	N/A	—	18-5881
1991-95	70	E000001-E138599	—	—	—	18-5790	1996-99	120	E138600-up	—	—	18-5834②	18-5790
1996-99	75	E138600-up	—	—	18-5834②	—	1991-92	120 L-Drive	N/A	N/A	—	18-5881	
1991D-1992C	90	E000001-E039023	N/A	N/A	—	18-5775	① Except "D" Models ② Style II						
1991	90 L-Drive	N/A	N/A	N/A	—	18-5775							

PREMIUM MARINE SPARK PLUG WIRE LEADS

MAGFORCE™



OE style boots provide a sealed barrier against heat, dirt and moisture.

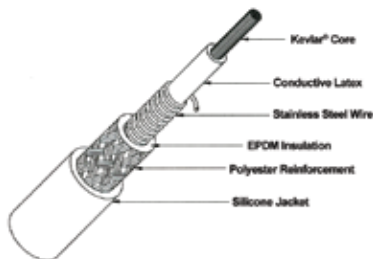

Part #	Description
18-8819-1	7" Spark Plug Wire
18-5228-1	9" Spark Plug Wire
① 18-5228-1D	9" Spark Plug Wire
②③ 18-5229-9-1	22" Spark Plug Wire (pkg of 5)
②③ 18-5230-9-1	10" Spark Plug Wire (pkg of 5)

Premium Marine Wire Leads Magnetic Suppression Core Manufactured for your specific application

- ★ Kevlar® core for maximum durability and long life.
- ★ Durable stainless steel wound conductor for maximum horsepower and engine performance.
- ★ Premium silicone jacketing and boots for the ultimate in high temperature protection.
- ★ Superior RFI suppression for the most sensitive electronic system.
- ★ Corrosion resistant stainless steel spark plug and distributor terminals for maximum conductivity.



**18-9802
TIMING LIGHT**
Self-powered accurate up to 10,000 RPM's

BATTERY CABLES

Gauge cable with soldered lug terminals on each end to accept a 3/8" stud.



Part No.	Size	Color	Gauge	Part No.	Size	Color	Gauge
BC88523	2'	red	4	BC88563	6'	red	2
BC88533	2'	black	4	BC88573	6'	black	2
BC88543	4'	red	2	BC88583	8'	red	1
BC88553	4'	black	2	BC88593	8'	black	1



**18-5225
SPARK PLUG WIRE KIT**
Replaces:
Mercury 84-99215A26, 84-813706A26
Kit includes 25 ft. Roll of 7 MM Hypalon Ignition Wire With a Metallic Core and a Large Assortment of Three Different End Fittings to Fit Outboard Motors.



**18-5226
IGNITION WIRE
Metallic Core
(100' Spool)
7mm Hypalon**

PKG. OF 10



**18-5224
18-5224-9②
IGNITION WIRE TERMINAL**

PKG. OF 10



**18-5750
18-5750-9②
UNIVERSAL SPARK
PLUG BOOTS**
Supplied complete w/Terminal Connector



**18-5752
UNIVERSAL
SPARK PLUG BOOTS
(8mm)**



**18-5742
VOLTAGE REGULATOR**
Replaces: 815279-2
Force engines with 16 amp - 20 amp charging system model years 1991-92

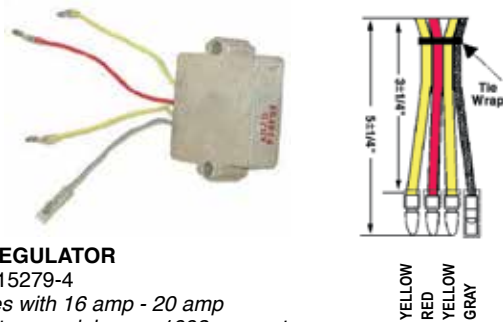

**18-5744
VOLTAGE REGULATOR**
Replaces: 815279-4
Force engines with 16 amp - 20 amp charging system model years 1993-present

① Items ending in "D" are Display Packaged - Regular number is Non-Display
② Priced per Package
③ Uses 7mm wire copper core



18-6762
TILT/TRIM MOTOR
 Replaces: 449541-3, 455541

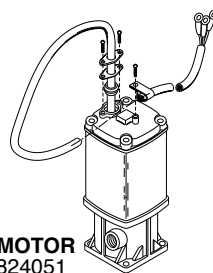

18-6775
TILT/TRIM MOTOR
 Replaces: 824051
 For: 90 HP (1995-97)
 and 120 HP (1995-97)
 Contains: All parts necessary, a new
 3- wire motor/reservoir, drive shaft
 coupler, oil seal, O-ring and hardware.



If you have this 3-wire
 single ram system, use
18-6775



18-6286
TILT/TRIM MOTOR
 Heavy Duty Late Model
 Mercury/Force 25-50HP
 Outboards w/2 wire
 connection and flat
 blade shaft
 Replaces : Mercury/Force
 827675A1

18-6279
TILT/TRIM MOTOR
 Late model Force outboards
 w/2 wire connection
 Replaces: Chrysler Force
 820545, F694541-1



18-6777
TILT/TRIM MOTOR
 Replaces: 818903A1, 819762A4-A7,
 819479A1, 819480A1, 81977A8-A9,
 822870A1, 830250A3-T3, 832021A1-T4-A2-T2,
 855654A1-T2, 19217A1-A5
 Contains: All parts necessary, a new 2- wire
 motor/reservoir, drive shaft coupler, oil seal,
 O-ring and hardware.

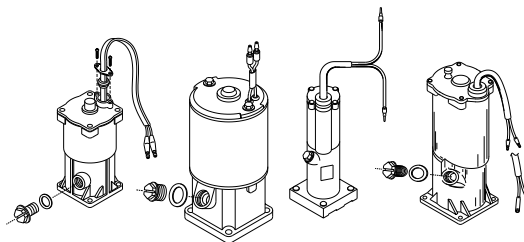

If you have any of the 2-wire single ram systems, use **18-6777**

For:			
HP	Years	HP	Years
40	1992-94	90	1991-94
50	1991-94	120	1990-94
70	1991-95	150	1989-94
75	1996-99		



18-6439
STARTER
 Replaces:
 50-803903T, 50-F575955
 Fits:50HP (1984-92)



18-6441
STARTER
 Replaces:
 50-803900T, 50-F514955
 Fits:25 HP (1983-84, 1989), 30 hp (1979),
 35 HP (1976-78, 1986-91)



18-5613
PREMIUM
OUTBOARD STARTER
 Replaces: Mercury/Force
 FK616955, 61-6955, 490955, 480955,
 50-898265002



18-5618
OUTBOARD STARTER
 Replaces: Mercury/Force
 50-819968-2











18-5622
OUTBOARD STARTER
 Replaces: Mercury/Force
 50-820193, 50-820193T1

CHRYSLER/FORCE

H.P.	Serial No.	Years	Starter #	O.E.M #	Drive Assembly	O.E. #	Tooth Count	Drive Brush Kit	O.E. #
25		1983-84	18-6441	50-F514955/514955	18-5655	F15150	10	18-5697	F15157
25		1989	18-6441	50-F514955/514955	18-5655	F15150	10	18-5697	F15157
30		1979	18-6441	50-F514955/514955	18-5655	F15150	10	18-5697	F15157
35		1976-78	18-6441	50-F514955/514955	18-5655	F15150	10	18-5697	F15157
35		1986-91	18-6441	50-F514955/514955	18-5655	F15150	10	18-5697	F15157
35-55		1966-89	①	201955/FK575955	18-5673	F15150	11	18-5697	F15164
25-60	All	1966-92	①	50-F575955	18-5655	F15150	10	18-5697	F15164
25-60	All	1966-92	①	50-F514955/514955	-	-	10	18-5697	F15164
40/50	OE009500-OE369299	1992-99	18-5622	50-820193/50-820193T1	18-5677	811902	13	18-5697	F15164
40/50	OE000001-OE093699	1992-94	①	50-819271/50-820193A1	18-5677	811902	13	18-5697	F15164
70-150	All	1966-89	18-5613	50-819085/F616955-1/F616955	18-5673	819222	9	18-5697	F15164
85L,70-150		1966-89	18-5613*	480955/FK616955	18-5673	F15100,F15110	9	18-5697	F15164
70	OE000001-OE138599	1991-95	18-5613	50-819085/F616955-1/F616955	18-5673	819222	9	-	F15190
75	OE138600-OE318771	1996-98	18-5613	50-819085/F616955-1/F616955	18-5673	819222	9	-	F15190
85/125 L-drive		1989	18-5613	50-819085/F616955-1/F616955	18-5673	819222	9	18-5697	F15164
Sport Jet 90/120	All	1992-97	18-5618	50-819968-2	-	820583	9	-	F15190
90	OE000001-OE318771	1991-98	18-5613	50-819085/F616955-1/F616955	18-5673	819222	9	-	F15190
90		1990-91	18-5613	50-819085/F616955-1/F616955	18-5673	819222	9	18-5697	F15164
90/120 L-drive		1990-91	18-5613	50-819085/F616955-1/F616955	18-5673	819222	9	18-5697	F15164
120	OE000001-OE093699	1990-94	18-5613	50-819085/F616955-1/F616955	18-5673	819222	9	18-5697	F15164
FORCE 150		1989A-1992C	18-5613	50-819085/F616955-1/F616955	18-5673	819222	9	-	F15190
150	OE000001-OE093699	1989-1994	18-5613	50-819085/F616955-1/F616955	18-5673	819222	9	-	F15190

① No replacement starter available, drive parts only * Only fits 140 HP (1983-1984)

 <p>18-7033 CARB KIT Replaces: FK10003, FK10026, FK10053, FK10102-1</p>	 <p>18-7037 CARB KIT Replaces: FK10004, FK10005, FK10007, FK10008, FK10027, FK10057, FK10108, FRK739</p>	 <p>18-7216 CARB KIT Replaces: 809449A1 For: 25 H.P. 1996-98, also fits Sears engines</p>	 <p>18-7041 NEEDLE & SEAT Replaces: F016311</p>
 <p>18-7057 NEEDLE & SEAT Replaces: F010790 .078 Bore</p>	 <p>18-7805 FUEL PUMP KIT Replaces: F2A24747-1</p>	 <p>18-7806-1 FUEL PUMP KIT</p>	 <p>18-7817 DIAPHRAGM KIT Replaces: 21-42990A7, A8, A9, A10, 21-857005A1</p>

CHRYSLER

HP	Model	Carb Kit	Needle & Seat	Fuel Pump Kit
3.6	32/33HA,HB,HC	18-7037	18-7057	N/A
4.5	42HA	18-7037	18-7057	18-7805
5	52/53HA	-	-	18-7805
6	60HA	18-7037	18-7057	18-7805
6	60H0D,H8B,H9C	-	-	18-7805
6	61H0C,H8B,H9B	-	-	18-7805
6	62H8J,H9K,H9L	-	-	18-7805
6	67H9B,H9C	-	-	18-7805
6	62/63H9M	18-7037	18-7057	18-7805
6	62/63HA	① 18-7037	18-7057	18-7805
6	62/63HA	② -	-	18-7805
6	62/63H9M,HC,HD,HE,HF,HG,HH	18-7037	18-7057	18-7805
6	64HA,HB,HC	18-7037	18-7057	18-7805
6	64H0F,H1G,H2H,H9E,65H0A	-	-	18-7805
6	64H8D	18-7037	18-7057	18-7805
7	72/73HA	-	-	18-7805
7.5	70H9A	-	-	18-7805
7.5	71H1B,H2C,H3D,H9A	-	-	18-7805
7.5	72H1D,H2E,H3F,H0C,H9B	-	-	18-7805

① S/N 3001 & up ② S/N 3000 & under

APPLICATION CONTINUED ON NEXT PAGE

CHRYSLER (Cont.)

HP	Model	Carb Kit	Needle & Seat	Fuel Pump Kit
7.5	75H9A,77H0B,H1C,H9B	—	—	18-7805
8	82/83HA,HC,HD,HE,HF,HG,HH,H9K	18-7037	18-7057	18-7805
8	82/87H8J	—	—	18-7805
9.9	91H0B,H9A	18-7037	18-7057	18-7805
9.9	91H3C,95H3J	—	—	18-7805
9.9	92H1H,98H1B	18-7037	18-7057	18-7805
9.9	92H1J/H2J,H3K	—	—	18-7805
9.9	92/93H0G,H9F,HD,HE	18-7037	18-7057	18-7805
9.9	92/93HA	—	—	18-7805
9.9	92/93HB ④	18-7037	18-7057	18-7805
9.9	92/93HB ⑤	—	—	18-7805
9.9	94H1F,94/95HA,95H2H	—	—	18-7805
9.9	94/95HB,HD,HE, 95H0F,H1G	18-7037	18-7057	18-7805
9.9	98H2C 98/99H9A	—	—	18-7805
10	100HA,101H8B	18-7037	18-7057	18-7805
10	102/103HA,HB,HC,HD,H8B	18-7037	18-7057	18-7805
10	104/105HA,HB,HC	18-7037	18-7057	18-7805
10	108/109HA,H8B	18-7037	18-7057	18-7805
12	121H9A,125H9E	18-7037	18-7057	18-7805
12.9	122/123HA,HC,HD,H9E	18-7037	18-7057	18-7805
12.9	124/125HA,HC,HD	18-7037	18-7057	18-7805
12.9	128/129 H9A	18-7037	18-7057	18-7805
15	152H1G	18-7037	18-7057	18-7805
15	152H1H,H2H,H3J	—	—	18-7805
15	158H3D	—	—	18-7805
15	152/153HA,HC,HB,H0F,H8D,H9E	18-7037	18-7057	18-7805
15	154HB,154/155HA	18-7037	18-7057	18-7805
15	158/159,HA,H8B,H9C	18-7037	18-7057	18-7805
20	202/203HA,HB,HD,HE,HF,HG	—	—	18-7805
20	202/3H0L,H1M,H9K,202H2N	18-7037	18-7057	—
20	204/205HA,HB,HD,HE,HF,HG	—	—	18-7805
20	206/207H9B	18-7037	18-7057	—
25	252H3G,257H3D ⑥	18-7037	18-7057	—
25	252/253HA,HB,H8C,H8D,252H1F,H2F	18-7037	18-7057	—
25	254/255HA,HB 256/257HA,HB	18-7037	18-7057	—
30	302/303HA,HB	18-7037	18-7057	—
30	302/303H9C	—	18-7057	—
30	304/305HA,HB	18-7037	18-7057	—
30	306/307H0C,H9B	—	18-7057	—
30	306/307HA,307H1D,H2E	18-7037	18-7057	—
35	350 THRU 355HA,HC,HD	18-7037	18-7057	18-7806-1
35	350/351,HE,HF,HG,HH,HK,H8L	18-7037	18-7057	—
35	352/353H8K,H9L,353H0M,H1N	18-7037	18-7057	—
35	352/353HE,HF,HG,HH,HJ,H2P	18-7037	18-7057	—
35	354/355HE,HF,HG,HH	18-7037	18-7057	—
35	356/357HC,HD,HC,HE,HF,HK,H8M	18-7037	18-7057	—
35	357H3N,R3P,360/361HA,HB	18-7037	18-7057	—
35	356/357HA,HB	18-7037	18-7057	18-7806-1
45	450/451HK	18-7037	18-7057	—
45	450 THRU 457HA,HC,HD	18-7037	18-7057	18-7806-1
45	450 THRU 457HE,HF,HG,HH	18-7037	18-7057	—
45	452/453HJ,H8K	18-7037	18-7057	—
45	456/457H0L,HJ,H1M,H9K,457H2N	18-7037	18-7057	—
45	458/459HA,HB	18-7037	18-7057	18-7806-1
45	458/459HD,HC,HE,HF,HG	18-7037	18-7057	—
45	459H0J,H9H	18-7037	18-7057	—
45	468/469HA	18-7037	18-7057	—
50	503H3A,507H1A,H2B,H2C,H3D,R3E	18-7037	18-7057	—
55	551HA,554 THRU 559HA,HD,HF ③	18-7037	18-7057	18-7806-1
55	554 THRU 559HE,HG	18-7037	18-7057	—
55	558/559HH,HJ,HK,H9L	18-7033	18-7057	—
55	559H0M,H0N,H1N,H2P,H3R,V3S	18-7033	18-7057	—
60	608/609HA	18-7033	18-7057	—
65	659HA,HB	—	18-7057	—
70	706/707HA,HC,HD,HE	18-7033	18-7057	18-7806-1
70	706/707HF,709HOAN,H9A	18-7037	18-7041	—
70	T700H9A	18-7037	18-7057	—
75	754H0B,456H0F,H2H,757HD,H9E	18-7033	18-7057	—

① S/N 3001 & up ② S/N 3000 & under
 ③ 554HF S/N 11072 & up 555HF 14439 & up, 557HF 14581 & up 558HF 11108 & up, 559HF 14309 & up
 ④ Tillotson carb CO-3A ⑤ Tillotson carb MD-144A ⑥ Tillotson carb WB-19D

CHRYSLER (Cont.)

HP	Model	Carb Kit	Needle & Seat	Fuel Pump Kit
75	756/757HA,HB,HC,756H1G	18-7037	18-7041	—
75	758H0B,H1C,P/S759H9A	18-7037	18-7041	—
75	758H2D,T750H9A	18-7037	18-7057	—
85	850H0A,H1C,851H9A,P/S855H9A	18-7033	18-7057	—
85	856H0H,H1J,H2K	18-7033	18-7057	—
85	856/7HA,HC,HD	18-7033	18-7057	18-7806-1
85	856/7HE	18-7037	18-7041	—
85	857HF,H9G	18-7033	18-7057	—
85	858H0C,H1D,H2E	18-7033	18-7057	—
85	859HA,H8A,H9B,T850H9A	18-7033	18-7057	—
90	906/907HA,HB,HC	18-7033	18-7057	—
100	T1000H9A,1002H0AN,1004H0B,H9A	—	18-7057	—
100	1006H0B,H1C,1007H9A,1008H0A,H1B	—	18-7057	—
105	1055HA	18-7037	18-7057	—
105	1055HB	—	18-7057	—
105	1056/1057HA,HB,HC,HD	18-7037	18-7057	18-7806-1
105	1056/1057HE,HF	18-7037	18-7057	—
105	1057HH,1058H2G	—	18-7057	—
105	1058 HA,HB,HC	18-7037	18-7057	18-7806-1
105	1058/9HD,HE	18-7037	18-7057	—
105	1058/1059HF,1059HG	—	18-7057	—
115	1159HA	—	18-7057	—
120	1206/1207HA,HB,HC,HD	18-7037	18-7057	18-7806-1
120	1206/1207HE,HF	18-7037	18-7057	—
120	1208HA,HB,HC	18-7037	18-7057	18-7806-1
120	1208/1209HD,HE	18-7037	18-7057	—
120	1208/1209HF,1209HG	—	18-7057	—
130	1306/1307HA	18-7037	—	18-7806-1
135	1358HA,HB,HC	18-7037	18-7057	18-7806-1
150	1508HA	18-7037	—	18-7806-1

FORCE

HP	Year	Serial # Range	Fuel Pump Kit
5	1988-98	N/A	18-7805
7.5	1985	N/A	18-7805
9.9/15	1984-98	N/A	18-7805
25	1989	N/A	18-7806-1
35	1986-87	N/A	18-7806-1
35A	1988-91	N/A	18-7806-1
35B	1988-91	N/A	18-7806-1
35C	1989-91	N/A	18-7806-1
40/50	1992C	E000001-E065371	18-7806-1
40/50	1992-94	E065372-E093669	18-7817
40/50	1995	E093700-E138599	18-7817
40/50	1997-99	E138600&UP	18-7817
50	1984-91,1992A	N/A	18-7806-1
60	1985	N/A	18-7806-1
70	1991B,1992C	E000001-E039023	18-7806-1 ①
70	1992-95	E039024-E138599	18-7817 ①
75	1996-99	E138600-UP	18-7817
85	1983-88,1989A,B	N/A	18-7806-1
85	1989C-H,L-Drive	N/A	18-7806-1
90	1991A,B,C	N/A	18-7806-1
90	1991D-1992C	E000001-E039023	18-7806-1 ①
90	1992-94	E039024-E093699	18-7817 ①
90	1995-99	E093700-UP	18-7817
90 L-Drive	1991	N/A	18-7806-1
90&L-Drive	1990	N/A	18-7806-1
Sport Jet 90	1993-94	E023150-E066619	18-7806-1
Sport Jet 90	1995-96	E138325-E138599	18-7806-1
Sport Jet 95XR	1996-97	E141089-UP	18-7806-1
120	1990A-1991C	N/A	18-7806-1
120	1991D-1992C, 1993-94	E000001-E093699	18-7817 ①
120	1995	E093700-E138599	18-7817
120	1996-99	E0138600-UP	18-7817
120 L-Drive	1990-92	N/A	18-7806-1
120 Sport Jet	1995-97	E095088-E138599	18-7806-1
125	1984-89	N/A	18-7806-1
125 L-Drive	1989	N/A	18-7806-1
150	1989-92	UP TO E065371	18-7806-1
150	1993-94	E000001-E093699	18-7817

① Serial # E000001-E065371 use 18-7806-1

FUEL WATER SEPARATORS



Sierra offers a complete line of 10 and 21 micron fuel water separating filters including drainable bowl filters to protect your carbureted and fuel injected engine.

Refer to pages 126-130 for a complete listing of OEM and universal applications.

Sierra fuel water separators remove over 99.8% of emulsified water from your gasoline. Sierra's 10 micron filters are over 90% efficient at removing particles as small as 10 micron. All filters flow @ 90 GPH to feed even the hungriest motor. Sierra 10 micron filters are recommended to prevent damage to sensitive inboard and outboard fuel injection systems.

8' LENGTH COMPLETE FUEL LINE ASSEMBLIES

3/8"
FUEL LINE ASSEMBLY

18-8011EP-1 SILVERADO 4000 Premium

OE# FS409752



18-8071
TANK
CONNECTOR
(SOLD SEPARATELY)



18-8005EP-1
PRIMER
BULB



18-8062
FUEL
CONNECTOR



*

*

FUEL LINE ASSEMBLY COMPONENTS

Chrysler Fuel Application

Engine	Year	Engine	Year	Engine	Year
6 HP	1976-82	35 HP	1974-89	90 HP	1975-77, 1983-84, 1991-94
7.5 HP	1979-85	40 HP	1992-94	100 HP	1979-84
8 HP	1976-79	45 HP	1974-84	105 HP	1976-78, 1982
9.9 HP	1979-95	50 HP	1981-94	115 HP	1977-84
10 HP	1976-78	55 HP	1974-83	120 HP	1976-77, 1990-94
12 HP	1979	60 HP	1984-85	125 HP	1981-88
15 HP	1976-95	65 HP	1978	135 HP	1976-77
20 HP	1978-82	70 HP	1979-80, 1991-95	140 HP	1978-84
25 HP	1975-78, 1981-84, 1989	75 HP	1975-84	150 HP	1989-94
30 HP	1979-82	85 HP	1977-88		



18-8002EP-1
18-8002EP-1-10①
PRIMER BULB
1/4"

18-8004EP-1
18-8004EP-1-10①
PRIMER BULB
5/16"
Large capacity bulb

18-8005EP-1
18-8005EP-1-10①
PRIMER BULB
3/8"
Large capacity bulb



18-8062
FUEL CONNECTOR
Replaces: 197787-3
Mates with 18-8071















18-8071
TANK CONNECTOR
1/4" NPT .432 O.D.
Mates with 18-8062
(Male)



* Tanks and Engines for picture purpose only.

① Discount shop pack of 10 - Priced per package

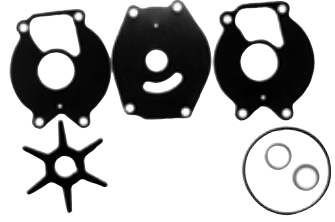
 18-3527 THERMOSTAT Replaces: Force F664068 For: Force 70 hp. 1991-95, 75 hp. 1996-99, 85 hp. 1989, 90 hp. 1991-99, 150 hp 1989-94, 90 SportJet 1993-95, 120 SportJet 1995-98, 85-125 hp. L-Drive 1989-94	 18-3556 THERMOSTAT Replaces: F97068-2 3/4" — 130°	 18-3557 THERMOSTAT Replaces: F335068 1" — 143°	 18-3559 THERMOSTAT Replaces: F528068 1" — 110°																																																																			
 18-3030 IMPELLER Replaces: 47-803630T, F523065, F523065-1 For: Force outboard, 85 HP (1975-89, except 1989 D, F, G, H), 125 HP A,B,&C (1981-88)	 18-3017 18-3017-10② IMPELLER Replaces: 47-89984T4, 47-F694065, 47-803631T	 18-3056 18-3056-10② IMPELLER Replaces: 47-43026-2	 18-3057 IMPELLER Replaces: 47-85089-3																																																																			
 18-3062 IMPELLER Replaces: 47-42038-2	 18-3084 IMPELLER Replaces: 47-F40065-2	 18-3085 IMPELLER Replaces: 47-F84065	 18-8900 IMPELLER Replaces: 47-19453																																																																			
 18-8901 IMPELLER Replaces: 47-F462065	 18-8903 IMPELLER Replaces: 47-F436065-2	 18-3240 WATER PUMP KIT For: 9.9HP (1979-97) 10HP (1974-78) 12HP (1979) 15HP (1974-97) 20HP (1973-78) 25HP (1973-78)																																																																				
 ① 18-3251D Display Package 18-3251 WATER PUMP KIT For: 85HP (1989 D, F, G, H) 90HP (all except 1995-97 & Sport Jet) 120HP (all except 1995-97 & Sport Jet) 125HP (1988-89) 150HP (1989-up) — CONTAINS — <table border="1" style="width: 100%; border-collapse: collapse;"> <thead> <tr> <th>Part #</th> <th>Desc.</th> <th>O.E. #</th> <th>Qty.</th> </tr> </thead> <tbody> <tr> <td>18-0416</td> <td>Gasket, Wear Plate</td> <td>27-F694830</td> <td>1</td> </tr> <tr> <td>18-3017</td> <td>Impeller</td> <td>47-89984T4</td> <td>1</td> </tr> </tbody> </table>	Part #	Desc.	O.E. #	Qty.	18-0416	Gasket, Wear Plate	27-F694830	1	18-3017	Impeller	47-89984T4	1	 ① 18-3214D Display Package 18-3214 IMPELLER REPAIR KIT — CONTAINS — <table border="1" style="width: 100%; border-collapse: collapse;"> <thead> <tr> <th>Part #</th> <th>Desc.</th> <th>O.E. #</th> <th>Qty.</th> </tr> </thead> <tbody> <tr> <td>18-2564</td> <td>Water Pump Base to Face Plate Gasket</td> <td>27-43033-1</td> <td>1</td> </tr> <tr> <td>18-2565</td> <td>Water Pump Base to Gear Hsg. Gasket</td> <td>27-43047-1</td> <td>1</td> </tr> <tr> <td>18-2566</td> <td>Face Plate to Water Pump Cover Gasket</td> <td>27-817277</td> <td>1</td> </tr> <tr> <td>18-2944</td> <td>Seal Ring</td> <td>26-45577</td> <td>1</td> </tr> <tr> <td>18-3056</td> <td>Impeller</td> <td>47-43026-1</td> <td>1</td> </tr> <tr> <td>18-3122</td> <td>Impeller Plate</td> <td>817276</td> <td>1</td> </tr> <tr> <td>18-7420</td> <td>O-Ring</td> <td>25-21836</td> <td>1</td> </tr> </tbody> </table>	Part #	Desc.	O.E. #	Qty.	18-2564	Water Pump Base to Face Plate Gasket	27-43033-1	1	18-2565	Water Pump Base to Gear Hsg. Gasket	27-43047-1	1	18-2566	Face Plate to Water Pump Cover Gasket	27-817277	1	18-2944	Seal Ring	26-45577	1	18-3056	Impeller	47-43026-1	1	18-3122	Impeller Plate	817276	1	18-7420	O-Ring	25-21836	1	 ① 18-3215D Display Package 18-3215 IMPELLER REPAIR KIT — CONTAINS — <table border="1" style="width: 100%; border-collapse: collapse;"> <thead> <tr> <th>Part #</th> <th>Desc.</th> <th>O.E. #</th> <th>Qty.</th> </tr> </thead> <tbody> <tr> <td>18-2560</td> <td>Impeller Washer Gasket</td> <td>12-86645</td> <td>2</td> </tr> <tr> <td>18-2561</td> <td>Gear Hsg. to Face Plate Gasket</td> <td>27-85087</td> <td>1</td> </tr> <tr> <td>18-2562</td> <td>Gear Hsg. to Face Plate Gasket</td> <td>27-99326-1</td> <td>1</td> </tr> <tr> <td>18-3057</td> <td>Impeller</td> <td>47-85089-3</td> <td>1</td> </tr> <tr> <td>18-7419</td> <td>O-Ring</td> <td>25-69202</td> <td>1</td> </tr> </tbody> </table>	Part #	Desc.	O.E. #	Qty.	18-2560	Impeller Washer Gasket	12-86645	2	18-2561	Gear Hsg. to Face Plate Gasket	27-85087	1	18-2562	Gear Hsg. to Face Plate Gasket	27-99326-1	1	18-3057	Impeller	47-85089-3	1	18-7419	O-Ring	25-69202	1
Part #	Desc.	O.E. #	Qty.																																																																			
18-0416	Gasket, Wear Plate	27-F694830	1																																																																			
18-3017	Impeller	47-89984T4	1																																																																			
Part #	Desc.	O.E. #	Qty.																																																																			
18-2564	Water Pump Base to Face Plate Gasket	27-43033-1	1																																																																			
18-2565	Water Pump Base to Gear Hsg. Gasket	27-43047-1	1																																																																			
18-2566	Face Plate to Water Pump Cover Gasket	27-817277	1																																																																			
18-2944	Seal Ring	26-45577	1																																																																			
18-3056	Impeller	47-43026-1	1																																																																			
18-3122	Impeller Plate	817276	1																																																																			
18-7420	O-Ring	25-21836	1																																																																			
Part #	Desc.	O.E. #	Qty.																																																																			
18-2560	Impeller Washer Gasket	12-86645	2																																																																			
18-2561	Gear Hsg. to Face Plate Gasket	27-85087	1																																																																			
18-2562	Gear Hsg. to Face Plate Gasket	27-99326-1	1																																																																			
18-3057	Impeller	47-85089-3	1																																																																			
18-7419	O-Ring	25-69202	1																																																																			

APPLICATION ON NEXT PAGE

- ① Items ending in "D" are Display Packaged - Regular number is Non-Display
- ② Discount shop pack of 10 - Priced per package

CHRYSLER/FORCE					
HP	Year	Serial No.	Impeller	Impeller Kit	Thermostat
9.9	1979-97	ALL	18-8903	18-3240	—
9.9/15	1998	E288600-E344999 ③	18-3062	—	—
10	1974-78	ALL	18-8903	18-3240	—
12	1979	ALL	18-8903	18-3240	—
15	1974-97	ALL	18-8903	18-3240	—
20	1973-78	ALL	18-8903	18-3240	—
20	1979-82	ALL	18-8901	18-3240	—
25	1973-78	ALL	18-8903	18-3240	—
25	1996-98	E127700-E344999	18-3057	18-3215	18-3556
30	1980-82	ALL	18-8901	—	—
35	1976-78, 83-84 & 86-88	ALL	18-8901	—	18-3556
35	1979-82	ALL	18-3084	—	18-3556
40/50	1992-94	E065372-E093669	—	—	18-3556
40/50	1995-99	E093700-E369299	18-3057	—	18-3556
50	1984-91,1992A	N/A	—	—	18-3556
70	1979-80	ALL	18-3085	—	18-3559
70	1991-95	E138600-E345999	18-8900	—	18-3527
75	1979	ALL	18-3085	—	18-3559
75	1980	ALL	18-3030	—	18-3559
75	1996-98	E138600-E345999	18-8900	—	18-3527
75	1999	E345000-UP	18-3057	—	18-3527
85	1977-88	ALL	18-3030	—	18-3559
85	1989	A,B	18-3030	—	18-3559
85	1989	C,E	18-3030	—	18-3527
85	1989	D, F, G, H	18-3017	—	18-3527
85	L-Drives 1989	A,B,C	18-3017	—	18-3527
90	1991A,B,C,D-1992C	E000001-E039023	18-3017	18-3251	18-3527
90	1992-94	E039024-E093699	18-3017	18-3251	18-3527
90	1995-97	E093700-UP	18-3056	18-3214	18-3527
90 L-Drive	1991	N/A	18-3017	18-3251	18-3527
90 & L-Drive	1990	N/A	18-3017	18-3251	18-3527
Sport Jet 90	1993-94	E023150-E066619	—	—	18-3527
Sport Jet 90	1995-96	E138325-E138599	—	—	18-3527
Sport Jet 95XR	1996-97	E141089-UP	—	—	18-3527
100	1979-80	ALL	18-3030	—	18-3559
105	1977-78	ALL	18-3030	—	18-3559
115	1977-80	ALL	18-3030	—	18-3559
120/135	1977	ALL	18-3030	—	18-3559
120	1990A-91C	N/A	18-3017	18-3251	18-3527
120	1991D-92C& 1993, 1994	E000001-E093699	18-3017	18-3251	18-3527
120	1995-97	E093700-UP	18-3056	18-3214	18-3527
120 L-Drive	1990-92	N/A	18-3017	18-3251	18-3527
120 Sport Jet	1995-97	E095088-E138599	—	—	18-3527
125	1981-89	ALL	18-3030	—	18-3559 ① ②
125	1988	C	18-3030	—	18-3527
125 L-Drive	1989	N/A	18-3017	18-3251	18-3559
140	1978-80	ALL	18-3030	—	18-3559
150	1989-92	UP TO E065371	18-3017	18-3251	18-3527
150	1993-UP	E000001-E093699	18-3017	18-3251	18-3527

① Except model "C" for 1988 ② 1989 "D" & "E" models ③ Mercury Lower Unit

CHRYSLER IMPELLER APPLICATIONS							
HP	Model	Serial #	Impeller	HP	Model	Serial #	Impeller
35	350 THRU 355HA,HC, HD 356/357HA,HB	ALL	18-3084	55	554 THRU 559HA, HD	ALL	18-3084
				70	709H0AN,H9A	ALL	18-3085
35	350HF	4901 & UP	18-3084	70	T700H9A,706/707HA, HC,HD,HE	ALL	18-3085
35	351HF	1001 & UP	18-3084				
35	352/353H2P,H9L, 353H0M,H1N	ALL	18-3084	75	T750H9A,757H9E, P/S759H9A	ALL	18-3085
35	354HF	14119 & UP	18-3084	85	856/857HA,HC,HD	ALL	18-3085
35	355HF	14227 & UP	18-3084				
35	356HD	11106 & UP	18-3084	105	1056/1057 HA-HE, 1058HA-HC	ALL	18-3085
35	357HD	14223 & UP	18-3084				
45	450 THRU 457HA, HC,HD 458/459HA,HB	ALL	18-3084	120	1206/1207HA-HE, 1208HA-HC	ALL	18-3085
				130	1306/1307HA	ALL	18-3085
55	551HA	ALL	18-3085	150	1508HA	ALL	18-3085



FORCE PISTON APPLICATION

Model / HP	CYL	Bore Size	PISTON	OEM Part #	RINGS	OEM Part #	Model / HP	CYL	Bore Size	PISTON	OEM Part #	RINGS	OEM Part #
40-50	2	3.312 / std.	18-4629	700-834794T3	18-39010①	39-817869A1	90 L-DRIVE, SPORT JET	3	3.375 / std	18-4632	700-834800A4	18-3998①	39-8204757A2
				FA691015		FA663260					FA528269		
40-50	2	3.322 / .010	18-4630	700-F694015	—	39-817869A2	90 L-DRIVE & SPORT JET	3	3.385 / .010	18-4633	700-819005A8	—	39-820457A1
				700-FSA694015	FSA335260	FA528260							
40-50	2	3.342 / .030	18-4631	700-834794A5	—	39-818110A1	90 L-DRIVE & SPORT JET	3	3.405 / .030	18-4634	700-834800A5	—	39-820641A1
				700-818134A1	—	39-818110A1							
40-50	2	3.375 / std	18-4632	700-834800A4	18-3998①	39-8204757A2	90 L-DRIVE & SPORT JET	3	3.405 / .030	18-4634	700-834800A6	—	39-818129A2
				700-819005A8		39-820457A1					FA528260		
40-50	2	3.385 / .010	18-4633	700-834800A5	—	39-820641A1	120-150	4	3.312 / std.	18-4629	700-834794T3	18-39010①	39-817869A1
				700-819005A12	—	FA691015							
40-50	2	3.405 / .030	18-4634	700-834800A6	—	39-818129A2	120-150	4	3.322 / .010	18-4630	700-834794A4	—	39-817869A2
				—	—	700-F694015							
85-90 & L-DRIVES	3	3.312 / std.	18-4629	700-834794T3	18-39010①	39-817869A1	120 L-DRIVE, SPORT JET	4	3.375 / std	18-4632	700-834800A4	18-3998①	39-8204757A2
				FA691015		FA663260					FA528269		
85-90 & L-DRIVES	3	3.322 / .010	18-4630	700-834794A4	—	39-817869A2	120 L-DRIVE, SPORT JET	4	3.385 / .010	18-4633	700-819005A8	—	39-820457A1
				700-FSA694015	FSA335260	FA528260							
85-90 & L-DRIVES	3	3.342 / .030	18-4631	700-834794A5	—	39-818110A1	120 L-DRIVE, SPORT JET	4	3.405 / .030	18-4634	700-818134A1	—	39-820641A1
				700-818134A1	—	39-818110A1							

① Keystone Rings

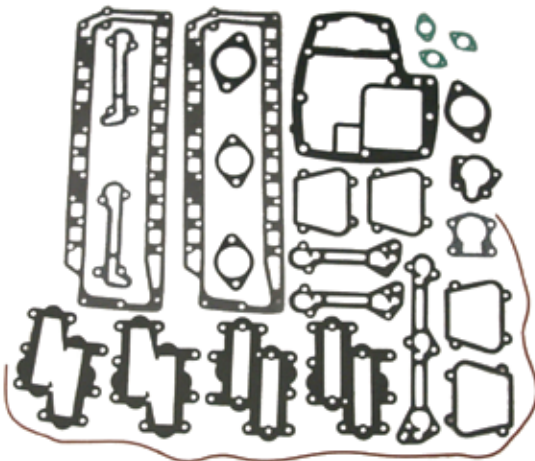

**18-4312
POWERHEAD GASKET SET**

Powerhead Gasket Sets Do Not Include Head Gaskets

— CONTAINS —

PART #	GASKET DESC.	O.E. #	QTY.
18-0968	Cyl. Drain Reed Plate	27-F84748-3	2
18-0861	Cyl. Drain Reed Plate	27-F85748-2	1
18-0869	Port Cover Gasket	27-F40223	4
18-0915	Deflector Plate	27-F406406	2
18-0854	Thermostat Cover	27-F476067	1
18-0958	Exhaust Plate	27F-372154	2
18-0960	Carburetor	27-F85906	2
18-0141	By-Pass	27-F85762	2
18-0315	Carburetor	27-F440906	2

18-4313

POWERHEAD GASKET SET

Powerhead Gasket Sets Do Not Include Head Gaskets

— CONTAINS —

PART #	GASKET DESC.	O.E. #	QTY.
18-0968	Cyl. Drain Reed Plate	27-F84748-3	1
18-0853	Manifold	27-F85159-1	1
18-0855	Carburetor Adapter Flange	27-F85168-1	3
18-0857	Cyl. Drain Cover	27-F85472-2	1
18-0861	Cyl. Drain Reed Plate	27-F85748-2	1
18-0869	Port Cover	27-F40223	2
18-0854	Thermostat Cover	27-F476067	1
18-0152	Intake	27-F481836	3
18-0119	Exhaust Port Plate	27-F85154	2
18-0114	Manifold End Cap	907761	1
18-7108	O-Ring	—	1
18-0960	Carburetor	27-F85906	3
18-0141	By-Pass	27-F85762	2
18-2534	Seal	184122-1	1

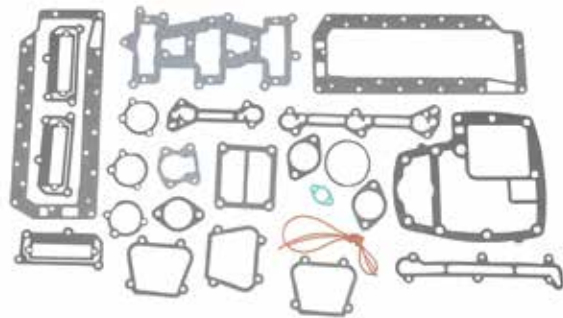

18-4314

POWERHEAD GASKET SET

Powerhead Gasket Sets Do Not Include Head Gaskets

— CONTAINS —

PART #	GASKET DESC.	O.E. #	QTY.
18-0863	Cyl. Drain Cover	27-F93472-1	1
18-0865	Reed Plate	27-F93748-1	1
18-0115	Upper Exhaust Cyl.	27-F307279-2	1
18-0962	Exhaust Port Plate	27-F40154-4	2
18-0869	Port Cover	27-F40223	2
18-0154	Lower Exhaust Cyl.	27-F40279-1	1
18-0873	Thermostat	27-F97067	1
18-0960	Carburetor	27-F85906	1
18-2534	Seal	184122-1	1

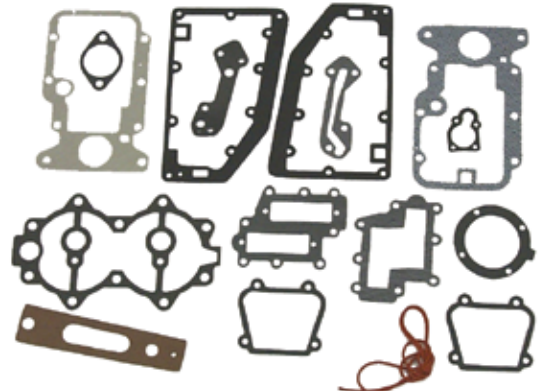

CHRYSLER POWERHEAD GASKET SET APPLICATION

HP	Years	Part #	HP	Years	Part #	HP	Years	Part #
45	1972-83 ①	18-4314	85	1970-73, 1977-88	18-4313	115	1977-83	18-4312
50	1981-87	18-4314				120	1971-77	18-4312
55	1972-76 ①	18-4314	90	1974-77	18-4313	125	1983-88 ②	18-4312
70	1970-73, 1979-80	18-4313	100	1979-81, 1983	18-4312	130	1972	18-4312
75	1974-83	18-4313	105	1972-78, 1982	18-4312	135	1974-77	18-4312
						140	1978-83	18-4312

① Beginning mid year 1972 All BC, BE, HC & HE Models

② For 1988 A & B Models

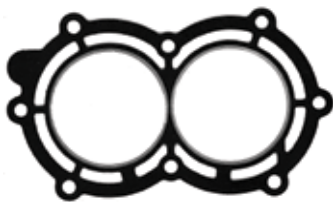

**18-3851
HEAD GASKET**
Replaces: 27-F286529-3
For: 9.9 and 15 HP

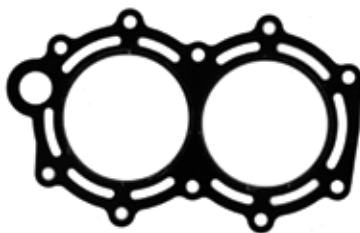

**18-3852
HEAD GASKET**
Replaces: 27-F513529
For: 25 and 35 HP

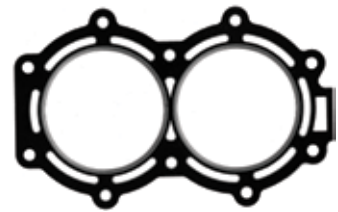

**18-3853
HEAD GASKET**
Replaces: 27-F691529-1
For: 45 and 50 HP

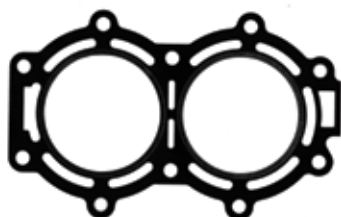

**18-3854
HEAD GASKET**
Replaces: 27-F658529
For: 50 HP

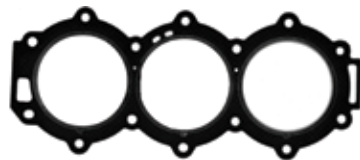

**18-3855
HEAD GASKET**
Replaces: 27-820438
For: 70, 75,85 and 90 HP

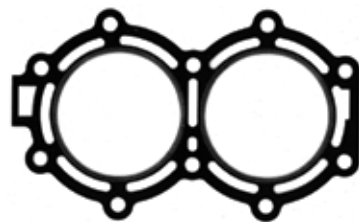

**18-3856
HEAD GASKET**
Replaces: 27-F201529-1
For: 1984-1987 "A" models 50 HP

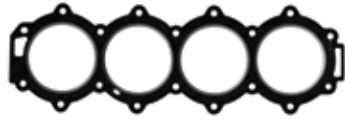

18-3857
HEAD GASKET
 Replaces: 27-824615/27-824615-2, F476529,
 F476529-1, F476529-2, 27-F476529-4
 For: 100 thru 140 H.P.



18-3858
HEAD GASKET
 Replaces: 27-F694529-1
 For: 150 HP

HEAD GASKET APPLICATION

HP	Model/Year	Serial #	Part #	HP	Model/Year	Serial #	Part #
9.9/15	1984-92,A,B	N/A	18-3851	90	1990-92,C,E	N/A	18-3855
9.9/15	1992-98	E000001 & UP	18-3851	90	1991-99	E000001 & UP	18-3855
25	1989A,B	N/A	18-3852	90	1990-91 L-DRIVE,A,B,C,D	N/A	18-3855
35	1986-91,A,B,C	N/A	18-3852	90	1993-95 SPORT JET	E023150-E138599	18-3855
40	1992C & 1992-99	E000001 & UP	18-3853	95	1996-97 SPORT JET XR	E141089 & UP	18-3855
50	1990A,1989-92,B,C,D,Z	N/A	18-3853	120	1990-92,A,C	N/A	18-3857
50	1984-87,A	N/A	18-3856	120	1990-99	E000001 & UP	18-3857
50	1988-89,A /1987-88,B,C,D	N/A	18-3854	120	1990-92,A,B,C,D L-DRIVE	N/A	18-3857
70	1991-92,B,C	N/A	18-3855	120	1995-99 SPORT JET,XR,XR2	N/A	18-3857
70	1992-95	E000001 & UP	18-3855	125	1983-89, A	N/A	18-3857
75	1996-99	E138600 & UP	18-3855	125	1986-89, B	N/A	18-3857
85	1984-89,A,L /1986-89,B,C,	N/A	18-3855	125	1988-89, C	N/A	18-3857
85	1986,M,N	N/A	18-3855	125	1989, D, E	N/A	18-3857
85	1985 L-DRIVE A,B,C	N/A	18-3855	150	1989A-1992C		18-3858
85	1989,D,E,F,G,H	N/A	18-3855	150	1989-1994	E000001-E093699	18-3858
90	1990-91,A,B,D	N/A	18-3855				

<p>PKG. OF 2</p> <p>18-0141 18-0141-9① BYPASS GASKET Replaces: 27-F85762</p>	<p>PKG. OF 2</p> <p>18-0152 18-0152-9① INTAKE GASKET Replaces: 27-F481836</p>	<p>PKG. OF 2</p> <p>18-0315 18-0315-9① CARBURETOR GASKET Replaces: 27-F440906</p>	<p>PKG. OF 2</p> <p>18-0960 18-0960-9① CARBURETOR MOUNTING GASKET Replaces: 27-F85906</p>
<p>18-0314 CARBURETOR ADAPTER GASKET Replaces: 27-828316, 27-F178168, F178168</p>	<p>PKG. OF 2</p> <p>18-0855 18-0855-9① CARBURETOR ADAPTER FLANGE GASKET Replaces: 27-F85168-2</p>	<p>PKG. OF 2</p> <p>18-0915 DEFLECTOR PLATE GASKET Replaces: 27-F406406</p>	<p>18-0861 CYLINDER DRAIN REED PLATE GASKET Replaces: 27-F85748-2</p>
<p>PKG. OF 2</p> <p>18-0119 18-0119-9① EXHAUST PLATE GASKET Replaces: 27-F85154-1</p>	<p>PKG. OF 2</p> <p>18-0958 EXHAUST PORT PLATE GASKET Replaces: 27-F372154-1</p>	<p>PKG. OF 2</p> <p>18-0962 EXHAUST PORT PLATE GASKET Replaces: 27-F40154-4</p>	<p>PKG. OF 2</p> <p>18-0869 18-0869-9① PORT COVER GASKET Replaces: 27-F40223</p>

SEE PAGES 166-167 FOR OUR COMPLETE LINE OF GASKET SEALANTS

① Priced per Package

PKG. OF 2



18-0115
18-0115-9①
POWERHEAD
BASE GASKET
Replaces: 27-F307279-2

PKG. OF 2

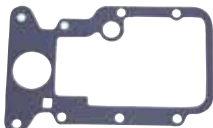

18-0154
LOWER EXHAUST
CYLINDER GASKET
Replaces: 27-F40279-1

PKG. OF 2



18-0854
18-0854-9①
THERMOSTAT
COVER GASKET
Replaces: 27-F476067

PKG. OF 2



18-0873
18-0873-9①
THERMOSTAT GASKET
Replaces: 27-F97067



18-0622
LOWER WEAR
PLATE GASKET
Replaces: 27-19701

PKG. OF 2



18-0415
18-0415-9①
WATER PUMP GASKET
Replaces: 27-F523031

PKG. OF 2



18-0416
WEAR PLATE GASKET
Replaces: 27-828316,
27-F178168, F178168



18-0417
18-0417-9①
WATER PUMP
GASKET
Replaces: 27-F84031

PKG. OF 2



18-2534
SEAL
(40")
Replaces: F184122-1



18-2370
BEARING CARRIER
Replaces: 19291A3
For: Force 40/50 HP (1995-99), 70 HP (1991-95), 75 HP (1996-98), Mercury/Mariner 30/40 HP 2 cyl (9854537-OP016999), 30/40 4-stroke (OG760300-up), 40/50 HP/30Jet 3 cyl (9973100-up), 60 HP 3 cyl (OD000750-up), 60 HP 4-stroke 9973100-up)



18-2375
DRAIN PLUG (MAGNET)
18-23751-9①
(Package of 50 without gasket)

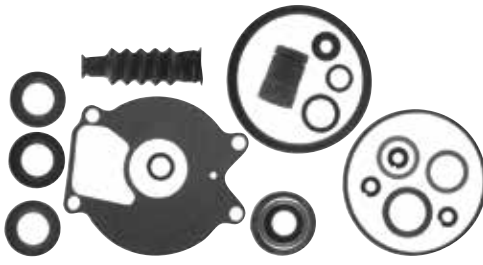

18-2624
LOWER UNIT SEAL KIT
Replaces: 26-85090A2

— CONTAINS —

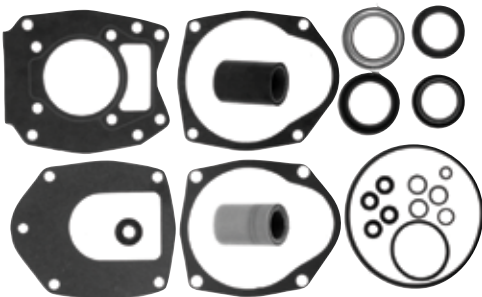

18-2626
LOWER UNIT SEAL KIT
Replaces: 26-43035A4

— CONTAINS —

PART #	DESC.	O.E. #	QTY.
18-0579	Oil Seal	26-41131	1
18-0580	Oil Seal	26-41132	1
18-0586	Seal	26-99325	2
18-7419	O-Ring	25-69202	1
18-2562	Gear Hsg to Face Plate Gasket	27-99326-1	1
18-2945	Washer	12-20260	2
18-2742	Boot	85552	1
18-2560	Washer	12-86645	2
18-7135	O-Ring	25-35276	1
18-7956	O-Ring	25-85549	1
18-7100	O-Ring	25-85594	1
18-7959	O-Ring	25-99691	1

PART #	DESC.	O.E. #	QTY.
18-0522	Oil Seal	26-43036	1
18-0583	Oil Seal	26-43035	1
18-2002	Oil Seal	26-76868	1
18-2053	Oil Seal	26-70081	1
18-2054	Oil Seal	26-816464	1
18-2563	Face Plate to Water Pump Cover Gasket	27-43034-1	1
18-2564	Water Pump Base to Face Plate Gasket	27-43033-1	1
18-2565	Water Pump Base to Gear Hsg Gasket	27-43047-2	1
18-2566	Face Plate to Water Pump Cover Gasket	27-817277	1
18-2945	Washer	12-19183	3
18-4261	Washer	19643	1
18-7198	O-Ring	25-45710	1

SEE PAGES 166-167 FOR OUR COMPLETE LINE OF GASKET SEALANTS

① Priced per Package

APPLICATION FOR SEAL KITS ON PAGE 200



18-2029
LOWER UNIT SEAL KIT
Replaces: 26-85090A1



18-2630
LOWER UNIT SEAL KIT
Replaces: FK1060

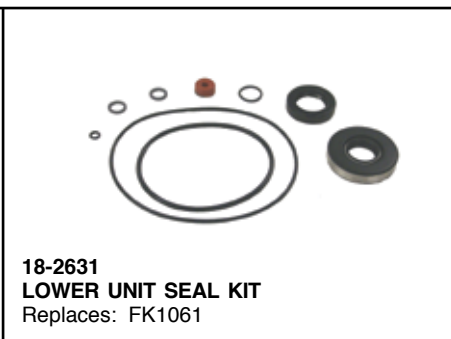

18-2631
LOWER UNIT SEAL KIT
Replaces: FK1061



18-2632
LOWER UNIT SEAL KIT
Replaces: FK1063-2

— CONTAINS —

PART #	DESC.	O.E. #	QTY.
18-2244	Washer	10-79953A2	3
18-7127	O-Ring	25-F84305	1
18-0500	Seal	26-817472	1
18-0512	Seal	26-F84307-1	1
18-7169	O-Ring	25-F24278	1
18-7176	O-Ring	25-90011	1
18-7467	O-Ring	25-54030	1
18-7141	O-Ring	802047	1



18-2633
LOWER UNIT SEAL KIT
Replaces: FK1127

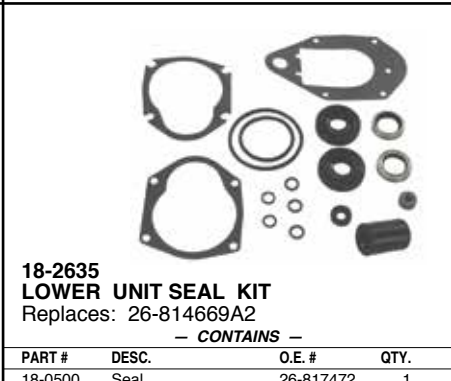

18-2635
LOWER UNIT SEAL KIT
Replaces: 26-814669A2

— CONTAINS —

PART #	DESC.	O.E. #	QTY.
18-0500	Seal	26-817472	1
18-0622	Lower Wear Plate Gasket	27-19701	1
18-2051	Seal	26-69188	1
18-2052	Seal	26-69189	1
18-2945	Washer	12-19183	3
18-7168	O-Ring	25-48171	2
18-7173	O-Ring	25-30224	1
18-7950	O-Ring	25-45258	1

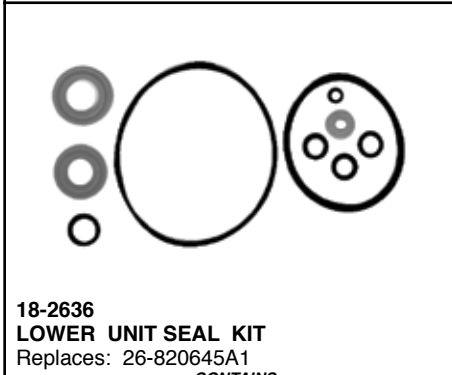

18-2636
LOWER UNIT SEAL KIT
Replaces: 26-820645A1

— CONTAINS —

PART #	DESC.	O.E. #	QTY.
18-0500	Seal	26-817472	1
18-0502	Seal	26-819396	1
18-0503	Seal	26-F40307-2	1
18-2945	Washer	12-19183	2
18-7116	O-Ring	25-62704	1
18-7134	O-Ring	25-F40342	1
18-7141	O-Ring	25-25007	1
18-7952	O-Ring	25-88657	1

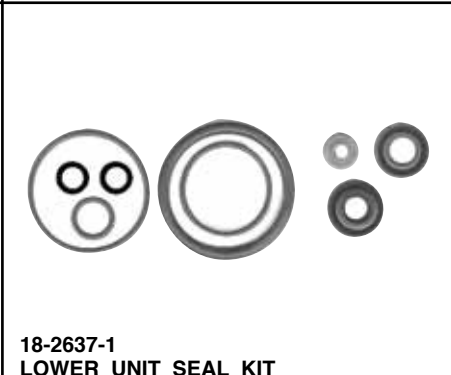

18-2637-1
LOWER UNIT SEAL KIT
Replaces: FK1064

— CONTAINS —

PART #	DESC.	O.E. #	QTY.
18-0500	Seal	26-817472	1
18-0592	Seal	26-F318307	1
18-2945	Washer	12-19183	2
18-7149	O-Ring	25-525555	1
18-7171	O-Ring	25-F525305	1
18-7191	O-Ring	25-F474342	1



18-2638
LOWER UNIT SEAL KIT
Replaces: FK1065

— CONTAINS —

PART #	DESC.	O.E. #	QTY.
18-0500	Seal	26-817472	1
18-0584	Seal	26-66022, 26-F346118	1
18-0593	Seal	26-F901307-2	2
18-0623	Lower Unit Gasket	27-F286555	1
18-2945	Washer	12-19183	3
18-7138	O-Ring	25-F455305	1

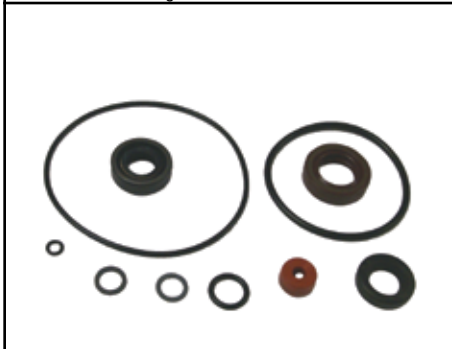

18-2639
LOWER UNIT SEAL KIT
Replaces: FK1068

— CONTAINS —

PART #	DESC.	O.E. #	QTY.
18-0584	Seal	26-66022	1
18-2945	Washer	12-19183	2
18-7134	O-Ring	25-F498618	1
18-7141	O-Ring	25-25007	1
18-7176	O-Ring	25-90011	1

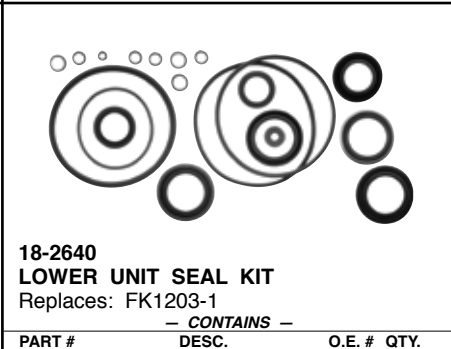

18-2640
LOWER UNIT SEAL KIT
Replaces: FK1203-1

— CONTAINS —

PART #	DESC.	O.E. #	QTY.
18-0500	Seal	26-817472	1
18-2014	Seal	26-F694305	1
18-2076	Seal	26-12224	1
18-2077	Seal	26-14077	1
18-2945	Washer	12-19183	3
18-7426	Grommet	25-30271	1
18-7127	O-Ring	25-F84305	1
18-7134	O-Ring	25-F498618	1
18-7169	O-Ring	25-F24278	1
18-7176	O-Ring	25-F74305	1
18-7413	O-Ring	25-62702	4



18-2697-1
LOWER UNIT SEAL KIT
Replaces: 26-41365A3

— CONTAINS —

PART #	DESC.	O.E. #	QTY.
18-0581	Oil Seal	26-41365	2
18-0584	Oil Seal	26-66022	1
18-0585	Oil Seal	26-821928	1
18-0586	Oil Seal	26-99325	1
18-2728	Water Tube Seal	26-42102-1	1
18-2945	Washer	12-19183	2
18-3149	Water Pump Base	46-42040A5	1
18-4261	Washer	19643	1
18-7162	O-Ring	25-33145	1

APPLICATION ON NEXT PAGE

CHRYSLER/FORCE LOWER UNIT SEAL KIT APPLICATION

Model/HP	Year	Seal Kit	Model/HP	Year	Seal Kit	Model/HP	Year	Seal Kit	Model/HP	Year	Seal Kit
6/7.5	1978-Up	18-2637	35 B	1989-91	18-2636	75	1975-79	18-2631	105	1979-83	18-2632
9.9/15	1997 & prior	18-2638	40	1992-94	18-2636	75	1980-83	18-2632	120	1990-94	18-2640
9.9/15	1998	18-2697-1	50	1984-94	18-2636	75	1996-98	18-2635	120	1995-99	18-2626
20/25	1972-78	18-2639	55	1972 1/2-1974	18-2636	75	1999	18-2626	125 ③	1983-89	18-2632
25	1989	18-2636	55 ②	1978-82	18-2630	85	1980-89	18-2632	125 D & E	1989	18-2640
25	1996-97	18-2624	55 ①	1983	18-2633	85 L Drive	1989	18-2640	125 L Drive	1989	18-2640
25	1998	18-2629	60 ②	1984 & Prior	18-2630	90	1974-77	18-2631	150	1989-94	18-2640
35	1970-72	18-2630	60 ①	1985	18-2633	90	1983	18-2632	① With one piece lower units ② With two piece lower units ③ 1989 A,B,C Models Only		
35	1972 1/2	18-2636	65 ①	All	18-2633	90	1990-94	18-2640			
35	1973	18-2630	70	1970-73	18-2631	90	1995-99	18-2626			
35	1974-75	18-2636	70	1979	18-2631	90 L Drive	1990-91	18-2640			
35	1986-91	18-2639	70	1991-95	18-2635	105	1970-76	18-2631			

①8-3701D



18-3701 PROP NUT KIT — CONTAINS —

Part #	O.E. #	Description	QTY.
18-3200	F697140	Tab Washer	2
18-3700	F7000	Prop Nut	1

PROP NUT & TAB WASHER APPLICATION

HP	Year	Model Type	Tab Washer	Prop Nut	Prop Nut Kit
90 ④	1990	A	—	18-3700	—
90	1990	B, C	18-3200	18-3700	18-3701
90	1991	ALL	18-3200	18-3700	18-3701
90 L-Drive	1990	C	18-3200	18-3700	18-3701
90 L-Drive	1991	ALL	18-3200	18-3700	18-3701
120	1990	A	—	18-3700	—
120	1990	B,C	18-3200	18-3700	18-3701
120	1991	ALL	18-3200	18-3700	18-3701
120 L-Drive	1990	ALL	18-3200	18-3700	18-3701
120 L-Drive	1991	B,D	18-3200	18-3700	18-3701
125 L-Drive	1989	ALL	—	18-3700	—
150	1989	ALL	—	18-3700	—
150	1990	A	—	18-3700	—
150	1990	B, C, D	18-3200	18-3700	18-3701
150	1991	ALL	18-3200	18-3700	18-3701

④ 903F90A, X90A, 908F90A, X90A Models only.



18-4446 PROP WRENCH KIT (18-4444 Wrench Only)

— CONTAINS —

Part #	Desc.	QTY.
18-3200	Tab Washer	2
18-3700	Prop Nut	1
18-4444	Prop Wrench	1

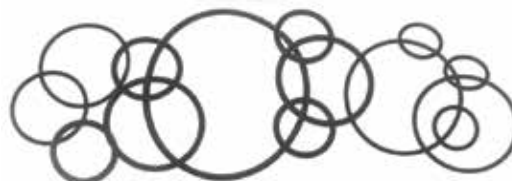

O-RINGS

PART NO.	O.E. NO.	DIMENSIONS (IN)	
		I.D.	WIDTH
18-7120	25-F498618	.215	.065
18-7127	25-F84305	3.315	.135
18-7134 ●⑦	25-F40342	.500	.100
18-7169 ●⑦	25-F24278	3.500	.135
18-7176 ●⑦	25-F74305	2.160	.100
18-7457	25-F455305	1.799	.103
18-7950	25-45258	9.843	.984
18-7952 ●⑦	25-88657	2.4803	.1378
18-7956 ●⑦	25-85549	2.4803	.1969
18-7100 ●⑦	25-85594	.2362	.1575

● PKG OF 5



OIL SEALS

PART NO.	O.E. NO.	PART NO.	O.E. NO.
18-0500	26-817472	18-0583	26-43035
18-0501	26-819394	18-0584	26-66022, 26-F346118
18-0502	26-819396	18-0586	26-99325
18-0503	26-F40307-2	18-0592	26-F318307
18-0512	26-F84307-1	18-0593	26-F901307-2
18-0579	26-41131	18-8347	26-816464-1
18-0580	26-41132	18-8354	26-828627

⑥ Items ending in "D" are Display Packaged - Regular number is Non-Display

⑦ This product is priced per piece. To order priced per package, please add -9 to the part number.

Honda Model Number Identification

	Manufacturer	Horse-power	Model Year	Shaft Length	Steering System	Market
BF2	BF = Honda	EX: 2	DX = 1999 DY = 2000 D1 = 2001 D2 = 2002 D3 = 2003 D4 = 2004 D5 = 2005 D6 = 2006 DK0 = 2007-up	S = 15" L = 20"	H = Throttle Grip C = Centrifugal Clutch	A = American

EXAMPLE: BF2D1SCHA = Honda, 2 HP, 2001 Model, 15", Centrifugal Clutch w/Throttle Grip, American

	Manufacturer	Special Features	Horse-power	Model Year	Shaft Length	Steering System	Starter	Market
BF5- BF20	BF = Honda	P = High Thrust Propeller = Standard Propeller	EX: 5 20	D1 = 2001 D2 = 2002 D3 = 2003 D4 = 2004 D5 = 2005 D6 = 2006 DK0 = 2007-up	S = 15" L = 20" XL = 25"	H = Throttle Grip C = Centrifugal Clutch	S = Electric = Manual T = Electric w/ Power Tilt	A = American

EXAMPLE: BFP5D1LHSA = Honda, High Thrust Prop., 5 HP, 2001 Model, 20", Throttle Grip, Elec. Start, American

	Manufacturer	Horse-power	Model Year	Shaft Length	Steering System	Tilt & Trim	Market
BF25- BF225	BF = Honda	EX: 25 115 225	AX = 1999 AY = 2000 A1 = 2001 A2 = 2002 A3 = 2003 A4 = 2004 A5 = 2005 A6 = 2006 K0 = 2007-up	S = 15" L = 20" X = 25" XX = 30"	R = Remote Control H = Tiller Handle	T = Tilt & Trim = Manual Tilt J = Jet Drive	A = American

EXAMPLE: BF25A1LRTA = Honda, 25 HP, 2001 Model, 20", Remote Control, Tilt & Trim, American

NOTE: After the 2006 model year Honda Marine dropped specific year designations.

 18-7494 COIL Replaces: 30520PNA007 Fits: 130/135/150/105 jet/ & 150 HP VTEC 1998-2007	 18-5225 SPARK PLUG WIRE KIT Kit includes 25 ft. Roll of 7 MM Hypalon Ignition Wire With a Metallic Core and a Large Assortment of Three Different End Fittings to Fit Outboard Motors.	 18-5226 IGNITION WIRE Metallic Core 100' Spool 7mm Hypalon	 18-5224 18-5224-9① SPARK PLUG WIRE TERMINAL PKG. OF 10	
 18-5750 18-5750-9① UNIVERSAL SPARK PLUG BOOTS Supplied complete with Terminal Connector PKG. OF 10	 18-5752 UNIVERSAL SPARK PLUG BOOT (8mm)	 18-6258 TILT/TRIM MOTOR Replaces: 36120-ZV5-821 Fits: BF35, BF40, BF45, BF50 (1992-Up)	 18-6793 TRIM MOTOR Replaces: 36120-ZV5-822 Fits: 40, 50 H.P. (2002-03)	
 18-6823 WIRING HARNESS Replaces: Universal Converts 3-wire Tilt and Trim motors to 2-Wire design	 18-6865 COMPLETE TRIM ASSEMBLY Replaces: Honda Universal Fits: Engines with 3-Ram Trim Assembly, 115-225HP Johnson/Evinrude Engines	 18-6433 OUTBOARD STARTER Replaces: 31200-ZV5-013 Fits: 40 H.P. (1999-Up)	 18-6959 STARTER Replaces: 31200-ZY6-003, 31200-ZY9-003, 31200-ZY9A-0031, Fits: 75-150HP 2004-2010	 18-6837 TRIM MOTOR Replaces: 36120-ZV5-822 Fits: 40-50HP 4-Stroke Engines

① Priced per Package

FUEL WATER SEPARATORS



Sierra offers a complete line of 10 and 21 micron fuel water separating filters including drainable bowl filters to protect your carbureted and fuel injected engine.

Refer to pages 126-130 for a complete listing of OEM and universal applications.

Sierra fuel water separators remove over 99.8% of emulsified water from your gasoline. Sierra's 10 micron filters are over 90% efficient at removing particles as small as 10 micron. All filters flow @ 90 GPH to feed even the hungriest motor. Sierra 10 micron filters are recommended to prevent damage to sensitive inboard and outboard fuel injection systems.

Sierra #	Honda #	Description
18-7947	17670-ZW1-030GH	Spin on Replacement Filter
18-7948	17670-ZW1-801AH	Spin on Replacement Filter
18-8225	16910-GB2-005	Fuel Filter
18-8226	16910-ZV4-015	Fuel Filter
18-7720	16900-SR3-004	Fuel Filter
18-7786	16900-SA5-004	Fuel Filter Kit
18-7785	16010-ST5-993	Fuel Filter Kit



18-7657 OXYGEN SENSOR
Replaces: 35655-ZY3-013



18-7658 OXYGEN SENSOR
Replaces: 35655-ZY9-003



18-7659 OXYGEN SENSOR
Replaces: 35668-ZY6-003

9' LENGTH COMPLETE FUEL LINE ASSEMBLIES

3/8"
FUEL LINE ASSEMBLY

18-81042EP-1 SILVERADO 4000 Premium OE# 17700-ZW9-010 17700-ZW9-020



18-80400 TANK CONNECTOR
(SOLD SEPARATELY)

*



18-80401 FUEL CONNECTOR



18-8005EP-1 PRIMER BULB



18-80403 FUEL CONNECTOR























*

FUEL LINE ASSEMBLY COMPONENTS

Honda Fuel Application: 8, 9.9, 15, 25, 30, 40, 50, 75, 90, 115, 130 HP (2001-02)









* Tanks and Engines for picture purpose only.

 <p>18-8002EP-1 18-8002EP-1-10 PRIMER BULB 1/4"</p>	 <p>18-8004EP-1 18-8004EP-1-10 PRIMER BULB 5/16" Large capacity bulb</p>	 <p>18-8005EP-1 18-8005EP-1-10 PRIMER BULB 3/8" Replaces: 174512 Large capacity bulb</p>	 <p>18-80400 TANK CONNECTOR Replaces: 16977-ZV5-A00 Male tank outlet, new style, 1/4"NPT, nickel plated brass. Male connector, for fuel tank. Mates with 18-80401</p>
 <p>18-80403 FUEL CONNECTOR Female 3/8 hose connector with rectangular locking post. Will not interchange with OE's 5/16" hose assemblies. For late model engine: For use with our 18-81042 fuel hose assembly, motor end. Mates with 18-80407</p>	 <p>18-80406 FUEL CONNECTOR Replaces: 16977-ZV5-900 Male tank outlet, old style, 1/4" NPT.</p>	 <p>18-80408 FUEL CONNECTOR Replaces: 17650-ZW9-003 Female 5/16" connector with rectangular locking post. Fits late model engines Mates with 18-80407</p>	 <p>18-80420 FUEL CONNECTOR Replaces: 17650-921-003ZB Fits: BF5/BF8A 2001 and earlier Mates with 17710-881-00ZA</p>
 <p>18-80407 FUEL CONNECTOR Replaces: 17710-ZW9-033 5/16 with interlocking post Fits: BF8-BF130 (2003) Mates with 18-80403, 18-80408</p>	 <p>18-7050 CARB KIT Replaces: Honda Kit 1 Fits: BF9.9(2000 & below), BF15(2002 & below)</p>	 <p>18-7051 CARB KIT Replaces: Honda Kit 2 Fits: BF9.9(2001 & Up), BF15(2003 & Up)</p>	 <p>18-7052 CARB KIT Replaces: Honda Kit 3 Fits: BF75(1997 & Up), BF90(1997 & Up)</p>
 <p>18-7053 CARB KIT Replaces: Honda Kit 4 Fits: BF8(2001 & Up), BF9.9(All), BF15(All), BF20(2003 & Up), BF25(All), BF30(All), BF35(1997), BF40(All), BF45(1997), BF50(All), BF75(1997 & Up), BF90(1997 & Up)</p>	 <p>18-7047 NEEDLE VALVE Replaces: Honda 16011-ZV4-005 Fits: BF8(2001 & Up), BF9.9(All), BF15(All), BF20(2003 & Up), BF25(All), BF30(All), BF35(1997), BF40(All), BF45(1997), BF50(All), BF75(1997 & Up), BF90(1997 & Up)</p>	 <p>18-7048 NEEDLE VALVE Replaces: Honda 16011-881-741 Fits: BF5(2003 & below), BF8(All), BF75(1997 & below), BF100(1997 & below)</p>	 <p>18-3627 THERMOSTAT Replaces: 19300-881-761 For: BF5A1, BF5A2, BF5A3, BF5A4, BF5A5, BF5A6, BF5AH, BF5AK, BF5AK0, BF5AM, BF5AW, BF5AX, BF5AY, BF8A3, BF8A4, BF8A5, BF8A6, BF8AH, BF8AK, BF8AK0, BF8AM, BF8AW, BF8AX, BF8AY, BF9.9AH, BF9.9AK, BF9.9AM, BF9.9AW, BF9.9AX, BF9.9AY, BF15A1, BF15A2, BF15AH, BF15AK, BF15AM, BF15AW, BF15AX, BF15AY, BF50F, BF75E, BF75F, BF100E, BF100F</p>
 <p>18-3628 THERMOSTAT Replaces: 19300-ZW9-003 For: BF8D1, BF8D2, BF8D3BF15D3, BF15D4, BF15D5, BF15D6, BF15DK0, BF20D3, BF20D4, BF20D5, BF20D6, BF20DK0, BF25D4, BF25D5, BF25D6, BF25DK0, BF30D4, BF30D5, BF30D6, BF30DK0, BF40A4, BF40A5, BF40A6, BF40AK0, BF40D, BF50A4, BF50A5, BF50A6, BF50AK0, BF50D, BF60A, BFP60A, BF75DK0, BF90DK0, BF200A2, BF225A2</p>	 <p>18-3629 THERMOSTAT Replaces: 19300-881-741 For: BF8AM, BF8AW, BF8AX, BF8AY, BF8A3, BF8A4, BF8A5, BF8A6, BF8AK0, BF75, BF75A, BF75B, BF75C, BF75D, BF75E, BF75F, BF75K1, BF75K2, BF75K3, BF75Z, BF100, BF100A, BF100B, BF100C, BF100D, BF100E, BF100F, BF100Z</p>	 <p>18-3630 THERMOSTAT Replaces: 19300-ZV5-043 For: BF25A, BF25A1, BF25A2, BF25A3, BF25AW, BF25AX, BF25AY, BF30A, BF30A1, BF30A2, BF30A3, BF30AW, BF30AX, BF30AY, BF35AM, BF40A, BF40A1, BF40A2, BF40A3, BF40AW, BF40AX, BF40AY, BF45AM, BF50A, BF50A1, BF50A2, BF50A3, BF50AW, BF50AX, BF50AY, BF75A1, BF75A2, BF75A3, BF75A4, BF75A6, BF75AT, BF75AW, BF75AX, BF75AY, BF90A1, BF115A1, BF115A2, BF115AX, BF115AY, BF130A1, BF130A2, BF130AX, BF130AY</p>	 <p>18-3031 IMPELLER Replaces: 19210-ZY3-003 Fits: BF200 & BF225 (2002 & Up)</p>

① Discount shop pack of 10 - Priced per package





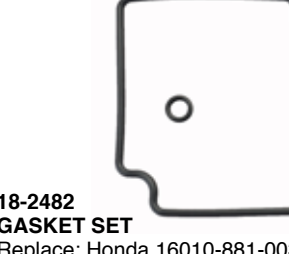











 <p>18-3100 IMPELLER Replaces: 19210-ZW9-013, 19210-ZW9-003 Fits:BF8D/9.9D short, long shaft</p>	 <p>18-3056 18-3056-10^① IMPELLER Replaces: 19210-ZW1-003 For: 75-90 HP</p>	 <p>18-3245 IMPELLER Replaces: 19210-881-A01, 19210-881-A02 For: 5, 7.5, 8, 10 HP</p>	 <p>18-3246 IMPELLER Replaces: 19210-ZV4-013 For: BF9.9, BF15, AH, AK, AM, AW Series # 14ZV40M</p>
 <p>18-3247 IMPELLER Replaces: 19210-ZV4-651 For: 8, 9.9, 15 HP</p>	 <p>18-3248 IMPELLER Replaces: 19210-ZV5-003 For: 35, 40, 45, 50 HP</p>	 <p>18-3249 IMPELLER Replaces: 19210-ZV7-003 For: 20, 25, 30 HP</p>	 <p>18-3250 IMPELLER Replaces: 19210-ZW1-B04 For: 75, 90, 115, 130 HP</p>
 <p>18-3268 IMPELLER KEY Replaces: 90752-ZV4-650 Fits: BF9.9A, BF15A</p>	 <p>18-3269 IMPELLER KEY Replaces: 90752-ZV7-000 Fits: BF25, BF30</p>	 <p>18-3270 IMPELLER KEY Replaces: 90752-ZV5-003 Fits: BF35, BF40, BF45, BF50</p>	 <p>18-3271 IMPELLER KEY Replaces: 90752-ZW1-B02 Fits: BF75-BF90 AX & Up, BF115, BF130</p>
 <p>18-3273 IMPELLER KEY Replaces: 90752-ZY3-003 Fits: BF200, BF225</p>	 <p>18-3122 IMPELLER PLATE Replaces: 19231-ZW1-003 For: 75-90 HP</p>	 <p>18-3187 IMPELLER REPAIR KIT Replaces: 06192-ZW1-305 Fits:BF75-90, (1996-98)</p>	 <p>^①18-3214D  WATER PUMP KIT For: BF 70/BF 90 1996-98</p>
 <p>18-3278 WATER PUMP SERVICE KIT Replaces: 06192-ZV1-C00 Fits: BF5</p>	 <p>18-3279 WATER PUMP SERVICE KIT Replaces: 06192-881-C00 Fits: BF8A (USA)</p>	 <p>18-3279 WATER PUMP SERVICE KIT Replaces: 06192-881-C00 Fits: BF8A (USA)</p>	 <p>18-3280 WATER PUMP SERVICE KIT Replaces: 06192-ZV4-000 Fits: BF9.9A/BF15A</p>

① Items ending in "D" are Display Packaged - Regular number is Non-Display

 <p>18-3281 WATER PUMP SERVICE KIT Replaces: 06192-ZV7-000 Fits: BF25/30</p>	 <p>18-3282 WATER PUMP SERVICE KIT Replaces: 06192-ZV5-003 Fits: BF35/45, BF40/50</p>	 <p>18-3283 WATER PUMP SERVICE KIT Replaces: 06192-ZW1-000 Fits: BF115/130, BF75/90 AX & Later</p>	 <p>18-3284 WATER PUMP SERVICE KIT Replaces: 06192-ZY6-000 Fits: BF135 / BF150</p>
 <p>18-3285 WATER PUMP SERVICE KIT Replace: 06192-ZY3-000 Fits: BF200/225</p>	 <p>18-2495 WATER PUMP GASKET Replace: 19232-ZV4-610 Fits: BF9.9A, BF15A</p>	 <p>18-2496 WATER PUMP GASKET Replace: 19233-ZV5-000 Fits: BF25, BF30</p>	 <p>18-2499 WATER PUMP GASKET Replace: 19234-ZY3-000 Fits: BF200, BF225</p>
 <p>18-2524 WATER PUMP GASKET Replace: 19232-ZV1-A10 Fits: BF5</p>	 <p>18-2608 WATER PUMP GASKET Replace: 19232-881-850 Fits: BF8A</p>	 <p>18-2609 WATER PUMP GASKET Replace: 19234-881-850 Fits: BF8A</p>	 <p>18-0176 WATER PUMP GASKET Replace: 19242-ZV5-000</p>
<p>PKG. OF 2</p>  <p>18-2563 18-2563-9① IMPELLER GASKET Replaces: 19232-ZW1-003</p>	<p>PKG. OF 2</p>  <p>18-2564 18-2564-9① IMPELLER GASKET Replaces: 19234-ZW1-003</p>	<p>PKG. OF 2</p>  <p>18-2565 18-2565-9① IMPELLER GASKET Replaces: 19242-ZW1-003</p>	
 <p>18-2480 GASKET SET Replace: Honda 16010-ZV4-005 Fits: BF8(2001), BF9.9(2001 & below), BF15(2002 & below), BF25(All), BF30(All), BF35(1997), BF40(All), BF45(1997), BF50(All), BF75(1997-06), BF90(1997-06)</p>	 <p>18-2481 GASKET SET Replace: Honda 16010-ZW9-003 Fits: BF8(2002 & Up), BF9.9(2002 & Up), BF15(2003 & Up), BF20(2003 & Up)</p>	 <p>18-2482 GASKET SET Replace: Honda 16010-881-003 Fits: BF5(2003 & below), BF8(2000 & below, 2003 & Up), BF50(1996 & below), BF75(1996 & below), BF100(1996 & below)</p>	

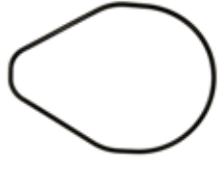
SEE PAGES 166-167 FOR OUR COMPLETE LINE OF GASKET SEALANTS

① Priced Per Package

 <p>18-2470 CARB MOUNTING GASKET Replace: Honda 16221-ZV4-610 Fits: BF9.9 (2000 & below), BF15 (2002 & below)</p>	 <p>18-2471 CARB MOUNTING GASKET Replace: Honda 16221-ZW9-000 BF8(2001 & Up), BF9.9(2001 & Up)</p>	 <p>18-2472 CARB MOUNTING GASKET Replace: Honda 16221-ZW1-000 Fits: BF75(1997-06), BF90(1997-06)</p>	
 <p>18-2473 CARB MOUNTING GASKET Replace: Honda 16201-881-850 Fits: BF8(2000 & below, 2003 & Up), BF75(1996 & below), BF100(1996 & below)</p>	<p>PKG. OF 2</p>  <p>18-2945 18-2945-9① 18-29451-9① (PKG. OF 50) DRAIN SCREW GASKET Used with 18-2244 Drain Screw</p>	 <p>18-0300 INTAKE MANIFOLD GASKET Replaces: 17105-ZY6-000 Fits: BF135-BF150</p>	 <p>18-0390 INTAKE MANIFOLD GASKET Replaces: 17105-ZY3-004 Fits: BF200-BF225 (2002 and UP)</p>
 <p>18-0248 INTAKE MANIFOLD GASKET Replaces: 17151-ZW5-000</p>	 <p>18-0382 THROTTLE BODY GASKET Replaces: 17109-ZY6-000 Fits: -BF75-BF150</p>	 <p>18-0396 THROTTLE BODY GASKET Replaces: 17109-ZY3-004 Fits: BF200-BF225 (2002 & UP)</p>	 <p>18-0737 THROTTLE BODY GASKET Replaces: 16176-POA-004</p>
 <p>18-3288 SEAL Replace: 91252-ZV1-003 Fits: BF5</p>	 <p>18-8298 SEAL Replaces: 91252-935-004 Fits: BF8A</p>	 <p>18-8299 MOLDED RUBBER SEAL (O-Ring Material) Replace: 91356-ZY3-003 Fits: BF200, BF225</p>	
 <p>18-1156 FORWARD GEAR BEARING Replaces: 91051-ZW1-003</p>	 <p>18-1157 FORWARD GEAR INNER BEARING Replaces: 91057-ZW1-003</p>	 <p>18-1158 CARRIER BEARING Replaces: 91053-ZW1-003</p>	

SEE PAGES 166-167 FOR OUR COMPLETE LINE OF GASKET SEALANTS

① Priced per Package

 <p>18-7909 OIL FILTER Replaces: 15400-POH-305PE, 15400-POH-305, 15400-ZJI-004, 15400-PLM-A01PE</p>	 <p>18-7913 OIL FILTER Replaces: 15400-PFB-014</p>	 <p>18-7911-1 OIL FILTER Replaces: 15400-PFB-007</p>
--	--	---



Models	Years	SS Number	Replace	Part #	Models	Years	SS Number	Replace	Part #
BF8D, BFP8D	2001-Current	15400-PFB-004	15400-PFB-014	18-7913	BF25	1999-Current	15400-ZW4-003	15400-PFB-007	18-7911-1
BF9D, BFP9D	2001-Current	15400-PM3-004	15400-PFB-014	18-7913	BF30	1999-Current	15400-ZW4-003	15400-PFB-007	18-7911-1
BF15D, BFP15D	2003-Current	15400-PM3-405	15400-PFB-014	18-7913	BF40	1999-Current	15400-ZW4-003	15400-PFB-007	18-7911-1
BF20D	2003-Current	15400-PJ7-015	15400-PFB-014	18-7913	BF50	1999-Current	15400-ZW4-003	15400-PFB-007	18-7911-1
BF25A	1998-Earlier	15400-PJ7-005	15400-PFB-014	18-7913	BF75, BF90	1997-Current	15400-POH-305PE	15400-PLM-A01PE	18-7909
BF30A	1998-Earlier	15400-PJ7-005	15400-PFB-014	18-7913	BF115, BF130	1999-Current	15400-POH-305	15400-PLM-A01PE	18-7909
BF35AM	1998-Earlier	15400-PJ7-005	15400-PFB-014	18-7913	BF135, BF150	2004-Current	15400-ZJ1-004	15400-PLM-A01PE	18-7909
BF40A	1998-Earlier	15400-PJ7-005	15400-PFB-014	18-7913	BF200, BF225	2002-Current	15400-ZJ1-999AH	15400-PLM-A01PE	18-7909
BF45AM	1998-Earlier	15400-PJ7-005	15400-PFB-014	18-7913					
BF50A	1998-Earlier	15400-PJ7-005	15400-PFB-014	18-7913					

**Zinc is for saltwater only applications.
Magnesium is for fresh water only applications.
Aluminum is for brackish water, or if boat is used in both fresh and salt environments.**

 <p>③ 18-6025 ANODE Replaces: 41107-ZV5-00 For use on extension cases: BF25, BF30, BF35, BF40, BF45, BF50 (1997-Up)</p>	 <p>② 18-6241 ③ 18-6011 ① 18-6011A ANODE Replaces: 41107-ZW1-003ZA BF75-BF90 (1997-98)</p>	 <p>③ 18-6068 ANODE Replaces: 41109-ZW1-003 BF75-BF90 (1997-98)</p>
---	---	---

<p>PKG. OF 10</p>  <p>18-3200 18-3200-9④ TAB WASHER Replaces: 90508-ZW1-003 For: 75-90 HP</p>	<p>⑤ 18-3701D Display Package</p>  <p>18-3701 PROP NUT KIT — CONTAINS — Part # O.E. # Description 18-3200 90508-ZW1-003 Tab Washer 18-3700 90301-ZW1-003 Prop Nut</p>	<p>PKG. OF 5</p>  <p>18-7198 18-7198-9④ O-RING Replaces: 91353-ZW1-003</p>
---	--	--

<p>OIL SEALS</p> <table border="1" style="width: 100%; border-collapse: collapse;"> <thead> <tr> <th>Part #</th> <th>Description</th> <th>O.E. #</th> </tr> </thead> <tbody> <tr> <td>18-0522</td> <td>Drive Shaft</td> <td>91254-ZW1-003</td> </tr> <tr> <td>18-0583</td> <td>Drive Shaft</td> <td>91251-ZW1-003</td> </tr> <tr> <td>18-2002</td> <td>Prop Shaft</td> <td>91252-ZW1-003</td> </tr> <tr> <td>18-2053</td> <td>Prop Shaft</td> <td>91255-ZW1-003</td> </tr> <tr> <td>18-2054</td> <td>Shift Shaft</td> <td>91253-ZW1-003</td> </tr> </tbody> </table>	Part #	Description	O.E. #	18-0522	Drive Shaft	91254-ZW1-003	18-0583	Drive Shaft	91251-ZW1-003	18-2002	Prop Shaft	91252-ZW1-003	18-2053	Prop Shaft	91255-ZW1-003	18-2054	Shift Shaft	91253-ZW1-003	 <p>18-8362-1 LOWER UNIT SEAL KIT For: Series 14ZV50M</p>
Part #	Description	O.E. #																	
18-0522	Drive Shaft	91254-ZW1-003																	
18-0583	Drive Shaft	91251-ZW1-003																	
18-2002	Prop Shaft	91252-ZW1-003																	
18-2053	Prop Shaft	91255-ZW1-003																	
18-2054	Shift Shaft	91253-ZW1-003																	

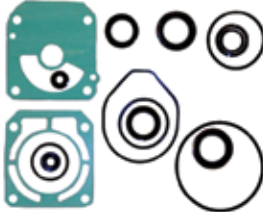
 <p>18-8363 LOWER UNIT SEAL KIT</p>	 <p>18-8365 LOWER UNIT SEAL KIT</p>	 <p>18-8366 LOWER UNIT SEAL KIT</p>										
<p>LOWER UNIT SEAL KIT APPLICATION</p> <table border="1" style="width: 100%; border-collapse: collapse;"> <thead> <tr> <th>HP/Model</th> <th>Part #</th> </tr> </thead> <tbody> <tr> <td>BF 9.9, BF 15</td> <td>18-8363</td> </tr> <tr> <td>BF 35/45 AM, BF 40/50 A, AW, AX</td> <td>18-8362-1</td> </tr> <tr> <td>BF 75, BF 90</td> <td>18-8366</td> </tr> <tr> <td>BF115, BF130</td> <td>18-8365</td> </tr> </tbody> </table>			HP/Model	Part #	BF 9.9, BF 15	18-8363	BF 35/45 AM, BF 40/50 A, AW, AX	18-8362-1	BF 75, BF 90	18-8366	BF115, BF130	18-8365
HP/Model	Part #											
BF 9.9, BF 15	18-8363											
BF 35/45 AM, BF 40/50 A, AW, AX	18-8362-1											
BF 75, BF 90	18-8366											
BF115, BF130	18-8365											

SEE PAGES 152-158 FOR ADDITIONAL OIL FILTER INFORMATION

① Aluminum ② Magnesium ③ Zinc ④ Priced per Package
⑤ Items ending in "D" are Display Packaged - Regular number is Non-Display

Johnson/Evinrude Model Identification

Outboards 1980-1998

Model Variation	Style	Horse-power	Design Feature	Shaft Year Length	Built
A = Australia B = Belgium C = Canada H = Hong Kong S = South Africa T = Tracker V = Boat Builder	J = Johnson E = Evinrude C = Commercial V = Quiet Rider	Example: 20 40 200	AE = Elec. Start - Alaska AR = Rope Start - Alaska BA = AC Lighting - Rope Start BE = Belgium Derated - Elec. Start BF = Belgium Derated - Rope Start BG = Belgium Derated - Rope Start BI = Belgium Derated - Rope Start BR = Euro Rope Start C = Counter Rotation CE = Canada Derated - Elec. Start CR = Canada Derated - Rope Start D = Remote Electric DE = Derated - Elec. Start DR = Derated - Rope Start DT = Derated - Elec. Start/Trim & Tilt E = Elec. Start ER = Elec. Start - Sport Styling ES = Elec. Start - Special FA = 4-stroke - Rope Start FE = 4-stroke - Elec. Start/Remote FP = Commercial w/Program Tilt FR = 4-stroke - Rope Start FRE = 4-stroke - Elec. Start/Remote FS = FICHT - Trim & Tilt FT = FICHT - Trim & Tilt/Special Styling G = Special Styling H = Less Integral Tank/Hydraulic Steering I = FICHT Fuel Injection IE = Italy Elec. Start IK = Italy Elec. Start J = Jet Drive K = 3-CYL 25/35 KC = Kerosene Rope Start KG = Kerosene/Gasoline KS = Kerosene Rope Start M = Manual Tilt - Elec. Start MS = Manual Tilt - Elec. Start/Special N = Counter Rotation P = Power Steering Q = 3-CYL 25/35 Trim & Tilt R = Rope Start RA = Australia Rope Start RC = Rope Start - Commercial/CD Ignition RD = Rope Start - Deluxe RE = Remote Elec. RP = Commercial w/Program Tilt RS = Rope Start - Commercial RW = Commercial w/Program Tilt S = Sail - Special Styling SC = Special Styling/Counter Rotation SE = Elec. Start Non-Tilt Sail SI = Italy Special Derated SL = 60 Degree V - Trim & Tilt SP = Special Styling SR = Rope Start - Sail - Non-Tilt ST = Special Styling - Trim & Tilt T = Trim & Tilt - Elec. Start TE = Tiller Elec. TR = Trim & Tilt - Sport styling TT = Tiller - Trim & Tilt U = Manual Tilt V = Special Gearcase W = 110 Degree Angle Drive - Rope Start WM = Elec. Commercial - Manual Tilt WMP = Same as "WM" w/Chrome Pump WT = Elec. Commercial - Trim & Tilt WTP = Same as "WT" w/Chrome Pump	= 15" L = 20" Y = 22.5" X = 25" Z = 30"	I = 1 N = 2 T = 3 R = 4 O = 5 D = 6 U = 7 C = 8 E = 9 S = 0 EX: CS = 1980 ES = 1990 EU = 1997 SC = 2008

EXAMPLE: VE70TLEDA - Boat Builder Model, Evinrude, 70 HP, Trim & Tilt w/Elec. Start, 1996 Model

MODEL IDENTIFICATION CHART CONTINUED ON NEXT PAGE

Johnson/Evinrude Model Identification

Outboards 1999 and Newer

Style	Horse-power	Design Feature	Shaft Length	Year Built
J = Johnson E = Evinrude	Example: 20 40 200	3 = 3-CYL (25 or 35 HP) 4 = Four Stroke Engine B = Blue Paint C = Counter-Rotation w/Trim & Tilt D = E-TEC E = Electric Start w/Remote Steering F = FICHT Fuel Injection G = Graphite Paint J = Jet M = Military Model P = Power Trim & Tilt R = Rope Start w/Tiller Steering S = Special Styling (White Evinrude) T = Tiller Steering TE = Tiller Electric W = Commercial Model	= 15" L = 20" Y = 22.5" X = 25" Z = 30"	I = 1 N = 2 T = 3 R = 4 O = 5 D = 6 U = 7 C = 8 E = 9 S = 0 EX: EE = 1999 SC = 2008

EXAMPLE: E70PLEEA - Evinrude model, 70 HP, Power Trim&Tilt, 20", 1999 model

<div style="text-align: right; font-size: small;"> </div> <p>18-5001 TUNE-UP KIT Replaces: 172525</p> <table style="width: 100%; font-size: x-small;"> <tr><td colspan="4" style="text-align: center;">— CONTAINS —</td></tr> <tr> <th style="width: 15%;">Part #</th> <th style="width: 35%;">Desc.</th> <th style="width: 15%;">O.E.#</th> <th style="width: 35%;">Qty.</th> </tr> <tr> <td>18-5200</td> <td>Condenser</td> <td>580256</td> <td style="text-align: center;">1</td> </tr> <tr> <td>18-5157</td> <td>Contact set</td> <td>580290</td> <td style="text-align: center;">2</td> </tr> </table>	— CONTAINS —				Part #	Desc.	O.E.#	Qty.	18-5200	Condenser	580256	1	18-5157	Contact set	580290	2	<div style="text-align: right; font-size: small;"> </div> <p>18-5002 TUNE-UP KIT Replaces: 172523</p> <table style="width: 100%; font-size: x-small;"> <tr><td colspan="4" style="text-align: center;">— CONTAINS —</td></tr> <tr> <th style="width: 15%;">Part #</th> <th style="width: 35%;">Desc.</th> <th style="width: 15%;">O.E.#</th> <th style="width: 35%;">Qty.</th> </tr> <tr> <td>18-5205</td> <td>Condenser</td> <td>581419</td> <td style="text-align: center;">2</td> </tr> <tr> <td>18-5156</td> <td>Contact Set</td> <td>580148</td> <td style="text-align: center;">2</td> </tr> </table>	— CONTAINS —				Part #	Desc.	O.E.#	Qty.	18-5205	Condenser	581419	2	18-5156	Contact Set	580148	2	<div style="text-align: right; font-size: small;"> </div> <p>18-5003 TUNE-UP KIT Replaces: 172806</p> <table style="width: 100%; font-size: x-small;"> <tr><td colspan="4" style="text-align: center;">— CONTAINS —</td></tr> <tr> <th style="width: 15%;">Part #</th> <th style="width: 35%;">Desc.</th> <th style="width: 15%;">O.E.#</th> <th style="width: 35%;">Qty.</th> </tr> <tr> <td>18-5205</td> <td>Condenser</td> <td>581419</td> <td style="text-align: center;">2</td> </tr> <tr> <td>18-5141</td> <td>Contact Set</td> <td>581207</td> <td style="text-align: center;">2</td> </tr> </table>	— CONTAINS —				Part #	Desc.	O.E.#	Qty.	18-5205	Condenser	581419	2	18-5141	Contact Set	581207	2
— CONTAINS —																																																		
Part #	Desc.	O.E.#	Qty.																																															
18-5200	Condenser	580256	1																																															
18-5157	Contact set	580290	2																																															
— CONTAINS —																																																		
Part #	Desc.	O.E.#	Qty.																																															
18-5205	Condenser	581419	2																																															
18-5156	Contact Set	580148	2																																															
— CONTAINS —																																																		
Part #	Desc.	O.E.#	Qty.																																															
18-5205	Condenser	581419	2																																															
18-5141	Contact Set	581207	2																																															
<div style="text-align: right; font-size: small;"> </div> <p>18-5006 TUNE-UP KIT Replaces: 172522</p> <table style="width: 100%; font-size: x-small;"> <tr><td colspan="4" style="text-align: center;">— CONTAINS —</td></tr> <tr> <th style="width: 15%;">Part #</th> <th style="width: 35%;">Desc.</th> <th style="width: 15%;">O.E.#</th> <th style="width: 35%;">Qty.</th> </tr> <tr> <td>18-5199</td> <td>Condenser</td> <td>580321</td> <td style="text-align: center;">2</td> </tr> <tr> <td>18-5156</td> <td>Contact Set</td> <td>580148</td> <td style="text-align: center;">2</td> </tr> </table>	— CONTAINS —				Part #	Desc.	O.E.#	Qty.	18-5199	Condenser	580321	2	18-5156	Contact Set	580148	2	<div style="text-align: right; font-size: small;"> </div> <p>18-5011 TUNE-UP KIT Replaces: 172521</p> <table style="width: 100%; font-size: x-small;"> <tr><td colspan="4" style="text-align: center;">— CONTAINS —</td></tr> <tr> <th style="width: 15%;">Part #</th> <th style="width: 35%;">Desc.</th> <th style="width: 15%;">O.E.#</th> <th style="width: 35%;">Qty.</th> </tr> <tr> <td>18-5199</td> <td>Condenser</td> <td>580321</td> <td style="text-align: center;">1</td> </tr> <tr> <td>18-5156</td> <td>Contact Set</td> <td>580148</td> <td style="text-align: center;">1</td> </tr> </table>	— CONTAINS —				Part #	Desc.	O.E.#	Qty.	18-5199	Condenser	580321	1	18-5156	Contact Set	580148	1	<p>18-5141 CONTACT SET Replaces: 581207</p>																
— CONTAINS —																																																		
Part #	Desc.	O.E.#	Qty.																																															
18-5199	Condenser	580321	2																																															
18-5156	Contact Set	580148	2																																															
— CONTAINS —																																																		
Part #	Desc.	O.E.#	Qty.																																															
18-5199	Condenser	580321	1																																															
18-5156	Contact Set	580148	1																																															
<p>18-5156 CONTACT SET Replaces: 580148</p>	<p>18-5157 CONTACT SET Replaces: 580290</p>	<p style="text-align: center;">CONDENSER 18-5199 Replaces: 580321</p>	<p style="text-align: center;">CONDENSER 18-5200 Replaces: 580256</p>																																															

APPLICATION BEGINS ON NEXT PAGE

① Items ending in "D" are Display Packaged - Regular number is Non-Display

HP	YEARS	CONTACT SET	CONDENSER	TUNE-UP KIT	HP	YEARS	CONTACT SET	CONDENSER	TUNE-UP KIT
1.5/2 ③	1968-90	18-5156	18-5199	18-5011	28	1962-64	18-5156	18-5205	18-5002
3	1952-68	18-5156	18-5199	18-5006	30	1956	18-5156	18-5199	18-5006
4	1965-76,1981-90	18-5156	18-5199	18-5006	33	1965-70	18-5156	18-5205	18-5002
5	1965-68	18-5156	18-5199	18-5006	35	1958-59	18-5156	18-5199	18-5006
5.5	1954-64	18-5156	18-5199	18-5006	35	1976	18-5141	18-5205	18-5003
6	1965-76	18-5156	18-5199	18-5006	40	1960-61	18-5156	18-5199	18-5006
7.5	1956-58	18-5156	18-5199	18-5006	40	1962-73	18-5156	18-5205	18-5002
9.5	1964-73	18-5156	18-5199	18-5006	40	1974-76	18-5141	18-5205	18-5003
9.9/15	1974-76	18-5141	18-5205	18-5003	40COMM	1981-83	18-5141	18-5205	18-5003
10	1950-63	18-5156	18-5199	18-5006	45/50	1958-59	18-5157	18-5200	18-5001
15	1956	18-5156	18-5199	18-5006	60	1964-67	18-5157	18-5200	18-5001
18	1957-61	18-5156	18-5199	18-5006	75/80	1960-67	18-5157	18-5200	18-5001
18/20	1962-73	18-5156	18-5205	18-5002	90	1964-75	18-5157	18-5200	18-5001
25	1969-76	18-5156	18-5205	18-5002	100	1966	18-5157	18-5200	18-5001
25	1955	18-5156	18-5199	18-5006					

③ Colt and Jr.

 <p>18-5163 IGNITION COIL Replaces: 581130</p>	 <p>18-5170 IGNITION COIL Replaces: 583740</p>	 <p>18-5172 IGNITION COIL Replaces: 581786</p>	<p>① 18-5176D </p>  <p>18-5176 IGNITION COIL KIT Replaces: 582366, 583737, 584561</p>
--	--	---	---

<p>① 18-5179D </p>  <p>18-5179 IGNITION COIL Replaces: 582508</p>	<p>① 18-5181D </p>  <p>18-5181 IGNITION COIL Replaces: 582995, 584477</p>	 <p>18-5192 IGNITION COIL Replaces: 582091</p>
---	---	--

 <p>18-5193 IGNITION COIL Replaces: 582382</p>	 <p>18-5194 IGNITION COIL Replaces: 582160, 584632</p>	<p></p>  <p>18-5196 IGNITION COIL Replaces: 581407, 502880</p>
--	--	---

APPLICATION BEGINS ON NEXT PAGE

① Items ending in "D" are Display Packaged - Regular number is Non-Display

H.P.	YEARS	COIL	QTY.	H.P.	YEARS	COIL	QTY.
1.5,2, Colt,Jr.	1968-90	18-5181	1	55 Comm.	1985-92	18-5179	2
2,2.3,3.3	1995-99	18-5170	1	60	1978-84	18-5176	2
2.5	1988	18-5170	1	60	1985-01	18-5179	3
2.5 Ultra/Excel	1987-88	18-5170	1	60 SST	1989-90	18-5179	3
3, 4	1950-76	18-5181	2	3 Cyl. Thru V-8	1985-99	18-5179 ⑥	per cyl
3,4	1991-01	18-5170	1	65	1971-75	18-5194	3
4	1981-89	18-5181	1	65	1979-84	18-5176	3
4	1977-80	18-5176	1	65 Comm.	1985-01	18-5179	3
4 Deluxe	1985-99	18-5179	2	70, 75	1974-75	18-5194	3
4 Ultra/Excel	1987-90	18-5170	1	70	1979-84	18-5176	3
4.5, 6, 7.5, 8	1980-84	18-5176	2	70	1985-01	18-5179	3
4.5	1986-87	18-5179	2	75	1979-84	18-5176	3
5, 5.5, 6	1950-76	18-5181	2	75	1985-99	18-5179	3
5	1985-91	18-5179	2	85	1969-72	18-5193	1
6	1977-84	18-5176	2	85	1973-75	18-5194	4
6, 8	1985-90	18-5179	2	85, 115	1976-77	18-5192	4
6,8	1991-99	18-5170	1	85	1978-84	18-5176	4
6.5 Comm.	1989-90	18-5179	2	85	1985-95	18-5179	4
7.5	1954-58	18-5181	2	88	1987-96	18-5179	4
9.5	1964-73	18-5181	2	90	1978-84	18-5176	4
9.9/15	1974-76	18-5196	2	90	1985-94	18-5179	4
9.9/15	1977-84	18-5176	2	90,115 Looper	1995-99	18-5170	2
9.9/15	1985-92	18-5179	2	100	1971-72	18-5193	1
9.9,15	1993-99	18-5170	1	100	1978-84	18-5176	4
9.9/15 4-Stroke	1994-99	18-5176	2	100	1985-99	18-5179	4
10	1949-63	18-5181	2	110	1986-90	18-5179	4
10,14 Comm.	1989-90	18-5176	2	115	1969-70	18-5193	1
14	1988	18-5176	2	115	1973-74	18-5194	4
15, 18, 20, 25	1951-72	18-5181	2	115	1978-84	18-5176	4
18,20	1973	18-5172 ③	2	115	1985-99	18-5179	4
18,20	1973	18-5163 ③	1	120	1985-99	18-5179	4
20, 25, 30	1985-99	18-5179	2	125	1971-72	18-5193	1
25	1973-76	18-5172 ③	2	125	1991-99	18-5179	4
25	1973-76	18-5163 ③	1	125 Comm.	1989-99	18-5179	4
25	1977-84	18-5176	2	135	1973-75	18-5194	4
25 Comm.	1985-91	18-5179	2	135	1976	18-5192	4
28, 30, 33, 35	1956-70	18-5181	2	140	1977	18-5192	4
28	1987-88	18-5176	2	140	1978-84	18-5176	4
28 ⑦	1989-90	18-5179	2	140	1985-99	18-5179	4
28	1997-98	18-5170	2	150, 175, 200, 235	1976-78	18-5192	1
30	1977-84	18-5176	2	150	1979-84	18-5176	6
35	1976	18-5172	2	150	1985-99	18-5179 ⑥	6
35	1977-84	18-5176	2	150-175 V6 EFI	1997-98	18-5170	3
40	1960-73	18-5181	2	150-175 Looper	1991-99	18-5170	3
40	1974	18-5196	2	155 Comm.	1984-99	18-5179 ①	6
40	1975-83	18-5172 ②	2	175	1979-84	18-5176	6
40	1977-84	18-5176	2	175	1985-99	18-5179 ⑥	6
40 Thru 50, 2 Cyl.	1985-88	18-5179	2	185	1984-99	18-5179	6
40 Comm.	1985-90	18-5179	2	200	1979-84	18-5176	6
40 Thru 50, 2 Cyl.	1989-99	18-5170	1	200	1985-99	18-5179	6
45 Comm.	1985-92	18-5179	2	225	1986-99	18-5179	6
45 SS	1987-90	18-5179	2	235	1979-84	18-5176	6
48	1987-88	18-5179 ⑦	2	250	1991-99	18-5179	8
45	1989-96	18-5170	2	275	1985-99	18-5179	8
50	1971-75	18-5194	2	300,3.6	1985-99	18-5179	8
50	1978-84	18-5176	2	Sail Drive	1978-99	18-5176	2
50	1985-88	18-5179	2	Sea Drive	1984-85	18-5176 ⑤	2
55	1978-84	18-5176	2				

① Except loopers

② Contact controlled engines only

③ (2) 18-5172 and (1) 18-5163 required per engine

⑤ Plug In Coil Only

⑥ Except 150-175 Loop

⑦ Except SPL models



**18-5753
POWER PACK**
Replaces: 581731
(pack 4)



**18-5754
POWER PACK**
Replaces: 581726
(pack 3)



**18-5755
POWER PACK**
Replaces: 581397
(pack 2)



**18-5756
POWER PACK**
Replaces: 582056
Same as 18-5753
w/o Hardware Pack
(1) Hole Drilled



**18-5757
POWER PACK**
Replaces: 582057
Same as 18-5754
w/o Hardware Pack
(2) Holes Drilled



**18-5758
POWER PACK**
Replaces: 582453, 583380, 582452



**18-5759
POWER PACK**
Replaces: 582125



**18-5760
POWER PACK**
Replaces: 582138, 582400,
582642, 582556



**18-5761
POWER PACK**
Replaces: 583114



**18-5762
POWER PACK**
Replaces: 582115



**18-5763
POWER PACK**
Replaces: 582285, 583170



**18-5764
POWER PACK**
Replaces: 582261



**18-5765
POWER PACK**
Replaces: 396141



**18-5766
POWER PACK**
Replaces: 583748



**18-5767
POWER PACK**
Replaces: 584783



**18-5768
POWER PACK**
Replaces: 584908, 5001344



**18-5770
POWER PACK**
Replaces: 584028



**18-5771
POWER PACK**
Replaces: 584032



**18-5772
POWER PACK**
Replaces: 584041



**18-5773
POWER PACK**
Replaces: 584642



**18-5774
POWER PACK**
Replaces: 585145



**18-5780
POWER PACK**
Replaces: 585189



**18-5781
POWER PACK**
Replaces: 586661



**18-5782
POWER PACK**
Replaces: 582705



**18-5783
POWER PACK**
Replaces: 582811



**18-5784
POWER PACK**
Replaces: 583110



**18-5785
POWER PACK**
Replaces: 585261



**18-5794
POWER PACK**
Replaces: 584489, 584329,
583896, 584331



**18-5883
POWER PACK**
Replaces: 584488



**18-5885
POWER PACK**
Replaces: 583865
For: V-6 5800 rpm limit

APPLICATION BEGINS ON NEXT PAGE



**18-5886
POWER PACK & SENSOR**
Replaces: 436367, 584122
For: V6 engines with optical sensor and BLUE sleeve on power pack. Do not use with gray sleeved stator.



**18-5887
POWER PACK**
Replaces: 584985
For: V6 engines with optical sensor and GRAY sleeve on power pack. Do not use with black sleeved stator.



**18-5891
POWER PACK**
Replaces: 583605
For: 3 & 6 cyl. 6700 rpm limit



**18-5892
POWER PACK**
Replaces: 582262
For: V-4 & V-8 6700 rpm limit



**18-5893
POWER PACK**
Replaces: 586667, 584037, 586217, 583476
For: V-4 & V-8 6700 rpm limit



**18-5884
OPTICAL SENSOR**
Replaces: 586343
For: V-4 & V-6 engines



**18-9802
TIMING LIGHT**
Self-powered accurate up to 10,000 RPM's

Model	Years	Power Pack	Model	Years	Power Pack	Model	Years	Power Pack
4	1977-80,1984	18-5758	40	1985	18-5765	90	1988	18-5892
4	1993	18-5883	40	1986-88	18-5763	100	1971	—
4 DLX	1986-88, 1994-99	18-5763	40	1991-93	18-5794	100	1968,1972	—
4.5	1980-84	18-5758	40			100	1979-80	18-5759 ①
4.5	1986-87	18-5763	40	Rope Start	1993- 01	100	1988	18-5892
5	1984	18-5758	40	Electric Start	1993- 01	100, 115	1989-99 Crossflow	18-5770
5	1985	18-5765	40 COM.	1986-88	18-5764 ⑦	110		
5	1986-88, 1993-98	18-5763	45	1991-92	18-5794	110 (TCLDF only)	1986	18-5783
6	1977-79,1984	18-5758	48	1987-88	18-5763	110	1986-87	18-5784
6	1985	18-5765	48	1991-93	18-5794	110	1988	18-5892
6	1986-88, 1993-01	18-5763	50	1971-75	18-5755	115	1969-70	—
6.5COM.	1992-99	18-5763	50	1979,1981-84	18-5758	115	1973-77	18-5753 ②
7.5	1980-83	18-5758	50	1985	18-5765	115	1978-84	18-5759 ①
8	1993-95	18-5763	50	1986-88	18-5763	115	1985	18-5783
9.9,15	1977-84	18-5758	50	1991-93	18-5794	120	1986	18-5892
9.9,15	1985	18-5765	50 Rope Start	1993- 01	18-5768	120	1988-99	18-5772
9.9,15	1986-88	18-5763	50			125	1971-72	—
9.9,15	1993-99	18-5767 ②	50	Electric Start	1993- 01	130	1988-99	18-5772
14	1987	18-5763	50	1996-99	18-5785	135	1973-76	18-5753 ②
10/15COM.	1992	18-5763	55	1976-77	18-5780 ⑧	140	1977	18-5753 ②
10,15COM.	1993-99	18-5767	55	1978-82	18-5755	140	1978-83	18-5759 ①
20	1981-84	18-5758	60	1978-82	18-5758	140	1986	18-5892
20	1985	18-5765	60	1991-92	18-5794	140	1988-99	18-5772
20	1986-88	18-5763	60	1970-71	—	150	197-78	18-5754③ ①
20	1989-92	18-5794	60	1980-84	18-5758	175	1979-83	18-5760 ①
20	1993-95	18-5768	60	1985	18-5765	175	1986-88	18-5761
20	1996-01	18-5768 ⑩	60	1986-88	18-5762 ⑧	175	1988-88	18-5761
25	1977-84	18-5758 ④	65	1989-92	18-5766	185	1989-91	18-5885
25	1985	18-5765	65	1989-92	18-5766	185	1991-92	18-5886 ①
25	1986-88	18-5763	65	1993-95	18-5774 ⑧	185	1993-03	18-5887
25	1989-92	18-5794	70	1974-78	18-5754 ③	200	1984	18-5760 ①
25	1993-95	18-5768	70	1979-84	18-5760	200	1990, 1992	18-5893
25	1996-01	18-5768 ⑩	70	1985	18-5782 ⑧	200	1993-99	18-5781
25 COM.	1986-88	18-5764 ⑦	70	1986-88	18-5762 ⑧	200, 225	1976-78	18-5754③ ①
28	1986-88	18-5763	70	1989-92	18-5766	200, 225	1979-83	18-5760 ①
28	1989-92	18-5794	70	1993-95	18-5774 ⑧	225	1987	18-5891
28	1996-01	18-5768	70	1996-99	18-5780 ⑧	235	1978	18-5754③ ①
30	1984	18-5758	75	1999-99	18-5780 ⑧	235	1979-84	18-5760 ①⑤⑥
30	1985	18-5765	75	1975-78	18-5754 ③	250	1991	18-5893
30	1986-88	18-5763	75	1979-84	18-5760	275	1986-87	18-5892
30	1989-92	18-5794	75	1985	18-5782 ⑧	300	1987	18-5892
30	1993-95	18-5768	85	1986-88	18-5762 ⑧	300	1991	18-5893
30	1996-01	18-5768 ⑩	85	1969-72	18-5753 ②	V-8	1993-99	18-5773
35	1977-84	18-5758	85	1973-77	18-5753 ②	1.6L	1984 & prior	18-5759 ⑨
35	1985	18-5765	88, 90	1978-80	18-5759 ①	1.6L	1985	18-5782
35	1986-88	18-5763	88	1986-87	18-5784	1.6L	1986-87	18-5784
35	1989-92	18-5794	88,90	1988	18-5892	2.0L	1988-99	18-5772
35	1993-95	18-5768	88,90	1989-99 Crossflow	18-5770	2.5, 2.6L	1986-88	18-5761 ⑨
40	1982	18-5758	90	1981-83	18-5759 ①			
				1985	18-5783			

① 2 Power Packs required per engine
 ② Order 18-5756 for Power Pack w/o cover,insulated pad and mounting screws
 ③ Order 18-5757 for Power Pack w/o cover,insulated pad and mounting screws

④ All Models except Worktwin, Workhorse and Commercial Model for 1983
 ⑤ Port side only for 1983 model STLCT
 ⑥ Port side only for 1984 models with suffix beginning with "S"

⑦ 2 cyl. only
 ⑧ 3 cyl. only
 ⑨ Sea Drive Series
 ⑩ Except remote models
 ① Refer to picture
 ② For 2 stroke models only

PREMIUM MARINE SPARK PLUG WIRE LEADS

MAGFORCE™



OE style boots provide a sealed barrier against heat, dirt and moisture.

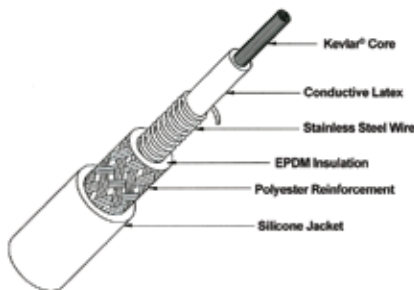

Premium Marine Wire Leads
Magnetic Suppression Core
 Manufactured for your specific application

- Kevlar® core for maximum durability and long life.
- Durable stainless steel wound conductor for maximum horsepower and engine performance.
- Premium silicone jacketing and boots for the ultimate in high temperature protection.
- Superior RFI suppression for the most sensitive electronic system.
- Corrosion resistant stainless steel spark plug and distributor terminals for maximum conductivity.

Part #	OEM#	Description	Part #	OEM#	Description
18-8815-1	OMC 582365	4" Spark Plug Wire	①③ 18-5229-9-1	Universal	22" Spark Plug Wire (pkg of 5)
18-8816-1	OMC 582365	6" Spark Plug Wire	①③ 18-5230-9-1	Universal	10" Spark Plug Wire (pkg of 5)
18-5231-1			18-8839-1	—	90 & 115 hp Outboard Wire Set
② 18-5231-1D	OMC 582365	9" Spark Plug Wire	18-8840-1	—	150 & 175 hp Outboard Wire Set
18-8818-1	OMC 582365	12" Spark Plug Wire			

<p>PKG. OF 10</p> <p>18-5224 18-5224-9① SPARK PLUG WIRE TERMINAL Replaces: 510364</p>	<p>18-5225 SPARK PLUG WIRE KIT Includes 25 ft Roll of Hypalon Ignition Wire with a copper conductor and a large assortment of three different end fittings to fit Johnson/Evinrude motors.</p>	<p>18-5226 IGNITION WIRE (100' Spool) Hypalon Replaces: 510883, 772584</p>	<p>PKG. OF 10</p> <p>18-5750 18-5750-9① UNIVERSAL SPARK PLUG BOOTS Supplied complete w/Terminal Connector Replaces: 581027, 580339</p>
<p>18-5752 UNIVERSAL SPARK PLUG BOOT 8mm</p>	<p>MP39100 IGNITION SWITCH Replaces: 386545 (5 Terminals - Pistol Shaped Key - 3 Position)</p>	<p>MP39760 IGNITION SWITCH Replaces: 393301, 508180 (6 Terminals - Push to Choke -3 Position)</p>	<p>MP39830 IGNITION SWITCH Replaces: 386545 (6 Terminals - Pistol Shaped Key -3 Position) Pollak</p>
<p>MP28890 IGNITION LANYARD Replaces: 176288 1996-Newer</p>	<p>18-1282 LANYARD & CLIP Replaces: 398602 Tiller Steer Models - ALL</p>	<p>MP28870 SWITCH & LANYARD Replaces: 585134</p>	<p>MP28880 LANYARD Replaces: 432230 1995-older</p>

① Priced per package
 ② Items ending in "D" are Display Packaged - Regular number is Non-Display
 ③ Uses 7mm copper core



**18-5877
STATOR**
Replaces: 584643
For: 185-300 HP Loopers (1993 &UP)



**18-5878
STATOR**
Replaces: 584981
For: 150-175 HP (1993-02)
Gray Sleeve



**18-2585
TRIM SEAL KIT**
Replace: 393942
Fits: 60hp - V6 (1990) and older,
V8 (1991-93)



**18-6277
TILT/TRIM ASSEMBLY**
Replaces: 435548
Heavy Duty, 2 Wire Connection,
Flat Blade Shaft
Fits : OMC V6(1993), Commer-
cial V8 (1993-Up)



**18-6823
WIRING HARNESS**
Replaces: Universal
Converts 3-wire Tilt and Trim motors to
2-Wire design



**18-6280
TILT/TRIM ASSEMBLY**
Replaces: 437801
Heavy Duty, OMC J Suffix
40,48,50HP(1992-Up)w/ 2
Wire Connection and Hollow
Hex Shaft



**18-6281
TILT/TRIM MOTOR**
Replaces: 438786, 439937,
5005254
Heavy Duty for OMC Outboards
75HP-250HP EFI(1998-Up)



**18-6285
TILT/TRIM ASSEMBLY**
Replaces: 433226
Heavy Duty OMC (1989-92) M
Suffix 40,48,50HP w/ 2 Wire
Connection and Hollow Hex
Shaft



**18-6756
TILT/TRIM MOTOR**
Replaces: 172588, 173944
Fits: (1982-98) 2 cylinder 2 stroke engines that
have been fitted with tilt kit 173946.



**18-6759
TILT/TRIM MOTOR**
Replaces: 394176,
391264, 393988, 985237
Newer 2 wire design for most 3, 4, 6 and 8 cyl.
applications 1982 to present
(Motor Only)
Use **18-7510** O-Ring
Replaces: 321163



**18-6761
TILT/TRIM MOTOR**
Replaces: 387277, 582048,
582155, 584107
Older 3 wire design for most 3, 4, 6
cylinder outboards up to 1981
(Motor Only)



**18-6762
TILT/TRIM MOTOR**
Replaces: 172543
For most 85, 115 and 135 H.P. V-4 applica-
tions (Motor and Reservoir)



**18-6767-1
TILT/TRIM MOTOR**
Replaces:
172850, 173564, 173596
For: 1974 (115 & 135 HP)
For most 45 H.P. commercial models 1989-90,
2 cylinder applications (1984-88),
3 cylinder applications (1977-83) and
4 cylinder applications (1974-77)
(Motor and Reservoir)
For Repair Kit use **18-6252**



**18-6780
TILT/TRIM MOTOR**
Replaces: 438529, 438531
For: 90, 115, 200, 225 HP (1991-Up);
120, 140 HP (1991-94); 130 HP (1995-Up)



**18-6815
TRIM MOTOR**
Replaces: Johnson/Evinrude
Fits: 2004-09 40-50HP 2006-09 60HP, 2009 25-30HP
Evinrude



**18-6865
COMPLETE TRIM ASSEMBLY**
Replaces: OMC,
Fits: Engines with 3-Ram Trim Assembly, 115-225HP
Johnson/Evinrude Engines



**18-6252
TILT & TRIM
MOTOR REPAIR KIT**
For use with **18-6767-1**
* Includes Brushes





POWER TRIM ASSEMBLIES

PART NO.	OE NO.	APPLICATION
18-6801	5005114	115-130HP, V4 (2000-09)
18-6802	5005113	135-200HP, V6, 60° (2000-09)
18-6803	5005115/5007662	200-250HP, V6, 90° (2000-09)



**18-5705
POWER TRIM RELAY**
Replaces:
582472, 584416, 586224
5 Terminal • Single Pull
Double Throw • 12 Volt

Contact	Resistive	Conductive
Open	40 Amps	30 Amps
Closed	20 Amps	15 Amps

18-5823D Display Package

18-5823 SOLENOID
Replaces: 584580
Fits: 9.9 4-stroke(1995-01), 9.9 (1993 & Up), 15 4-stroke(1995-01), 15 (1993 & Up), 8 (1996-98),

18-5833D Display Package

18-5833 SOLENOID
Replaces: 586774
Fits: E40 (2004-07), E50 (2004-06), E60 (2006-07), E75 (2004-07), E90 (2004-07), E115 (2007), E150 (2007), E175 (2007), E200 (2005-07), E225 (2005-07), E250 (2005-07)

18-5807 SOLENOID
Replaces: 378444, Prestolite SAW4206

18-5808D Display Package

18-5808 SOLENOID
Replaces: 395419, 582708

18-5813 SOLENOID
Replaces: 584128

18-5814D Display Package

18-5814 SOLENOID
Replaces: 581528, 172869

BATTERY CABLES
Gauge cable with soldered lug terminals on each end to accept 3/8" stud.

Part No.	Size	Color	Gauge	Part No.	Size	Color	Gauge
BC88523	2'	red	4	BC88563	6'	red	2
BC88533	2'	black	4	BC88573	6'	black	2
BC88543	4'	red	2	BC88583	8'	red	1
BC88553	4'	black	2	BC88593	8'	black	1

Model	Year	Starter Solenoid	Trim Solenoid Relay	Model	Year	Starter Solenoid	Trim Solenoid Relay	Model	Year	Starter Solenoid	Trim Solenoid Relay
9.9/15	1991-92	18-5813	N/A	40	1967-92	18-5808	N/A	60	1964-66	18-5807	N/A
18	1957-59	18-5807	N/A	45 ②	1989-92	18-5808	N/A	60	1967-80	18-5808	N/A
20	① 1981-92	18-5808	N/A	45SS	1988-90	18-5808	N/A	60	1981-83	18-5808	—
25	① 1972-92	18-5808	N/A	48	1987-92	18-5808	N/A	60	1984-92	18-5808	18-5705
28	1987-92	18-5808	N/A	50	1958-59	18-5807	N/A	SST 60	1989-90	18-5808	18-5705
30	① 1984-92	18-5808	N/A	50	1971-79	18-5808	N/A	65 ③	1968-73	18-5808	N/A
33	1965-67	18-5807	N/A	50	1981-83	18-5808	—	65 ③	1985-92	18-5808	18-5705
33	1968-70	18-5808	N/A	50	1984-92	18-5808	N/A	70	1961	18-5807	N/A
35	1957-59	18-5807	N/A	55	1968-80	18-5808	N/A	70	1974-80	18-5808	N/A
35	1976-88	18-5808	N/A	55	1981	18-5808	—	70	1981	18-5808	18-5814
40	1960-66	18-5807	N/A	55 ②	1989-92	18-5808	N/A	70	1982-92	18-5808	18-5705

① Electric start only ② Commercial models ③ Also commercial models
④ w/o electric shift ⑤ w/electric shift

⑥ Items ending in "D" are Display Packaged - Regular number is Non-Display

Model	Year	Starter Solenoid	Trim Solenoid Relay	Model	Year	Starter Solenoid	Trim Solenoid Relay	Model	Year	Starter Solenoid	Trim Solenoid Relay
75	1960-64	18-5807	N/A	90	1982-92	18-5808	18-5705	140	1982-92	18-5808	18-5705
75	④ 1965	18-5807	N/A	100	1966-72	18-5808	N/A	150	1979-81	18-5808	18-5814
75	⑤ 1965	18-5808	N/A	100	1979-80	18-5808	18-5814	150	1982-92	18-5808	18-5705
75	1975-80	18-5808	N/A	100	② 1984-92	18-5808	18-5705	155	② 1984-92	18-5808	18-5705
75	1981	18-5808	18-5814	1600cc	② 1988	18-5808	18-5705	2500cc	1988	18-5808	18-5705
75	1982-88	18-5808	18-5705	110	1986-89	18-5808	18-5705	175	1977-81	18-5808	18-5814
80	④ 1966	18-5807	N/A	115	1969-75	18-5808	N/A	175	1982-92	18-5808	18-5705
80	⑤ 1966	18-5808	N/A	115	1976-81	18-5808	18-5814	185	1984-92	18-5808	18-5705
80	1967	18-5808	N/A	115	1982-92	18-5808	18-5705	200	1976-81	18-5808	18-5814
85	1968-75	18-5808	N/A	120	1985-92	18-5808	18-5705	200	③ 1982-92	18-5808	18-5705
85	1976-80	18-5808	18-5814	125	③ 1971-81	18-5808	N/A	225	1986-92	18-5808	18-5705
85	1991-92	18-5808	18-5705	125	③ 1982-92	18-5808	18-5705	235	1978-81	18-5808	18-5814
88	1987-92	18-5808	18-5705	135	1973	18-5808	N/A	235	1982-85	18-5808	18-5705
90	1964	18-5807	N/A	135	1974-75	18-5808	—	250	1991-92	18-5808	18-5705
90	1965	18-5808	N/A	135	1976	18-5808	18-5814	275	1985-88	18-5808	18-5705
90	1981	18-5808	18-5814	140	1977-81	18-5808	18-5814	3.6L/300	1985-92	18-5808	18-5705

① Electric start only
④ w/o electric shift

② Commercial models
⑤ w/electric shift

③ Also commercial models

**18-5708
RECTIFIER**
Replaces: 582399, 583408
6-10 AMP



**18-5709
RECTIFIER**
Replaces: 581778
4-5 AMP

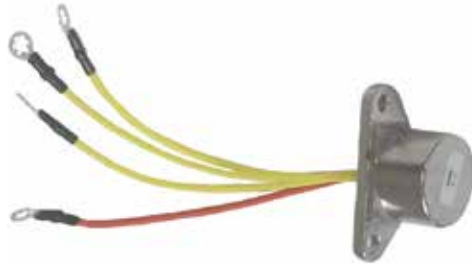

**18-5825
REGULATOR/RECTIFIER**
Replaces: 395204



**18-5826
REGULATOR/RECTIFIER**
Replaces: 584890



**18-5827
REGULATOR/RECTIFIER**
Replaces: 585001, 584476



**18-5828
REGULATOR/RECTIFIER**
Replaces: 585219, 439561



**18-5829
REGULATOR/RECTIFIER**
Replaces: 586048



**18-5830
REGULATOR/RECTIFIER**
Replaces: 586075



**18-5831
REGULATOR/RECTIFIER**
Replaces: 586271, 584641, 585995



**18-5832
REGULATOR/RECTIFIER**
Replaces: 583266, 583689,
586000, 584424



REGULATOR/RECTIFIER APPLICATION ON NEXT PAGE

Model	Year	Part #	Model	Year	Part #
9.9,15	1974-92	18-5709	90-115 60 Degree-V4	1996-Up	18-5830
20	1989-98 ④	18-5709	100	1971,1979-80,1984-92 ③	18-5708
25	1977-03 (2 Cyl) ④	18-5709	115	1973-92	18-5708
25/40/50TL/ J Elec TR	1992	18-5827	120/140	1985	18-5832
25SIK/ SIL/ SIT	1994-1995	18-5827	125	1971-72	18-5708
25/35 3 Cyl.	1995-Up	18-5826	135	1974 ⑦	18-5708
28	1989-96	18-5709	135	1973,1975-76	18-5708
30	1989-03 (2 Cyl) ④	18-5709	140	1977-88	18-5708
35	1976-93 (2 Cyl) ④	18-5709	150	1979-88	18-5708
35JET/ TL/ J Elec.	1992-1993	18-5827	150/175 60 Degree-V6	1991-1995	18-5828
35JET/ M-TE/ TTL	1993-1995	18-5827	150/175 60 Degree-V6	1996-Up	18-5829
35JET/ EL/ TL/ TTL	1996	18-5827	155	1984-88	18-5708
35JET Elec.	1997	18-5827	175	1977-83	18-5708
40	1974-76,1988-92	18-5709	185	1984-88	18-5708
40/50TE/ EL/ TL/ TTL	1993-1996	18-5827	185/200/225	1993-1994	18-5831
40/ 50 Elec. 2 Cycle.	1993-03 (2 Cycle.)	18-5827	185/200/225/200COMM	1990-1992	18-5832
45	1989-92 COMM	18-5709	200	1976-83	18-5708
45SS	1989-90	18-5709	200/225	1986-1989	18-5832
48	1989-92	18-5709	200/225/200COMM	1994-1997	18-5831
50	1971-75	18-5708	235	1978-88	18-5708
50	1979-92	18-5709	250/300	1991-1995	18-5831
55	1976-77	18-5708	250	1997	18-5831
55	1978-81, 1980-92 ①	18-5709	275	1985-1986	18-5832
60	1970 ⑤, 1971	18-5708	275/300 (3.6L)	1987	18-5832
60	1980-88	18-5709	275/300	1988	18-5832
60	1989-91 ⑥	18-5708	300 (3.6L) — Port & Stbd.	1985-1986	18-5832
SST60	1989-90	18-5708	300	1989-1990	18-5832
60	1992-01	18-5827	1.8/2.0L V4 "S"	1987-1990	18-5832
65	1972-73, 1988-91	18-5708	2.7L V6	1986-1987	18-5832
65 Elec.	1992	18-5827	3.0L V6	1988-1990	18-5832
70	1974-91 ②	18-5827	3.0L V6	1993-1998	18-5832
70	1992-01	18-5708	3.6L V8	1987	18-5832
75	1975-88	18-5708	4.0L V8	1989-1990	18-5832
85	1970-80	18-5708	V-4 & V-6 Crossflow with 35 AMP	ALL	18-5825
88	1989-92	18-5708			
90	1981-92	18-5708			

- ① Also Commercial Models
- ② 1991 EL & TL Models only
- ③ Except 1992 Models WTLENE & WTXENE
- ④ Electric Start only
- ⑤ D Models only
- ⑥ EL & TL Models only
- ⑦ 135443, 135483 Models only



**18-6434
OUTBOARD STARTER**
Replaces: 386430
Fits:9.9,15 HP (1974-92), 8 HP 4 Stroke (1996-98)



**18-5600
PREMIUM
OUTBOARD STARTER**
Replaces: 395207, 387094, 585062, 586288

**18-5640
O.E. EQUIVALENT
OUTBOARD STARTER**
Replaces: 395207, 387094, 585062, 586288



**18-5612
OUTBOARD STARTER**
Replaces: 432925, 586287, 586286



**18-5617
OUTBOARD STARTER**
Replaces: 586274



**18-5619
OUTBOARD STARTER**
Replaces: 584799, 396235, 391511, 397023, 586731

**ALL STARTERS ARE COUNTER CLOCKWISE ROTATION
STARTER APPLICATION ON PAGE 221**



18-5624
OUTBOARD STARTER
Replaces: 583482, 585056



18-5627
OUTBOARD STARTER
Replaces: 583473, 585059, 585459



18-5628
OUTBOARD STARTER
Replaces: 393570, 585060



18-5629
PREMIUM
OUTBOARD STARTER
Replaces: 392133, 585061, 386591

18-5645
O.E. EQUIVALENT
OUTBOARD STARTER
Replaces: 392133, 585061, 386591



18-5630
PREMIUM
OUTBOARD STARTER
Replaces: 387684, 585063, 389275, 384163

18-5646
O.E. EQUIVALENT
OUTBOARD STARTER
Replaces: 387684, 585063, 389275, 384163



18-5631
OUTBOARD STARTER
Replaces: 584818, 586277



18-5632
OUTBOARD STARTER
Replaces: 584980, 586284



18-5634
PREMIUM
OUTBOARD STARTER
Replaces: 585057, 585051, 385529, 389954



18-5635
PREMIUM
OUTBOARD STARTER
Replaces: 585058, 586281, 386657, 391735, 585050, 384777

18-5648
O.E. EQUIVALENT
OUTBOARD STARTER
Replaces: 585058, 586281, 386657, 391735, 585050, 384777



18-6826
STARTER
Replaces: Johnson/Evinrude
Fits: 40-90HP E-Tec Engines



18-6863
STARTER
Replaces: OMC
Fits: Johnson/Evinrude 9.9-15HP
4-Stroke Engines



18-6945
STARTER
Replaces: Johnson
Fits: Johnson, Suzuki 25HP 2006-11



18-6250
OUTBOARD STARTER
REPAIR KIT
Prestolite
2 Brush



18-6251
OUTBOARD STARTER
REPAIR KIT
Prestolite
4 Brush



18-5655
DRIVE ASSEMBLY
Replaces: 321648
See next page for additional application



18-5671
DRIVE ASSEMBLY
Replaces: 384781
See next page for additional application

ALL STARTERS ARE COUNTER CLOCKWISE ROTATION
STARTER APPLICATION ON NEXT PAGE



18-5674
DRIVE ASSEMBLY
 Replaces: 387683
 See chart below for additional application



18-5678
DRIVE ASSEMBLY
 Replaces: 585269
 See chart below for additional application



18-5679
DRIVE ASSEMBLY
 Replaces: 585267
 See chart below for additional application

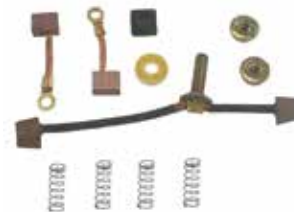

18-5697
DRIVE BRUSH KIT
 Replaces: 385952
 See chart below for additional application

H.P.	Years	Starter #	OE Part #	O.E. #	Drive ^② Assembly	O.E. #	Tooth Count	Drive ^② Brush Kit	O.E. #
9.9/ 15	1974-92	—	386430	395264	—	319977	10	NA	NA
9.9/ 15	1993 & Up	18-5617	586274	395264	—	319977	10	NA	NA
9.9/ 15	1997 & Up 4 stroke	—	584613	NSS	18-5679 ①	585267	10	18-5697	385952
20 ⑦	1985-88	18-5629	586278	393354	18-5655	321648	11	18-5697	385952
20 thru 30 ⑦	1993-98	18-5629	586278	393354	18-5655	321648	11	18-5697	385952
25 thru 35 ⑦	1977-88	18-5629	586278	NSS	18-5655	321648	11	18-5697	385952
20 thru 30 ⑤	1989-92	18-5627	585059	393354	18-5671 ①	384781	9	18-5697	385952
25 thru 35	1997-99 3 cylinders	18-5631	586277	586100	NSS ①	NSS	10	18-5697	385952
40-50	1984-88	18-5630	586280	NSS	18-5671 ①	384781	9	18-5697	385952
50	1972	18-5630	586280	NSS	18-5671 ①	585269	9	18-5697	385952
40-50 ①	1989-99	18-5624	586279	NSS	18-5678 ①	585269	9	18-5697	385952
55	1978	18-5630	586280	NSS	18-5678 ①	585269	9	18-5697	385952
60	1985 2 cylinders	18-5630	586280	NSS	18-5678 ①	585269	9	18-5697	385952
50	1985-99 3 cylinders	18-5635	586281	NSS	18-5678 ①	585269	9	18-5697	385952
55	1969	18-5635	586281	NSS	18-5678 ①	585269	9	18-5697	385952
60	1971	18-5635	586281	NSS	18-5671 *	384781	9	18-5697	385952
60	1986-01 3 cylinders	18-5635	586281	NSS	18-5678 ①	585269	9	18-5697	385952
65	1985-01 3 cylinders	18-5635	586281	NSS	18-5678 ①	585269	9	18-5697	385952
70, 75	1980-01	18-5635	586281	NSS	18-5678 ①	585269	9	18-5697	385952
85 thru 115	1973-99 crossflows	18-5634	586283	NSS	18-5679 ①	586100	10	18-5697	385952
90, 115	1995-99 looper	18-5632	586284	NA	NA	NA	NA	18-5697	385952
120 thru 140	1985-94	18-5628	586285	NSS	18-5679 ①	586100	10	18-5697	385952
130	1995-99	18-5628	586285	NSS	18-5679 ①	586100	10	18-5697	385952
V-6 Crossflow	1976-92	18-5600	586288	393285	18-5674	387683	8	18-5697	385952
150, 175 60°	1991-99 loopers	18-5612	586286	NA	NA	NA	NA	18-5697	385952
150 thru 175 V-6	1997-03	18-5612	586287	NSS	NSS	NA	NA	NA	433850
200 thru 300	1986-Up std. rotation	18-5619	586411	397375	NA	NA	10	18-5697	385952

Note: Some starters will replace Prestolite versions however replacement parts are for Bosch versions only.
 * Starter drive retained with nut

NSS Not sold separately

① Drive kit includes drive assembly with clip style retainer

② Drive kits, drive assemblies, and brush sets offered are for "Bosch Style" starters only.

⑤ With 9 tooth pinion

⑦ For Bosch models

4 STROKE FUEL SYSTEM KITS



18-7761
CARBURETOR REBUILD KIT
 Fits: Johnson/Evinrude Four-Stroke 4-6 hp. (2007)

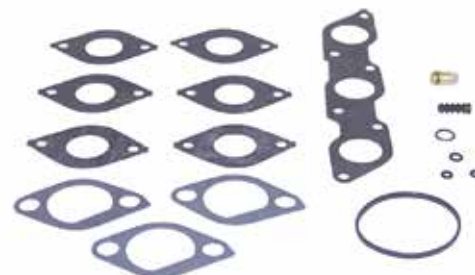

18-7773
CARBURETOR REBUILD KIT
 Replaces: 5032424
 25, 30 HP (2000-01) (2004 & Up)

2 STROKE FUEL SYSTEM KITS

 <p>18-7010 CARB KIT Replaces: 382050, 382051, 382054</p>	 <p>18-7024 CARB KIT Replaces: 382053, 382052, 385356</p>	 <p>18-7026 CARB KIT Replaces: 382057</p>	 <p>18-7042 CARB KIT (without float) Replaces: 392061, 398729, 396701</p>								
 <p>18-7222 CARB KIT (with float) Replaces: 392061, 398729, 396701</p>	 <p>18-7043 CARB KIT Replaces: 382045, 382046, 382047, 382049, 383052, 383067, 398532, 439071</p>	 <p>18-7046 CARB KIT Replaces: 390055, 392550, 398526, 435443, 434888, 439076</p>	 <p>18-7219 CARB KIT Replaces: 439073, 431897</p>								
 <p>18-7220 CARB KIT Replaces: 435676, 435677, 435678, 435752</p>	 <p>18-7221 CARB KIT Replaces: 435442, 438996</p>	 <p>18-7223 CARB KIT Replaces: 398452, 391305, 398453, 439072, 391937</p>	 <p>18-7247 CARB KIT Replaces: 438996, 436852 For: V4 & V6 (60°) 1988-2001</p>								
 <p>18-7248 CARB KIT Replaces: 437327, 439079, 439078</p>	 <p>18-0871 SERVICE VALVE WITH O-RING Replaces: 175158 Fits: All Johnson/Evinrude with primer valve (except 1993 9.9 & 15hp.)</p>	 <p>18-7044 SERVICE VALVE KIT Fits: All Johnson/Evinrude with primer valve (except 1993 9.9 & 15 H.P.)</p>	 <p>18-0993 COVER & GASKET ASSEMBLY Replaces: 437228 Fits: All Johnson/Evinrude with primer valve (except 1993 9.9 & 15hp.)</p>								
 <p>NEEDLE & SEAT</p> <table border="1"> <thead> <tr> <th>Part #</th> <th>Replaces:</th> </tr> </thead> <tbody> <tr> <td>18-7093</td> <td>396521, 678882, 378895</td> </tr> <tr> <td>18-7094</td> <td>379313, 396522</td> </tr> <tr> <td>18-7038</td> <td>396520, 379312, 387262</td> </tr> </tbody> </table>	Part #	Replaces:	18-7093	396521, 678882, 378895	18-7094	379313, 396522	18-7038	396520, 379312, 387262	<p>PKG. OF 10</p>  <p>18-7106 18-7106-9① NEEDLE PACKING Replaces: 307583</p>	 <p>18-7210 FLOAT Replaces: 382363</p>	<p>PKG. OF 5</p>  <p>18-7296 18-7296-9① ADJUSTING NEEDLE RETAINER Replaces: 315232</p>
Part #	Replaces:										
18-7093	396521, 678882, 378895										
18-7094	379313, 396522										
18-7038	396520, 379312, 387262										

① Priced per Package

HP	Year	Carb. Kit w/o Float	Carb. Kit w/ Float	Needle & Seat	Carb. Float
1.5	1970-90	18-7043	—	18-7094	—
2	1970-90	18-7043	—	18-7094	—
3	1952-67	18-7043	—	18-7038	—
3	1968	18-7043	—	18-7094	—
4	1983-89	18-7223	—	18-7094	—
4	1991-93	18-7223	—	18-7094	—
4.5	1982-84, 1987	18-7223	—	18-7094	—
5	1965-67	18-7043	—	18-7094	—
5	1968	18-7024	—	18-7093	—
5	1984-85	18-7223	—	18-7094	—
5.5	1954-67	18-7043	—	18-7094	—
6	1954-79	18-7043	—	18-7094	—
6	1968	18-7024	—	18-7093	—
6	1984-85	18-7223	—	18-7094	—
6.8	1986-96	18-7219	—	—	—
7.5	1955-58	18-7043	—	18-7094	—
7.5	1982-83	18-7223	—	18-7094	—
8	1984-85	18-7223	—	18-7094	—
9.9	1974-88	18-7223	—	18-7094	—
9.9/15	1989-96	18-7219	—	—	—
10	1954-63	18-7043	—	18-7094	—
14	1968	③ 18-7223	—	18-7094	—
15	1955-56	18-7043	—	18-7094	—
15	1974-88	18-7223	—	18-7094	—
18	1957-68	18-7043	—	18-7094	—
18	1969-73	18-7042	18-7222	18-7093	18-7210
20	1957-68	18-7043	—	18-7094	—
20	1969-90	18-7042	18-7222	18-7093	18-7210
20	1991-96	18-7219	—	18-7094	—
25	1954-55	18-7024	—	18-7093	—
SAIL DR	1978-Up	18-7042	18-7222	18-7093	18-7210
25	1969-95	⑤ 18-7042	18-7222	18-7093	18-7210
28	1962-64	18-7010	—	18-7093	—
28	1976-95	18-7042	18-7222	18-7093	18-7210
30	1956	18-7024	—	18-7093	—
30	1976-Up	18-7042	18-7222	18-7093	18-7210
33	1965-70	18-7010	—	18-7093	—
35	1957-59	18-7024	—	18-7093	—
35	1959	18-7010	—	18-7093	—
35	1976-95	⑤ 18-7042	18-7222	18-7093	18-7210
40	1960-63, 1971	18-7010	—	18-7093	—
40	1965-70, 1972-78	18-7024	—	18-7093	—
40	1971-90, 1979-92	① 18-7042	18-7222	18-7093	18-7210
45	1971-97	② 18-7042	18-7222	18-7093	18-7210
48	1992-97	18-7042	18-7222	18-7093	18-7210
50	1958-59	18-7026	—	18-7093	—
50	1971-97	18-7042	18-7222	18-7093	18-7210
55	1968-69, 1971-97	② 18-7042	18-7222	18-7093	18-7210
60	1964-67	18-7026	—	18-7093	—
60	1970-97	18-7042	18-7222	18-7093	18-7210
65	1972-97	18-7042	18-7222	18-7093	18-7210
70	1972-97 (3 cyl)	18-7042	18-7222	18-7093	18-7210
75	1960-63	18-7026	—	18-7093	—
75	1975-88	18-7042	18-7222	18-7093	18-7210
80	1966-67	18-7026	—	18-7093	—
85	1968	18-7026	—	18-7093	—
85	1971-79	18-7046	—	18-7093	—
85	1969-70, 1991-93	18-7046	—	18-7038	—
V-4	1969-79	18-7046	—	18-7038	—
V-4	1983-84	18-7046	—	18-7038	—
88.90	1985-95	18-7046	—	18-7038	—
90	1981-82, 1983	③ 18-7046	—	18-7038	—
90	1995-02	—	18-7247	—	—
100	1971, 1980	18-7046	—	18-7038	—
100	1972, 1979	18-7046	—	18-7093	—
100	1998-01	—	18-7247	—	—
105	1999-01	—	18-7247	—	—
115	1969, 1980-95	18-7046	—	18-7038	—
115	1995-02	18-7046	—	18-7093	—
115	1995-02	—	18-7247	—	—
V-6	1976-90	④ 18-7046	—	18-7038	—
115	1983	18-7046	—	18-7038	—
120	1985-90	18-7220	—	18-7094	—
120	1985-90, 1993	18-7220	—	18-7094	—
125	1971-72	18-7046	—	18-7093	—
125	1993	18-7220	—	18-7094	—
125C	1989-95	18-7220	—	18-7094	—
135	1973-76	18-7046	—	18-7093	—
140	1977, 1980-83	18-7046	—	18-7038	—
140	1978-79	18-7046	—	18-7093	—
140	1985-90	18-7220	—	18-7094	—
140	1993	18-7220	—	18-7094	—
150	1979-90	18-7046	—	18-7038	—
150	1992-96, 1998-02	18-7247	—	—	—
155	1984-93	① 18-7046	—	18-7038	—
175	1977-91	18-7046	—	18-7038	—
175	1992-96, 1998-02	18-7247	—	—	—
185	1984	18-7046	—	18-7038	—
185	1989-93	18-7221	—	18-7094	—
200	1976-83	18-7046	—	18-7038	—
200	1986-90	18-7220	—	18-7094	—
200	1992-93	18-7221	—	18-7094	—
225	1986-90, 1992-93	18-7221	—	18-7094	—
235	1978-84	18-7046	—	18-7038	—
250	1991-93	18-7221	—	18-7094	—
275/3.6L	1985-88	18-7221	—	18-7094	—
300	1988, 1991-93	18-7221	—	18-7094	—

① Commercial ② Also Commercial ③ Early Production ④ Cross Flow ⑤ Except 1995-Up 3 Cylinder Models

 <p>18-7350 FUEL PUMP Replaces: 397839, 391638, 395091, 397274 For: 6/8/9/15 HP 1981-92</p>	 <p>18-7351 FUEL PUMP Replaces: 438562 For: 9.9/15 HP 1993-2006 Uses kit 18-7800</p>	 <p>18-7352 FUEL PUMP Replaces: 438556, 388268, 385781, 394543, 382354, 395713, 398338, 432451, 398387, 433387 For: 25-55 HP 1976-89 (non-VRO)</p>
 <p>18-7353 FUEL PUMP Replaces: 438555, 433386 For: 20-30 HP 1990-2000</p>	 <p>18-7800 FUEL PUMP KIT Replaces: 438616, 433519</p>	 <p>18-7801 FUEL PUMP KIT Replaces: 379777</p>
 <p>18-7820 FUEL PUMP KIT Replaces: 393103</p>	 <p>18-7821 FUEL PUMP KIT Replaces: 398514, 395867</p>	 <p>18-7822 FUEL PUMP KIT Replaces: 432962</p>
 <p>18-7823 FUEL PUMP KIT Replaces: 393088</p>	<p>PKG. OF 2</p>  <p>18-7796 18-7796-9[Ⓞ] CHECK VALVE Replaces: 335334 (Enlarged to show detail)</p>	 <p>18-3501 DIAPHRAGM & CUP ASSEMBLY Replaces: 435957 For: 8 (1996-97), 10 (1996-97), 15 (1996-97), 40 (1995-97), 50 (1995-97), 55 (1995-97), 60 (1993-96), 65 (1993-96), 70 (1993-96), 120 (1993-94), 125 (1993-95), 130 (1995-96), 140 (1993-94), 250 (1994-95), 300 (1994-95),</p>
 <p>18-3497 DIAPHRAGM KIT Replaces: 5033372 4-5 HP (2003-06), 6 HP (2005-06) 4-Stroke</p>	 <p>18-3498 DIAPHRAGM KIT Replaces: 5036216 9.9-15 HP (2005-07) 4-Stroke</p>	 <p>18-3499 DIAPHRAGM KIT Replaces: 5030699 9.9, 15 HP (2002-04), 25HP (2004-06), 30HP (2004-07), 40-70 HP (2002-06) 4-Stroke</p>

Display Package

Ⓞ Priced per Package

FUEL PUMP KIT APPLICATION ON NEXT PAGE

FUEL PUMP REPAIR KIT APPLICATION

Model	Year	Part #	Model	Year	Part #	Model	Year	Part #
2.5	1987-88	18-7823	30/35	1976-86	18-7820	65	1990	18-7821 ①
4	1981-Up	18-7823	35	1958-59	18-7801	65 Comm	1984	18-7820
4.0 Deluxe	1992-93	18-7823	40	1960-64	18-7801	65 Comm	1988-89	18-7821
4.5	1982-87	18-7823	40	1987	18-7821	70/75	1982-84	18-7820
5	1985-93	18-7823	40	1990-Up	18-7800	70	1990	18-7821
6	1986-93	18-7823	40 ②	1970-78	18-7820	75	1960-65	18-7801
6.5	1989-90	18-7823	40/50	1988-89	18-7822	80	1966-67	18-7801
7.5	1982-83	18-7823	45	1958-59	18-7801	85	1978-83	18-7820
8	1984-93	18-7823	45/48/50② ③	1989	18-7822	88	1987	18-7821
9.9/15	1981	18-7820	45/48/50② ③	1990-up	18-7800	88/90/110 ③	1988-89	18-7821
9.9/15	1982-Up	18-7823	45/55	1985-86	18-7821	88/90/100/115 ③	1990	18-7821 ①
9.9 Electric & 15	1987-89	18-7821	45/55 Comm	1987	18-7821	88/100/125 ③	1990-Up	18-7800
9.9 Electric & 15	1990-Up	18-7800	48	1989-90	18-7821 ①	90	1964-65	18-7801
10/14	1989-90	18-7823	48	1987	18-7821	90/115	1978-83	18-7820
14	1988	18-7823	48	1988	18-7822	90/115/140	1982	18-7820
20/25	1977-86	18-7820	48/50	1990	18-7822 ①	100	1966	18-7801
20 Thru 30	1990-Up	18-7800	50	1958-59	18-7801	100 Comm	1989-90	18-7821
20/25/30	1987	18-7821	50	1987	18-7821	125 Comm	1989-90	18-7821
20/25/30	1988-89	18-7822	50	1982-84	18-7820	V4 140	1978-83	18-7820
20/25/30 Rope	1990	18-7822 ①	50/60	1983	18-7820	150/175/200	1982	18-7820
20/30/35 Remote	1990	18-7822 ①	55	1984	18-7820	V6 150/175	1983	18-7820
20/35 Rope	1989	18-7822	55 Comm	1984	18-7820	V6 235	1983	18-7820
25 Comm	1982	18-7820	55 Thru 75	1970-78	18-7820	155 Comm	1989-90	18-7821
25 Comm	1988-90	18-7822	60	1964-67	18-7801	V6 235	1983	18-7820
28	1962-63	18-7801	60	1988	18-7821	2.6	1984	18-7821
28	1987	18-7821	65	1985-87	18-7820	3.0	1991-93	18-7823

① Early production pump ② Two stroke ③ Not VRO (Variable Ratio Oiling)

- UNIVERSAL DESIGN -
DIRECT REPLACEMENT FOR MERCURY AND YAMAHA
FUEL WATER SEPARATOR BRACKETS



Bracket Type	Part #	Bracket Type	Part #
1/4" Stainless Steel	18-7777	1/4" Aluminum	18-7853-1
3/8" Stainless Steel	18-7776	3/8" Aluminum	18-7775

FUEL WATER SEPARATOR KITS



21 MICRON FILTER KITS - FOR CARBURETED ENGINES

Kit Type	Part #	Micron Rating	Contents
1/4" Aluminum (Short Filter)	18-7848-1	21	1 - 18-7844 filter & 1 18-7853-1 bracket 2 - 18-4256 1/4" pipe plugs
1/4" Aluminum Bonus Pack Contains spare filter	18-7848-2	21	2 - 18-7844 filter & 1 18-7853-1 bracket 2 - 18-4256 1/4" pipe plugs
1/4" Aluminum (Tall Filter)	18-7852-1	21	1 - 18-7845 filter & 1 18-7853-1 bracket 2 - 18-4256 1/4" pipe plugs
1/4" Aluminum Bonus Pack Contains spare filter	18-7852-2	21	2 - 18-7845 filter & 1 18-7853-1 bracket 2 - 18-4256 1/4" pipe plugs
3/8" Aluminum (Tall Filter)	18-7775-1	21	1 - 18-7845 filter & 1 18-7775 bracket 2 - 18-4264 3/8" pipe plugs
1/4" Stainless Steel (Tall Filter)	18-7777-1	21	1 - 18-7845 filter & 1 18-7777 bracket 2 - 18-4256 1/4" pipe plugs
3/8" Stainless Steel (Tall Filter)	18-7776-1	21	1 - 18-7845 filter & 1 18-7776 bracket 2 - 18-4264 3/8" pipe plugs



10 MICRON FILTER KITS FOR FUEL INJECTED ENGINES

Kit Type	Part #	Micron Rating	Contents
1/4" Aluminum (Short Filter)	18-7983-1	10	1 - 18-7944 filter & 1 18-7853-1 bracket 2 - 18-4256 1/4" pipe plugs
1/4" Aluminum Bonus Pack Contains spare filter	18-7983-2	10	2 - 18-7944 filter & 1 18-7853-1 bracket 2 - 18-4256 1/4" pipe plugs
1/4" Aluminum (Tall Filter)	18-7982-1	10	1 - 18-7945 filter & 1 18-7853-1 bracket 2 - 18-4256 1/4" pipe plugs
1/4" Aluminum Bonus Pack Contains spare filter	18-7982-2	10	2 - 18-7945 filter & 1 18-7853-1 bracket 2 - 18-4256 1/4" pipe plugs
1/4" Aluminum (High Capacity Filter)	18-7966-1	10	1 - 18-7866 filter & 1 18-7853-1 bracket 2 - 18-4256 1/4" pipe plugs
3/8" Aluminum (Tall Filter)	18-7986-1	10	1 - 18-7945 filter & 1 18-7775 bracket 2 - 18-4264 3/8" pipe plugs
1/4" Stainless Steel (Tall Filter)	18-7984-1	10	1 - 18-7945 filter & 1 18-7777 bracket 2 - 18-4256 1/4" pipe plugs
3/8" Stainless Steel (Tall Filter)	18-7985-1	10	1 - 18-7945 filter & 1 18-7776 bracket 2 - 18-4264 3/8" pipe plugs



10 MICRON FILTER KITS WITH DRAIN BOWLS

Sierra AquaVue™ and metal bowl separator filters allow water to be drained from the filter to extend service life. Use the AquaVue™ bowl for outboard, above deck installations. USCG regulations require the use of the flame resistant metal bowl below deck.

Kit Type	Part #	Micron Rating	Contents
1/4" Aluminum w/ AquaVue™ bowl	18-7932	10	1 - 18-7919 filter & 1 18-7853-1 bracket 1 - 18-7922 AquaVue™ bowl 2 - 18-4256 1/4" pipe plugs
1/4" Aluminum w/ metal drain bowl	18-7951	10	1 - 18-7919 filter & 1 18-7853-1 bracket 1 - 18-7924 metal bowl 2 - 18-4256 1/4" pipe plugs
1/4" Stainless Steel w/ AquaVue™ bowl	18-7937	10	1 - 18-7919 filter & 1 18-7777 bracket 1 - 18-7922 AquaVue™ bowl 2 - 18-4256 1/4" pipe plugs
1/4" Stainless Steel w/ metal drain bowl	18-7938	10	1 - 18-7919 filter & 1 18-7777 bracket 1 - 18-7924 metal bowl 2 - 18-4256 1/4" pipe plugs

COMPACT BRACKET AND SEPARATOR KIT - FOR SMALL OUTBOARDS AND FRESH WATER APPLICATIONS



**18-7774
COMPACT ALUMINUM BRACKET**



**18-7965-1
10 MICRON COMPACT
SEPARATOR KIT**
Contains:
1 - 18-7774 bracket
1 - 18-7865 filter

REPLACEMENT FILTERS



UNIVERSAL DESIGN

10 MICRON REPLACEMENT FILTERS		21 MICRON REPLACEMENT FILTERS	
Part #	Description	Part #	Description
18-7944	Short - 3.875"	18-7844	Short - 3.875"
18-7945	Long - 4.35"	18-7845	Long - 4.35"
18-7866	High Capacity - 6"		
18-7865	Compact 10 Micron		

REPLACEMENT FILTERS FOR OMC

10 MICRON REPLACEMENT FILTERS			21 MICRON REPLACEMENT FILTERS		
Part #	Description	Replaces	Part #	Description	Replaces
18-7946	OMC thread	OMC 502905	18-7846	OMC thread	OMC 502905
18-7989	Cobra EFI	OMC 502906	18-7789	Cobra EFI	OMC 502906



10 MICRON REPLACEMENT FILTERS AND KITS WITH DRAIN BOWLS

REPLACEMENT ELEMENTS			ELEMENT & BOWL KITS	
Part #	Description	Replaces	Part #	Description
18-7919	Spin on replacement	Racor S3213	18-7928	Filter & AquaVue™ Bowl Contains: 18-7919 filter, 18-7922 bowl
18-7920	Spin on replacement OMC style	OMC 771839 Racor S3214	18-7929	Filter & Metal Bowl Contains: 18-7919 filter, 18-7924 bowl
REPLACEMENT BOWLS			18-7941	Filter & AquaVue™ Bowl Contains: 18-7920 filter, 18-7922 bowl
Part #	Description		18-7943	Filter & Metal Bowl Contains: 18-7920 filter, 18-7924 bowl
18-7922	AquaVue™ Collection Bowl			
18-7924	Metal Collection Bowl			



**18-79781
FUEL FILTER**
Replaces: 433190
60° V4 and V6



**18-7953
FUEL FILTER**
Replaces: 5035974
Fits: 25HP (2006-07) / 90,115,140
4 stroke (2005-06)



**18-7716
FUEL FILTER**
Replaces: 5032323
Fits: Johnson 25 4-Stroke (2004-05), 30
4-Stroke (2004-07), 40/60/70 4-Stroke
(2002-06), 90/115/140 4-Stroke (2003-04,
2006), Evinrude 25/30/40/50/70 4-Stroke
(2000-01)



**18-7719
FUEL FILTER**
Replaces: 5032238
Fits: Johnson 4/5 (2003-07), 6 4-Stroke
(2005-07), 10/15 4-Stroke (2002-07),
40/50/60/70 4-Stroke (2002-06), Evin-
rude 40/50 4-Stroke (2000-01)



**18-7722
FUEL FILTER**
Replaces: 5005266
For: E-Tec 40, 50, 60, 75, 90,115, 150, 175 & 200DPL



**18-7826
FUEL FILTER**
Replaces: 305185



INLINE FUEL FILTERS

Part #	Application:
18-7828-1	1/4" Small Capacity (For 1/4" Fuel Line)
18-7829	1/2" Large Capacity (For 1/4" Fuel Line)
18-7830	5/16" Replaces: OMC 398327
18-7831	3/8" Replaces: OMC 398319

8' LENGTH COMPLETE FUEL LINE ASSEMBLIES

3/8"
FUEL LINE ASSEMBLY

18-8009EP-1 SILVERADO 4000 Premium

OE# 398549



**18-8063
TANK
CONNECTOR**
(SOLD SEPARATELY)



**18-8092
FUEL
CONNECTOR**



**18-8005EP-1
PRIMER
BULB**

**18-8092
FUEL
CONNECTOR**



FUEL LINE ASSEMBLY COMPONENTS
Fits: 2 HP (1 cyl.) - 75 HP (3 cyl.) (1976-02)

8' LENGTH COMPLETE FUEL LINE ASSEMBLIES

3/8"
FUEL LINE ASSEMBLY

18-8014EP-1 SILVERADO 4000 Premium

OE# 174509



**18-8074
HOSE
BARB**
(SOLD SEPARATELY)



**18-8005EP-1
PRIMER
BULB**

**18-8092
FUEL
CONNECTOR**



FUEL LINE ASSEMBLY COMPONENTS
Fits: All V6 & V8 (1976-02)



Display Package

**18-8004EP-1
18-8004-10EP-1①
PRIMER BULB**
5/16"
Replaces: 174511, 775638
Large capacity bulb



Display Package

**18-8005EP-1
18-8005-10EP-1①
PRIMER BULB**
3/8"
Replaces: 174512
Large capacity bulb



Display Package

HOSE BARB APPLICATION

Part #	OMC O.E. #	Barb	NPT	Conn. Type
18-8055	173311	5/16"	1/4"	Male
18-8074	173312	3/8"	1/4"	Male



Display Package

**18-8056
18-8056-10①
FUEL CONNECTOR**
5/16"
Replaces: 174508, 775640
Mates with 18-8063



Display Package

**18-8063
18-8063-10①
TANK CONNECTOR**
Replaces: 502867, 772681
(1/4" NPT)
Mates with 18-8056 & 18-8092



Display Package

**18-8072
FUEL ELBOW**
3/8" Barb w/ 3/8" NPT Thread
Replaces: 174177
90°



Display Package

**18-8092
FUEL CONNECTOR**
3/8"
Replaces: 176445, 775641
Mates with 18-8063



**18-3290
INDICATOR ELBOW**
Replaces: 321886
Pipe threaded to hose

**SAE J1527 USCG Type B1-15
SILVERADO 3000**



16-331-0566
5/16" I.D.
Replaces: 333341
Available in 1/4", 5/16", 3/8", 5/8" ID.
Also available in 10' - 250' lengths.

16-331-0386
3/8" I.D.
Replaces: 125115

**SAE J1527 USCG Type B1-15
SILVERADO 3000**



16-331-0560
5/16" I.D.

16-331-0380
3/8" I.D.
Available in 5/16" and 3/8" ID.
Also available in 50' reels.

***** Tanks and Engines for picture purpose only.

① Discount shop pack of 10 - Priced per package



BLEEDER HOSE
18-8048 **18-8050**
 .090 I.D. x .220 O.D. .0625 I.D. x .190 O.D.



18-8051
FUEL LINE HOSE
 Replaces: 322656
for OMC Pressurized Systems



18-8052
FUEL LINE HOSE
3/16" I.D.
 Non-Pressurized Systems
 Replaces: 122838



18-9125
OETIKER CLAMP KIT
 Replaces: 787133

Part #	Johnson Evinrude #	Oetiker #	Description	
18-9141	787145	14100082	Oetiker Jaw Pincers	
Nominal OD				
Part #	Johnson Evinrude #	Oetiker #	Inches	mm
18-9126-9	346930	16700004	3/8"	9.5
18-9127-9	348838	16700006	13/32"	10.5
18-9128-9	349516	16700007	7/16"	11.3
18-9129-9	347107	16700010	1/2"	13.3
18-9130-9	347108	16700011	17/32"	13.8
18-9131-9	346931	16700012	35/64"	14
18-9132-9	346785	16700013	9/16"	14.5
18-9133-9	346786	16700016	5/8"	15.7
18-9134-9	348839	16700017	11/16"	17
18-9135-9	346151	16700024	13/16"	21
18-9136-9	346152	16700031	1"	25.6
18-9137-9	346153	16700037	13/16"	30.1
18-9138-9	349759	16700040	1 1/4"	31.6
18-9139-9	349729	16700053	1 5/8"	41
18-9140-9	346150	16700020	47/64"	18.5

All clamps are standard package of 10. Each package of 10 is available individually.

PKG. OF 10

Part #	Clamp O.E. #	Clamp Range	Size
① 18-8020	322652	.538 - .608	8
① 18-8021	911616	.597 - .665	10
① 18-8034	329654	.670 - .780	12
① 18-8200	322653	.360 - .406	2
① 18-8201	124249	.410 - .468	4
① 18-8202	322654	.475 - .536	6
① 18-8203*	329653	.750 - .875	14
① 18-8204*	324825	.875 - .975	19



SNAPPER CLAMPS



56507
LOCTITE® PST 6ML
PIPE SEALANT
 Replaces: 910048
 (with Teflon®)



18-3001
IMPELLER
 Replaces: 277181, 434424



18-3002
IMPELLER
 Replaces: 375638, 775518



18-3003
IMPELLER
 Replaces: 377178, 775519



18-3005
IMPELLER
 Replaces: 377992



18-3006
IMPELLER
 Replaces: 378891, 775521



18-3015
IMPELLER
 Replaces: 433935
 For: 2.5, 3, 4 Ultra, Excel
 With Key



18-3043
IMPELLER
 Replaces: 389642



18-3044
IMPELLER
 Replaces: 385072

① This product is priced per piece. To order price per package, please add -9 to the part number.

 <p>18-3050 18-3050-10Ⓢ IMPELLER Replaces: 386084</p>	 <p>18-3051 IMPELLER Replaces: 395289</p>	 <p>18-3053 IMPELLER Replaces: 396725 Wedge Key</p>	 <p>18-3055 IMPELLER Replaces: 389589</p>
 <p>18-3059 18-3059-10Ⓢ IMPELLER Replaces: 395864, 397131, 435821, 435748, 5001593 Includes 18-3299 Impeller Key</p>	 <p>18-3082 IMPELLER Replaces: 382547 Slotted Key</p>	 <p>18-3083 IMPELLER Replaces: 377230, 777213</p>	 <p>18-3090 IMPELLER Replaces: 387361, 763735</p>
 <p>18-3091 IMPELLER Replaces: 389576</p>	 <p>18-3099 IMPELLER Replaces: 5033112 For: 4 Stroke 9.9 and 15 HP (2002-up)</p>	 <p>18-3104 IMPELLER Replaces: 432941, 437059</p>	 <p>18-3366 IMPELLER Replaces: 390286</p>
 <p>18-3368 IMPELLER Replaces: 396809</p>	 <p>18-3102 IMPELLER PLATE Replaces: 305303</p>	 <p>18-3103 IMPELLER PLATE Replaces: 303069</p>	 <p>18-3127 IMPELLER PLATE Replaces: 319275</p>
 <p>18-3182 IMPELLER PLATE Replaces: 317841</p>	 <p>18-3346 CUP & PLATE ASSEMBLY Replaces: 435027</p>	 <p>18-3359 WEAR PLATE Replaces: 328755</p>	 <p>18-3179 WATER PUMP CUP Replaces: 324097</p>

APPLICATION BEGINS ON PAGE 237

Ⓢ Discount shop pack of 10 - Priced per package



**18-3455
INSERT CUP**
Replaces: 340619
For: 40, 50, 25 Jet, 30 Jet 1995-Up,
E-Tec 40/50/60 HP All

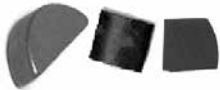

IMPELLER KEYS

Part #	Replaces:	Std. Pkg.
18-3295 ③	330619	3
18-3138 ① ③	334897	2
18-3108	308928	1
18-3299 ③	331107	5

① PKG OF 2 ② PKG OF 3



**18-3326
IMPELLER KEY**
Replaces: 300611



**18-3358
INSERT CUP**
Replaces: 328751



**18-3129
WATER PUMP HOUSING**
Replaces: 435673



**18-3405
WATER PUMP HOUSING**
Replaces: 435959



**18-3180
WATER PUMP HOUSING**
Replaces: 435390



**18-3336
WATER PUMP HOUSING**
Replaces: 384087



**18-3363
WATER PUMP HOUSING**
Replaces: 330560



**18-3367
WATER PUMP HOUSING**
Replaces: 393632



**18-3126
WEAR PLATE**
Replaces: 321940



**18-3178
WEAR PLATE**
Replaces: 318995



**18-3343
WEAR PLATE**
Replaces: 320981



**18-3201
IMPELLER REPAIR KIT**
— CONTAINS —

Part #	Desc.	O.E. #	Qty.
18-3001	Impeller	277181, 434424	1



**18-3202
IMPELLER REPAIR KIT**
— CONTAINS —

Part #	Desc.	O.E. #	Qty.
18-3001	Impeller	277181, 434424	1
18-3102	Impeller Plate	305303	1



**18-3203
IMPELLER REPAIR KIT**
— CONTAINS —

Part #	Desc.	O.E. #	Qty.
18-3002	Impeller	375638	1
18-3103	Impeller Plate	303069	1



**18-3210
IMPELLER REPAIR KIT**
— CONTAINS —

Part #	Desc.	O.E. #	Qty.
18-3043	Impeller	389642	1
18-2536	Rubber Seal	321120	1
18-2557	Impeller Gasket	324701, 338484	1
18-7158	O-Ring	310967, 310585	1

APPLICATION BEGINS ON PAGE 237

③ This product is priced per piece. To order priced per package, please add -9 to the part number.

① 18-3211D 

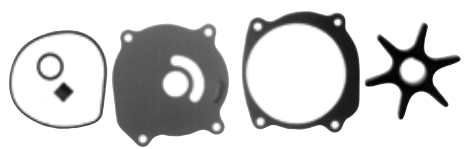

**18-3211
IMPELLER REPAIR KIT**

— CONTAINS —

Part #	Desc.	O.E. #	Qty.
18-3059	Impeller	395864, 397131, 435821	1
18-2536	Rubber Seal	321120	1
18-2557	Impeller Gasket	324701, 338484	1
18-3299	Impeller Key	331107	1
18-7158	O-Ring	310967, 310585	1
18-3138	Impeller Key	334897	1



**18-3238
WATER PUMP KIT**
Replaces: 388891

— CONTAINS —

Part #	Desc.	O.E. #	Qty.
18-3051	Impeller	395289	1
18-0446	Water Pump Gasket	323311	1
18-0445	Water Pump Gasket	323312	1
18-2030	Oil Seal	321786	1
18-7105	O-Ring	311338	2
18-3133	Stainless Steel Bolt	331979	4



**18-3453
WATER PUMP KIT**

With Housing
Replaces: 5006511
For: E-Tec 40/50/60 HP All



**18-3454
WATER PUMP KIT**

With Housing
Replaces: 438592
For: 40, 50, 25 Jet, 30 Jet 1995-Up



**18-3325
WATER PUMP KIT**

Replaces: 387326

— CONTAINS —

Part #	Desc.	O.E. #	Qty.
18-7134	O-Ring	339543	1
18-3108	Flywheel Key	308928	1
18-3337	Grommet	315837	1
18-3083	Impeller	377230	1
18-3343	Impeller Plate	320981	1
18-2705	Grommet	315748	1



**18-3327
WATER PUMP KIT**

With Housing
Replaces: 394711, 386697, 391698

— CONTAINS —

Part #	Desc.	O.E. #	Qty.
18-3050	Impeller	386084	1
18-3180	Housing	435390	1
18-3178	Wear Plate	318995	1
18-3179	Water Pump Cup	324097	1
18-3329	Grommet	302497	1
18-2392	Grommet	327035	1
18-2025	Oil Seal	318972	1
18-7116	O-Ring	303097	1
18-7139	O-Ring	319085	1
18-3326	Pin	300771	1
18-3369	Stainless Steel Bolt	319126	4



**18-3376
WATER PUMP KIT**

Without Housing
Replaces: 384956

— CONTAINS —

Part #	Desc.	O.E. #	Qty.
18-3083	Impeller	377230	1
18-3343	Impeller Plate	320981	1
18-3108	Flywheel Key	308928	1
18-3337	Grommet	315837	1
18-7134	O-Ring	339543	1
18-2705	Grommet	315748	1
18-3136	Screw (Long)	324430	2
18-3369	Stainless Steel Bolt	319126	2



**18-3377
WATER PUMP KIT**

Without Housing
Replaces: 382468

— CONTAINS —

Part #	Desc.	O.E. #	Qty.
18-3002	Impeller	375638	1
18-3103	Impeller Plate	303069	1
18-3329	Water Tube Grommet	302497	1
18-3326	Pin	300771	1

APPLICATION BEGINS ON PAGE 237

① Items ending in "D" are Display Packaged - Regular number is Non-Display

**18-3378
WATER PUMP KIT**

With Housing
Replaces: 391635

— CONTAINS —

Part #	Desc.	O.E. #	Qty.
18-3055	Impeller	389589	1
18-3343	Impeller Plate	320981	1
18-3336	Housing	384087	1
18-2709	Wear Plate Gasket	336530	1
18-3365	Stainless Steel Bolt	909533	2
18-3369	Stainless Steel Bolt	319126	2
18-2705	Seal	315748	1
18-3337	Water Tube Grommet	315837	1
18-7134	O-Ring	303059	1



**18-3379
WATER PUMP KIT**

Without Housing
Replaces: 390381

— CONTAINS —

Part #	Desc.	O.E. #	Qty.
18-3366	Impeller	390286	1
18-3352	Impeller Plate	325398	1
18-3354	Water Pump Gasket	325399	2
18-3332	Grommet	304056	1



**18-3380
WATER PUMP KIT**

Without Housing
Replaces: 390770

— CONTAINS —

Part #	Desc.	O.E. #	Qty.
18-3055	Impeller	389589	1
18-3343	Impeller Plate	320981	1
18-2709	Wear Plate Gasket	336530	1
18-3365	Stainless Steel Bolt	909533	2
18-3136	Stainless Steel Bolt	319126	2
18-2705	Seal	315748	1
18-3337	Water Tube Grommet	315837	1
18-7134	O-Ring	303059	1



**18-3381
WATER PUMP KIT**

Without Housing
Replaces: 393509

— CONTAINS —

Part #	Desc.	O.E. #	Qty.
18-3051	Impeller	395289	1
18-3359	Impeller Plate	328755	1
18-0124	Impeller Plate Gasket	325537	1
18-3358	Water Pump Cup	328751	1
18-2539	Rubber Seal	328753	1
18-3329	Grommet	302497	1
18-7100	O-Ring	301877	1
18-7105	O-Ring	311338	2
18-7146	O-Ring	554545	1
18-3133	Stainless Steel Bolt	331979	6



**18-3382
WATER PUMP KIT**

With Housing
Replaces: 393630

— CONTAINS —

Part #	Desc.	O.E. #	Qty.
18-3051	Impeller	395289	1
18-3359	Impeller Plate	328755	1
18-3367	Housing	393632	1
18-3358	Water Pump Cup	328751	1
18-0124	Impeller Plate Gasket	325537	1
18-3329	Grommet	302497	1
18-7100	O-Ring	301877	1
18-7105	O-Ring	311338	2
18-7146	O-Ring	554545	1
18-3133	Stainless Steel Bolt	331979	6



**18-3383
WATER PUMP KIT**

With Housing
Replaces: 395270

— CONTAINS —

Part #	Desc.	O.E. #	Qty.
18-3051	Impeller	395289	1
18-3363	Housing	330560	1
18-3358	Water Pump Cup	328751	1
18-3360	Impeller Housing Gasket	329390	1
18-3329	Grommet	302497	1
18-3133	Stainless Steel Bolt	331979	4



**18-3384
WATER PUMP KIT**

Without Housing
Replaces: 386124

— CONTAINS —

Part #	Desc.	O.E. #	Qty.
18-7158	O-Ring	310585	1
18-3108	Flywheel Key	308928	1
18-3043	Impeller	389642	1
18-3182	Impeller Plate	317841	1
18-2026	Oil Seal	321453	1
18-3135	Screw	306643	2
18-3136	Screw	323626	4
18-2389	Grommet	314832	2





**18-3385
WATER PUMP KIT**

Without Housing
Replaces: 396932

— CONTAINS —

Part #	Desc.	O.E. #	Qty.
18-3368	Impeller	396809	1
18-3343	Impeller Plate	320981	1
18-2705	Seal	315748	1
18-7481	Rubber Seal	324981	1
18-7134	O-Ring	303059	1
18-3337	Water Tube Grommet	315837	1
18-3365	Stainless Steel Bolt	909533	2
18-3369	Stainless Steel Bolt	319126	2



**18-3387
WATER PUMP KIT**

Without Housing
Replaces: 432956

— CONTAINS —

Part #	Desc.	O.E. #	Qty.
18-2703	Grommet	314008	1
18-3053	Impeller	396725	1
18-2705	Seal	315748	1
18-3133	SS Bolt	331979	4
18-7174	O-Ring	326649	1
18-7481	O-Ring	324981	1
18-2709	Wear Plate Gasket	336530	1
18-3126	Wear Plate	321940	1
18-3127	Impeller Plate	319275	1
18-3138	Impeller Key	334897	1
18-3299	Flywheel Key	331107	1
18-3153	Stainless Steel Bolt	908158	1



**18-3388
WATER PUMP KIT**

Without Housing
Replaces: 389143

— CONTAINS —

Part #	Desc.	O.E. #	Qty.
18-0969	Impeller Housing Gasket	319586	1
18-3108	Stainless Steel Key	323950	1
18-2703	Grommet	314008	1
18-3127	Impeller Plate	319275	1
18-2705	Seal	315748	1
18-3082	Impeller	382547	1
18-3153	Stainless Steel Bolt	334597	1
18-2709	Wear Plate Gasket	336530	1
18-3133	Stainless Steel Bolt	331979	4
18-3126	Wear Plate	321940	1



**18-3389
WATER PUMP KIT**

With Housing
Replaces: 436957

— CONTAINS —

Part #	Desc.	O.E. #	Qty.
18-7481	O-Ring	324981	1
18-2703	Grommet	314008	1
18-3053	Impeller	396725	1
18-3127	Impeller Plate	319275	1
18-2705	Seal	315748	1
18-3133	Stainless Steel Bolt	908158	1
18-3299	Flywheel Key	331107	1
18-7174	O-Ring	326649	1
18-2709	Wear Plate Gasket	336530	1
18-3129	Housing	435673	1
18-3138	Impeller Key	334897	1
18-3126	Wear Plate	321940	1



**18-3390
WATER PUMP KIT**

Without Housing
Replaces: 395060

— CONTAINS —

Part #	Desc.	O.E. #	Qty.
18-3059	Impeller	397131, 435821	1
18-2557	Impeller Gasket	324701, 338484	1
18-3299	Impeller Key	331107	1
18-7158	O-Ring	310967, 310585	1
18-3135	Stainless Steel Screw	306643	2
18-2703	Grommet	314008	1
18-2704	Grommet	320943	1
18-2706	Grommet	321008	1
18-3136	Stainless Steel Bolt	323626	4
18-2769	Rubber Seal	332000	1
18-3133	Stainless Steel Bolt	331979	4
18-3346	Cup Plate Assy.	435027	1
18-3138	Impeller Key	334897	1



**18-3391
WATER PUMP KIT**

With Housing
Replaces: 395072

— CONTAINS —

Part #	Desc.	O.E. #	Qty.
18-3346	Cup & Plate Assy.	435027	1
18-2769	O-Ring	332000	1
18-2557	Impeller Plate Gasket	338484, 324701	1
18-2704	Grommet	320943	1
18-3136	Stainless Steel Bolt	323626	4
18-3299	Flywheel Key	331107	1
18-3153	Stainless Steel Bolt	908158	1

**18-3392
WATER PUMP KIT**

With Housing
Replaces: 434421

— CONTAINS —

Part #	Desc.	O.E. #	Qty.
18-3059	Impeller	395864, 397131, 435821	1
18-3346	Cup & Plate Assy.	435027	1
18-3299	Impeller Key	331107	1
18-7158	O-Ring	310967, 310585	1
18-3135	Stainless Steel Screw	306643	2
18-2703	Grommet	314008	1
18-2704	Grommet	320943	1
18-2706	Grommet	321008	1
18-3136	Stainless Steel Bolt	323626	4
18-2769	Rubber Seal	332000	1
18-2557	Impeller Gasket	324701, 338484	1
18-3133	Stainless Steel Bolt	331979	4



**18-3393
WATER PUMP KIT**

With Housing
Replaces: 395073

— CONTAINS —

Part #	Desc.	O.E. #	Qty.
18-3043	Impeller	389642	1
18-2557	Impeller Gasket	324701, 338484	1
18-3346	Cup & Plate Assy.	435027	1
18-3108	Water Pump Key	323950	1
18-0110	Shift Housing Gasket	324670	1
18-7158	O-Ring	310967, 310585	1
18-3135	Stainless Steel Screw	306643	2
18-2703	Grommet	314008	1
18-2704	Grommet	320943	1
18-2706	Grommet	321008	1
18-3136	Stainless Steel Bolt	323626	4
18-2769	O-Ring	332000	1
18-7143	O-Ring	322501	1
18-3133	Stainless Steel Bolt	331979	4



**18-3394
WATER PUMP KIT**

Without Housing
Replaces: 433548

— CONTAINS —

Part #	Desc.	O.E. #	Qty.
18-7481	O-Ring	324981	1
18-2708	Grommet	333758	1
18-2709	Wear Plate Gasket	336530	1
18-3104	Impeller	432941	1
18-3138	Impeller Key	334897	1
18-2705	Seal	315748	1
18-3133	Stainless Steel Bolt	331979	4
18-3126	Wear Plate	321940	1



**18-3399
WATER PUMP KIT**

With Housing
Replaces: 396933

— CONTAINS —

Part #	Desc.	O.E. #	Qty.
18-7134	O-Ring	303059	1
18-3337	Grommet	315837	1
18-3368	Impeller	396809	1
18-2709	Wear Plate Gasket	336530	1
18-3369	Screw (Short)	319126	2
18-2705	Seal	315748	1
18-3336	Housing	384087	1
18-3365	Screw (Long)	909533	2
18-3343	Wear Plate	320981	1



18-3400
WATER PUMP KIT
 Without Housing
 Replaces: 391698



— CONTAINS —

Part #	Desc.	O.E. #	Qty.
18-3050	Impeller	386084	1
18-3178	Impeller Plate	318995	1
18-3179	Water Pump Cup	324097	1
18-3329	Grommet	302497	1
18-2392	Grommet	327035	1
18-2025	Oil Seal	318972	1
18-7116	O-Ring	303097	1
18-3369	Screw	319126	4
18-3326	Pin	300771	1
18-7139	O-Ring	319085	1

18-3401
WATER PUMP KIT
 Without Housing
 Replaces: 395271



— CONTAINS —

Part #	Desc.	O.E. #	Qty.
18-3051	Impeller	395289	1
18-3360	Gasket	329398	1
18-3358	Cup	328773	1
18-7440-1	O-Ring	301967	2
18-2013	Oil Seal	321786	1
18-3329	Grommet	302497	1
18-0108	Gasket	324449	1
18-3133	Stainless Steel Bolt	331979	4

18-3402
WATER PUMP KIT
 Without Housing
 Replaces: 382296



— CONTAINS —

Part #	Desc.	O.E. #	Qty.
18-3003	Impeller	377178	1
18-3102	Impeller Plate	305303	1
18-2891	Gasket	303339	1
18-3326	Pin	300771	1
18-3329	Grommet	302497	1
18-2023	Oil Seal	313282	1

18-3403
WATER PUMP KIT
 Without Housing
 Replaces: 388644



— CONTAINS —

Part #	Desc.	O.E. #	Qty.
18-7158	O-Ring	310585	1
18-3108	Key	308928	1
18-2703	Grommet	314008	1
18-3135	Screw	306643	4
18-2026	Seal	321453	1
18-3136	Housing Screw	323626	1
18-3043	Impeller	389642	1
18-3346	Cup & Plate Assembly	435027	1
18-2536	Gasket	321120	1
18-2704	Grommet	320943	1

18-3315-2
WATER PUMP KIT
 With Housing
 Replaces: 435929, 5001595

For: 90/115SL (1995-UP), 120/125ESX (1993-94),
 120/130/140/150/175/V-6/V-8(1993-UP)

— CONTAINS —

Part #	Desc.	O.E. #	Qty.
18-2557	Gasket	324701	1
18-3405	Housing, WP	435485	1



STAINLESS STEEL BOLTS

Part #	O.E. #	Size
18-3133	331979	1/4 x 20 x 1 1/16"
18-3135 ①③	306643	1/8 x 20 x 1/2"
18-3136 ①③	323626	1/4 x 20 x 1 3/4"
18-3153	908158	1/4 x 20 x 1/2"
18-3365	909533	1/4 x 20 x 1"
18-3369	319126	1/4 x 20 x 1"
18-4276 ②③	324334	1/4 x 20 x 1 1/32"

① Std. Pkg. of 2 ② Std. Pkg. of 5

APPLICATION BEGINS ON NEXT PAGE

③ This product is priced per piece. To order priced per package, please add -9 to the part number.

Horsepower	Year	Impeller	Impeller Plate	Plate & Cup	Cup	Repair Kit	Pump Kit w/o Hsg.	Pump Kit W/Hsg.	Housing Kit
2 Jr. Colt	1985-90	18-3090	—	—	—	—	—	—	—
2.5	1987-06	18-3015	—	—	—	—	—	—	—
3	1952-78	18-3001	—	—	—	18-3201	—	—	—
3.5	1987-06	18-3015	—	—	—	—	—	—	—
4	1969-72	18-3001	—	—	—	18-3201	—	—	—
4	⑦ 1973-83	18-3001	—	—	—	18-3201	—	—	—
4	⑧ 1976-80	18-3090	—	—	—	—	—	—	—
4 Deluxe	1980-97	18-3091	—	—	—	—	—	—	—
4 Ultra Excel	1987-06	18-3015	—	—	—	—	—	—	—
4.5	1980-97	18-3091	—	—	—	—	—	—	—
5	1965-68	18-3001	—	—	—	—	—	—	—
5 (4-Stroke)	1998-Up	18-3091	—	—	—	—	—	—	—
5.5	1954-64	18-3001	18-3102	—	—	18-3202	—	—	—
6	1952-78	18-3001	18-3102	—	—	18-3202	—	—	—
6	1979	18-3090	—	—	—	—	—	—	—
6	1984-97	18-3091	—	—	—	—	—	—	—
6 (4-Stroke)	1998-Up	18-3091	—	—	—	—	—	—	—
7.5	1954-58	18-3001	18-3102	—	—	18-3202	—	—	—
8 (2-Stroke)	1986-97	18-3091	—	—	—	—	—	—	—
9.5	1964-73	18-3003	18-3102	—	—	—	18-3402	—	—
10	1958-63	18-3003	18-3102	—	—	—	18-3402	—	—
10	1949-57	18-3002	18-3103	—	—	18-3203	18-3377	—	—
9.9/15	1974-Up	18-3050	18-3178	—	18-3179	—	18-3400	18-3327	18-3180
9.9/15 (4-Stroke)	1995-Up	18-3050	18-3178	—	18-3179	—	18-3400	18-3327	18-3180
15,18	1953-65	18-3002	—	—	—	18-3203	18-3377	—	—
20	1966-73	18-3002	—	—	—	18-3203	18-3377	—	—
20	1982-84	18-3051	—	—	18-3358	—	18-3401	18-3383	18-3363
20	1985-Up	18-3051	18-3359	—	18-3358	—	18-3381	18-3382	18-3367
25	1951-55	18-3006	—	—	—	—	—	—	—
25	1969-78	18-3002	18-3103	—	—	18-3203	18-3377	—	—
25	1979-84	18-3051	—	—	18-3358	—	18-3401	18-3383	18-3363
25	1985-Up	18-3051	18-3359	—	18-3358	—	18-3381	18-3382	18-3367
28	1962-64	18-3006	—	—	—	—	—	—	—
28	1978-Up	18-3051	—	—	18-3358	—	18-3401	18-3383	18-3363
30	1951-57	18-3006	—	—	—	—	—	—	—
30	1984-Up	18-3051	18-3359	—	18-3358	—	18-3381	18-3382	18-3367
33	1962-71	18-3006	—	—	—	—	—	—	—
35	1951-57	18-3006	—	—	—	—	—	—	—
35	1958-59	18-3083	—	—	—	—	—	—	—
35	1976-77	18-3006	—	—	—	—	—	—	—
35	1978-79	18-3051	—	—	—	—	18-3238	—	—
35	1980-82	18-3051	N/A	—	18-3358	—	—	18-3382	18-3367
35	1983-Up	18-3051	18-3359	—	18-3358	—	—	—	—
35 Jet	1992-93	18-3104	—	—	—	—	18-3394	—	—
40	1960-70	18-3083	—	—	—	—	—	—	—
40	1971-73	18-3006	—	—	—	—	—	—	—
40 Comm.	1981-90	18-3366	18-3352	—	—	—	18-3379	—	—
40	1984-85	18-3055	18-3343	—	—	—	18-3385	18-3399	18-3336
40	1986-88	18-3368	18-3343	—	—	—	18-3385	18-3399	18-3336
40	1989-98	18-3104	—	—	—	—	18-3394	—	—
40	1999-Up	18-3053	—	—	—	—	18-3394	—	—
45/55 Comm.	1985	18-3055	—	—	—	—	18-3380	—	18-3336
45/55	1989	18-3368	18-3343	—	—	—	18-3385	18-3399	18-3336
45/55 Comm.	1986-88,	18-3368	—	—	—	—	18-3385	18-3399	18-3336
48	1987-88	18-3368	18-3343	—	—	—	18-3385	18-3399	18-3336
48	1989-96	18-3104	18-3127	—	—	—	18-3394	—	—
50	1971-78	18-3083	18-3343	—	—	—	18-3376	—	—
50	1979-85	18-3055	18-3343	—	—	—	18-3380	18-3378	18-3336
50	1986-88	18-3368	18-3343	—	—	—	18-3385	18-3399	18-3336
50	1989-98	18-3104	—	—	—	—	18-3394	—	—
55	1968-69	18-3082	—	—	—	—	—	—	—
55	1976-78	18-3083	—	—	—	—	—	—	18-3336
55	1979-85	18-3055	18-3343	—	—	—	18-3380	18-3378	18-3336
60	1964-67	18-3005	—	—	—	—	—	—	—
60	1970-71	18-3082	—	—	—	—	—	—	—
60	1980-85	18-3055	—	—	—	—	18-3380	18-3378	18-3336
60	1986-94	18-3053	18-3127	—	—	—	18-3387	18-3389	—
60	1995-Up	18-3053	18-3127	—	—	—	18-3387	—	—
65	1968	18-3005	—	—	—	—	—	—	—
65	1972-73	18-3082	—	—	—	—	—	—	—
65 Comm.	1984-94	18-3053	18-3127	—	—	—	18-3387	18-3389	—
65 Comm.	1995-Up	18-3053	18-3127	—	—	—	18-3387	—	—
70	1974-78	18-3082	18-3127	—	—	—	18-3388	—	—
70	1979-94	18-3053	18-3127	—	—	—	18-3387	18-3389	—
70	1995-Up	18-3053	18-3127	—	—	—	18-3387	—	—
75	1960-65	18-3005	—	—	—	—	—	—	—
75	1974-78	18-3082	18-3127	—	—	—	18-3388	—	—
75	1979-88	18-3053	18-3127	—	—	—	18-3387	18-3389	18-3129
80	1966-67	18-3005	—	—	—	—	—	—	—
85	1968	18-3005	—	—	—	—	—	—	—

① Except chrome pumps ③ "S" Suffix ⑤ Except 1993-94 25" & 30" V6 & V8
 ② Except SL models 1995 & Up/FFI models ④ "F" Suffix ⑦ For water pumps using 1 water tube ⑧ 90 degree gearcase

Horsepower	Year	Impeller	Impeller Plate	Plate & Cup	Cup	Repair Kit	Pump Kit w/o Hsg.	Pump Kit W/Hsg.	Housing Kit
85	1969-72	18-3044	18-3182	—	—	—	—	—	—
85	1973-77	18-3043	18-3182	—	—	—	18-3384	—	—
85	1978	18-3043	—	18-3346	—	—	—	18-3393⑦	18-3391
85	1979-95	18-3059	—	18-3346	—	18-3211	18-3390	18-3392	18-3391
90	1964-68	18-3005	—	—	—	—	—	—	—
90	1979-Up	18-3059	—	18-3346	—	18-3211	18-3390	18-3392②	18-3391
90 SL,DI	1995 & UP	18-3059	—	18-3346	—	18-3211	18-3390	18-3315-2	18-3405
100	1969-72	18-3044	—	—	—	—	—	—	—
100	1979-Up	18-3059	—	18-3346	—	18-3211	18-3390	18-3392	18-3391
100 Comm. ①	1984-Up	18-3059	—	18-3346	—	18-3211	18-3390	18-3392	18-3391
105 Comm.	1998-2001	18-3059	—	18-3346	—	18-3211	18-3390	18-3315-2	18-3405
115	1969-70	18-3044	—	—	—	—	—	—	—
115	1973-76	18-3043	—	—	—	—	18-3384	—	—
115	1977-78	18-3043	—	18-3346	—	—	—	18-3393⑦	18-3391
115	1979-Up	18-3059	—	18-3346	—	18-3211	18-3390	18-3392②	18-3391
115 SL,DL	1995 & UP	18-3059	—	18-3346	—	18-3211	18-3390	18-3315-2	18-3405
120 25" ④	1993-2000	18-3059	—	18-3346	—	18-3211	18-3390	18-3315-2	18-3405
125	1971-72	18-3044	—	—	—	—	—	—	—
125 ESX 25" ③	1993-94	18-3059	—	18-3346	—	18-3211	18-3390	18-3392	18-3391
125 ESX 25"	1994-95	18-3059	—	18-3346	—	18-3211	18-3390	18-3392	18-3391
125 ESX 25" ④	1993-94	18-3059	—	18-3346	—	18-3211	18-3390	—	—
130	1997 & UP	18-3059	—	18-3346	—	18-3211	18-3390	18-3315-2	18-3405
130 25"	1994-2000	18-3059	—	18-3346	—	18-3211	18-3390	18-3315-1	18-3405
135	1973-75	18-3043	18-3182	—	—	18-3210	18-3384	—	—
135	1976	18-3043	18-3182	—	—	—	—	—	—
135 25"	2001	18-3059	—	18-3346	—	18-3211	18-3390	18-3315-2	18-3405
140	1977-78	18-3043	—	18-3346	—	—	—	18-3393⑦	18-3391
140	1979-Up	18-3059	—	18-3346	—	18-3211	18-3390	18-3392	18-3391
140 25" ④	1993	18-3059	—	18-3346	—	18-3211	18-3390	18-3315-2	18-3405
140 25"	1994-2000	18-3059	—	18-3346	—	18-3211	18-3390	18-3315-2	18-3405
150	1976-78	18-3043	—	18-3346	—	18-3210	—	18-3393⑦	18-3391
150	1979-Up	18-3059	—	18-3346	—	18-3211	18-3390	18-3392	18-3391
150 20"	1993 & UP	18-3059	—	18-3346	—	18-3211	18-3390	18-3392	18-3391
150 SL 20"	1994-98	18-3059	—	18-3346	—	18-3211	18-3390	18-3315-2	18-3405
150 EL 20"	1996-98	18-3059	—	18-3346	—	18-3211	18-3390	18-3315-2	18-3405
150 25"	1993 & UP	18-3059	—	18-3346	—	18-3211	18-3390	18-3315-2	18-3405
150 DI	1997 & UP	18-3059	—	18-3346	—	18-3211	18-3390	18-3315-2	18-3405
150	2000 & UP	18-3059	—	18-3346	—	18-3211	18-3390	18-3315-2	18-3405
175	1976-78	18-3043	—	18-3346	—	18-3210	—	18-3393⑦	18-3391
175 SL 20"	1994-98	18-3059	—	18-3346	—	18-3211	18-3390	18-3315-2	18-3405
175 EL 20"	1996-98	18-3059	—	18-3346	—	18-3211	18-3390	18-3315-2	18-3405
175 25"	1993 & UP	18-3059	—	18-3346	—	18-3211	18-3390	18-3315-2	18-3405
175 DI	1997 & UP	18-3059	—	18-3346	—	18-3211	18-3390	18-3315-2	18-3405
175	2000 & UP	18-3059	—	18-3346	—	18-3211	18-3390	18-3315-2	18-3405
200	1976-78	18-3043	—	18-3346	—	—	—	18-3393⑦	18-3391
200 Comm.	1990	18-3059	—	18-3346	—	18-3211	18-3390	18-3392	18-3391
200 25" & 30"	1993-97	18-3059	—	18-3346	—	18-3211	18-3390	18-3315-2	18-3405
225 20"	1993 & UP	18-3059	—	18-3346	—	18-3211	18-3390	18-3392	18-3391
225 25" & 30"	1993-97	18-3059	—	18-3346	—	18-3211	18-3390	18-3315-2	18-3405
235	1978	18-3043	—	18-3346	—	—	—	18-3393⑦	18-3391
235	1979-Up	18-3059	—	18-3346	—	18-3211	18-3390	18-3392	18-3391
V4 Cross 20" & 25"	1993 & UP	18-3059	—	18-3346	—	18-3211	18-3390	18-3392	18-3391
V4 Loop 20"	1993 & UP	18-3059	—	18-3346	—	18-3211	18-3390	18-3392	18-3391
V4, V6, V8 ⑤	1982-94	18-3059	—	18-3346	—	18-3211	18-3390	18-3392	18-3391
V6, V8 20"	1993 & UP	18-3059	—	18-3346	—	18-3211	18-3390	18-3392	18-3391
V6 & V8 25" & 30"	1993 & UP	18-3059	—	18-3346	—	18-3211	18-3390	18-3315-2	18-3405
Sea Drives	1979-Up	18-3059	—	18-3346	—	18-3211	18-3390	18-3392⑥	18-3391

① Except chrome pumps ③ "S" Suffix ⑤ Except 1993-94 25" & 30" V6 & V8
 ② Except SL models 1995 & Up/FFI models ④ "F" Suffix ⑦ For water pumps using 1 water tube ⑧ 90 degree gearcase

 <p>18-3563 POPPET RELIEF VALVE V-6 Crossflow Replaces: 321027</p>	 <p>18-3564 POPPET RELIEF VALVE V-4 Crossflow Replaces: 318395</p>	 <p>18-1219 GROMMET V-6 Crossflow Replaces: 320880</p>	<p>PKG. OF 2</p>  <p>18-1221 18-1221-9① RETAINER GASKET V-4/V-6 Loop Charge Replaces: 330273</p>
 <p>18-3562 VALVE CUP V-6 Crossflow Replaces: 321222</p>	 <p>18-1243 VALVE SPRING V-4/V-6 Crossflow Replaces: 317245</p>	 <p>18-1222 THERMOSTAT GASKET V-4/V-6 Loop Charge Replaces: 394408</p>	 <p>18-3567 RUBBER VALVE V-6 Crossflow Replaces: 321221</p>

① Priced per Package



**18-3565
RETAINER**
V-6 Crossflow
Replaces: 321220



**18-2391
GROMMET**
V-4 Crossflow
Replaces: 321692



**18-3500
THERMOSTAT**
Replaces: 434137
For: 3 cyl. (1992 & UP),
90° Looper (1990-1992)
140°



**18-3544
THERMOSTAT**
Replaces: 435491
Fits: E100 (2004-06), E110 (04-06), E115 (2002-06), E75 (2002-03), E90 (2002-03), E150 (1991-94), E175 (1991-94), J105 (2003), J115 (2002-06), J150 (1991-92, 1993-94, 2002-06), J175 (1991-92, 1994, 2002-06), J90 (2004-06)



**18-3545
THERMOSTAT 130°**
Replace: 437090
Fits: E115 (1997),
E135, E150, E175 (2000-06)



**18-3546
THERMOSTAT 130°**
Replaces: 5001036
Fits: E200, E225, E250 (2000-05),
J200, J225, J250 (2000-01)



**18-3543
THERMOSTAT**
Replaces: 393659, 434841,
378065, 508626, 5005440
Fits: 40-250hp E-tech, 6-55hp, Cross V4 & V6,
9.9 4-Stroke (1994-01), 15 4-Stroke (1994-01)
143°



**18-3557
THERMOSTAT**
Replaces: 396987, 382385
143°



**18-3561
THERMOSTAT**
Replaces: 436195
143°



**18-1506
VERNATHERM 143°**
Replaces: 394411
For: 10/15 (1993-95), 60/125/185 (1989-90),
65 (1987-89), 70/200/225 (1986-90),
120/140/300 (1985-90), 275 (1985-88)



**18-3560
VERNATHERM**
Replaces: 384719
105°
Fits most 3 & 4 cyl., 1985-90

① **18-3669D** 



**18-3669
THERMOSTAT KIT**
– CONTENTS –

Part #	Description	O.E. #
18-3557	Thermostat	396987
18-2548	Thermostat Cover Gasket	332108
18-0929	Thermostat Gasket	313416

① **18-3673D** 



**18-3673
THERMOSTAT KIT**
V-4 Crossflow

① **18-3674D** 



**18-3674
THERMOSTAT KIT**
V-6 Crossflow



**18-3566
TELL TALE
HOSE ELBOW**
Replaces: 331894



**18-1507
THERMOSTAT SEAL**
Replaces: 335981
For: 60° V-4 & V-6



**18-1734
THERMOSTAT SEAL**
Replaces: 334742
For: OMC thermostat application 6, 8, 10, 15,
40, 48, 50 HP (1989-94)

APPLICATION BEGINS ON PAGE 241

① Items ending in "D" are Display Packaged - Regular number is Non-Display

Crossflow V-4 Engine

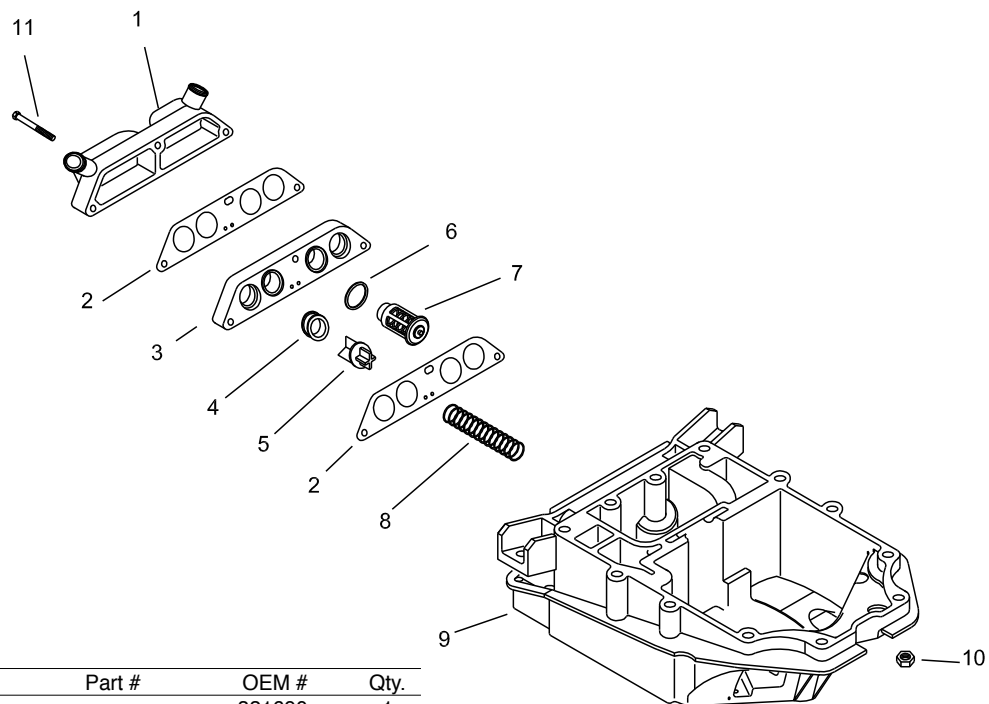

Fig. #	Description	Part #	OEM #	Qty.
1	Cover	~	321690	1
2	Gasket	18-0977	332369	2
3	Valve Body	~	321693	1
4	Grommet	18-2391	321692	2
5	Valve	18-3564	318395	2
6	Thermostat Gasket	18-0675	321932	2
7	Thermostat	18-3543	434841, 393659	2
8	Spring	18-1243	317245	2
9	Adapter	~	331039	1
10	Nut	~	306422	4
11	Screw Cover	~	305652	3

Crossflow V-6 Engine

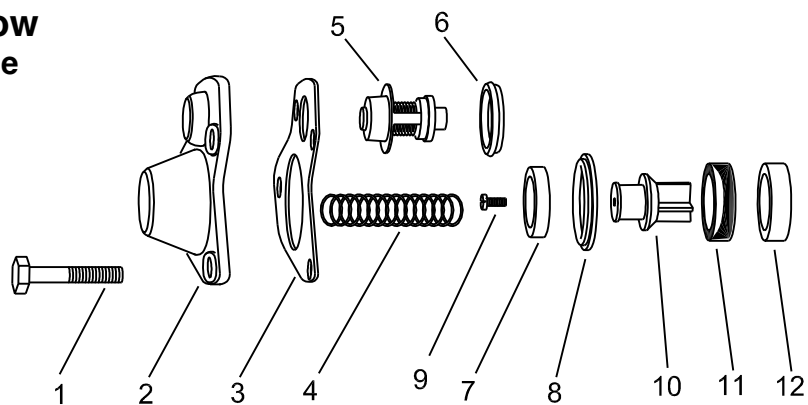

Fig. #	Description	Part #	OEM #	Qty.
1	Screw	—	306778	4
2	Cover	—	321013	1
3	Gasket	18-2546	321184	1
4	Spring	18-1243	317245	1
5	Thermostat	18-3543	393659	1
6	Thermostat Gasket	18-0182	310058	1
7	Retainer	18-3565	321220	1
8	Seal	18-3567	321221	1
9	Stainless Steel Bolt	18-3135	306643	1
10	Valve	18-3563	321027	1
11	Grommet	18-1219	320880	1
12	Valve Cap	18-3562	321222	1

APPLICATION ON NEXT PAGE

HP	Years	Thermostat Kit	Thermostat	Valve	Valve Seat	Valve Diaphragm	Valve Retainer	Valve Cup	Valve Spring	Grommet
5	1965-68, 1986	18-3672 ⑤	18-3543	—	—	—	—	—	—	—
5.5	1959-64	18-3672 ⑤	18-3543	—	—	—	—	—	—	—
6	1965-79, 1986	18-3672 ⑤	18-3543	—	—	—	—	—	—	—
7.5	1980-86	18-3672 ⑤	18-3543	—	—	—	—	—	—	—
8	1986	18-3672 ⑤	18-3543	—	—	—	—	—	—	—
9.5	1964-73	18-3672 ⑤	18-3543	—	—	—	—	—	—	—
9.9	1974-86	18-3672 ⑤	18-3543	—	—	—	—	—	—	—
10	1959-63	18-3672 ⑤	18-3543	—	—	—	—	—	—	—
15	1974-86	18-3672 ⑤	18-3543	—	—	—	—	—	—	—
18	1959-73	18-3672 ⑤	18-3543	—	—	—	—	—	—	—
20	1981-94	18-3672 ⑤	18-3543	—	—	—	—	—	—	—
25 ①	1969-94	18-3672 ⑤	18-3543	—	—	—	—	—	—	—
28	1989-94	18-3672 ⑤	18-3543	—	—	—	—	—	—	—
30	1986-94	18-3672 ⑤	18-3543	—	—	—	—	—	—	—
35	1959, 1976-94	18-3672 ⑤	18-3543	—	—	—	—	—	—	—
40	1960-69	18-3672 ⑤	18-3543	—	—	—	—	—	—	—
45	1989-92 ②	18-3672 ⑤	18-3543	—	—	—	—	—	—	—
50	1971-75, 1979, 1981-86	18-3672 ⑤	18-3543	—	—	—	—	—	—	—
55	1976-92 ③	18-3672 ⑤	18-3543	—	—	—	—	—	—	—
60	1969-70	18-3669 ⑤	18-3557	—	—	—	—	—	—	—
60	1980-86	18-3672 ⑤	18-3543	—	—	—	—	—	—	—
60, 60TTL	1993	—	18-3561	—	—	—	—	—	—	—
65	1971-73	18-3669	18-3557	—	—	—	—	—	—	—
65	1993	—	18-3561	—	—	—	—	—	—	—
65C	1984-86	18-3669	18-3557	—	—	—	—	—	—	—
65 Jet	1994-95	18-3673	18-3543	18-3564	—	—	—	—	18-1243	18-2391
70	1974-86	18-3669	18-3557	—	—	—	—	—	—	—
70,70TTL	1993	—	18-3561	—	—	—	—	—	—	—
75	1978-88	18-3669	18-3557	—	—	—	—	—	—	—
80 Jet	1994-95	18-3673	18-3543	18-3564	—	—	—	—	18-1243	18-2391
85	1978-80	18-3673	18-3543	18-3564	—	—	—	—	18-1243	18-2391
85	1993-95	18-3673	18-3543	18-3564	—	—	—	—	18-1243	18-2391
88	1987-95	18-3673	18-3543	18-3564	—	—	—	—	18-1243	18-2391
90 ④	1983-95	18-3673	18-3543	18-3564	—	—	—	—	18-1243	18-2391
90 Jet	1994	18-3673	18-3543	18-3564	—	—	—	—	18-1243	18-2391
100	1979-80	18-3673	18-3543	18-3564	—	—	—	—	18-1243	18-2391
100	1990-95	18-3673	18-3543	18-3564	—	—	—	—	18-1243	18-2391
100 Comm	1984-95	18-3673	18-3543	18-3564	—	—	—	—	—	—
110	1985-89	18-3673	18-3543	18-3564	—	—	—	—	18-1243	18-2391
112	1994-95	18-3673	18-3543	18-3564	—	—	—	—	18-1243	18-2391
115 ④	1978-95	18-3673	18-3543	18-3564	—	—	—	—	18-1243	18-2391
120	1988-91	—	—	—	—	18-1222	—	18-1221	—	—
140	1978-85	18-3673	18-3543	18-3564	—	—	—	—	18-1243	18-2391
140	1988-91	—	—	—	—	18-1222	—	18-1221	—	—
150	1978-91	18-3672 ⑤	18-3543	18-3563	18-1219	18-3567	18-3565	18-3562	18-1243	18-0182
155	1984-91	18-3672 ⑤	18-3543	18-3563	18-1219	18-3567	18-3565	18-3562	18-1243	18-0182
175	1977-91	18-3672 ⑤	18-3543	18-3563	18-1219	18-3567	18-3565	18-3562	18-1243	18-0182
185	1984-85	18-3672 ⑤	18-3543	18-3563	18-1219	18-3567	18-3565	18-3562	18-1243	18-0182
200	1977-83	18-3672 ⑤	18-3543	18-3563	18-1219	18-3567	18-3565	18-3562	18-1243	18-0182
200	1988-93	—	—	—	—	18-1222	18-3565	18-1221	—	—
225	1988-93	—	—	—	—	18-1222	18-3565	18-1221	—	—
235	1978-85	18-3672 ⑤	18-3543	18-3563	18-1219	18-3567	18-3565	18-3562	18-1243	18-0182

① All 1989-91 models except DR & DT ③ Commercial also ⑤ For complete Thermostat Kit including gaskets & spring use 18-3674
 ② Commercial ④ Except 60 degree models



Piston Rings are available individually

SIERRA PISTON KIT CONTENTS

(SEE APPLICATION CHARTS FOR SPECIFIC APPLICATIONS)

Model / HP	Cyl.	Bore size	Piston	OEM Part #	Piston Ring	OEM Part #	OEM Part #	Circlips	OEM Part #
9.9/15	2	2.188 / std.	—	397487	18-3931	386279	N/A	—	325262
9.9/15	2	2.218 / .030	—	396574	18-3933	386280	N/A	—	325262
9.9/15	2	2.188 / std.	18-4061	387660	18-3931	386279	N/A	—	325262
9.9/15	2	2.218 / .030	18-4062	387661	18-3933	386280	N/A	—	325262
25-35	2	3.000 / std.	18-4107	392621	18-3910	396377	320954	18-4290	317831
25-35	2	3.020 / .020	18-4117	N/A	18-3911	396378	320954	18-4290	317831
25-35	2	3.030 / .030	—	396576	18-3912	396379	320954	18-4290	317831
35-60	2 & 3	3.187 / std.	—	391798	18-3913	391170, 434107	322188	18-4290	317831
35-60	2 & 3	3.207 / .020	—	N/A	18-3914	N/A	322188	18-4290	317831
35-60	2 & 3	3.217 / .030	—	396581	18-3915	391416, 434109	322188	18-4290	317831
60-75	3	3.000 / std.	18-4124	387284	18-3910	396377	320954	18-4290	317831
60-75	3	3.020 / .020	18-4114	387285	18-3911	396378	320954	18-4290	317831
60-75	3	3.030 / .030	18-4104	396583	18-3912	396379	320954	18-4290	317831
50-70	3	3.187 / std.	18-4063	394461	18-3913	391170, 434107	322188	18-4290	317831
50-70	3	3.217 / .030	18-4064	398483	18-3915	391416, 434109	322188	18-4290	317831

SIERRA V-4/V-6 PISTON KIT CONTENTS

(SEE APPLICATION CHARTS FOR SPECIFIC APPLICATIONS)

Model/HP	Cyl.	Bore Size	Piston	OEM Part #	Piston Ring	OEM Part #	Wrist Pin	OEM Part #	Circlips	OEM Part #
85-300	4 & 6	3.500	18-4120	393271, 393924	18-3904	394930	18-4280	327861	18-4290	317831
85-300	4 & 6	3.520	18-4110	—	18-3906	396503, 385662	18-4280	327861	18-4290	317831
85-300	4 & 6	3.530	18-4100	396585, 396588	18-3905	396504	18-4280	327861	18-4290	317831
150-235	4 & 6	3.625	18-4123	392455	18-3907	390509	18-4280	327861	18-4290	317831
150-235	4 & 6	3.645	18-4113	N/A	—	N/A	18-4280	327861	18-4290	317831
150-235	4 & 6	3.655	—	396587	18-3908	390510	18-4280	327861	18-4290	317831

Loopers

120-300	4 & 6	3.685 (port)	18-4065	432072, 432969	18-3975	431870	N.S.S.	—	18-4292	326765
120-300	4 & 6	3.685 (starboard)	18-4066	432073, 432970	18-3975	431870	N.S.S.	—	18-4292	326765
120-300	4 & 6	3.715 (port)	18-4067	432077, 433003	—	431844	N.S.S.	—	18-4292	326765
120-300	4 & 6	3.715 (starboard)	18-4068	432078, 433004	—	431844	N.S.S.	—	18-4292	326765
120-300	4 & 6	3.500 (port)	—	393566	18-3904	394930	18-4280	327861	18-4290	317831
120-300	4 & 6	3.500 (starboard)	—	391481	18-3904	394930	18-4280	327861	18-4290	317831
120-300	4 & 6	3.520 (port)	18-4112	N/A	18-3906	396503, 385662	18-4280	327861	18-4290	317831
120-300	4 & 6	3.520 (starboard)	18-4111	N/A	18-3906	396503, 385662	18-4280	327861	18-4290	317831
120-300	4 & 6	3.530 (port)	18-4102	393612	18-3905	396504	18-4280	327861	18-4290	317831
120-300	4 & 6	3.530 (starboard)	18-4101	391653	18-3905	396504	18-4280	327861	18-4290	317831
185, 200-225	6	3.5995 (port)	standard 18-4190	436860	18-3901	436254	—	—	—	—
185, 200-225	6	3.5995 (starboard)	standard 18-4079	436859	18-3901	436254	—	—	—	—
185, 200-225	6	3.5995 (port)	.020 18-4195	439015	—	439538	—	—	—	—
185, 200-225	6	3.5995 (starboard)	.020 18-4086	439516	—	439538	—	—	—	—

INLINE PISTON & RINGS APPLICATION

HP	YEAR	CYL	STD. BORE	STD PISTON	.020 OS PISTON	.030 OS PISTON	STD RINGS	.020 OS RINGS	.030 OS RINGS
5/6/8	1986-95	2	1.937	18-4069	—	—	18-3972	—	—
9.9/15	1974-80	2	2.188	18-4061	—	18-4062	18-3931	—	18-3933
9.9/15	1981-93	2	2.188	—	—	—	18-3931	—	18-3933
10	1988-90	2	2.188	—	—	—	18-3931	—	18-3933
14	1988-90	2	2.188	—	—	—	18-3931	—	18-3933
15 4-Stroke	1995-UP	2	2.188	—	—	—	18-3931	—	18-3933
18 Jet	1995-98	2	3.000	18-4107	18-4117	—	18-3910	18-3911	18-3912
20	1981-99	2	3.000	18-4107	18-4117	—	18-3910	18-3911	18-3912
25	1977-80	2	3.000	—	—	—	18-3910	18-3911	18-3912
25	1981-96	2	3.000	18-4107	18-4117	—	18-3910	18-3911	18-3912
25	1983-93	2	3.187	—	18-4115	18-4105	18-3913	18-3914	18-3915
28	1986-96	2	3.000	18-4107	18-4117	—	18-3910	18-3911	18-3912

APPLICATION CHART CONTINUED ON NEXT PAGE

INLINE PISTON & RINGS APPLICATION

HP	YEAR	CYL	STD. BORE	STD PISTON	.020 OS PISTON	.030 OS PISTON	STD RINGS	.020 OS RINGS	.030 OS RINGS
28 Jet	1995-96	2	3.187	—	18-4115	18-4105	18-3913	18-3914	18-3915
30	1984-98	2	3.000	18-4107	18-4117	—	18-3910	18-3911	18-3912
35	1976-80	2	3.000	—	—	—	18-3910	18-3911	18-3912
35	1981-92	2	3.000	18-4107	18-4117	—	18-3910	18-3911	18-3912
35	1986-87	2	3.187	—	18-4115	18-4105	18-3913	18-3914	18-3915
35 Jet	1990-98	2	3.187	—	18-4115	18-4105	18-3913	18-3914	18-3915
40	1975-83	2	3.187	—	—	—	18-3913	18-3914	18-3915
40	1984-98	2	3.187	—	18-4115	18-4105	18-3913	18-3914	18-3915
40 Comm.	1981-97	2	3.187	—	—	—	18-3913	18-3914	18-3915
45 Comm.	1985-92	2	3.187	—	18-4115	18-4105	18-3913	18-3914	18-3915
45SS	1987-90	2	3.187	—	18-4115	18-4105	18-3913	18-3914	18-3915
48	1987-97	2	3.187	—	18-4115	18-4105	18-3913	18-3914	18-3915
50	1981-95	2	3.187	—	18-4115	18-4105	18-3913	18-3914	18-3915
50	1995-98	3	3.187	18-4063	—	18-4064	18-3913	18-3914	18-3915
55	1976-79	2	3.187	—	—	—	18-3913	18-3914	18-3915
55 Comm.	1980-95	2	3.187	—	18-4115	18-4105	18-3913	18-3914	18-3915
60	1980-85	2	3.187	—	18-4115	18-4105	18-3913	18-3914	18-3915
60 (49 CID Model)	1986-88	3	3.000	18-4124	18-4114	18-4104	18-3910	18-3911	18-3912
60	1986-98	3	3.187	18-4063	—	18-4064	18-3913	18-3914	18-3915
65, 65 Comm.	1972-73	3	3.000	—	—	—	18-3910	18-3911	18-3912
49 CID Model	1984-86	3	3.000	18-4124	18-4114	18-4104	18-3910	18-3911	18-3912
65	1987-95	3	3.187	18-4063	—	18-4064	18-3913	18-3914	18-3915
65 Jet	1991-95	4	3.500	18-4120	18-4110	18-4100	18-3904	18-3906	18-3905
70	1974-75	3	3.000	—	—	—	18-3910	18-3911	18-3912
70	1976-85	3	3.000	18-4124	18-4114	18-4104	18-3910	18-3911	18-3912
70	1986-94	3	3.187	18-4063	—	18-4064	18-3913	18-3914	18-3915
75	1975	3	3.000	—	—	—	18-3910	18-3911	18-3912
75	1976-88	3	3.000	18-4124	18-4114	18-4104	18-3910	18-3911	18-3912

JOHNSON/EVINRUDE PISTONS (for V-4, V-6 and V-8 Applications)

H.P.	CYL.	YEAR	STD.	STANDARD		.020" O.S		.030" O.S		PISTON RINGS	.020" O.S. RINGS	.030" O.S. RINGS	POWERHEAD BEARING SET
			BORE	(PORT)	(STBD)	(PORT)	(STBD)	(PORT)	(STBD)				
65 Jet	4	1991-95	3.500	18-4120	18-4120	18-4110	18-4110	18-4100	18-4100	18-3904	18-3906	18-3905	18-1386
80 Jet	4	1991-96	3.500	18-4120	18-4120	18-4110	18-4110	18-4100	18-4100	18-3904	18-3906	18-3905	—
85	4	1979-80, 1991-95	3.500	18-4120	18-4120	18-4110	18-4110	18-4100	18-4100	18-3904	18-3906	18-3905	18-1386
88	4	1987-95	3.500	18-4120	18-4120	18-4110	18-4110	18-4100	18-4100	18-3904	18-3906	18-3905	18-1386
90	4	1981-98	3.500	18-4120	18-4120	18-4110	18-4110	18-4100	18-4100	18-3904	18-3906	18-3905	18-1386
100 ①	4	1979-97	3.500	18-4120	18-4120	18-4110	18-4110	18-4100	18-4100	18-3904	18-3906	18-3905	18-1386
110	4	1986-90	3.500	18-4120	18-4120	18-4110	18-4110	18-4100	18-4100	18-3904	18-3906	18-3905	18-1386
115	4	1974-77	3.500	18-4120	18-4120	18-4110	18-4110	18-4100	18-4100	18-3904	18-3906	18-3905	—
115	4	1978-98	3.500	18-4120	18-4120	18-4110	18-4110	18-4100	18-4100	18-3904	18-3906	18-3905	18-1386
120	4	1985-87	3.500	18-4122	—	18-4112	18-4111	18-4102	18-4101	18-3904	18-3906	18-3905	—
120	4	1988-94	3.685	18-4065	18-4066	—	—	18-4067	18-4068	18-3975	—	—	—
125 Comm.	4	1992-95	3.685	18-4065	18-4066	—	—	18-4067	18-4068	18-3975	—	—	—
130	4	1995-98	3.685	18-4065	18-4066	—	—	18-4067	18-4068	18-3975	—	—	—
135	4	1974-76	3.500	18-4120	18-4120	18-4110	18-4110	18-4100	18-4100	18-3904	18-3906	18-3905	—
140	4	1977	3.500	18-4120	18-4120	18-4110	18-4110	18-4100	18-4100	18-3904	18-3906	18-3905	—
140	4	1978-84	3.500	18-4120	18-4120	18-4110	18-4110	18-4100	18-4100	18-3904	18-3906	18-3905	18-1386
140	4	1985-87	3.500	18-4122	—	18-4112	18-4111	18-4102	18-4101	18-3904	18-3906	18-3905	—
140	4	1988-94	3.685	18-4065	18-4066	—	—	18-4067	18-4068	18-3975	—	—	—
1600CC	4	1988	3.500	18-4120	18-4120	18-4110	18-4110	18-4100	18-4100	18-3904	18-3906	18-3905	18-1386
150	6	1973-77	3.500	18-4120	18-4120	18-4110	18-4110	18-4100	18-4100	18-3904	18-3906	18-3905	—
150	6	1978-91	3.500	18-4120	18-4120	18-4110	18-4110	18-4100	18-4100	18-3904	18-3906	18-3905	—
155 Comm.	6	1984-92	3.500	18-4120	18-4120	18-4110	18-4110	18-4100	18-4100	18-3904	18-3906	18-3905	—
175	6	1977-83	3.500	18-4120	18-4120	18-4110	18-4110	18-4100	18-4100	18-3904	18-3906	18-3905	—
175	6	1986-91	3.625	18-4123	18-4123	18-4113	18-4113	18-4103	18-4103	18-3907	—	18-3908	—
185	6	1984-85	3.500	18-4120	18-4120	18-4110	18-4110	18-4100	18-4100	18-3904	18-3906	18-3905	—
185	6	1990-93	—	—	—	—	—	—	—	—	—	—	18-1389
185 Looper	6	1993-94	3.5995	18-4190	18-4079	18-4195	18-4086	—	—	—	—	—	—
200	6	1976-83	3.500	18-4120	18-4120	18-4110	18-4110	18-4100	18-4100	18-3904	18-3906	18-3905	18-1389
200	6	1985-87	3.500	18-4122	—	18-4112	18-4111	18-4102	18-4101	18-3904	18-3906	18-3905	—
200 ①	6	1988-93	3.685	18-4065	18-4066	—	—	18-4067	18-4068	18-3975	—	—	18-1389
200-225 Looper	6	1993-01	3.5995	18-4190	18-4079	18-4195	18-4086	—	—	—	—	—	—
225	6	1985-87	3.500	18-4122	—	18-4112	18-4111	18-4102	18-4101	18-3904	18-3906	18-3905	18-1389
225	6	1988-93	3.685	18-4065	18-4066	—	—	18-4067	18-4068	18-3975	—	—	18-1389
235	6	1980-85	3.625	18-4123	18-4123	18-4113	18-4113	18-4103	18-4103	18-3907	—	18-3908	—
250/300	6	1990-93	3.685	18-4065	18-4066	—	—	18-4067	18-4068	18-3975	—	—	—
2500CC	6	1988	3.500	18-4120	18-4120	18-4110	18-4110	18-4100	18-4100	18-3904	18-3906	18-3905	—
250	6	1988-92	3.685	18-4065	18-4066	—	—	18-4067	18-4068	18-3975	—	—	—
275	8	1988-92	3.685	18-4065	18-4066	—	—	18-4067	18-4068	18-3975	—	—	—
275	8	1985-87	3.500	18-4122	—	18-4112	18-4111	18-4102	18-4101	18-3904	18-3906	18-3905	—
300	8	1988-92	3.685	18-4065	18-4066	—	—	18-4067	18-4068	18-3975	—	—	—
300/3.6L	8	1985-87	3.500	18-4122	—	18-4112	18-4111	18-4102	18-4101	18-3904	18-3906	18-3905	—

① Except 1991 60° V Models

60° Eagle Series

HP	Cyl.	Bore Size	Piston	OE No.	Piston Ring	OE No.
90-175	4 & 6	3.600 (port)	—	436242	18-4088	436353
90-175	4 & 6	3.600(starboard)	—	436243	18-4088	436353
90-175	4 & 6	3.620 (port)	—	N/A	—	N/A
90-175	4 & 6	3.620 (starboard)	—	N/A	—	N/A
90-175	4 & 6	3.630 (port)	—	439519	—	436354

OMC V-4/V-6 60° Eagle Series Pistons

H.P.	YEAR	CYL.	STD. BORE	STANDARD		.020"O.S.		.030"O.S.		STD. RINGS	
				(PORT)	(STBD)	(PORT)	(STBD)	(PORT)	(STBD)		
90-175	1991-2000	4 & 6	3.600		—			18-4058		—	18-4088

OMC SEA DRIVE PISTONS

H.P.	YEAR	CYL.	STD. BORE	STANDARD		.020"O.S.		.030"O.S.		STD. RINGS	.020" O.S. RINGS	.030" O.S. RINGS
				(PORT)	(STBD)	(PORT)	(STBD)	(PORT)	(STBD)			
1.6L	1983-89	4	3.500	18-4120	18-4120	18-4110	18-4110	18-4100	18-4100	18-3904	18-3906	18-3905
1.8L	1987	4	3.500	18-4122	—	18-4112	18-4111	18-4102	18-4101	18-3904	18-3906	18-3905
2.5L	1982, 1984-85	6	3.500	18-4120	18-4120	18-4110	18-4110	18-4100	18-4100	18-3904	18-3906	18-3905
2.6L	1982-86	6	3.625	18-4123	18-4123	18-4113	18-4113	18-4103	18-4103	18-3907	—	18-3908
2.7L	1987	6	3.500	18-4122	—	18-4112	18-4111	18-4102	18-4101	18-3904	18-3906	18-3905
3.6L	1987	8	3.500	18-4122	—	18-4112	18-4111	18-4102	18-4101	18-3904	—	18-3905

ORIGINAL EQUIPMENT MANUFACTURER RECOMMENDS THE REPLACEMENT OF ROD BOLTS WITH EVERY POWER HEAD REBUILD.



ROD BOLTS

Part #	OE#	Application
18-4075	308186	For V-4 & V-6 Crossflow engines
18-4075-9①②	308186	For V-4 & V-6 Crossflow engines
18-4076	330081	For V-4 Looper engines



18-1752 CONNECTING ROD

Replaces: 394462
For: 40HP (1999-01), 50HP (1995-98), 60HP (1989-01), 70HP (1986-01)



18-1753 CONNECTING ROD

Replaces: 395861
For: 30HP (1999-01), 40 HP (1985-02), 45HP (1986-87, 1990-97), 48HP (1987-96), 50HP (1985-02), 55HP (1985-93, 1999-01), 60 HP (1985)



18-4148-1 CONNECTING ROD

Replaces: 394488, 5004705
For V-4 Looper engines and some V-6 applications



SLEEVE

Part No.	I.D.	O.D.	Wall	Length	Description
18-4712	3.1875	3.453	0.125	5.556	Replacement straight sleeve with ports cut in



18-1352 CENTER MAIN BEARING

Replaces: 378252



18-1353 CENTER MAIN BEARING

Replaces: 387041



18-1360 ROD BEARING

Replaces: 396041

APPLICATION BEGINS ON NEXT PAGE

① Priced per Package ② Package of 12



**18-1361
ROD CRANK END
BEARING**
Replaces: 387787



**18-1296
WRIST PIN BEARING**
Replaces:
386014
For: 9.9-15 HP



**18-1374
WRIST PIN
BEARING**
Replaces: 395627



**18-1376
WRIST PIN BEARING**
Replaces: 434844



**18-1377
CENTER MAIN
BEARING**
Replaces: 320499



**18-1378
ROD BEARING**
Replaces: 388344



**18-4040
NEEDLE BEARINGS
(18 Needles)**
Replaces: 387142, 387139
(Crank End)
(Must re-use cage)



POWERHEAD BEARING KITS

Part #	Part #
18-1386	18-1389

POWERHEAD BEARINGS

Part #	Replaces:	Description
18-1391	330854	Lower Crankshaft Bearing
18-1393	393896	Upper Crankshaft Bearing
18-1395	385503	Lower Crankshaft Bearing
18-1396	390641	Lower Crankshaft Bearing

H.P.	Year	Sleeve	Connecting Rod	Rod Bolt	Wrist Pin Brg.	Rod Brg. Complete	Rod Brgs. Only	Center Main Brg.	Split bearing [sleeve]	Upper Crank Brg.	Lower Crank Brg.	Powerhead Brg. Kit
2 CYLINDER												
9.9	1974-83	-	-	-	-	-	-	-	-	-	-	-
9.9	1974-83	-	-	-	-	-	-	-	-	-	-	-
9.9	1974-80	-	-	-	-	-	-	-	-	-	-	-
9.9	1981-83	-	-	-	-	-	-	-	-	-	-	-
9.9	1986-92	-	-	-	-	-	-	-	-	-	-	-
9.9	1984-97	-	-	-	-	-	-	-	-	-	-	-
9.9	1998	-	-	-	-	-	-	-	-	-	-	-
14 Comm	1988-89	-	-	-	-	-	-	-	-	-	-	-
15	1974-83	-	-	-	-	-	-	-	-	-	-	-
15	1984-97	-	-	-	-	-	-	-	-	-	-	-
15 Comm	1994	-	-	-	18-1296	-	-	-	-	-	-	-
18	1960-68	-	-	-	-	-	18-4040	-	-	-	-	-
18	1970-73	-	-	-	18-1375	-	18-4040	-	-	-	-	-
18 Jet	1996-97	-	-	-	18-1374	18-1378	-	18-1394	-	18-1393	18-1391	-
20	1981-84	-	-	-	18-1374	18-1378	18-4040	18-1394	-	-	18-1391	-
20	1985-97	-	-	-	18-1374	18-1378	-	18-1394	-	18-1393	18-1391	-

APPLICATION CONTINUED ON NEXT PAGE

H.P.	Year	Sleeve	Connecting Rod	Rod Bolt	Wrist Pin Brg.	Rod Brg. Complete	Rod Brgs. Only	Center Main Brg.	Split bearing [sleeve]	Upper Crank Brg.	Lower Crank Brg.	Powerhead Brg. Kit
25	1970-76	-	-	-	18-1375	-	18-4040	-	-	-	-	-
25	1977	-	-	-	18-1375	18-1378	18-4040	-	-	-	18-1391	-
25	1978-80	-	-	18-4075	18-1375	18-1378	18-4040	18-1394	-	-	18-1391	-
25	1981-84	-	-	-	18-1374	18-1378	18-4040	18-1394	-	18-1391	18-1391	-
25 ①	1985-97	-	-	-	-	-	-	18-1394	-	18-1393	18-1391	-
25	1985-97	-	-	18-4075	18-1374	18-1378	-	-	-	-	-	-
25 Comm	1982-84	-	-	-	18-1374	18-1378	18-4040	18-1394	-	-	18-1391	-
25 Comm	1985-97	-	-	-	18-1374	18-1378	-	18-1394	-	18-1393	18-1391	-
28	1987-97	-	-	-	18-1374	18-1378	-	18-1394	-	18-1393	18-1391	-
30	1981-93	-	-	18-4075	18-1374	18-1378	18-4040	-	-	-	-	-
30	1984-1992	-	-	18-4075	-	18-1378	18-4040	18-1394	-	-	-	-
30	1985-97	-	-	-	18-1374	18-1378	18-4040	18-1394	-	18-1393	18-1391	-
30	1984	-	-	-	-	18-1378	18-4040	18-1394	-	-	18-1391	-
33	1965-69	-	-	-	-	18-1378	18-4040	-	-	-	-	-
33	1970	-	-	-	18-1375	18-1378	18-4040	-	-	-	-	-
35	1976-80	-	-	-	18-1375	18-1378	18-4040	-	-	-	18-1391	-
35	1981-84	-	-	18-4075	18-1374	-	18-4040	18-1394	-	-	18-1391	-
35	1985-97	-	-	-	18-1374	18-1378	-	18-1394	-	18-1393	18-1391	-
35	1976-1993	-	-	18-4075	18-1374	18-1378	-	-	-	-	-	-
35	1977	-	-	18-4075	-	-	-	-	-	-	-	-
35	1978-1980	-	-	18-4075	18-1375	18-1378	18-4040	18-1394	-	-	18-1391	-
35	1981-1993	-	-	18-4075	18-1374	18-1378	-	18-1394	18-1362	18-1393	18-1391	-
40	1984-92	18-4712	-	18-4075	18-1374	18-1378	-	18-1352	18-1362	-	18-1391	-
40	1961-70	-	-	-	-	-	18-4040	-	-	-	-	-
40	1971-73	-	-	-	18-1375	18-1378	18-4040	-	-	-	-	-
40	1974-76	-	-	-	18-1375	18-1378	18-4040	18-1352	18-1362	-	18-1154	-
40	1984-86	-	-	-	18-1374	18-1378	-	18-1352	18-1362	18-1372	18-1154	-
40	1987-97	-	-	-	18-1374	18-1378	-	18-1352	18-1362	-	18-1154	18-1389
40	1983	-	-	18-4075	18-1375	-	-	18-1352	18-1362	-	18-1154	-
40 Comm	1982-83	-	-	-	18-1375	18-1378	-	18-1352	18-1362	-	-	-
40 Comm	1984-85	-	-	-	18-1375	18-1378	-	18-1352	18-1362	18-1372	-	-
40 Comm	1989-90	-	-	-	18-1375	18-1378	-	18-1352	18-1362	-	-	-
40 Comm	1994	-	-	-	18-1374	18-1378	-	18-1352	18-1362	-	-	-
40 Comm	1995-97	-	-	-	18-1374	-	-	18-1352	18-1362	-	-	-
45 Comm	1985-86	-	-	-	18-1374	18-1378	-	18-1352	18-1362	18-1372	-	-
45 Comm	1987-94	-	-	-	18-1374	18-1378	-	18-1352	18-1362	18-1372	-	-
45 Comm	1995-97	-	-	-	18-1374	-	-	18-1352	18-1362	-	-	-
45 Comm	1987	-	-	-	18-1374	18-1378	-	18-1352	18-1362	-	18-1154	-
45ss	1987-90	-	-	-	18-1374	18-1378	-	18-1352	18-1362	18-1372	-	-
48	1987	18-4712	-	-	18-1374	18-1378	-	18-1352	18-1362	18-1372	-	-
48	1987-92	18-4712	-	18-4075	18-1374	18-1378	-	18-1352	18-1362	-	-	-
48	1988-96	-	-	-	18-1374	18-1378	-	18-1352	18-1362	-	-	-
50	1979-83	18-4712	-	18-4075	18-1374	18-1378	18-4040	18-1352	18-1362	18-1372	-	-
50	1979-86	-	-	-	18-1374	18-1378	-	18-1352	18-1362	18-1372	-	-
50	1981-93	18-4712	-	18-4075	18-1374	18-1378	-	18-1352	18-1362	-	-	-
50②	1987-97	-	-	-	18-1374	18-1378	-	18-1352	18-1362	-	-	-
50③	1995-97	-	-	-	18-1374	18-1378	-	18-1352	18-1362	-	-	-
55	1968-69	-	-	-	18-1375	18-1378	18-4040	18-1352	18-1362	-	-	-
55	1976-81	-	-	-	18-1374	18-1378	18-4040	18-1352	18-1362	18-1372	-	-
55 Comm	1982	-	-	-	18-1374	18-1378	18-4040	18-1352	18-1362	18-1372	-	-
55 Comm	1983-86	-	-	-	18-1374	18-1378	-	18-1352	18-1362	18-1372	-	-
55 Comm	1987-94	-	-	-	18-1374	18-1378	-	18-1352	18-1362	-	-	-
55 Comm	1995-97	-	-	-	18-1374	18-1378	-	18-1352	18-1362	-	-	-
55	1978-93	18-4712	-	18-4075	-	-	-	-	-	-	-	-
60	1980-85	18-4712	-	18-4075	18-1374	18-1378	-	18-1352	18-1362	18-1372	-	-
60	1964-67,70-71	-	-	-	18-1375	18-1378	18-4040	18-1352	18-1362	-	-	-
60	86-90	-	-	-	18-1374	18-1378	-	18-1352	18-1362	18-1372	-	-
60	1991-93	-	-	-	18-1374	18-1378	-	18-1352	18-1362	-	-	-
60	1994-97	-	-	-	18-1374	-	-	18-1352	18-1362	-	-	-
SST-60	1989-90	-	-	-	18-1374	18-1378	-	18-1352	18-1362	18-1372	-	-
3 CYLINDER												
60	1985	-	-	18-4075	18-1374	18-1378	18-4040	18-1352	18-1362	18-1372	-	-
60	1986-90	-	-	-	18-1374	18-1378	18-4040	18-1352	18-1362	18-1372	-	-
60	1986-88	-	-	18-4075	18-1374	18-1378	18-4040	18-1352	18-1362	18-1372	-	-
60	1989-92	-	-	18-4075	18-1374	18-1378	18-4040	18-1352	18-1362	-	-	-
65	1968	-	-	-	18-1375	18-1378	18-4040	18-1352	18-1362	-	-	-
65	1972-73	-	-	-	18-1375	18-1378	18-4040	18-1352	18-1362	18-1372	-	-
65 Comm	1984	-	-	-	18-1374	18-1378	18-4040	18-1352	18-1362	18-1372	-	-
65 Comm	1985-90	-	-	-	18-1374	18-1378	18-4040	18-1352	18-1362	18-1372	-	-
65 Comm	1991-93	-	-	-	18-1374	18-1378	18-4040	18-1352	18-1362	-	-	-
65 Comm.	1994-97	-	-	-	18-1374	18-1378	18-4040	18-1352	18-1362	-	-	-
65	1984-86	-	-	18-4075	18-1374	18-1378	18-4040	18-1352	18-1362	18-1372	18-1154	-
70	1976-85	-	-	18-4075	18-1374	18-1378	18-4040	18-1352	18-1362	18-1372	18-1154	-
70	1974-75	-	-	-	18-1375	18-1378	18-4040	18-1352	18-1362	18-1372	-	-
70	1976-90	-	-	-	18-1374	18-1378	18-4040	18-1352	18-1362	18-1372	18-1154	-

① Except "D" Models ③ Three Cylinder Models ⑤ 60 Degree Models
 ② Two Cylinder Models ④ 90 Degree Models ⑥ V-4, V-6 & V-8 Model engines do not include upper bearings in kits

APPLICATION CONTINUED ON NEXT PAGE

H.P.	Year	Sleeve	Connecting Rod	Rod Bolt	Wrist Pin Brg.	Rod Brg. Complete	Rod Brgs. Only	Center Main Brg.	Split bearing [sleeve]	Upper Crank Brg.	Lower Crank Brg.	Powerhead Brg. Kit
70	1976-84	-	-	18-4075	18-1374	18-1378	18-4040	18-1352	18-1362	18-1372	18-1154	-
70	1985-90	-	-	-	18-1374	18-1378	18-4040	18-1352	18-1362	18-1372	18-1154	-
70	1991-93	-	-	-	18-1374	18-1378	18-4040	18-1352	18-1362	-	-	-
70	1994-97	-	-	-	18-1374	-	-	18-1352	18-1362	-	-	-
75	1960-65	-	-	-	18-1375	18-1378	18-4040	18-1352	18-1362	-	-	-
75	1975	-	-	-	18-1375	18-1378	18-4040	18-1352	18-1362	18-1372	18-1154	-
75	1976-84	-	-	18-4075	18-1374	18-1378	18-4040	18-1352	18-1362	18-1372	18-1154	-
75	1982-88	-	-	18-4075	18-1374	18-1378	18-4040	18-1352	18-1362	18-1372	18-1154	-
75	1985-88	-	-	-	18-1374	18-1378	18-4040	18-1352	18-1362	18-1372	18-1154	-
75 ⑥	1976-88	-	-	18-4075	18-1374	18-1378	18-4040	18-1352	18-1362	18-1372	18-1154	-
V-4 CROSSFLOW												
65JET	1992-95	-	-	18-4075	18-1374	18-1361	18-4040	18-1353	18-1377	-	18-1395	18-1386
80	1966- 67	-	-	-	18-1375	18-1378	18-4040	18-1352	18-1362	-	-	-
80JET	1993-97	-	-	18-4075	18-1374	18-1361	18-4040	18-1353	18-1377	-	18-1395	18-1386
80JET	1992-97	-	-	-	18-1374	18-1361	18-4040	18-1353	18-1377	-	18-1395	18-1386
85	1968-72	-	-	-	18-1375	18-1378	18-4040	18-1352	18-1362	-	18-1154	-
85	1973	-	-	-	18-1374	18-1378	18-4040	18-1352	18-1362	-	18-1395	-
85	1974-78	-	-	-	18-1374	18-1361	18-4040	18-1352	18-1362	-	18-1395	-
85 ⑥	1979-80	-	-	18-4075	18-1374	18-1361	18-4040	18-1353	18-1377	-	18-1395	18-1386
85 ⑥	1991-95	-	-	-	18-1374	18-1361	18-4040	18-1353	18-1377	-	18-1395	18-1386
85	1979-80,92	-	-	18-4075	18-1374	18-1361	18-4040	18-1353	18-1377	-	18-1395	18-1386
85TTL	1992-95	-	-	18-4075	18-1374	18-1361	18-4040	18-1353	18-1377	-	18-1395	18-1386
88	1987-91	-	-	18-4075	18-1374	18-1361	18-4040	18-1353	18-1377	-	18-1395	18-1386
88 ⑥	1987-96	-	-	18-4075	18-1374	18-1361	18-4040	18-1353	18-1377	-	18-1395	18-1386
88	1987-92	-	-	18-4075	18-1374	18-1361	18-4040	18-1353	18-1377	-	18-1395	18-1386
88	1993	-	-	18-4075	18-1374	18-1361	18-4040	18-1353	18-1377	-	18-1395	18-1386
88	1992-96	-	-	18-4075	18-1374	18-1361	18-4040	18-1353	18-1377	-	18-1395	18-1386
90	1981-86	-	-	18-4075	18-1374	18-1361	18-4040	18-1353	18-1377	-	18-1395	18-1386
90	1986-91	-	-	18-4075	18-1374	18-1361	18-4040	18-1353	18-1377	-	18-1395	18-1386
90	1992-94	-	-	18-4075	18-1374	18-1361	18-4040	18-1353	18-1377	-	18-1395	18-1386
90 ⑥ ④	1981-97	-	-	18-4075	18-1374	18-1361	18-4040	18-1353	18-1377	-	18-1395	18-1386
90 ④	1981-97	-	-	18-4075	18-1374	18-1361	18-4040	18-1353	18-1377	-	18-1395	18-1386
90 ⑤	1995-97	-	-	18-4075	18-1374	18-1361	18-4040	18-1353	18-1377	-	18-1395	18-1386
90JET ⑥	1994-95	-	-	18-4075	18-1374	18-1361	18-4040	18-1353	18-1377	-	18-1395	18-1386
90	1981-92	-	-	18-4075	18-1374	18-1361	18-4040	18-1353	18-1377	-	18-1395	18-1386
90	1993	-	-	18-4075	18-1374	18-1361	18-4040	18-1353	18-1377	-	18-1395	18-1386
100	1966- 68	-	-	-	18-1375	18-1378	18-4040	18-1352	18-1362	-	18-1154	-
100	1971- 72	-	-	-	18-1375	18-1378	18-4040	18-1352	18-1362	-	18-1154	-
100 ⑥	1979-80	-	-	18-4075	18-1374	18-1361	18-4040	18-1353	18-1377	-	18-1395	18-1386
100	1984-85	-	-	18-4075	18-1374	18-1361	18-4040	18-1353	18-1377	-	18-1395	18-1386
100	1986-91	-	-	18-4075	18-1374	18-1361	18-4040	18-1353	18-1377	-	18-1395	18-1386
100 ⑥	1990-94	-	-	18-4075	18-1374	18-1361	18-4040	18-1353	18-1377	-	18-1395	18-1386
100 Comm ⑥	1984-97	-	-	18-4075	18-1374	18-1361	18-4040	18-1353	18-1377	-	18-1395	18-1386
100	1979-81,92	-	-	18-4075	18-1374	18-1361	18-4040	18-1353	18-1377	-	18-1395	18-1386
100	1992-97	-	-	18-4075	18-1374	18-1361	18-4040	18-1353	18-1377	-	18-1395	18-1386
100	1993	-	-	18-4075	18-1374	18-1361	18-4040	18-1353	18-1377	-	18-1395	18-1386
100 Comm	1984-87,89-92	-	-	18-4075	18-1374	18-1361	18-4040	18-1353	18-1377	-	18-1395	18-1386
100 Comm.	1993	-	-	18-4075	18-1374	18-1361	18-4040	18-1353	18-1377	-	18-1395	18-1386
110 ⑥	1986-89	-	-	18-4075	18-1374	18-1361	18-4040	18-1353	18-1377	-	18-1395	18-1386
112 ⑥	1994- 96	-	-	-	18-1374	18-1361	18-4040	18-1353	18-1377	-	18-1395	18-1386
115	1969-70	-	-	-	18-1375	18-1378	18-4040	18-1352	18-1362	-	18-1154	-
115	1973	-	-	18-4075	18-1374	18-1378	18-4040	18-1352	18-1362	-	18-1395	-
115	1974-78	-	-	18-4075	18-1374	18-1361	18-4040	18-1352	18-1362	-	18-1395	-
115 ⑥ ④	1990-97	-	-	-	18-1374	18-1361	18-4040	18-1353	18-1377	-	18-1395	18-1386
115 ⑥	1979-85	-	-	18-4075	18-1374	18-1361	18-4040	18-1353	18-1377	-	18-1395	18-1386
115	1991-92	-	-	18-4075	18-1374	18-1361	18-4040	18-1353	18-1377	-	18-1395	18-1386
115	1990-91	-	-	18-4075	18-1374	18-1361	18-4040	18-1353	18-1377	-	18-1395	18-1386
115	1993	-	-	18-4075	18-1374	18-1361	18-4040	18-1353	18-1377	-	18-1395	18-1386
115	1992-94	-	-	18-4075	18-1374	18-1361	18-4040	18-1353	18-1377	-	18-1395	18-1386
115 ④	1990-97	-	-	-	18-1374	18-1361	18-4040	18-1353	18-1377	-	-	-
115 ⑤	1995-97	-	-	-	-	18-1361	18-4040	18-1353	18-1377	-	-	-
115JET ⑥	1994-97	-	-	-	18-1374	18-1361	18-4040	18-1353	18-1377	-	18-1395	18-1386
115C	1984	-	-	18-4075	18-1374	18-1361	18-4040	18-1353	18-1377	-	18-1395	18-1386
120 ⑥	1985-94	-	-	-	18-1376	18-1360	-	18-1353	18-1377	-	18-1396	-
125	1971-72	-	-	-	18-1375	18-1378	18-4040	18-1352	18-1362	-	-	-
125 Comm ⑥	1989-95	-	-	-	18-1376	18-1360	-	18-1353	18-1377	-	18-1396	-
125Esx ⑥	1991-94	-	-	-	18-1376	18-1360	-	18-1353	18-1377	-	18-1396	-
130 ⑥	1994-97	-	-	-	18-1376	18-1360	-	18-1353	18-1377	-	18-1396	-
135	1973	-	-	-	18-1374	18-1378	18-4040	18-1352	18-1362	-	18-1395	-
135	1974-76	-	-	18-4075	18-1374	18-1361	18-4040	18-1352	18-1362	-	18-1395	-
140	1977-78	-	-	18-4075	18-1374	18-1361	18-4040	18-1352	18-1362	-	18-1395	-
140	1979	-	-	18-4075	-	-	-	-	-	-	-	-
140 ⑥	1979-84	-	-	-	18-1374	18-1361	18-4040	18-1353	18-1377	-	18-1395	18-1386
140 ⑥	1985-94	-	-	-	18-1376	18-1360	-	18-1353	18-1377	-	18-1396	-
140	1977-84	-	-	18-4075	18-1374	18-1361	18-4040	18-1353	18-1377	-	18-1395	18-1386

① Except "D" Models
② Two Cylinder Models





③ Three Cylinder Models
④ 90 Degree Models

⑤ 60 Degree Models
⑥ V-4, V-6 & V-8 Model engines do not include upper bearings in kits

APPLICATION CONTINUED ON NEXT PAGE

H.P.	Year	Sleeve	Connecting Rod	Rod Bolt	Wrist Pin Brg.	Rod Brg. Complete	Rod Brgs. Only	Center Main Brg.	Split bearing [sleeve]	Upper Crank Brg.	Lower Crank Brg.	Powerhead Brg. Kit
1600CC	1988	-	-	18-4075	-	-	-	-	-	-	-	-
1.6L	-	-	-	18-4075	-	-	-	-	-	-	-	-
V-6 CROSSFLOW												
150 ⑥	1978-91	-	-	-	18-1374	18-1361	18-4040	18-1353	18-1377	-	18-1395	-
150 ⑤	1991-97	-	-	-	-	18-1361	18-4040	18-1353	-	-	-	-
150 Comm ⑤	1993-95	-	-	-	-	18-1361	18-4040	18-1353	-	-	-	-
150	1978-85	-	-	18-4075	18-1374	18-1361	18-4040	18-1353	18-1377	-	18-1395	-
150	1978-88	-	-	18-4075	18-1374	18-1361	18-4040	18-1353	18-1377	-	18-1395	-
150	1986-91	-	-	18-4075	18-1374	18-1361	18-4040	18-1353	18-1377	-	-	-
150	1989-91	-	-	18-4075	18-1374	18-1361	18-4040	18-1353	18-1377	-	-	-
155 Comm	1984-85	-	-	18-4075	18-1374	18-1361	18-4040	18-1353	18-1377	-	18-1395	-
155 Comm ⑥	1984-92	-	-	-	18-1374	18-1361	18-4040	18-1353	18-1377	-	18-1395	-
155 Comm	1986-91	-	-	18-4075	-	-	-	-	-	-	-	-
175 ⑥	1977-91	-	-	-	18-1374	18-1361	18-4040	18-1353	18-1377	-	18-1395	-
175 ⑤	1991-97	-	-	-	-	18-1361	18-4040	18-1353	-	-	-	-
175	1977-83	-	-	18-4075	18-1374	18-1361	18-4040	18-1353	18-1377	-	-	-
175	1986-90	-	-	18-4075	18-1374	18-1361	18-4040	18-1353	18-1377	-	-	-
175	1977-83,85	-	-	18-4075	18-1374	18-1361	18-4040	18-1353	18-1377	-	-	-
185 ⑥	1984-85	-	-	18-4075	18-1374	18-1361	18-4040	18-1353	18-1377	-	18-1395	18-1389
185	1990	-	18-4148-1	18-4076	-	-	-	-	-	-	-	-
185 ⑥	1990-94	-	-	-	18-1376	18-1360	-	18-1353	18-1377	-	18-1396	18-1389
185	1990-93	-	18-4148-1	18-4076	-	-	-	-	-	-	-	-
185	1992-94	-	18-4148-1	18-4076	-	-	-	-	-	-	-	-
200 ⑥	1976-83	-	-	18-4075	18-1374	18-1361	18-4040	18-1353	18-1377	-	18-1395	18-1389
200	1986-97	-	-	-	18-1376	18-1360	-	18-1353	18-1377	-	18-1396	-
200 Comm	1990	-	18-4148-1	18-4076	-	-	-	-	-	-	18-1396	-
200 Comm	1990-94	-	-	-	18-1376	18-1360	-	18-1353	18-1377	-	-	-
200	1976-83	-	-	18-4075	18-1374	18-1361	18-4040	18-1353	18-1377	-	18-1395	-
200C	1990	-	-	18-4076	18-1376	18-1360	-	18-1353	18-1377	-	18-1396	-
200	1986-91	-	-	18-4076	-	-	-	-	-	-	-	-
200	1986-93	-	-	18-4076	-	-	-	-	-	-	-	-
225 ⑥	1986-97	-	-	-	18-1376	18-1360	-	18-1353	18-1377	-	18-1396	18-1389
235 ⑥	1978-85	-	-	18-4075	18-1374	18-1361	18-4040	18-1353	18-1377	-	18-1395	-
235	1978-79	-	-	18-4075	18-1374	18-1361	18-4040	18-1353	18-1377	-	-	-
235	1980-85	18-4718	-	18-4075	18-1374	18-1361	18-4040	18-1353	18-1377	-	-	-
250	1991-95	-	-	-	18-1376	18-1360	-	18-1353	18-1377	-	18-1396	-
250	1997	-	-	-	18-1376	18-1360	-	18-1353	18-1377	-	18-1396	-
275	1985-88	-	-	-	18-1376	18-1360	-	18-1353	18-1377	-	18-1396	-
3.6L	1985-87	-	-	-	18-1376	18-1360	-	18-1353	18-1377	-	18-1396	-
300	1988-95	-	-	-	18-1376	18-1360	-	18-1353	18-1377	-	18-1396	-
2500CC	1988	-	-	-	-	-	-	-	-	-	-	-
2.5L	1982,84-85	-	-	-	-	-	-	-	-	-	-	-
2.6L	1982-86	18-4718	-	-	-	-	-	-	-	-	-	-
V-4 LOOPER												
120	1985	-	-	18-4076	18-1376	18-1360	-	18-1353	18-1377	-	18-1396	-
120	1985-94	-	-	18-4076	18-1376	18-1360	-	18-1353	18-1377	-	18-1396	-
125	1985-94	-	-	18-4076	18-1376	18-1360	-	18-1353	18-1377	-	18-1396	-
140	1985-94	-	-	18-4076	18-1376	18-1360	-	18-1353	18-1377	-	18-1396	-
1.8L	ALL	-	-	18-4076	-	-	-	-	-	-	-	-
V-6 LOOPER												
225	1986-91	-	-	18-4076	18-1376	18-1360	-	18-1353	18-1377	-	18-1396	-
225	1986-93	-	-	18-4076	18-1376	18-1360	-	18-1353	18-1377	-	18-1396	-
2.7L	1987	-	-	18-4076	-	-	-	-	-	-	-	-
275	1985-88	-	-	18-4076	18-1376	18-1360	-	18-1353	18-1377	-	18-1396	-
300	1985-95	-	-	18-4076	18-1376	18-1360	-	18-1353	18-1377	-	18-1396	-

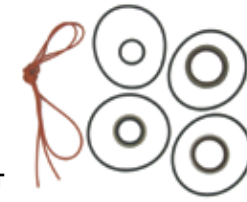
- ① Except "D" Models ③ Three Cylinder Models ⑤ 60 Degree Models
- ② Two Cylinder Models ④ 90 Degree Models ⑥ V-4, V-6 & V-8 Model engines do not include upper bearings in kits

<p>18-4329 CRANKSHAFT SEAL KIT For: 20-35 HP</p>  <table border="1" style="width: 100%; border-collapse: collapse; margin-top: 10px;"> <thead> <tr> <th>HP</th> <th>Years</th> <th>HP</th> <th>Years</th> </tr> </thead> <tbody> <tr> <td>20</td> <td>1981-89</td> <td>30</td> <td>1984-89</td> </tr> <tr> <td>25</td> <td>1977-89</td> <td>35</td> <td>1976-89</td> </tr> <tr> <td>28</td> <td>1986-88</td> <td></td> <td></td> </tr> </tbody> </table>	HP	Years	HP	Years	20	1981-89	30	1984-89	25	1977-89	35	1976-89	28	1986-88			<p>18-4330 CRANKSHAFT SEAL KIT For: 40-75 HP</p> 	<p>18-4331 CRANKSHAFT SEAL KIT For: Crossflow V-4 - V-6</p> 
HP	Years	HP	Years															
20	1981-89	30	1984-89															
25	1977-89	35	1976-89															
28	1986-88																	
<p>18-4332 CRANKSHAFT SEAL KIT For: 9.9 - 15 HP</p> 	<p>18-8355 CRANKSHAFT SEAL KIT For:</p> <table border="1" style="width: 100%; border-collapse: collapse; margin-top: 10px;"> <thead> <tr> <th>Year</th> <th>Model/HP</th> </tr> </thead> <tbody> <tr> <td>1990</td> <td>20-30AC, TE, E/ 20-35R/25COMM.</td> </tr> <tr> <td>1991-92</td> <td>25/28/32R, TE, RE</td> </tr> </tbody> </table>	Year	Model/HP	1990	20-30AC, TE, E/ 20-35R/25COMM.	1991-92	25/28/32R, TE, RE	<p>18-1286 UPPER CRANKSHAFT SEAL Replaces: 336232 For: 60° & EFI 90-115HP & 150-175HP</p> 										
Year	Model/HP																	
1990	20-30AC, TE, E/ 20-35R/25COMM.																	
1991-92	25/28/32R, TE, RE																	



***18-7895**
OIL FILTER
Replaces: 778888, 5035703
200/225 (2004-05)



***18-7896**
OIL FILTER
Replaces: 778886, 5033539
90-115 EFI (2003-05)



***18-7897**
OIL FILTER
Replaces: 778887, 5033919
140 EFI (2003-05)



18-7903
OIL FILTER
Replaces: 5033102, 763364
9.9-15HP (2002-07)



***18-7915-1**
OIL FILTER
Replaces: 778885, 5031411
25-70 HP (1998-2005)



***18-7916**
OIL FILTER
Replaces: 434839
9.9 & 15 HP models from (1995-2001)
OMC Built



18-70936
HOSE (CYLINDER HEAD, STARBOARD)
Replace: 340975
Fits: 90 (1994-95), 100 (1996-97), 115 (1994-97), E88 (1996), E90 (1996-98), E100 (1996-97), E112 (1996), E115 (1996-98), J88 (1996), J90 (1996-98), J100 (1997-98), J112 (1996), J115 (1996-98)



18-70937
HOSE (CYLINDER HEAD, PORT)
Replaces: 340976
Fits: 90 (1994-95), 100 (1996-97), 115 (1994-97), E88 (1996), E90 (1996-98), E100 (1996-97), E112 (1996), E115 (1996-98), J88 (1996), J90 (1996-98), J100 (1997-98), J112 (1996), J115 (1996-98)

SEE PAGES 166-167 FOR OUR COMPLETE LINE OF GASKET SEALANTS

— CONTAINS —

Part #	Desc.	O.E. #	Qty.
18-0933	Air Silencer Gasket	314115	1
18-0935	Base To Cover Gasket	314322	1
18-0951	Carburetor to Manifold Gasket	317305	1
18-2543	Water Jacket Gasket	318609	1
18-0118	Carburetor Gasket	325092	3
18-2913	Exhaust Cover Gasket	318609	2
18-2938	Exhaust Cover Gasket	331917	1
18-2548	Thermostat Gasket	332108	1
18-2865	Adapter to Powerhead Gasket	313763	1
18-0929	Thermostat Gasket	313416	1



18-4300
POWERHEAD GASKET SET
Replaces: 385416

— CONTAINS —

Part #	Desc.	O.E. #	Qty.
18-2876	By-Pass Cover Gasket	307133	4
18-2866	Exhaust Cover Gasket	317914	2
18-0953	Water Pass. Gasket	317951	1
18-0117	Exhaust Plate Gasket	317995	1
18-0955	Exhaust Cover Gasket	318156	1
18-2873	Cyl. Cover Starboard Gasket	318335	2
18-0957	Adapter To Powerhead Gasket	318373	1
18-2867	Manifold to Crankcase Gasket	319174	1
18-2864	Adapter to Powerhead Gasket	321727	1
18-0991	Leaf Plate Gasket	321907	4
18-0134	Carburetor to Manifold Gasket	327707	2
18-2857	Air Silencer	386573,	
	To Carburetor Gasket	319771	2

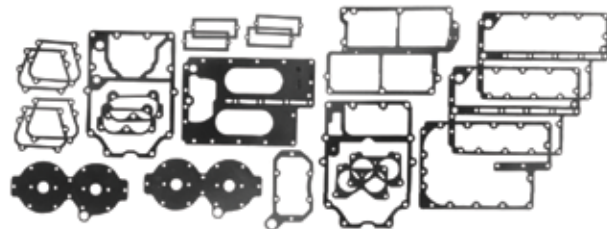

18-4301
POWERHEAD GASKET SET
Replaces: 388602

APPLICATIONS BEGIN ON PAGE 256

* Anti-Drain-Back Valve
Valve eliminates dry starts, prevents oil from draining back into crankcase during engine shutdown.

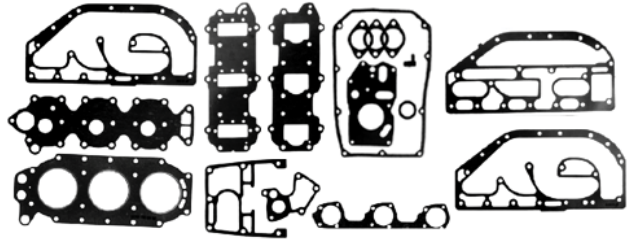

18-4302
POWERHEAD GASKET SET
 Replaces: 390078

— CONTAINS —

Part #	Desc.	O.E. #	Qty.
18-2960	Head Gasket	313413	1
18-2865	Adapter to Powerhead Gasket	313763	1
18-0951	Carb to Manifold Gasket	317305	1
18-2543	Water Jacket Gasket	318609	1
18-0989	Air Silencer Gasket	321794	1
18-0118	Carburetor Gasket	325092	3
18-0102	Exhaust Manifold Gasket	323469	1
18-2913	Exhaust Cover Gasket	331916	2
18-2938	Exhaust Cover Gasket	331917	1
18-2548	Thermostat Cover Gasket	332108	1
18-0975	Carb to Silencer Gasket	333008	1

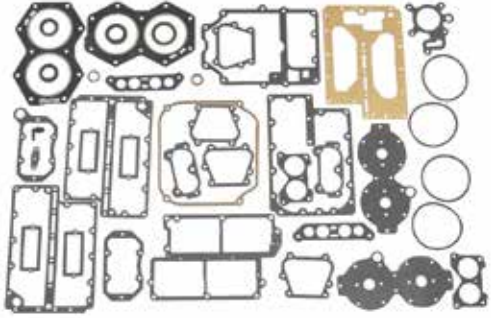

18-4303-1
POWERHEAD GASKET SET
 Replaces: 389556, 391300

— CONTAINS —

Part #	Desc.	O.E. #	Qty.
18-0850	Fuel Pump Mtg Gasket	303615	1
18-2876	By-Pass Cover Gasket	307133	4
18-2866	Exhaust Cover Gasket	317914	2
18-0953	Water Passage Gasket	317951	1
18-0117	Exhaust Plate Gasket	317995	1
18-2873	Gasket	318335	2
18-2956	Water Jacket Head Gasket	318358	2
18-2867	Manifold to Crankcase Gasket	319174	1
18-2857	Air Silencer to Carb. Gasket	386573, 319771	2
18-0985	Air Silencer Gasket	321722	1
18-2864	Adapter to Powerhead Gasket	321727	1
18-0991	Leaf Plate Gasket	321907	4
18-2547	Water Pass. Cover Gasket	322858	1
18-0102	Exhaust Manifold Gasket	323469	1
18-0134	Intake Plate Gasket	326926	1
18-0977	Thermostat Gasket	332369	2

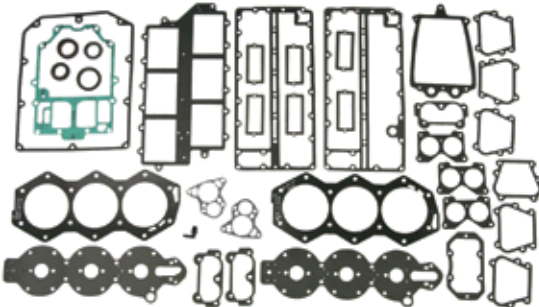

18-4304-1
POWERHEAD GASKET SET
 Replaces: 391988

— CONTAINS —

Part #	Desc.	O.E. #	Qty.
18-2549	Exhaust Plate Gasket	321543	1
18-2876	By-Pass Cover Gasket	307133	6
18-2544	Water Jacket Cover Gasket	321028	2
18-2545	Exhaust Plate Gasket	321182	1
18-0979	Air Silencer Gasket	321183	1
18-2546	Thermostat Gasket	321184	2
18-0991	Leaf Plate Gasket	321907	6
18-2547	Water Passage Cover Gasket	322858	1
18-0995	Adapter to Powerhead Gasket	323222	1
18-0134	Carburetor To Manifold Gasket	327707	3
18-0148	Intake Manifold Gasket	329718	1
18-2964	Head Gasket	320745, 335360	2
18-2550	Powerhead Gasket	323214	1
18-2857	Air Silencer To Carburetor Gasket	386573, 319771	1
18-2001	Oil Seal	330137	1
18-2074	Oil Seal	322575	2
18-8307	Oil Seal	331103	1



18-4305
POWERHEAD GASKET SET
 Replaces: 393433
 For: 2 cylinder models only

— CONTAINS —

Part #	Desc.	O.E. #	Qty.
18-0851	Relief Port Twin Gasket	329826	1
18-0850	Fuel Pump Mtg. Gasket	303615	1
18-0941	Water Jacket Cover Gasket	315538	1
18-0118	Carburetor Gasket	325092	2
18-0120	Exhaust Cover Gasket	325211	1
18-0128	Powerhead Mtg. Twin Gasket	326468	1
18-3802	Head Gasket	327795, 335359	1
18-0136	Powerhead Mounting Gasket	328283	1
18-0157	Airbox Split Twin Gasket	330698	1
18-0154	Airbox Split Twin Gasket	—	1
18-0159	Airbox Split Twin Gasket	330909	1
18-0983	Carb. to Air Box Twin Gasket	321497	1
18-0182	Thermostat Gasket	310058	1
18-0963	Intake Manifold Twin Gasket	335633	1

— CONTAINS —

Part #	Desc.	O.E. #	Qty.
18-0850	Fuel Pump Mtg. Gasket	303615	1
18-0122	Outer Leaf Plate Gasket	325260	1
18-0961	Carburetor to Intake Manifold Gasket	318932	1
18-0967	By-Pass Cover Gasket	319332	1
18-0112	Powerhead Mtg. Gasket	324717	1
18-0959	Inner Leaf Plate Gasket	318924	1
18-2907	Adapter Housing Gasket	325721	1
18-2905	Water Cover Gasket	329920	1
18-2853	Exhaust Cover Gasket	318925	2
18-2963	Head Gasket	330818	1
18-2879	Filter Cap to Pump Gasket	331363, 338876	1

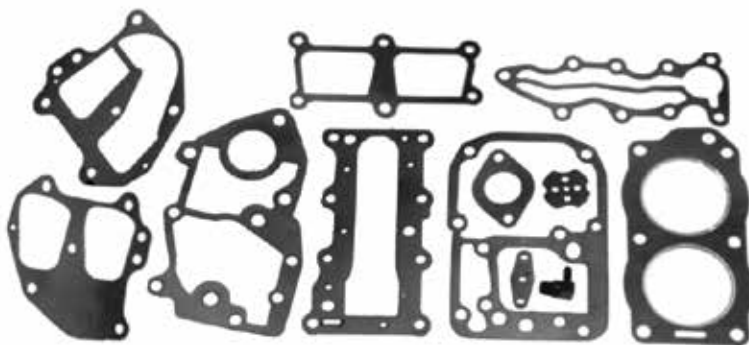

**18-4306
POWERHEAD GASKET SET**
Replaces: 394546

— CONTAINS —

Part #	Desc.	O.E. #	Qty.
18-0850	Fuel Pump Mounting Gasket	303615	1
18-0971	By-Pass Gasket	319661	1
18-0981	Leaf Plate Gasket	321479	1
18-0106	Exhaust Manifold Gasket	324323	2
18-0118	Carburetor Gasket	325092	1
18-2862	Manifold to Leaf Plate Gasket	321573, 326260	1
18-0126	Inner Exhaust Cover Gasket	326264	1
18-2852	Powerhead to Lower Unit Gasket	330621	1
18-3803	Head Gasket	329419	1



**18-4307
POWERHEAD GASKET SET**
Replaces: 433941, 392567, 392615

— CONTAINS —

Part #	Desc.	O.E. #	Qty.
18-0991	Leaf Plate	321907	6
18-0995	Adapter to Powerhead Gasket	323222	1
18-0134	Carburetor to Manifold Gasket	327707	3
18-0148	Intake Manifold Gasket	329718	1
18-0979	Air Silencer Gasket	321183	1
18-0945	Outer Exhaust Gasket	336430	1
18-0927	Inner Exhaust Cover Gasket	393561	1
18-2544	Water Jack. Cover Gasket	321028	2
18-2546	Thermostat Gasket	321184	2
18-2547	Water Passage Cover Gasket	322858	1
18-2550	Powerhead Gasket	323214	1
18-2857	Air Silencer Carburetor Gasket	386573, 319771	1
18-2876	By-Pass Cover Gasket	307133	6
18-7416	O-Ring	329380	1
18-7417	O-Ring	329381	1
18-3801	Head Gasket	325647, 335361	2

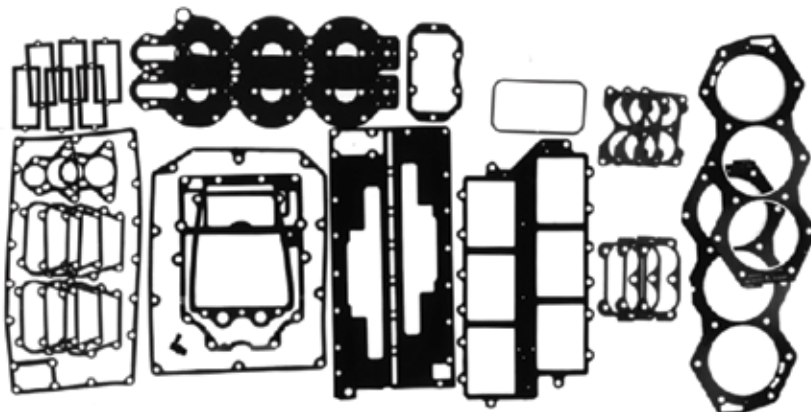

**18-4309
POWERHEAD GASKET SET**
Replaces: 394885, 434381

— CONTAINS —

Part #	Desc.	O.E. #	Qty.
18-0142	Intake Manifold Gasket	328622	1
18-0155	Rectifier Mtg. Gasket	330412	2
18-0138	Adapter to Powerhead Gasket	328590	1
18-0140	AirBox Gasket	328604	2
18-2074	Oil Seal	322575, 339620	1
18-2075	Oil Seal	332942	1
18-7418	O-Ring	326741	4
18-3837	Head Gasket	328623	2
18-0978	Cover to Base Gasket	331598	2

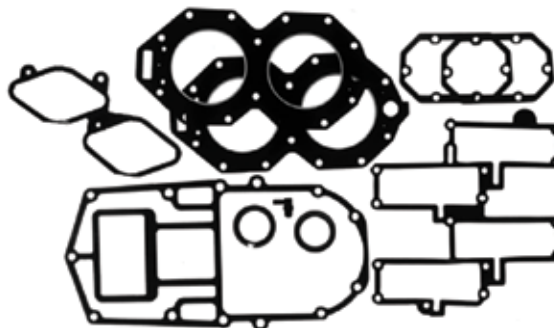

**18-4310
POWERHEAD GASKET SET**
Replaces: 396750

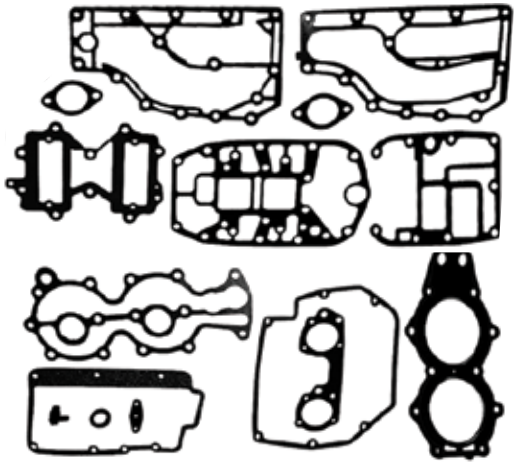

**18-4318
POWERHEAD GASKET SET**
Replaces: 390076

— CONTAINS —

Part #	Desc.	O.E. #	Qty.
18-0963	Intake Manifold GasketTwin	335633	1
18-0850	Fuel Pump Mtg. Gasket	303615	1
18-0118	Carburetor Gasket	325092	2
18-0983	Carburetor to Airbox	321497	1
18-3802	Head Gasket	327795, 335359	1
18-0941	Water Jacket Cover Gasket	315538	1
18-0157	Air Box Split Gasket	330698	1
18-0128	Powerhead Mounting Gasket	326468	1
18-0136	Powerhead Mounting Gasket	328283	1
18-1224	Exhaust Cover Gasket	315869	1
18-1218	Exhaust Cover Gasket	315868	1
18-0182	Seal	310058	1

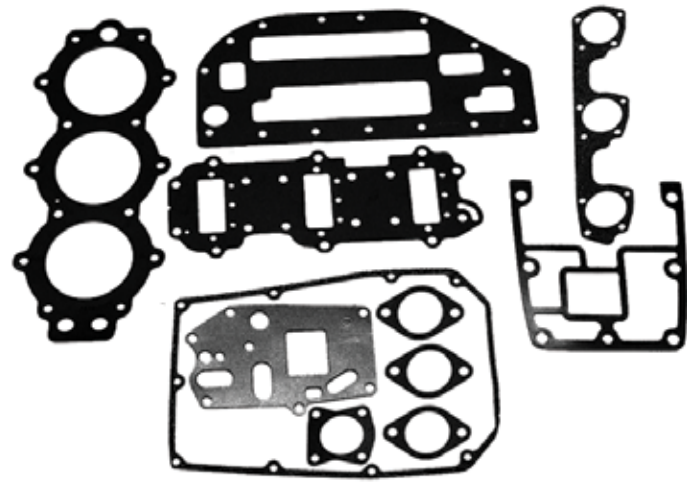

**18-4321
POWERHEAD GASKET SET**
Replaces: 398047

— CONTAINS —

Part #	Desc.	O.E. #	Qty.
18-0118	Carburetor Gasket	325092	3
18-0989	Air Silencer Gasket	321794	1
18-0975	Carb to Silencer Gasket	333008	1
18-3836	Head Gasket	329836	1
18-1202	Thermostat Cover Gasket	329830	1
18-1205	Adapter Gasket	329828	1
18-1207	Exhaust Manifold Gasket	329833	1
18-1212	Intake Manifold Gasket	326926	1
18-1219	Grommet	320880	1
18-1221	Retainer	330273	1

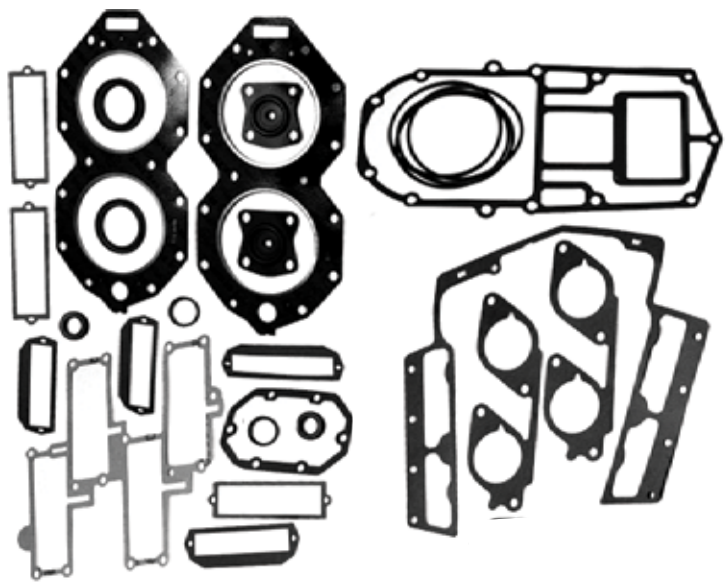

**18-4322
POWERHEAD GASKET SET**
Replaces: 432570

— CONTAINS —

Part #	Desc.	O.E. #	Qty.
18-0987	Throttle Body to Manifold Gasket	332319	2
18-0142	Intake Manifold Gasket	328622	1
18-2074	Seal	322575, 339620	1
18-2075	Seal	332942	1
18-0130	Reed Box Gasket	332266	4
18-7418	O-Ring	326741	4
18-0155	Rectifier Mtg. Gasket	330412	1
18-3866	Head Gasket	328623, 340115	2
18-0138	Adapter to Powerhead Gasket	328590	1
18-0144	Reed Box Gasket	328626	4
18-1221	Retainer	330273	2
18-1219	Grommet	320880	2
18-1222	Thermostat Gasket	394408	2

— CONTAINS —

Part #	Desc.	O.E. #	Qty.
18-0130	Reed Box Gasket	332266	6
18-3839	Head Gasket	334726, 333670	2
18-0161	Lower Manifold Gasket	331532	1
18-0155	Rectifier Mtg. Gasket	330412	1
18-0142	Intake Manifold Gasket	328622	1
18-0987	Throttle Body to Manifold Gasket	332319	3
18-0978	Cover to Base Gasket	331598	1
18-0965	Adapter to Powerhead Gasket	333879	1
18-7418	O-Ring	326741	4
18-2074	Seal	322575, 339620	1
18-2075	Seal	332942	1
18-1222	Thermostat Gasket	394408	2
18-1221	Retainer	330273	2
18-1219	Grommet	320880	2
18-0412	Thermostat Gasket	337068	2

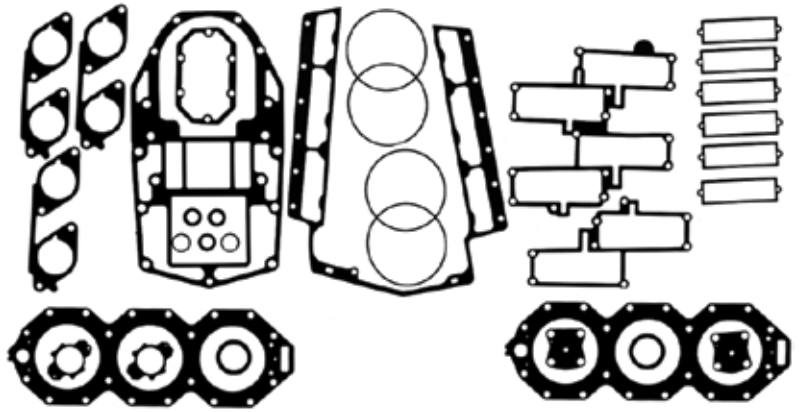

**18-4323
POWERHEAD GASKET SET**
Replaces: 436891

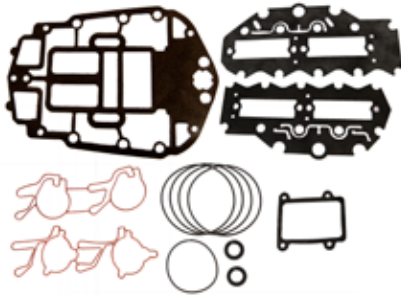

**18-4402
POWERHEAD GASKET SET**
Replaces: 437779
Fits: 90 V4 60 degree (1995-00), 115 V4 60 degree (1995-00)

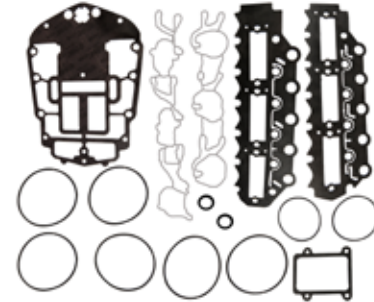

**18-4406
POWERHEAD GASKET SET**
Replaces: 437155
Fits: 150 60 degree (1991-00), 175 60 degree (1991-00)

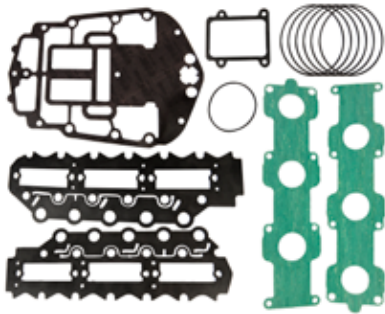

**18-4420
POWERHEAD GASKET SET**
Replaces: 439202
Fits: 150 Ficht FFI, 175 Ficht FFI

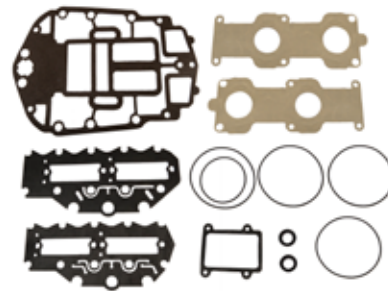

**18-4421
POWERHEAD GASKET SET**
Replaces: 5000400
Fits: 90 Ficht FFI, 115 Ficht FFI, 135 Ficht FFI

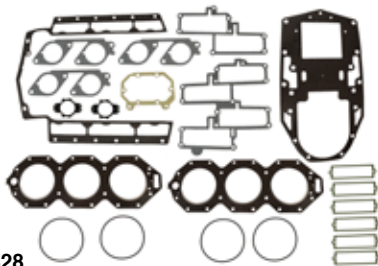

**18-4428
POWERHEAD GASKET SET**
Replaces: 437725
Fits: 200 BB (1993 & Up), 225 BB (1993 & Up), 225 Ficht FFI (1999 & Up), 250 Carb only (2000)

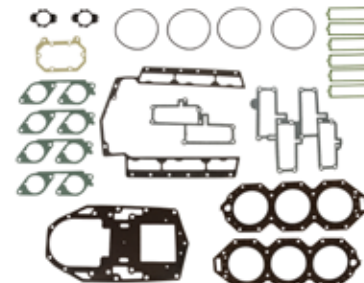

**18-4429
POWERHEAD GASKET SET**
Replaces:
Fits: 200 Ficht FFI (1999-01), 225 (2000-04), 250 (2000-04), 3.3L (2000-04)

PKG. OF 2



18-2884
18-2884-9①
HEAD GASKET
 Replaces: 313782

PKG. OF 2



18-2885
18-2885-9①
HEAD GASKET
 Replaces: 303438

PKG. OF 2



18-2888
18-2888-9①
HEAD GASKET
 Replaces: 332010



18-2950
HEAD GASKET
 Replaces: 309612

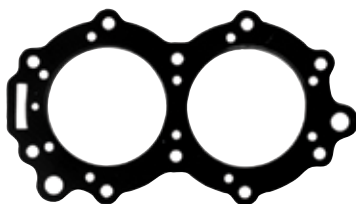

18-2951
HEAD GASKET
 Replaces: 304720



18-2952
HEAD GASKET
 Replaces: 203034

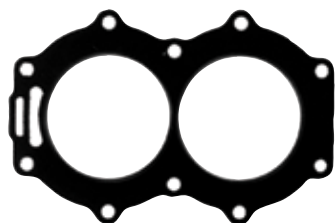

18-2954
HEAD GASKET
 Replaces: 319633



18-2956
HEAD GASKET
 Replaces: 318358



18-2957
HEAD GASKET
 Replaces: 307069



18-2958
HEAD GASKET
 Replaces: 315539



18-2959
HEAD GASKET
 Replaces: 306048

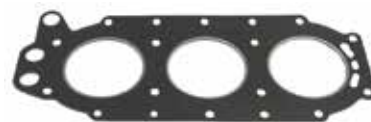

18-2960
HEAD GASKET
 Replaces: 313413



18-2961
HEAD GASKET
 Replaces: 329103



18-2962
HEAD GASKET
 Replaces: 322332



18-2963
HEAD GASKET
 Replaces: 330818

① Priced per Package

 <p>18-2964 HEAD GASKET Replaces: 320745, 335360</p>	 <p>18-3800 HEAD GASKET Replaces: 325273</p>	 <p>18-3801 HEAD GASKET Replaces: 325647, 335361</p>
 <p>18-3802 HEAD GASKET Replaces: 327795, 335359</p>	 <p>18-3803 HEAD GASKET Replaces: 329419 For: 2 cylinder models only</p>	 <p>18-3836 HEAD GASKET Replaces: 329836</p>
 <p>18-3837 HEAD GASKET Replaces: 328623</p>	 <p>18-3838 HEAD GASKET Replaces: 331211</p>	 <p>18-3839 HEAD GASKET Replaces: 333670, 334726</p>
 <p>18-3841-2 HEAD GASKET Replaces: 203130</p>	 <p>18-3898 HEAD GASKET Replaces: 332819</p>	 <p>18-3866 HEAD GASKET Replaces: 340115 For V-4 Loop Charge</p>
 <p>18-3895 HEAD GASKET Replaces: 332816</p>	 <p>18-3896 HEAD GASKET Replaces: 332817</p>	<p>PKG. OF 12</p>  <p>18-7110 18-7110-9^① CYLINDER HEAD O-RING Replaces: 335523 Fits: 90/115 HP (1995-98), 100 HP (1998), 105 HP (1997-98), 150/175 HP (1991-97)</p>
 <p>18-0490 HEAD GASKET (O-RING) Replaces: 335523 Fits: 90 Ficht FFI, 115 Ficht FFI, 135 Ficht FFI, 150 Ficht FFI, 175 Ficht FFI, 90 V4 60 degree(1995-00), 115 V4 60 degree (1995-00), 150 60 degree(1991-00), 175 60 degree(1991-00)</p>	 <p>18-0491 HEAD GASKET Replaces: 346007 Fits: 200 Ficht FFI (1999-01), 225 (2000-04), 250 (2000-04), 3.3L (2000-04)</p>	 <p>18-0492 HEAD GASKET Replaces: 340919 Fits: 200 BB (1993 & Up), 225 BB (1993 & Up), 225 Ficht FFI (1999 & Up) 250 Carb only (2000)</p>

① Priced per Package

HEAD GASKET/GASKET SET APPLICATION





HP	Year	Head Gasket	Low Comp. Head Gasket	Gasket Set	HP	Year	Head Gasket	Low Comp. Head Gasket	Gasket Set
1.5	1968-70	18-2884	—	—	65 Comm.	1987-95	18-3836	—	18-4321
2, Colt, Jr.	1971-90	18-2884	—	—	65 Jet	1991-95	18-2956 ①	18-3898 ①	18-4303-1
2.5,3,4,4.5, Ultra, Excel 4	1981-93	18-2888	—	—	70	1974-76	18-2960	18-3895	18-4300 ⑨
3	1957-68	18-3841-2	—	—	70	1977-85	18-2960	18-3895	18-4302
4	1969-80	18-3841-2	—	—	70	1986-97	18-3836	—	18-4321
4	1969-80	18-3841-2	—	—	75	1960-65	18-2959 ①	—	—
4.5	1980	18-3841-2	—	—	75	1975	18-2960	18-3895	18-4300 ⑨
5	1965-68	18-2961	—	—	75	1977-88	18-2960	18-3895	18-4302
5	1984-95	18-3800	—	—	80	1966-67	18-2959 ①	—	—
5.5	1957-58	18-2885	—	—	80 Jet	1991-96	18-2956 ①	18-2956 ①	18-4303-1
5.5	1959-64	18-2961	—	—	85	1968-72	18-2959 ①	—	—
6	1965-79	18-2961	—	—	85	1979-80,91-95	18-2956 ①	18-3898 ①	18-4303-1
6	1984-95	18-3800	—	—	88	1987-95	18-2956 ①	18-3898 ①	18-4303-1
6.5 Comm.	1989-90	18-3800	—	—	90	1964-65	18-2959 ①	—	—
7.5	1957-58	18-2952	—	—	90	1981-95	18-2956 ①	18-3898 ①	18-4303-1
7.5	1980-93	18-3800	—	—	100	1966-72	18-2959 ①	—	—
8	1984-95	18-3800	—	—	100 ③	1979-95	18-2956 ①	18-3898 ①	18-4303-1
9.5	1964-73	18-2950	—	—	1600CC	1988	18-2956 ①	18-3898 ①	18-4303-1
9.9	1974-92	18-2963	—	18-4306 ②	110	1986-89	18-2956 ①	18-3898 ①	18-4303-1
10 Comm.	1989-90	18-2963	—	18-4306	115	1969-70	18-2959 ①	—	—
14	1988-90	18-2963	—	18-4306	115	1973-77	18-2956 ①	18-3898 ①	—
15	1974-92	18-2963	—	18-4306 ④	115	1978-95	18-2956 ①	18-3898 ①	18-4303-1
18	1959-73	18-2962	—	—	120	1985-87	18-3837 ①	—	18-4310
18 Jet	1995-98	18-3803	—	18-4307	120	1988-94	18-3866 ①	—	18-4322
20	1981-99	18-3803	—	18-4307	125 Comm.	1992-95	18-3866 ①	—	18-4322
25	1969-76	18-2962	—	—	130	1995-98	18-3866 ①	—	18-4322
25	1977-78	18-2954	—	—	135	1973-76	18-2956 ①	18-3898 ①	18-4301
25 ⑤	1979-03	18-3803	—	18-4307	140	1977	18-2956 ①	18-3898 ①	18-4301
28	1986-96	18-3803	—	18-4307	140	1978-84	18-2956 ①	18-3898 ①	18-4303-1
30 ⑤	1984-03	18-3803	—	18-4307	140	1985-87	18-3837 ①	—	18-4310
33	1965-70	18-2951	—	—	140	1988-94	18-3866 ①	—	18-4322
35	1957-58	18-2951	—	—	150	1973-91	18-2964 ①	18-3896 ①	18-4304-1
35	1976-78	18-2954	—	—	155 Comm.	1984-92	18-2964 ①	18-3896 ①	18-4304-1
35	1979-88	18-3803	—	18-4307	2500CC	1988	18-2964 ①	18-3896 ①	18-4304-1
35 ⑥	1987	18-3802	—	18-4305	175	1977-83	18-2964 ①	18-3896 ①	18-4304-1
40	1960-80	18-2957	—	—	175	1986-91	18-3801 ①	18-3897 ①	18-4309
40 Comm.	1981-90	18-2957	—	18-4324	185	1984-85	18-2964 ①	18-3896 ①	18-4304-1
40	1984-97	18-3802	—	18-4305	185	1990-93	18-3839 ①	—	18-4323
40 Comm.	1994-97	18-3802	—	18-4305	200	1976-83	18-2964 ①	18-3896 ①	18-4304-1
45 Comm.	1985-97	18-3802	—	18-4305	200	1986-87	18-3838 ①	—	—
45SS	1987-90	18-3802	—	—	200 ③	1988-93	18-3839 ①	—	18-4323
48	1987-97	18-3802	—	18-4305	225	1986-87	18-3838 ①	—	—
50	1958-59	—	—	—	225	1988-93	18-3839 ①	—	18-4323
50	1971-75	18-2958	—	18-4305 ⑦	235	1978-79	18-2964 ①	18-3896 ①	—
50	1979-80	18-3802	—	18-4318	235	1980-85	18-3801 ①	18-3897 ①	18-4309
50	1981-97	18-3802	—	18-4305	275/3.6L	1985-87	18-3840 ①	—	—
55	1968-69	18-2960	18-3895	—	OMC SEA DRIVE				
55	1977-79	18-3802	—	18-4318	HP	Year	Head Gasket	Low Comp. Head Gasket	Gasket Set
55	1980-97	18-3802	—	18-4305	1.6L	1983-90	18-2956	18-3898 ①	18-4303-1
55	1995	18-3802	—	—	1.8L	1987	18-3837	-	-
60	1970-71	18-2960	18-3895	—	2.0L	1988-90	18-3866 ①	-	18-4322
60	1980-85	18-3802	—	18-4305	2.5L	1982,84-85	18-2964	18-3896 ①	18-4304-1
60	1986-88	18-2960	18-3895	18-4302	2.6L	1982-86	18-3801 ①	18-3897 ①	-
60	1989-97	18-3836	—	18-4321	2.7L	1987	18-3838	-	-
SST60	1989-90	18-3836	—	—	3.0L	1988-90	18-3839	-	-
65	1968	—	—	—	3.6L	1987	18-3840	-	-
65	1972-73	18-2960	18-3895	18-4300 ⑨					
65 Comm.	1984-86	18-2960	—	18-4302					

① Two head gaskets required per engine
 ② 1976 G & H Suffix models only
 ③ Commercial models also





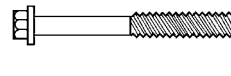
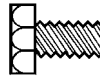

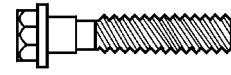
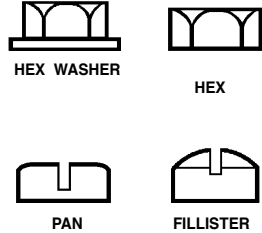





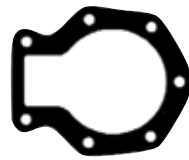
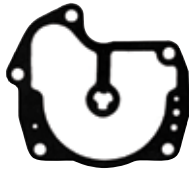

④ 1976 A Suffix models only
 ⑤ For 2 cylinder models only
 ⑥ D Suffix models only

⑦ 18-2958 Head Gasket required to complete set
 ⑨ Head Gasket Not Available in Gasket Set

























STAINLESS STEEL BOLTS

 <p>18-3133 Replaces: 331979 1/4" x 20 x 1 1/16" HEX For: Rewind starters, water pump housings, mid-sections and jet drive units</p>	<p>PKG. OF 2</p>  <p>18-3135 18-3135-9① Replaces: 306643 1/8" x 20 x 1/2" PAN HEAD For: Lower unit anodes, ignition covers and water pump housings</p>	<p>PKG. OF 2</p>  <p>18-3136 18-3136-9① Replaces: 323626 1/4" x 20 x 1 3/4" HEX WASHER For: Water pump housings, exhaust covers, intake manifolds, ignition coils and more</p>	 <p>18-3153 Replaces: 908158 1/4" x 20 x 1/2" HEX For: Lower unit anodes, bearing carriers, 45 HP and up and Cobra, 5 HP lower engine covers</p>
 <p>18-3365 Replaces: 909533 1/4" x 20 x 1" HEX WASHER For: Flywheel covers, intake covers and more</p>	 <p>18-3369 Replaces: 302325 1/4" x 20 x 1" HEX For: Impeller housings, ignition coils, exhaust covers, shift covers and starter brackets</p>	<p>PKG. OF 5</p>  <p>18-4276 18-4276-9① Replaces: 324334 1/4" x 20 x 1 1/32" HEX WASHER For: Water pump housings, exhaust covers, intake manifolds, ignition coils and more</p>	<p>HEAD STYLES</p>  <p>HEX WASHER HEX PAN FILLISTER</p>

SEE PAGES 166-167 FOR OUR COMPLETE LINE OF GASKET SEALANTS

















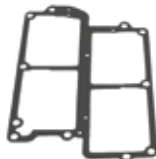

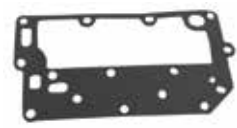



<p>PKG. OF 2</p>  <p>18-0118 18-0118-9① CARB GASKET Replaces: 325092</p>	<p>PKG. OF 2</p>  <p>18-0134 18-0134-9① V-4 & V-6 CARB TO MANIFOLD GASKET Replaces: 327707</p>	<p>PKG. OF 2</p>  <p>18-0961 18-0961-9① CARB MOUNTING GAS-KET Replaces: 318932</p>	 <p>18-0437 COVER GASKET Replaces: 334353</p>	 <p>18-0626 COVER GASKET Replaces: 334043</p>
 <p>18-1241 FLOAT BOWL AND NOZZLE GASKET</p>	 <p>18-2579 FLOAT BOWL GASKET Replaces: 338882</p>	 <p>18-2582 CARB BOWL GASKET Replaces: 338813</p>	 <p>18-8352 CARBURETOR MOUNTING GASKET Replaces: 332253</p>	<p>PKG. OF 2</p>  <p>18-2890 18-2890-9① FLOAT BOWL GASKET Replaces: 331203, 338886</p>
<p>PKG. OF 2</p>  <p>18-2893 18-2893-9① FLOAT BOWL GASKET Replaces: 303750</p>	<p>PKG. OF 2</p>  <p>18-2903 18-2903-9① FLOAT BOWL GASKET Replaces: 332696, 338880</p>	<p>PKG. OF 2</p>  <p>18-2906 18-2906-9① FLOAT BOWL GASKET Replaces: 333418 V-4, V-6</p>	<p>PKG. OF 2</p>  <p>18-2908 18-2908-9① FLOAT BOWL GASKET Replaces: 331499, 338878</p>	<p>PKG. OF 2</p>  <p>18-0850 18-0850-9① FUEL PUMP GASKET Replaces: 303615</p>

① Priced per package

<p>PKG. OF 2</p>  <p>18-2879 18-2879-9① FILTER CAP TO PUMP GASKET Replaces: 331363, 338876</p>	<p>PKG. OF 2</p>  <p>18-2900 18-2900-9① CAP TO FUEL PUMP GASKET Replaces: 332694, 338879</p>	<p>PKG. OF 2</p>  <p>18-2889 18-2889-9① FILTER BOWL GASKET Replaces: 302675</p>	<p>PKG. OF 2</p>  <p>18-2892 18-2892-9① FILTER BOWL GASKET Replaces: 303355</p>	 <p>18-0140 AIR BOX GASKET Replaces: 328604</p>
 <p>18-0157 AIR BOX GASKET Replaces: 330698</p>	 <p>18-0159 AIR BOX GASKET Replaces: 330909</p>	 <p>18-0933 AIR SILENCER GASKET Replaces: 314115 70/75 HP</p>	 <p>18-0935 BASE TO COVER GASKET Replaces: 314322 70/75 HP</p>	<p>PKG. OF 2</p>  <p>18-0975 18-0975-9① CARB TO SILENCER GASKET Replaces: 333008 3 Cyl.</p>
 <p>18-0978 COVER TO BASE GASKET Replaces: 331598 For: 185, 200 & 225 H.P., V-6</p>	 <p>18-0979 AIR SILENCER GASKET Replaces: 321183 V-6</p>	<p>PKG. OF 2</p>  <p>18-0983 18-0983-9① CARB TO AIR BOX TWIN GASKET Replaces: 321497</p>	 <p>18-0985 AIR SILENCER GASKET Replaces: 321722 V-4</p>	 <p>18-0989 AIR SILENCER GASKET Replaces: 321794 3 Cyl.</p>
<p>PKG. OF 2</p>  <p>18-2857 18-2857-9① AIR SILENCER GASKET Replaces: 386573, 319771</p>	<p>PKG. OF 2</p>  <p>18-0122 18-0122-9① 9.9 & 15 HP OUTER LEAFPLATE GASKET Replaces: 325260</p>	<p>PKG. OF 2</p>  <p>18-0130 18-0130-9① REED BLOCK GASKET Replaces: 332266 For: V-4, V-6 & V-8</p>	 <p>18-0142 INTAKE MANIFOLD GASKET Replaces: 328622</p>	<p>PKG. OF 2</p>  <p>18-0144 18-0144-9① REED BLOCK GASKET Replaces: 328626 For: 120-140 H.P V-4</p>
 <p>18-0148 INTAKE MANIFOLD GASKET Replaces: 329718 V-6</p>	 <p>18-0161 LOWER MANIFOLD GASKET Replaces: 331532 For: V-6</p>	 <p>18-0424 INTAKE MANIFOLD GASKET Replaces: 315578</p>	 <p>18-0951 CARB TO MANIFOLD GASKET Replaces: 317305 3 Cyl.</p>	<p>PKG. OF 2</p>  <p>18-0959 18-0959-9① INNER LEAF PLATE GASKET Replaces: 318924 9.9 & 15 HP</p>





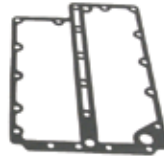
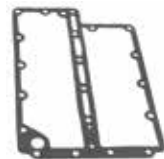





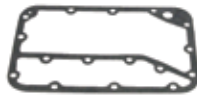

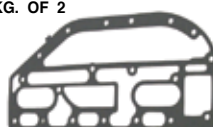



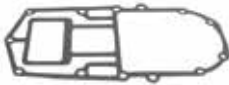

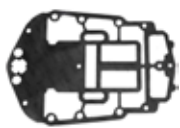



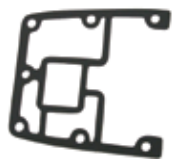
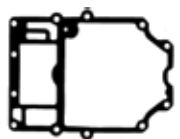

SEE PAGES 166-167 FOR OUR COMPLETE LINE OF GASKET SEALANTS

① Priced per package

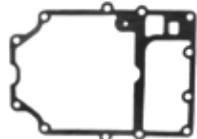
<p>PKG. OF 2</p>  <p>18-0963 18-0963-9① INTAKE MANIFOLD TWIN GASKET Replaces: 335633</p>	<p>PKG. OF 2</p>  <p>18-0981 18-0981-9① LEAF PLATE GASKET Replaces: 321479 25 & 35 HP</p>	<p>PKG. OF 2</p>  <p>18-0987 18-0987-9① THROTTLE BODY TO MANIFOLD GASKET Replaces: 332319</p>	<p>PKG. OF 2</p>  <p>18-0991 18-0991-9① LEAF PLATE GASKET Replaces: 321907 V-4/V-6</p>	<p>PKG. OF 2</p>  <p>18-0973 18-0973-9① CARB GASKET Replaces: 315052 V-4 Carburetor mounting includes: 100, 115, 125, 135, 140, 150, 175, 200, 235(1977-79), 85 (1969-79)</p>
<p>18-1212 INTAKE MANIFOLD GASKET Replaces: 326926 For: 3 cyl.</p> 	<p>PKG. OF 2</p>  <p>18-2862 18-2862-9① LEAF PLATE GASKET Replaces: 321573, 326260 25/35 HP</p>	<p>PKG. OF 2</p>  <p>18-2867 18-2867-9① MANIFOLD TO CRANKCASE GASKET Replaces: 319174 For: V-4</p>	<p>18-0102 EXHAUST MANIFOLD GASKET Replaces: 323469 V-4</p> 	<p>PKG. OF 2</p>  <p>18-0106 18-0106-9① EXHAUST MANIFOLD GASKET Replaces: 324323 25/35</p>
<p>18-0117 EXHAUST PLATE GASKET Replaces: 317955 V-4</p> 	<p>18-0120 EXHAUST PLATE GASKET Replaces: 325211</p> 	<p>PKG. OF 2</p>  <p>18-0126 18-0126-9① INNER EXHAUST COVER GASKET Replaces: 326264</p>	<p>18-0927 235 HP INNER EXHAUST COVER GASKET Replaces: 393561</p> 	<p>PKG. OF 2</p>  <p>18-0999-9① INNER EXHAUST GASKET Replaces: 323459 V-4</p>
<p>18-0945 OUTER EXHAUST GASKET Replaces: 336430</p> 	<p>18-0955 EXHAUST COVER GASKET Replaces: 318156 V-4</p> 	<p>18-1207 EXHAUST MANIFOLD GASKET Replaces: 329833</p> 	<p>18-1218 EXHAUST COVER GASKET Replaces: 315868</p> 	<p>18-1224 EXHAUST COVER GASKET Replaces: 315869</p> 
<p>PKG. OF 2</p>  <p>18-2545 18-2545-9① EXHAUST PLATE GASKET Replaces: 321182 V-6</p>	<p>PKG. OF 2</p>  <p>18-2549 18-2549-9① EXHAUST COVER GASKET Replaces: 321435 V-6</p>	<p>PKG. OF 2</p>  <p>18-2853 18-2853-9① EXHAUST COVER GASKET Replaces: 318925 9.9/15 HP</p>	<p>PKG. OF 2</p>  <p>18-2866 18-2866-9① EXHAUST COVER GASKET Replaces: 317914 V-4</p>	<p>PKG. OF 2</p>  <p>18-2870 18-2870-9① EXHAUST COVER GASKET Replaces: 305176</p>



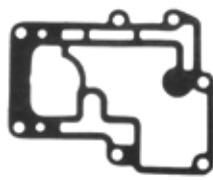
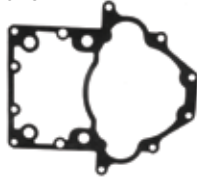

















SEE PAGES 166-167 FOR OUR COMPLETE LINE OF GASKET SEALANTS

① Priced per package

<p>PKG. OF 2</p>  <p>18-2871 18-2871-9① EXHAUST COVER GASKET Replaces: 304762</p>	<p>PKG. OF 2</p>  <p>18-2886 18-2886-9① COVER PLATE GASKET Replaces: 203171</p>	<p>PKG. OF 2</p>  <p>18-2913 18-2913-9① EXHAUST COVER GASKET Replaces: 331916 3 Cyl.</p>	<p>PKG. OF 2</p>  <p>18-2938 18-2938-9① EXHAUST COVER GASKET Replaces: 331917 3 Cyl.</p>	 <p>18-1285 MOLDED INTAKE PORT GASKET Replaces: 335403 For: V6 60° Eagle series 150-175HP (1991-00)</p>
 <p>18-0112 POWERHEAD BASE GASKET Replaces: 324717 9.9 & 15 HP</p>	 <p>18-0128 POWERHEAD BASE GASKET Replaces: 326468</p>	 <p>18-0136 POWERHEAD BASE GASKET Replaces: 328283</p>	 <p>18-0138 POWERHEAD BASE GASKET Replaces: 328590</p>	 <p>18-0690 BASE GASKET Replaces: 347205 Fits: 200 BB (1993 & Up), 200 Ficht FFI (1999-01), 225 BB (1993 & Up), 225 Ficht FFI (1999 & Up), 225 (2000-04), 250 Carb only (2000), 250 (2000-04), 3.3L (2000-04)</p>
 <p>18-0691 BASE GASKET Replaces: Fits:150 Ficht FFI , 175 Ficht FFI</p>	 <p>18-0692 BASE GASKET Replaces: 339601 Fits:90 V4 60 degree (1995-00), 90 Ficht FFI, 1150V4 60 degree (1995-00), 115 Ficht FFI, 135 Ficht FFI, 150 60 degree (1991-00), 175 60 degree (1991-00)</p>	 <p>18-0693 INTAKE GASKET Replaces: 336227 Fits: 135(2005-06), 150(1991-98), 150(1991-06), 175(1991-06)</p>	 <p>18-0694 INTAKE GASKET Replaces: 336226 Fits: 135(2005-06), 150(1991-05), 175(1991-05)</p>	 <p>18-0695 INTAKE GASKET Replaces: 336389 Fits: 90(1995-06), 115(1995-06), 100(1998-01, 2005)</p>
 <p>18-0696 INTAKE GASKET Replaces: 336388 Fits: 90(1995-06), 100(1998-01, 2005), 115(1995-06)</p>	 <p>18-0957 POWERHEAD BASE GASKET Replaces: 318373</p>	 <p>18-0965 ADAPTER OUTER POWERHEAD GASKET Replaces: 333879</p>	 <p>18-0995 POWERHEAD BASE GASKET Replaces: 323222 V-6</p>	<p>PKG. OF 2</p>  <p>18-1205 18-1205-9① ADAPTER COVER GASKET Replaces: 329828</p>
<p>PKG. OF 2</p>  <p>18-2550 18-2550-9① POWERHEAD BASE GASKET Replaces: 323214 V-6</p>	<p>PKG. OF 2</p>  <p>18-2852 18-2852-9① POWERHEAD BASE GASKET Replaces: 330621 25/35 HP</p>	<p>PKG. OF 2</p>  <p>18-2864 18-2864-9① POWERHEAD BASE GASKET Replaces: 321727 V-4</p>	<p>PKG. OF 2</p>  <p>18-2865 18-2865-9① POWERHEAD BASE GASKET Replaces: 313763 3 Cyl.</p>	<p>PKG. OF 2</p>  <p>18-2868 18-2868-9① POWERHEAD BASE GASKET Replaces: 310137 35/40 HP</p>
<p>PKG. OF 2</p>  <p>18-2877 18-2877-9① BAFFLE GASKET Replaces: 314421 18/25 HP</p>	<p>PKG. OF 2</p>  <p>18-2878 18-2878-9① BAFFLE GASKET Replaces: 319710 25/35</p>	<p>PKG. OF 2</p>  <p>18-2894 18-2894-9① EXHAUST HOUSING GASKET Replaces: 304314</p>	<p>PKG. OF 2</p>  <p>18-2898 18-2898-9① POWERHEAD BASE GASKET Replaces: 309956 V-4</p>	<p>PKG. OF 2</p>  <p>18-2901 18-2901-9① EXHAUST HOUSING GASKET Replaces: 313065 5, 5.5, 6 HP</p>

























SEE PAGES 166-167 FOR OUR COMPLETE LINE OF GASKET SEALANTS

① Priced per package

<p>PKG. OF 2</p>  <p>18-2904 18-2904-9① EXHAUST PLATE GASKET Replaces: 319348 28, 33, 40 HP</p>	<p>PKG. OF 2</p>  <p>18-2907 18-2907-9① EXHAUST HOUSING GASKET Replaces: 325721</p>	<p>PKG. OF 2</p>  <p>18-0967 18-0967-9① BYPASS COVER GASKET Replaces: 319332 9.9 & 15 HP</p>	 <p>18-0971 BYPASS GASKET Replaces: 319661 25 & 35 HP</p>	 <p>18-1229 BYPASS COVER GASKET Replaces: 304784</p>
<p>PKG. OF 2</p>  <p>18-2876 18-2876-9① BYPASS COVER GASKET Replaces: 307133</p>	<p>PKG. OF 2</p>  <p>18-0941 WATER JACKET GASKET Replaces: 315538 50/55 HP</p>	<p>PKG. OF 2</p>  <p>18-2543 18-2543-9① WATER JACKET GASKET Replaces: 318609 3 Cyl.</p>	 <p>18-0892 DEFLECTOR HOSE Replaces: 322411</p>	<p>PKG. OF 2</p>  <p>18-2544 18-2544-9① WATER JACKET GASKET Replaces: 321028 V-6</p>
<p>PKG. OF 2</p>  <p>18-2856 18-2856-9① WATER JACKET GASKET Replaces: 319665 25/35 HP</p>	<p>PKG. OF 2</p>  <p>18-3899 WATER COVER GASKET Replaces: 327674 FOR: 20, 25, 25C, 30, 35</p>	<p>PKG. OF 2</p>  <p>18-2872 18-2872-9① WATER JACKET GASKET Replaces: 318334 V-4</p>	<p>PKG. OF 2</p>  <p>18-2873 18-2873-9① WATER JACKET GASKET Replaces: 318335 V-4</p>	<p>PKG. OF 2</p>  <p>18-2905 18-2905-9① WATER COVER GASKET Replaces: 329920 9.9, 15 HP</p>
 <p>18-3360 IMPELLER HOUSING GASKET Replaces: 329390 20-25 HP</p>	<p>PKG. OF 2</p>  <p>18-0182 18-0182-9① THERMOSTAT GASKET Replaces: 310058</p>	<p>PKG. OF 2</p>  <p>18-0397 THERMOSTAT GASKET Replaces: 318917</p>	<p>PKG. OF 2</p>  <p>18-0412 18-0412-9① THERMOSTAT GASKET Replaces: 337068</p>	 <p>18-0426 THERMOSTAT GASKET Replaces: 305196</p>
<p>PKG. OF 2</p>  <p>18-0441 18-0441-9① THERMOSTAT GASKET Replaces: 329076</p>	<p>PKG. OF 2</p>  <p>18-0929 18-0929-9① THERMOSTAT GASKET Replaces: 313416 3 Cyl.</p>	<p>PKG. OF 2</p>  <p>18-0675 THERMOSTAT GASKET Replaces: 321932 V-4</p>	<p>PKG. OF 2</p>  <p>18-0977 18-0977-9① THERMOSTAT GASKET Replaces: 332369 V-4</p>	<p>PKG. OF 2</p>  <p>18-1202 18-1202-9① THERMOSTAT GASKET Replaces: 329830</p>

SEE PAGES 166-167 FOR OUR COMPLETE LINE OF GASKET SEALANTS

① Priced per package

 <p>18-1222 THERMOSTAT GASKET Replaces: 394408</p>	<p>PKG. OF 2</p>  <p>18-2547 18-2547-9① WATER PASSAGE GASKET Replaces: 322858 V-4/V-6</p>	<p>PKG. OF 2</p>  <p>18-2548 18-2548-9① THERMOSTAT GASKET Replaces: 332108 3 Cyl.</p>	<p>PKG. OF 2</p>  <p>18-2546 18-2546-9① THERMOSTAT GASKET Replaces: 321184 V-6</p>	<p>PKG. OF 2</p>  <p>18-0124 18-0124-9① IMPELLER PLATE GASKET Replaces: 325537</p>
<p>PKG. OF 2</p>  <p>18-0445 18-0445-9① WATER PUMP GASKET Replaces: 323312 35HP</p>	<p>PKG. OF 2</p>  <p>18-0446 WATER PUMP GASKET Replaces: 323311 35HP</p>	<p>PKG. OF 2</p>  <p>18-0969 18-0969-9① IMPELLER HOUSING GASKET Replaces: 319586</p>	<p>PKG. OF 5</p>  <p>18-2536 18-2536-9① IMPELLER HOUSING SEAL Replaces: 321120 V-4, V-6</p>	<p>PKG. OF 5</p>  <p>18-2539 18-2539-9① RUBBER SEAL Replaces: 328753 40"</p>
 <p>18-2541 RUBBER SEAL Replaces: 911704</p>	<p>PKG. OF 2</p>  <p>18-2557 18-2557-9① IMPELLER GASKET Replaces: 324701, 338484 V-4, V-6, V-8</p>	<p>PKG. OF 2</p>  <p>18-2709 18-2709-9① WEAR PLATE GASKET Replaces: 336530</p>	 <p>18-0679 THERMOSTAT GASKET Replaces: 311145</p>	<p>PKG. OF 2</p>  <p>18-7428 18-7428-9① O-RING Replaces: 307103</p>
<p>PKG. OF 2</p>  <p>18-7481 18-7481-9① O-RING Replaces: 324981</p>	<p>PKG. OF 2</p>  <p>18-0155 18-0155-9① RECTIFIER MOUNTING GASKET Replaces: 330412</p>	<p>PKG. OF 2</p>  <p>18-0851 18-0851-9① RELIEF GASKET Replaces: 329826</p>	<p>PKG. OF 2</p>  <p>18-0953 18-0953-9① WATER PASSAGE GASKET Replaces: 317951 V-4/V-6</p>	<p>PKG. OF 2</p>  <p>18-0110 18-0110-9① SHIFT HOUSING GASKET Replaces: 324670</p>
 <p>18-0313 SHIFT ROD GASKET Replaces: 352165 For: E-Tec 75/90/115/150/175/200/225/250 HP</p>	<p>PKG. OF 2</p>  <p>18-0882 18-0882-9① SHIFT ROD GASKET Replaces: 304764</p>	<p>PKG. OF 2</p>  <p>18-2855 18-2855-9① SHIFT HOUSING GASKET Replaces: 314082</p>	<p>PKG. OF 2</p>  <p>18-2874 18-2874-9① SOLENOID COVER GASKET Replaces: 314876 V-4</p>	<p>PKG. OF 2</p>  <p>18-2880 18-2880-9① COVER PLATE GASKET Replaces: 304023</p>

SEE PAGES 166-167 FOR OUR COMPLETE LINE OF GASKET SEALANTS

① Priced per package

<p>PKG. OF 2</p>  <p>18-0108 18-0108-9① LOWER GEAR CASE GASKET Replaces: 324449</p>	<p>PKG. OF 2</p>  <p>18-0540 EXHAUST LEG RUBBER SEAL Replaces: 320936</p>	<p>PKG. OF 2</p>  <p>18-0949 18-0949-9① TRUNION CAP GASKET Replaces: 316499</p>	<p>PKG. OF 2</p>  <p>18-2537 EXHAUST SEAL LEG Replaces: 324937</p>	<p>PKG. OF 2</p>  <p>18-2869 18-2869-9① EXHAUST HOUSING GASKET Replaces: 305312</p>
<p>PKG. OF 2</p>  <p>18-2891 18-2891-9① BEARING HOUSING GASKET Replaces: 303339 6HP</p>	<p>PKG. OF 2</p>  <p>18-0188 18-0188-9① WASHER Replaces: 909748</p>	<p>PKG. OF 2</p>  <p>18-8353 OIL SEAL Replaces: 320961</p>	<p>PKG. OF 2</p>  <p>18-1219 GROMMET Replaces: 320880</p>	<p>PKG. OF 2</p>  <p>18-2389 GROMMET Replaces: 314832</p>
<p>PKG. OF 2</p>  <p>18-2391 GROMMET Replaces: 321692</p>	<p>PKG. OF 2</p>  <p>18-2392 GROMMET Replaces: 327035</p>	<p>PKG. OF 2</p>  <p>18-2703 18-2703-9① GROMMET Replaces: 314008</p>	<p>PKG. OF 2</p>  <p>18-2704 GROMMET Replaces: 320943</p>	<p>PKG. OF 2</p>  <p>18-2706 18-2706-9① GROMMET Replaces: 321008</p>
<p>PKG. OF 2</p>  <p>18-2708 18-2708-9① GROMMET Replaces: 333758</p>	<p>PKG. OF 2</p>  <p>18-3329 GROMMET Replaces: 302497 9.9-35 HP</p>	<p>PKG. OF 2</p>  <p>18-3332 GROMMET Replaces: 304026</p>	<p>PKG. OF 2</p>  <p>18-3337 GROMMET Replaces: 315837 40-50 HP</p>	<p>PKG. OF 2</p>  <p>18-1221 18-1221-9① RETAINER GASKET Replaces: 330273</p>
<p>PKG. OF 2</p>  <p>18-2532 GEARCASE COVER SEAL Replaces: 305762 2 Cyl.</p>	<p>PKG. OF 2</p>  <p>18-2534 SEAL 40" Replaces: 309044 Material equivalent to that of O.E. spool # 309044</p>	<p>PKG. OF 2</p>  <p>18-7963 O-RING Replaces: 331353</p>	<p>PKG. OF 2</p>  <p>18-2705 18-2705-9① OIL SEAL Replaces: 315748</p>	<p>PKG. OF 2</p>  <p>18-2769 18-2769-9① RUBBER SEAL Replaces: 332000</p>

SEE PAGES 166-167 FOR OUR COMPLETE LINE OF GASKET SEALANTS



① Priced per package

PKG. OF 2  18-0913 TILT MOTOR GASKET Replaces: 909902	PKG. OF 2  18-0917 TILT MOTOR GASKET Replaces: 311508	 18-8372 MOLDED SEAL Replaces: 323582 For: 5 & 7.5 HP (1978-83) Outboards	PKG. OF 2  18-2881 18-2881-9④ HOUSING TO TANK GASKET Replaces: 332403, 125530 For: 6 Gallon Fuel Tank	PKG. OF 2  18-2887 18-2887-9④ FUEL TANK GASKET Replaces: 302557
--	--	---	---	--

 18-1280 SCREW WITH O-RING Replaces: 317763 115-235HP (1980-87) Cobra Drives	 18-4904 STARTER HANDLE & ROPE (Uses 9/64" Rope) Handle Only: 18-4901	 STARTER ROPE 18-4911 5/32" x 200' Replaces: 322236, 772577 18-4913 3/16" x 200' Replaces: 316705, 772578 18-4914 1/8" x 200' Replaces: 316706, 772579	 18-1505 STARTER GEAR Replaces: 318940 For: 9.9 - 15HP (1974-1992)	 18-6501 REWIND SPRING Replaces: 395460, 307573
--	---	---	---	---

 18-6503 REWIND SPRING Replaces: 318944	 18-6509 REWIND SPRING Replaces: 326877	 18-6511 REWIND SPRING Replaces: 312932	 18-6522 REWIND SPRING Replaces: 323653, 338534
--	--	---	--

H.P.	YEARS	REWIND SPRING	H.P.	YEARS	REWIND SPRING	H.P.	YEARS	REWIND SPRING	H.P.	YEARS	REWIND SPRING
2	1969-80	18-6511	4.5	1980-90	18-6511	10	1950-63	18-6501	18	1968-73	18-6501
3	1954-68	18-6501	5.5	1954-68	18-6501	12	1980-92	18-6522	20	1956-73,	18-6501
4 ①	1969-92	18-6511	7.5	1954-68	18-6501	12	1956-68	18-6501	20	85-97	
4 ②	1969-80	18-6511	9.9	1980-92	18-6522	15	1979-92	18-6522	28	1969-92	18-6501
4 ③	1981-92	18-6509	9.9	1974-78	18-6503	15	1956-68	18-6501	25	1969-05	18-6501
① 1992 4D Models only			10	1980-92	18-6522	15	1974-78	18-6503	30	1984-05	18-6501
② Except 4D			③ All 4D						35	1976-94	18-6501

PKG. OF 3  18-6513 18-6513-9④ STARTER PAWL Replaces: 203698	PKG. OF 2  18-6512 18-6512-9④ STARTER PAWL Replaces: 330525
--	--

HP	Years	Pawl	HP	Years	Pawl	HP	Years	Pawl
2	1971-88	18-6513	18	1957-73	18-6513	30	1984-90	18-6512
Jr/Colt	1990	18-6513	20	1981-90	18-6512	35	1976-77	18-6513
3	1957-67	18-6513	25	1969-76	18-6513	35	1978-90	18-6512
4	1978-90	18-6513	25	1977	18-6513	45	1958-59	18-6513
5.5	1957-64	18-6513	25	1978-90	18-6512	50	1958-89	18-6513
7.5	1957-76	18-6513	25C	1982-90	18-6512	60	1964-66	18-6513
10	1957-62	18-6513	30	1957-61	18-6512	75	1960-65	18-6513
						80	1966	18-6513

SEE PAGES 166-167 FOR OUR COMPLETE LINE OF GASKET SEALANTS

④ Priced per package

COMPLETE PROTECTION FOR YOUR MARINE ENGINE

WE'VE GOT YOU COVERED

Sierra
Marine Engine and Drive Parts



- Widest variety of oil and lubricants in the industry
- Covered by Sierra's Industry Leading Warranty
- Blended to FC-W[®] and TC-W3[®] certification standards
- Specifically designed for the marine engine
- Sierra has the right lubricant for the job



Explore

www.seastarsolutions.com



SEASTAR
SOLUTIONS[®]

- 78 — Gear Housing Seal Kit 16-2658
- 77 — Water Pump Repair Kit W/ HOUSING 18-3382

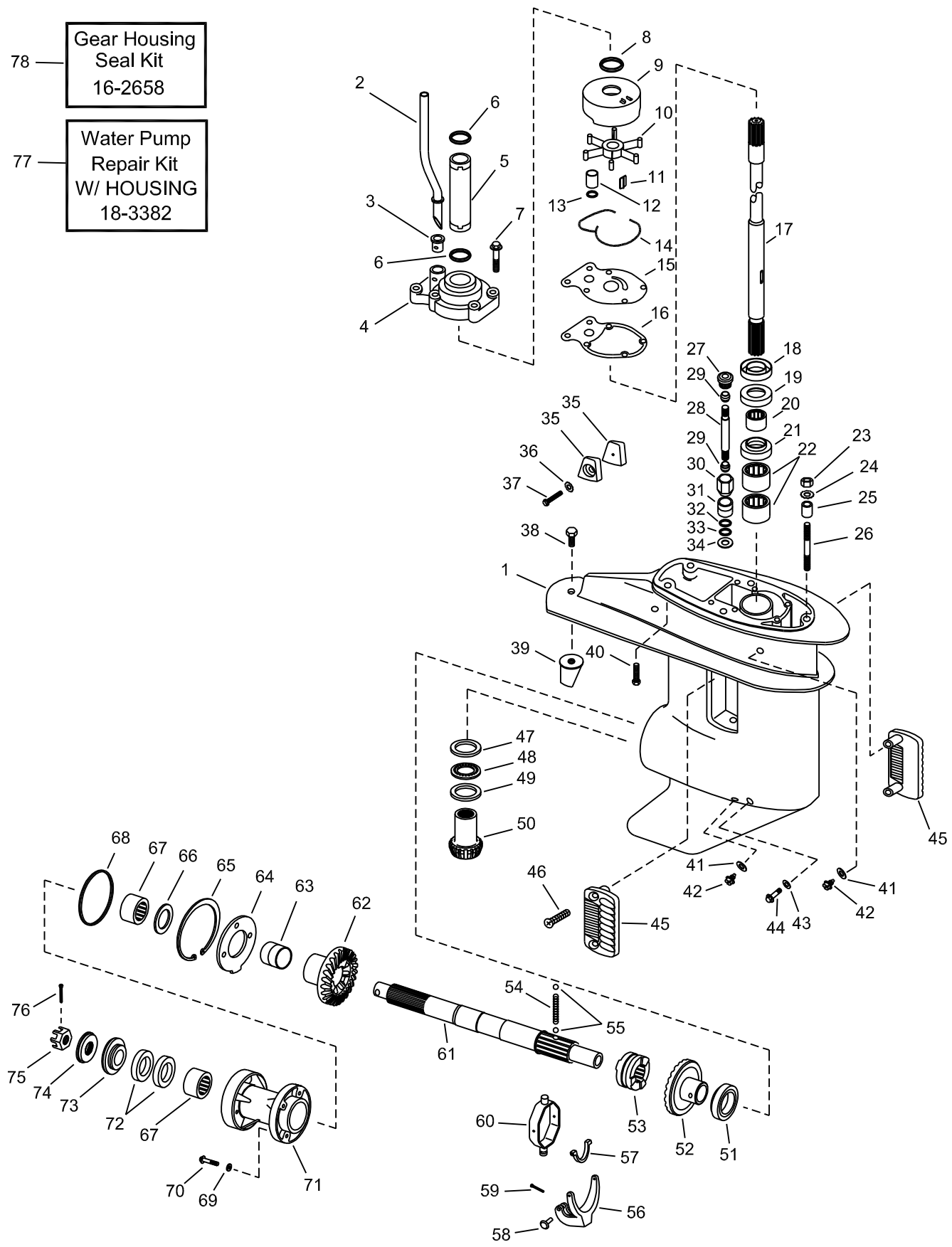
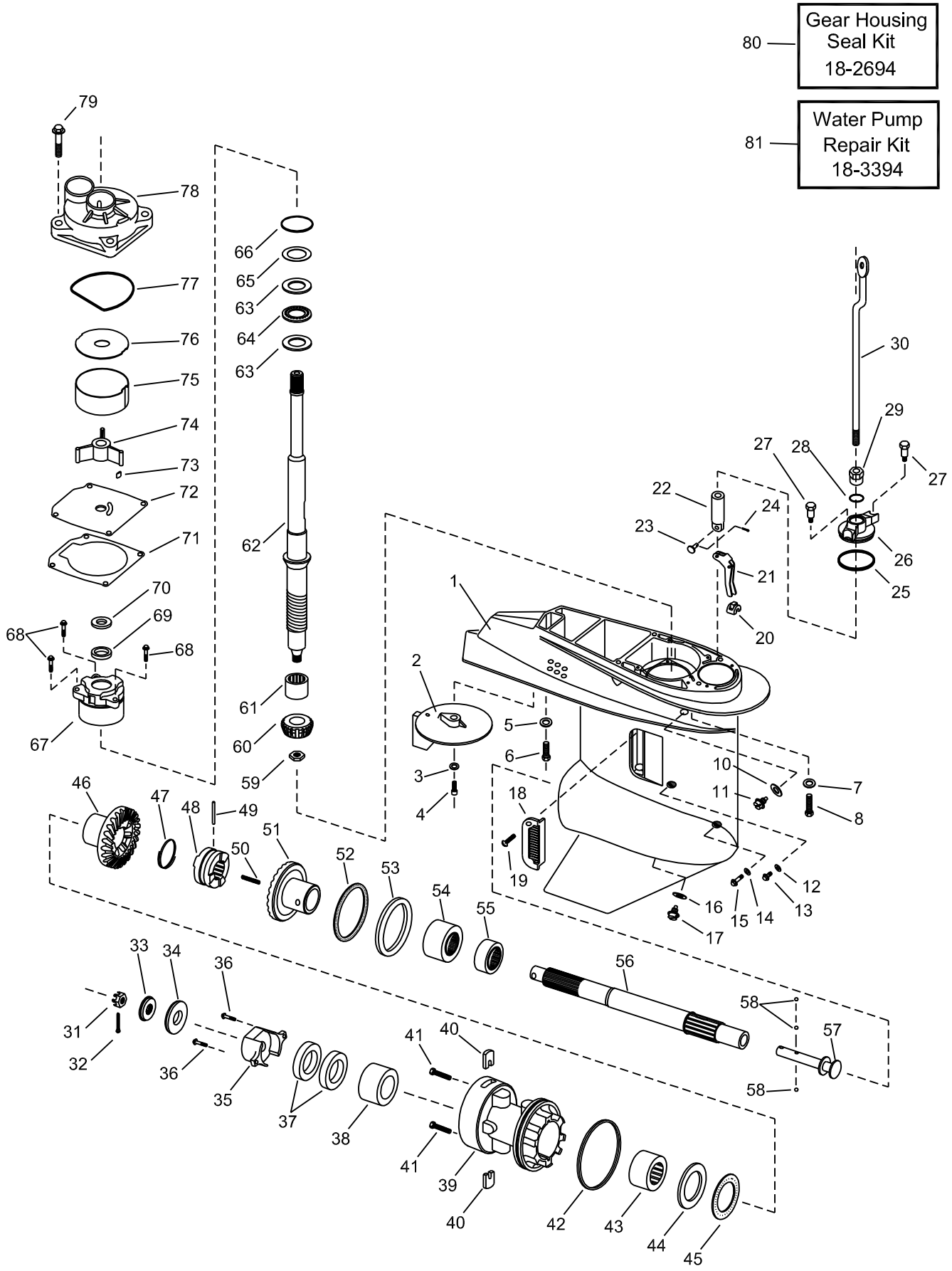
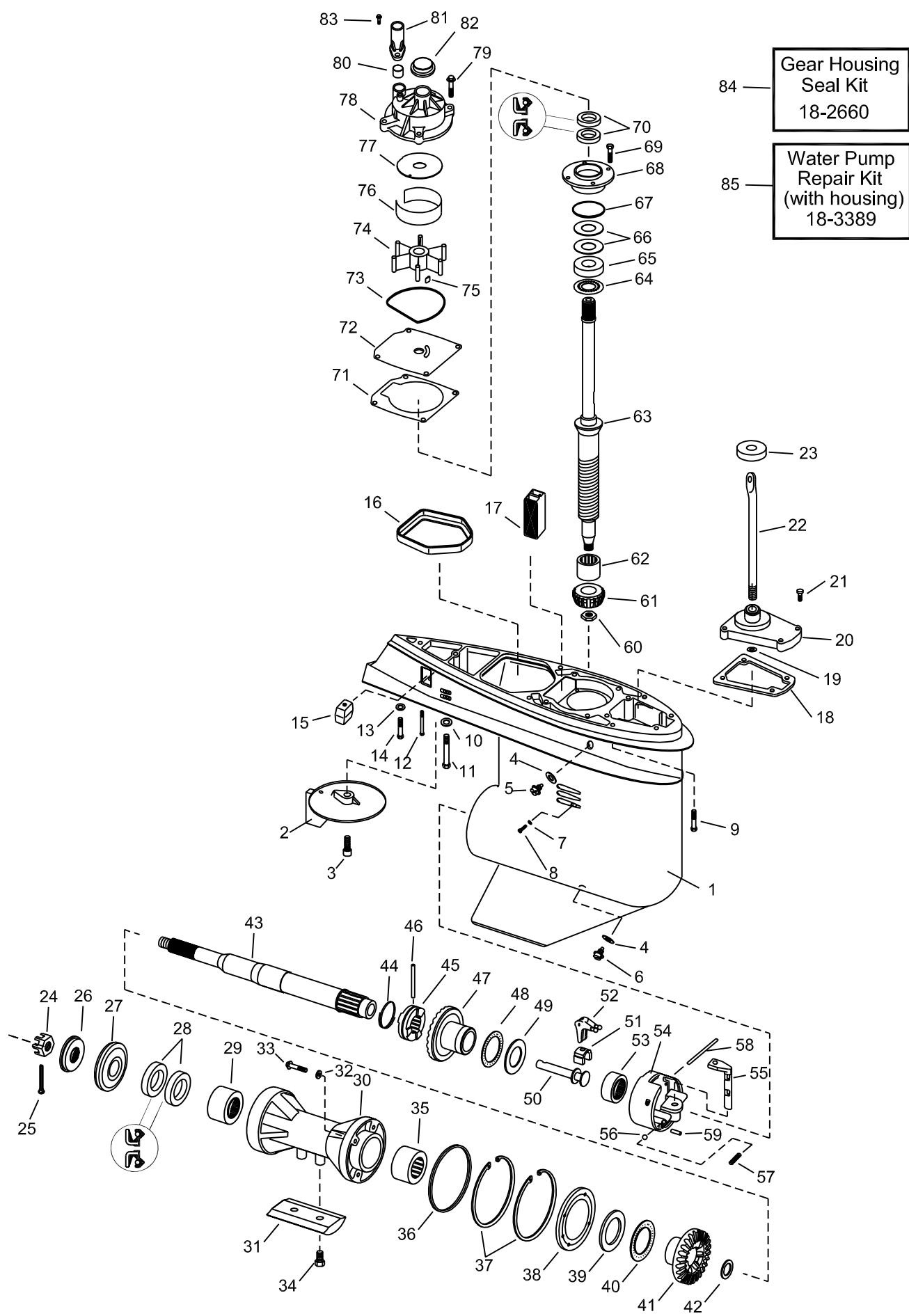

Figure #	Description	Part #	O.E.M. #	Qty.	Figure #	Description	Part #	O.E.M. #	Qty.
1	Gear Housing	—	434030	1	46	Screw, Screen Retaining	—	325539	2
2	Tube Water	—	395339	1	47	Washer, Thrust	—	327716	1
3	Grommet	18-3329	302497	1	48	Bearing, Thrust	—	388027	1
4	Housing, Water Pump	18-3367	393632	1	49	Washer, Thrust	—	330441	1
5	Tube, Extension	—	326692	1	50	Gear, Pinion	18-1288	328313	1
6	O-Ring	18-7105	311338	2	51	Bearing, Forward Gear	—	386186	1
7	Bolt, Water Pump Housing	—	328725	6	52	Gear, Forward	18-1287	392475	1
8	O-Ring	18-7146	554545	1	53	Clutch Sliding	18-1290	337020	1
9	Insert, Water Pump Housing	18-3358	328751	1	54	Spring, Detent	—	327070	1
10	Impeller	18-3051	395289	1	55	Ball, Detent	18-2243	316506	2
11	Key, Water Pump	18-3295	344470	1	56	Lever Shifter	—	337019	1
12	Bushing	—	328754	1	57	Cradle, Sliding Clutch	—	438311	1
13	O-Ring	18-7100	301877	1	58	Pin, Shift	—	302504	1
14	Seal, Spaghetti	18-2539	328753	1	59	Cotterpin, Shift Lever	—	303049	1
15	Plate, Wear	18-3359	328753	1	60	Yoke & Connector Assy.	—	390023	1
16	Gasket, Water Pump	18-0124	325537	1	61	Shaft, Propeller	—	439143	1
17	Drive Shaft (15")	—	341635	1	62	Gear, Reverse	18-1289	327655	1
	Drive Shaft (20")	—	341636	1	63	Bushing, Reverse Gear	—	319635	1
18	Seal Drive Shaft (upper)	18-2065	332261	1	64	Plate, Retainer	—	319746	1
19	Seal Drive Shaft (lower)	18-2033	321938	1	65	Ring, Retaining	—	319747	1
20	Bearing, Driveshaft	—	386473	1	66	Washer, Forward Gear Thrust	—	319684	1
21	Collar, Housing	—	322018	1	67	Bearing, Propshaft	—	437288	2
22	Bearing, Pinion	—	437288	2	68	O-Ring	18-2026	338518	1
23	Nut, Housing	—	306422	1	69	Seal	18-7475	332584	2
24	Washer, Locking	—	301250	1	70	Bolt, Carrier Retaining	—	319743	2
25	Bushing, Housing Alignment	—	319785	1	71	Carrier, Bearing	—	433428	1
26	Stud	—	320173	1	72	Seal, Propshaft	18-2026	321453	2
27	Connector, Shift	—	325624	1	73	Spacer, Prop	18-4232	335420	1
28	Shift Rod	—	331479	1	74	Prop Nut & Spacer	18-3707	319891	1
29	Keeper, Nylon Shift	—	325625	2	75	Cotter Pin, Prop Nut	18-3743	320785	1
30	Nut, Shiftshaft Retaining	—	331465	1	76	Gear Housing Seal Kit	18-2658	396351	1
31	Bushing	—	326361	1	77	Water Pump Kit	18-3382	393639	1
32	O-Ring	18-7180	303347	1					
33	O-Ring	18-7100	301877	1					
34	Washer, Expanding	18-0189	321738	1					
35	Anode Kit	—	434029	1					
36	Lockwasher	—	304454	1					
37	Bolt, Anode Retaining	—	333677	1					
38	Bolt, Trim Tab Retaining	—	329217	1					
39	Trim Tab	—	336203	1					
40	Bolt, Housing Retaining	—	328333	4					
41	Gasket, Drain Plug	18-4248	311598	2					
42	Plug, Drain	18-2387	307551	2					
43	Seal	18-7475	332584	1					
44	Pin, Shift Lever Pivot	—	308376	1					
45	Screen, Water Inlet	—	336202, 336206	2					



Complete Gear Housings Listed on Page 276



Complete Gear Housings Listed on Page 276

Figure #	Description	Part #	O.E.M. #	Qty.	Figure #	Description	Part #	O.E.M. #	Qty.
1	Housing Gearcase	—	392478	1	43	Propshaft	18-2250	439185, 439131	1
2	Trim Tab	—	318544	1					
3	Bolt, Trim Tab	—	313715	1	44	Retaining Spring	18-2399	324369	1
4	O-Rings, Drain Plugs	18-7145	333572	2	45	Clutch Sliding	18-2209	318303	1
5	Drain Fill Plug, Upper	18-2387	307551	1	46	Pin, Clutch Dog	18-1714	313448	1
6	Magnetic Drain Screw	18-2378	318544	1	47	Gear Set, Forward & Pinion	18-2207	397338	1
7	Seal	18-7475	332584	1	48	Thrust Bearing, Forward Gear	18-1371	385043	1
8	Bolt, Pinion Retaining	—	324852	1	49	Thrust Washer, Forward Gear	18-0198	324766	1
9	Bolt, Housing	—	308843	4	50	Shaft, Shifter	—	326668	1
10	Lockwasher	—	306314	1	51	Cradle, Shifter	18-3766	334163	1
11	Bolt, Long Gearcase	—	313697	1	52	Lever, Shift	—	324037	1
12	Bolt, Anode	—	328096	1	53	Bearing, Housing	NSS	NSS	
13	Lockwasher	—	306470	1	54	Bearing Housing Assy.	—	391365	1
14	Bolt, Short Gearcase	—	306503	1	55	Detent Shift	—	326670	1
15	Anode, Cavitation	18-6024	436745	1	56	Detent Ball	—	327345	1
16	Seal, Exhaust	18-2537	324937	1	57	Detent Spring	—	911961	1
17	Screen, Water Inlet	—	314175	1	58	Pin, Shifter Housing	—	320145	1
18	Gasket, Shiftshaft Housing	18-2855	314082	1	59	Pin, Housing	18-3765	331880	1
19	O-Rings, Shiftshaft	18-7137	318372	1	60	Nut, Pinion	—	313339	1
20	Shiftshaft Housing	—	388651	1	61	Gear, Pinion	NSS	NSS	
21	Bolt, Shiftshaft Housing	18-3133	302325	4	62	Bearing, Pinion	18-1356	382343	1
22	Shiftshaft	—	327337	1	63	Driveshaft(std)	—	437376	1
23	Slinger, Shift Arm	18-2706	321452	1	64	Bearing, Thrust	18-0194	317230	1
24	Nut, Propeller	18-3705	314503	1	65	Washer, Thrust	18-1367	385068	1
25	Cotter Pin, Prop Nut	18-3742	314502	1	66	Shim (.003)	18-2232	323889	AR
26	Spacer, Prop Nut	18-4228	315810	1	66	Shim (.004)	18-2233	323890	AR
27	Thrust Washer	18-4222	127084, 318841	1	66	Shim (.005)	18-2234	317232	AR
28	Outer Seal, Carrier	18-8326	330137	1	67	O-Ring Bearing Housing	18-7128	313754	1
28	Inner Seal, Carrier	18-2001	342787	1	68	Driveshaft Retaining Housing	—	385087	1
29	Carrier Bearing (Aft)	18-1350	379504	1	69	Bolt, Driveshaft Retaining	—	909386	4
30	Carrier Assembly	—	434391	1	70	Seal	18-8325	342786	1
31	Anode, Carrier	—	306470	1	71	Gasket, Water Pump	18-2709	336530	1
32	Seal	18-7475	332584	4	72	Plate, Impeller	18-3127	341038	1
33	Bolt, Carrier to Retainer	18-2379	320041	4	73	Seal, Water Pump Housing	18-7481	324981	1
34	Bolt, Carrier Anode	—	127466	2	74	Impeller	18-3053	396725	1
35	Carrier Bearing (Fore)	18-1351	382407	1	75	Key, Impeller	18-3138	334897	1
36	O-Ring , Bearing Housing	18-7127	313446	1	76	Liner, Water Pump Housing	—	321940	1
37	Retaining Rings	—	313445	2	77	Liner, Top Plate	18-3126	324980	1
38	Retaining Plate, Carrier	—	313453	1	78	Housing, Water Pump	18-3129	435673	1
39	Large Thrust Washer, Reverse Gear	18-0193	313447	1	79	Bolt, Water Pump Housing	18-3133	302325	1
40	Thrust Bearing, Reverse Gear	18-1366	382408	1	80	Seal, Guide tube	18-2703	314008	1
41	Gear, Reverse	18-2208	318304	1	81	Guide, Water Tube	—	319276	1
42	Small Thrust Washer, Reverse Gear	—	316484	1	82	Grommet	18-2705	342786	1
					83	Screw, Guide Tube	18-3153	908158	1
					84	Gear Housing Seal Kit	18-2660	396349	1
					85	Water Pump Repair Kit, Complete	18-3389	432955	1

AR As required

NSS Not Sold Separate

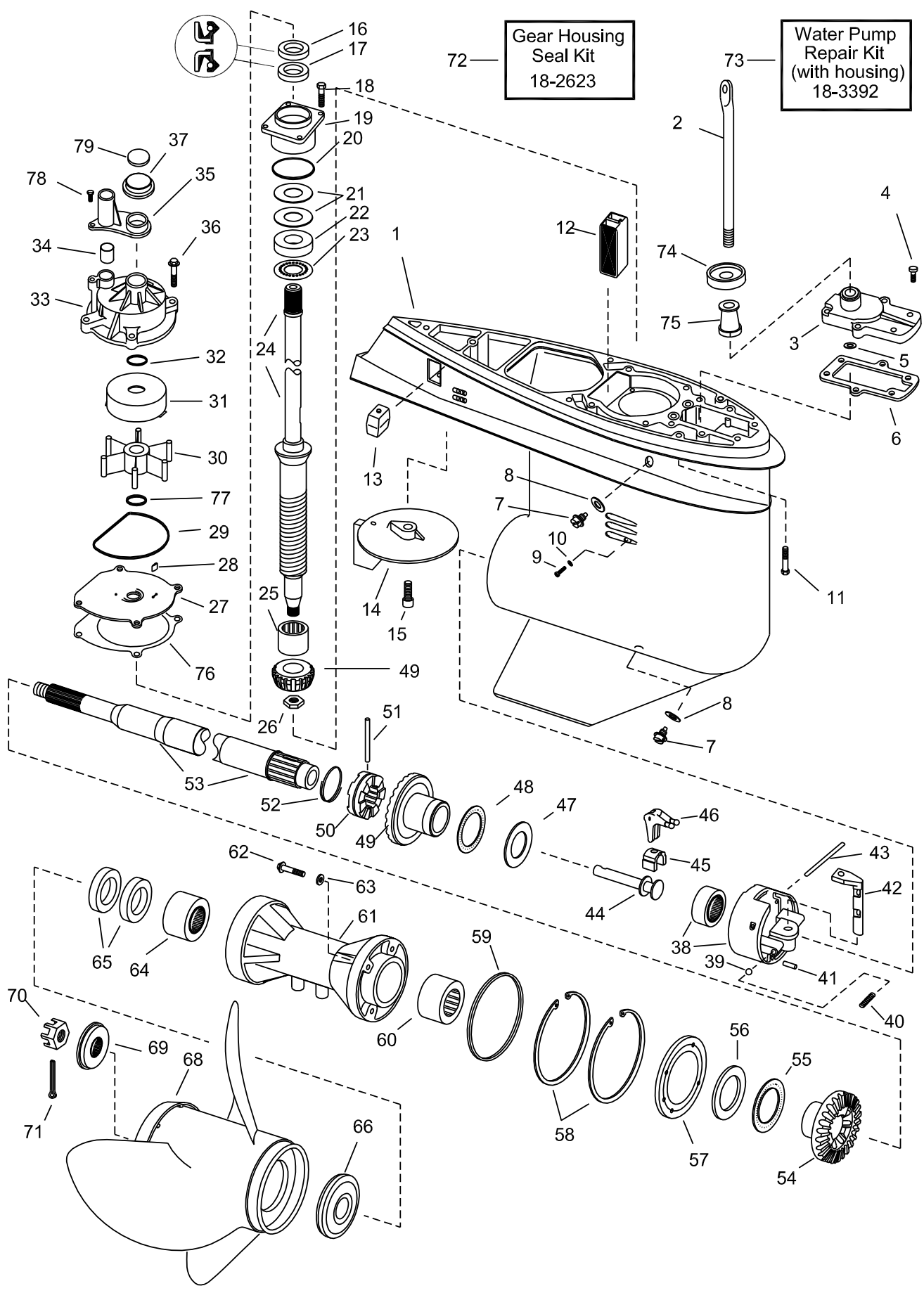

Complete Gear Housings Listed on Page 276

Figure #	Description	Part #	O.E.M. #	Qty.	Figure #	Description	Part #	O.E.M. #	Qty.
1	Housing Gearcase	—	431642	1	43	Pin, Shift Lever	—	320145	1
2	Shift Rod (long)	—	332120	1	44	Shift Shaft	18-3763	322941	1
	Shift Rod (x-long)	—	332121	1	45	Cradler, Shifter	18-3766	334163	1
3	Cover, Shift Rod	—	388618	1	46	Shift Lever	—	324037	1
4	Screw, Cover	18-3369	302325	6	47	Thrust Washer, Forward Gear	18-0198	324766	1
5	O-Ring, Shift Rod	18-7137	318372	1	48	Thrust Bearing, Forward Gear	18-1371	385043	1
6	Gasket, Shift Housing	18-0110	324670	1	49	Gear Set, Forward & Pinion	18-2218	398035	1
7	Magnetic Drain Screw	18-2378	318544	1	50	Sliding Clutch	18-2220	323664	1
8	O-Rings, Plugs	18-7145	333572	1	51	Pin, Clutch Dog	18-1714	313448	1
9	Screw	—	324852	1	52	Retaining Spring	18-2399	324369	1
10	O-Ring	18-7475	332584	1	53	Propeller Shaft	18-2252	387818	1
11	Screw, Gearcase to housing	—	331999	5	54	Gear, Reverse	18-2219	333077	1
12	Screen, Water intake	—	323466	1	55	Thrust Bearing, Reverse Gear	18-1366	382408	1
13	Anode	18-6024	393023	1	56	Thrust Washer, Reverse Gear	18-0195	314731	1
14	Trim Tab	—	327640	1	57	Retainer Plate/Bearing Housing	—	314732	1
15	Screw, Trim tab	—	313715	1	58	Retaining Rings	—	313445	2
16	Oil Seal, Upper	18-2061	329922	1	59	O-Ring, Bearing Housing	18-7127	313446	1
17	Oil Seal, Lower	18-2062	329923	1	60	Carrier Bearing (Fore)	18-1351	382407	1
18	Screw, Housing to gearcase	—	317624	4	61	Bearing Housing	—	397087	1
19	Bearing Housing	—	397493	1	62	Screw, Retainer	18-2377	316563	4
20	O-Ring Bearing Housing	18-7130	314728	1	63	O-Ring	18-7475	332583	1
21	Shim .003	18-2229	323362	AR	64	Roller Bearing (Aft)	18-1350	379504	1
	Shim .004	18-2230	323361	AR	65	Oil Seals, Prop Shaft	18-2001	330137	2
	Shim .005	18-2231	314745	AR	66	Thrust Washer	18-4222	318841	1
22	Thrust Washer, Pinion	18-0200	327656	1	68	Propeller	—	Various	1
23	Thrust Bearing, Pinion	18-1365	387656	1	69	Spacer, Prop Nut	18-4228	315810	1
24	Drive Shaft (long)	—	394613	1	70	Nut, Propeller	18-3705	314503	1
	Drive Shaft (x-long)	—	394614	1	71	Cotter Pin, Prop Nut	18-3742	314502	1
25	Bearing, Pinion	18-1357	384195	1	72	Gear Housing Seal Kit	18-2623	396354	1
26	Nut, Pinion	18-3719	314730	1	73	Water Pump Repair Kit (w/housing)	18-3392	395062	1
27	Wear Plate	18-3346	330380	1					
28	Key, Impeller	18-3299	331107	1	74	Grommet	18-2706	321008	1
29	Seal, Impeller Housing	18-7963	331353	1	75	Spacer, Shift rod	—	321122	1
30	Impeller	18-3059	395864	1	76	Gasket, Impeller housing plate	18-2557	324701	1
31	Cup, Impeller	18-3346	330379	1	77	O-Ring, Drive Shaft	—	302035	1
32	O-Ring, Drive Shaft	18-2769	332000	1	78	Screw, Cover to impeller	18-3135	306643	2
33	Housing, Water Pump	18-3130	395040	1	79	O-Ring, Driveshaft to crankcase	18-7158	310585	1
34	Grommet, Water Tube	18-2703	314008	1					
35	Pump cover	—	321159	1					
36	Screw, Impeller housing	—	328715	4					
37	Grommet	18-2704	320943	1					
38	Bearing Housing Assembly	—	391365	1					
39	Ball, Detent	—	327345	1					
40	Spring, Detent	—	326666	1					
41	Pin, Housing	18-3765	331880	1					
42	Detent, Shifter	—	323946	1					

AR As required

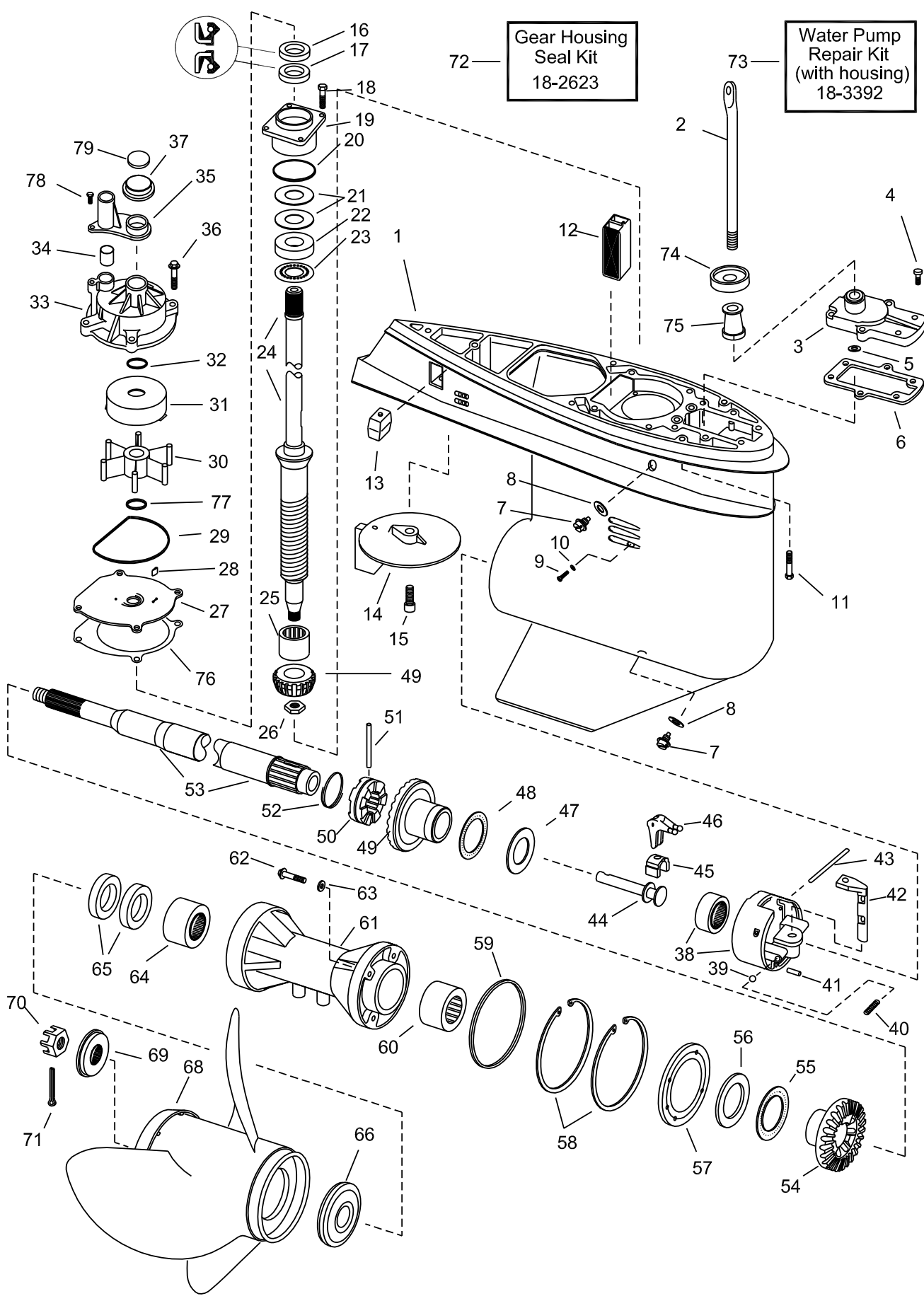

Complete Gear Housings Listed on Page 276

Figure #	Description	Part #	O.E.M. #	Qty.	Figure #	Description	Part #	O.E.M. #	Qty.
1	Housing Gearcase	—	438050	1	43	Pin, Shift Lever	—	328825	1
2	Shift Rod (long)	—	324407	1	44	Shift Shaft	18-3763	322941	1
2	Shift Rod (x-long)	—	324408	1	45	Cradler, Shifter	18-3766	334163	1
3	Cover & Shift Rod	—	435482	1	46	Shift Lever	18-3762	322938	1
4	Screw, Cover	18-3369	302325	6	47	Thrust Washer, Forward Gear	18-0199	327669	1
5	O-Ring, Shift Rod	18-7137	318372	1	48	Thrust Bearing, Forward Gear	18-1370	389042	1
6	Gasket, Shift Housing	18-0110	324670	1	49	Gear Set, Forward & Pinion	NSS	435020	1
7	Magnetic Drain Screw	18-2378	318544	2	50	Sliding Clutch	18-2216	337774	1
8	O-Rings, Plugs	18-7145	333572	2	51	Pin, Clutch Dog	18-1714	313448	1
9	Screw	—	324852	1	52	Retaining Spring	18-2399	324369	1
10	O-Ring	18-7120	307853	1	53	Propeller Shaft	18-2187	395209	1
11	Screw, Gearcase to housing	—	320741	5	54	Gear, Reverse	NSS	910994	1
12	Screen, Water intake	—	321123	1	55	Thrust Bearing, Reverse Gear	18-1366	382408	1
13	Anode	18-6024	393023	1	56	Thrust Washer, Reverse Gear	18-0195	314731	1
14	Trim Tab	—	327640	1	57	Retainer Plate/Bearing Housing	—	321174	1
15	Screw, Trim tab	—	313715	1	58	Retaining Rings	—	321171	2
16	Oil Seal, Upper	18-2061	329922	1	59	O-Ring, Bearing Housing	18-7133	305123	1
17	Oil Seal, Lower	18-2062	329923	1	60	Carrier Bearing (Fore)	18-1351	382407	1
18	Screw, Housing to gearcase	—	316534	4	61	Bearing Housing	—	397094	1
19	Bearing Housing	—	438963	1	62	Screw, Retainer	18-2377	316563	4
20	O-Ring Bearing Housing	18-7130	314728	1	63	O-Ring	18-7109	317178	1
21	Shim .003	18-2229	323362	AR	64	Roller Bearing (Aft)	18-1158	387247	1
21	Shim .004	18-2230	323361	AR	65	Oil Seals, Prop Shaft	18-2002	320862	2
21	Shim .005	18-2231	314745	AR	66	Thrust Washer	18-4223	333592	1
22	Thrust Washer, Pinion	18-0200	327656	1	68	Propeller	—	various	1
23	Thrust Bearing, Pinion	18-1365	387665	1	69	Spacer, Prop Nut	18-4231	320570	1
24	Drive Shaft (long)	see app chart	435755	1	70	Nut, Propeller	18-3708-1	398042	1
24	Drive Shaft (x-long)	see app chart	435756	1	71	Cotter Pin, Prop Nut	18-3741	306394	1
25	Bearing, Pinion	18-1117	387817	1	72	Gear Housing Seal Kit	18-2623	396353	1
26	Nut, Pinion	18-3719	314730	1	73	Water Pump Repair Kit (w/housing)	18-3392	434421	1
27	Cup & Plate Assembly	18-3346	330380	1					
28	Key, Impeller	18-3299	331107	1	74	Grommet	18-2706	321008	1
29	Seal, Impeller Housing	18-7963	331353	1	75	Spacer, Shift rod	—	321122	1
30	Impeller	18-3059	397131	1	76	Gasket, Impeller housing plate	18-2557	324701	1
31	Cup & Plate Assembly	18-3346	330379	1	77	O-Ring, Drive Shaft	18-7158	310585	1
32	O-Ring, Drive Shaft	18-7158	310585	1	78	Screw, Cover to impeller	18-3135	306643	2
33	Housing, Water Pump	18-3130	395040	1	79	O-Ring, Driveshaft to crankcase	18-7158	310585	1
34	Grommet, Water Tube	18-2703	314008	1					
35	Pump cover	—	321159	1					
36	Screw, Impeller housing	18-3136	323626	4					
37	Grommet	18-2704	320943	1					
38	Bearing Housing Assembly	18-3767	389455	1					
39	Ball, Detent	18-1501	160084	1					
40	Spring, Detent	18-1502	911962	1					
41	Pin, Housing	18-3765	331880	1					
42	Detent, Shifter	—	323946	1					

AR As required



18-4840^②
COMPLETE LOWER GEARCASE ASSEMBLIES
 Replaces: 435277
 Fits: 40/48/50hp w/20" Shaft (1989-92)



18-4841^②
COMPLETE LOWER GEARCASE ASSEMBLIES
 Replaces: 435276
 Fits: 40/48/50hp w/15" Shaft (1989-92)



18-4843^②
COMPLETE LOWER GEARCASE ASSEMBLIES
 Replaces: 435279
 Fits: 40/48/50hp w/15" Shaft (1993 and Up)



18-4800^②
COMPLETE LOWER GEARCASE ASSEMBLIES
 Replaces: 5004632
 Fits: V4 60 Degree w/ Tube (1995-03)
 w/o Upper Driveshaft



18-4801^②
COMPLETE LOWER GEARCASE ASSEMBLIES
 Replaces: 5000356
 Fits: 85-140hp Crossflow (1978-94)
 w/o Upper Driveshaft



18-4802^②
COMPLETE LOWER GEARCASE ASSEMBLIES
 Replaces: 5005401
 Fits: V6 (1978-91 Crossflow),
 (1991-present Eagle) w/o Upper Driveshaft

PKG. OF 5



18-2377
18-2377-9^①
RETAINER SCREW
 Replaces: 316563

PKG. OF 4



18-2379
18-2379-9^①
LOWER UNIT CARRIER SCREW
 Replaces: 320041



18-4826
GEARCASE TO HOUSING SCREW
 Replaces: 331999

PKG. OF 5



18-4253-9^①
18-42531-9^①
 (PKG. OF 50)
DRAIN SCREW O-RING
 Replaces: 336982
 Used w/ 18-1236 Drain Screw

PKG. OF 5



18-4248
18-4248-9^①
18-42481-9^①
 (PKG. OF 50)
DRAIN/FILL PLUG WASHER (Plastic)
 Replaces: 311598
 Used with 18-2387 Drain Screw

① Priced per package

② All gearcase assemblies pictured above are primed only. Be prepared to paint the gearcase to match your customer's engine.

<p>PKG. OF 2</p>  <p>18-2945 18-2945-9① 18-29451-9① (PKG. OF 50) DRAIN SCREW GASKET Replaces: 307552</p>	 <p>18-1236 DRAIN SCREW Replaces: 309243 For: 40-50 HP (1989-97) Cobra Drives</p>	 <p>18-2387 18-23871-9① (PKG. OF 50) LOWER UNIT DRAIN/FILL SCREW Slot Head</p>	 <p>18-4255 E-TEC DRAIN SCREW Replaces: 307551 Allan Head</p>																																																									
 <p>18-2378 18-23781-9① (PKG. OF 50) MAGNETIC DRAIN SCREW Slot Head</p>	 <p>18-4249 E-TEC DRAIN SCREW WITH MAGNET Replaces: 318544 Allan Head</p>	 <p>18-3708-1 PROP NUT & KEEPER Replaces: 398042</p>	<p>PKG. OF 5</p>  <p>PROP NUTS</p> <table border="1"> <thead> <tr> <th>PART #</th> <th>O.E. #</th> </tr> </thead> <tbody> <tr> <td>18-3705②</td> <td>314503</td> </tr> <tr> <td>18-3706②</td> <td>318971</td> </tr> <tr> <td>18-3707②</td> <td>319891</td> </tr> </tbody> </table>	PART #	O.E. #	18-3705 ②	314503	18-3706 ②	318971	18-3707 ②	319891																																																	
PART #	O.E. #																																																											
18-3705 ②	314503																																																											
18-3706 ②	318971																																																											
18-3707 ②	319891																																																											
<p>PKG. OF 10</p>  <p>COTTER PINS</p> <table border="1"> <thead> <tr> <th>PART #</th> <th>O.E. #</th> <th>DIMEN.</th> </tr> </thead> <tbody> <tr> <td>18-3735②</td> <td>5030087</td> <td>5/32" X 1 3/8"</td> </tr> <tr> <td>18-3740②</td> <td>302804</td> <td>3/32" X 1"</td> </tr> <tr> <td>18-3741②</td> <td>309955</td> <td>1/8" X 1 3/4"</td> </tr> <tr> <td>18-3742②</td> <td>314502</td> <td>1/8" X 1 1/4"</td> </tr> <tr> <td>18-3743②</td> <td>320785</td> <td>1/8" X 3/4"</td> </tr> <tr> <td>18-3744②</td> <td>552906</td> <td>3/32" X 3/4"</td> </tr> </tbody> </table>	PART #	O.E. #	DIMEN.	18-3735 ②	5030087	5/32" X 1 3/8"	18-3740 ②	302804	3/32" X 1"	18-3741 ②	309955	1/8" X 1 3/4"	18-3742 ②	314502	1/8" X 1 1/4"	18-3743 ②	320785	1/8" X 3/4"	18-3744 ②	552906	3/32" X 3/4"	<p>③18-3715D </p>  <p>18-3715 PROP NUT KIT Replaces: 175266 — CONTAINS —</p> <table border="1"> <thead> <tr> <th>Part #</th> <th>O.E. #</th> <th>Description</th> </tr> </thead> <tbody> <tr> <td>18-3708-1</td> <td>398042</td> <td>Prop Nut/Keeper</td> </tr> <tr> <td>18-3741</td> <td>309955</td> <td>Cotter Pin</td> </tr> <tr> <td>18-4231</td> <td>320570</td> <td>Prop Spacer</td> </tr> </tbody> </table>	Part #	O.E. #	Description	18-3708-1	398042	Prop Nut/Keeper	18-3741	309955	Cotter Pin	18-4231	320570	Prop Spacer	<p>③18-3716D </p>  <p>18-3716 PROP NUT KIT Replaces: 175267 — CONTAINS —</p> <table border="1"> <thead> <tr> <th>Part #</th> <th>O.E.#</th> <th>Description</th> </tr> </thead> <tbody> <tr> <td>18-3705</td> <td>314503</td> <td>Prop Nut</td> </tr> <tr> <td>18-3742</td> <td>314502</td> <td>Cotter Pin</td> </tr> <tr> <td>18-4228</td> <td>315810</td> <td>Prop Spacer</td> </tr> </tbody> </table>	Part #	O.E.#	Description	18-3705	314503	Prop Nut	18-3742	314502	Cotter Pin	18-4228	315810	Prop Spacer	<p>③18-3717D </p>  <p>18-3717 PROP NUT KIT Replaces: 175268 — CONTAINS —</p> <table border="1"> <thead> <tr> <th>Part #</th> <th>O.E. #</th> <th>Description</th> </tr> </thead> <tbody> <tr> <td>18-3707</td> <td>319891</td> <td>Prop Nut</td> </tr> <tr> <td>18-3743</td> <td>320785</td> <td>Cotter Pin</td> </tr> <tr> <td>18-4232</td> <td>323943</td> <td>Prop Spacer</td> </tr> </tbody> </table>	Part #	O.E. #	Description	18-3707	319891	Prop Nut	18-3743	320785	Cotter Pin	18-4232	323943	Prop Spacer
PART #	O.E. #	DIMEN.																																																										
18-3735 ②	5030087	5/32" X 1 3/8"																																																										
18-3740 ②	302804	3/32" X 1"																																																										
18-3741 ②	309955	1/8" X 1 3/4"																																																										
18-3742 ②	314502	1/8" X 1 1/4"																																																										
18-3743 ②	320785	1/8" X 3/4"																																																										
18-3744 ②	552906	3/32" X 3/4"																																																										
Part #	O.E. #	Description																																																										
18-3708-1	398042	Prop Nut/Keeper																																																										
18-3741	309955	Cotter Pin																																																										
18-4231	320570	Prop Spacer																																																										
Part #	O.E.#	Description																																																										
18-3705	314503	Prop Nut																																																										
18-3742	314502	Cotter Pin																																																										
18-4228	315810	Prop Spacer																																																										
Part #	O.E. #	Description																																																										
18-3707	319891	Prop Nut																																																										
18-3743	320785	Cotter Pin																																																										
18-4232	323943	Prop Spacer																																																										
 <p>18-3768 COVER NUT Replaces: 911751 For: Cobra drives: 115 (1994-97), 232 (1987-90), 252 (1986), 262 (1989), 302 (1987)</p>	 <p>18-4222 THRUST WASHER Replaces: 318841, 127084</p>	 <p>18-4223 THRUST WASHER Replaces: 333592</p>	 <p>18-4228 PROP SPACER Replaces: 315810</p>																																																									
 <p>18-4229 THRUST WASHER Replaces: 319890</p>	 <p>18-4230 THRUST WASHER Replaces: 320305</p>	 <p>18-4231 PROP SPACER Replaces: 320570</p>	 <p>18-4232 PROP SPACER Replaces: 323943</p>																																																									

APPLICATION ON NEXT PAGE

① Priced per package

② This product is priced per piece. To order priced per package, please add -9 to the part number.

③ Items ending in "D" are Display Packaged - Regular number is Non-Display

JOHNSON/EVINRUDE						
HP	Year	Spacer Before Prop	Washer After Prop	Prop Nut	Cotter Pin	Prop Nut Kit
9.9/15	1974-75	—	—	18-3706	18-3740	—
9.9/15	1976-99	—	—	18-3706	18-3744	—
20	1984-90	18-4229	18-4232	18-3707	18-3743	18-3717
20/30/35	1991-99	—	18-4232	18-3707	18-3743	18-3717
25 ⑥	1991	—	18-4232	18-3707	18-3743	18-3717
25 ⑦	1991	18-4232	18-4228	18-3705	18-3742	18-3716
25 ⑧	1992	—	18-4232	18-3707	18-3743	18-3717
25/30	1984-90	18-4229	18-4232	18-3707	18-3743	18-3717
35	1976-90	18-4229	18-4232	18-3707	18-3743	18-3717
40 ① ④	1984-99	18-4230	18-4228	18-3705	18-3742	18-3716
40 Comm	1996-97	18-4222	18-4228	18-3705	18-3742	18-3716
40 Comm	1998-99	—	18-4228	18-3705	18-3742	18-3716
45 Comm ②	1986-97	—	18-4228	18-3705	18-3742	18-3716
48 ①	1987-96	18-4230	18-4228	18-3705	18-3742	18-3716
50/60 TTL	1996-98	18-4222	18-4228	18-3705	18-3742	18-3716
50 ②	1971-74	18-4222	18-4228	18-3705	18-3742	18-3716
50 ① ④	1975-99	18-4230	18-4228	18-3705	18-3742	18-3716
50 EL&DT	1996-98	—	18-4228	18-3705	18-3742	18-3716
50 Comm ②	1977-79	18-4222	18-4228	18-3705	18-3742	18-3716
55	1968-69	18-4222	18-4228	18-3705	18-3742	18-3716
55 ①	1976-79	18-4230	18-4228	18-3705	18-3742	18-3716
55 Comm ②	1980-97	18-4222	18-4228	18-3705	18-3742	18-3716
55 Comm	1998-99	—	18-4228	18-3705	18-3742	18-3716
60/70 ④	1996-99	—	18-4228	18-3705	18-3742	18-3716
60	1970-71, 1986-95	18-4222	18-4228	18-3705	18-3742	18-3716
60 ①	1980-85	18-4230	18-4228	18-3705	18-3742	18-3716
65	1972-73	18-4222	18-4228	18-3705	18-3742	18-3716
65 Comm	1984-95	18-4222	18-4228	18-3705	18-3742	18-3716
65 Comm	1996-99	—	18-4228	18-3705	18-3742	18-3716
70	1974-95	18-4222	18-4228	18-3705	18-3742	18-3716
75 ②	1975-84	18-4222	18-4228	18-3705	18-3742	18-3716
75 ①	1975-85	18-4230	18-4228	18-3705	18-3742	18-3716
Formula E	1986-90	18-4230	18-4228	18-3705	18-3742	18-3716
Sprint	1986-90	18-4230	18-4228	18-3705	18-3742	18-3716
85	1969-80, 1995	18-4222	18-4228	18-3705	18-3742	18-3716
88/90	1981-95	18-4222	18-4228	18-3705	18-3742	18-3716
88	1996	—	18-4228	18-3705	18-3742	18-3716
90 ① ④	1996-99	—	18-4228	18-3705	18-3742	18-3716
90 ②	1996	—	18-4231	18-3708-1	—	—
90 V-4 ④	1997-99	—	18-4228	18-3705	18-3742	18-3716
90 V-4 ② ④	1997	18-4223	18-4231	18-3708-1	—	—
90 FSX/ FPX ④	1998-99	18-4223	18-4231	18-3708-1	—	—
100	1979-80	18-4222	18-4228	18-3705	18-3742	18-3716
100 ⑨	1988-94	18-4222	18-4228	18-3705	18-3742	18-3716
100 ⑩	1992	—	18-4231	18-3708-1	—	—
100 Comm ④	1996, 1998	—	18-4228	18-3705	18-3742	18-3716
100 Comm	1995-97, 1999	18-4223	18-4231	18-3708-1	—	—
100 Comm ③	1984-90	18-4223	18-4231	18-3708-1	18-3741	18-3715
110	1986-89	18-4222	18-4228	18-3705	18-3742	18-3716
112	1996	—	18-4228	18-3705	18-3742	18-3716
115	1973-94	18-4222	18-4228	18-3705	18-3742	18-3716
115 ① ④	1996-99	—	18-4228	18-3705	18-3742	18-3716
115 ②	1996	—	18-4231	18-3708-1	—	—
115 V-4 ④	1997-99	—	18-4228	18-3705	18-3742	18-3716
115 V-4 ② ④	1997	18-4223	18-4231	18-3708-1	—	—
115 FSX/ FPX ④	1998-99	18-4223	18-4231	18-3708-1	—	—
120 ③	1985	18-4223	18-4231	18-3708-1	18-3741	18-3715

APPLICATION CONTINUED ON NEXT PAGE

- ① Models equipped with small gearcase
- ② Models equipped with large gearcase
- ③ Models equipped with V-6 gearcase
- ④ For 3-Blade propeller only
- ⑤ Use 18-4222 for 4-Blade propeller

- ⑥ All models except DR, DE & DT
- ⑦ Models DR, DE & DT only
- ⑧ Except models RSU, RSLU, RWENB, RWLENB
- ⑨ Except 1992 models WTLNE, WTXNENE
- ⑩ Models WTLNE, WTXNENE

- ① 1992 ES models only
- ② Except 1992 ESX models
- ③ 1992 TL models only
- ④ 1992 CX, TX models only

JOHNSON/EVINRUDE						
HP	Year	Spacer Before Prop	Washer After Prop	Prop Nut	Cotter Pin	Prop Nut Kit
120	1986-94	18-4222	18-4228	18-3705	18-3742	18-3716
125 ①	1971-94	18-4222	18-4228	18-3705	18-3742	18-3716
125 ②	1992	—	18-4231	18-3708-1	—	—
125 Comm	1991	—	18-4231	18-3708-1	18-3741	18-3715
125 Comm	1992-96	18-4223	18-4231	18-3708-1	—	—
130	1995-99	18-4223	18-4231	18-3708-1	—	—
135	1973-76	18-4222	18-4228	18-3705	18-3742	18-3716
140	1977-84	18-4222	18-4228	18-3705	18-3742	18-3716
140 ③	1985	18-4223	18-4231	18-3708-1	18-3741	18-3715
140 ④	1986-94	18-4222	18-4228	18-3705	18-3742	18-3716
140 ③	1990	18-4223	18-4231	18-3708-1	18-3741	18-3715
140 ④	1992	—	18-4231	18-3708-1	—	—
150	1978-90	18-4223	18-4231	18-3708-1	18-3741	18-3715
150	1991-95	—	18-4231	18-3708-1	18-3741	18-3715
150 ④	1996-99	18-4223	18-4231	18-3708-1	—	—
155 Comm	1984-90	18-4223	18-4231	18-3708-1	18-3741	18-3715
155 Comm	1991-95	—	18-4231	18-3708-1	18-3741	18-3715
175	1977-90	18-4223	18-4231	18-3708-1	18-3741	18-3715
175	1992	—	18-4231	18-3708-1	—	—
175 ④	1993-99	18-4223	18-4231	18-3708-1	—	—
185	1984-85	18-4223	18-4231	18-3708-1	18-3741	18-3715
185 Comm ④	1991-95	—	18-4231	18-3708-1	18-3741	18-3715
200	1976-90	18-4223	18-4231	18-3708-1	18-3741	18-3715
200/225 ④	1991-95	—	18-4231	18-3708-1	18-3741	18-3715
200/225 ④	1996-99	18-4223	18-4231	18-3708-1	—	—
225	1986-90	18-4223	18-4231	18-3708-1	18-3741	18-3715
235	1978-85	18-4223	18-4231	18-3708-1	18-3741	18-3715
250/300	1991	18-4223 ⑤	18-4231	18-3708-1	18-3741	18-3715
250/300	1992	—	18-4231	18-3708-1	—	—
250/300 ④	1993-95	18-4223	18-4231	18-3708-1	—	—
250	1996-99	18-4223	18-4231	18-3708-1	—	—
2.6L	1984-85	18-4223	18-4231	18-3708-1	18-3741	18-3715
275	1986	18-4223	18-4231	18-3708-1	18-3741	18-3715
3.6L	1986-90	18-4223	18-4231	18-3708-1	18-3741	18-3715

OMC SEA DRIVE						
V4	1982-90	18-4222	18-4228	18-3708-1	18-3742	18-3715
V6	1982-90	18-4223	18-4231	18-3708-1	18-3741	18-3715
V8	1987, 1989-90	18-4223	18-4231	—	—	—

- | | | |
|---------------------------------------|--|---------------------------|
| ① Models equipped with small gearcase | ⑥ All models except DR, DE & DT | ① 1992 ES models only |
| ② Models equipped with large gearcase | ⑦ Models DR, DE & DT only | ② Except 1992 ESX models |
| ③ Models equipped with V-6 gearcase | ⑧ Except models RSU, RSLU, RWENB, RWLENB | ③ 1992 TL models only |
| ④ For 3-Blade propeller only | ⑨ Except 1992 models WTLNE, WTXNENE | ④ 1992 CX, TX models only |
| ⑤ Use 18-4222 for 4-Blade propeller | ⑩ Models WTLNE, WTXNENE | |

 <p>18-8304 OIL SEAL Replaces: 321830</p>	 <p>18-0195 THRUST WASHER Reverse & Forward Gear Replaces: 314731 For: 45-60 HP - 2 Cyl, 3 Cyl, V-4 & V-6</p>	 <p>18-0197 THRUST WASHER Forward Gear Replaces: 333725 For: 40-55 HP - 1989-1995</p>	 <p>18-0198 THRUST WASHER Forward Gear Replaces: 324766 For: 3 Cyl, V-4 & V-6</p>
 <p>18-0200 THRUST WASHER Drive Shaft Replaces: 327656 For: V-4 & V-6</p>	 <p>18-0201 THRUST WASHER Drive Shaft Replaces: 333771 For: 40-60 HP - 1990-1995</p>	 <p>18-1117 PINION BEARING Replaces: 387817</p>	 <p>18-1154 BALL BEARING Replaces: 377139</p>



**18-1158
CARRIER BEARING**
Replaces: 387247



**18-1161
TAPERED ROLLER BEARING**
Replaces: 983891



**18-1299
LOWER MAIN BEARING**
Replaces: 433503
For: V4 & V6 60° engines



**18-1344
NEEDLE BEARING**
Ref. # J-1812
Fits: Driveshaft bearing cup 18-4807
(OE# 439476)



**18-1350
NEEDLE BEARING
(CARRIER)**
Replaces: 379504



**18-1351
NEEDLE BEARING
(CARRIER)**
Replaces: 382407



**18-1354
NEEDLE BEARING**
Replaces: 386764



**18-1355
NEEDLE BEARING**
Replaces: 386765



**18-1356
NEEDLE BEARING
(PINION)**
Replaces: 382343



**18-1357
NEEDLE BEARING
(PINION)**
Replaces: 384195



**18-1363
THRUST BEARING**
Replaces: 397537



**18-1364
THRUST BEARING**
Replaces: 397538



**18-1365
THRUST BEARING**
Replaces: 387656



**18-1366
THRUST BEARING**
Replaces: 382408



**18-1367
THRUST BEARING**
Replaces: 385068



**18-1368
THRUST BEARING**
Replaces: 398901



**18-1369
THRUST BEARING**
Replaces: 432264



**18-1370
THRUST FORWARD
BEARING**
Replaces: 389042



**18-1371
THRUST FORWARD
BEARING**
Replaces: 385043

APPLICATION BEGINS ON NEXT PAGE

HP	Year	Drive Shaft Bearing	Pinion Gear Bearing	Fore Carrier Bearing	Aft Carrier Bearing	Fwd. Gear Thrust Bearing	Rev Gear Thrust Bearing	Fore Propshaft Bearing	Aft. Propshaft Bearing
25D	1989-95	18-1368	18-1356	18-1354	18-1355	18-1364	18-1363	18-1369	18-1351
35	1987	—	—	18-1354	18-1355	—	—	—	—
40	1984-88	—	—	18-1354	18-1355	—	—	—	—
40	1989-Up	18-1368	18-1356	18-1354	18-1355	18-1364	18-1363	18-1369	18-1351
45 Comm	1985-Up	—	18-1367	18-1356	18-1351	18-1350	18-1371	18-1366	—
48	1987-88	—	—	18-1354	18-1355	—	—	—	—
48	1989-96	18-1368	18-1356	18-1354	18-1355	18-1364	18-1363	18-1369	18-1351
50	1973-74	18-1367	18-1356	18-1351	18-1350	18-1366	18-1366	—	—
50	1975	—	—	18-1354	18-1355	—	—	—	—
50	1979-88	—	—	18-1354	18-1355	—	—	—	—
50	1989-Up	18-1368	18-1356	18-1354	18-1355	18-1364	18-1363	18-1369	18-1351
50 ①	1995-Up	18-1367	18-1356	18-1351	18-1350	18-1371	18-1366	—	—
55	1976-81	—	—	18-1354	18-1355	—	—	—	—
55 ②	1980-82	18-1367	18-1356	18-1351	18-1350	18-1366	18-1366	—	—
55 Comm	1983-Up	—	18-1367	18-1356	18-1351	18-1350	18-1371	18-1366	—
60 ②	1980-81	18-1367	18-1356	18-1351	18-1350	18-1366	18-1366	—	—
60	1980-85	—	—	18-1354	18-1355	—	—	—	—
60 ③	1986-87	—	—	18-1354	18-1355	—	—	—	—
60 ④	1986-97	18-1367	18-1356	18-1351	18-1350	18-1371	18-1366	—	—
65	1973	18-1367	18-1356	18-1351	18-1350	18-1371	18-1366	—	—
65 Comm	1984-97	—	18-1367	18-1356	18-1351	18-1350	18-1371	18-1366	—
70 ④	1974-97	18-1367	18-1356	18-1351	18-1350	18-1371	18-1366	—	—
70 ③	1979-85	—	—	18-1354	18-1355	—	—	—	—
75 ④	1975-88	18-1367	18-1356	18-1351	18-1350	18-1371	18-1366	—	—
75 ③	1979-87	—	—	18-1354	18-1355	—	—	—	—
85	1973-80	18-1365	18-1357	18-1351	18-1350	18-1371	18-1366	—	—
85	1991-95	18-1365	18-1357	18-1351	18-1350	18-1371	18-1366	—	—
88	1987-96	18-1365	18-1357	18-1351	18-1350	18-1371	18-1366	—	—
90	1981-97	18-1365	18-1357	18-1351	18-1350	18-1371	18-1366	—	—
100	1979-80	18-1365	18-1357	18-1351	18-1350	18-1371	18-1366	—	—
100	1990-94	18-1365	18-1357	18-1351	18-1350	18-1371	18-1366	—	—
100 Comm	1984-90	—	18-1365	18-1117	18-1351	18-1158	18-1370	18-1366	—
100 Comm ⑧	1989-90	—	18-1365	18-1357	18-1351	18-1350	18-1371	18-1366	—
100 Comm	1991-93	—	18-1365	18-1117	18-1351	—	18-1370	18-1366	—
110	1986-89	18-1365	18-1357	18-1351	18-1350	18-1371	18-1366	—	—
112	1994-95	18-1365	18-1357	18-1351	18-1350	18-1371	18-1366	—	—
115	1973-85	18-1365	18-1357	18-1351	18-1350	18-1371	18-1366	—	—
115	1990-95	18-1365	18-1357	18-1351	18-1350	18-1371	18-1366	—	—
120	1985	18-1365	18-1117	18-1351	18-1158	18-1370	18-1366	—	—
120	1986-92	18-1365	18-1357	18-1351	18-1350	18-1371	18-1366	—	—
125 Comm ⑤	1989-90	—	18-1365	18-1117	18-1351	18-1158	18-1370	18-1366	—
125 Comm ⑥	1989-90	—	18-1365	18-1357	18-1351	18-1350	18-1371	18-1366	—
125 Comm	1991-94	—	18-1365	18-1117	18-1351	—	18-1370	18-1366	—
125	1992	18-1365	18-1357	18-1351	18-1350	18-1371	18-1366	—	—
135	1973-76	18-1365	18-1357	18-1351	18-1350	18-1371	18-1366	—	—
140	1977-84	18-1365	18-1357	18-1351	18-1350	18-1371	18-1366	—	—
140	1985	18-1365	18-1117	18-1351	18-1158	18-1370	18-1366	—	—
140	1986-92	18-1365	18-1357	18-1351	18-1350	18-1371	18-1366	—	—
140 TX	1988-90	18-1365	18-1117	18-1351	18-1158	18-1370	18-1366	—	—
140 TX	1991-92	18-1365	18-1117	18-1351	—	18-1370	18-1366	—	—
150	1978-90	18-1365	18-1117	18-1351	18-1158	18-1370	18-1366	—	—
150	1991-95	18-1365	18-1117	18-1351	—	18-1370	18-1366	—	—
150 Comm	1993-95	—	18-1365	18-1117	18-1351	—	18-1370	18-1366	—
155 Comm	1984-90	—	18-1365	—	18-1351	18-1158	—	18-1366	—
155 Comm ⑤	1989-90	18-1365	18-1117	18-1351	18-1158	18-1370	18-1366	—	—
155 Comm ⑦	1989-90	18-1365	18-1117	18-1351	18-1158	18-1370	18-1366	—	—
175	1977	18-1365	18-1117	18-1351	18-1158	—	18-1366	—	—
175	1978-90	18-1365	18-1117	18-1351	18-1158	18-1370	18-1366	—	—
175	1991-97	18-1365	18-1117	18-1351	—	18-1370	18-1366	—	—
185	1984-85	18-1365	18-1117	18-1351	18-1158	18-1370	18-1366	—	—
185	1990	18-1365	18-1117	18-1351	18-1158	18-1370	18-1366	—	—
185	1992-94	18-1365	18-1117	18-1351	—	18-1370	18-1366	—	—
200	1976-77	18-1365	18-1117	18-1351	18-1158	—	18-1366	—	—
200	1978-90	18-1365	18-1117	18-1351	18-1158	18-1370	18-1366	—	—
200	1991-97	18-1365	18-1117	18-1351	—	18-1370	18-1366	—	—
200 Comm	1990-91	—	18-1365	18-1117	18-1351	18-1158	18-1370	18-1366	—
225	1986-90	18-1365	18-1117	18-1351	18-1158	18-1370	18-1366	—	—
225	1991-97	18-1365	18-1117	18-1351	—	18-1370	18-1366	—	—
235	1978-85	18-1365	18-1117	18-1351	18-1158	18-1370	18-1366	—	—

① 3 Cyl. Models

② Rope Start Models

③ 15" Transom Models

④ 20" Transom Models

⑤ WTP Models

⑥ ESX Models

⑦ WTA Models Only

⑧ Models with "S" Prefix Only

OUTBOARD SHAFTS



18-1723
LOWER DRIVE SHAFT
 Replaces: 346004
 For: V4 60° includes: E100, E115, E75, E 90, J115 & J90



18-2277
LOWER DRIVE SHAFT
 Replaces: 335722



18-2279
LOWER DRIVE SHAFT
 Replaces: 335679



18-9219
LOWER DRIVE SHAFT
 Replaces: 335677



18-1722
DRIVE SHAFT
 Replaces: 438399
 For: 20" Models, 40-50HP (1997-99)



18-1721
DRIVE SHAFT
 Replaces: 433067
 For: 20" Models, 40-50(1989-92)



18-2327
UPPER DRIVE SHAFT ASSEMBLY
 Replaces: 436234



18-2326
UPPER DRIVE SHAFT ASSEMBLY
 Replaces: 436232



18-2330
UPPER DRIVE SHAFT ASSEMBLY
 (Extra Long)
 Replaces: 436235



18-1732
DRIVE SHAFT RETAINER
 Replaces: 338504
 For: V4 & V6 driveshafts



18-2093
SEAL
 Replaces: 398051
 For: 20 - 35 HP(1977-95) seal for propshaft 18-2026, driveshaft 18-2033, upper crankcase 18-8351

APPLICATION BEGINS ON NEXT PAGE

HP	Year	Lower Drive Shaft	Upper Drive Shaft	Upper Drive Shaft (Extra Long)	HP	Year	Lower Drive Shaft	Upper Drive Shaft	Upper Drive Shaft (Extra Long)
85 TTL	1991	18-2277	18-2325	—	140 TX	1990-91	18-9219	—	—
85 TTL	1992-95	18-2277	18-2326	—	140 TL	1991-94	18-2277	18-2326	—
88	1991	18-2277	18-2325	—	140 TX	1992-94	18-9219	—	—
88	1992-96	18-2277	18-2326	—	150	1990	18-9219	—	—
90	1991	18-2277	18-2325	—	150	1991	18-9219	18-2325	—
90	1992-97	18-2277	18-2326	—	150	1992-97	18-9219	18-2327	18-2330
90 ① ②	1995-96	—	18-2327	—	150 Comm	1993-95	18-9219	18-2327	18-2330
90 ② ③	1995-96	18-9219	—	18-2330	155 Comm	1990	18-2279③	—	—
90 ②	1997	18-2277	18-2326	—	155 Comm ⑤	1990	18-9219	—	—
100	1991	18-2277	18-2325	—	155 Comm	1991	18-9219	18-2325	—
100	1992-94	18-2277	18-2326	—	155 Comm	1992	18-9219	18-2326	—
100 Comm	1991	18-9219	—	—	175	1990	18-9219	—	—
100 Comm	1992-97	18-9219	18-2326	—	175	1991	18-9219	18-2325	—
112	1994-96	18-2277	18-2326	—	175	1992-97	18-9219	18-2327	18-2330
115	1991	18-2277	—	—	185	1990	18-9219	—	—
115	1992-97	18-2277	18-2326	—	185	1991	18-9219	18-2325	—
115 ① ②	1995-96	—	18-2327	—	185	1992-94	18-9219	18-2326	—
115 ② ③	1995-96	18-9219	—	18-2330	200	1990	18-9219	—	—
115 ②	1997	18-2277	18-2326	—	200	1991	18-9219	18-2325	—
120	1991-93	18-2277	18-2325	—	200	1992-97	18-9219	18-2326	—
120 ④	1993	18-9219	—	—	200 Comm	1990	18-9219	—	—
120 TL	1994	18-2277	18-2326	—	225	1990	18-9219	—	—
120 TX	1994	18-9219	—	—	225	1991	18-9219	18-2325	—
125 Comm	1991-95	18-9219	18-2326	—	225	1992-97	18-9219	18-2326	—
125	1992-93	18-2277	18-2325	—	250	1991-95	18-2279	—	—
125 ④	1993	18-9219	—	—	250	1997	18-2279	—	—
125	1994	18-2277	18-2326	—	300	1990	18-2279	—	—
130	1995-97	18-9219	18-2326	—	300	1991-95	18-2279	—	—

① 20" Models ② 60 Degree V Models ③ 25" Models ④ F Suffix Only ⑤ WTP Models Only



**18-1725
PROP SHAFT**
Replaces: 436834
For: V4 60HP



**18-2187
PROP SHAFT**
Replaces: 395209, 391472



**18-2250
PROP SHAFT**
Replaces: 387879



**18-2251
PROP SHAFT**
Replaces: 435022, 433017, 436740



**18-2252
PROP SHAFT**
Replaces: 387818, 436888



**18-2355
PROP SHAFT**
Replaces: 386659
For: 35, 40, 48, 50, 55, 60, 70, 75 HP 2 & 3 cyl. outboards (1975-1987)



**18-2288
PROP SHAFT**
Replaces: 397541, 439138

PROP SHAFT APPLICATION BEGINS ON PAGE 286



**18-1287
FORWARD GEAR & BUSHING**
Replaces: 392475
For: 25-35HP (1975-88)



**18-1291
GEAR SET**
For: Commercial V4 gearcases
— CONTAINS —

Part #	Desc.	O.E.#
NSS	Forward Gear	435123
NSS	Reverse Gear	336574
18-2216	Clutch	337774



**18-1292
GEAR SET**
For: Late model V-6 150-225 H.P. with large reverse gear
— CONTAINS —

Part #	Desc.	O.E.#
NSS	Forward Gear	5004216
NSS	Reverse Gear	336561



**18-1293
GEAR SET**
For: 20HP (1984-98), 25HP(1985-02),
30HP (1984-02) 35HP (1984-01)
— CONTAINS —

Part #	Desc.	O.E.#
18-1287	Forward Gear	392475
18-1289	Reverse Gear	327655
18-1288	Pinion	328313
18-1290	Clutch	337020



**18-1288
PINION GEAR**
Replaces: 328313
For: 25-35HP (1984-96)



**18-2207
FORWARD GEAR SET**
Replaces: 397338
Includes: Forward & Pinion Gears



**18-2208
REVERSE GEAR**
Replaces: 318304



**18-2209
SLIDING CLUTCH**
Replaces: 318303



**18-2210
GEAR SET**
— CONTAINS —

Part #	Desc.	O.E.#
18-2207	Forward Gear	397338
18-2208	Reverse Gear	318304
18-2209	Sliding Clutch	318303



**18-2216
SLIDING CLUTCH**
Replaces: 337772, 337774, 334516,
336562, 910995



**18-2217
GEAR SET**
— CONTAINS —

Part #	Desc.	O.E.#
NSS	Forward Gear	435020
NSS	Reverse Gear	910994
18-2216	Sliding Clutch	337772



**18-2218
FORWARD GEAR SET**
Replaces: 434063, 989966,
985050, 436746
Includes: Forward & Pinion Gears



**18-2219
REVERSE GEAR**
Replaces: 333077, 317838, 340490



**18-2220
SLIDING CLUTCH**
Replaces: 323664, 320630



**18-2221
GEAR SET**
— CONTAINS —

Part #	Desc.	O.E.#
18-2218	Forward Gear	434063
18-2219	Reverse Gear	333077
18-2220	Sliding Clutch	323664



18-2287
CLUTCH DOG
Replaces: 319895



18-2289
GEAR SET
Replaces: 433570
Individual parts not sold separately



18-2308
SLIDING CLUTCH
Replaces: 332491



18-2309
REVERSE GEAR
Replaces: 332489



18-1290
CLUTCH DOG
Replaces: 337020
For: 25-35HP (1992-98)



18-2310
FORWARD GEAR SET
Replaces: 397627
Includes: Forward & Pinion Gears



18-2315
GEAR SET

— CONTAINS —

Part #	Desc.	O.E.#
18-2310	Forward Gear Set	397627
18-2309	Reverse Gear	332489
18-2308	Sliding Clutch	332491



18-2290
GEAR SET

— CONTAINS —

Part #	Desc.	O.E.#
NSS	Forward Gear Set	435020, 434026, 983141, 391289
NSS	Reverse Gear	336561
18-2216	Sliding Clutch	337774, 334516, 336562, 910795, 337772



18-1729
COVER & BUSHING ASSEMBLY

Replaces: 434588
For: 40HP (1993-02), 48HP (1993-96), 50HP (1993-02)



18-1500
INTAKE WATER SCREEN
Replaces: 337778

For: 100, 120, 125, 140, 150, 175, 200, 225 (1993) (OMC Cobra & V-6)



18-4818
CARRIER BEARING
Replaces: 397087

Fits: 85-140hp crossflow (1978-98)



18-1343
BEARING CARRIER RETAINING TAB

Replaces: 333957
For: 100, 120, 125, 140, 150, 175, 200, 225, (1988-92) (Cobra Drives)



18-4807
DRIVESHAFT BEARING RETAINER CAP

Replaces: 439476
To replace bearing use 18-1344



18-3766
SHIFT CRADLE

Replaces: 334163
For: V-4/V-6, Cobra, Stringer

PKG. OF 2



18-2243
18-2243-9^①
DETENT BALL
 Replaces: 316506
 9.9 - 35 HP



18-2398
RETAINING SPRING
 Replaces: 320311
 For: 2 & 3 CYL.



18-2399
RETAINING SPRING
 Replaces: 324369
 For: V-4 & V-6

^① Priced per package

ALL FORWARD GEARS INCLUDE PINION GEARS

HP	Year	Model	Prop Shaft	Gear Set	Fwd. Gear	Rev. Gear	Clutch
20	1985-95	ALL		18-1293	18-1287 ⑩	18-1289	18-1290
25	1985-95	ALL		18-1293	18-1287 ⑩	18-1289	18-1290
25D	1989-95	ALL	18-2288	18-2315	18-2310	18-2309	18-2308
30	1984-96	ALL		18-1293	18-1287 ⑩	18-1289	18-1290
35	1984-94	ALL ⑨		18-1293	18-1287 ⑩	18-1289	18-1290
35	1987	AE, AR, AT	—	18-2289	—	—	18-2287
40	1984-88	ALL	—	18-2289	—	—	18-2287
40	1989-97	ALL	18-2288	18-2315	18-2310	18-2309	18-2308
48	1987-88	ALL	—	18-2289	—	—	18-2287
48	1989-96	ALL	18-2288	18-2315	18-2310	18-2309	18-2308
50	1975	ALL	—	—	—	—	18-2287
50	1979-88	ALL	—	18-2289	—	—	18-2287
50	1989-97	2 Cyl.	18-2288	18-2315	18-2310	18-2309	18-2308
50	1997	3 Cyl.	18-2250	—	18-2207	18-2208	18-2209
55	1976-78	ALL	—	—	—	—	18-2287
60	1980-85	Electric Start	—	18-2289	—	—	18-2287
60	1986-87	⑥	18-2250	18-2210	18-2207	18-2208	18-2209
60 ⑧	1986-87	3 Cyl.	—	—	—	—	18-2287
60	1988-97	ALL	18-2250	18-2210	18-2207	18-2208	18-2209
65	1984	ALL	18-2250	18-2210	18-2207	18-2208	18-2209
65	1987	ALL	18-2250	18-2210	18-2207	18-2208	18-2209
65	1990-91	ALL	18-2250	18-2210	18-2207	18-2208	18-2209
65 COMM	1985-97	ALL	18-2250	18-2210	18-2207	18-2208	18-2209
65 COMM Remote	1992-95	ALL	18-2250	18-2210	18-2207	18-2208	18-2209
65 COMM Rope	1992-95	ALL	18-2250	18-2210	18-2207	18-2208	18-2209
70	1975	①	N/A	18-2210	18-2207	18-2208	18-2209
70	1976	ALL	N/A	18-2210	18-2207	18-2208	18-2209
70	1977-85	⑥	18-2250	18-2210	18-2207	18-2208	18-2209
70 ⑧	1979-85	ALL	—	—	—	—	18-2287
70	1986-97	ALL	18-2250	18-2210	18-2207	18-2208	18-2209
70TTL	1992-95	ALL	18-2250	18-2210	18-2207	18-2208	18-2209
75 ⑧	1975-87	ALL	—	—	—	—	18-2287
75	1976	⑥	N/A	18-2210	18-2207	18-2208	18-2209
75	1977	⑥	18-2250	18-2210	18-2207	18-2208	18-2209
75	1978-80	⑥	18-2250	18-2210	18-2207	18-2208	18-2209
75	1982-87	⑥	18-2250	18-2210	18-2207	18-2208	18-2209
75	2000-01	FPX & FX	18-2251	18-1291	—	—	18-2216
85	1973-77	ALL	—	—	—	18-2219	—
85	1978-80	ALL	18-2252	18-2221	18-2218	18-2219	18-2220
85	1991-95	ALL	18-2252	18-2221	18-2218	18-2219	18-2220
88	1987-96	ALL	18-2252	18-2221	18-2218	18-2219	18-2220
90	1981-98 ②	ALL	18-2252	18-2221	18-2218	18-2219	18-2220
90	1995-01	25" Transoms	18-2251	18-1291	—	—	18-2216
90	1999	ALL	18-1725	18-2221	18-2218	18-2219	18-2220
100	1979-80, 90-95	ALL	18-2252	18-2221	18-2218	18-2219	18-2220
100 COMM	1984-90	ALL	18-2187	—	—	—	18-2216
100 COMM	1989-90, 1998	③	18-2252	18-2221	18-2218	18-2219	18-2220
100 COMM	1993-01	ALL	18-2251	18-1291	—	—	18-2216
105 JET	1992	ALL	18-2251	18-2217	—	—	18-2216
105	1997-99	ALL	18-2251	18-1291	—	—	18-2216
105 COMM	2000-01	ALL	18-2251	18-1291	—	—	18-2216
110	1986-89	ALL	18-2252	18-2221	18-2218	18-2219	18-2220
112	1994-96	ALL	18-2252	18-2221	18-2218	18-2219	18-2220
115	1973-76	ALL	—	—	—	18-2219	—
115	1977	ALL	18-2252	—	—	18-2219	18-2220
115	1978-85, 1990-98	ALL	18-2252	18-2221	18-2218	18-2219	18-2220
115	1995-01	25" Transoms	18-2251	18-1291	—	—	18-2216
115	1999	20" 60 degree V4	18-2252	18-2221	18-2218	18-2219	18-2216
115	1999	25" 60 degree V4	18-2251	—	—	—	18-2216
120	1985	ALL	—	—	—	—	18-2216
120	1986-92	ALL	18-2252	18-2221	18-2218	18-2219	18-2220
120	1993-94	TL & TX ⑦	18-2252	18-2221	18-2218	18-2219	18-2220
120	1993-94	TX ⑤	18-2251	18-1291	—	—	18-2216
125 COMM	1989-90	④	18-2252	18-2221	18-2218	18-2219	18-2220

① Models with "E" suffix only
 ② Models with "WTP" only
 ③ Models with "S" prefix only
 ④ Models "ESX" only

⑤ All models except "ESX"
 ⑥ 20" Transom only
 ⑦ All models except 140TX
 ⑧ 15" Models

⑨ 1993 Models "ESX" "F" suffix only
 ⑩ Except 1999 "FCX" Models
 ⑪ Except 1998 "FSX" Models
 ⑫ Models with "F" suffix only

⑬ Models with "S" suffix only
 ⑭ Fits new style reverse gear with 6 clutch ears only
 ⑮ Except AE, AR & AT models
 ⑯ Pinion 18-1288 sold separately

ALL FORWARD GEARS INCLUDE PINION GEARS

HP	Year	Model	Prop Shaft	Gear Set	Fwd. Gear	Rev. Gear	Clutch
125 COMM	1989-90	⑤	18-2187	—	—	—	18-2216
125 COMM	1992-94, 1996	⑤	18-2251	—	—	—	18-2216
125	1991	②	18-2251	—	—	—	18-2216
125	1991-95	④ ⑨	18-2252	18-2221	18-2218	18-2219	18-2220
125	1993-95	⑤	18-2251	18-1291	—	—	18-2216
125	1996-98	ALL	18-2251	18-1291	—	—	18-2216
130	1995-01	TL & TX & 25"	18-2251	18-1291	—	—	18-2216
135	2001	ALL	18-2251	18-1291	—	—	18-2216
140	1977	ALL	18-2252	—	—	—	18-2220
140	1978-84, 1986-87	ALL	18-2252	18-2221	18-2218	18-2219	18-2220
140	1985	ALL	18-2187	—	—	—	18-2216
140	1988-94	⑦	18-2252	18-2221	18-2218	18-2219	18-2220
140	1988-90	TX	18-2187	—	—	—	18-2216
140	1993-94	TX ⑤	18-2251	18-1291	N/A	N/A	18-2216
150	1978-79	ALL	—	—	—	—	18-2216 ⑩
150	1980-87	ALL	18-2187	18-2217	—	—	18-2216
150	1988-89, 90	ALL	18-2187	18-2217	—	—	18-2216
150	1991-99 ①	ALL	18-2251	18-2290	—	—	18-2216
150	2004	ALL	18-2251	18-1292	N/A	N/A	18-2216
150 COMM	1993-96	ALL	18-2251	18-2290	—	—	18-2216
155 COMM	1984-88	ALL	18-2187	—	—	—	18-2216
155 COMM WTP	1986-88	ALL	18-2187	—	—	—	18-2216
155 COMM WTL & WTX	1989-90	ALL	18-2187	—	—	—	18-2216
155 COMM	1989-90	②	18-2187	18-2217	—	—	18-2216
155 COMM	1991-92	ALL	18-2251	18-2290	—	—	18-2216
175	1977	ALL	—	N/A	N/A	N/A	18-2220
175	1978-83	ALL	—	—	—	—	18-2216 ⑩
175	1985-90	ALL	18-2187	18-2217	—	—	18-2216
175/185	1991-99 ①	ALL	18-2251	18-2290	—	—	18-2216
185	1984-85	ALL	18-2187	18-2217	—	—	18-2216
200	1979-86	ALL	—	18-2217	—	—	18-2216
200	1988-90	ALL	18-2187	18-2217	—	—	18-2216
200	1991-99	ALL	18-2251	18-2290	—	—	18-2216
200	2002-03	ALL	18-2251	18-1292	N/A	N/A	18-2216
220	1987	ALL	18-2187	18-2217	—	—	18-2216
225	1986-87	ALL	—	18-2217	—	—	18-2216
225	1988-89	ALL	18-2187	18-2217	—	—	18-2216
225	1991-99	ALL	18-2251	18-2290	—	—	18-2216
225	2002-04	ALL	18-2251	18-1292	N/A	N/A	18-2216
235	1979-85	ALL	—	18-2217	—	—	18-2216
250	1991-99	ALL	18-2251	—	—	—	18-2216
250	2002-03	ALL	18-2251	18-1292	N/A	N/A	18-2216
275	1985-88	ALL	18-2251	—	—	—	18-2216
3.6L	1985-87	ALL	18-2251	—	—	—	18-2216
300	1988-95	ALL	18-2251	—	—	—	18-2216

- ② Models with "WTP" only
- ③ Models with "S" prefix only
- ④ Models "ESX" only
- ⑤ All models except "ESX"
- ⑥ 20" Transom only
- ⑦ All models except 140TX
- ⑧ 15" Models
- ⑨ 1993 Models "ESX" "F" suffix only
- ⑩ Except 1999 "FCX" Models
- ⑪ Except 1998 "FSX" Models
- ⑫ Models with "F" suffix only
- ⑬ Models with "S" suffix only
- ⑭ Fits new style reverse gear with 6 clutch ears only
- ⑮ Except AE, AR & AT models
- ⑯ Pinion 18-1288 sold separately

SEA DRIVE SHAFTS AND GEARS

HP	Year	Model	Prop Shaft	Gear Set	Fwd. Gear	Rev. Gear	Clutch
1.6	1990 ①	ALL	18-2252	18-2221	18-2218	18-2219	18-2220
2	1990 ②	ALL	18-2187	—	—	—	18-2216
2	1990 ①	ALL	18-2187	—	—	—	18-2216
3	1990 ①	ALL	18-2187	18-2217	—	—	18-2216
3	1990	ALL	18-2187	18-2217	—	—	18-2216
4	1990	ALL	18-2187	—	—	—	18-2216
1.6	1989	ALL	18-2252	18-2221	18-2218	18-2219	18-2220
2	1989	ALL	18-2187	—	—	—	18-2216
3	1989	ALL	18-2187	18-2217	—	—	18-2216
4	1989	ALL	18-2187	—	—	—	18-2216
1.6	1988	ALL	18-2252	18-2221	18-2218	18-2219	18-2220
2	1988	ALL	18-2187	—	—	—	18-2216
3	1988	ALL	18-2187	18-2217	—	—	18-2216
1.6	1987	ALL	18-2252	18-2221	18-2218	18-2219	18-2220
1.8	1987	ALL	18-2252	18-2221	18-2218	18-2219	18-2220
2.7	1987	ALL	18-2187	18-2217	—	—	18-2216
3.6	1987	ALL	18-2187	—	—	—	18-2216
1.6	1986	ALL	18-2252	18-2221	18-2218	18-2219	18-2220
2.6	1986	ALL	18-2187	18-2217	—	—	18-2216
1.6 V-4	1985 ③	ALL	18-2252	18-2221	18-2218	18-2219	18-2220
2.6 V-6	1985 ④	ALL	18-2187	—	—	—	18-2216
2.5/2.6	1985 ③	ALL	18-2187	—	—	—	18-2216
1.6 V-4	1984 ③	ALL	18-2252	18-2221	18-2218	18-2219	18-2220
2.6 V-6	1984 ④	ALL	18-2187	—	—	—	18-2216
2.5/2.6	1984 ③	ALL	18-2187	—	—	—	18-2216
1.6	1983	ALL	18-2252	18-2221	18-2218	18-2219	18-2220
2.6	1983	ALL	N/A	—	—	—	18-2216
2.5/2.6	1982	ALL	—	—	—	—	18-2216

- ① Models with "E" suffix only
- ② Models with "WTP" only
- ③ Models with "S" prefix only
- ④ Models "ESX" only



18-6525
THROTTLE CABLE
Replaces: 397003
For: 4, 85, 115 HP models from 1968 & up



18-6526
THROTTLE CABLE
Replaces: 397004
For: 6 & 8 HP models from 1968 - 1990



18-6527
THROTTLE CABLE
Replaces: 395911
For: 10 HP models from 1968 - 1990



18-6528
THROTTLE CABLE
Replaces: 5000581, 396161
For: 20, 25 & 30 HP models from 1986 & up



Part #	Desc.	O.E. #	I.D.	Part #	Desc.	O.E. #	I.D.
18-1718 ②	Kit	—		18-2229 ① ③	.003 Shim	323362	1.24
18-2224 ③	.003 Shim	320166	1.58	18-2230	.004 Shim	323361	1.24
18-2225 ③	.004 Shim	320167	1.56	18-2231	.005 Shim	314745	1.24
18-2226 ③	.005 Shim	320168	1.53	18-2232	.003 Shim	323889	1.22
18-2227 ③	.006 Shim	320169	1.53	18-2233	.004 Shim	323890	1.22
18-2228 ③	.007 Shim	320170	1.53	18-2234 ① ③	.005 Shim	317232	.22

HP	Year	0.003 Shim	0.004 Shim	0.005 Shim	0.006 Shim	0.007 Shim
60	1980-1987	18-2224	18-2225	18-2226	18-2227	18-2228
60	1988-95	18-2232	18-2233	18-2234	—	—
60SST	1989-1990	18-2224	18-2225	18-2226	18-2227	18-2228
60TTL	1992	18-2232	18-2233	18-2234	—	—
65C	1984-91,93-95	18-2232	18-2233	18-2234	—	—
65C	1992	18-2232	18-2233	18-2234	—	—
70	1975-76	18-2232	18-2233	18-2234	—	—
70	1977-85	18-2224	18-2225	18-2226	18-2227	18-2228
70	1986-95	18-2232	18-2233	18-2234	—	—
70TTL	1992	18-2232	18-2233	18-2234	—	—
75	1975-1988	18-2224	18-2225	18-2226	18-2227	18-2228
85	1975-79	18-2229	18-2230	18-2231	—	—
85	1980,91	18-2229	18-2230	18-2231	—	—
85TTL	1992-95	18-2229	18-2230	18-2231	—	—
88	1987-95	18-2229	18-2230	18-2231	—	—
90	1981-95	18-2229	18-2230	18-2231	—	—
100	1979	18-2229	18-2230	18-2231	—	—
100	1980,90-95	18-2229	18-2230	18-2231	—	—
100C	1984-87,89-95	18-2229	18-2230	18-2231	—	—
100PLY	1989	18-2229	18-2230	18-2231	—	—
105JET	1992-93	18-2229	18-2230	18-2231	—	—
110	1986-89	18-2229	18-2230	18-2231	—	—
115	1980-85,90-95	18-2229	18-2230	18-2231	—	—
115	1975-79	18-2229	18-2230	18-2231	—	—
120	1985-95	18-2229	18-2230	18-2231	—	—
125, 125C	1989-95	18-2229	18-2230	18-2231	—	—
125ESX	1989-90	18-2229	18-2230	18-2231	—	—
125WTPL	1990	18-2229	18-2230	18-2231	—	—
135	1975-76	18-2229	18-2230	18-2231	—	—
140	1977-79	18-2229	18-2230	18-2231	—	—
140	1980-95	18-2229	18-2230	18-2231	—	—
150	1979-95	18-2229	18-2230	18-2231	—	—
150C	1986-91,95	18-2229	18-2230	18-2231	—	—
155C	1984-87,89-95	18-2229	18-2230	18-2231	—	—
175	1977	18-2229	18-2230	18-2231	—	—
175	1978-88,90-95	18-2229	18-2230	18-2231	—	—
185	1984-85,90-95	18-2229	18-2230	18-2231	—	—
200	1976-77	18-2229	18-2230	18-2231	—	—
200	1978-83,86-95	18-2229	18-2230	18-2231	—	—
200C	1990	18-2229	18-2230	18-2231	—	—
225	1986-93	18-2229	18-2230	18-2231	—	—
235	1978-85	18-2229	18-2230	18-2231	—	—
1600cc	1988	18-2229	18-2230	18-2231	—	—
2500cc	1988	18-2229	18-2230	18-2231	—	—

① STD PKG OF 2 ② Includes 1 each of 18-2229, 18-2230 & 18-2231
 ③ This product is priced per piece. To order priced per package, please add -9 to the part number

Zinc is for saltwater only applications.
Magnesium is for fresh water only applications.
Aluminum is for brackish water, or if boat is used in both fresh and salt environments.

 <p>③ 18-6115 ANODE TRANSOM BRACKET Replaces: 433580 For: 60-225 (1991-93) For use on Stern Bracket</p>	 <p>③ 18-6017 ① 18-6017A ② 18-6100 ANODE Replaces: 173029, 123009 (1981-91) 9.9-115 HP For use on gearcase and transom bracket assembly</p>	 <p>18-6018 ANODE Replaces: 327606 1983-89 2HP, For Motor Leg</p>
 <p>③ 18-6024 ① 18-6024A ANODE Replaces: 393023, 436745 (1982-87) 60-300 HP For use on gearcases</p>	 <p>③ 18-6025 ANODE Replaces: 433458, 398331 (1987-92) 60-300HP For use on Stern Bracket</p>	 <p>② 18-6026 ANODE Replaces: 392462 For exhaust housing, 2 & 3 Cyl. (1984-99)</p>
 <p>③ 18-6095 ① 18-6095A ANODE Replaces: 431708 (1988-90) 45-300 HP For use on Prop Shaft Bearing Carrier</p>	 <p>③ 18-6020 ANODE Replaces: 976669 (1969-89) Kit for V4 & V6</p>	 <p>③ 18-6027 ANODE Replaces: 392123 (1982-98) 40-300 HP Front Lower Leg Extension</p>

① Aluminum ② Magnesium ③ Zinc

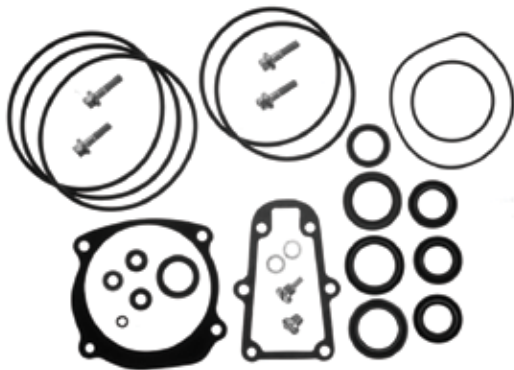

18-2623
LOWER UNIT SEAL KIT
Replaces: 439141

-- CONTAINS --

Part #	Desc.	O.E. #	Qty.
18-0110	Shift Housing Gasket	314082	1
18-2001	Seal	330137	2
18-2002	Seal	320862	2
18-2026	Seal	321453	2
18-2061	Seal	329922	1
18-2062	Seal	329923	1
18-2377	Screw	316563	4
18-2378	Magnetic Drain Screw	318544	1
18-2536	O-Ring	315788	1
18-2557	Impeller Gasket	338484	1
18-4248	Washer	311598	2
18-7109	O-Ring	317178	1
18-7120	O-Ring	307853	1
18-7127	O-Ring	313446	1
18-7130	O-Ring	314728	1
18-7133	O-Ring	305123	2
18-7137	O-Ring	318372	2
18-7142	O-Ring	322119	1
18-7144	O-Ring	333572	3
18-7145	O-Ring	332584	1
18-7475	Washer	328743	4
18-8300	Seal	341280	1
18-8301	Seal	341281	1



18-2656
LOWER UNIT SEAL KIT
Replaces: 396350

-- CONTAINS --

Part #	Desc.	O.E. #	Qty.
18-0189	Shift Rod Washer	321738	1
18-2025	Oil Seal	318971	1
18-2028	Oil Seal	321480	2
18-2029	Oil Seal	321481	2
18-4248	Washer	311598	2
18-7100	O-Ring	301877	1
18-7104	O-Ring	308627	1
18-7120	O-Ring	307853, 322598	1
18-7139	O-Ring	319085	1
18-7145	O-Ring	333572	2



18-2657
LOWER UNIT SEAL KIT
Replaces: 396352

-- CONTAINS --

Part #	Desc.	O.E. #	Qty.
18-0882	Shift Rod Gasket	304764	1
18-0108	Lower Gearcase Gasket	324449	1
18-3360	Impeller Housing Gasket	329390	1
18-7411	O-Ring	---	1
18-2027	Oil Seal	321459	2
18-2031	Oil Seal	321787	1
18-2063	Oil Seal	330327	1
18-4248	Washer	311598	2
18-7100	O-Ring	301877	1
18-7145	O-Ring	333572	2
18-7475	Quad Ring	332583,	

**18-2658
LOWER UNIT SEAL KIT**
Replaces: 396351



— CONTAINS —

Part #	Desc.	O.E. #	Qty.
18-0124	Impeller Plate Gasket	325537	1
18-0189	Shift Rod Washer	321738	1
18-2026	Oil Seal	321453	2
18-2033	Oil Seal	321928	1
18-2065	Oil Seal	332261	1
18-2539	Rubber Seal	328753	1
18-4248	Washer	311598	2
18-7100	O-Ring	301877	1
18-7105	O-Ring	311338	2
18-7108	O-Ring	313893	1
18-7109	O-Ring	317178	3
18-7145	O-Ring	333572	2
18-7146	O-Ring	554545	1
18-7180	O-Ring	303347	1
18-2030	Oil Seal	321786	1
18-2027	Oil Seal	321459	1

**18-2659
LOWER UNIT SEAL KIT**
Replaces: 396355



— CONTAINS —

Part #	Desc.	O.E. #	Qty.
18-0969	Impeller Housing Gasket	319586	1
18-2059	Oil Seal	321466	1
18-2060	Oil Seal	321467	2
18-2064	Oil Seal	332205	1
18-2532	Foam Seal	305762	1
18-2537	Rubber Seal	324937	1
18-2855	Shift Housing Cover to Gear Case Gasket	314082	1
18-4248	Washer	311598	2
18-7115	O-Ring	302588	1
18-7120	O-Ring	307853	1
18-7137	O-Ring	318372	1
18-7140	O-Ring	320303	1
18-7145	O-Ring	333572	2
18-7475	Quad Ring	332584	3

**18-2660
LOWER UNIT SEAL KIT**
Replaces: 396349

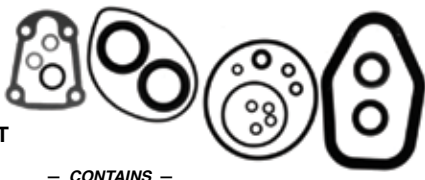

— CONTAINS —

Part #	Desc.	O.E. #	Qty.
18-2059	Oil Seal	321466	1
18-2064	Oil Seal	332205	1
18-2537	Rubber Seal	324937	1
18-2855	Shift Housing Cover to Gearcase Gasket	314082	1
18-4248	Washer	311598	2
18-7120	O-Ring	307853	1
18-7127	O-Ring	313446	1
18-7128	O-Ring	313754	1
18-7137	O-Ring	318372	1
18-7145	O-Ring	333572	2
18-7475	Quad Ring	332584	4
18-7174	O-Ring	910582, 326649	1
18-2001	Oil Seal	330137	2

**18-2679
LOWER UNIT SEAL KIT**



— CONTAINS —

Part #	Desc.	O.E. #	Qty.
18-2022	Oil Seal	303345	1
18-2035	Oil Seal	327031	1
18-2891	Bearing Housing Gasket	303339	1
18-4248	Washer	311598	2
18-7100	O-Ring	301877	1
18-7117	O-Ring	303360	1
18-7120	O-Ring	307853	1
18-2534	Spaghetti Seal	309044	1

**18-2680
LOWER UNIT SEAL KIT**



— CONTAINS —

Part #	Desc.	O.E. #	Qty.
18-2023	Oil Seal	313282	1
18-2035	Oil Seal	327031	1
18-2891	Bearing Housing Gasket	303339	1
18-4248	Washer	311598	2
18-7100	O-Ring	301877	1
18-7117	O-Ring	303360	1
18-7120	O-Ring	307853	1
18-2534	Spaghetti Seal	309044	1

**18-2681
LOWER UNIT SEAL KIT**



— CONTAINS —

Part #	Desc.	O.E. #	Qty.
18-2023	Oil Seal	313282	1
18-2024	Oil Seal	314167	1
18-2891	Bearing Housing Gasket	303339	1
18-4248	Washer	311598	2
18-7100	O-Ring	301877	1
18-7117	O-Ring	303360	1
18-7120	O-Ring	307853	1
18-2534	Spaghetti Seal	309044	1

**18-2682
LOWER UNIT SEAL KIT**

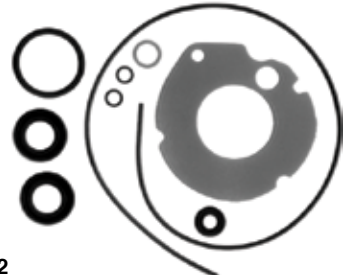

— CONTAINS —

Part #	Desc.	O.E. #	Qty.
18-2022	Oil Seal	303345	2
18-2891	Bearing Housing Gasket	303339	1
18-4248	Washer	311598	2
18-7100	O-Ring	301877	1
18-7117	O-Ring	303360	1
18-7120	O-Ring	307853	1
18-2534	Spaghetti Seal	309044	1

**18-2683
LOWER UNIT SEAL KIT**



— CONTAINS —

Part #	Desc.	O.E. #	Qty.
18-2023	Oil Seal	313282	2
18-2891	Bearing Housing Gasket	303339	1
18-4248	Washer	311598	2
18-7100	O-Ring	301877	1
18-7117	O-Ring	303360	1
18-7120	O-Ring	307853	1
18-2534	Spaghetti Seal	309044	1

**18-2684
LOWER UNIT SEAL KIT**



— CONTAINS —

Part #	Desc.	O.E. #	Qty.
18-0882	Shift Rod Gasket	304764	1
18-2032	Oil Seal	321788	1
18-4248	Washer	311598	2
18-7100	O-Ring	301877	1
18-7120	O-Ring	307853	1
18-2031	Oil Seal	321787	1
18-2534	Spaghetti Seal	309044	1

**18-2685
LOWER UNIT SEAL KIT**



— CONTAINS —

Part #	Desc.	O.E. #	Qty.
18-2030	Oil Seal	321786	3
18-2031	Oil Seal	321787	1
18-4248	Washer	311598	2
18-7100	O-Ring	301877	1
18-7112	O-Ring	302493	1
18-7120	O-Ring	307853	1
18-2534	Spaghetti Seal	309044	1
18-0882	Shift Rod Gasket	304764	1



**18-2686
LOWER UNIT SEAL KIT**

— CONTAINS —

Part #	Desc.	O.E. #	Qty.
18-0882	Shift Rod Gasket	304764	1
18-2005	Oil Seal	313284	1
18-2021	Oil Seal	302564	1
18-4248	Washer	311598	2
18-7100	O-Ring	301877	1
18-7115	O-Ring	302588	1
18-7120	O-Ring	307853, 322598	1

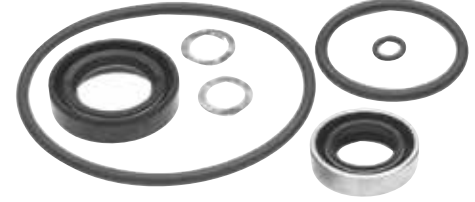

**18-2687
LOWER UNIT SEAL KIT**

— CONTAINS —

Part #	Desc.	O.E. #	Qty.
18-2005	Oil Seal	313284	1
18-4248	Washer	311598	2
18-7120	O-Ring	307853, 322598	1
18-7152	O-Ring	307082	1
18-2027	Oil Seal	321459	1
18-7143	O-Ring	322501	1
18-0173	Oil Seal	313283	1
18-7428	Rubber Seal	307103	1



**18-2688
LOWER UNIT SEAL KIT**

— CONTAINS —

Part #	Desc.	O.E. #	Qty.
18-2027	Oil Seal	321459	2
18-2855	Shift Housing Cover to Gearcase Gasket	314082	1
18-4248	Washer	311598	2
18-7100	O-Ring	301877	1
18-7109	O-Ring	317178	4
18-7127	O-Ring	313446	1
18-7128	O-Ring	313754	1
18-2001	Oil Seal	330137	2
18-7129	O-Ring	314491	1

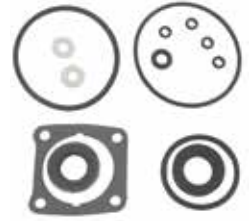

**18-2689
LOWER UNIT SEAL KIT**

— CONTAINS —

Part #	Desc.	O.E. #	Qty.
18-0173	Oil Seal	313283	1
18-0174	Oil Seal	326716	1
18-0886	Lower Gearcase Gasket	307099	1
18-4248	Washer	311598	2
18-7115	O-Ring	302588	1
18-7118	O-Ring	305242	1
18-7120	O-Ring	307853, 322598	4
18-7152	O-Ring	307082	1
18-7428	O-Ring	307103	1



**18-2690
LOWER UNIT SEAL KIT**

— CONTAINS —

Part #	Desc.	O.E. #	Qty.
18-2855	Shift Housing Cover to Gearcase Gasket	314082	1
18-2874	Solenoid Cover Gasket	314876	1
18-4248	Washer	311598	2
18-7120	O-Ring	307853, 322598	4
18-7127	O-Ring	313446	1
18-7129	O-Ring	314491	1
18-7130	O-Ring	314728	1
18-7126	O-Ring	313340	1

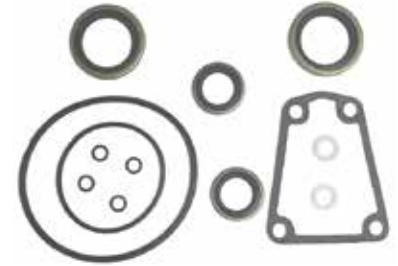

**18-2691
LOWER UNIT SEAL KIT**

— CONTAINS —

Part #	Desc.	O.E. #	Qty.
18-2874	Solenoid Cover Gasket	314876	1
18-4248	Washer	311598	2
18-7109	O-Ring	317178	4
18-7127	O-Ring	313446	1
18-2001	Oil Seal	330137	2
18-7130	O-Ring	314728	1
18-2059	Oil Seal	321466	2



**18-2692
LOWER UNIT SEAL KIT**

— CONTAINS —

Part #	Desc.	O.E. #	Qty.
18-0110	Shift Housing Gasket	324670	1
18-2026	Oil Seal	321453	2
18-2874	Solenoid Cover Gasket	314876	1
18-4248	Washer	311598	2
18-7109	O-Ring	317178	4
18-7120	O-Ring	322598	1
18-7127	O-Ring	313446	1
18-7130	O-Ring	314728	1
18-7137	O-Ring	318372	1
18-2001	Oil Seal	330137	2



**18-2694
LOWER UNIT SEAL KIT**
Replaces: 433550

— CONTAINS —

Part #	Desc.	O.E. #	Qty.	Part #	Desc.	O.E. #	Qty.
18-2709	Wear Plate Gasket	336530	1	18-7481	Seal	315788	1
18-7115	O-Ring	302588	1	18-2708	Seal	333758	1
18-7127	O-Ring	313446	1	18-2059	Oil Seal	321466	2
18-7120	O-Ring	307853, 322598	1	18-2018	Oil Seal	305987	2
18-7172	O-Ring	553126	1	18-2064	Oil Seal	332205	1
18-7137	O-Ring	318372	1	18-2705	Seal	315748	1
18-7475	O-Ring	332584	1	18-4248	Washer	311598	1
				18-7173	O-Ring	310327, 910582	1



**18-8383
SEAL KIT**
Replaces: Johnson/Evinrude 5000309
For: E-Tec 40, 50, 60 HP



**18-8384
Seal Kit**
Replaces: OMC E-Tec 5006373
For: E-Tec 75/90/115/150/175/200/225/250 HP

**18-8337
LOWER UNIT SEAL KIT**
Replaces: 5031456
For: 40/50 HP 4 stroke (1999-2003)

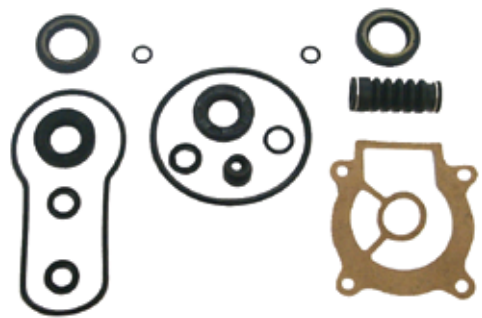

— CONTAINS —

Part #	Desc.	O.E. #	Qty.
18-0461	Water Pump Gasket	—	1
18-7151	O-Ring	—	1
18-7413	O-Ring	303191	2
18-8331	Drain Plug Gasket	—	3
18-8334	Shift Shaft Seal	—	1
18-8345	Seal	—	2

GEAR HOUSING SEAL KITS APPLICATION

Model	Year	Seal Kit	Model	Year	Seal Kit
5.5	⑧	1955-67	85	1991-95	18-2623
6	⑧	1955-67	88	1985-Up	18-2623
6	⑨	1967-68	90 (Elect.)	1964-65	18-2689
6	⑩	1968-79	90 (V-4)	1973-83	18-2692
7.5	⑧	1955-67	90	1985-Up	18-2623
9.5 (M Suffix)		1964-67	100 (Large Prop Shaft)	1971-72	18-2691
9.5 (B Suffix)		1967-73	100 (V-4)	1973-83	18-2692
9.9/15		1974-Up	100 (Comm)	1984-90	18-2623
9.9/15 (4 Stroke)		1974-Up	100 (Comm)	1991-95	18-2623
10		1958-67	100	1991-92	18-2623
18		1958-73	110 (V-4)	1973-83	18-2692
20		1966-73	110	1985-89	18-2623
20		1979-82	115 (Small Prop Shaft)	1969-71	18-2690
20		1985-Up	115 (V-4)	1973-83	18-2692
25		1955-59	115	1985-Up	18-2623
25		1968-78	120	1985	18-2623
25		1979-82	120	1986-92	18-2623
25		1984	120	1993	18-2623
25		1985-Up	125 (Large Prop Shaft)	1971-72	18-2691
25	①	1990-95	125	1991-92	18-2623
25 (Comm)		1985-Up	125	1993	18-2623
28		1962-70	125 (Comm)	1991-93	18-2623
28		1985-98	135 (V-4)	1973-83	18-2692
30		1955-59	140 (V-4)	1973-83	18-2692
30		1976-95	140	1985	18-2623
33		1962-70	140	1986-92	18-2623
35		1955-59	140	1992-93	18-2623
35		1977-92	140	1992-95	18-2623
40 (Manual Shift)		1960-73	150 (V-6)	1978-86	18-2623
40 (Elect. Shift)		1962-70	150	1991	18-2623
40		1976-88	150	1991-95	18-2623
40		1989-Up	155 (Comm)	1984-90	18-2623
48		1976-88	155 (Comm)	1991-93	18-2623
48		1989-96	175 (V-6)	1977-86	18-2623
50		1971-74	175	1991	18-2623
50		1976-88	175	1992	18-2623
50		1989-Up	175	1991-95	18-2623
50 (3 cyl.)		1995-Up	185	1991-93	18-2623
55		1968-69	200 (V-6)	1976-86	18-2623
55		1976-88	200	1991-95	18-2623
60 (Manual/Elect.)		1960-68	225	1991-95	18-2623
60		1970-71	235 (V-6)	1977-86	18-2623
60 (2 cyl.)		1976-88	V-8	1985-91	18-2623
60 (3 cyl.)		1978-Up	250 (V-8)	1991-95	18-2623
65 (Manual/Elect.)		1960-68	300 (V-8)	1991-95	18-2623
65		1978-Up			
70		1978-Up			
75 (Manual/Elect.)		1960-68	OMC SEA DRIVE		
75		1978-91	1.6L	1985-90	18-2623
75 (Small Gearcase)		1976-88	1.8L	1987	18-2623
V-4		1978-84	2.0L	1988-90	18-2623
85 (Manual/Elect.)		1968	2.5L	1984-85	18-2623
85 (Small Prop Shaft)		1969-71	2.6L	1984-86	18-2623
85 (Large Prop Shaft)		1971-72	2.7L	1987	18-2623
85 (V-4)		1973-83	3.0L	1988-90	18-2623
			3.6L	1987	18-2623
			4.0L	1989-90	18-2623

① "D" Suffix Only	⑤ 1992 TL Models only	⑨ 1967 "S" Suffix Only
② Models "GL" & "EX" only	⑥ CX Models only	1968 "C" Suffix Only
③ 1992 Models except WTLNE, WTXENE	⑦ 1992 Counter Rotation	⑩ 1968 "A" & "R" Suffixes Only
④ 1992 ESX Models only	⑧ 1967 "D" Suffix Only	● TX & Counter Rotation Models



18-2595
SHIFT ROD & WEAR PLATE GASKET SET
 Replaces: 982132

18-2595 SHIFT ROD & WEAR PLATE GASKET SET APPLICATION					
HP	YEARS	HP	YEARS	HP	YEARS
85	1978-80	125	1989-90	225	1986-90
88	1987-90	140	1977-90	235	1978-85
90	1981-90	150	1978-90	275	1985-90
100	1979-90	155C	1984-90	3.6L	1985-90
100C	1984-89	175	1977-90	300	1985-90
110	1986-89	185	1984-90		
115	1978-90	200	1976-90		
120	1985-90				

OIL SEALS



Part #	O.E. #	Shaft Size	Dimensions (in)		Part #	O.E. #	Shaft Size	Dimensions (in)	
			O.D.	Width				O.D.	Width
18-0173	313283	0.795	1.320	0.307	18-2059	321466	0.750	1.126	0.200
18-0174	326716	0.750	1.382	0.242	18-2060	321467	1.000	1.375	0.250
18-0542	321831	0.750	1.253	0.186	18-2061	329922	0.822	1.375	0.195
18-0543	321895	1.540	1.926	0.243	18-2062	329923	0.875	1.375	0.207
18-0559	332585	0.285	0.357	0.940	18-2063	330327	0.625	1.124	0.188
18-2000	309989	1.375	2.000	0.313	18-2064	332205	0.730	1.130	0.194
18-2001	330137	1.125	1.624	0.250	18-2065	332261	0.625	1.375	0.195
18-2002	320862	1.188	1.692	0.250	18-2066	911019	1.000	1.375	0.435
18-2005	313284	0.625	1.128	0.250	18-2067	911685	2.000	2.509	0.315
18-2012	310599	1.000	1.499	0.250	18-2068	911701	0.500	0.905	0.250
18-2016	313992	1.187	1.875	0.250	18-2068	915702	0.500	0.905	0.250
18-2018	305987	1.000	1.375	0.250	18-2068	916058	0.500	0.905	0.250
18-2020	310649	2.500	3.000	0.250	18-2068	3853655	.500	.905	.250
18-2021	302564	0.750	1.375	0.250	18-2071	981195	1.500	2.125	0.250
18-2022	303345	0.554	1.000	0.375	18-2072	981196	1.750	2.502	0.250
18-2023	313282	0.554	1.062	0.312	18-2073	981268	1.625	2.502	0.250
18-2024	314167	0.425	0.937	0.312	18-2074	322575	1.625	2.125	0.250
18-2025	318972	0.500	0.875	0.250	18-2074	339620	1.625	2.125	0.250
18-2026	321453	0.875	1.250	0.188	18-2075	332942	1.562	2.062	0.300
18-2027	321459	0.625	1.125	0.250	18-8300	341280	0.866	1.378	0.280
18-2028	321480	0.500	1.250	0.188	18-8301	341281	1.220	1.693	0.280
18-2029	321481	0.687	1.250	0.250	18-8304	321830	20.37mm	31.8mm	6.35mm
18-2030	321786	0.625	1.125	0.188	18-8307	331103	1.100	1.628	0.448
18-2031	321787	0.625	1.125	0.312	18-8325	342786	28mm	41.5mm	7/11
18-2032	321788	0.500	1.000	0.188	18-8326	342787	18mm	29mm	8/12
18-2033	321928	0.625	1.375	0.250	18-8349	911795			
18-2034	324639	0.437	0.937	0.188	18-8350	3852548	1.375	2.186	0.500
18-2035	327031	0.425	0.875	0.313	18-8351	328603	1.100	1.690	0.320
18-2058	313353	1.938	2.438	0.250	18-8351	321504	1.110	1.570	0.320
					18-8367	334950	1.250	1.687	0.250

OIL SEAL APPLICATION

HP	YEARS	PROPSHAFT	QTY.	DRIVESHAFT	QTY.	UPPER CRANKCASE	QTY.	LOWER CRANKCASE	QTY.
1.5,2,2.5,3	1958-68	-	1	18-2035	1	-	-	-	-
1.5,2	1968-90	18-2035	1	18-2035	1	-	-	-	-
2.5,4	② 1973-80	18-2035	1	18-2035	2	-	-	-	-
2.5	1987	18-2034	2	18-2035	2	-	-	-	-
2.5,4	② 1981-95	-	1	18-2035	2	-	-	-	-
3 Weedless	1958-68	18-2035	1	-	-	-	-	-	-
3,4,6 Weedless	1968-82	18-2024	1	18-2024	1	-	-	-	-
4	1981-90	18-2034	2	-	-	-	-	-	-
4	1984, 1986-95	-	-	18-2034	2	-	-	-	-
4.5,7.5	1980-87	-	1	18-2034	2	-	-	-	-
5,5.5,6,7.5	① 1957-64	18-2022	1	18-2035	1	-	-	-	-
5,6,8	1980-87	-	-	18-2034	2	-	-	-	-
6	1965-67	-	1	18-2023	1	-	-	-	-
6	1968-79	18-2023	1	18-2024	1	-	-	-	-
9.5	1964-73	18-2022	1	18-2022	1	-	-	-	-
9.9	1974-83	18-2029	1	18-2028	1	18-8304	-	18-0542	1
9.9	1984-95	18-2029	1	18-2028	1	18-8304	-	18-0542+18-2032	1
10	1957-58	18-2005	1	18-2032	1	-	-	-	-
10	1959-63	18-2022	1	18-2022	1	-	-	-	-

① 1968 Models 5802M,3M,6802C,3C ② Standard Gearcase

OIL SEAL APPLICATION (Cont.)

HP	YEARS	PROPSHAFT	QTY.	DRIVESHAFT	QTY.	UPPER CRANKCASE	QTY.	LOWER CRANKCASE	QTY.
10	1981	18-2023 (inner)	1	-	-	18-8304	-	18-0542	1
10	1989	18-2031+18-2027	1	18-2063+18-2027	1	18-8304	-	18-0542+18-2032	1
14	1988-90	18-2031+18-2027	1	18-2063+18-2027	1	18-8304	-	18-0542+18-2032	1
15	1974-83	18-2029	2	18-2028	1	18-8304	-	18-0542	1
15	1984-95	18-2029	2	18-2028	1	18-8304	-	18-0542+18-2032	1
18	1957	18-2005	1	18-2032	1	18-2060	1	-	-
18	1958-73	18-2005	1	18-2032	1	18-2018	1	-	-
20	1981-82	18-2031+18-2030	1	18-2030	1	18-8351	-	-	-
20	1983	18-2031+18-2030	1	18-2027+18-2030	1	18-8351	-	-	-
20	1984	18-2025+18-2027	1	18-2063+18-2030	1	18-8351	-	-	-
20	1985-86	18-2026	1	18-2033	1	18-8350	-	-	-
20	1987-95	18-2026	1	18-2033+18-2065	1	18-8350	-	-	-
25	1969-76	18-2005	1	18-2032	1	18-2018	1	-	-
25	1977-78	18-2005	1	18-2032	1	18-8351	-	-	-
25	1979-82	18-2031+18-2030	1	18-2030	1	18-8351	-	-	-
25	1983	18-2031+18-2030	1	18-2027+18-2030	1	18-8351	-	-	-
25	1984	18-2031+18-2027	1	18-2063+18-2030	1	18-8351	-	-	-
25	1985-86	18-2026	1	18-2033	2	18-8351	-	-	-
25	1987-95	18-2026	1	18-2033+18-2065	1	18-8351	-	-	-
25C	1982	18-2030	1	18-2030	1	18-8351	-	-	-
25C	1983	18-2031+18-2027	1	18-2027+18-2030	1	18-8350	-	-	-
25C	1984-90	18-2031+18-2027	1	18-2063+18-2027	1	18-8350	-	-	-
28	1962-64	18-2021	1	18-2005	1	18-8351	-	-	-
28	1987-90	18-2031+18-2027	1	18-2063+18-2027	1	18-8350	-	-	-
30	1984-86	18-2026	1	18-2033	1	18-8350	-	-	-
30	1987-95	18-2026	1	18-2033 (Inner)	1	18-8350	-	-	-
33	1965-76	18-2021	1	18-2005	1	18-8351	-	-	-
35	1957-59	18-2021	1	18-2005	1	18-2018	1	-	-
35	1976	18-2026	1	18-2027	2	18-8351	-	-	-
35	1977-86	18-2026	2	18-2033	2	18-8351	-	18-2093	-
35	1987-90	18-2026	2	18-2033 (Inner)	1	18-8350	-	18-2093	-
40	1960-61	18-2021	1	18-2005	1	18-2018	1	-	-
40	1962-73	18-2021	1	18-2005	1	18-8351	-	-	-
40	1974-76	18-2021	1	18-2029	1	18-0543	1	18-2001	1
40C	1981-86	18-2021	1	18-2029	2	18-0543	1	18-2001	2
40	1984-85	18-2060	2	18-2059	2	18-0543	1	18-2001	1
40 (AR,AE,AT)	1988	18-2001	1	18-2063+18-2027	1	18-0543	1	18-8307	-
40	1986-89	18-2060	2	18-2064+18-2059	1	18-0543	1	18-8307	-
45C	1985	18-2001	2	18-2063+18-2027	1	18-0543	1	18-8307	-
45C	1986	18-2001	2	18-2064+18-2059	1	18-0543	1	18-8307	-
45C	1987	18-2001	2	18-2063+18-2027	1	18-0543	1	18-8307	-
45C	1988-94	18-2001	2	18-2063+18-2027	1	18-0543	1	18-2001	-
45C	1995	18-2001	2	18-2064+18-2059	1	18-0543	1	-	-
48	1988-95	18-2060	2	18-2064+18-2059	1	18-0543	1	18-2063 (Inner)	1
50	1971-74	18-2001 (Manual)	2	18-2027	2	18-0543	1	18-2001	1
50	1975	18-2060	2	18-2059	1	18-0543	1	18-2001	1
50	1979	18-2001	2	18-2027	2	18-0543	1	18-2001	1
50	1980	18-2060	2	18-2059	1	18-0543	1	18-2001	1
50/60 (rope start)	1981-83	18-2001	2	18-2027	1	18-0543	1	18-2001	1
50/60 (Electric)	1981-83	18-2060	2	18-2059	1	18-0543	1	18-2001	1
50/60	1984-85	18-2060	2	18-2059	1	18-0543	1	18-2001	1
50/60 Small Gearcase	1986-87	18-2060	2	18-2064+18-2059	1	18-0543	1	18-2001	1
50/60 Large Gearcase	1986-87	18-2001	2	18-2064+18-2059	1	18-0543	1	18-2001	1
50/60	1988-89	18-2001	2	18-2064+18-2059	1	18-0543	1	18-2001	1
50	1990-95	18-2060	2	18-2064+18-2059	1	18-0543	1	18-2063 (Inner)	1
55	1968-69	18-2012	2	18-2059	2	18-0543	1	18-2001	1
55	1976-77	18-2060	2	18-2059	2	18-0543	1	18-2001	1
55	1978	18-2059	1	18-2059	2	18-0543	1	18-2001	1
55	1979-83	18-2001	2	18-2027	1	18-0543	1	18-2001	1
55 (Electric)	1980-83	18-2012	2	18-2059	2	18-0543	1	18-2001	1
55C	1984	18-2001	2	18-2063+18-2027	1	18-0543	1	18-2001	1
55C	1985	18-2001	2	18-2063	1	18-0543	1	18-2001	1
55C	1986	18-2001	2	18-2064+18-2059	1	18-0543	1	18-8307	-
55C	1987-94	18-2001	2	18-2063+18-2027	1	18-0543	1	18-8307	-
55C	1995	18-2001	2	18-2064+18-2059	1	18-0543	1	-	-
60 (Manual Shift)	1964-68	18-0173	1	18-0174	1	-	-	-	-
60	1970	18-2012	1	18-2059	2	18-0543	1	18-2001	1
60 (3 Cylinder)	1971	18-2001	2	18-2059	2	18-0543	1	18-2001	1
60 (Rope)	1980-83	18-2001	2	18-2027	2	18-0543	1	18-2001	1
60 (Electric)	1980-83	18-2001	2	18-2059	2	18-0543	1	18-2001	1

OIL SEAL APPLICATION (Cont.)

HP	YEARS	PROPSHAFT	QTY.	DRIVESHAFT	QTY.	UPPER CRANKCASE	QTY.	LOWER CRANKCASE	QTY.
60	1984-85	18-2060	2	18-2059	2	18-0543	1	18-2001	1
60SST	1989	18-2060	2	18-2064+18-2059	1	18-0543	1	18-2001	1
60SST	1990	18-2060	2	18-2064+18-2059	1	18-0543	1	18-8307	-
60 (3 Cylinder)	1987-95	18-2001	2	18-2064+18-2059	1	18-0543	1	18-8307	-
65 (Manual Shift)	1968	18-0173	1	18-0174	1	18-0543	1	-	-
65 (3 Cylinder)	1972-73	18-2001	2	18-2059	2	18-0543	1	18-2001	1
65C	1984-85	18-2001	2	18-2059	2	18-0543	1	18-2001	1
65C	1986-89	18-2001	2	18-2064+18-2059	1	18-0543	1	18-2001	1
70 (Large Gearcase)	1974-85	18-2001	2	18-2059	2	18-0543	1	18-2001	1
70 (Large Gearcase)	1986-95	18-2001	2	18-2064+18-2059	1	18-0543	1	18-8307	-
70 (Small Gearcase)	1977-85	18-2060	2	18-2059	2	18-0543	1	18-8307	-
75 (Manual Shift)	1960-62	18-0173	1	18-0174	1	-	-	-	-
75 (Large Gearcase)	1975-84	18-2001	2	18-2059	2	18-0543	1	18-2001	1
75 (Large Gearcase)	1986-87	18-2001	2	18-2064+18-2059	1	18-0543	1	18-8307	-
75 (Small Gearcase)	1975-84	18-2060	2	18-2059	2	18-0543	1	18-2001	1
80	1966-68	18-0173	1	18-0174	1	-	-	-	-
85	1969-70	18-2012	2	18-2059	2	18-2074	1	18-2001	1
85	1971-72	18-2001	2	18-2059	2	18-2074	1	18-2001	1
85	1973-80	18-2001	2	18-2026	2	18-2074	2	18-2001	1
88	1987-94	18-2001	2	18-2061+18-2062	1	18-2074	2	18-8307	-
90	1981-83	18-2001	2	18-2026	2	18-2074	2	18-2001	1
90	1984-94	18-2001	2	18-2061+18-2062	1	18-2062	1	18-8307	-
90 Seadrive	1985-90	18-2001	2	18-2061+18-2062	1	18-2074	2	18-2001	1
100	1971-72	18-2001	2	18-2059	2	18-2074	1	18-2001	1
100	1979-80	18-2001	2	18-2026	2	18-2074	2	18-2001	1
100C	1984-90	18-2002	2	18-2061+18-2062	1	18-2074	2	18-8307	-
110	1986-88	18-2001	2	18-2061+18-2062	1	18-2074	2	18-2001	1
115	1969-70	18-2012	2	18-2059	2	18-2074	1	18-2001	1
115	1973-83	18-2001	2	18-2026	2	18-2074	1	18-2001	1
115	1984-85	18-2001	2	18-2061+18-2062	1	18-2074	2	18-2001	1
115	1990-94	18-2001	2	18-2061+18-2062	1	18-2074	2	18-8307	-
120	1985	18-2002	2	18-2061+18-2062	1	18-2074	2	18-2075	2
120	1986-88	18-2001	2	18-2061+18-2062	1	18-2074	2	18-2075	2
120	1989	18-2002	2	18-2061+18-2062	1	18-2074	2	18-2075	2
120	1990-94	18-2001	2	18-2061+18-2062	1	18-2074	2	18-2075	2
125	1971-72	18-2001	2	18-2059	2	18-2074	1	18-2001	1
125C	1989	18-2002	2	18-2061+18-2062	1	18-2074	2	18-2075	1
125C (ESX models)	1989	18-2001	2	18-2061	1	18-2062	1	18-2075	1
135	1973-76	18-2001	2	18-2026	2	18-2074	2	18-2001	1
140	1977-83	18-2001	2	18-2026	2	18-2074	2	18-2001	1
140	1984	18-2001	2	18-2026	2	18-2074	2	18-2001	1
140	1985	18-2002	2	18-2061+18-2062	1	18-2074	2	18-2075	2
140	1986-94	18-2001	2	18-2061+18-2062	1	18-2074	2	18-2075	2
140TX	1989	18-2002	1	18-2061+18-2061	1	18-2074	2	18-2075	2
150	1978-83	18-2002	2	18-2026	2	18-2074	2	18-2075	2
150	1984	18-2002	2	18-2061+18-2062	1	18-2074	2	18-2075	2
150	1985-90	18-2002	2	18-2061+18-2062	1	18-2074	2	18-8307	-
155C	1984-85	18-2002	2	18-2061+18-2062	1	18-2074	2	18-2001	1
155C	1986-90	18-2002	2	18-2061+18-2062	1	18-2074	2	18-8307	-
175	1977-85	18-2002	2	18-2026	2	18-2074	2	18-2001	1
175	1986-90	18-2002	2	18-2061+18-2062	1	18-2074	2	18-8307	-
185	1984-85	18-2002	2	18-2061+18-2062	1	18-2074	2	18-2001	1
185	1990	18-2002	2	18-2061+18-2062	1	18-2074	2	18-2075	1
200	1976-83	18-2002	2	18-2026	2	18-2074	2	18-2001	1
200	1984-85	18-2002	2	18-2061+18-2062	1	18-2074	2	18-8307	-
200,225	1986-90	18-2002	2	18-2061+18-2062	1	18-2074	2	18-2075	2
235	1978-83	18-2002	2	18-2026	2	18-2074	2	18-2001	1
235	1984-85	18-2002	2	18-2061+18-2062	1	18-2074	2	18-2001	1
275	1985-88	18-2002	2	18-2061+18-2062	1	18-2074	2	18-2075	2

OIL SEAL APPLICATION - DRIVESHAFT HOUSING

HP	Years	Sierra Oil Seal	Qty.	Desc.	HP	Years	Sierra Oil Seal	Qty.	Desc.
5/6/6.5/8 ①	1987-90	18-2034	1	EH,L	75/80/85	1961-68	18-2060	1	PS
45/55 ①	1990	18-2063	1	EH A	90/100	1964-68	18-2060	1	PS
50/60/65	1958-68	18-2060	1	PS					

① Commercial models also
PS Pivot shaft

EH A Exhaust housing to adapter
EH,L Driveshaft to exhaust housing

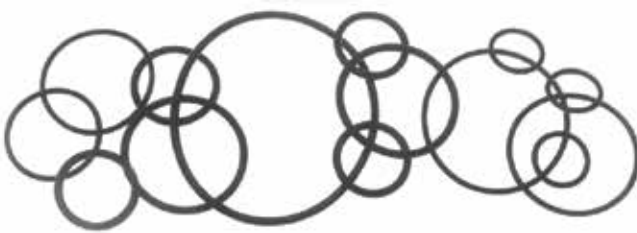

O-RINGS

Part #	O.E. #	Dimensions (in)	
		I.D.	Width
18-7100 ②⑤	301877	.245	.155
18-7101 ②⑤	305739	.250	.065
18-7102 ②⑤	307450	.430	.065
18-7103 ②⑤	308624	.924	.103
18-7104 ②⑤	308627	2.210	.135
18-7105 ②⑤	311338	.750	.065
18-7107 ②⑤	313175	4.750	.135
18-7108 ②⑤	313893	2.550	.100
18-7108 ②⑤	338518	2.550	.100
18-7109 ②⑤	317178	.214	.048
18-7111 ①	301824	.197	.113
18-7112 ①	302493	1.170	.135
18-7114 ②	302540	1.000	.135
18-7115 ①	302588	1.735	.135
18-7116 ①	303067	.360	.100
18-7117 ①	303360	1.060	.135
18-7118 ②⑤	305242	.300	.135
18-7120 ①	307853	.215	.065
18-7121 ①	308621	3.100	.135
18-7123 ①	308876	2.235	.100
18-7126 ①	313340	1.690	.100
18-7127 ①	313446	3.315	.135
18-7128 ①	313754	1.835	.100
18-7129 ②⑤	314491	.970	.065
18-7130 ①	314728	2.125	.100
18-7133 ②⑤	305123	3.780	.135
18-7133 ②⑤	322119	3.780	.135
18-7134 ②⑤	303059	.500	.100
18-7135 ①	310584	.750	.135
18-7137 ②⑤	318372	0.320	.155
18-7138 ②⑤	318717	1.500	.210
18-7139 ②⑤	319085	1.080	.210
18-7140 ②⑤	320303	2.750	.135
18-7141 ②⑤	321117	.180	.065
18-7142 ②	322119,	3.940	.135
18-7143 ②⑤	322501, 331188	1.310	.100
18-7144 ②⑤	326849	4.250	.135
18-7145 ②⑤			
18-7146 ②⑤			
18-7150 ③⑤			
18-7150 ③⑤			
18-7150 ③⑤			
18-7152 ②⑤			
18-7153 ②⑤			
18-7153 ②⑤			
18-7155 ②⑤			
18-7156 ②⑤			
18-7158 ②⑤			
18-7158 ②⑤			
18-7162 ②⑤			
18-7164 ②⑤			
18-7165 ②⑤			
18-7167 ②⑤			
18-7168 ②⑤			
18-7169 ②⑤			
18-7170 ②⑤			
18-7172 ②⑤			
18-7173 ②⑤			
18-7174 ②⑤			
18-7174 ②⑤			
18-7178 ②⑤			
18-7180 ②⑤			
18-7198 ②⑤			
18-7400 ②⑤			
18-7401 ②⑤			
18-7403 ②⑤			
18-7404 ②⑤			
18-7406 ②⑤			
18-7407 ②⑤			
18-7407 ⑤			
18-7408 ②⑤			
18-7409 ②⑤			
18-7411 ②⑤			
18-7413 ②⑤			
18-7416 ②⑤			
18-7417 ②⑤			
18-7418 ②⑤			
18-7440-1 ④			
18-7457 ①			
18-7461 ①			
18-7475 ①⑤			
■18-7477 ②⑤			
18-7510 ⑤			

① PKG. OF 1 ② PKG. OF 5 ③ PKG. OF 10 ④ PKG. OF 2 ■ Indicates quad rings rather than O-Rings

⑤ This product is priced per piece. To order priced per package, please add -9 to the part number.

POWERHEAD				
HP	YEAR	O RING	QTY	DESC
5.5	1959	18-7180	1	LC
9.5	1964-73	18-7156	1	UC
18	1957-72	18-7114	1	CCH
18/25	1957-76	18-7164	1	LLC
20/25 ①	1977,79-90	18-7174	1	LC
20/25	1990-95	18-7146	1	CCH O
25/35	1957,69-76	18-7114	1	CCH
25/18	1971-76	18-7164	1	UC
25 ⑥	1989-90	18-7123	1	CCH
25 ⑥	1989-90	18-7457	1	UC
25/35	1978	18-7134	1	LC
28	1962-64	18-7164	1	LLC
28/30/35	1976-77,79-90	18-7174	1	LC
28/30/35	1990-95	18-7146	1	CCH O
33/35/40	1957-75	18-7164	1	LLC
35	1987	18-7128	1	UC
35	1987	18-7123	1	CCH
40/45 ①	1976,81-95	18-7123	1	CCH
40) ①	1976,81-95	18-7128	1	UC
45/45SS ①	1985-95	18-7128	1	UC
45SS/48	1987-95	18-7123	1	CCH
48/50/55 ①	1971-95	18-7128	1	UC
50	1958-59	18-7133	1	CCH
50/55 ①	1968-90	18-7123	1	CCH
55/60	1968-71	18-7117	1	CCH O
60/65/75/80	1960-68	18-7133	2	CCH
60/SST60	1970-71,81-95	18-7128	1	UC
60/SST60	1970-95	18-7123	1	CCH
60/SST60	1989-90	18-7158	1	LC
65 ①	1972-73,85-95	18-7123	1	CCH
65 ①	1972-73,85-95	18-7128	1	UC
65/70 ①	1989-90	18-7158	1	LC
70	1974-90	18-7123	1	CCH
70	1974-90	18-7128	1	UC
75	1975-88	18-7128	1	UC
75	1975-88	18-7123	1	CCH
V-4	1969-71	18-7117	1	CCH O
85)	1968-80	18-7133	4	CCH
88/90/100 ①	1964,81-95	18-7133	4	CCH
100	1966	18-7120	4	CCHS
110/115	1969-95	18-7133	4	CCH
125/135/140	1971-84	18-7133	4	CCH
150/155/175 ①	1977-90	18-7133	4	CCH
200/235/185	1976-85	18-7133	4	CCH

CCH S Crankcase Head Screw
 LC Lower Crankshaft
 LLC Large Lower Crankshaft
 ① Commercial Models Only

CCH O Crankcase Head Outer
 UC Upper Crankshaft
 CCH Crankcase Head
 ⑥ 89 Models DR, DE, DT

POWERHEAD				
HP	YEAR	O RING	QTY	DESC
4	1969-90	18-7111	1	FC
5 THRU 300 ①	1957-90	18-7111	2	FC
20/25/30	1984-86	18-7101	1	EPMV
35/40	1984-86	18-7101	1	EPMV
45 ①	1986-87	18-7101	1	EPMV
50	1985-86	18-7101	1	EPMV
55 ①	1986-88	18-7101	1	EPMV
60/65/70 ①	1985-86	18-7101	1	EPMV
75	1983-86	18-7101	1	EPMV
V-4/6 ①	1980-86	18-7101	1	EPMV
200/225	1986-88	18-7115	1	EPP
V-8	1985-86	18-7115	1	EPP

① Commercial Models Also
 EPMV Electric Fuel Primer Manual Valve
 FC Fuel Connector
 EPP Electric Primer Pump

POWER TILT AND TRIM				
HP	YEAR	O RING	QTY	DESC
35/40/45 ①	1986-89	18-7168	1	LA
45SS	1988-90	18-7134	1	TEC
45SS	1988	18-7141	4	OL
50/55/60 ①	1981-89	18-7168	1	LA
60/70/75	1981-90	18-7174	2	MVS,L
60/70/75	1981-90	18-7141	4	OL
60/70/75	1981-90	18-7165	2	MVS,S
60/70/75	1981-90	18-7102	1	FP
70/75	1981	18-7174	1	TR
V-4/6 ①	1977-79	18-7168	3	RV
V-4/6 ①	1977-90	18-7174	1	TR
V-4/6/8	1977-90	18-7174	2	MVS,L
V-4/6/8 ①	1977-90	18-7102	1	FP
V-4/6/8 ①	1977-90	18-7165	2	MVS,S
V-4/6/8 ①	1977-90	18-7141	4	OL
85	1976-79	18-7168	1	LA
115/135	1974-77	18-7168	1	LA
200	1976	18-7168	3	RV
200/300	1990	18-7168	3	RV

① Commercial Models Also
 TEC Trim End Cap to Rod
 LA Line Assembly
 RV Relief Valve
 MVS,L Manifold Valve Seat, Large
 MVS,S Manifold Valve Seat, Small
 TR Trim rod
 OL Oil Line
 FP Fill Plug

POWER STEERING				
HP	YEAR	O RING	QTY	DESC
60/70/75	1981-90	18-7168	4	CP
V-4/6/8	1980-90	18-7168	4	CP
V-6/8	1986-90	18-7129	2	SC
V-6/8	1986	18-7135	3	PVHT

CP Pump Control Piston
 RV Pump Hsg. Relief Valve
 SV Spoon Valve
 SC Steering Cylinder
 PVHT Piston to Valve Hsg. Tube Seal

DRIVESHAFT HOUSING				
HP	YEAR	O RING	QTY	DESC
2.5	1987-88	18-7101	1	SS
4 ③	1981-90	18-7101	1	SS
4 ②	1984,86-90	18-7168	1	K&S
4 ④	1984,86-90	18-7146	2	SB
4.5	1980-84,86-87	18-7168	1	K&S
4.5	1980-87	18-7146	2	SB
4.5	1980	18-7146	1	EHC
5	1984-90	18-7168	1	K&S
5	1984-90	18-7146	2	SB
6	1984-90	18-7168	1	K&S
6	1984-90	18-7146	2	SB
6.5 ①	1989-90	18-7168	1	K&S
6.5 ①	1989-90	18-7146	2	SB
7.5	1980-83	18-7146	2	SB
7.5	1980-83	18-7168	1	K&S
7.5	1980	18-7146	1	EHC
8	1984-90	18-7146	2	SB
8	1984-90	18-7168	1	K&S
28	1962-64	18-7115	1	SB
33	1965-70	18-7115	1	SB
35	1959	18-7114	1	PS
40	1960-70	18-7102	1	SS
40	1961-70	18-7114	1	PS
40 ⑤	1971-76,81-90	18-7115	1	SB
45SS	1987,88	18-7115	1	SB
60	1964-67	18-7180	4	SA
65	1968	18-7180	4	SA
75	1960-61,64-65	18-7180	4	SA
80	1966-67	18-7180	4	SA

DRIVESHAFT HOUSING (Cont.)				
HP	YEAR	O RING	QTY	DESC
85	1968	18-7180	4	SA
90	1964-65	18-7180	4	SA
100	1966-68	18-7180	4	SA
① Commercial		K&S Knob & Shaft to Swivel Bracket		
② "RD" Models Only		PS Pivot Shaft		
③ "BR" "RL" "RC" "RE" Models Only		SS Shift Shaft		
④ "R" "RD" Models Only		SA Shock Absorber		
⑤ '82-'90 Commercial		SB Swivel Bracket		
EHC Exhaust Housing Cover				

GEARCASE				
HP	YEAR	O RING	QTY	DESC
1.5/2	1968-90	18-7173	1	PBH
2/2.5/4	1988-90	18-7145	1	D&F S
3/4	1957-79	18-7168	1	DS CC
3/4 Std. Gearcase	1964-80	18-7173	1	PBH
4	☆ 1981-95	18-7162	1	PBH
4 RD Models	1984,86-95	18-7118	1	SR
4.5	1980-87	18-7118	1	SR
5/5.5	1957-68	18-7180	1	DS BH
5	1965-68	18-7173	1	PBH
5/6/108	1984-95	18-7118	1	SR
5/6/6.5/8 6.5 HP Comm	1988-95	18-7145	2	D&F S
5/6/108	1989-95	18-7168	1	WT E
5.5/6	1957-79	18-7100	1	SR
5.5/6/7.5	1957-79	18-7117	1	PBH
5.5	1964	18-7120	1	SR PP
6/7.5	1957-79	18-7180	1	DS BH
6	1965-79	18-7120	1	SR PP
6.5/7.5 7.5 HP Comm	1980-90	18-7118	1	SR
6.5 Comm	1989-90	18-7168	1	WT E
7.5/9.5	1957-73	18-7100	1	SR
9.5/10	1958-73	18-7117	1	PBH
9.5	1964-73	18-7120	1	SR PP
9.5	1965-66,68,70-73	18-7168	1	WT E
9.5/9.9/15	1974-84	18-7116	1	DS CC
9.9/15	1974-95	18-7100	1	SR
9.9/15	1974-95	18-7168	1	WT E
9.9/15	1974-90	18-7104	1	PBH
9.9/15	1974-90	18-7139	1	IH
9.9/15	1984-85	18-7120	1	SR PP
9.9/15	1986-95	18-7475	1	SR PP
9.9/15	1988-92	18-7145	2	D&F S
9.9/15	1993-96	18-4248	2	D&F S
10	1957	18-7112	1	PBH
10/14	⊕ 1957-63,88-90	18-7100	1	SR
10/18/25	1957-77	18-7116	1	DS CC
10/14 Comm	1988-90	18-7145	2	D&F S
14 Comm	1988-89	18-7475	1	SR PP
15A	1987-90	18-7174	1	WT
18/25	1957-76	18-7112	1	PBH
18/20/25	⊕ 1957-95	18-7100	1	SR
18/20/28	1964-85	18-7120	1	SR PP
20/25	1977,85-95	18-7105	2	IH S
20/25	1985-90	18-7146	1	IH
20/25	1985-95	18-7180	1	SR S
20/25	1985-95	18-7108	1	PBH
20/25	⊕ 1986-95	18-7475	1	SR PP
20/25/30	1987-95	18-7475	2	PBH S
20/25/28	⊕ 1988-95	18-7145	2	D&F S
20/25	1988-95	18-7100	1	IH
20/30	1990	18-7475	1	BS
25	⊕ 1969-86	18-7120	1	SR PP
25	1977	18-7109	2	PBH S
25	1978	18-7134	1	DS CC
25	1989-95	18-7475	1	BS
25	Ⓜ 1989-90	18-7172	1	PBH
25	Ⓜ 1989-90	18-7109	1	SR PP
25	Ⓜ 1989-90	18-7173	1	DS BH

GEARCASE (Cont.)				
HP	YEAR	O RING	QTY	DESC
25	Ⓜ 1989-90	18-7137	1	SR
28/33	1962-63,65-67	18-7165	1	WT E
28/33	1962-70	18-7134	1	DS CC
28/33/35	1962-70	18-7115	1	PBH
28	1963-64	18-7100	1	SR
28	1987-95	18-7475	1	SR PP
30/35/33	1965-70,84-85	18-7120	1	SR PP
30/33	1965-95	18-7100	1	SR
30/35	1976-86	18-7109	2	PBH S
30/35	① 1976-95	18-7108	1	PBH
30/35	1976-95	18-7105	2	IH S
30/35	① 1983-95	18-7180	1	SR S
30	1984-90	18-7146	1	IH
30/35	1986-95	18-7475	1	SR PP
30/35	① 1986-95	18-7100	1	IH
30/35	① 1987-95	18-7145	2	D&F S
35	1957-58	18-7165	1	WT E
35	Ⓜ 1957-59,87	18-7134	1	DS CC
35/40	Ⓜ 1957-90	18-7100	1	SR
35	1976-77	18-7174	1	DS CC
35	Ⓜ 1983-84,86-90	18-7146	1	IH
35	Ⓜ 1987	18-7140	1	PBH
35	Ⓜ 1987	18-7137	1	SR
35	Ⓜ 1987	18-7115	1	DS BH
35	Ⓜ 1987,90	18-7475	1	BS
35	Ⓜ 1987-90	18-7475	2	PBH S
40	② 1960-85,89-90	18-7115	1	PBH
40/48	1960-88	18-7134	1	DS CC
40	* 1962-70	18-7152	1	PBH
40	⊕ 1965-66,71,73-85	18-7120	1	SR PP
40	☆ 1966,70	18-7120	4	PBH S
40	1971,73-76,81-85	18-7165	1	WT E
40	1984	18-7109	4	PBH S
40/45	⊕ 1984-86	18-7120	1	BS
40/48	1984-88	18-7140	1	PBH
40/48	1984-88	18-7115	1	DS BH
40/45 45 HP Comm	1984-95	18-7137	1	SR
40/45 45 HP Comm	1987-95	18-7475	1	BSS
40/50	⊕ 1988-95	18-7145	2	D&F S
40/48/50	1989-90	18-7109	1	SR PP
40 Comm	1989-90	18-7165	1	WT E
40 Comm	1989-90	18-7475	1	SR PP
40/48/50	1989-95	18-7172	1	PBH
40/48/50	1989-95	18-7173	1	DS BH
45 Comm	1985-88	18-7134	1	IH
45 Comm	1985-95	18-7128	1	DS BH
45 Comm	1985-95	18-7127	1	PBH
45/48 45 HP Comm	1987-95	18-7145	2	D&F S
45SS	1987-90	18-7134	2	DS CC
45 Comm	1995	18-7475	4	PBH S
48	1987-88	18-7475	3	PBH S
48/50	1987-95	18-7475	1	BS
48	1987-95	18-7137	1	SR
50/60	1958-67	18-7118	1	SR
50/60/65	1958-68	18-7174	1	WT E
50/55	1958-69	18-7174	1	DS CC
50/55/60	1968-71	18-7126	1	DS BH
50/55	1968-72	18-7129	1	PS OP
50	1971	18-7100	1	SR
50	Ⓜ 1971-74,79,81	18-7127	1	PBH
50	⑨ 1971-81	18-7128	1	DS BH
50/55/60	1971-84	18-7109	4	PBH S
50/55	⊕ 1971-88	18-7134	1	DS CC
50	☆ 1973-74	18-7156	2	SA,L
50	☆ 1973-74	18-7146	1	SA,S
50/55	⊕ 1973-95	18-7137	1	SR
50	Ⓜ 1975,79,81,			

GEARCASE (Cont.)					GEARCASE (Cont.)				
HP	YEAR	O RING	QTY	DESC	HP	YEAR	O RING	QTY	DESC
	82-88	18-7115	1	DS BH	V-4	1966-68	18-7118	1	SR
50	⑧ 1975,79,81-88	18-7140	1	PBH	V-4	1966-68	18-7120	1	SR PP
50/60	1981-86	18-7120	1	BSS	80	1967	18-7120	4	PBH S
55	① 1968-69,79-81, 83-95	18-7127	1	PBH	V-4	1968-95	18-7127	1	PBH
55	⑩ 1976-82	18-7140	1	PBH	V-4	1969-72	18-7129	1	PS OP
55	⑩ 1976-82	18-7115	1	DS BH	V-4/6/8	1969-95	18-7130	1	DS BH
55	⑨ 1979-81,83-95	18-7128	1	DS BH	V-4	1971-86	18-7109	4	PBH S
55	⊕ 1981-88	18-7120	1	BS	V-4	1973-74	18-7146	1	SA,S
55 Comm	1988,90-95	18-7475	4	PBH S	V-4	1973-77	18-7156	2	SA,L
55 Comm	1989-95	18-7475	1	BS	V-4/6/8	1973-95	18-7137	1	SR
55 Comm	1989-95	18-7145	2	D&F S	V-4,6,8	1973-90	18-7158	1	DS CC
60 71 "E" Models	1964,66-67, 70-71	18-7120	4	PBH S	V-4	1975-77	18-7178	1	SA,S
60	⑦ 1964-67,80-87	18-7115	1	DS BH	V-4	1981-86	18-7120	1	BS
60/65/75 Std. Gearcase	1964-68	18-7152	1	PBH	V-4/6	1987-95	18-7475	4	PBH S
60	1964-71,86-88	18-7174	1	DS CC	V-4/6/8	1987-95	18-7475	1	BS
60 67 Std. Gearcase	1966-67	18-7120	1	SR PP	V-4/6/8	1987-95	18-7145	2	D&F S
60/65	1968-71	18-7129	1	PS OP	85/90	1964-68	18-7152	1	PBH
60	③ 1970-81,86-95	18-7127	1	PBH	100	1966-68	18-7167	1	PBH
60	③ 1980-81,86-95	18-7128	1	DS BH	100	⑦ 1984-90	18-7142	1	PBH
60	1980-85	18-7134	1	DS CC	100 Comm	1986-90	18-7475	1	BS
60	② 1980-87	18-7140	1	PBH	100 Comm	1987	18-7109	4	PBH S
60/SST60	1980-95	18-7137	1	SR	120	1985	18-7142	1	PBH
60/SST60/					125	1971	18-7173	1	PBH
65 65 HP Comm	1987-95	18-7475	1	BS	125 Comm	1989-90	18-7142	1	PBH
60/SST60/					125 Comm	1990	18-7174	1	WT
65 65 HP Comm	1987-95	18-7145	2	D&F S	140	1985,88-90	18-7142	1	PBH
SST60	1989-90	18-7140	1	PBH	V-6	1976-78	18-7178	1	SA,S
SST60	1989-90	18-7174	1	DS CC	V-6	1976-78	18-7156	2	SA,L
60/65/70 65 HP Comm	1989-90	18-7158	1	DS CC	V-6	1976-85	18-7109	4	PBH S
SST60	1989-90	18-7115	1	DS BH	V-6	1976-90	18-7142	1	PBH
65/75	1960-68	18-7118	1	SR	V-6	1986	18-7120	1	BS
65 Std. Gearcase	1968	18-7120	1	SR PP	155	⑧ 1984,89-90	18-7142	1	PBH
65 Std. Gearcase	1968	18-7115	1	DS BH	155	③ 1984-90	18-7144	3	PBH
65	⊕ 1968-73, 85-88,90	18-7174	1	DS CC	200/225	1987	18-7120	1	BS
65	⊕ 1971,73,85-86	18-7109	4	PBH S	V-8	1985-86	18-7120	1	BS
65	⊕ 1972-73,85-95	18-7127	1	PBH	V-8	1985-90	18-7144	3	PBH
65	⊕ 1973,85-95	18-7137	1	SR	V-8	1985-90	18-7174	1	WT
65	⊕ 1973,85-95	18-7128	1	DS BH					
65/70 75 "B" Models	1973-75	18-7156	2	SA,L					
65/70 75 "B" Models	1973-75	18-7146	1	SA,S					
65 Comm	1985-86	18-7120	1	BS					
65/70 65 HP Comm	1988-95	18-7475	4	PBH S					
70/75	1960-65,74-88	18-7174	1	DS CC					
70/75	1974-85	18-7109	4	PBH S					
70/75	1974-95	18-7137	1	SR					
70	⑦ 1974-95	18-7128	1	DS BH					
70	⑦ 1974-95	18-7127	1	PBH					
70 15" Transom	1977-85	18-7115	1	DS BH					
70 15" Transom	1977-85	18-7140	1	PBH					
70	1981-87	18-7120	1	BS					
70	1988-95	18-7475	1	BS					
70	1988-95	18-7145	2	D&F S					
75	1960,63-65	18-7120	4	PBH S					
75	1961-65	18-7174	1	WT E					
75	⑤ 1964-65,75-88	18-7115	1	DS BH					
75	1965	18-7120	1	SR PP					
75	⑥ 1975-87	18-7127	1	PBH					
75 20" Transom	1975-87	18-7128	1	DS BH					
75 15" Transom	1975-88	18-7140	1	PBH					
75	1981-86	18-7120	1	BS					
75	1987-88	18-7475	1	BS					
75	1987-88	18-7145	2	D&F S					
V-4	1964-66,68-70	18-7120	4	PBH S					
V-4	1964-67	18-7174	1	WT E					
V-4	1964-68	18-7115	1	DS BH					
V-4	1964-72	18-7174	1	DS CC					

- ① 35 hp '87 Models RC, RL
- ② '62-'70 w/o Selectric Shift/'89-'90 Comm.
- ③ '65 Std Gearcase/'75-'87 15" Transom
- ④ '76-'87 20" Transom
- ⑤ '77-'85 20" Transom
- ⑥ '79-'81 Electric Start
- ⑦ '79-'81 Rope Start
- ⑧ '79-'81 Rope Start/'82 Comm.
- ⑨ '79-'81 Rope Start/'83-'90 Comm.
- ⑩ '80-'81 Electric Start/'86-'87 — 15" Transom
- ⑪ '80-'81 Rope Start/'86,'87 — 20" Transom
- ⑫ '87 Models AR, AE
- ⑬ '87 Models RC, RL
- ⑭ '89 Models DR, DE, DT
- ⑮ '89 WTLZ, WTXZ Models '90 WTESM, WTXESM Comm.
- ⑯ '89 WTLZ, WTXZ / '90 WTLES, WTESM Comm.
- ⑰ '89 WTPLY, WTALY, WTPXY, WTAXY, '90 WTPLA, WTALA, WTPXA/Comm.
- ⑱ AR, AE Models
- ⊕ B, BR Models
- ⊕ Comm. Models Also
- ★ Electric Start
- * Selectric Shift

- BS Bearing Setscrew
- DS BH Driveshaft Bearing Hsg.
- DS CC Driveshaft to Crankcase
- D & F S Drain & Fill Screw
- WT E 5" Gearcase Extension, Water Tube
- GC 1 Gearcase (11 7/16")
- GC 2 Gearcase (12 7/8")
- GC3 Gearcase (19 1/2")
- IH Impeller Hsg.
- IHS Impeller Hsg. Spacer
- PBH Prop Bearing Hsg.
- PBH S Prop Bearing Hsg. Screw
- PS OP Prop Shaft Oil Pump
- SA,L Shift Assembly, Large
- SA,S Shift Assembly, Small
- SR Shift Rod
- SR PP Shift Rod Pivot Pin
- SR S Shift Rod Scraper
- WT Water Tube



**18-5225
SPARK PLUG WIRE KIT**
Kit includes 25 ft Roll of Hypalon Ignition Wire With a Copper Conductor and a Large Assortment of Three Different End Fittings to Fit McCulloch Motors
Wire available in 100' Spool **18-5226**



**18-5226
IGNITION WIRE
Metallic Core**
100' Spool
7mm Hypalon



**18-5153
CONTACT SET**
Replaces: 75101A,
1340135, 36550135



**18-5241
CONDENSER**
Replaces: 38850115

HP	Years	Contact Set	Condenser	HP	Years	Contact Set	Condenser
3.6	1953-57	18-5153	—	7.5	1961-68	18-5153 ②	—
6	1960-62	18-5153 ②	—	10	1958	—	18-5241 ②
7.5	1952-87	18-5153 ②	—	25	1959	18-5153 ② ③	—
7.5	1958	18-5153 ② ③	—	30 - 33	1955-56	18-5153 ②	—
7.5	1960	18-5153 ②	—	40	1957-59	18-5153 ② ③	—

② Two Required ③ REPCO Magneto Only

8' LENGTH COMPLETE FUEL LINE ASSEMBLIES

5/16" FUEL LINE ASSEMBLY 18-8013EP-1 SILVERADO 4000 Premium



**18-8004EP-1
PRIMER
BULB**



FUEL LINE ASSEMBLY COMPONENTS

8' LENGTH COMPLETE FUEL LINE ASSEMBLIES

3/8" FUEL LINE ASSEMBLY 18-8015EP-1 SILVERADO 4000 Premium



**18-8005EP-1
PRIMER
BULB**



FUEL LINE ASSEMBLY COMPONENTS

12' LENGTH COMPLETE FUEL LINE ASSEMBLIES

5/16" FUEL LINE ASSEMBLY 18-8032EP-1 SILVERADO 4000 Premium



**18-8004EP-1
PRIMER
BULB**



FUEL LINE ASSEMBLY COMPONENTS



Display Package

PRIMER BULB ASSEMBLY
Comes complete with two Hose Clamps



Display Package

**18-7852-1
FUEL WATER
SEPARATOR KIT**
Includes:
18-7845 Filter - 18-7853-1 Bracket
18-4256 1/4" (2) Brass Plugs
18-9004 Pipe Sealant with Teflon® is recommended for use on filter bracket fitting threads



Display Package

FUEL FILTER
18-7828-1 **18-7830**
(1/4" Small) (5/16")
18-7829 **18-7831**
(1/4" Large) (3/8")

Part #	Description
18-8002EP-1	For 1/4" I.D. Hose
18-8004PE-1	For 5/16" I.D. (large capacity bulb)
18-8005EP-1	For 3/8" I.D. (large capacity bulb)

* Tanks and Engines for picture purpose only.

MERCURY OUTBOARD

HP	CYL	BEG. S/N	YEAR	HP	CYL	BEG. S/N	YEAR	HP	CYL	BEG. S/N	YEAR
2.2	1	8075603	1984	8	2	C221500	1990	35	2	1755799	1965
2.2	1	8087123	1985	9.8	2	5206550	1979	35	2	1960827	1966
2.2	1	A800761	1986	9.8	2	5541280	1980-81	35	2	2097800	1967
2.2	1	A805221	1987	9.8	2	5965263	1982	35	2	2300972	1968
2.2	1	A817421	1988	9.8	2	6263906	1983	35	2	2487558	1969
2.2	1	A837101	1989	9.8	2	6438338	1984	35	2	6445653	1984
3	1	A855097	1990	9.8	2	6620196	1985	35	2	6626696	1985
3.4 L	6	6436883	1984	9.8 (100)	2	1397581	1961	35	2	A922171	1986
3.4 L	6	A129445	1985	9.8 (110)	2	1455240	1962	35	2	B110789	1987
3.4 L	6	A912426	1986	9.8 (110)	2	1474328	1963	35	2	B238644	1988
3.5	1	6202173	1983	9.8 (110)	2	1607083	1964	35	2	B393190	1989
3.5	1	6434771	1984	9.8 (110)	2	1742746	1965	35 (300)	4	1271885	1960
3.5	1	6594744	1985	9.8 (110)	2	1865779	1966	40	2	2874704	1970
3.6	1	5404657	1980-81	9.8 (110)	2	2098352	1967	40	2	3043031	1971
3.6	1	5910968	1982	9.8 (110)	2	2290663	1968	40	2	3219678	1972
3.9	1	1655013	1964	9.8 (110)	2	2508759	1969	40	2	3474578	1973
3.9	1	1738941	1965	9.8 (110)	2	2798057	1970	40	2	3859435	1974
3.9	1	1865633	1966	9.8 (110)	2	3002814	1971	40	2	4118385	1975
3.9	1	2098037	1967	9.8 (110)	2	3263263	1972	40	2	4362215	1976
3.9	1	2278851	1968	9.8 (110)	2	3482753	1973	40	2	4564002	1977
4	1	2498136	1969	9.8 (110)	2	3795658	1974	40	2	4860103	1978
4	1	2771662	1970	9.8 (110)	2	4079675	1975	40	2	5174089	1979
4	1	3028361	1971	9.8 (110)	2	4304785	1976	40	2	5556230	1980-81
4	1	3296137	1972	9.8 (110)	2	4605112	1977	40	2	5991215	1982
4	1	3529446	1973	9.8 (110)	2	4839254	1978	40	2	6228285	1983
4	1	3764825	1974	9.9	2	A918999	1986	40	4	C159200	1989
4	2	5589202	1980-81	9.9	2	B114231	1987	40	4	C221500	1990
4	2	9075839	1976	9.9	2	B233200	1988	40 350	2	1356948	1961
4	2	9172806	1978	9.9	2	B385500	1989	45	4	1476510	1962
4	1	A818721	1988	9.9	2	C221500	1990	45	4	A914859	1986
4	1	A837101	1989	10	2	1290910	1960	45	4	B110789	1987
4	1	A855097	1990	15	2	1288910	1960	45	4	B238644	1988
4	1	A906702	1986	15	2	1346448	1961	45	4	B393190	1989
4	1	B114109	1987	15	2	B293117	1988	45 (400)	4	1279685	1960
4.5	1	4108120	1975	15	2	B385500	1989	45 (400)	4	1384806	1961
4.5	1	4377557	1976	15	2	C221500	1990	50	4	1421113	1961
4.5	1	4597262	1977	18	2	5860332	1980-81	50	4	1477910	1962
4.5	1	4869518	1978	18	2	5954911	1982	50	4	1552535	1963
4.5	1	5270784	1979	18	2	6171607	1983	50	4	1605952	1964
4.5	1	5595532	1980-81	18	2	6443973	1984	50	4	1755549	1965
4.5	1	6025119	1982	18	2	6617631	1985	50	4	1870389	1966
4.5	1	6232381	1983	20	2	1558310	1963	50	4	2097445	1967
4.5	1	6428076	1984	20	2	1606903	1964	50	4	2305101	1968
4.5	1	6608536	1985	20	2	1755849	1965	50	4	2514919	1969
5	1	A819951	1988	20	2	1866496	1966	50	4	2736807	1970
5	1	A837101	1989	20	2	1997990	1967	50	4	3009934	1971
5	1	A855097	1990	20	2	2296267	1968	50	4	3235063	1972
6	2	1408611	1961	20	2	2550065	1969	50	4	3478003	1973
6	2	1485612	1962	20	2	2827677	1970	50	4	3816308	1974
6	2	1551443	1963	20	2	2991679	1971	50	4	4141450	1975
6	2	1607513	1964	20	2	3226958	1972	50	4	4357650	1976
6	2	1745521	1965	20	2	3537531	1973	50	4	4576237	1977
6	2	1958278	1966	20	2	3755885	1974	50	4	4962056	1978
6	2	2096171	1967	20	2	4103290	1975	50	4	5193259	1979
6	2	2284857	1968	20	2	4293920	1976	50	4	5531630	1980-81
6	2	A910596	1986	20	2	4580036	1977	50	4	5949386	1982
6	2	B114231	1987	20	2	4819249	1978	50	4	6275323	1983
6	2	B233200	1988	20	2	5183393	1979	50	4	6448808	1984
6	2	B385500	1989	20	2	5606492	1980-81	50	4	6586624	1985
7.5	2	2529895	1969	20	2	A910971	1986	50	3	A912478	1986
7.5	2	2810637	1970	20	2	B114231	1987	50	3	B110789	1987
7.5	2	3016581	1971	20	2	B238464	1988	50	3	B239242	1988
7.5	2	3274633	1972	20	2	B385500	1989	50	3	B396036	1989
7.5	2	3488153	1973	20	2	C221500	1990	50	3	C221500	1990
7.5	2	3801458	1974	22 (200)	2	1292910	1960	60	3	1303411	1960
7.5	2	4087015	1975	22 (200)	2	1339948	1961	60	3	6428681	1984
7.5	2	4314385	1976	25	2	1467499	1962	60	3	6609651	1985
7.5	2	4691222	1977	25	2	5705532	1980-81	60	3	A197392	1986
7.5	2	4851693	1978	25	2	5942041	1982	60	3	B110789	1987
7.5	2	5226935	1979	25	2	6185159	1983	60	3	B239242	1988
7.5	2	5524660	1980-81	25	2	6453343	1984	60	3	B396036	1989
7.5	2	5936301	1982	25	2	6593849	1985	60	3	C221500	1990
7.5	2	6239857	1983	25	2	A911346	1986	65	4	1542745	1963
7.5	2	6430041	1984	25	2	B114231	1987	65	4	1606282	1964
7.5	2	6611886	1985	25	2	B238464	1988	65	4	1765044	1965
8	2	A197112	1986	25	2	B385500	1989	65	4	1869564	1966
8	2	B114231	1987	25	2	C221500	1990	65	4	2119749	1967
8	2	B233200	1988	35	4	1570507	1963	65	4	2309311	1968
8	2	B385500	1989	35	2	1628795	1964	65	4	2503991	1969

MERCURY OUTBOARD

HP	CYL	BEG. S/N	YEAR	HP	CYL	BEG. S/N	YEAR	HP	CYL	BEG. S/N	YEAR
65	4	2803562	1970	90	3	B110054	1987	150	6	3752620	1974
65	4	2997339	1971	90	3	B240451	1988	150	6	4125985	1975
65	3	3293184	1972	90	3	C100000	1989	150XS	6	4319880	1976
65	3	3547987	1973	90	3	C221500	1990	150XS	6	4602012	1977
65	3	3807833	1974	90cc	2	A907702	1986	150XS	6	4868648	1978
65	3	4136685	1975	90cc	2	B114221	1987	V-150	6	4868998	1978
65	3	4382057	1976	95	6	1869776	1966	V-150	6	5129480	1979
70	3	1296411	1960	95	6	2097280	1967	V-150	6	5503247	1980-81
70	3	1413611	1961	100	6	1503332	1962	V-150	6	5944791	1982
70	3	1503459	1962	100	6	1518384	1963	V-150	6	6220254	1983
70	3	4382057	1976	100	6	1665002	1964	V-150	6	6443213	1984
70	3	4571652	1977	100	6	1755459	1965	V-150	6	6616991	1985
70	3	4825249	1978	100	6	2318586	1968	V-150	6	A904646	1986
70	3	5128280	1979	100	6	2484633	1969	V-150	6	B116662	1987
70	3	5579017	1980-81	100	4	B209468	1988	V-150	6	B242881	1988
70	3	5974683	1982	100	4	C100000	1989	V-150	6	C100861	1989
70	3	6279960	1983	100	4	C221500	1990	V-150	6	C221500	1990
70	3	B110054	1987	102cc	2	A819211	1988	V-150XR2	6	A905191	1986
70	3	B240451	1988	102cc	2	A837101	1989	V-150XR2	6	B289430	1988
70	3	C100000	1989	110	6	1870204	1966	V-150XR4	6	B242885	1988
75	4	6432901	1984	110	6	2097385	1967	V-175	6	4301235	1976
75	4	6613221	1985	115	6	2836019	1970	V-175	6	4563802	1977
75	4	A197882	1986	115	6	3023086	1971	V-175	6	4838074	1978
75	3	C100000	1989	115	6	3270480	1972	V-175	6	5180109	1979
75	3	C221500	1990	115	6	3525441	1973	V-175	6	5488752	1980-81
80	4	1335465	1960	115	6	3761035	1974	V-175	6	6618751	1985
80	4	1398630	1961	115	6	4112635	1975	V-175	6	A918329	1986
80	4	2559001	1969	115	6	4310785	1976	V-175	6	B116662	1987
80	4	2783253	1970	115	6	4567952	1977	V-175	6	B241881	1988
80	4	2986444	1971	115	6	4855153	1978	V-175	6	C100861	1989
80	4	3186263	1972	115	6	5168574	1979	V-175	6	C221500	1990
80	4	4831999	1978	115	6	5600967	1980-81	V-200	6	4839034	1978
80	4	5141097	1979	115	6	6006834	1982	V-200	6	5158929	1979
80	4	5582562	1980-81	115	6	6262961	1983	V-200	6	5464486	1980-81
80	4	5987161	1982	115	6	6440183	1984	V-200	6	6073192	1982
80	4	6232941	1983	115	6	6630171	1985	V-200	6	6203991	1983
80	3	A966142	1987	115	6	A907777	1986	V-200	6	6435503	1984
80	3	B240451	1988	115	6	B117567	1987	V-200	6	6625221	1985
80	3	C100000	1989	115	6	B239242	1988	V-200	6	A913228	1986
85	6	1460999	1963	115	4	C100000	1989	V-200	6	B116662	1987
85	6	1648888	1964	115	4	C221500	1990	V-200	6	B241881	1988
85	4	3493913	1973	125	6	2314956	1968	V-200	6	C100861	1989
85	4	3865695	1974	125	6	2536210	1969	V-200	6	C221500	1990
85	4	4092965	1975	135	6	2839369	1970	210cc	2	A918999	1986
85	4	4590512	1977	135	6	3036066	1971	210cc	2	B114231	1987
85XS	4	4366802	1976	V-135	6	A909997	1986	210cc	2	B233405	1988
90	6	1755444	1965	V-135	6	B116662	1987	210cc	2	B385500	1989
90	6	4854301	1978	V-135	6	B241881	1988	V-220	6	B241881	1988
90	6	5160324	1979	V-135	6	C100861	1989	V-225	6	5615282	1980-81
90	6	5594657	1980-81	V-135	6	C221500	1990	V-250	6	C139860	1989
90	6	5996390	1982	140	6	3293234	1972	V-250	6	C221500	1990
90	6	6246856	1983	140	6	4865678	1978	V-275	6	C139860	1989
90	6	6436123	1984	140	6	5189788	1979	V-275	6	C221500	1990
90	6	6623151	1985	140	6	5625108	1980-81	V-300	6	5611648	1980-81
90	6	A902436	1986	150	6	3502806	1973	V-300	6	6239853	1983



**18-5007
TUNE-UP KIT**

—CONTENTS—

Part #	O.E. #	Description
18-5153	398-174	Contact Set
18-5206	398-693	Condenser



**18-5012
TUNE-UP KIT**

—CONTENTS—

Part #	O.E. #	Description
18-5148	394-1100A3	Contact Set
18-5169	394-1130A1	Condenser



**18-5139
CONTACT SET**

Replaces: 336-4318A2
(2) 18-5139 = (1) 336-4318A2

 <p>18-5140 CONTACT SET Replaces: 398-2202</p>	 <p>18-5148 CONTACT SET Replaces: 394-1100A3</p>	 <p>18-5153 CONTACT SET Replaces: 398-174</p>	 <p>18-5169 CONDENSER Replaces: 394-1130A1</p>
 <p>18-5206 CONDENSER Replaces: 398-693</p>	 <p>18-5207 CONDENSER Replaces: 398-713</p>	 <p>18-5187 IGNITION COIL Replaces: 339-85699A1 For: Mariner 200DFI, 225DFI, V135DFI (2.5L), V150DFI (2.5L) and Mercury 3.0DFI</p>	
 <p>18-5180 IGNITION COIL Replaces: 392-825101T For: 40/45/50 4-stroke</p>	 <p>18-5182 IGNITION COIL Replaces: 823033 For: 2.5/3/3.3 HP</p>	 <p>18-5185 IGNITION COIL Replaces: 16064A1, 815113T02 For: 4/5 HP</p>	
 <p>18-5178 IGNITION COIL Replaces: 398-173</p>	 <p>①18-5181D Display Package 18-5181 IGNITION COIL Replaces: 802371A1</p>	 <p>①18-5186D Display Package 18-5186 IGNITION COIL Replaces: 339-7370A13, 339-832757A4</p>	
 <p>18-5433 IGNITION COIL Replaces: 32193A2, 38547, 392-806529A1, 898253T24 (Uses External Resistor)</p>	 <p>18-5775 SWITCH BOX Replaces: 332-7778A6, 332-7778A9,A12</p>	 <p>18-5776 SWITCH BOX Replaces: 339-7452A3</p>	

① Items ending in "D" are Display Packaged - Regular number is Non-Display



**18-5777
SWITCH BOX**
Replaces: 339-7452A15, A19



**18-5778
SWITCH BOX**
Replaces: 339-7452A14, A21

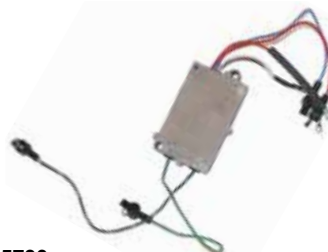

**18-5786
SWITCH BOX ASSEMBLY**
Replaces: 332-4911A2
For: 20 HP



**18-5787
SWITCH BOX ASSEMBLY**
Replaces: 332-4911A8
For: 40 HP



**18-5788
SWITCH BOX ASSEMBLY**
Replaces: 339-6222A8
For: 4 HP

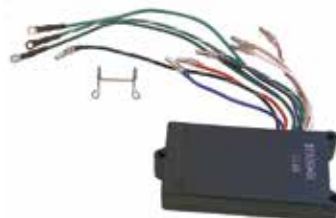

**18-5790
SWITCH BOX ASSEMBLY**
Replaces: 18495A26
For: 75-90 HP



**18-5791
SWITCH BOX ASSEMBLY**
Replaces: 19052A8
For: 50-60 HP



**18-5792
SWITCH BOX ASSEMBLY**
Replaces: 16061T
For: 4/5 HP



**18-5793
SWITCH BOX ASSEMBLY**
Replaces: 823034T
For: 2.5/3.3 HP



**18-5881
SWITCH BOX**
Replaces: 332-5772A7



**18-1151
DISTRIBUTOR
ROTOR SHAFT BEARING**
Replaces: 30-20066
SKF France R822T



**18-1152
DISTRIBUTOR
ROTOR SHAFT BEARING**
Replaces: 30-26379
SKF France 6002-2 RSI/HT

HP	Model	Beginning Serial No	Ending Serial No	Contact Set	Condenser	Tune-Up Kit	Coil	Switch Box
2 Stroke								
2.2M		A8075603	& UP	—	—	—	—	—
2.5		A855097	& UP	—	—	—	—	—
2.5 CD IGN		A855097	& UP	—	—	—	18-5182	—
3 CD IGN		A855097	& UP	—	—	—	18-5182	—
3.3		D901217	& UP	—	—	—	18-5182	—
3.5	⑤	358136	359615	—	—	—	—	—
3.6		540657	& UP	—	—	—	—	—
3.9		1655013	2498155	18-5140	18-5212	18-5008	—	—
4		2498136	2693114	18-5140	18-5212	18-5008	—	—
4	⑧	2771622	A809600	18-5139	—	—	—	—
4		A809601	& UP	—	—	—	—	—
4 (2 cyl.prod. of USA)		5589202	& UP	—	—	—	—	18-5788
4		G710613	& UP	—	—	—	—	18-5792
4.5		4107220	& UP	18-5139	—	—	—	—
5	⑤	338136	& UP	—	—	—	18-5178	—
5	⑦	338136	& UP	—	—	—	—	—
5 PHELON		574128	786612	—	—	—	18-5185	—
5		A809601	& UP	—	—	—	—	—
5.9 (Mark 6) (Phelon)		888005	1134535	—	—	—	18-5178	—

① Two Required ② Three Required ③ Four Required ④ Six Required ⑤ Phelon Magneto only ⑥ Manual start only
 ⑦ Bendix Scintilla Magneto Only ⑧ Except "Gnat" N/A Not Applicable
 ⑨ For Switch Box with Standard Nut Connections Uses 18-5776 – For Switch Box with Bullet Connections Uses 18-5777
 ⑩ For Switch Box with Standard Nut Connections Uses 18-5776 – For Switch Box with Bullet Connections Uses 18-5778

HP	Model	Beginning Serial No	Ending Serial No	Contact Set	Condenser	Tune-Up Kit	Coil	Switch Box
6	⑤	1184570	& UP	—	—	—	18-5178	—
6		1408611	1610264	—	—	—	18-5178	—
6		1610265	2529894	18-5140	18-5212	18-5008	—	—
6		A197112	G760299	—	—	—	18-5186 ①	18-5777
6		G760300	T800749	—	—	—	18-5186	—
7.5	⑤	214324	& UP	18-5153	18-5207	—	18-5178	—
7.5		2529895	2721150	18-5140	18-5212	18-5008	—	—
7.5		3274633	3801457	18-5139	—	—	—	—
7.5		3801458	& UP	—	—	—	—	—
8		A197112	G760299	—	—	—	18-5186 ①	18-5777
8		A760300	& UP	—	—	—	18-5186	18-5777
9.8		1470349	1865778	18-5153	18-5206	18-5007	18-5178	—
9.8		1865776	2708898	18-5140	18-5212	18-5008	—	—
9.8		2798057	3263262	18-5139	—	—	—	—
9.8		3263263	3795657	18-5139	—	—	—	—
9.8		3795658	& UP	—	—	—	—	—
210CC	Sail Power	A918999	& UP	—	—	—	18-5186 ①	18-5777
9.9		A197112	G760299	—	—	—	18-5186 ①	18-5777
9.9		G760300	& UP	—	—	—	18-5186	18-5777
10	PHELON			—	—	—	18-5178	—
10		1120828	112327	18-5153	18-5206	18-5007	18-5178	—
10		595628	112327	18-5153	18-5206	18-5007	18-5178	—
10		595628	& UP	18-5153	18-5206	18-5007	18-5178	—
10		D038000	G760299	—	—	—	—	18-5777
15		1200114	1499331	18-5153	18-5206	18-5007	18-5178	N/A
15		B292414	G760299	—	—	—	18-5186 ①	18-5777
15		G760300	& UP	—	—	—	18-5186	18-5777
15	SEA PRO	G044027	G437999	—	—	—	18-5186	—
15		G438000	G760299	—	—	—	18-5186	18-5777
15		G760300	& UP	—	—	—	18-5186	—
15	COMM	G760300	& UP	—	—	—	18-5186	—
15	NON COM	G760300	& UP	—	—	—	18-5186	—
15XD	COMM	G760300	& UP	—	—	—	18-5186	—
15XD	NON COMM	760300	& UP	—	—	—	18-5186	—
18		5837437	6443972	—	—	—	18-5186 ①	18-5776
18		6443973	& UP	—	—	—	18-5186 ①	⑨
18 BULLET	CONN	6443973	& UP	—	—	—	18-5186	—
20		860979	& UP	18-5153	18-5206	18-5007	18-5178	—
20		1558310	1592567	—	—	—	18-5178	—
20		1592568	2827676	—	—	—	—	—
20		2827677	3226957	18-5139	—	—	—	—
20		3226958	3537530	18-5139	—	—	—	—
20		3537531	3755884	—	—	—	18-5186	18-5786
20		3755884	4403786	—	—	—	—	—
20		4403787	6443972	—	—	—	—	—
20		6443973	G044026	—	—	—	18-5186 ①	18-5777
20		G044027	G437999	—	—	—	18-5186	—
20		G438000	G760299	—	—	—	18-5186 ①	18-5777
20	COMM	G760300	T800999	—	—	—	18-5186	—
20 NON	COMM	G760300	T800999	—	—	—	18-5186	—
20 JET		G044027	G760299	—	—	—	18-5186	—
20 JET		G760300	& UP	—	—	—	18-5186	—
22		1158546	1499331	18-5153	18-5206	18-5007	18-5178	—
25 KF9		377150	379008	18-5148	18-5169	18-5012	—	—
25 KG9		377150	379008	18-5148	18-5169	18-5012	—	—
25 MARK40		377150	379008	18-5148	18-5169	18-5012	—	—
25		5705532	6443972	—	—	—	18-5186 ①	18-5776
25	NUT	6443973	& UP	—	—	—	18-5186 ①	⑩
25	BULLET	6443973	& UP	—	—	—	18-5186	—
25		B238464	G044026	—	—	—	18-5186 ①	18-5777
25		G04027	G437999	—	—	—	18-5186	—
25		G438000	G760299	—	—	—	18-5186	—
25	COMM	G760300	& UP	—	—	—	18-5186	—
25	NONCOMM	G760300	& UP	—	—	—	18-5186	—
25		E268781	& UP	—	—	—	—	—
30	MK 30 55			—	18-5169	—	—	—
30		1271884	1448139	—	18-5169	—	—	—
30		G053314	G380074	—	—	—	—	—
30		G380075	G589999	—	—	—	—	—
30		G590000	T598999	—	—	—	—	—
30	Jet	C159200	G589999	—	—	—	18-5186 ①	18-5881
30	JET	G590000	T178499	—	—	—	—	—
35	350	1271884	1448139	18-5148	18-5169	18-5012	—	—
35	35A	1271884	1448139	—	18-5169	—	—	—
35		1571114	2874703	18-5140	18-5212	18-5008	—	—
35	NUT	6445653	B110788	—	—	—	18-5186 ①	⑩
35	BULLET	6445653	B110788	—	—	—	18-5186 ①	18-5778
35		B110789	& UP	—	—	—	18-5186	18-5778
40		831021	1279684	18-5148	18-5169	18-5012	—	—
40		1279685	1476509	—	18-5169	—	—	—
40		3336258	3859434	—	—	—	18-5186	—
40 (2 cyl.)		3859435	5823917	—	—	—	18-5186	18-5787
40 (2CYL)		3859435	5823917	—	—	—	—	—
40 (2 cyl.)		5823918	6443973	—	—	—	18-5186 ①	18-5776
40 (2CYL)		G053314	G380074	—	—	—	—	—
40 (2CYL)		G380075	G589999	—	—	—	—	—
40 (2CYL)		G590000	& UP	—	—	—	—	—
40 (3CYL)		G531301	T999999	—	—	—	—	—
40 LIGHT		N000513	& UP	—	—	—	—	—
40XR	LIGHTING	N000513	& UP	—	—	—	—	—
40 (4 cyl.)		C159200	& UP	—	—	—	18-5186 ③	18-5881
40	JET	T178500	& UP	—	—	—	—	—
45		1139538	& UP	18-5148	18-5169	18-5012	—	—
45		1476510	1531958	—	18-5169	—	—	—
45/50 (4 cyl.)		5531630	& UP	—	—	—	18-5186 ③	18-5881
45 (3CYL)	JET	G290584	G589999	—	—	—	18-5186	—

① Two Required ② Three Required ③ Four Required ④ Six Required ⑤ Phelon Magneto only ⑥ Manual start only
 ⑦ Bendix Scintilla Magneto Only ⑧ Except "Gnat" N/A Not Applicable
 ⑨ For Switch Box with Standard Nut Connections Uses 18-5776 – For Switch Box with Bullet Connections Uses 18-5777
 ⑩ For Switch Box with Standard Nut Connections Uses 18-5776 – For Switch Box with Bullet Connections Uses 18-5778

HP	Model	Beginning Serial No	Ending Serial No	Contact Set	Condenser	Tune-Up Kit	Coil	Switch Box
45 JET		G760300	T178499	—	—	—	18-5180	—
45 FOUR STROKE		G231123	T178499	—	—	—	18-5180	—
50		1421113	2305100	—	18-5169	—	—	—
50		1770179	2116317	—	18-5169	—	—	—
50	⑥	2116318	2305100	—	18-5169	—	—	—
50		2305101	2858813	—	—	—	—	—
50 (4CYL)		2858814	4140999	—	—	—	—	—
50 (4CYL)		4141000	4357639	—	—	—	—	—
50 (4CYL)		4357640	5193258	—	—	—	—	—
50 (4CYL)		5193259	5531629	—	—	—	18-5186	18-5881
50 (4CYL)		5531630	& UP	—	—	—	18-5186	18-5881
50 4-stroke & Bigfoot		G231123	T178499	—	—	—	18-5180	—
50/60 (3 cyl.)		6428681	D000749	—	—	—	18-5186 ②	18-5775
50/55/60 (3 cyl.)		D000750	G589999	—	—	—	18-5186 ②	18-5791
50 (3CYL)		G590000	T999999	—	—	—	—	—
55 (3CYL)		D000750	G589999	—	—	—	18-5186	—
55 (3CYL)		G590000	G760299	—	—	—	—	—
55 (3CYL)		G760300	& UP	—	—	—	—	—
60 MK75		1072997	& UP	—	—	—	—	—
60 (6CYL)		1303411	1542744	—	—	—	—	—
60 (3CYL)		6428681	D000749	—	—	—	18-5186	18-5775
60 (3CYL)		D000750	G589999	—	—	—	18-5186	—
60 (3CYL)		G590000	G760299	—	—	—	—	—
60 (3CYL)		G760300	& UP	—	—	—	—	—
65 (4CYL)		1542745	2309310	—	18-5169	—	—	—
65 (4CYL)	650	2309311	2803561	—	—	—	—	—
65 (4CYL)	650E	2309311	2803561	—	—	—	—	—
65 (4CYL)		2803562	2874263	—	—	—	—	—
65 (4CYL)		2997339	3293183	—	—	—	—	—
65 (3CYL)	3 3/8 COIL	3293184	3525440	—	—	—	—	—
65 (3CYL)	2 7/8 COIL	3293184	3525440	—	—	—	—	—
65 (3CYL)		4382057	4571651	—	—	—	—	18-5775
65 (3CYL)		3547987	4382056	—	—	—	—	—
65 JET		G438000	& UP	—	—	—	—	—
65 jet		D283222	G437999	—	—	—	18-5186	—
70	MK75,78	1110600	& UP	—	—	—	18-5433	—
70 (6CYL)		1296411	1566239	—	—	—	18-5433	—
Merc 70		4571652	5128279	—	—	—	—	18-5775
Mariner70		5128280	& UP	—	—	—	18-5186 ②	18-5775
70		1296411	1566239	—	—	—	18-5433 ①	—
70		5579016	6428680	—	—	—	18-5186 ②	18-5775
70/75 (3 cyl.)		C272000	D283221	—	—	—	18-5186 ②	18-5775
75 (3 cyl.)		D283222	G437999	—	—	—	—	18-5790
75 (4 cyl.)		6432901	& UP	—	—	—	18-5186 ③	18-5881
75 (3CYL)		C222000	D283221	—	—	—	18-5186	18-5775
75 (3CYL)		D283222	G437999	—	—	—	18-5186	—
75 (3CYL)		G438000	& UP	—	—	—	—	—
75 (3CYL)	OPTIMAX	T801000	& UP	—	—	—	—	—
80		1335465	1566239	—	—	—	18-5433 ①	—
Mariner 80 (4cyl.)		5144547	& UP	—	—	—	18-5186 ③	—
Merc 80 (4cyl.)		5582562	6432900	—	—	—	18-5186 ③	—
80		2559001	3493912	—	—	—	—	—
80 (4 cyl.)		4831999	5141096	—	—	—	—	18-5881
80 (4 cyl.)		5141097	6432900	—	—	—	18-5186	18-5881
80 (3 cyl.)		A996142	& UP	—	—	—	18-5186 ②	18-5775
80 Jet		D283222	G437999	—	—	—	—	18-5881
80JET		G438000	& UP	—	—	—	—	—
85 (6cyl)		1460999	1766823	—	—	—	18-5433 ①	—
85 (4cyl)		3493913	3865694	—	—	—	—	—
85 (4cyl)		3865695	4366801	—	—	—	—	—
85 (4 cyl.)		4366802	4831998	—	—	—	—	18-5881
90		1766824	1869775	—	—	—	18-5433 ①	—
90		4845301	5299505	—	—	—	—	—
90 (6 cyl.)		5299506	& UP	—	—	—	18-5186 ④	18-5775 ①
90 (3 cyl.)		A996142	D283221	—	—	—	18-5186 ②	18-5775
90 (3 cyl.)		D283222	G437999	—	—	—	18-5186	18-5790
90 (Powerhead)	Sport Jet	E023150	E095087	—	—	—	18-5775	—
90 (3CYL)		G438000	& UP	—	—	—	—	—
90 OPTIMAX		T801000	& UP	—	—	—	—	—
95		1869776	1935100	—	—	—	18-5433 ①	—
95		1935101	2318585	—	—	—	—	—
100 (6 cyl.)		1464949	2318585	—	—	—	18-5433 ①	—
100 (6CYL)		2318586	2536018	—	—	—	—	—
100 (6CYL)		2399698	2641854	—	—	—	—	—
100 (6CYL)		2641855	3253111	—	—	—	—	—
100 (4 cyl.)		B209468	G437999	—	—	—	18-5186 ③	18-5881
100 (4CYL)		G438000	& UP	—	—	—	—	—
105 Jet		D082000	G303045	—	—	—	18-5186 ④	18-5775 ①
110		1870204	2314955	—	—	—	18-5433 ①	—
115 (6CYL)		5314656	& UP	—	—	—	18-5186 ④	18-5775 ①
115 (6CYL)		2836019	2928720	—	—	—	—	—
115 (6CYL)		2928721	4112634	—	—	—	—	—
115 (6CYL)		4112635	5314655	—	—	—	—	—
115 (6CYL)		5314656	& UP	—	—	—	18-5186	—
115 (4CYL)		B209468	6437999	—	—	—	18-5186 ③	—
115 (4CYL)		G438000	& UP	—	—	—	—	—
115 (3CYL)	OPTIMAX	T801000	& UP	—	—	—	—	—
115 (3CYL)	PRO XS	B751825	& UP	—	—	—	—	—
115 (3CYL)		C100000	G437999	—	—	—	—	18-5881
125 (4CYL)		D283222	G437999	—	—	—	18-5186	18-5881
125 (6CYL)		2314956	2839368	—	—	—	—	—
125 (6CYL)		2400058	2641854	—	—	—	—	—
125 (6CYL)		2641855	3253111	—	—	—	—	—
125 (4CYL)		G438000	& UP	—	—	—	—	—
125 (3CYL)	OPTIMAX	B736885	& UP	—	—	—	—	—

① Two Required ② Three Required ③ Four Required ④ Six Required ⑤ Phelon Magneto only ⑥ Manual start only
 ⑦ Bendix Scintilla Magneto Only ⑧ Except "Gnat"
 ⑨ For Switch Box with Standard Nut Connections Uses 18-5776 – For Switch Box with Bullet Connections Uses 18-5777
 ⑩ For Switch Box with Standard Nut Connections Uses 18-5776 – For Switch Box with Bullet Connections Uses 18-5778

HP	Model	Beginning Serial No	Ending Serial No	Contact Set	Condenser	Tune-Up Kit	Coil	Switch Box
135		2839369	3293233	—	—	—	—	—
V-135		A904646	& UP	—	—	—	18-5186 ④	18-5775 ①
140		3293234	3502805	—	—	—	—	—
140		4865678	5327662	—	—	—	—	—
140		5327663	& UP	—	—	—	18-5186 ④	18-5775 ①
140 Jet		D082000	G960499	—	—	—	18-5186 ④	18-5775 ①
150		3502806	4865677	—	—	—	—	—
150 XS		4868648	5327662	—	—	—	—	—
150	V135	A904646	G960499	—	—	—	18-5186	18-5775
150	V135	G960500	T178499	—	—	—	—	—
V-150	ORGOIL	4868998	A904645	—	—	—	—	18-5775 ①
V-150	BLUCOIL	4868998	A904645	—	—	—	18-5186	—
V-150		5129480	G960499	—	—	—	18-5186 ④	18-5775 ①
V-150 XR2		6616991	A904645	—	—	—	18-5186 ④	18-5775 ①
0		B242885	D819999	—	—	—	18-5186 ④	18-5775 ①
V-150		G960500	& UP	—	—	—	—	—
V-150 XR6		D082000	T408999	—	—	—	—	①
V-150	EFI	T409000	& UP	—	—	—	—	—
V-150	DFI	G590000	B490865	—	—	—	18-5187	—
V-150	DFI	B490866	& UP	—	—	—	—	—
V-150	PRO XS	B690542	& UP	—	—	—	—	—
V-175		4301235	5180108	—	—	—	—	18-5775 ①
V-175,EFI, XR1		5180109	G960499	—	—	—	18-5186 ④	18-5775 ①
V-175 EFI		D000750	G960499	—	—	—	18-5186	—
V-175 EFI		G960500	T408999	—	—	—	—	—
V-175 EFI		T409000	T800999	—	—	—	—	—
V-175 DFI		T178500	B490865	—	—	—	18-5187	—
V-175 DFI		B490866	& UP	—	—	—	—	—
V-175 PRO		B516339	& UP	—	—	—	—	—
V-200	ORGOIL	4839034	5363917	—	—	—	—	①
v-200	BLUCOIL	4839034	5363917	—	—	—	—	—
V-200, XR1		5363918	G960499	—	—	—	18-5186 ④	18-5775 ①
v-200		G960500	& UP	—	—	—	—	—
V-200 EFI		C100861	G960499	—	—	—	18-5186	—
V-200 EFI		G303046	T408999	—	—	—	—	—
V-200 EFI	2.5L	T409000	& UP	—	—	—	—	—
V-200 EFI	3.0L	T750164	& UP	—	—	—	—	—
V-200 DFI		G386496	G589999	—	—	—	18-5183	—
V-200 DFI		G590000	B504988	—	—	—	18-5187	—
V-200 DFI		B504989	& UP	—	—	—	—	—
V-200 PRO		B504989	& UP	—	—	—	—	—
V-220		B117316	& UP	—	—	—	18-5186 ④	18-5775 ①
V-225	2.4L	5628028	& UP	—	—	—	18-5186 ④	18-5775 ①
V-225	3.0L	D280813	G303045	—	—	—	—	—
V-225	3.0L	G303046	T408999	—	—	—	—	—
V-225	3.0L	G245605	G303045	—	—	—	—	—
V-225	3.0L	G303046	T408999	—	—	—	—	—
V-225 EFI	3.0L	G129222	G303045	—	—	—	—	—
V-225 EFI	3.0L	G303046	T408999	—	—	—	—	—
V-225 EFI	3.0L	T409000	& UP	—	—	—	—	—
V-225 DFI		G590000	B504988	—	—	—	18-5187	—
V-225		B504989	& UP	—	—	—	—	—
V-225 PRO		B104549	B426650	—	—	—	18-5187	—
V-225 PRO		B426561	& UP	—	—	—	—	—
V-250 EFI	3.0L	G129222	T408999	—	—	—	—	—
V-250 EFI	3.0L	T409000	& UP	—	—	—	—	—
V-250	3.4L	C101891	& UP	—	—	—	18-5186	—
V-250 DFI		B528615	& UP	—	—	—	—	—
V-250 PRO		B426561	& UP	—	—	—	—	—
V-275	3.4L	C101891	& UP	—	—	—	18-5186	—
V-300	3.4L	5611648	& UP	—	—	—	18-5186	—

- ① Two Required ② Three Required ③ Four Required ④ Six Required ⑤ Phelon Magneto only ⑥ Manual start only
 ⑦ Bendix Scintilla Magneto Only ⑧ Except "Gnat"
 ⑨ For Switch Box with Standard Nut Connections Uses 18-5776 – For Switch Box with Bullet Connections Uses 18-5777
 ⑩ For Switch Box with Standard Nut Connections Uses 18-5776 – For Switch Box with Bullet Connections Uses 18-5778

PREMIUM MARINE SPARK PLUG WIRE LEADS

MAGFORCE™



OE style boots provide a sealed barrier against heat, dirt and moisture.

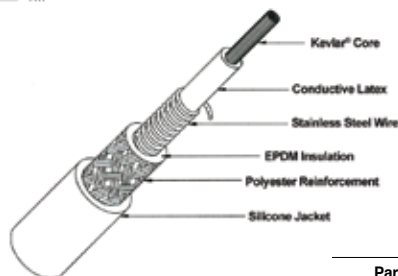

Premium Marine Wire Leads Magnetic Suppression Core Manufactured for your specific application

- ★ Kevlar® core for maximum durability and long life.
- ★ Durable stainless steel wound conductor for maximum horsepower and engine performance.
- ★ Premium silicone jacketing and boots for the ultimate in high temperature protection.
- ★ Superior RFI suppression for the most sensitive electronic system.
- ★ Corrosion resistant stainless steel spark plug and distributor terminals for maximum conductivity.

Part #	OEM #	Description
18-8819-1	—	7" Spark Plug Wire
18-5228-1	—	9" Spark Plug Wire
18-5228-1D ③	84-813715A1	9" Spark Plug Wire
★ 18-5227-1	—	9" Spark Plug Wire (7mm)
18-5227-1D ②③	84-813715A1	9" Spark Plug Wire (7mm)
18-5229-9-1 ①②	—	22" Spark Plug Wire
18-5230-9-1 ①②	—	10" Spark Plug Wire

★ Metallic core wire ① PKG. OF 5 ② 7mm copper core wire

③ Items ending in "D" are Display Packaged - Regular number is Non-Display

**18-5225
SPARK PLUG
WIRE KIT**

Replaces:
Mercury 84-99215A26, 84-813706A26
Kit includes 25 ft. Roll of 7 MM Hypalon
Ignition Wire With a Metallic Core and a
Large Assortment of Three Different End
Fittings to Fit Outboard Motors.



**18-5226
IGNITION WIRE
Metallic Core**

100' Spool
7mm Hypalon



**18-5511
WIRING HARNESS**

Replaces: 84-822253A20,
45876-20, 84-822253T20



PKG. OF 10



**18-5224
18-5224-9①
SPARK PLUG WIRE TERMINAL**

Replaces: Mercury 20121

PKG. OF 10



**18-5750
18-5750-9①
UNIVERSAL SPARK PLUG BOOTS**

Supplied complete w/Terminal Connector



**18-5752
UNIVERSAL
SPARK PLUG BOOT**

8mm

**MP41070-2
IGNITION SWITCH**

Push to Choke — 3 Position — 6 Wire Sealed Polyester
Replaces: 87-17009A2



**MP41000
IGNITION SWITCH**

Push to Choke — 3 Position — 6 Terminal
Replaces: 87-88107



**MP51090
MP51092
IGNITION SWITCH**

3 Position Magneto — OFF- RUN-START
PUSH to Choke
Replaces: 87-17009A5



**MP52000
MP52002
IGNITION SWITCH**

3 Position Magneto — OFF- RUN-START
PUSH to Choke
Replaces: 87-88107A5



**18-6751
MANUAL RELEASE VALVE**

Replaces: 893929A01, 813442A2,
813442A1, 811618A1, 811618,
812843A1, 99660A1
Fits: Most 2 & 4 Stroke Outboards with Integral
tilt and trim



**18-6771
TILT/TRIM RESERVOIR**

Replaces: 18525A1



**18-6778
TILT/TRIM RESERVOIR**

Replaces: 88316A1
For: Motors with 4 screw attachments



**18-6800
TRIM ASSEMBLY
(REMANUFACTURED)**

Replaces: 855998A09
Fits: 200HP DFI, 225HP EFI & Carb, 225HP DFI, 250 EFI, V-135, V-150, V-200, XR-6



(2 Wire w/ Relays)

**18-6273-1
TILT/TRIM MOTOR**
High Performance Cartridge Pump
w/Replaceable Motor

Replaces: 99186, 99186-1, 99186-T
Fits : 35-220 HP (1985-93) Mercury/Mariner Outboards
w/ Design I, 3 Ram, 3 Wire Tilt/Trim Units w/ Side Fill
Reservoir. Integral Trim/Tilt System



**18-6757
TILT/TRIM MOTOR**

Fits: Mercury 35-220 HP (1985-92) w/ Design I, 3-Ram
Side Fill Integral Trim/Tilt System w/ Square Style Eaton
Motor and 18-6273-1 Tilt/Trim Motor Pump Assy



**18-6763
TILT/TRIM MOTOR**

Replaces: 92975A28, A32
To 1984 for Most Mercury Outboards
(Motor and Reservoir Only)

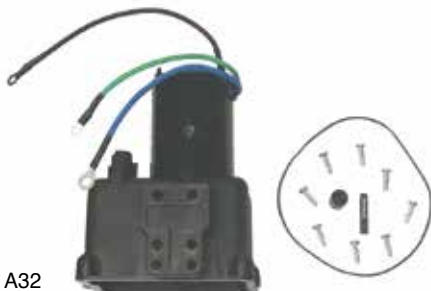

**18-6765
TILT/TRIM ASSEMBLY**

Replaces: 823653A5,
92459A4, 823653A9
Fits: 250, 275 HP & V-3.4L, Serial No. 5611648-UP



**18-6773
TRIM MOTOR**

Replaces: 828708, 878265A4
For most late model Mercury/Mariner 1996 & UP (135, 150,
XR6 Mag III, 175, 200, 225, 250 HP — 105 - 140 HP Jet)



**18-6774
TRIM MOTOR**

Replaces: 811628, 828708A1, 878265A6
High-performance cartridge, replaceable motor. Design II,
Ram 3, 3 wire, tilt/trim units. Squared style Eaton



**18-6775
TILT/TRIM MOTOR**

Reference OE reservoir 811673 1
Contains: All parts necessary, a new 3- wire mo-
tor/reservoir, drive shaft coupler, oil seal,
O-ring and hardware.
For:

Models	Models
65 Jet	100 4-Cyl.
75 3-Cyl.	115 4-Cyl.
80 Jet	125 4-Cyl.
90 3-Cyl.	

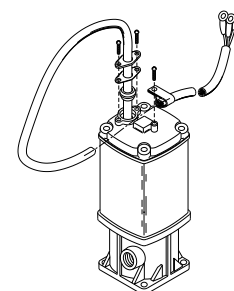

If you have this 3-wire single ram
system, use **18-6775**

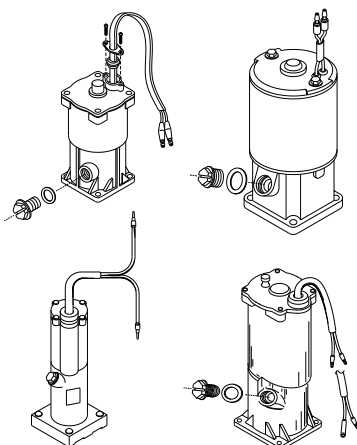

If you have any of the 2-wire single systems, use **18-6777**

18-6777

TILT/TRIM MOTOR

Replaces: 818903A1, 819762A4-A7, 819479A1, 819480A1,
81977A8-A9, 822870A1, 830250A3-T3, 832021A1-T4-A2-T2,
855654A1-T2, 19217A1-A5, 854472A2, A3, A4
Contains: All parts necessary, a new 2- wire motor/reservoir,
drive shaft coupler, oil seal, O-ring and hardware.

For:

Models	Models
30 Jet	60 3-Cyl., Bigfoot
30 4-Stroke	65 Jet
35	75 3-Cyl.
40 2, 3, 4-Cyl.	75 4-Stroke
40 4-Stroke, Bigfoot	80 Jet
45 4-Stroke, Bigfoot, Bodensee	90 3-Cyl.
50 3-Cyl.	90 4-Stroke
50 4-Stroke, Bigfoot	100 4-Cyl.
55 3-Cyl.	115 4-Cyl.
	125 4-Cyl.

**18-6784
TILT/TRIM MOTOR**

Replaces: Mercury Assembly 824051
2 wire motor with conversion kit including harness & relays.
For: Single ram 3-wire systems



**18-6274
TILT/TRIM MOTOR**

Replaces: 14336A20
Low pressure / high flow



BATTERY CABLES

Gauge Cable with soldered lug terminals on each end to accept a 3/8" stud.

Part No.	Size	Color	Gauge	Part No.	Size	Color	Gauge
BC88523	2'	red	4	BC88563	6'	red	2
BC88533	2'	black	4	BC88573	6'	black	2
BC88543	4'	red	2	BC88583	8'	red	1
BC88553	4'	black	2	BC88593	8'	black	1

**18-9800
COMPRESSION TESTER**

Perfect for hard to reach bottom spark plug holes on older Mercury models.



**18-9801
MULTI METER/DVA TESTER**

Replaces: 91-99750A1
A must for testing Mercury ignition systems.



**18-9802
TIMING LIGHT**

Replaces: 91-99379
Self-powered accurate up to 10,000 RPM's.



**18-5863
STATOR**

Replaces: 86617A17
For: 15-25 HP



**18-5864
STATOR**

Replaces: 86617A20
For: 6-25 HP



**18-5865
STATOR**

Replaces: 398-5704A7
For: 50-70 HP



**18-5866
STATOR**

Replaces: 76314A3
For: 45-50 4 cyl.



**18-5867
STATOR**

Replaces: 398-9873A4
For: 135-200 V-6



**18-5870
STATOR**

Replaces: 398-832075A4-A21
For: 30-125 HP
Replacement for the 18-5873 & 18-5874 kits



**18-5871
STATOR**

Replaces: 398-5454A32
For: 135-300 V6



**18-5873
STATOR**

Replaces: 398-832075A6
For: 100, 115, 125 HP





18-5874
STATOR
 Replaces: 398-832075A14/A20
 For: 30-50 HP



18-5875
STATOR
 Replaces: 398-9610A5
 For: 135-200 HP



18-5876
STATOR
 Replaces: 398-9610A19
 For: 135 -200 HP



18-5854
STATOR
 Replaces: 398-5454A17



18-5856
STATOR
 Replaces: 398-5255



18-5857
STATOR
 Replaces: 398-5454A7



18-5859
STATOR
 Replaces: 398-5454A26



18-5860
STATOR
 Replaces: 398-5454A35



18-5795
TRIGGER ASSEMBLY
 Replaces: 96455A11
 For: 90-220 HP 1979-92, 135-220 HP 1993-97



18-5796
TRIGGER ASSEMBLY
 Replaces: 96455A15
 For: 6 cyl.



18-5797
TRIGGER ASSEMBLY
 Replaces: 96455A8
 For: 3 cyl.



18-5798
TRIGGER ASSEMBLY
 Replaces: 96455A9
 For: 6 cyl.

STATOR & TRIGGER APPLICATIONS

HP	Beg. S/N	End S/N	Trigger	Stator	HP	Beg. S/N	End S/N	Trigger	Stator
6	A197112	G760299	—	18-5864	125 4 cyl	G438000	& UP	—	18-5870 **
7.5	2810637	3274632	—	18-5855	125 4 cyl (Belgium)	9927000	& UP	—	18-5870 **
8	A197112	G760299	—	18-5864	125 4 cyl with voltage reg.	D283222	G437999	—	18-5873 **
9.8	2798057	3263262	—	18-5855	125 4 cyl with				
9.9	A197112	G760299	—	18-5864	voltage reg. (Belgium)	9793577	9926999	—	18-5873 **
XR10,10 MAG & SEA PRO	D038000	G760299	—	18-5864	V135	A904646	C100860	18-5798	18-5860 ②
15	A197112	G760299	—	18-5864	V135	A904646	C100860	18-5798	18-5871
15 SEA PRO, SUPER 15	G044365	G437999	—	18-5863	V135	C100861	C239552	18-5798	18-5875
15 SEA PRO, SUPER 15	G438000	G760299	—	18-5864	V135	C239553	D081999	18-5798	18-5860 ③
18	5837437	6443972	—	18-5864	V135	C239553	D081999	18-5798	18-5875
18XD	6443973	B238463	—	18-5864	V135	C239553	D081999	18-5798	18-5867 ③⑥
20	2827677	3226957	—	18-5855	V135	D082000	G960499	18-5798	18-5876
20	6443973	G044026	—	18-5864	140	5327663	& UP	18-5798	18-5854
20, 20 JET	G044027	G437999	—	18-5863	140 JET	UP TO	G760299	18-5798	18-5876
20, 20 JET	G438000	G760299	—	18-5864	V150	4868998	A904645	18-5798	18-5857
20XD	6443973	B238463	—	18-5864	V150	A904646	C100860	18-5798	18-5860 ②
25	5705532	6443972	—	18-5864	V150	A904646	C100860	18-5798	18-5871
25, 25 SEA PRO & MARATHON	B238464	G044026	—	18-5864	V150	C100861	C239552	18-5798	18-5875
25, 25 SEA PRO & MARATHON	G044027	G437999	—	18-5863	V150	C239553	D081999	18-5798	18-5860 ③
25, 25 SEA PRO & MARATHON	G438000	G760299	—	18-5864	V150	C239553	D081999	18-5798	18-5875 †
25XD	5705532	G044026	—	18-5864	V150	C239553	D081999	18-5798	18-5867 ③⑥
30 2 cyl electric models	G055314	& UP	—	18-5870 **	V150	D082000	G960499	18-5798	18-5876
30 JET 3 cyl electric models	G590000	T408999	—	18-5870 **	V150 EFI	D082000	G960499	18-5798	18-5876
30 Jet 4 cyl electric models	C159200	D055047	—	18-5874 **	V150 XRI EFI	D082000	G303045	18-5798	18-5876
35 2 cyl	6445653	B110788	—	18-5864	150 XR-4	B242885	C100860	18-5798	18-5860
40 2 cyl	3859435	5823917	—	18-5856 ①	150 XR-4	C100861	C239552	18-5798	18-5875
40 2 cyl electric start	G055314	& UP	—	18-5870 **	150 XR-4	C239553	D081999	18-5798	18-5860 ③
40 3 cyl electric start	G531301	& UP	—	18-5870 **	150 XR-4	C239553	D081999	18-5798	18-5875 †
40 3 cyl electric start (Belgium)	9973100	& UP	—	18-5874 **	150 XR-4	C239553	D081999	18-5798	18-5867 ③⑥
40 4 cyl electric start	C159200	D055047	—	18-5874	150 XR-4, MAG II	C239553	D081999	18-5798	18-5875
40 JET electric start	T178500	& UP	—	18-5874 **	150 XR-4, MAG II	C239553	D081999	18-5798	18-5867 ③⑥
45 4 cyl manual start only	5531630	B110788	—	18-5866	150 XR-6, MAG III	D082000	G960499	18-5798	18-5876
45 4 cyl electric models	5531630	& UP	—	18-5870	V175	4301235	6618750	18-5798	18-5857
45 JET electric models	G590000	T129554	—	18-5874 **	V175	6618751	C100860	18-5798	18-5871 ④
50 4 cyl manual start only	4357640	& UP	—	18-5866	V175	6618751	C100860	18-5798	18-5857 ④
50 4 cyl electric models	4357640	& UP	—	18-5870	V175	6618751	C100860	18-5798	18-5860 ⑤
50 3 cyl	6428681	D000749	18-5797	18-5865	V175	C100861	C239552	18-5798	18-5875
50, 55 3 cyl electric start	G590000	& UP	—	18-5870 **	V175	C239553	D081999	18-5798	18-5860 ③
50 3 cyl electric models (Belgium)	9973100	& UP	—	18-5870 **	V175	C239553	D081999	18-5798	18-5867 ③⑥
55 3 cyl electric models	D000750	G589999	—	18-5870 **	V175	C239553	D081999	18-5798	18-5875 †
55 3 cyl electric models (Belgium)	9741042	9973088	—	18-5870 **	V175	D082000	G960499	18-5798	18-5876
60 3 cyl	6428681	D000749	18-5797	18-5865	V175 MAG, EFI	D000750	D081999	18-5798	18-5875
60 3 cyl electric models	G590000	& UP	—	18-5870 **	V175 EFI	D303046	G960499	18-5798	18-5876
60 3 cyl electric models (Belgium)	9973100	& UP	—	18-5870 **	V175 XRI EFI	D000750	D081999	18-5798	18-5875
60 3 cyl Bigfoot	G590000	G760299	—	18-5874 **	V175 XRI EFI	D082000	G303045	18-5798	18-5876
65 (650) 3 cyl	4382057	4571651	—	18-5865	V200	4839034	6625220	18-5798	18-5857 ④
70 3 cyl	4571652	A996141	18-5797	18-5865	V200	6618751	C100860	18-5798	18-5860 ⑤
75 4 cyl	6432901	& UP	—	18-5859	V200	C100861	D081999	18-5798	18-5860 ③
75 3 cyl electric models	G438000	& UP	—	18-5870	V200	C100861	C291519	18-5798	18-5875 †
80 (80, 800) 4 cyl	4831999	6432900	—	18-5859	V200	C100861	C291519	18-5798	18-5867 ③⑥
80 JET	G438000	& UP	—	18-5870 **	V200	D082000	G960499	18-5798	18-5876
85 (850) 4 cyl	4366802	4831998	—	18-5859	V200 EFI	C100861	OD081999	18-5798	18-5875
90 6 cyl	5299506	& UP	18-5798	18-5854	V200 EFI	G303046	G960499	18-5798	18-5876
90 3 cyl electric models	G438000	& UP	—	18-5870	V200 XRI EFI	C291520	D081999	18-5798	18-5875 †
90 3 cyl (Belgium) electric models	9927000	& UP	—	18-5870	V200 XRI EFI	D082000	G960499	18-5798	18-5876
100 4 cyl	G438000	& UP	—	18-5870 **	V220	B117316	& UP	18-5795	18-5860
100 4 cyl	9927000	& UP	—	18-5870 **	V225	5628028	& UP	18-5798	18-5857
100 4 cyl with voltage reg.	B209468	G437999	—	18-5873 **	SPORTJET MODELS				
100 4 cyl with voltage reg. (Belgium)	9523024	9926999	—	18-5873 **	90	ALL W/RED STATOR		—	18-5870
105 JET	D082000	G960499	18-5798	18-5876	95XR	ALL W/RED STATOR		—	18-5870
115 6 cyl	5314656	& UP	18-5798	18-5854	120XR	ALL W/RED STATOR		—	18-5870
115 4 cyl electric models	G438000	& UP	—	18-5870 **	175XR2	ALL		18-5796	—
115 4 cyl electric models (Belgium)	9927000	& UP	—	18-5870 **					
115 4 cyl with voltage reg.	C10000	G437999	—	18-5873 **					
115 4 cyl with voltage reg. (Belgium)	9559771	9926999	—	18-5873 **					

① Electric start models only

② Stators with 5/8" laminations only

③ Applications with 16 amp Stator and non-louvered flywheel cover

④ Applications not using a voltage regulator

⑤ Stators with 5/8" laminations and used with 15 amp voltage regulator

⑥ Flywheel without screws

** May require the purchase of voltage regulator if not currently equipped

† Applications with clear 40 amp stator with louvered flywheel cover



**18-5741
VOLTAGE REGULATOR**
Replaces: 815279A2, 815279-1
For: Mercury engines with 16 amp or 40 amp charging system model/years 1989-91

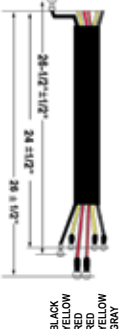

BLACK
RED
RED
YELLOW
GRAY

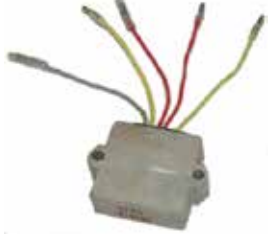

**18-5743
VOLTAGE REGULATOR**
Replaces: 815279-3, 815279-5, 883072T
For: Mercury engines with 16 amp or 40 amp charging system model/years 1992 to present

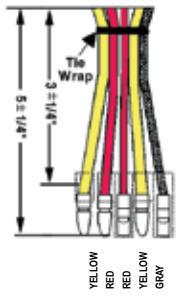

YELLOW
RED
RED
YELLOW
GRAY



**18-5707
RECTIFIER**
Replaces: 62351A1, 62351A2, 816770, 816770T
All applications with square, 3 post rectifier



**18-5811
STARTER SOLENOID**
Replaces: Mercury 809463A1
For: PG260 Series Starters, (Verado 200-275 HP), (75/95 1.5L DFI), (115/135/150/175/200 2.5L DFI), (225 3.0L DFI)



**18-5802
SOLENOID**
Replaces: 65057A1, 65057T1

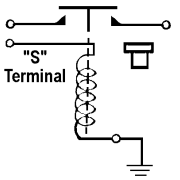

⑦ **18-5802D** Display Package



**18-5808
SOLENOID**
Replaces: 47886, 47886T

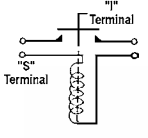

① **18-5808D** Display Package



**18-5810
SOLENOID**
Horizontal Post

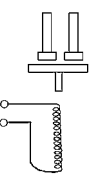

① **18-5810D** Display Package



**18-5815
SOLENOID**
Replaces: 89-68258A4, 89-853654A1, 89-76545

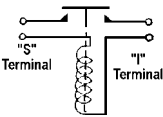

① **18-5815D** Display Package



**18-5816
SOLENOID**
Replaces: 89-96054, 89-96054T, 89-91975
Flat Bracket

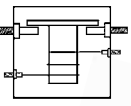

① **18-5816D** Display Package



**18-5817
SOLENOID**
Replaces: 89-96158, 89-96158T
Vertical Post, Angled Bracket

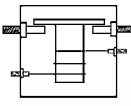

① **18-5817D** Display Package



**18-5818
SOLENOID**
Replaces: 89-818864, 89-818864T

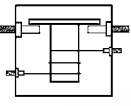

① **18-5818D** Display Package



**18-5819
SOLENOID**
Replaces: 89-818997A1, 89-818997T1

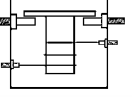

① **18-5819D** Display Package



**18-5820
SOLENOID**
Replaces: 89-818999A2, 89-825842A1, 89-850188T1



① **18-5820D** Display Package



**18-5821
STARTER SOLENOID**
Replaces: 89-825096T, 825096T01
Fits: 9.9 4-Stroke(1999 & Up), 15 4-stroke (1999 & Up), 30 4-stroke(2002 & Up), 40/50/60 4-stroke(2001 & Up), 75/90 4-stroke(2000 & Up)

① **18-5821D** Display Package



**18-5822
CHOKE SOLENOID**
Replaces: 54293A13
Fits: 75 4cyl (1984 & Up), V150 (1978 & Up), V150 Magnum (1978-85), V150 Marathon (1978-85), V150 XR 2 (1978-85), V1500 (1978-85), V175 (1976-99), V1750 (1976-88), V200 (1978 & Up), V2000 (1978-88)

① **18-5822D** Display Package

APPLICATION ON NEXT PAGE

① Items ending in "D" are Display Packaged - Regular number is Non-Display



18-5834 SOLENOID
Replaces: 89-817109A2
For : 75 HP (3 cyl.) S/N G127500 & UP

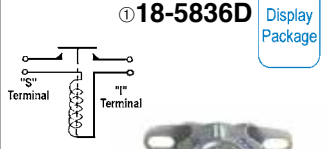

18-5836 SOLENOID
Replaces: 25661, 256611, 25661T1



18-5729 POWER TRIM RELAY
Replaces: 87-18211
For : 35 (2 cyl.) (with Ram Trim) OC159200 & UP
60 (3 cyl.) (with Ram Trim) OB122920 - OD000749



18-5737 POWER TRIM RELAY
Replaces: 87-19761
For : 40 (4 cyl.) (with Relays) OC159200 & UP



18-5849 RELAY, SHROUDED, TRIM
Replaces: 882751A1, 828151A1, 828151, 882751A2
Fits: Power Trim Relay used on most 2-stroke and 4-stroke (non-Verado®) engines.



18-5850 RELAY, SHROUDED
Replaces: 882751A04
Fits: 135hp. - 350hp Verado (2005 - Current); 496Mag & 496HO (2004 - Current); 8.1HO (2004 - Current)



18-5852 RELAY, SHROUDED
Replaces: 821509T01, 821509, 853292
Fits: Four-Stroke: 45hp (0G231123-0G472132); 50hp. (0G231123-0T178499)

① Items ending in "D" are Display Packaged - Regular number is Non-Display

SOLENOID APPLICATION

HP	Req. S/N	End. S/N	Starter Solenoid/Relay	Power Trim Solenoid	Power Trim Relay
4-Stroke					
9.9 (4-Stroke)(323cc)	0G760300	0T979999	18-5821	—	—
15 (4-Stroke)(323cc)	0G760300	1B727495	18-5821	—	—
30 (4-Stroke) Carb	0G760300	& Up	—	—	18-5849
30 (4-Stroke) EFI	0T409000	1B226999	18-5821	—	18-5849
40 (4-Stroke)(3 cyl) Carb	0G760300	& Up	—	—	18-5849
40 (4-Stroke)(3 cyl) EFI	0T409000	& Up	18-5821	—	18-5849
40 (4-Stroke)(4 cyl) Carb	0T228405	0T598999	18-5821	—	18-5849
40 (4-Stroke)(4 cyl) EFI	0T409000	& Up	18-5821	—	18-5849
45 (4-Stroke) Bodensee	0G231123	0G472132	18-5821	—	18-5852
45 (4-Stroke) Bodensee	0G472133	0T178499	18-5821	—	18-5849
50 (4-Stroke)	0G231123	0T178499	18-5821	—	18-5852
50 (4-Stroke)(4 cyl) Carb 996cc	0T178500	0T598999	18-5821	—	18-5849
50 (4-Stroke)(4 cyl) EFI 996cc	0T409000	& Up	18-5821	—	18-5849
60 (4-Stroke)(4 cyl) Carb 996cc	0T178500	0T598999	18-5821	—	18-5849
60 (4-Stroke)(4 cyl) EFI 996cc	0T409000	& Up	18-5821	—	18-5849
75 (4-Stroke) Carb 1596cc	0G960500	1B226999	18-5821	—	—
75 (4-Stroke) EFI 1596cc	1B366823	& Up	18-5834	—	—
90 (4-Stroke) Carb 1596cc	0G960500	1B226999	18-5821	—	—
90 (4-Stroke) EFI 1731cc	1B366823	& Up	18-5821	—	—
115 (4-Stroke) EFI w/ 2 relay trim	0T178500	0T800999	—	—	18-5849
115 (4-Stroke) EFI 1731cc	0T809000	1B366822	—	—	18-5849
115 (4-Stroke) EFI 1731cc	1B366823	& Up	18-5821	—	—
135 (4-Stroke) Verado	1B227000	& Up	18-5850	—	18-5850
150 (4-Stroke) Verado	1B227000	& Up	18-5850	—	18-5850
175 (4-Stroke) Verado	1B227000	& Up	18-5850	—	18-5850
200 (4-Stroke)(4 cyl) Verado	1B517159	& Up	18-5850	—	18-5850
200 (4-Stroke)(6 cyl) Verado	0T980000	& Up	18-5850	—	18-5850
225 (4-Stroke)(6 cyl) Verado	0T980000	& Up	18-5850	—	18-5850
250 (4-Stroke)(6 cyl) Verado	0T980000	& Up	18-5850	—	18-5850
275 (4-Stroke)(6 cyl) Verado	0T980000	& Up	18-5850	—	18-5850
300 (4-Stroke)(6 cyl) Verado	1B517434	& Up	18-5850	—	18-5850
350 (4-Stroke)(6 cyl) Verado	1B716557	& Up	18-5850	—	18-5850
2-Stroke					
HP	Req. S/N	End. S/N	Starter Solenoid	Power Trim Solenoid	Power Trim Relay
6/8/9.9	A197112	OD280999	18-5816	—	—
15	A197112	OD280999	18-5816	—	—
18	5837437	& UP	18-5816	—	—
20	4709593	6443972	18-5815	—	—
20	6443973	0G044026	18-5816	—	—
25	5705532	G044026	18-5816	—	—
30 (2 cyl) 644cc	G053314	& UP	—	—	18-5849
30 JET non-handle	C159200	G589999	18-5816	—	—
35 2 cyl (w/ 3 Ram Trim)	6445653	C159199	18-5817	18-5817	—

① Use 18-5817 for applications with circuit breaker and fuse. ③ For units with 10-32, 5/16-18 terminals. ⑤ For design II applications use 18-5820.
 ② For units with 8-32, 1/4-20 terminals. ④ Use 18-5818 if off white solenoid is needed. ⑥ w/rubber bushing solenoid

SOLENOID APPLICATION

HP	Beg. S/N	End. S/N	Starter Solenoid	Power Trim Solenoid	Power Trim Relay
35 2 cyl (w/ 1 Ram Trim)	C159200	& UP	18-5817	—	18-5729
40 2 cyl	2874704	5556229	18-5836	—	—
40 2 cyl	5556230	5823917	18-5815	—	—
40 2 cyl	5823918	G053313	18-5817	—	—
40	G053314	& UP	18-5816 ⑤	—	—
40 4 Cyl.(w/solenoids)	C159200	& UP	18-5816	18-5820	—
40 4 Cyl.(w/relays)	C159200	& UP	18-5816	—	18-5737
45 4 Cyl.(w/o circuit breaker)	5531630	6146848	18-5815	18-5815	—
45 4 Cyl.(w/circuit breaker)	5531630	6146848	18-5815	18-5817	—
45 4 Cyl.(w/o circuit breaker)	6146849	B110788	18-5817	18-5815 ①	—
45 4 Cyl.(w/circuit breaker)	6146849	B110788	18-5817	18-5817	—
45 4 Cyl.	B110789	& UP	18-5817	18-5817	—
45 JET (w/flush mount solenoid)	D000750	G290584	18-5816	—	—
45 JET	G290585	G589999	18-5820	—	—
50	3008819	4140999	18-5836	—	—
50	4141000	5531629	18-5815	—	—
50 4 Cyl.(w/circuit breaker)	5531630	6146848	18-5815	18-5815 ①	—
50 4 Cyl.(w/circuit breaker)	5531630	6146848	18-5815	18-5817	—
50 4 Cyl.(w/o circuit breaker)	6146849	& UP	18-5817	18-5815 ①	—
50 4 Cyl.(w/circuit breaker)	6146849	& UP	18-5817	18-5817	—
50 3 Cyl.	6428681	B122929	18-5816	18-5817	—
50 3 Cyl. (w/ 3 Ram Trim)	B122930	C160935	18-5817	18-5817	—
50 3 Cyl. (w/ 1 Ram Trim)	B122930	D000749	18-5817	—	18-5729
50 3 Cyl.	D000750	G290584	18-5816	—	18-5849
50 3 cyl	G290585	G589999	18-5820	—	18-5849
50 3 cyl	G590000	& UP	—	—	18-5849
55 3 Cyl.	D000750	G290584	18-5816 ⑤	—	18-5849
55 3 Cyl.	G290585	G589999	18-5820	—	18-5849
60 3 Cyl.	6428681	B122929	18-5816	18-5817	—
60 3 Cyl. (w/solenoids)	B122930	D000749	18-5817	18-5817	—
60 3 Cyl. (w/relays)	B122930	D000749	18-5817	—	18-5729
60 3 Cyl.	D000750	G290584	18-5816 ⑤	—	18-5849
60 3 Cyl.	G290585	G589999	18-5820	—	18-5849
65 4 Cyl.	2446775	3293183	18-5836	—	—
65 3 Cyl.	3547987	4571651	18-5815	—	—
65 JET	G127500	& UP	18-5834	—	—
70 3 Cyl.	4571652	5579016	18-5815	—	—
70 3 Cyl.	5579017	6104369	18-5815	18-5815 ①	—
70 3 Cyl.	6104370	6428680	18-5816	18-5815 ①	—
70 3 Cyl.	A996147	& UP	18-5817	18-5817	—
75 4 Cyl.	6432901	& UP	18-5816	18-5817	—
75 3 cyl w/ 1 Ram Trim	C222000	D252460	—	—	18-5849
75 3 Cyl.	D252461	G127499	18-5817	18-5819	—
75 3 Cyl.	G127500	G360002	18-5834	18-5819	—
75 3 Cyl.	G360003	& UP	18-5834	—	18-5849
75 Optimax 3 cyl (1.5L)	T801000	& UP	18-5834	—	18-5849
80	2559001	3493912	18-5836	—	—
80 4 Cyl.	4831999	5582561	18-5815	—	—
80 4 Cyl.	5582562	6030903	18-5815	18-5815 ①	—
80 4 Cyl.	6030904	6432900	18-5816	18-5815 ①	—
80 3 Cyl.	A996142	& UP	18-5817	18-5817	—
80 JET 4 cyl	D283222	& UP	18-5834	—	—
80 JET 3 cyl	B586067	& UP	18-5834	—	18-5849
85 4 Cyl.	3493913	3865694	18-5836	—	—
85 4 Cyl.	3865695	4831998	18-5815	—	—
90	4845301	5299505	18-5815	18-5815	—
90	5299506	6026608	18-5815	18-5815 ①	—
90	6026609	6436122	18-5816	18-5815 ①	—
90	6436123	& UP	18-5816	18-5817	—
90 3 Cyl.	A996142	C221999	18-5817	18-5817	—
90 3 Cyl. w/ 1 Ram Trim	C222000	D252460	—	—	18-5849
90 3 Cyl.	D252461	G127499	—	18-5819	—
90 3 Cyl.	G127500	G360002	18-5834	18-5819	—
90 3 Cyl.	G360003	& UP	18-5834	—	18-5849
90 Optimax 3 cyl (1.5L)	T801000	& UP	18-5834	—	18-5849
100 6 Cyl.	2318586	3253111	18-5836	—	—
100 4 Cyl. w/ 1 Ram Trim & 5/16-18 starter terminal	B209468	D252460	18-5834	—	18-5849
100 4 Cyl. w/ 3 Ram Trim & 5/16-18 starter terminal	B209468	D252460	18-5834	—	—
100 4 Cyl.	D252461	G359967	18-5834	18-5819	—
100 4 Cyl.	G359968	& UP	18-5834	—	18-5849
105 JET w/ flush mounted starter solenoid	D082000	G303045	18-5815	—	—
105 JET w/ rubber mounted starter solenoid	D082000	G303045	18-5834	—	—
105 JET	G303046	& UP	18-5834	—	—
110 6Cyl.	1870204	2314955	18-5836	—	—
115	2836019	4112634	18-5836	18-5836	—
115	4112635	5600966	18-5815	18-5815	—
115	5600967	6051525	18-5815	18-5815 ①	—
115	6051526	6436122	18-5816	18-5817 ①	—
115	6436123	& UP	18-5816	18-5817	—
115 4 Cyl. w/ 3 Ram Trim & 5/16-18 starter terminal	C100000	D252460	18-5834	—	—
115 4 Cyl. w/ 1 Ram Trim & 5/16-18 starter terminal	C100000	D252460	18-5834	—	18-5849
115 4 Cyl.	D252461	G359967	18-5834	18-5819	—
115 4 Cyl.	G359968	& UP	18-5834	—	18-5849
115 Optimax 3 cyl (1.5L)	T801000	& UP	18-5834	—	18-5849

① Use 18-5817 for applications with circuit breaker and fuse.

③ For units with 10-32, 5/16-18 terminals.

⑤ For design II applications use 18-5820.

② For units with 8-32, 1/4-20 terminals.

④ Use 18-5818 if off white solenoid is needed.

⑥ w/rubber bushing solenoid

SOLENOID APPLICATION

HP	Beg. S/N	End. S/N	Starter Solenoid	Power Trim Solenoid	Power Trim Relay
115 Pro XS	B751825	& UP	18-5834	—	18-5849
125	2314956	3253111	18-5836	—	—
125 4 Cyl.	D283222	G359967	18-5834	18-5819	—
125 4 Cyl.	G359968	& UP	18-5834	—	18-5849
125 Optimax 3 cyl (1.5L)	B736885	& UP	18-5834	—	18-5849
135	2839369	3293233	18-5836	—	—
V135	A904646	C100860	18-5815 ③	18-5817	—
V135	A904646	C100860	18-5816 ②	18-5817	—
V135	C100861	C239552	18-5815	18-5817	—
V135	C239553	D081999	18-5815 ④	18-5817	—
V135 (w/flush mounted solenoid)	D082000	G201874	18-5815	18-5819	—
V135 (w/rubber bushing solenoid)	D082000	G201874	18-5834	18-5819	—
V135 (w/flush mounted solenoid)	G201875	G303045	18-5815	—	18-5849
V135 (w/rubber bushing solenoid)	G201875	G303045	18-5834	—	18-5849
V135	G303046	& UP	18-5834	—	18-5849
V135 DFI	G590000	& UP	18-5834	—	18-5849
140	3293234	3502805	18-5836	18-5836	—
140	4865678	& UP	18-5815	18-5815	—
140 JET	G303046	T178499	18-5834	—	18-5849
150	3502806	4121434	18-5836	18-5836	—
150	4121435	4865677	18-5815	18-5836	—
150 XS	4868648	5327662	18-5815	18-5815	—
V150	4868998	6042945	18-5815	18-5817	—
V150	6042946	A904645	18-5816	18-5817	—
V150	A904646	C100860	18-5815 ③	18-5817	—
V150	A904646	C100860	18-5817 ②	18-5817	—
V150	C100861	C239552	18-5815	18-5817	—
V150	C239553	D081999	18-5815 ④	18-5817	—
V150, 150 EFI w/flush mounted solenoid	D082000	G201874	18-5815	18-5819	—
V150, 150EF w/rubber mount solenoid	D082000	G201874	18-5834	18-5819	—
V150, 150 EFI w/flush mounted solenoid	G201875	G303045	18-5815	—	18-5849
V150, 150EF w/rubber mount solenoid	G201875	G303045	18-5834	—	18-5849
V150, 150 EFI	G303046	& UP	18-5834	—	18-5849
V150 DFI	G590000	& UP	18-5834	—	18-5849
150 XR-4/Magnum II	B242885	C239552	18-5815	18-5817	—
150 XR-4/Magnum II w/standard color solenoid	C239553	D081999	18-5815	18-5817	—
150 XR-4/Magnum II w/off white color solenoid	C239553	D081999	18-5815	18-5818 ⑥	—
150 XR-6/Magnum III w/flush mounted solenoid	D082000	G201874	18-5815	18-5819	—
150 XR-6/Magnum III w/rubber mounted solenoid	D082000	G201874	18-5834	18-5819	—
150 XR-6/Magnum III	G201875	G303045	18-5815	—	—
150 XR-6/Magnum III w/flush mounted solenoid	G201875	G303045	18-5815	—	18-5849
150 XR-6/Magnum III w/rubber mounted solenoid	G201875	G303045	18-5834	—	18-5849
150 XR-6/Magnum III	G303046	& UP	18-5834	—	18-5849
V175	4301235	6618750	18-5815	18-5815	—
V175	6618751	C239552	18-5816 ②	18-5817	—
V175	6618751	C239552	18-5815 ③	18-5817	—
V175	C100861	C239552	18-5815	18-5817	—
V175	C239553	D081999	18-5815 ④	18-5817	—
V175, 175 EFI w/ flush mounted solenoid	D082000	G201874	18-5815	18-5819	—
V175, 175 EFI w/ rubber mounted solenoid	D082000	G201874	18-5834	18-5819	—
V175, 175 EFI w/ flush mounted solenoid	G201875	G303045	18-5815	—	18-5849
V175, 175 EFI w/ rubber mounted solenoid	G201875	G303045	18-5834	—	18-5849
V175, 175 EFI	G303046	& UP	18-5834	—	18-5849
V175 DFI	G590000	& UP	18-5834	—	18-5849
V175 Pro XS	B516339	& UP	18-5834	—	18-5849
V200	4839034	6073191	18-5815	18-5815	—
V200	6073192	6225220	18-5816	18-5817	—
V200	6625221	C100860	18-5816 ②	18-5817	—
V200	6625221	C100860	18-5815 ③	18-5817	—
V200	C100861	C291519	18-5815	18-5817	—
V200 (2.5L)	C291520	D081999	18-5815 ④	18-5817	—
V200 w/ flush mounted solenoid	D082000	G201874	18-5815	18-5819	—
V200 w/ rubber mounted solenoid	D082000	G201874	18-5834	18-5819	—
V200, 200 EFI (w/flush mounted solenoid)	D082000	G201874	18-5815	18-5819	—
V200, 200 EFI (w/rubber bushing solenoid)	D082000	G201874	18-5834	18-5819	—
V200, 200 EFI (w/flush mounted solenoid)	G201875	G303045	18-5815	—	18-5849
V200, 200 EFI (w/rubber bushing solenoid)	G201875	G303045	18-5834	—	18-5849
V200, 200 EFI	G303046	& UP	18-5834	—	18-5849
V200 DFI	G386496	& UP	18-5834	—	18-5849
V220 (Laser)	B117316	& UP	18-5815	18-5817	—
V225 2.4L	5628028	& UP	18-5815	18-5815	—
V225 3.0L	D280813	G129221	18-5834	18-5819	—
V225 3.0L	G129222	G303045	18-5834	18-5819	—
V225 3.0L	G129222	G303045	18-5834	—	18-5849
V225 3.0L	G303046	& UP	18-5834	—	18-5849
V225 DFI	G590000	& UP	18-5834	—	18-5849
V225 Sea Pro / Marathon	G245605	& UP	18-5834	—	18-5849
V225 Pro XS	B104549	& UP	18-5834	—	18-5849
V225/250 EFI	G129222	& UP	18-5834	—	18-5849
V250XB	G980600	& UP	18-5834	—	18-5849
V250 Pro XS	B426561	& UP	18-5834	—	18-5849
V250/275 (3.4L)	C101891	& UP	18-5815	18-5817	—
300 (3.4L)	5611648	& UP	18-5815	18-5817	—

① Use 18-5817 for applications with circuit breaker and fuse.

③ For units with 10-32, 5/16-18 terminals.

⑤ For design II applications use 18-5820.

② For units with 8-32, 1/4-20 terminals.

④ Use 18-5818 if off white solenoid is needed.

⑥ w/rubber bushing solenoid



**18-5929
ALTERNATOR**
Replaces: 892940T
All Verado's



**18-6454
ALTERNATOR**
Replaces: 875285T1,
881248T02, 889955T01
5S/I 50 amp Spool mount
Fits 2.5L



**18-6455
ALTERNATOR**
Replaces: 875286T,
875286A1, 881247A1
5S/I 50 amp
Fits 1.5L and 3.0L
For: 200 DFI, 200 DFI/DTS, 225 EFI, 225 EFI, Sea Pro, 225 DFI/DTS, 250 EFI



**18-6840
ALTERNATOR**
Replaces: 50-897755T, 897755T
Fits: 75-115HP EFI (4-Stroke)



18-18000
Replaces: 57-892318
For: 75 DFI (2005-06),
90 DFI (2005-06), 15 DFI (2004-06)

SERPENTINE BELTS

18-18100
Replaces: 57-828507Q4
For: 135 DFI (1998-Up),
150 DFI (1998-Up), 175 DFI (2001-Up)



18-15128
Replaces: 57-880566014
Fits: All Verados-135-275HP

SERPENTINE BELTS

18-15129
Replaces: 57-828507 1
Fits: 200 DFI (1997& Up), 225 DFI (1998 & Up)

**18-6500
SERVICE END
ALTERNATOR HARNESS**
Replaces: 84-881262A2
Fits: Optimax (1998-01) For: Delco Alternators



ALL STARTERS ARE COUNTER CLOCKWISE ROTATION



**18-5609
STARTER**
Replaces: 50-86976
Fits: V200 (1978 & Up), V-2000 (1978-88), V225 (1980-81)



**18-6435
STARTER**
Replaces: 50-888161T,
50-884044T, 50-859377T
Fits: 40,50,60 HP 4 Stroke 4 Cyl, 0P094500 & UP:
50,60 HP EFI 4 Stroke 4 Cyl, 0P153500-UP

ALL STARTERS ARE COUNTER CLOCKWISE ROTATION



**18-6436
STARTER**
Replaces: 50-859171T, 50-834749,
50-898265001
Fits:40HP Italy 4 Stroke 0G760300-UP: 45HP
Bodensee 0G760300-UP: 50HP 4 Stroke
0G760300-UP: 50HP Bigfoot 4 Stroke 0G760300-UP



**18-6437
STARTER**
Replaces: 50-888151T,
50-830308T, 50-859169T,
50-893886T
Fits:25HP 4 Stroke 0G760300 & UP



**18-6438
STARTER**
Replaces: 50-888160T, 50-884045T,
50-859170T, 50-854636T, 50-893887T
Fits:30,40HP 3 Cyl 4 Stroke 0G760300 & UP



**18-6425
STARTER**
Replaces: 50-804312T1
For: 4 Stroke 75 HP, and 90HP except Verado



**18-6440
STARTER**
Replaces: 50-892339T, 50-853329T
Fits:90,V135,V150,V175,V200,2.5L DFI, 0T178500 &
UP: 200,250HP,3.0L, 0T467442 & UP, and Inline 4 and
6 cyl. Verados. Models with solenoid operated bendix.



**18-5601
PREMIUM
STARTER**
Replaces: 50-55601, 50-55601A2,
50-38890A1

**18-5641
O.E. EQUIVALENT**



**18-5602
STARTER**
Replaces: 50-67341, 50-58788A3,
50-893891T, 50-44369A1



**18-5604
PREMIUM
STARTER**
Replaces: 50-66015, 50-66015T,
50-893891T, 50-44369A1
10-Tooth

**18-5642
O.E. EQUIVALENT**



**18-6282
STARTER**
Fits: Mercury V6 Jet (1996 and up) 8 Tooth
Drive Gear
Replaces: 50-8329972, 50-832997003



**18-6283
STARTER**
Replaces: 50-8331535,
50-898265008
For: Mercury 2.5 DFI(1999 and up), 200HP V6
DFI(1996-99), 225HP V6 DFI(1998 and up), 3.0L
V6(1999 and up) 9 tooth drive gear



**18-5605
STARTER**
Replaces: 50-73521, 50-73521T,
50-898265005



**18-5606
STARTER**
Replaces: 50-44369, 50-60315, 50-44369A1
50-898265012



18-5608
PREMIUM
STARTER
Replaces: 50-44415, 50-77141, 50-79472, 50-44414, 50-79472 1, 50-893893



18-5643
O.E. EQUIVALENT



18-5610
STARTER
Replaces: 50-66015T, 50-660151, 50-660153, 50-893892T, 50-893892T



18-5611
STARTER
Replaces: 50-90983A-1, 50-90983T1, 50-8M0033984
For: 6-15 HP (1986-96), 18-25 HP (1980-87), 10 tooth drive gear



18-5620
STARTER
Replaces: 50-818445-3, 50-818445-2, 50-818445 5, 50-898265009



18-5621
STARTER
Replaces: 50-822462, 50-822462T1, 50-893890T



18-5636
PREMIUM
STARTER
Replaces: 50-57465A1, 50-57867, 50-64975, 50-72467, 50-58788A3

18-5649
O.E. EQUIVALENT



18-6825
STARTER
Replaces: 50-86976
Fits: 200-225HP V6 engines



18-6828
STARTER
Replaces: 50-41583
Fits: 35, 35 (2 CYL.), 402, 40 (2 CYL.)



18-6829
STARTER
Replaces: 50-852570, T, 50-857065, 50-859168, T, 859168, T
Fits: Mercury, Mariner 9.9-15HP 4-Stroke Engines



18-6864
STARTER
Replaces: 50-819271, 50-820193A1
Fits: Mercury 40-50HP Engines



ALL STARTERS ARE COUNTER CLOCKWISE ROTATION



NEW

**18-6940
STARTER**
Replaces: 50-825991A2
Fits: 9.9HP 4- Stroke Engines



NEW

**18-6943
STARTER**
Replaces: 50-893894
Fits: 9.9-15HP Engines



**18-6250
STARTER REPAIR KIT**
Prestolite
2 Brush



**18-6251
STARTER REPAIR KIT**
Prestolite
4 Brush



**18-5650
DRIVE ASSEMBLY**
Replaces: 57380
See chart below for additional application



**18-5656
DRIVE ASSEMBLY**
Replaces: 68575
See chart below for additional application



**18-5658
DRIVE ASSEMBLY**
Replaces: 86177, 86177 1
See chart below for additional application



**18-5674
DRIVE ASSEMBLY**
Replaces: 75660, 13310T1
See chart below for additional application

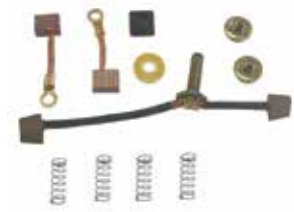

**18-5697
DRIVE BRUSH KIT**
Replaces: 75384
See chart below for additional application

MERCURY

H.P.	Beg. Serial #	Ending Serial #	O.E.M #	Starter #	O.E. #	Drive Assembly	O.E. #	Drive Tooth Count	Brush Kit	O.E. #
6	A197112	& Up	50-8M0033984/50-90983A1	18-5611	96562		—	10	—	—
7.5	3801458	4851692	50-73531	ⓐ	96562		96562/75427	10	18-5697	75384
7.5	4851693	& Up	50-78011	ⓐ	96562		96562/75427	10	18-5697	75384
8/9.9/15	A197112	& Up	50-8M0033984/50-90983A1	18-5611	96562		—	10	—	—
18	5837437	& Up	50-8M0033984/50-90983A1	18-5611	96562		—	—	—	—
20	4709593	6443973	50-76275	ⓐ	96562		96562/75427	10	—	—
20	6443973	& Up	50-8M0033984/50-90983A1	18-5611	96562		—	10	—	—
25	5705532	& Up	50-8M0033984/50-90983A1	18-5611	96562		—	10	—	—
30 2 cyl.	G053314	& Up	50-893890T/50-822462	18-5621	N.L.A.	18-5656	68575	10	18-5697	75384
30 JET	G159200	G589999	50-898265005/50-73521	18-5605	68575 3	18-5656	68575	10	18-5697	75384
30 JET 3 cyl.	G590000	T408999	50-893890T/50-822462	18-5621	90643	18-5656	68575	10	18-5697	75384
35 2 cyl.	6445653	& Up	50-41583T/50-41583	ⓐ	N.L.A.		43076/ 43076T	10	18-5697	75384
35/40 2 cyl.	6445652	& DOWN	50-55601A2/50-55601	18-5601	N.L.A.	18-5650	57380	9	18-5697	75384
40 2 cyl.	G053314	& Up	50-893890T/50-822462	18-5621	68575 3	18-5656	68575	10	18-5697	75384
40H.P. 3 cy.	G590000	G760299	50-893890T/50-822462	18-5621	68575 3	18-5656	68575	10	18-5697	75384
40 3 cyl.	G760300	& Up	50-893890T/50-822462	18-5621	68575 3	18-5656	68575	10	18-5697	75384
40 4 cyl.	C159200	& Up	50-898265005/50-73521	18-5605	68575 3	18-5656	68575	10	18-5697	75384
40 JET	T178500	& Up	50-893890T/50-822462	18-5621	68575 3	18-5656	68575	10	18-5697	75384
45 4 cyl.	5531630	& Up	50-898265005/50-73521	18-5605	68575 3	18-5656	68575	10	18-5697	75384
45 JET	D000750	G589999	50-44369A1/50-65436/50-60315	18-5606 ⓑ	68575 3	18-5656	—	—	—	—
45 JET	G590000	T129554	50-893890T/50-822462	18-5621	68575 3	18-5656	68575	10	18-5697	75384
50 4 cyl.	4357639	& Below	50-55601A2/50-38890A1	18-5601	N.L.A.	18-5650	57380	9	18-5697	75384
50 4 cyl.	4357640	& Up	50-898265005/50-73521	18-5605	68575 3	18-5656	68575	10	18-5697	75384
50 3 cyl.	B122930	G589999	50-44369A1	18-5606 ⓑ	68575 3	18-5656	—	—	—	—
50 3 cyl.	G590000	& Up	50-893890T/50-822462	18-5621	68575 3	18-5656	68575	10	18-5697	75384
55 3 cyl.	D000750	G589999	50-44369A1	18-5606 ⓑ	68575 3	18-5656	—	—	—	—
55 3 cyl.	G590000	& Up	50-893890T/50-822462	18-5621	68575 3	18-5656	68575	10	18-5697	75384
60 3 cyl.	6428681	G589999	50-44369A1/50-65436/50-60315	18-5606 ⓑ	68575 3	18-5656	—	—	—	—
60 3 cyl.	G590000	& Up	50-893890T/50-822462	18-5621	68575 3	18-5656	68575	10	18-5697	75384
60 3 cyl. Bigfoot	G590000	G760299	50-893890T/50-822462T 1	18-5621	68575 3	18-5656	68575	10	18-5697	75384

Note: Some starters will replace Prestolite versions however replacement parts are for Bosch versions only.
 ⓐ With 8 tooth pinion
 ⓑ With 9 tooth pinion
 ⓒ Inline 6 cylinder
 ⓓ Bosch models only
 ⓔ Some applications require Mercury adapter #44368 (prior to S/N 0D000750)

MERCURY

H.P.	Beg. Serial #	Ending Serial #	O.E.M #	Starter #	O.E. #	Drive Assembly	O.E. #	Drive Tooth Count	Brush Kit	O.E. #
65 4 cyl.	2803822	3293183	50-57867A1/50-58788	18-5636	68575 3	18-5656	68575	10	18-5697	75384
65 3 cyl.	3293184	4571651	50-44369A1/50-65436/50-60315	18-5606	68575 3	18-5656				
65 Jet	D283222	& Up	50-893891T/50-66015	18-5604	68575 3	18-5656	68575	10	18-5697	75384
70 3 cyl.	457165	A996142	50-44369A1/50-65436/50-60315	18-5606	68575	18-5656				
80 4 cyl.	2783253	3493912	50-57867A1/50-58788	18-5636	N.L.A.		68575	10	18-5697	75384
80 4 cyl.	4831999	& Up	50-893891T/50-66015	18-5604	68575 3	18-5656	68575	10	18-5697	75384
85 4 cyl.	3865694	& Below	50-58788A3/50-58788	18-5636	N.L.A.	18-5656	68575	10	18-5697	75384
85 4 cyl.	3865695	4366801	50-67341	18-5602	68575 3	18-5656	68575	10	18-5697	75384
80 Jet	D283222	& Up	50-893892T/50-66015-1	18-5610	68575 3	18-5656	75660/13310T1	8	18-5697	75384
90	4845301	& Up	50-72467/50-64975/50-57465A1	18-5636	68575 3	18-5656	68575	10	18-5697	75384
90 3 cyl.	A996142	& Up	50-893891T/50-66015	18-5604	68575 3	18-5656	68575	10	18-5697	75384
100 4 cyl.	B209468	G965520	50-893892T/50-66015-1	18-5610	68575-3	18-5674	75660/13310T1	8	18-5697	75384
105 JET	G760299	& Below	50-893893/50-44414/50-44415/50-79472/50-77141	18-5608	13310T 1	18-5674	75660/13310T1	8	18-5697	75384
115 6 cyl.	4855153	& Up	50-72467/50-64975/50-57465A1	18-5636	68575 3	18-5656	68575	10	18-5697	75384
115 4 cyl.	C100000	& Up	50-893892T/50-66015-1	18-5610	68575 3	18-5674	75660/13310T1	8	18-5697	7538
125 4 cyl.	D283222	& Up	50-893892T/50-66015-1	18-5610	68575 3	18-5674	75660/13310T1	8	18-5697	75384
135 V-6	A904646	G960499	50-893893/50-79472/50-77141/50-44414/50-44415	18-5608	13310T 1	18-5674	75660/13310T1	8	18-5697	75384
140 6 cyl. Inline	4865678	& UP	50-72467/50-64975/50-57465A1	18-5636	68575 3	18-5656	68575	10	18-5697	75384
140 JET	G960499	& Below	50-893893/50-44414/50-44415/50-79472/50-77141	18-5608	1310T 1	18-5674	75660/13310T1	8	18-5697	75384
150	4121435	& Up	50-72467/50-64975/50-57465A1	18-5636	68575 3	18-5656	68575	10	18-5697	75384
V150	4868998	G960499	50-793793/50-79472/50-77141	18-5608	13310T 1	18-5674	75660/13310T1	8	18-5697	75384
150 XR2	4868998	A904645	50-44414,50-44415	18-5608	N.L.A.	18-5674	75660/13310T1	8	18-5697	75384
150 XR4	B242885	D819999	50-893893/50-79472/50-77141/50-44414/50-44415	18-5608	13310T 1	18-5674	75660/13310T1	8	18-5697	75384
150 XR6	D082000	G960499	50-893893/50-79472/50-77141/50-44414/50-44415	18-5608	13310T 1	18-5674	75660/13310T1	8	18-5697	75384
150 EFI	G303046	T408999	50-893893/50-79472/50-77141/50-44414/50-44415	18-5608	13310T 1	18-5674	75660/13310T1	8	18-5697	75384
V175	4301235	G960499	50-893893/50-79472/50-77141	18-5608	13310T 1	18-5674	75660/13310T1	8	18-5697	75384
175 EFI, XRI, MAG	D000750	G960499	50-893893/50-44414/50-44415	18-5608	N.L.A.	18-5674	75660/13310T1	8	18-5697	75384
200	4839034	G960499	50-893893/50-79472/50-77141	18-5608	13310T 1	18-5674	75660/13310T1	8	18-5697	75384
200 EFI, XRI	C100861	G960499	50-893893/50-44414/50-44415	18-5608	N.L.A.	18-5674	75660/13310T1	8	18-5697	75384
2.4EFI/2.5EFI/	ALL	—	50-893893/50-79472/50-77141/50-44414/50-44415	18-5608	13310T 1	18-5674	75660/13310T1	8	18-5697	75384
2.5 Carb/	ALL	—	50-893893/50-79472/50-77141/50-44414/50-44415	18-5608	13310T 1	18-5674	75660/13310T1	8	18-5697	75384
3.4L/MOD VP	ALL	—	50-893893/50-79472/50-77141/50-44414/50-44415	18-5608	13310T 1	18-5674	75660/13310T1	8	18-5697	75384
V200	5363918	6435503	50-86976	18-5609	8677 1	18-5658	86177/86177 1	9	18-5697	75384
V225	5628028	D280812	50-86976	18-5609	8677 1	18-5658	86177/86177 1	9	18-5697	75384
225 3.0L Carb	D280813	T408999	50-898265009/50-818445-3/50-818445-2	18-5620	13310T 1	18-5674	75661/13310T1	8	18-5697	75384
225/250 EFI 3.0L	G129222	& Up	50-898265009/50-818445-3/50-818445-2	18-5620	13310T 1	18-5674	75661/13310T1	8	18-5697	75384
250XB	G980600	& Up	50-898265009/50-818445-3/50-818445-2	18-5620	13310T 1	18-5674	75661/13310T1	8	18-5697	75384

Note: Some starters will replace Prestolite versions however replacement parts are for Bosch versions only.
 ② Inline 6 cylinder
 ④ With 8 tooth pinion
 ⑤ With 9 tooth pinion
 ⑥ No replacement starter available, drive parts only
 ⑦ Bosch models only
 ⑧ Some applications require Mercury adapter #44368 (prior to S/N ODO00750)

18-7354 CARB KIT
 Replaces: 1395-8506
 V-175 outboards
 Serial Number 4301235 thru OC100860

18-7355 CARB KIT
 Replaces: 1395-811691 2

18-7356 CARB KIT
 Replaces: 1395-811691 3

18-7004 CARB KIT
 Replaces: 1395-6200

18-7005 CARB KIT
 Replaces: 1395-6452

18-7006-1 CARB KIT
 Replaces: 1399-1717, 1399-2015, 1399-3523, 1395-4808, 1395-8791994024, 879194024



18-7007
CARB KIT
 Replaces: 1399-5135,
 1399-5198



18-7013
CARB KIT
 For AJ, KA, KB, KC, KD Carburetor



18-7021
CARB KIT
 For WM, WMK



18-7211-1
CARB KIT
 Replaces: 1395-8112231



18-7212
CARB KIT
 Replaces: 1395-97611

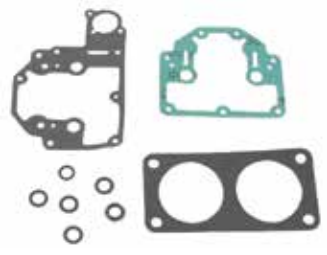

18-7213
CARB KIT
 Replaces: 8107492

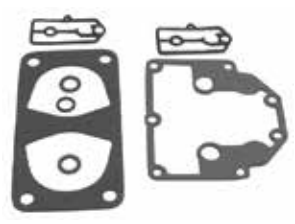

18-7214
CARB KIT
 Replaces: 8107493



18-7215
CARB KIT
 Replaces: 1395-9024



18-7216
CARB KIT
 Replaces: 809449A1
 For: 25 HP Force &
 25 HP 3 cyl Merc. & Sears 1996-98



18-7226
CARB KIT
 Replaces: 1395-9650
 Fits: 30 JET, 40/45 4 CYL 4 Stroke,
 Carb models WMA-7B,9,10,13



18-7290
CARB KIT
 Replaces: 84419M



18-7291
CARB KIT
 Replaces: 84475M



18-7293
CARB KIT
 Replaces: 92520M



18-7738
CARB KIT
 Replaces: 802706A1
 For: 9.9 4 Stroke (323cc) (1999 & up)
 and 15 4 Stroke (1998 & up)



18-7743
CARB KIT
 Replaces: 804346T1
 For: 75 4 Stroke (2000 & up), 90 4 Stroke (2000 & up)



**18-7750-1
CARB KIT**
Replaces: 1395-8236354
Fits:WME-1,1A,1B,4,5,6,6A,7,7B,8,9,10,10A,11,14,15,15A,17,18,20,20A,21,21A,22,22B,23,24,26,27,28,32,32A,33,34,35,36,36A,37,37A,38,39A,40,40A,42,42A,43,44,45,50,52,53,57,58,63,64,65,66,67,68,69,79,81



**18-7765
CARB KIT**
Replaces: 11502M



**18-7769
CARB KIT**
Replaces: 814481M



**18-7770
CARB KIT**
Replaces: 84456M



**18-7062
INLET VALVE**
Replaces: 1395-95951
Fits:WME-1,1A,1B,4,5,6,6A,7,7B,8,9,10,10A,11,14,15,15A,17,18,20,20A,21,21A,22,22B,23,24,26,27,28,32,32A,33,34,35,36,36A,37,37A,38,39A,40,40A,42,42A,43,44,45,50,52,53,57,58,63,64,65,66,67,68,69,79,81



**18-7057
NEEDLE & SEAT**
Replaces: 1399-1473,1395-9258,1399-1138, 1399-9258 1
.078 Bore



**18-7061
NEEDLE & SEAT**
Replaces: 1395-8318, 1395-83181
.065 Bore



**18-7295
NEEDLE VALVE**
Replaces: 1395-9022



**18-7233
NEEDLE & SEAT**
Replaces: 1395-7824



**18-72000
FLOAT**
Replaces: 1395-9594
Fits:WME1,1A,1B,4,5,6,6A,7,7B,8,9,10,10A,11,14,15,15A,17,18,20,20A,21,21A,22,22B,23,24,26,27,28,32,32A,33,34,35,36,36A,37,37A,38,39A,40,40A,42,42A,43,44,45,50,52,53,57,58,63,64,65,66,67,68,69,79,81



**18-7249
FLOAT KIT**
Replaces: 19273
Fits:WM-3,5,6,8,9,10,11,12,13,13A,14,15,15A,16,16A,17,18



**18-7208
FLOAT**
Replaces: 1395-8983, 1395-8673



**18-7209
FLOAT**
Replaces: 1395-9293

MARINER CARBURETOR KIT APPLICATION

HP	Year/Serial No.	Carb Kit	HP	Year/Serial No.	Carb Kit	HP	Year/Serial No.	Carb Kit
6 C-D	Ser.No.Code 6H8 & 6H6	18-7765	25A	M-648-24991 & Up ML-648-64046 & Up E-648-27056 & Up EL-648-56526-& Up	18-7770	30A	M-689-230100 & Up ML-689-530100 & Up E-689-250100 & Up EL-689-550100 & Up	18-7770
8C	Ser.No.Code 6G1	18-7765						
9.9C	M-682-070796 & Up ML-682-368040 & Up E-682-251511 & Up EL-682-55146 & Up	18-7769	25C	Ser.No.Code 695	18-7770	48	M-670-02641 & Up ML-670-34581 & Up	18-7290
	15C		M-684-052848 & Up ML-684-332302 & Up E-684-252381 & Up EL-684-553251 & Up	28	M-664-05306 & Upl ML-664-41686 & Upl E-664-26236 & Up EL-664-57421 & Up			
						W48	Ser.No.Code 670	18-7290
						55	Ser.No.Code 663	18-7290
						W55	Ser.No.Code 663	18-7290
						60	Ser.No.Code 675	18-7290

MERCURY CARBURETOR KIT APPLICATION

HP	Year — S/N	Carburetor Model	Carburetor Kit	Gasket Kit	Needle & Seat	Float	
3.9	1964-68	KB-7A,KB-7B	18-7013	18-7006-1	18-7057	18-7208	
4 (1 cyl.)	1969-74	—	—	—	—	—	
	80-81,86-87	KB-10A	18-7013	18-7006-1	18-7057	18-7208	
4 (1 cyl.)	—	WMD-1	—	18-7006-1	18-7061	18-7208	
4.5	1980-85	KD-10A	18-7013	18-7006-1	18-7057	18-7208	
4.5	1980-85	WMD-1	18-7021	18-7006-1	18-7061	18-7208	
6	1961-68	KB-6A,6B,7B,AJ57A	18-7013	18-7006-1	18-7057	18-7208	
6	S/N A197112-Up	WMC-5.5A,5B,7.7A,	—	—	—	—	
		17,17B,17C,18,18A,	—	—	—	—	
		18B,19,19A,20,20A,	—	—	—	—	—
		20B,23,28,34,	—	—	—	—	—
		39,41,47,49	—	—	18-7212	—	—
7.5	1969-73	KB-9A,KB-12A	18-7013	18-7006-1	18-7057	18-7208	

APPLICATION CONTINUED ON NEXT PAGE

MERCURY CARBURETOR KIT APPLICATION (Cont.)

HP	Year — S/N	Carburetor Model	Carburetor Kit	Gasket Kit	Needle & Seat	Float
7.5	1972-85	BB-2A, BB-2B, BB-2C, BB-4A, BB-5A, BB-5B, BB5C, BB-5D, BB-7A, BB-7C	—	—	—	—
7.5		WMB-2, 4	—	18-7007	18-7295	18-7209
8	S/N A197112-Up	WMC-5.5A, 5B, 7.7A, 17, 17B, 17C, 18, 18A, 18B, 19, 19A, 20, 20A, 20B, 23, 28, 34, 39, 41, 47, 49, 57	—	—	18-7295	18-7209
9.8	1962-73	KB-5A, 8A, 11A	18-7013	18-7006-1	18-7057	18-7208
9.8	1972-85	BB-1B, BB-1C, BB-3A, BB-3B, BB-3C, BB-6A, BB-6C	—	—	—	—
9.8		WMB-1, 3	—	18-7007	18-7295	18-7209
9.9	S/N A197112-Up	WMC-5.5A, 5B, 7.7A, 17, 17B, 17C, 18, 18A, 18B, 19, 19A, 20, 20A, 20B	—	18-7212	—	—
9.9		WMC-23, 28, 34, 39, 41, 41A, 47, 47A, 49, 49A, 57	—	18-7212	—	—
9.9 (4 Stroke) (323cc)	S/N OG590000-Up	—	—	—	—	—
10	1957-61	AJ-52A	18-7013	18-7006-1	18-7057	18-7208
10		AJ-56AB	—	18-7006-1	18-7057	18-7208
10		KB-1A, 4A	—	18-7006-1	18-7057	18-7208
10 Seapro/ Marathon	All	WMC-33, 33A, 40, 42, 50, 50A, 55, 55A	—	18-7212	—	—
XR-10	All	WMC-23, 48, 48A, 49, 49A	—	18-7212	—	—
MAG 10	All	WMC-23, 48, 48A, 49, 49A	—	18-7212	—	—
15	1959-61	AJ-52A, AJ-56A	18-7013	18-7006-1	18-7057	18-7208
15(150)		KB-1A, 4A	—	18-7006-1	18-7057	18-7208
15	S/N A197112-Up	WMC-5.5A, 5B, 7.7A, 17, 17B, 17C, 18, 18A, 18B, 19, 19A, 20, 20A, 20B	—	18-7212	—	—
15		WMC-23, 28, 34, 39, 41, 41A, 47, 47A, 49, 49A, 57	—	18-7212	—	—
15	S/N OG590000-Up	—	18-7738	—	—	—
15 Seapro/ Marathon	All	WMC-33, 33A, 40, 42, 50, 50A, 55, 55A	—	18-7212	—	—
Super 15	S/N 6443973-Up	WMC-1, 2, 3, 4, 9, 10, 11, 12, 13, 13A, 14, 14A, 15A, 16A, 24, 25, 26, 27, 29, 30, 31, 31A, 32, 32A, 35, 35A, 35B, 36, 37, 44, 45, 46, 46A, 50, 53, 54, 56	—	—	—	—
Seapro/ Marathon	S/N 6443973-Up	WMC-1, 2, 3, 4, 9, 10, 11, 12, 13, 13A, 14, 14A, 15A, 16A, 24, 25, 26, 27, 29, 30, 31, 31A, 32, 32A, 35, 35A, 35B, 36, 37, 44, 45, 46, 46A, 50, 53, 54, 56	—	18-7212	—	—
15XD/25		—	—	—	—	—
15 (4-Stroke)	S/N OG590000-Up	—	18-7738	—	—	—
18	S/N 6443973-Up	WMC-1, 2, 3, 4, 9, 10, 11, 12	—	18-7212	—	—
18		WMC-13, 13A, 14, 14A, 15A, 16A, 24, 25, 26, 27, 29, 30, 31, 31A	—	18-7212	—	—
20	S/N 6443973-Up	WMC-1, 2, 3, 4, 9, 10, 11, 12	—	18-7212	—	—
20		WMC-13, 13A, 14, 14A, 15A, 16A, 24, 25, 26, 27, 29, 30, 31, 31A	—	18-7212	—	—
20 (200)	1963-72	KA-20A, 22A, 22B, 22C, 23A, 25A	18-7013	18-7006-1	18-7057	18-7208
20	1973-80	BA-1A, BA-2A, BA-2C, BA-2D, BA-2E	—	18-7007	—	18-7209
Jet 20	S/N 6443973-Up	WMC-1, 2, 3, 4, 9, 10, 11, 12, 13, 13A, 14, 14A, 15A, 16A, 24, 25, 26, 27, 29, 30, 31, 31A, 32, 32A, 35, 35A, 35B, 36, 37, 44, 45, 46, 46A, 50, 53, 54, 56	—	—	—	—
22	1958-59	KA-KC	18-7013	18-7006-1	18-7057	18-7208
25 (2 cyl)	S/N 6443973-Up	WMC-1, 2, 3, 4, 9, 10, 11, 12	—	18-7212	—	—
25 (2 cyl)		WMC-13, 13A, 14, 14A, 15A, 16A, 24, 25, 26, 27, 29, 30, 31, 31A, 32, 32A, 35, 35A, 35B, 36, 37, 44, 45, 46, 46A, 50, 53, 54, 56	—	18-7212	—	—
30 (2 cyl), (644cc)	S/N G053314-Up	WME-36, 36A, 37, 37A, 38, 39A, 42, 42A, 63, 64, 65, 66, 67	—	—	—	—
		—	18-7750-1	18-7211-1	—	18-72000
30 (300) 4-cyl		AJ-54A	—	—	18-7057	18-7208
30 (300) 4-cyl		KB-2A	—	17-7006-1	18-7057	18-7208
30 JET (3 cyl)		WME-53, 68, 69	18-7750-1	18-7211-1	—	18-72000
30 JET (4 cyl)		WMA-10, 13	18-7226	—	—	—
35	1984-89	KC-4A, 8A, 9A, 9B, 9C, 13A	18-7013	18-7006-1	18-7061	18-7208
35	1963-69	KB-2A	18-7013	18-7006-1	18-7057	18-7208
35	1984-89	WMK-38	18-7021	18-7006-1	18-7061	18-7208

APPLICATION CONTINUED ON NEXT PAGE

MERCURY CARBURETOR KIT APPLICATION (Cont.)



















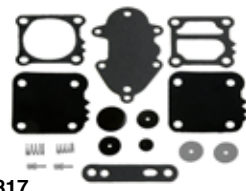
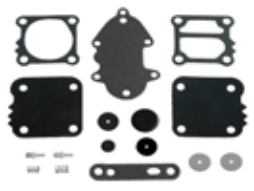

HP	Year — S/N	Carburetor Model	Carburetor Kit	Gasket Kit	Needle & Seat	Float
35		AJ-54A	—	—	18-7057	18-7208
40	1960-61	KA-7A,KD-5A, KA-2A,KA-9A	—	—	—	—
40	1954-59	AJ	18-7013	18-7006-1	18-7057	18-7208
40	1970-74	WMK-1,WMK-8	18-7021	18-7006-1	18-7061	18-7208
40	1975-83	WMK-21,WMK-24, WMK-31	18-7021	18-7006-1	18-7061	18-7208
40 (2 cyl.)	S/N G053314-Up	WME-36,36A,37,37A, 38,39A,42,42A,63, 64,65,66,67	—	—	—	—
40 (3 cyl.)		WME-53, 68, 69	18-7750-1	18-7211-1	—	18-72000
40 (4 cyl.)		WMA-4	—	18-7215	18-7295	18-7209
40 (4 cyl.)		WMA-7B	18-7226	—	—	18-7209
40 (4 cyl.)		WMA-9, 10, 13	18-7226	—	—	—
45	1958-62	KA-2A	18-7013	18-7006-1	18-7057	18-7208
45	1958-62	AJ-54A	18-7013	18-7006-1	18-7057	18-7208
45 (4 cyl.)	1986	Tillotson/Walbro	—	18-7007	—	18-7209
45 (4 cyl.)	1987-Up	WMA-4	—	18-7215	18-7295	18-7209
45 (4 cyl.)		KA-17A	18-7013	—	18-7057	18-7208
45 (4 cyl.)		WMA-7B	18-7226	—	—	18-7208
45 (4 cyl.)		WMA-9, 10, 13	18-7226	—	—	—
45 JET (3 cyl.)		WME-57, 58	18-7750-1	18-7211-1	—	18-72000
50 (4 cyl.)	1961-75	KA-13A,18A,19A, 21A,21B,21C,21D, 24A,26A,26B,27A	—	—	—	—
50	1976-85	BA-3B,BA-3C,BA-3D	18-7013	18-7006-1	18-7057	18-7208
50 (3 cyl.)	1986-90	WM-13, 13A, 15, 15A, 16, 16A, 18	—	18-7007	—	18-7209
50 (3 cyl.)		WME-22,22B,23,24,26, 27, 28, 35, 43, 44, 45, 53, 68, 69	18-7750-1	18-7004	—	18-7249
50 (4cyl.)	1986-Up	WMA-1.3	—	18-7215	18-7295	18-7209
50 (4cyl.)		BA-3A, 3B, 3C, 3D, 4A	—	18-7007	18-7295	18-7209
50 (4cyl.)		WMK-8	18-7021	18-7006-1	18-7061	18-7208
55 (3 cyl.)		WM-13, 13A, 15, 15A, 16, 16A, 18	18-7249	18-7004	—	—
55		WME-22, 22B, 23, 24, 26, 27, 28, 35, 43, 44, 45, 57, 58	18-7750-1	18-7211-1	—	18-72000
60 (3 cyl.)	S/N D000750-Up	WME-22,22B,23,24,26, 27, 28, 35, 43, 44, 45, 57, 58	18-7750-1	18-7211-1	—	18-72000
60 (3 cyl.)	1984-90	WM-13,13A, 15, 15A, 16, 16A, 18	—	18-7004	—	18-7249
60	1957-60	AJ-53A,AJ-55A,KB	18-7013	18-7006-1	18-7057	18-7208
60 600 (6 cyl.)		KB-3A	—	18-7006-1	18-7057	18-7208
65 650 (4 cyl.)	1963-71	KC-2A,5A,5B,5C, 11A,15A	18-7013	18-7006-1	18-7057	18-7208
65 650 (3 cyl.)	1972-75	WMK-5,WMK-12, WMK-13,WMK-20	18-7021	18-7006-1	18-7061	18-7208
65	1976	WM-2,WM-4	—	18-7004	18-7061	18-7208
Jet 65 (3 cyl.)	S/N A996142-Up	WME-1,1A,1B,4,5,6,6A, 7, 7B, 8, 9, 10, 10A, 15, 15A, 17, 18, 19, 25, 29, 30, 31, 41, 46, 47, 48, 49, 59, 60, 61, 62, 75, 76, 77	18-7750-1	18-7211-1	—	18-72000
70	1958-62	KC,KA-2A	18-7013	18-7006-1	18-7057	18-7208
70 700 (6 cyl.)		KA-8A, 12A	18-7013	18-7006-1	18-7057	18-7208
70	1977-83	WM-6,8, 9, 11	—	18-7004	18-7061	18-7249
70 (3 cyl.)	S/N A996142-Up	WME-1,1A,1B,4,5, 6,6A,7,7B,8,9,10, 10A,15,15A,17,18, 19,25,29,30,31,41, 46,47,48,49,59, 60,61,62	—	—	—	—
75 (4 cyl.)	1984-86	WM-14, 17	18-7750-1	18-7211-1	—	18-72000
75 (3 cyl.)	S/N A996142-Up	WME-1,1A,1B,4,5, 6,6A,7,7B,8,9,10, 10A,15,15A,17,18, 19, 25,29,30,31,41, 46,47,48,49,59, 60,61,62	—	18-7004	—	18-7249
75 (4 Stroke)	S/N QG960500-Up	—	18-7750-1	18-7211-1	—	18-72000
80 (3 cyl.)	S/N A996142-Up	WME-1,1A,1B,4,5, 6,6A,7,7B,8,9,10, 10A,15,15A,17,18, 19,25,29,30,31,41, 46,47,48,49,59, 60,61,62	—	—	—	—
80 (4 cyl.)	1960-61	60,61,62	18-7750-1	18-7211-1	—	18-72000
80 (4 cyl.)	1969-72	KD-4A	18-7013	18-7006-1	18-7061	18-7208
80 (4 cyl.)	1978-83	WMK-2	18-7021	18-7006-1	18-7061	18-7208
80 800 (6 cyl.)		WM-5,10,12, 14, 17	—	18-7004	18-7061	18-7249
Jet 80 (4 cyl.)	S/N B209468-Up	KA-10A, 11A, 14A, 16A, KC-3A	—	18-7006-1	18-7057	18-7208
85	1973-75	WME-11,14,20,20A, 21,21A,32,32A,33, 34,40,40A,50,51,52,79	18-7750-1	18-7211-1	—	18-72000
85 850 (6 cyl.)	1963-65	WMK-4,WMK-16, WMK-17	18-7021	18-7006-1	18-7061	18-7208
85	1976-77	KA,KC	18-7013	18-7006-1	18-7057	18-7208
90 (3 cyl.)	S/N A996142-Up	WM-3,WM-5	—	18-7004	18-7061	18-7249
90 (4 Stroke)	S/N QG960500-Up	WME-1,1A,1B,4,5,6, 6A,7,7B,8,9,10,10A, 15,15A,17,18,19,25, 29,30,31,41,46,47, 48,49,59,60,61,62	—	—	—	—
90 (6 cyl.)	1965	—	18-7750-1	18-7211-1	—	18-72000
90 (6 cyl.)	1978-86	KC-6A	18-7013	18-7006-1	18-7057	18-7208
95	1966-67	WMK-23,WMK-27, WMK-30,WMK-35, WMK-39	18-7021	18-7006-1	18-7061	18-7208
100 (4 cyl.)	S/N B209468-Up	KC-6A	18-7013	18-7006-1	18-7057	18-7208
		WME-11,14,20,20A, 21,21A,32,32A,33,34,	—	—	—	—

APPLICATION CONTINUED ON NEXT PAGE

MERCURY CARBURETOR KIT APPLICATION (Cont.)

HP	Year — S/N	Carburetor Model	Carburetor Kit	Gasket Kit	Needle & Seat	Float
		40,40A,50,51,52,79	18-7750-1	18-7211-1	—	18-72000
100 (6 cyl.)	1962-69	KC-1A,7A,10A,14A	18-7013	18-7006-1	18-7057	18-7208
100 (6 cyl.)		KD-1A, 1B, 2A, 3A	18-7013	18-7006-1	18-7061	18-7208
V-105 Jet	1994-95 S/N OD082000-OG303045	WMH-13, 13B, 23, 31	18-7355	18-7213	—	—
V-105 Jet	1996 & Up S/N OG303046 & Up	WMV-2, 2A	18-7356	18-7214	—	—
110		KC-1A, 7A, 7B, 10A, 14A	18-7013	18-7006-1	18-7057	18-7208
115 (4 cyl.)	S/N B209468-Up	WME-11,14,20,20A, 21,21A,32,32A,33,34	—	—	—	—
		40,40A,50,51,52	18-7750-1	18-7211-1	—	18-72000
115 (6 cyl.)	1970-77	KD-6A,KD-6B	18-7013	18-7006-1	18-7061	18-7208
115 (6 cyl.)	1970-88	WMK-3,10,15, 18, 26, 28, 32, 36, 40, 41, 41-1A, 41-1B, 41-3A, 41-3B	18-7021	18-7006-1	18-7061	18-7208
125	1968-69	KD-1A,1B,2A, 3A	18-7013	18-7006-1	18-7057	18-7208
125 (4 cyl.)	S/N B209468-Up	WME-11,14,20,20A, 21,21A,32, 32A,33	—	—	—	—
		34,40,40A,50,51,52, 81	18-7750-1	18-7211-1	—	18-72000
135	1970-71	KD-7A,KD-7B	18-7013	18-7006-1	18-7057	18-7208
135	1970-71	WMK-4	18-7021	18-7006-1	18-7061	18-7208
V-135	1986-88 S/N OA904646-OC100860	WH-33, 40	18-7354	18-7005	18-7233	—
V-135	1986-88 S/N OA904646-OC100860	WH-32, 35, 38	18-7354	18-7005	—	—
V-135	1989-90 S/N OC100861-OC239552	WH-35, 38	—	18-7005	18-7233	—
V-135	1989-90 S/N OC100861-OC239552	WH-40, 48	18-7354	18-7005	18-7233	—
V-135	1991 S/N OC239553-OD081999	WMH-8, 8A	18-7355	18-7213	—	—
V-135	1992-95 S/N OD082000-OG303045	WMH-12A, 12B, 28, 30	18-7355	18-7213	—	—
V-135	1996-98 S/N OG303046-OG760299	WMV-1, 1A	18-7356	18-7214	—	—
V-135	1999 & Up S/N OG760300 & Up	WMV-1A, 15, 15A	18-7356	18-7214	—	—
140	1972	WMK-7,WMK-9	18-7021	18-7006-1	18-7061	18-7208
140	1978-80	WMK-25,WMK-29	18-7021	18-7006-1	18-7061	18-7208
V-140 Jet	1994-95 S/N OG082000-OG303045	WMH-16, 21, 34, 39	18-7355	18-7213	—	—
V-140 Jet	1996-98 S/N OG303046-OG760299	WMV-5, 5A	18-7356	18-7214	—	—
V-140 Jet	1999 & Up S/N OG760300 & Up	WMV-5A	18-7356	18-7214	—	—
150	1973-77	WMK-11	18-7021	18-7006-1	18-7061	18-7208
150	1973-78	WMK-14,WMK-19, WMK-22	18-7021	18-7006-1	18-7061	18-7208
3.4L	1984-86	WO-3	—	—	18-7233	—
V150	1978-90	WH-2,12,21,23,27, 29,35,38,40,48	—	18-7005	18-7233	—
V-150	1979-85 S/N OA904645 & Below	WH-9	—	18-7005	—	—
V-150	1979-85 S/N OA904645 & Below	WH-12	—	18-7005	18-7233	—
V-150	1979-85 S/N OA904645 & Below	WH-29	18-7354	18-7005	18-7233	—
V-150	1986-90 S/N OA904646-OC239552	WH-35, 38	—	18-7005	18-7233	—
V-150	1986-90 S/N OA904646-OC239552	WH-40, 48	18-7354	18-7005	18-7233	—
V-150	1990-91 S/N OC239553-OD081999	WMH-1, 7	18-7355	18-7213	—	—
V-150	1992-95 S/N OD082000-OG303045	WMH-13, 13B, 23, 31	18-7355	18-7213	—	—
V-150	1996-98 S/N OG303046-OG760299	WMV-2, 2A	18-7356	18-7214	—	—
V-150	1999 & Up S/N OG760300 & Up	WMV-3A, 16, 16A	18-7356	18-7214	—	—
V-150 (XR4, MAGII)	1988 S/N OB242885-OC100860	WH-41A	18-7354	18-7005	18-7233	—
V-150 (XR4, MAGII)	1989 S/N OC100861-OC239552	WH-41	18-7354	18-7005	18-7233	—
V-150 (XR4, MAGII)	1989 S/N OC100861-OC239552	WH-41A	18-7354	18-7005	18-7233	—
V-150 (XR4, MAGII)	1990-91 S/N OC239553-OD081999	WMH-6	18-7355	18-7213	—	—
V-150 (XR6, MAGIII)	1996-98 S/N OG303046-OG760299	WMV-3, 3A	18-7356	18-7214	—	—
V-150 (XR6, MAGIII)	1999 & Up S/N OG760300 & Up	WMV-3A, 16, 16A	18-7356	18-7214	—	—
V-150 (XR6, MAGIII)	1992-95 S/N OD082000-OG303045	WMH-14A, 25, 32A	18-7355	18-7213	—	—
V-175	1976-88 S/N 4301235-OC100860	WH-1, 4, 7, 7A, 13, 17, 28, 39, 46	—	18-7005	18-7233	—
V-175	1976-88 S/N 4301235-OC100860	WH-17R, 30, 34	18-7354	18-7005	18-7233	—
V-175	1990 S/N OC100861-OC239552	WH-34	18-7354	18-7005	18-7233	—
V-175	1991 S/N OC239553-OD081999	WMH-2, 11	18-7355	18-7213	—	—
V-175	1992-95 S/N OD082000-OG303045	WMH-15, 22, 33	18-7355	18-7213	—	—
V-175	1996-98 S/N OG303046-OG760299	WMV-4, 4A	18-7356	18-7214	—	—
V-175	1999 & Up S/N OG760300 & Up	WMV-4A	18-7356	18-7214	—	—
V200	1978-90 □	WH-3,14,18,20, 22,26,28,31,39,46	—	18-7005	18-7233	—
V-200	1991 S/N OC291520-OD081999	WMH-3	18-7355	18-7213	—	—
V-200	1992-95 S/N OD082000-OG303045	WMH-16, 21, 34, 39	18-7355	18-7213	—	—
V-200	1996-98 S/N OG303046-OG760299	WMV-5, 5A	18-7356	18-7214	—	—
V-200	1999 & Up S/N OG760300 & Up	WMV-5A	18-7356	18-7214	—	—
V200	1980-82 S/N 4839034-OC100860	WH-3A,11	—	18-7005	—	—
V-225 (2.4L)	1981 & Up 5628028 & Up	WH-5, 20	—	18-7005	18-7233	—
225	S/N D280813 thru G303045	WMH-19,45,46,47	18-7355	18-7213	—	—
V225	1980-81	WH-15	—	18-7005	18-7233	—
V-225 (3.0L)	S/N OD280813-OG303045	WMH-19, 46, 47	18-7355	18-7213	—	—
V-225 (3.0L)	S/N OG303046-OG760299	WMV-7, 13	18-7356	18-7214	—	—
V-225 (3.0L)	S/N OG303046 & Up	WMV-13, 13A	18-7356	18-7214	—	—
V-225 (3.0L)	S/N OG245605-OG303045	WMH-45	18-7355	18-7213	—	—
Seapro/Marathon						
V-225 (3.0L)	S/N OG303046-OG760299	WMH-6, 11A	18-7356	18-7214	—	—
V-225 (3.0L)	S/N ALL & Up	WMV-11, 11A, 13, 13A, 19	18-7356	18-7214	—	—
Seapro/Marathon						
V250	1989-90	WD-8A-1,2,3,4,5,6	—	—	18-7061	—
V275	1989-91	WD-9/9A-1,2,3,4,5,6	—	—	18-7061	—
V300	1980 & Up S/N 5611648 & Up	WD-3, 5	—	—	18-7061	—
XR2	S/N C239553-Up	WHM-1,2,3B,5,7,8, 8A,11A,12,12A,12B, 13,13B,14A,15,16, 18A,21,22,23,24,25, 28,30,31,32,33,34	—	—	—	—
			18-7213	—	—	—
XR4	1988-90	WH-41 WH-41A	—	18-7005	—	—
XR6/ MAGIII	S/N C239553-Up	WHM-1,2,3B,5,7,8, 8A,11A,12,12A,12B, 13,13B,14A,15,16, 18A,21,22,23,24,25, 28,30,31,32,33,34	—	—	—	—
			18-7213	—	—	—

① Except EFI, XRI

 <p>18-8866 FUEL PUMP Replaces: 899106T01 Fits: Mercury 4 stroke outboard</p>	 <p>18-7804 FUEL PUMP KIT Replaces: 23014A1</p>	 <p>18-7806-1 FUEL PUMP KIT</p>	
 <p>18-7807 FUEL PUMP KIT Replaces: 55278A1</p>	 <p>18-7808 FUEL PUMP KIT Replaces: 55278A5</p>	 <p>18-7809 FUEL PUMP KIT Replaces: 55278A4</p>	
 <p>18-7810 FUEL PUMP KIT Replaces: 90363A1</p>	 <p>18-7811 FUEL PUMP KIT Replaces: 89031A1</p>	 <p>18-7812 FUEL PUMP KIT Replaces: 89031A2</p>	
 <p>18-7813 FUEL PUMP KIT Replaces: 89031A3, 66599A3</p>	 <p>18-7814 FUEL PUMP KIT Replaces: 89031A4</p>	 <p>18-7815 FUEL PUMP KIT Replaces: 1399-5137</p>	 <p>18-7817 FUEL PUMP KIT Replaces: 21-42990A7, A8, A9, A10 21-857005A1</p>
 <p>18-7818-1 FUEL PUMP KIT Replaces: 42909A3, 42909A4</p>	 <p>18-7833 FUEL PUMP DIAPHRAGM Replaces: 11497M</p>	 <p>18-7834 FUEL PUMP DIAPHRAGM Replaces: 91748M</p>	 <p>18-7837 FUEL PUMP DIAPHRAGM Replaces: 84262M</p>
 <p>18-7838 FUEL PUMP DIAPHRAGM Replaces: 84265M</p>	 <p>18-7839 FUEL PUMP DIAPHRAGM Replaces: 80606M</p>	 <p>18-7840 FUEL PUMP DIAPHRAGM Replaces: 84141M</p>	 <p>18-7847 FUEL PUMP DIAPHRAGM</p>

DIAPHRAGM APPLICATION ON NEXT PAGE

MERCURY FUEL PUMP KITS

HP	Beginning	Ending	Fuel Pump Kit	HP	Beginning	Ending	Fuel Pump Kit
7.5	3488153	& UP	18-7815 ②	115 (4 CYL)	B209468	& UP	18-7817 ⑦
8	A197112	& UP	18-7212	115 (115, 1150) SQUARE F/P	6436123	& UP	18-7817
9.8	3482753	& UP	18-7815 ②	115 (4 CYL)	D283222	& UP	18-7817
9.9	A197112	& UP	18-7212	115 (6 CYL) DFI	G960500	T178999	18-7817
10	1057994	1455239	18-7804	115 (3 CYL) DFI	T801000	& UP	18-7817
15	1200114	1349667	18-7804	115 PRO XS	B751825	& UP	18-7817
15	B292414	& UP	18-7212	120	ALL		18-7806-1
20	1866496	2296266	18-7804	120XR	ALL		18-7806-1
20	3537531	A910970	18-7815 ②	125 (1250) 6 CYL	2314956	2839386	18-7804
20	6443973	T800749	18-7212	125 (4 Cyl.)	D283222	& UP	18-7817
20 JET	G044027	& UP	18-7212	125 (1250BP) 6 CYL	2400058	2641954	18-7817
22	1158546	1499331	18-7804	125 (3 CYL) DFI	B736885	& UP	18-7817
25	1467499	1499331	18-7804	135	2839369	3293233	18-7807
25	6443973	& UP	18-7212	V-135	C100860	& Below	18-7812 ①
30	950250	1448139	18-7804	V-135	A904646	& UP	18-7817 ⑤
30 JET	C159200	T408999	18-7817	V-135 TRIANGULAR F/P	A904646	C100860	18-7813
35	6445652	& BELOW	18-7804	V-135 SQUARE F/P	A904646	D081999	18-7817
35	6445653	B110788	18-7809	V-135	D082000	T178499	18-7817
35	B110789	& UP	18-7817	V-135 DFI (DESIGN II)	G590000	G760299	18-7817
40 (2 cyl.)	831021	1476509	18-7804	V135 DFI	G760300	& UP	18-7817
40 (2 CYL)	2874704	5556229	18-7807	140	3293234	3502805	18-7807
40 (2 CYL)	C159200	& UP	18-7817	140	4865678	5327662	18-7811
40 (2 CYL)	G053314	& UP	18-7817	140 JET	ALL		18-7817
40 (3 CYL)	G590000	T999999	18-7817	150	3502806	4865677	18-7807
40 FOUR STROKE JET 2 CYCLE	G760300	& UP	18-7817	150 EFI	G303046	& UP	18-7817
45	1139538	1531958	18-7804	V-150	C100860	& Below	18-7812 ①
45 (4 cyl.)	B110789	& UP	18-7817	V-150	A904646	C100860	18-7817 ⑤
45/50 (4 cyl.)	3478003	B110788	18-7815 ②	V-150 XR2	ALL		18-7812
45 JET	6428681	& UP	18-7817	V-150 (150HP)	4868998	A904645	18-7812
45 JET	D000750	T129554	18-7817	V-150 SQUARE F/P	A904646	C100860	18-7817
50 (4 cyl.)	2116318	4357639	18-7804	V-150	C100861	D081999	18-7817
50 (3 cyl.)	6428681	B122929	18-7809	V-150 CARB & EFI	D082000	B226999	18-7817
50 (3 cyl.)	B122930	T999999	18-7817	V-150 DFI (DESIGN I)	G590000	G760299	18-7817
50/55 (3 cyl.)	D000750	& UP	18-7817	V-150 DFI (DESIGN II)	G590000	G760299	18-7817
60	1072997	1542744	18-7804	V-150 DFI	G760300	& UP	18-7817
60	6428681	B122929	18-7809	V-175	C100860	& Below	18-7812 ①
60 (3 cyl.)	B122930	& UP	18-7817	175 EFI	G303046	G589999	18-7817
60 (3 cyl.)	D000750	& UP	18-7817	V-175	6618751	& UP	18-7817 ⑤
65	1542745	2803561	18-7804	V-175 TRIANGULAR F/P	4301235	C100860	18-7812
65	ALL 3 CYL		18-7807	V-175 SQUARE F/P	4301235	& UP	18-7817
65 JET	D283222	& UP	18-7817	V-175	C100861	D303045	18-7817
65 (650) 4 CYL	2119749	2803561	18-7804	V-175	D303046	G960499	18-7817
70	1143038	1566239	18-7804	V-175 EFI	D000750	D081999	18-7817
70 (3 cyl.)	4571652	6428680	18-7809	V-175 EFI	D082000	T408999	18-7817
70 (3 cyl.)	A996142	C221999	18-7818-1	V-175 EFI	T409000	T800999	18-7817
75 (4 CYL) SQUARE F/P	6432901	& UP	18-7817	V-175 DFI	T178500	& UP	18-7817
75 (3 CYL) 90 DEGREE OIL CHECK VALVE	C222000	D283221	18-7818-1	V-175 PRO XS	B516339	& UP	18-7817
75 (3 CYL) INLINE OIL CHECK VALVE	C222000	D283221	18-7817	200 EFI	G303046	G589999	18-7817
75 (3 CYL)	D283222	& UP	18-7817	V-200	6073192	6357229	18-7810
75 (3 CYL) DFI	T980000	& UP	18-7817	V-200	6357230	6625220	18-7814 ①
75 (4 cyl.)	6432901	& UP	18-7808 ①	V-200	4839034	6073191	18-7812
75 (4 cyl.)	6432901	& UP	18-7817 ⑤	V-200	6625221	& UP	18-7817 ⑤
75 (3 cyl.)	A996142	D283221	18-7818-1	V-200	6625221	C291519	18-7817
80	1335465	2670574	18-7804 ③	V-200	C291520	B226999	18-7817
80	2783253	2856331	18-7807 ③	V-200 EFI	C100861	D081999	18-7817
80	2559001	2670574	18-7808 ④	V-200	D082000	T408999	18-7817
80	4831999	6432900	18-7808	V-200 (2.5L) EFI	T409000	& UP	18-7817
80 (3 CYL)	A966142	C221999	18-7818-1	V-200 (3.0L) EFI	T750164	& UP	18-7817
80 JET (3 CYL)	0D283222	& UP	18-7817	V-200 DFI	G590000	T598999	18-7817
80 JET (4 CYL)	B586067	& UP	18-7817	V-200 DFI	T599000	T580999	18-7817
85	1460999	1766823	18-7804	V-200 DFI	T801000	& UP	18-7817
85	3493913	4831998	18-7808	V-200 PRO XS	B504989	& UP	18-7817
90 (6 cyl.)	1766824	4845300	18-7804	V-220 LASER	B117316	& UP	18-7817
90 (6 CYL)	5299506	6436122	18-7811 ①	V-225	5628028	& UP	18-7810
90 (6 CYL)	6436123	& UP	18-7817 ⑤	V-225 SEA PRO/MARATHON (3.0L)	D208813	& UP	18-7817
90 (3 CYL)	A996142	D283221	18-7818-1	V-225 (3.0L) EFI	G129222	& UP	18-7817
90 (3 CYL) INLINE OIL CHECK VALVE	C222000	D283221	18-7817	V-225 (3.0L) DFI	G590000	T598999	18-7817
90 (3 CYL) 90 DEGREE OIL CHECK VALVE	C222000	D283221	18-7818-1	V-225 DFI	T599000	T800999	18-7817
90 (3 CYL)	D283222	& UP	18-7817	V-225 DFI	T801000	& UP	18-7817
90 (3 CYL) DFI	T801000	& UP	18-7817	V-225 DTS	T599000	B417701	18-7817
95 (950) 6 CYL	1869776	2318585	18-7804	V-225 DTS	B417702	& UP	18-7817
95XR	ALL		18-7806-1	V-225 PRO XS	B104549	& UP	18-7817
100	2318586	3253111	18-7804	V-250 (3.4L)	C101891	& UP	18-7817
100 (4 CYL) 90 DEGREE OIL CHECK VALVE	B209468	D283221	18-7818-1 ⑥	V-250 (3.0L) EFI	G129222	& UP	18-7817
100 (4 CYL) INLINE OIL CHECK VALVE	B209468	D283221	18-7817 ⑦	V-250XB	G980600	T800999	18-7817
100 (4 CYL)	D283222	G965520	18-7817	V-250 DFI	B528615	& UP	18-7817
105 JET	ALL		18-7817	V-250 PRO XS	B426561	& UP	18-7817
110	1870204	2314955	18-7804	V-275 (3.4L)	C101891	& UP	18-7817
115	3761034	& BELOW	18-7807	V-300 (3.4L)	5611648	& UP	18-7812
115 (6 CYL)	5314656	6436122	18-7813 ①	XR4/XR6	C100860	& Below	18-7817
115 (6 CYL) TRIANGULAR F/P	6436123	& UP	18-7817 ⑤	Magnum II	ALL		18-7817
115 (4 CYL)	B209468	& UP	18-7818-1 ⑥				

① Except models with square fuel pump
 ② Models equipped with Tillotson BA, BB, BD carburetors
 ③ Dual fuel pump applications

④ Single fuel pump applications
 ⑤ Models with square fuel pumps

⑥ Use with white fuel pump body
 ⑦ Use with black fuel pump body

MARINER DIAPHRAGMS (Japanese Models)

Model	S/N Code	S/N	Diaphragms	Model	S/N Code	S/N	Diaphragms
5C	6E3	ALL	18-7834	28	644	M-664-151346 & UP	②
6C	6H8	ALL	18-7833	30	689	ALL	②
6D	6H6	ALL	18-7833	40 TC	6E9	ALL	②
8B	677	ML-677-316416 & UP	18-7837	40A APE	676	M-676-A00346 — 001990	18-7839
8B	677	M-677-012921 & UP	18-7837	40A APE	676	M-676-A001991 & UP	②
8C	6G1	ALL	18-7833	40A APE	676	ML-676-A41356 — 302250	18-7839
9.9C	682	ALL	①	40A APE	676	ML-676-A302251 & UP	②
15A	651	ALL	18-7839	40A APE	676	E-676-A10121 — 100355	18-7839
15C	684	ALL	①	40A APE	676	E-676-A100356 & UP	②
20A APE	653	ALL	18-7839	40A APE	676	EL-676-A50631 — 400940	18-7839
20C TPE	6A9	ALL	②	40A APE	676	EL-676-A400941 & UP	②
25A	648	EL-648-550230 & BELOW	18-7839	40B TPE	676	ALL	②
25A	648	EL-648-550231 & UP	②	40C TC	6E9	ALL	②
25A	648	E-648-26825 & BELOW	18-7839	48	670	ML-670-302510 & BELOW	18-7839
25A	648	E-648-26826 & UP	②	48	670	ML-670-302511 — 311995	②
25A	648	ML-648-304174 & BELOW	18-7839	48	670	M-670-02640 & BELOW	18-7839
25A	648	ML-648-304174 & UP	②	48	670	M-670-02641 — 002160	②
25A	648	M-648-19025 & BELOW	18-7839	W48	670	ML-670-311996 & UP	18-7839
25A	648	M-648-19026 & UP	②	W48	670	M-670-002161 & UP	18-7839
25C TPE	695	EL-695-550101 — 555959	②	55	663	EL-663-315379 — 317710	18-7839
25C TPE	695	EL-695-555960 & UP	18-7839	55	663	EL-663-317711 & UP	②
25C TPE	695	E-695-250101 — 253861	②	55	663	E-663-004041 — 004317	18-7839
25C TPE	695	E-695-253862 & UP	18-7839	55	663	E-663-004318 & UP	②
25C TPE	695	ML-695-300101 — 318173	②	55	663	ML-663-36475 & BELOW	18-7839
25C TPE	695	ML-695-318174 & UP	18-7839	55	663	M-663-02730 & BELOW	18-7839
25C TPE	695	M-695-000101 — 023895	②	W55	663	ML-663-578278 — 583880	18-7839
25C TPE	695	M-695-023896 & UP	18-7839	W55	663	ML-663-583881 & UP	②
28	644	EL-664-570795 & BELOW	18-7839	60 2 CYL	6F0	ALL	18-7839
28	644	EL-664-570796 & UP	②	60 2 CYL	675	EL-675-30101 — 300280	18-7839
28	644	E-664-270310 & BELOW	18-7839	60 2 CYL	675	EL-675-300281 — 304180	②
28	644	E-664-270311 & UP	②	60 2 CYL	675	EL-675-304180 & UP	18-7839
28	644	ML-664-451125 & BELOW	18-7839	60 2 CYL	675	E-675-00101 — 000180	18-7839
28	644	ML-664-451126 & UP	②	60 2 CYL	675	E-675-00181 — 001170	②
28	644	M-664-151345 & BELOW	18-7839	60 2 CYL	675	E-675-001171 & UP	18-7839

① Requires the use of both 18-7837 and 18-7838

② Requires the use of both 18-7839 and 18-7840

8' LENGTH COMPLETE FUEL LINE ASSEMBLIES

3/8"
FUEL LINE ASSEMBLY

18-8010EP-1 *SILVERADO 4000 Premium*



**18-8068
18-8082
TANK
CONNECTOR**
(SOLD SEPARATELY)

**18-8084
FUEL
CONNECTOR**

**18-8005EP-1
PRIMER
BULB**

**18-8083
FUEL
CONNECTOR**

FUEL LINE ASSEMBLY COMPONENTS

8' LENGTH COMPLETE FUEL LINE ASSEMBLIES

3/8"
FUEL LINE ASSEMBLY

18-8012EP-1 *SILVERADO 4000 Premium*

OE# 32-858114Q08,
32-858114K08



**18-8074
HOSE BARB**

**18-8005EP-1
PRIMER
BULB**

**18-8073
HOSE BARB**

FUEL LINE ASSEMBLY COMPONENTS

Has 1/4" NPT threaded fitting on engine end and 1/4" NPT threaded fitting on the tank end. Primer bulb is included in this 8ft. (2.44 m) assembly. Fits various applications using the older style twist type disconnects at the engine end and either a bayonet or thread-in fitting on the tank end.

8' LENGTH COMPLETE FUEL LINE ASSEMBLIES

3/8"
FUEL LINE ASSEMBLY

18-8024EP-1 *SILVERADO 4000 Premium*

OE# 32-858104Q08,
32-858104K08



**18-8074
HOSE BARB**

**18-8005EP-1
PRIMER
BULB**

**18-8076
FUEL
CONNECTOR**

FUEL LINE ASSEMBLY COMPONENTS

Has standard quick connect type fitting on engine end and 1/4" NPT threaded fitting on the tank end. Primer bulb is included in this 8 ft. (2.44 m) assembly. Fits Force 40 HP and larger (1993 & Newer), Force 9.9/15/25HP (1998), and all Mercury/Mariner outboards using clip on type disconnect at engine ends and a tank with threaded fuel pickup fitting.

* Tanks and Engines for picture purpose only.

8' LENGTH COMPLETE FUEL LINE ASSEMBLIES

3/8"
FUEL LINE ASSEMBLY

18-8025EP-1 SILVERADO 4000 Premium

**OE# 32-858105Q08,
32-858105K08**



*

*

FUEL LINE ASSEMBLY COMPONENTS

Has standard quick connect type fitting on engine end and bayonet style fitting on the tank end. Primer bulb is included in this 8 ft. (2.44 m) assembly.
Fits Force 40 HP and larger (1993 & Newer), Force 9.9/15/25HP (1998), and all Mercury/Mariner outboards using clip-on type disconnect at the engine end and an older style tank with bayonet type connection.

8' LENGTH COMPLETE FUEL LINE ASSEMBLIES

3/8"
FUEL LINE ASSEMBLY

18-8016EP-1 SILVERADO 4000 Premium

**OE# 32-858109Q12,
32-858109K12**



*

*

FUEL LINE ASSEMBLY COMPONENTS

Has double sealed quick connect type fitting on tank end and clip-on type quick connect on engine end. Primer bulb is included in this 8ft. (2.44m) assembly.
Fits Force 40 HP and larger (1993 & Newer), Force 9.9/15/25HP (1998) and all Mercury Mariner outboards using clip-on type disconnects at both tank and engine ends

12' LENGTH COMPLETE FUEL LINE ASSEMBLIES

3/8"
FUEL LINE ASSEMBLY

18-8023EP-1 SILVERADO 4000 Premium

**OE# 32-857103Q12,
32-857103K12**



18-8074 HOSE BARB



18-8005EP-1 PRIMER BULB

18-8073 HOSE BARB



*

*

FUEL LINE ASSEMBLY COMPONENTS

Has 1/4" NPT threaded fitting on engine end and 1/4" NPT threaded fitting on the tank end. Primer bulb is included in this 8ft. (2.44 m) assembly.
Fits various applications using the older style twist type disconnects at the engine end and either a bayonet or thread-in fitting on the tank end.

* Tanks and Engines for picture purpose only.

Display Package



18-4462 TANK ADAPTER
(Clip Style Fitting)
For: Mercury/Mariner
(Female Twist-on)

Display Package



18-8002EP-1 PRIMER BULB
1/4"

18-8004EP-1 PRIMER BULB
5/16"
Replaces: 89396A38, 89396Q38
Large capacity bulb

18-8005EP-1 PRIMER BULB
3/8"
Replaces: 13330A3, 13330Q, 13330Q5
Large capacity bulb

Display Package



HOSE BARB APPLICATION

Part #	Mercury O.E. #	Barb	NPT	Conn. Type
18-8054	22-63186	5/16"	1/8"	Male
18-8055	22-63187	5/16"	1/4"	Male
18-8073	—	3/8"	1/8"	Male
18-8074	—	3/8"	1/4"	Male

① Discount shop pack of 10 - Priced per package

 <p>NEW</p> <p>18-7083 PRIMER BULB Replaces: 858763 Fits: 30 2cyl(All), 30 JET 3cyl(All), 40 2cyl(All), 40 3cyl(All), 40 JET(All), 50 3cyl(G590000 & Up), 55 3cyl(G590000 & Up), 60 3cyl(G590000 & Up), 60 3cyl Bigfoot(All), 65 JET (All), 75 3cyl(D283222 & Up), 90 3cyl(D283222 & Up)</p>	 <p>18-80410 FUEL CONNECTOR Replaces: 22-13563T3 Female Hose connector 5/16" Fits: 4/5 2-Stroke (1999 & Up) Mates with 18-80412</p>	 <p>18-80412 FUEL CONNECTOR Replaces: 22-816856T2 Male Hose connector 5/16" Fits: 100 4-cyl. (1988-99), 115 4-cyl. (1989 & up), 125 4-cyl. (1994 & up), 65 Jet (1994 & up), 75 3-cyl. (1987 & up), 80 Jet (1994 & up), 90 3-cyl. (1987 & up) Mates with 18-80410</p>
 <p>18-8068 TANK CONNECTOR (1/4" NPT) (Female)</p>	 <p>18-8069 FUEL CONNECTOR 5/16" Replaces: 22831Q3, 22831A3 (Female)</p>	 <p>18-8070 FUEL CONNECTOR 5/16" Replaces: 30185A3, 30185Q3 (Male)</p>
 <p>18-8075 FUEL CONNECTOR (1/4") Replaces: 22-14213M, 2214213Q Mates with 18-8077-1</p>	 <p>18-8076 18-8076-10^① FUEL CONNECTOR (3/8") Replaces: 22-13563A3, 22-13563Q3 Mates with 18-8077-1</p>	 <p>18-8077-1 18-8077-1-10^① TANK CONNECTOR (1/4" NPT) Mates with 18-8075, 18-8076, 18-8085</p>
 <p>18-8082 TANK CONNECTOR Mercury Straight Fitting (1/4" NPT) (Female)</p>	 <p>18-8083 FUEL CONNECTOR 3/8" (Female)</p>	 <p>18-8084 FUEL CONNECTOR 3/8" Replaces: 30185A3, 30185Q3 (Male)</p>
 <p>18-8085 18-8085-10^① FUEL CONNECTOR (5/16") Mates with 18-8077-1</p>	 <p>18-8091 FUEL CONNECTOR Replaces: 22-13563Q7, 22-13563T7 Mates with 18-80402</p>	 <p>18-80402 FUEL CONNECTOR 1/4" NPT Mates with 18-8091</p>

① Discount shop pack of 10 - Priced per package

**- UNIVERSAL DESIGN -
DIRECT REPLACEMENT FOR MERCURY AND YAMAHA
FUEL WATER SEPARATOR BRACKETS**



Bracket Type	Part #	Replaces	Bracket Type	Part #	Replaces
1/4" Stainless Steel	18-7777		1/4" Aluminum	18-7853-1	Mercury 89876A3
3/8" Stainless Steel	18-7776		3/8" Aluminum	18-7775	

FUEL WATER SEPARATOR KITS



21 Micron filter kits - for carbureted engines

Kit Type	Part #	Micron Rating	Contents	Replaces
1/4" Aluminum (Short Filter)	18-7848-1	21	1 - 18-7844 filter & 1 18-7853-1 bracket 2 - 18-4256 1/4" pipe plugs	35-802893A4, Q4, 35-60494A4
1/4" Aluminum Bonus Pack Contains spare filter	18-7848-2	21	2 - 18-7844 filter & 1 18-7853-1 bracket 2 - 18-4256 1/4" pipe plugs	
1/4" Aluminum (Tall Filter)	18-7852-1	21	1 - 18-7845 filter & 1 18-7853-1 bracket 2 - 18-4256 1/4" pipe plugs	
1/4" Aluminum Bonus Pack Contains spare filter	18-7852-2	21	2 - 18-7845 filter & 1 18-7853-1 bracket 2 - 18-4256 1/4" pipe plugs	
3/8" Aluminum (Tall Filter)	18-7775-1	21	1 - 18-7845 filter & 1 18-7775 bracket 2 - 18-4264 3/8" pipe plugs	
1/4" Stainless Steel (Tall Filter)	18-7777-1	21	1 - 18-7845 filter & 1 18-7777 bracket 2 - 18-4256 1/4" pipe plugs	
3/8" Stainless Steel (Tall Filter)	18-7776-1	21	1 - 18-7845 filter & 1 18-7776 bracket 2 - 18-4264 3/8" pipe plugs	



10 MICRON FILTER KITS FOR FUEL INJECTED ENGINES

Kit Type	Part #	Micron Rating	Contents
1/4" Aluminum (Short Filter)	18-7983-1	10	1 - 18-7944 filter & 1 18-7853-1 bracket 2 - 18-4256 1/4" pipe plugs
1/4" Aluminum Bonus Pack Contains spare filter	18-7983-2	10	2 - 18-7944 filter & 1 18-7853-1 bracket 2 - 18-4256 1/4" pipe plugs
1/4" Aluminum (Tall Filter)	18-7982-1	10	1 - 18-7945 filter & 1 18-7853-1 bracket 2 - 18-4256 1/4" pipe plugs
1/4" Aluminum Bonus Pack Contains spare filter	18-7982-2	10	2 - 18-7945 filter & 1 18-7853-1 bracket 2 - 18-4256 1/4" pipe plugs
1/4" Aluminum (High Capacity Filter)	18-7966-1	10	1 - 18-7866 filter & 1 18-7853-1 bracket 2 - 18-4256 1/4" pipe plugs
3/8" Aluminum (Tall Filter)	18-7986-1	10	1 - 18-7945 filter & 1 18-7775 bracket 2 - 18-4264 3/8" pipe plugs
1/4" Stainless Steel (Tall Filter)	18-7984-1	10	1 - 18-7945 filter & 1 18-7777 bracket
3/8" Stainless Steel (Tall Filter)	18-7985-1	10	1 - 18-7945 filter & 1 18-7776 bracket 2 - 18-4264 3/8" pipe plugs



10 MICRON FILTER KITS WITH DRAIN BOWLS

Sierra AquaVue™ and metal bowl separator filters allow water to be drained from the filter to extend service life. Use the AquaVue™ bowl for outboard, above deck installations. USCG regulations require the use of the flame resistant metal bowl below deck.

Kit Type	Part #	Micron Rating	Contents
1/4" Aluminum w/ AquaVue™ bowl	18-7932	10	1 - 18-7919 filter & 1 18-7853-1 bracket 1 - 18-7922 AquaVue™ bowl 2 - 18-4256 1/4" pipe plugs
1/4" Aluminum w/ metal drain bowl	18-7951	10	1 - 18-7919 filter & 1 18-7853-1 bracket 1 - 18-7924 metal bowl 2 - 18-4256 1/4" pipe plugs
1/4" Stainless Steel w/ AquaVue™ bowl	18-7937	10	1 - 18-7919 filter & 1 18-7777 bracket 1 - 18-7922 AquaVue™ bowl 2 - 18-4256 1/4" pipe plugs
1/4" Stainless Steel w/ metal drain bowl	18-7938	10	1 - 18-7919 filter & 1 18-7777 bracket 1 - 18-7924 metal bowl 2 - 18-4256 1/4" pipe plugs

COMPACT BRACKET AND SEPARATOR KIT FOR SMALL OUTBOARDS AND FRESH WATER APPLICATIONS



18-7774
COMPACT ALUMINUM BRACKET

18-7965-1
10 MICRON COMPACT SEPARATOR KIT
Contains:
1 - 18-7774 bracket
1 - 18-7865 filter



REPLACEMENT FILTERS



UNIVERSAL DESIGN - DIRECT REPLACEMENT FOR MERCURY AND YAMAHA

10 MICRON REPLACEMENT FILTERS			21 MICRON REPLACEMENT FILTERS		
Part #	Description	Replaces	Part #	Description	Replaces
18-7944	Short - 3.875"	35-807172, 35-802893Q	18-7844	Short - 3.875"	35-807172, 35-802893Q
18-7945	Long - 4.35"	35-807172	18-7845	Long - 4.35"	35-807172
18-7866	High Capacity - 6"				
18-7865	Compact 10 Micron				
18-7967	Early model with sensor	35-18458Q3			
18-7968	Late model with sensor	35-18458Q4			



10 Micron replacement filters and kits with drain bowls

REPLACEMENT FILTERS			FILTER & BOWL KITS	
Part #	Description	Replaces	Part #	Description
18-7919	Spin on replacement	35-809097 Racor S3213	18-7928	Filter & AquaVue™ Bowl Mercury Style Contains: 18-7919 filter, 18-7922 bowl
18-7920	Spin on replacement	35-809099 Racor S3214	18-7929	Filter & Metal Bowl MercuryStyle Contains: 18-7919 filter, 18-7924 bowl
18-7948	Spin on replacement Fits - 320RRAC01	35-886638 Racor S3227	18-7969	Filter & Metal bowl Contains: 18-7948 filter, 18-7924 bowl
REPLACEMENT BOWLS			18-7994	Filter & AquaVue™ Bowl Contains: 18-7948 filter, 18-7922 bowl
18-7922	AquaVue™ Collection Bowl			
18-7924	Metal Collection Bowl			



**18-7936
FUEL FILTER ELEMENT**
Replaces: 35-888289T2
Fits: 75 4-Stroke (2000 & Up), 90 4-Stroke (2000 & Up), 115 EFI 4-Stroke (2001 & Up)



**18-7712
FUEL FILTER (INLINE)**
Replaces: 35-16248
Fits: 4/5 2 cyl (1999 & Up), 4/5/6 4 stroke (1999 & Up), 8/9.9 4-stroke (2005 & Up)



**18-7713
FUEL FILTER (INLINE)**
Replace: 35-80365M
Fits: Mercury/Mariner 9.9 4-Stroke(1995-98), 15 4-Stroke (1998 & Up), Yamaha 6 (1989, 1992-99), 8 (1989-99, 2001-02), F4 (1999-02), F9.9 (1989-95, 1997-99, 2001-02), FT 9.9 (1988-90)



**18-7714
FUEL FILTER (INLINE)**
Replaces: 35-877565T1
Fits: 25 4-Stroke (1998 & Up), 30 4-Stroke (1999-01), 30 3 cyl 4-Stroke (1999-01), 40 4-Stroke (1998-01), 40 4-Stroke 4 cyl (2001-02), 40 Carb 3-cyl 4-Stroke (2002 & Up), 50 4-Stroke 4 cyl (2001-02), 60 4-Stroke 4 cyl (2001-02), 75 4-Stroke (2000 & Up), 90 4-Stroke (2000 & Up)



**18-7718
FUEL FILTER (INLINE)**
Replaces: 35-879885T
For: 135/150/175 4-Stroke Verado (S/N 1B227000 & Up), 200/225 4-Stroke Verado (S/N OT980000 & Up), 250/275 4-Stroke Verado (S/N OT801000 & Up)



**18-7802
FUEL FILTER**
Replaces: 35-87946A3, 35-87946-Q3, Q4
For: 6 HP thru 25 HP





**18-7832
FUEL FILTER**
Replaces: 1399-3938
For: A.J, KA, KB, KC, KD, WM, WMC Carb.



**18-7979
FUEL FILTER**
Replace: 881540
Fits: 115 EFI (4 Stroke), 75HP (4 Stroke), 75HP (4 Stroke) (Bodensee), 90HP (4 Stroke)



**18-7981
FUEL FILTER**
Replaces: 35-884380T, 35-8M0020349
Fits: All Verados, 90HP (DFI) (3 cyl), 115 DFI (3 cyl) / 200HP (DFI) / 225HP (DFI) (including 3.0L DFI)

	Fuel Filters	PKG. OF 10
	Part # Application:	
	18-7828-1 1/4" Small Capacity (For 1/4" Fuel Line)	
	18-7829 1/4" Large Capacity (For 1/4" Fuel Line) Replaces: 35-16494, 35-816296, 35-816296T, 35-816296K03	
	18-7830 5/16" Replaces: 35-16494-1, 35-816296-1, 35-816296T1	
18-7831 3/8" 802128A1		
		18-7113-9 Ⓜ O-RING Replaces: 25-897536 Fits: 18-7802 Filter Element (35-87946Q3)



18-7997
AIR FILTER
 Replaces: 35-853333T
 Fits: V115 DFI (2.5L) (2000), V-135 DFI (2.5L) (1998 & Up), V-150 DFI (2.5L) (1998 & Up), V-175 DFI (2.5L) (2001 & Up), 200 DFI (1998-02), 225 DFI (1998-02)



18-7998
AIR FILTER
 Replaces: 35-893318T01
 For: 200/225 4-Stroke Verado (S/N OT980000 & Up), 250/275 4-Stroke Verado (S/N OT801000 & Up)



18-7999
AIR FILTER
 Replaces: 35-896247
 For: 135/150/175 4-Stroke Verado (S/N 1B227000 & Up)



18-3605
THERMOSTAT KIT
 Fits: V-135 DFI (2.5L)(1998 & Up), V-150 DFI (2.5L) (1998 & Up), V-175 DFI (2.5L)(2000 & Up)





18-3606
THERMOSTAT KIT
 Fits: 200 3.0L DFI DTS (ALL), 200 3.0L EFI (2003 & Up)(OT750164 & Up), 200 DFI (1997 & Up)(OG386496 & Up), 225 3.0L EFI (1999 & Up)(OG760300 & Up), 225 3.0L EFI SeaPro (2004 & Up)(OT801000 & Up), 225 3.0L DFI DTS (2003 & Up)(OT599000 & Up), 225 DFI (1998 & Up)(OG590000 & Up), 250 3.0L EFI (1999 & Up) (OG760300 & Up), 250 Long 3.0L EFI (OT861319 & Up)

① **18-3672D** Display Package

18-3672
THERMOSTAT KIT
 — CONTAINS —

Part #	Desc.	O.E. #
18-3553	Thermostat	75692
18-0182	Thermostat Gasket	27-62386



HP	Beg. S/N	End S/N	HP	Beg. S/N	End S/N
V135	A904646	& UP	V150 MAGII	C239553	4571651
V150	A904646	& UP	V150 MAGIII	D082000	4825248
V150 XR4	C239553	C159199	V175	C100861	& UP
V150 XR6	D082000	& UP	V200	6435503	& UP



18-3569
THERMOSTAT KIT
 Replaces: 803061T1

HP	Beg. S/N	End S/N	HP	Beg. S/N	End S/N
70 3 cyl.	A996142	& UP	100 4 cyl.	B209468	& UP
75 3 cyl.	C222000	& UP	115 4 cyl.	C100000	& UP
80 3 cyl.	A996142	& UP	125 4 cyl.	D283222	& UP
90 3 cyl.	A996142	& UP			



18-3534
THERMOSTAT 110°
 Replaces: 850055001
 Fits: 40 3cyl (1998 & Up), 40 Jet (2000 & Up), 50 3cyl (1986 & Up), 55 3cyl (1996 & Up), 60 3cyl (1984 & Up)



18-3535
THERMOSTAT 130°
 Replaces: 885599004
 Fits: 200 3.0L DFI DTS (ALL), 200 3.0L EFI (2003 & Up)(OT750164 & Up), 200 DFI (1997 & Up)(OG386496 & Up), 225 3.0L EFI (1999 & Up)(OG760300 & Up), 225 3.0L EFI SeaPro (2004 & Up) (OT801000 & Up), 225 3.0L DFI DTS (2003 & Up)(OT599000 & Up), 225 DFI (1998 & Up)(OG590000 & Up), 250 3.0L EFI (1999 & Up)(OG760300 & Up), 250 Long 3.0L EFI (OT861319 & Up)



18-3536
THERMOSTAT 143°
 Replaces: 833072003
 Fits: V135 DFI 2.5L (1998 & Up) (OG590000 & Up), V150 DFI 2.5L (1998 & Up)(OG590000 & Up), V175 DFI 2.5L (2001 & Up)(OT178500 & Up)



18-3537
THERMOSTAT 143°
 Replaces: 833072004
 Fits: 75 3 cyl DFI 1.5L (2006 & Up) (OT980000 & Up), 90 3 cyl DFI 1.5L (2004 & Up)(OT801000 & Up), 115 3 cyl DFI 1.5L (2004 & Up)(OT801000 & Up)

① Items ending in "D" are Display Packaged - Regular number is Non-Display

② Priced per package

18-3553
THERMOSTAT
Replaces: 75692
143°



18-3553 THERMOSTAT APPLICATION

HP	Beg. S/N	End. S/N	HP	Beg. S/N	End. S/N
7.5	5226935	& UP	V150	A904646	& UP
9.8	5206550	& UP	V175	C100861	& UP
40	3336258	C159199	V200	6435503	& UP
50/60	D000750	& UP	V220	B117316	& UP
65	3547987	4571651	V225	5628028	& UP
70	4571652	4825248	V300/3.4L	5611648	& UP
70/75/80/90	A996142	& UP	XR4	C239553	D081999
100/115	B209468	& UP	Magnum II	C239553	D081999
V135	A904646	& UP			

18-3549
THERMOSTAT
Replaces: 14586
For: 6, 7, 8, 9.9 & 15 HP
Mercury/Mariner A197112 & Later
120°



18-3549 THERMOSTAT APPLICATION

MARINER		
HP	Serial #	
6,8,9.9 (2 cyl.)	A197112	Later
Sea Pro 10	D038000	Later
15 (2 cyl.)	B292414	Later
18XD, 20XD, 25XD	B114231	Later
25 (2 cyl.) 25 Sea Pro	B238464	Later
30 (2 cyl.)	G055314	Later
45 Jet, 50, 55, 60 (3 cyl.)	G290585	Later
MERCURY		
Sea Pro 10	D038000	Later
15 (2 cyl.)	B292414	Later
18XD, 20XD, 25XD	B114231	Later
25 (2 cyl.) 25 Sea Pro	B238464	Later
30 (2 cyl.)	G055314	Later
45 Jet, 50, 55, 60 (3 cyl.)	G290585	Later



18-5896
SENDER
Replaces: 12415
1/8"-27NPT Threads

18-3007
18-3007-10[ⓐ]
IMPELLER
Replaces: 47-89983,
47-89983T



18-3008
IMPELLER
Replaces: 47-20813



18-3012
IMPELLER
Replaces: 47-22748



18-3017
18-3017-10[ⓐ]
IMPELLER
Replaces: 47-89984,
47-89984T4, 47-30221,
47-65960



Part #	ID	Replaces:
18-3039	.456"	47-89981
18-3054	.438"	47-89980



IMPELLER

18-3052
IMPELLER
Replaces: 47-89982



18-3056
18-3056-10[ⓐ]
IMPELLER
Replaces: 47-43026-2,
47-43026T2



18-3057
IMPELLER
Replaces: 47-85089-3



18-3062
IMPELLER
Replaces: 47-42038-2



18-3063
IMPELLER
Replaces: 47-95611M



18-3066
IMPELLER
Replaces: 47-11590M



18-3067
IMPELLER
Replaces: 47-84797M



18-3069
IMPELLER
Replaces: 47-81423M,
47-97108M



18-3072
IMPELLER
Replaces: 47-80395M



18-3073
IMPELLER
Replaces: 47-96305M



18-3074
IMPELLER
Replaces: 47-84027M,
47-84027T



APPLICATION BEGINS ON PAGE 343

[ⓐ] Discount shop pack of 10 - Priced per package

 <p>18-8900 IMPELLER Replaces: 47-19453</p>	 <p>18-3098 IMPELLER Replaces: 47-161543</p>	 <p>18-3293 IMPELLER KEY Replaces: 28-43037 Also large O/B's</p>	 <p>18-3294 IMPELLER KEY Replaces: 28-81603M</p>
 <p>18-3300 IMPELLER KEY Replaces: 28-83444M For models: 40A, 40B, 40C</p>	 <p>18-3305 IMPELLER KEY Replaces: 28-81912M For models: 6C-D, 8C, 9.9C, 15C</p>	 <p>18-3109 WATER TUBE GUIDE Replaces: 23-29804, 23-29804T (Use with 18-3116 Housing)</p>	 <p>18-3014 LOWER WATER PUMP SEAL Replaces: 26-821310 For: 4-Stroke O/B's, 25/30/40/45/50 HP s/n OG760300 & UP</p>
 <p>18-3013 UPPER WATER PUMP SEAL Replaces: 26-821309 For: 4-Stroke O/B's, 25/30/40/45/50 HP s/n OG760300 & UP</p>	 <p>18-3110 WATER PUMP HOUSING WITH BUSHING Replaces: 26-38970 (Part of 18-3116 Housing)</p>	 <p>18-3151 WATER COUPLING ASSEMBLY Replaces: 816597</p>	 <p>PKG. OF 5 18-3227 18-3227-9^① WATER PUMP DOWEL PIN Replaces: 17-35973 For: 20-225HP S/N 1866496-Up</p>
 <p>18-1730 COUPLING Replaces: 43585 For: 200, 225, 250 & 275 Verado's</p>	 <p>18-3113 INSERT CUP Replaces: 70977</p>	 <p>18-3114 INSERT CUP Replaces: 48752, 48752T</p>	 <p>18-3115 INSERT CUP Replaces: 48753</p>
 <p>18-3435 INSERT CUP</p>	 <p>18-3107 IMPELLER PLATE Replaces: 54705, 32768</p>	 <p>18-3117 IMPELLER PLATE Replaces: 32435</p>	 <p>18-3122 IMPELLER PLATE Replaces: 817276, 8172761</p>
 <p>18-3139 IMPELLER PLATE Replaces: 46895</p>	 <p>18-3436 IMPELLER PLATE</p>	 <p>18-3116 WATER PUMP HOUSING Replaces: 46-96148A1, 46-96148T</p>	 <p>18-3118 WATER PUMP HOUSING Replaces: 46-77822A1</p>

① Priced per package



18-3414
WATER PUMP BASE
Replaces: 46-96146A5



18-3416
WATER PUMP BASE
Replaces: 46-96146A6



18-3419
WATER PUMP BASE
Replaces: 46-42579A3



18-3422
WATER PUMP BASE
Replaces: 46-77516A1



18-3423
WATER PUMP BASE
Replaces: 46-73640A1



18-3424
WATER PUMP BASE
Replaces: 46-77177A1



18-3445
WATER PUMP BASE
Replaces: 46-812966A7
For: 40-60 HP



① **18-3207D**

18-3207
IMPELLER REPAIR KIT
Replaces: 47-89983T2, 47-89983Q1
— CONTAINS —

Part #	Desc.	O.E. #	Qty.
18-3007	Impeller	47-89983	1
18-2945	Drain Gasket	12-20260,12-19183	2
18-2823	Low. Water Pump Base to Face Plate Gasket	27-32769, 27-19553	1
18-2824	Upper Face Plate to Pump Body Gasket	27-32770	1
18-2825	Water Pump Base Gasket	27-32771,27-19551	1
18-2841	Water Pump Base Gasket	27-77417,27-19552	1
18-2948	Rubber Washer	12-49221-1	1
18-3107	Plate	54705	1
18-7155	O-Ring	25-26855	1
18-7174	O-Ring	25-45711	1
18-7115	O-Ring	25-26722	1



① **18-3214D**

18-3214
IMPELLER REPAIR KIT
Replaces: 47-43026T6, 47-43026T8, 47-43026T11
— CONTAINS —

Part #	Desc.	O.E. #	Qty.
18-2564	Water Pump Base to Face Plate Gasket	27-43033-1	1
18-2565	Water Pump Base to Gear Housing Gasket	27-43047-1	1
18-2566	Face Plate to Water Pump Cover Gasket	27-817277	1
18-2944	Seal Ring	26-45577	1
18-3056	Impeller	47-43026-1	1
18-3122	Impeller Plate	817276	1
18-7420	O-Ring	25-21836	1

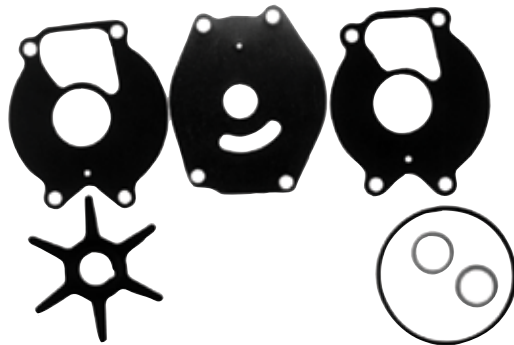

① **18-3215D**

18-3215
IMPELLER REPAIR KIT
Replaces: 47-85089T7
— CONTAINS —

Part #	Desc.	O.E. #	Qty.
18-2560	Impeller Washer Gasket	12-86645	2
18-2561	Gear Housing to Face Plate Gasket	27-85087	1
18-2562	Gear Housing to Face Plate Gasket	27-99326-1	1
18-3057	Impeller	47-85089-3	1
18-7419	O-Ring	25-69202	1



18-3149-1
WATER PUMP KIT
Replaces: 46-42040A5, 46-42040T5
For: 10 Magnum, Marathon, Sea Pro, Viking
15 Marathon, Sea Pro 6, 8, 9.9HP, XR10

APPLICATION BEGINS ON PAGE 343

① Items ending in "D" are Display Packaged - Regular number is Non-Display



18-3265
IMPELLER REPAIR KIT
 Mercury 47-43026Q06
 For: 135/150/175 4-Stroke Verado (S/N 1B227000 & Up), 200/225 4-Stroke Verado (S/N OT980000 & Up), 250/275 4-Stroke Verado (S/N OT801000 & Up)

① **18-3217D** Display Package



18-3217
IMPELLER KIT
 Similar to: 46-96148A5 without base or housing
 — CONTAINS —

Part #	Desc.	O.E. #	Qty.
18-3109	Water Tube	23-29804	1
18-3017	Impeller	47-89984	1
18-2919	Water Pump Gasket	27-42631-1	1
18-3110	Grommet	26-38970	1
18-2945	Drain Gasket	12-20260, 12-19183	2
18-2826	Water Pump Base to Gear Housing Gasket	27-85610	1
18-2914	Water Pump Gasket	27-85608-1	1
18-2915	Water Pump Gasket	27-85609-1	1
18-2944	Seal Ring	26-45577	1
18-3117	Plate	32435	1
18-7158	O-Ring	25-30613	1
18-7162	O-Ring	25-33145	1
18-7173	O-Ring	25-30224	1
18-7176	O-Ring	25-90011	1
18-2801	Water Pump Gasket	27-32438	1
18-7196	O-Ring	25-38099	1
18-7426	O-Ring	35-30271	1

① **18-3239D** Display Package



18-3239
IMPELLER REPAIR KIT
 — CONTAINS —

Part #	Desc.	O.E. #	Qty.
18-3039	Impeller	47-89981	1
18-3139	Impeller Plate	46895	1
18-7409	O-Ring	—	1



18-3252
IMPELLER REPAIR KIT
 Replaces: 47-89982T1
 — CONTAINS —

Part #	Desc.	O.E. #	Qty.
18-2004	Oil Seal	26-20070	2
18-2006	Oil Seal	26-33467	1
18-2827	Upper Face Plate to Water Pump Body Gasket	27-39623	1
18-2828	Lower Water Pump Base to Face Plate	27-39625	1
18-3052	Impeller	47-89982	1
18-7164	O-Ring	25-33466	1



18-3406
UPPER WATER PUMP REPAIR KIT
 Replaces: 817275A08
 For: 135/150/175 4-Stroke Verado (S/N 1B227000 & Up), 200/225 4-Stroke Verado (S/N OT980000 & Up), 250/275 4-Stroke Verado (S/N OT801000 & Up)



18-3407
COMPLETE WATER PUMP REPAIR KIT
 Replaces: 817275A09
 For: 135/150/175 4-Stroke Verado (S/N 1B227000 & Up), 200/225 4-Stroke Verado (S/N OT980000 & Up), 250/275 4-Stroke Verado (S/N OT801000 & Up)

**18-3314
WATER PUMP KIT**



— CONTAINS —

Part #	Desc.	O.E. #	Qty.
18-3109	Water Tube Guide	23-29804	1
18-3017	Impeller	47-89984	1
18-3116	Housing	46-96148A1	1
18-3414	Base	46-96146A5	1
18-2919	Water Pump Gasket	27-42631-1	1
18-3110	Grommet	26-38970	1
18-2945	Drain Gasket	12-20260, 12-19183	2
18-2826	Water Pump Base to Gear Housing Gasket	27-85610-1	1
18-2914	Water Pump Gasket	27-85608-1	1
18-2915	Water Pump Gasket	27-85609-1	1
18-2944	Seal Ring	26-45577	1
18-3117	Plate	32435	1
18-7158	O-Ring	25-30613	1
18-7162	O-Ring	25-33145	1
18-7173	O-Ring	25-30224	1
18-7176	O-Ring	25-90011	1
18-2801	Gasket	27-32438	1
18-7196	O-Ring	25-38099	1
18-7426	O-Ring	35-30271	1

**18-3316
WATER PUMP KIT**
Replaces: 46-78400A2

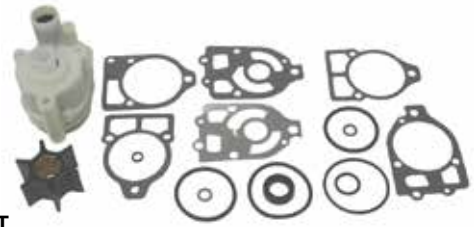

— CONTAINS —

Part #	Desc.	O.E. #	Qty.
18-3109	Water Tube Guide	23-29804	1
18-3017	Impeller	47-89984	1
18-3116	Housing	46-96148A1	1
18-3416	Base	46-96146A6	1
18-2919	Water Pump Gasket	27-42631-1	1
18-3110	Grommet	26-38970	1
18-2945	Drain Gasket	26-20260, 12-19183	2
18-2826	Water Pump Base to Gear Housing Gasket	27-85610-1	1
18-2914	Water Pump Gasket	27-85608-1	1
18-2915	Water Pump Gasket	27-85609-1	1
18-2944	Seal Ring	26-45577	1
18-3117	Plate	32435	1
18-7158	O-Ring	25-30613	1
18-7162	O-Ring	25-33145	1
18-7173	O-Ring	25-30224	1
18-7176	O-Ring	25-90011	1
18-2801	Gasket	27-32438	1
18-7196	O-Ring	25-38099	1
18-7426	O-Ring	35-30271	1

**18-3319
WATER PUMP KIT**
Replaces: 46-42579A4



— CONTAINS —

Part #	Desc.	O.E. #	Qty.
18-3109	Water Tube Guide	23-29804	1
18-3017	Impeller	47-89984	1
18-3116	Housing	46-96148A1	1
18-3419	Base	46-42579A3	1
18-2919	Water Pump Gasket	27-42631-1	1
18-3110	Grommet	26-38970	1
18-2945	Drain Gasket	26-20260, 12-19183	2
18-2826	Water Pump Base to Gear Housing Gasket	27-85610-1	1
18-2914	Water Pump Gasket	27-85608-1	1
18-2915	Water Pump Gasket	27-85609-1	1
18-2944	Seal Ring	26-45577	1
18-3117	Plate	32435	1
18-7158	O-Ring	25-30613	1
18-7162	O-Ring	25-33145	1
18-7173	O-Ring	25-30224	1
18-7176	O-Ring	25-90011	1
18-2801	Gasket	27-32438	1
18-7196	O-Ring	25-38099	1
18-7426	O-Ring	35-30271	1

**18-3507
WATER PUMP KIT
(Without Base)**
Replaces: 46-60366A1

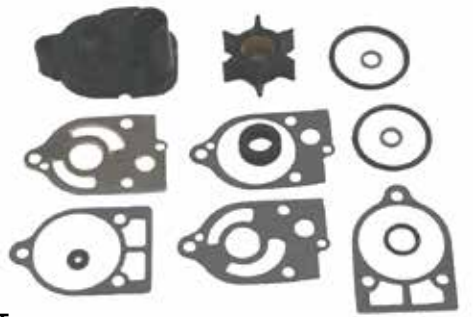

— CONTAINS —

Part #	Desc.	O.E. #	Qty.
18-3007	Impeller	47-89983	1
18-3118	Upper Pump Housing	46-77822A1	1
18-2945	Drain Gasket	12-20260, 12-19183	2
18-2823	Lower Water Pump Base to Face Plate Gasket	27-32769, 27-19553	1
18-2824	Upper Face Plate To Body Gasket	27-32770, 27-19551	1
18-2825	Water Pump Base Gasket	27-32771	1
18-2841	Water Pump Base Gasket	27-77417, 27-19552	1
18-2948	Drain Plug	12-49221-1	1
18-3107	Plate	54705	1
18-7155	O-Ring	25-26855	1
18-7174	O-Ring	25-45711	1
18-7115	O-Ring	25-26722	1

**18-3517
WATER PUMP KIT
(Without Base)**
Replaces:
46-60367A1,
46-96148A5,
46-96148A8

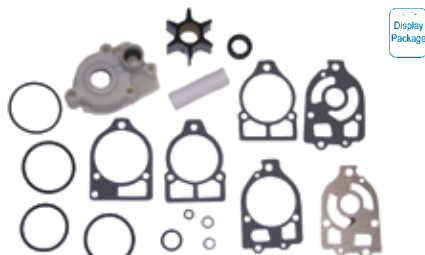

— CONTAINS —

Part #	Desc.	O.E. #	Qty.
18-3109	Water Tube	23-29804	1
18-3017	Impeller	47-89984	1
18-3116	Housing	46-96148A1	1
18-2919	Water Pump Gasket	27-42631-1	1
18-3110	Grommet	26-38970	1
18-2945	Drain Gasket	26-20260, 12-19183	2
18-2826	Water Pump Base to Gear Housing Gasket	27-85610-1	1
18-2914	Water Pump Gasket	27-85608-1	1
18-2915	Water Pump Gasket	27-85609-1	1
18-2944	Seal Ring	26-45577	1
18-3117	Plate	32435	1
18-7158	O-Ring	25-30613	1
18-7162	O-Ring	25-33145	1
18-7173	O-Ring	25-30224	1
18-7176	O-Ring	25-90011	1
18-2801	Water Pump Gasket	27-32438	1
18-7196	O-Ring	25-38099	1
18-7426	O-Ring	35-30271	1

**18-3322
WATER PUMP KIT**
Replaces: 46-77516A3



— CONTAINS —

Part #	Desc.	O.E. #	Qty.
18-3007	Impeller	47-89983	1
18-3118	Upper Pump Housing	46-77822A1	1
18-3422	Water Pump Base	46-77516A1	1
18-2945	Drain Gasket	12-20260, 12-19183	2
18-2823	Lower Water Pump Base to Face Plate Gasket	27-32769, 27-19553	1
18-2824	Upper Face Plate To Body Gasket	27-32770, 27-19551	1
18-2825	Water Pump Base Gasket	27-32771	1
18-2841	Water Pump Base Gasket	27-77417, 27-19552	1
18-2948	Drain Plug	12-49221-1	1
18-3107	Plate	54705	1
18-7155	O-Ring	25-26855	1
18-7174	O-Ring	25-45711	1
18-7115	O-Ring	25-26722	1



**18-3323
WATER PUMP KIT**
Replaces: 46-73640A2

— CONTAINS —

Part #	Desc.	O.E. #	Qty.
18-3007	Impeller	47-89983	1
18-3118	Upper Pump Housing	46-77822A1	1
18-3423	Water Pump Base	46-73640A1	1
18-2945	Drain Gasket.	12-20260, 12-19183	2
18-2823	Lower Water Pump Base to Face Plate Gasket	27-32769, 27-19553	1
18-2824	Upper Face Plate To Body Gasket	27-32770, 27-19551	1
18-2825	Water Pump Base Gasket	27-32771	1
18-2841	Water Pump Base Gasket	27-77417, 27-19552	1
18-2948	Drain Plug	12-49221-1	1
18-3107	Plate	54705	1
18-7155	O-Ring	25-26855	1
18-7174	O-Ring	25-45711	1
18-7115	O-Ring	25-26722	1

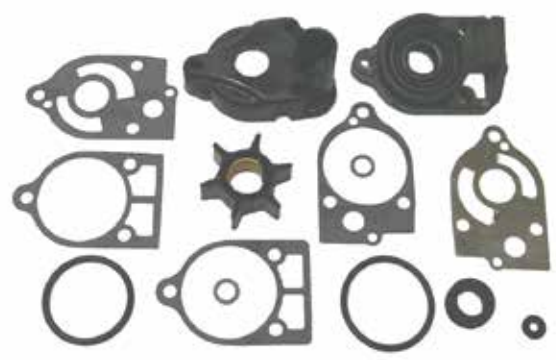

**18-3324
WATER PUMP KIT**
Replaces: 46-77177A3

— CONTAINS —

Part #	Desc.	O.E. #	Qty.
18-3007	Impeller	47-89983	1
18-3118	Upper Pump Housing	46-77822A1	1
18-3424	Water Pump Base	46-77177A1	1
18-2945	Drain Gasket.	12-20260, 12-19183	2
18-2823	Lower Water Pump Base to Face Plate Gasket	27-32769, 27-19553	1
18-2824	Upper Face Plate To Body Gasket	27-32770, 27-19551	1
18-2825	Water Pump Base Gasket	27-32771	1
18-2841	Water Pump Base Gasket	27-77417, 27-19552	1
18-2948	Drain Plug	12-49221-1	1
18-3107	Plate	54705	1
18-7155	O-Ring	25-26855	1
18-7174	O-Ring	25-45711	1
18-7115	O-Ring	25-26722	1



**18-3571
WATER PUMP HOUSING KIT**
Replaces: 817275A1
V-6 outboard



**18-3572
WATER PUMP HOUSING KIT**
Replaces: 817275A2
V-6 outboard



**18-3148
WATER PUMP REPAIR KIT**
Without Housing
Replaces: 46-84277M, 46-84277T

— CONTAINS —

Part #	Desc.	O.E. #	Qty.
18-0768	Wear Plate Gasket	—	1
18-3074	Impeller	47-84027M	1
18-3305	Woodruff Key	28-8192M	1



**18-3446
WATER PUMP KIT**
Replaces: 46-70941A3
For: 4/4.5 HP

— CONTAINS —

Part #	Desc.	O.E. #	Qty.
18-3039	Impeller	47-89981	1
18-3139	Impeller Plate	46895	1



18-3447
WATER PUMP KIT
Replaces: 46-46893A6, 47-22748
For: 3.9/4 HP

— CONTAINS —

Part #	Desc.	O.E. #	Qty.
18-3012	Impeller	47-22748	1
18-3139	Impeller Plate	46895	1



18-3448
WATER PUMP KIT
Replaces: 46-48744A3
For: 20 HP 1967-80

— CONTAINS —

Part #	Desc.	O.E. #	Qty.
18-3052	Impeller	47-89982	1
18-2827	Upper Face Plate Gasket	27-39623	1
18-2828	Lower Face Plate Gasket	27-39625	1
18-2829	Water Pump Base Gasket	27-39626	1



18-3570
WATER PUMP KIT

— CONTAINS —

Part #	Desc.	O.E. #	Qty.
NSS	Water Pump Housing	—	1
18-3056	Impeller	47-430262	1
18-2599	Face Seal & Tool	26-816575A2	1
18-3122	Impeller Plate	817276	1

HP	Reg. S/N	End. S/N	HP	Reg. S/N	End. S/N
817275A2 APPLICATION					
40 (4 stroke)			817275A2 APPLICATION (Cont.)		
(4 cyl.) Bigfoot	OT228405	& UP	80 Jet	OD283222	& UP
935cc Big Foot	OG231123	OT178499	90 (3 cyl.)	OA996142	& UP
50 (4 stroke)			90 (4 stroke)	OG960500	& UP
996cc Big Foot	OT178500	& UP	100 (4 cyl.)	OB209468	& UP
60 (3 cyl.)			115 (4 cyl.)	OC100000	& UP
Bigfoot	OD000750	& UP	125 (4 cyl.)	OD283222	& UP
60 (4 stroke)			817275A1 APPLICATION		
Bigfoot	OT178500	& UP	45 (4 stroke)		
65 Jet	OC283222	& UP	Bigfoot Bodensee	OG231123	& UP
70 (3 cyl.)	OA996142	& UP	V-200 DFI (3.0L)	OG386496	OG589999
75 (3 cyl.)	OC222000	& UP	V-200 DFI (3.0L)	OG590000	& UP
75 (4 stroke)	OG960500	& UP	V-225 (3.0L)		
80 (3 cyl.)	OA996142	& UP	Carb & EFI	OD280813	& UP
			V-225 DFI	OG590000	& UP
			V-250 (3.0L) EFI	OG129222	& UP



18-3425
WATER PUMP KIT
Without Housing
Replaces: 84188M, 84188T

— CONTAINS —

Part #	Desc.	O.E.#	Qty.
18-0292	Wear Plate to Pump Housing Gasket	27-81417M	1
18-3435	Insert Cup	—	1
18-0294	Wear Plate to Pump Base Gasket	—	1
18-3069	Impeller	47-81423M, 47-97108M	1
18-0256	Bolt	—	2
18-3436	Impeller Plate	—	1



18-3426
WATER PUMP KIT
With Housing
Replaces: 42431M, 97793M, 97793T

— CONTAINS —

Part #	Desc.	O.E.#	Qty.
18-3067	Impeller	47-84797M	1



18-3427
WATER PUMP KIT
With Housing
Replaces: 95611M

— CONTAINS —

Part #	Desc.	O.E.#	Qty.
18-0773	Wear Plate Gasket	—	1
18-3067	Impeller	47-84797M	1

MARINER COOLING SYSTEM APPLICATION

Mariner Models	S/N Code	S/N	Impeller	Plate	Impeller Cup	Impeller Repair Kit	Complete Kit
2A	646	All	18-3072	—	—	—	—
2B	6A1	All	18-3072	—	—	—	—
4A	6E0	All	18-3073	—	—	—	—
5C	6E3	All	18-3073	—	—	—	—
6C	6H8	All	18-3066	—	—	—	—
6D	6H6	All	18-3066	—	—	—	—
8A(M)	655	000000-000300	18-3063	—	—	—	—
8A(ML)	655	000000-300101	18-3063	—	—	—	—
8B(M)	677	000101 & Up	18-3063	—	—	—	—
8B(ML)	677	300101 & Up	18-3063	—	—	—	—
8C	6G1	All	18-3066	—	—	—	—
9.9C	682	All	18-3074	—	—	18-3148	—
15A(M)	651	000285 & Below	18-3063	—	—	—	—
15A(ML)	651	3000100 & Below	18-3063	—	—	—	—
15C	684	All	18-3074	—	—	18-3148	—
20C(M)	6A9	000101-005810	18-3067	18-3436	—	18-3426	—
20C(ML)	6A9	300101-306542	18-3067	18-3436	—	18-3426	—
20C(E)	6A9	250101-250819	18-3067	18-3436	—	18-3426	—
20C(EL)	6A9	550101-550693	18-3067	18-3436	—	18-3426	—
20C(M)	6A9	010112 & Up	18-3067	—	—	—	18-3427
20C(ML)	6A9	306543 & Up	18-3067	—	—	—	18-3427
20C(E)	6A9	250820 & Up	18-3067	—	—	—	18-3427
20C(EL)	6A9	550694 & Up	18-3067	—	—	—	18-3427
25C(M)	695	000101-014870	18-3067	18-3436	—	—	18-3426
25C(ML)	695	000000-312185	18-3067	18-3436	—	—	18-3426
25C(E)	695	000000-252290	18-3067	18-3436	—	—	18-3426
25C(EL)	695	000000-553575	18-3067	18-3436	—	—	18-3426
25C(M)	695	014871 & Up	18-3067	—	—	—	18-3427
25C(ML)	695	312186 & Up	18-3067	—	—	—	18-3427
25C(E)	695	252291 & Up	18-3067	—	—	—	18-3427
25C(EL)	695	553576 & Up	18-3067	—	—	—	18-3427
28	664	All	18-3067	—	—	—	—
30	689	All	18-3067	—	—	—	—
30A(M)	689	000366-014805	18-3067	18-3436	—	—	18-3426
30A(ML)	689	301911-315315	18-3067	18-3436	—	—	18-3426
30A(E)	689	100251-103275	18-3067	18-3436	—	—	18-3426
30A(EL)	689	401216-407815	18-3067	18-3436	—	—	18-3426
30A(M)	689	022059 & Up	18-3067	—	—	—	18-3427
30A(ML)	689	321377 & Up	18-3067	—	—	—	18-3427
30A(E)	689	105325 & Up	18-3067	—	—	—	18-3427
30A(EL)	689	411947 & Up	18-3067	—	—	—	18-3427
48/48W	670	All	18-3069	18-3436	18-3435	18-3425	—
55/W55	663	All	18-3069	18-3436	18-3435	18-3425	—
60	675,6F0	All	18-3069	18-3436	18-3435	18-3425	—

MERCURY COOLING SYSTEM APPLICATION

Horsepower	Beginning Serial #	Ending Serial #	Impeller	Impeller Plate	Insert Cup	Upper Housing	Base	Impeller Repair Kit	Thermostat	Upper Kit	Complete Kit
3.3 (with shift)	D901217	& UP	18-3098								
3.5	358136	6202172	18-3012								
3.5	6202173	& UP	18-3054								
3.6	5404657	& UP	18-3054								
3.9	1655013	2498135	18-3012	18-3139							
4 (1 cyl.)	2498136	4107219	18-3039	18-3139				18-3239			
4 (2 cyl.)	5589202	& UP	18-3054	—							
4 (made in USA)	5595532	A809600	18-3054	18-3139							
4 (made in USA)	5595532	& UP	18-3039	18-3139		18-3446		18-3239			18-3446
4 (1 cyl.)	A809601	& UP	18-3098							—	
4.5	4107220	5595531	18-3039	18-3139				18-3239			18-3446
4.5	5595532	& UP	18-3054	18-3139							
4.5	5595532	& UP	18-3039	18-3139				18-3239			18-3446
5	574128	786612	18-3012								
5 (1 cyl.)	A809601	& UP	18-3098								
5 4-STROKE	R000001	& UP	18-3098								
6	888005	1916138	18-3012								
6	1916139	2193817	18-3039	18-3139				18-3239			
6	A197112	OT800749	18-3062								
6	1582403	1916138	18-3039				18-3447				
6	1916139	2193817	18-3039				18-3447				
6	2193818	2529894	18-3039				18-3447				
6	2385673	2387383	18-3039								
7.5	2529895	4131609	18-3039	18-3139			18-3447				18-3447
7.5	4131610	5226934	18-3039	18-3139				18-3239			18-3446
7.5	5206550	& UP	18-3054								
7.5	5206550	& UP	18-3039	18-3139				18-3239			18-3446

- 1 Models with aluminum upper pump housings
- 2 Models with aluminum water pumps
- 3 Models with plastic upper pump housings
- 4 Models with plastic water pumps
- 5 Pump screws without insulators
- 6 Pump screws with insulators
- 7 Models with driveshaft retaining nut
- 8 Models without driveshaft retaining nut
- 9 Models with flush hole
- 10 Models without flush hole
- 11 Models having plastic upper housing use #48752 inset cup
- 12 Units already having a complete pump replacement using 46-46893A 6 should use the 2193818-2529894 serial group for components
- 13 Units already having a complete pump replacement using 46-46893A 6 should use USA 3795658-4126549 serial group for components
- 14 Units which have already had a complete pump replacement with the 46-46893A 6 pump should use the "Early Mariner Impellers" chart for components

MERCURY COOLING SYSTEM APPLICATION

Horsepower	Beginning Serial #	Ending Serial #	Impeller	Impeller Plate	Insert Cup	Upper Housing	Base	Impeller Repair Kit	Thermostat	Upper Kit	Complete Kit
8	A197112	& UP	18-3062								
8 (4-stroke Bodensee)	G760300	& UP	18-3062								
110 (9.8)	1865779	2196388	18-3039				18-3447				
110 (9.8)	2196389	3795657	18-3039								
110 (9.8)	3795658	4126459	18-3039				18-3447				
110 (9.8) 3	4126460	5206549	18-3039	18-3139				18-3239			
110	5206550	& UP	18-3054								—
9.8	5206550	& UP	18-3039	18-3139				18-3239	18-3553		18-3446
9.9	A197112	& UP	18-3062								
9.9 (4 Stroke) STANDARD CASE	G760300	T979999	18-3062								
XR10 SeaPro	D038000	& UP	18-3062						18-3549		
10	500022	1057993	18-3008								
15	B292414	& UP	18-3062						18-3549		
15 SeaPro	G044365	& UP	18-3062								
16	700000	& UP	18-3008								
18	5837437	& UP	18-3057								
20	860970	1292909	18-3008								
20	2827677	6443972	18-3052					18-3252			18-3448
20	6443973	T800749	18-3057					18-3215			
22	1158546	1238089	18-3008								
25,25XD,25 Sea Pro	5705532	& UP	18-3057					18-3215			
25 (3 cyl.)	E268781	& UP	18-3057					18-3215			
30	950250	1260724	18-3008					—			
30	1271884	1448139	18-3007	18-3107				18-3207		18-3507	—
30 Jet	C159200	G589999	18-3007	18-3107	18-3115	18-3118	18-3424	18-3207		18-3507	18-3324
30 Jet	G590000	& UP	18-3057								
30 (2 cyl)	G053314	T598999	18-3057								
35	1217222	1448139	18-3007	—			—	—		—	—
35	1571114	1960826	18-3007	18-3107				18-3207		18-3507	—
35	1960827	2453068	18-3007	18-3107				18-3207		18-3507	—
35	6445653	& UP	18-3007	18-3107	18-3115	18-3118	18-3424	18-3207		18-3507	18-3324
40	941751	1224480	18-3008	—	—	—	—	—		—	—
40	1224481	1476509	18-3007	—	—	—	—	—		—	—
40	2874704	4362214	18-3007	18-3107	18-3115	18-3118	18-3422	18-3207		18-3507	18-3322
40 (2 cyl) thru 1983	4860103	& UP	18-3057	18-3107	18-3115	18-3118	18-3424	18-3207		18-3507	18-3324
40 (3 cyl)	G531301	& UP	18-3057	—	—	—	—	—		—	18-3507
40 (4 cyl)	C159200	& UP	18-3007	18-3107	18-3115	18-3118	18-3424	18-3207			
40 (4-stroke) 2:1 ratio	G760300	T408999	18-3057								
40 (EFI 4-stroke) 1.83:1 ratio	T409000	& UP	18-8900				18-3445				
40 (EFI 4-stroke) 2.31:1 ratio	T409000	B344398	18-3056					18-3214			
40 (4-stroke, 4 cyl.) 2.31:1 ratio	T228405	T598999	18-3056					18-3214			
40 (4-stroke,Std)	G231123	T178499	18-3057								
40 4-stroke Carb BIG FOOT	C033811	& UP	18-3056								
40	1279685	1476509	18-3007								18-3507
45	5531630	& UP	18-3007	18-3107	18-3115	18-3118	18-3424	18-3207			
45 Jet (3 cyl)	D000750	& UP	18-8900								
45 (4-stroke, std) Bodensee	G231123	& UP	18-3057								
45 (4-stroke, bigfoot) Bodensee	G231123	& UP	18-3056					18-3214			
50	1421113	1460498	18-3007								18-3507
50	1477910	1521913	18-3007								
50	1521914	2305100	18-3007	18-3107				18-3207			18-3507
50 aluminum w/p	2305101	2478119	18-3007								
50 plastic w/p	2305101	2478119	18-3007								
500	2514919	4357639	18-3007	18-3107	18-3115	18-3118	18-3422	18-3207			18-3507
50 (4cyl)	4357640	5531629	18-3007	18-3107	18-3115	18-3118	18-3423	18-3207			18-3507
50 (4cyl)	5531630	& UP	18-3007			18-3118					
50 (4 cyl)	4962056	& UP	18-3007	18-3107	18-3115	18-3118	18-3424	18-3207			18-3507
50 (3 cyl)	6428681	D000749	18-3007	18-3107	18-3115	18-3118	18-3424	18-3207			
50 (3 cyl)	D000750	G589999	18-8900				18-3445		18-3553		
50 (3 cyl)	G590000	& UP	18-3057								
50 (4-stroke,Std)	G231123	T178499	18-3057								
50 (4-stroke, 4 cyl.) STANDARD	T178500	T598999	18-8900				18-3445				
50 (4-stroke, 4 cyl.) BIG FOOT	T178500	& UP	18-3056			18-3572		18-3214			
50 (EFI 4-stroke) STANDARD	T409000	B344398	18-8900				18-3445				
50 (EFI 4-stroke) BIG FOOT	T409000	B344398	18-3056					18-3214			
55 (3 cyl)	D000750	& UP	18-8900				18-3445				
60	6428681	D000749	18-3007	18-3107	18-3115	18-3118	18-3424	18-3207			18-3324
60 (3cyl) standard	D000750	& UP	18-3056	18-3122				18-3214	18-3553		
60 Marathon	D000750	& UP	18-3056	18-3122				18-3214			
60 Big Foot	D000750	& UP	18-3056	18-3122				18-3214	18-3553		
60 (3 cyl)	D000750	& UP	18-8900						18-3553		
60 4-STROKE STANDARD	OT178500	T598999	18-8900				18-3445	18-3214			
60 4-STROKE, BIG FOOT	OT178500	T598999	18-3056					18-3214			
60 4-STROKE EFI BIG FOOT	T409000	B344398	18-3056								

1 Models with aluminum upper pump housings
 2 Models with aluminum water pumps
 3 Models with plastic upper pump housings
 4 Models with plastic water pumps
 5 Pump screws without insulators
 6 Pump screws with insulators
 7 Models with driveshaft retaining nut

8 Models without driveshaft retaining nut
 9 Models with flush hole
 10 Models without flush hole
 11 Models having plastic upper housing use #48752 inset cup
 12 Units already having a complete pump replacement using 46-46893A 6 should use the 2193318-2529894 serial group for components
 13 Units already having a complete pump replacement using 46-46893A 6 should use USA 3795658-4126549 serial group for components
 14 Units which have already had a complete pump replacement with the 46-46893A 6 pump should use the "Early Mariner Impellers" chart for components

MERCURY COOLING SYSTEM APPLICATION

Horsepower	Beginning Serial #	Ending Serial #	Impeller	Impeller Plate	Insert Cup	Upper Housing	Base	Impeller Repair Kit	Thermostat	Upper Kit	Complete Kit
65(4 cyl) aluminum w/p	1542745	280351	18-3017	18-3117	18-3114			18-3217		18-3317	18-3507
65 (4cyl) plastic w/p	1542745	280351	18-3017			18-3116				18-3317	
65 (4cyl)	2803562	2874263	18-3017			18-3116				18-3317	
65 (4cyl)	2997439	3293183	18-3017			18-3116				18-3317	
65(3 cyl)	3293184	4382056	18-3007	18-3107	18-3115	18-3118	18-3422	18-3207			18-3507
65(3 cyl)	4382057	4571651	18-3007	18-3107	18-3115	18-3118	18-3424	18-3207			
65 Jet	0D283222	& UP	18-3056	18-3122				18-3214			
70	1413611	1436114	18-3017	18-3117				18-3217			18-3507
70 (6cyl)	1482212	1503458	18-3017								
700 E-2 (6cyl)	1503459	1503958	18-3017								
700 EL-2 (6cyl)	1503459	1566239	18-3017								
700 E-2 (6cyl) 11	1503959	1566239	18-3017			18-3116					
700 EL-2 (6cyl) 11	1505111	1566239	18-3017			18-3116				18-3317	
70 (3 cyl)	4571652	4977156	18-3007	18-3107	18-3115	18-3118	18-3423	18-3207	18-3553		18-3507
70	4977157	6428680	18-3007	18-3107	18-3115	18-3118	18-3424	18-3207			—
70	B110054	& UP	18-3056					18-3214			18-3517
70 (3cyl) 6	A996142	C221999	18-3056			18-3572			18-3553		
70 (3cyl) 5	A996142	C221999	18-3056			18-3572			18-3553		
75 (4 cyl)	6432901	& UP	18-3017	18-3117	18-3114	18-3116	18-3414	18-3217		18-3317	
75 (3 cyl)	A996142	C221999	18-3056					18-3214	18-3553		
75 (3 cyl)	C222000	& UP	18-3056					18-3214	18-3569		
75 (3 cyl)	C222000	& UP	18-3056	18-3122				18-3214	18-3569		
75 (3cyl) Optimax	T980000	& UP	18-3056			18-3572					
75 4-STROKE	G960500	B366822	18-3056					18-3214			
75 4-STROKE	B366823	& UP	18-3056			18-3572					
80	1355468	3493912	18-3017	18-3117				18-3217			18-3517
80 (6cyl)	1335465	1398629	18-3017								
80 (4 cyl)	4831999	6432900	18-3017	18-3117	18-3114	18-3116	18-3414	18-3217		18-3317	
80 (3 cyl) 6	A996142	C221999	18-3056					18-3214	18-3553		
80 (3 cyl) 5	A996142	C221999	18-3056			18-3572			18-3553		
80 Jet	D283222	& UP	18-3056	18-3122				18-3214			
850 E & EL (6cyl)	1460999	1567039	18-3017	18-3117				18-3217			18-3517
850 E-1, EL-1 (6cyl) 11	1566240	1766823	18-3017							18-3317	
85 (4 cyl)	4590512	& UP	18-3017	18-3117	18-3114	18-3116	18-3414	18-3217			
85 XS (4cyl)	3493913	4831998	18-3017			18-3116				18-3317	
850 XS (4cyl)	3493913	4831998	18-3017			18-3116				18-3317	
850, 850 XS (4cyl)	3493913	4590511	18-3017			18-3116				18-3317	
900 (90hp) (6 cyl) 11	1766824	1869775	18-3017	18-3117				18-3217		18-3317	18-3517
90 (6 cyl)	4845301	& UP	18-3017	18-3117	18-3114	18-3116	18-3414	18-3217		18-3317	
90 (3 cyl)	B110054	C221999	18-3056					18-3214			
90 (3 cyl)	A996142	& UP	18-3056					18-3214	18-3553		
90 (3 cyl)	A996142	& UP	18-3056	18-3122				18-3214	18-3553		
90 4-STROKE	G960500	B366822	18-3056			18-3572		18-3214			
90 4-STROKE	B366823	& UP	18-3056			18-3572		18-3214			
95	1869776	2318585	18-3017	18-3117				18-3217		18-3317	
115 (3CYL) Optimax	T801000	& UP	18-3056			18-3572					
950 (95hp) (6 cyl) 11	1869776	2318585	18-3017							18-3317	
1000(6 cyl)	1464949	1503331	18-3017	18-3117				18-3217			
1000 (6cyl)	1503332	2318585	18-3017			18-3116				18-3317	
100 (4 cyl)	B209468	& UP	18-3056					18-3214	18-3553		
100 (4 cyl)	B209468	& UP	18-3056	18-3122				18-3214	18-3553		18-3517
1000 SS (6cyl) 1	2318586	2413843	18-3017			18-3116				18-3317	
1000 SS (6cyl) 3	2318586	2413843	18-3017			18-3116				18-3317	
1000 SS E-1 1	2484633	2836018	18-3017			18-3116				18-3317	
1000 SS E-1 3	2484633	2836018	18-3017			18-3116				18-3317	
1000 BP (6cyl)	2399698	3253111	18-3017			N.L.A.					
105 Jet	0D182000	& UP	18-3017	18-3117	18-3114	18-3116	18-3419	18-3217		18-3317	
110 1	1870204	2314955	18-3017	18-3117				18-3217		18-3317	
110 3	1870204	2314955	18-3017			18-3317				18-3317	
115 (6cyl)	2836019	4112634	18-3017	18-3117				18-3217		18-3317	18-3517
115 (6cyl)	4112635	4394236	18-3017							18-3317	
115 (6 cyl)	4394237	& UP	18-3017	18-3117	18-3114	18-3116	18-3414	18-3217		18-3317	
115 (4 cyl) 6	C100000	& UP	18-3056					18-3214	18-3569		
115 (4cyl) 5	C100000	& UP	18-3056			18-3572			18-3569		
115 (4 cyl)	B209468	& UP	18-3056	18-3122				18-3214			
115 4-STROKE	T178500	B366822	18-3056					18-3214			
115 4-STROKE	B366823	& UP	18-3056			18-3572					
115 (3cyl) Optimax	T801000	& UP	18-3056			18-3572					
115 Pro XS	B751825	& UP	18-3056			18-3572					
125 (6cyl) 2	2314956	2839368	18-3017	18-3117				18-3217		18-3317	
125 (6cyl) 4	2314956	2839368	18-3017							18-3317	
125 (4 cyl) 6	D283222	& UP	18-3056						18-3569		
125 (4cyl) 5	D283222	& UP	18-3056			18-3572					
125 (3cyl) Optimax	B736885	& UP	18-3056			18-3572					

- 1 Models with aluminum upper pump housings
- 2 Models with aluminum water pumps
- 3 Models with plastic upper pump housings
- 4 Models with plastic water pumps
- 5 Pump screws without insulators
- 6 Pump screws with insulators
- 7 Models with driveshaft retaining nut

- 8 Models without driveshaft retaining nut
- 9 Models with flush hole
- 10 Models without flush hole
- 11 Models having plastic upper housing use #48752 inset cup
- 12 Units already having a complete pump replacement using 46-46893A 6 should use the 2193818-2529894 serial group for components
- 13 Units already having a complete pump replacement using 46-46893A 6 should use USA 3795658-4126549 serial group for components
- 14 Units which have already had a complete pump replacement with the 46-46893A 6 pump should use the "Early Mariner Impellers" chart for components

MERCURY COOLING SYSTEM APPLICATION

Horsepower	Beginning Serial #	Ending Serial #	Impeller	Impeller Plate	Insert Cup	Upper Housing	Base	Impeller Repair Kit	Thermostat	Upper Kit	Complete Kit
135	2839369	3293233	18-3017	18-3117				18-3217		18-3317	18-3517
V 135	904646	& UP	18-3017	18-3117	18-3114	18-3116	18-3419	18-3217			—
135 4-STROKE VERADO	B227000	& UP	18-3056			18-3572					18-3407
140	3293234	3502805	18-3017	18-3117				18-3217		18-3317	18-3517
140	4865678	& UP	18-3017	18-3117	18-3114	18-3116	18-3414	18-3217		18-3317	18-3517
140 Jet	D082000	& UP	18-3017	18-3117	18-3114	18-3116	18-3419	18-3217			—
150	3502806	4121434	18-3017	18-3117				18-3217			18-3517
150 (6cyl) 9	4121435	4865677	18-3017	18-3117	18-3114	18-3116	18-3414	18-3217		18-3317	18-3517
150 (6cyl) 10	4121435	4865677	18-3017				18-3414			18-3317	
1500 XS (6cyl)	4868648	5327662	18-3017							18-3317	
V 150	A904646	& UP	18-3017	18-3117	18-3114	18-3116	18-3419	18-3217		18-3317	18-3517
V 150	A904645	& BELOW	18-3017	18-3117	18-3114	18-3116	18-3416	18-3217			18-3517
V-135 DFI	G590000	& UP	18-3017							18-3317	
V-150 Carb 8	4868998	A904645	18-3017							18-3317	
V-150 Carb 7	4868998	A904645	18-3017							18-3317	
V-150 Carb, EFI, DFI	A904646	& UP	18-3017							18-3317	
V-150XR2,4,6 - MAGNUM II, III	4868998	& UP	18-3017							18-3317	
V150XR2,4,6 - MAGNUM II, III	4868998	& UP	18-3017							18-3317	
150 4-STROKE VERADO (4cyl)	B227000	& UP	18-3056			18-3572				18-3406	18-3407
V 175	6618751	& UP	18-3017	18-3117	18-3114	18-3116	18-3419	18-3217		18-3317	18-3517
V 175	4301235	6618750	18-3017	18-3117	18-3114	18-3116	18-3416	18-3217		18-3317	18-3517
V-175 Carb, EFI, DFI	6618751	& UP	18-3017							18-3317	
175 4-STROKE VERADO (4cyl)	B227000	& UP	18-3056			18-3572				18-3406	18-3407
V 200	6625221	& UP	18-3017	18-3117	18-3114	18-3116	18-3419	18-3217		18-3317	18-3517
V-200 8	4839034	6625220	18-3017	18-3117	18-3114	18-3116	18-3416	18-3217		18-3317	—
V-200 7	4839034	6625220	18-3017							18-3317	
V-200 DFI (3.0L)	G386496	G589999	18-3056					18-3214			18-3517
V-200 EFI (3.0L)	T750164	B504988	18-3056								
V-200 Carb, & EFI (2.5L)	6625221	& UP	18-3017							18-3317	
V-200 DFI (3.0L)	G590000	T598999	18-3056			18-3572					
V-200 DFI (3.0L)	T590000	B504988	18-3056			18-3572					
V-200 DFI (3.0L)	B504989	& UP	18-3056			18-3572					18-3407
200 4-STROKE VERADO (4cyl)	B517159	& UP	18-3056			18-3572				18-3406	18-3407
200 4-STROKE 4.8 INCH TORPEDO	T980000	& UP	18-3056			18-3572				18-3406	18-3407
V 220 LASER	B117316	& UP	18-3017	18-3117	18-3114	18-3116	18-3419	18-3217			18-3517
V-225 (2.4L) 8	5628028	& UP	18-3017								
V-225 (2.4L) 7	5628028	& UP	18-3017								
V-225 (3.0L) CARB & EFI	D280813	G760299	18-3056								
V-225 (3.0L) CARB & EFI	G760300	T408999	18-3056			18-3571					
V-225 (3.0L) EFI	T409000	B504988	18-3056			18-3571					
V-225 DFI	G590000	T598999	18-3056			18-3571					
V-225 DFI	T599000	B504988	18-3056			18-3571					
V-225 DFI	B504989	& UP	18-3056			18-3571					18-3407
V-225 Pro XS	B104549	B752546	18-3056			18-3571					
V-225 Pro XS	B752547	& UP	18-3056			18-3571					18-3407
225 4-STROKE VERADO 4.8 INCH TORPEDO	T980000	& UP	18-3056			18-3572					18-3407
V-250 (3.0L) EFI	G129222	T408999	18-3056			18-3571					
V-250 (3.0L) EFI	T409000	B504988	18-3056			18-3572					
V-250 DFI	B528615	& UP	18-3056			18-3572					18-3407
V-250 Pro XS	B426561	B752546	18-3056			18-3571					
V-250 Pro XS	B752547	& UP	18-3056			18-3572					18-3407
250 4-STROKE VERADO 4.8 INCH TORPEDO	T980000	& UP	18-3056			18-3572					18-3407
275 4-STROKE VERADO 4.8 INCH TORPEDO	T980000	& UP	18-3056			18-3572					18-3407
300 4-STROKE VERADO 4.8 INCH TORPEDO	B517434	& UP	18-3056			18-3572					18-3407
MARK 5	574128	786612	18-3012								
MARK 6, 6A	888005	& UP	18-3012								
MARK 50	ALL	& UP	18-3007								
MARK 55	831021	& UP	18-3007								
MARK 55A	1227131	& UP	18-3007								
MARK 58 E, MARK 58A (M&E)	1139538	& UP	18-3007								
9	OG129222	& UP	18-3056	18-3117	18-3114	18-3116	18-3419	18-3214			18-3517
XR4/Magnum II	ALL		18-3017					18-3217			

1 Models with aluminum upper pump housings
2 Models with aluminum water pumps
3 Models with plastic upper pump housings
4 Models with plastic water pumps
5 Pump screws without insulators
6 Pump screws with insulators
7 Models with driveshaft retaining nut
8 Models without driveshaft retaining nut
9 Models with flush hole
10 Models without flush hole
11 Models having plastic upper housing use #48752 inset cup
12 Units already having a complete pump replacement using 46-46893A 6 should use the 2193818-2529894 serial group for components
13 Units already having a complete pump replacement using 46-46893A 6 should use USA 3795658-4126549 serial group for components
14 Units which have already had a complete pump replacement with the 46-46893A 6 pump should use the "Early Mariner Impellers" chart for components

ALL PISTONS ARE SUPPLIED COMPLETE WITH PISTON RINGS, WRIST PIN AND CIRCLIPS.



Mariner (Japanese Models)

Sierra Piston Kit Contents (See Application Charts for Specific Applications)

Model / HP	Cyl.	Bore size	Piston	OEM Part #	Piston Ring	OEM Part #
9.9 / 15	2	std	18-4135	761-7982M, 761-7982T	18-3976	39-15320M
48	2	std	18-4138	761-8484M	—	—

MARINER PISTON AND RINGS APPLICATION — JAPANESE MODELS

Model	Ser # Code	Ser #	Standard Piston	.25mm Piston	.50mm Piston	Standard Rings	.25mm Rings	.50mm Rings	Qty. Req'd
9.9	682	ALL	18-4135	—	—	18-3976	—	—	2
15C	684	ALL	18-4135	—	—	18-3976	—	—	2
30A	689	ALL	18-4138	—	—	—	—	—	2

Mercury / Mariner

Sierra Piston Kit Contents (See Application Charts for Specific Applications)

Model / HP	Cyl.	Bore size	Piston	OEM Part #	Piston Ring	OEM Part #	Circlips	OEM Part #
2 Ring Pistons - High Dome								
35-140	2-6	2.875 / Std.	—	774-9137A12	18-3918	39-817096A6	18-4294	40-52035
35-140	2-6	2.890 / .015	—	774-9137A13	18-3919	39-817096A16	18-4294	40-52035
35-140	2-6	2.905 / .030	18-4535	774-9137A14	18-3920	39-817096A26	18-4294	40-52035
2 Ring Pistons - Low Dome								
35-140	2-6	2.875 / Std.	—	774-9137A9	18-3918	39-817096A6	18-4294	40-52035
35-140	2-6	2.890 / .015	—	774-9137A10	18-3919	39-817096A16	18-4294	40-52035
35-140	2-6	2.905 / .030	—	774-9137A11	18-3920	39-817096A26	18-4294	40-52035
3 Ring Pistons - High Dome								
35-140	2-6	2.875 / Std.	①—	776-8896A3	①18-3902	39-78816A12	18-4294	40-52035
35-140	2-6	2.890 / .015	—	776-8897A2	18-3916	39-78811A12	18-4294	40-52035
35-140	2-6	2.905 / .030	①18-4535	776-8898A2	①18-3917	39-88392A12	18-4294	40-52035
3 Ring Pistons - Low Dome								
35-140	2-6	2.875 / Std.	—	776-8600A9	②18-3902	39-78816A12	18-4294	40-52035
35-140	2-6	2.890 / .015	—	776-9095A1	②18-3916	39-78811A12	18-4294	40-52035
35-140	2-6	2.905 / .030	—	776-9096A1	18-3917	39-88392A12	18-4294	40-52035
2 Ring Pistons - Crossflow								
40-50	4	2.565 / Std.	18-4620	780-9229A7	18-3966	39-18653A12	18-4294	40-52035
40-50	4	2.580 / .015	18-4621	780-9229A10	18-3967	39-18653A1	18-4294	40-52035
40-50	4	2.595 / .030	18-4622	780-9229A11	18-3968	39-18653A2	18-4294	40-52035
50-60	3	2.875 / Std.	—	783-9613A1	18-4019	39-19721A6	18-4294	40-52035
50-60	3	2.890 / .015	18-4017	783-9613A2	—	39-19721A1	18-4294	40-52035
50-60	3	2.905 / .030	18-4018	783-9613A3	—	39-19721A2	18-4294	40-52035
70-115	3-4	3.375 / Std.	18-4623	777-815965T4	18-3979	39-96170A12	18-4294	40-52035
70-115	3-4	3.390 / .015	18-4624	777-815965A5	—	39-96170A3	18-4294	40-52035
70-115	3-4	3.405 / .030	18-4625	777-815965A6	—	39-96170A4	18-4294	40-52035
75-125	3-4	3.375 / Std.	18-4626	2704-826191T4	18-3982	39-822321A12	18-4294	40-52035
75-125	3-4	3.390 / .015	18-4627	2704-821896A3	—	39-822321A1	18-4294	40-52035
75-125	3-4	3.405 / .030	18-4628	2704-821896A4	—	39-822321A2	18-4294	40-52035

3 RING INLINE PISTON AND RINGS APPLICATION - REFERENCE ONLY ③

H.P.	Cyl.	Beginning Serial No.	Ending Serial No.	Std. Cyl. Dia. (Bore)	Std. Piston	.015 O.S. Piston	.030 O.S. Piston	Std. Rings	.015 O.S. Rings	.030 O.S. Rings
3.5	1	6202173	& UP	2	—	—	—	—	—	—
3.6	1	5404657	& UP	2	—	—	—	—	—	—
3.9	1	1655013	2498135	2	—	—	—	—	—	—
4 (1CYL)	1	2498136	A809600	2	—	—	—	—	—	—
4.5	1	4107220	& UP	2	—	—	—	—	—	—
7.5	2	2529895	& UP	2	—	—	—	—	—	—
9.8	2	1470349	& UP	2	—	—	—	—	—	—
20	2	1922910	5942040	2.562	—	—	—	18-3903	—	—
25	2	1467499	149931	2.562	—	—	—	18-3903	—	—
30 Jet (40 HP)	4	0C159200	& UP	2.562	18-4620	18-4621	18-4622	18-3966	18-3967	18-3968

APPLICATION CONTINUED ON NEXT PAGE

① 3 ring high dome NLA, 2 ring piston are now substituted ② 3 ring low dome NLA, 2 ring piston are now substituted

③ Chart is for referencing only, pistons received will be 2 ring version

3 RING INLINE PISTON AND RINGS APPLICATION - REFERENCE ONLY ③

H.P.	Cyl.	Beginning Serial No.	Ending Serial No.	Std. Cyl. Dia. (Bore)	Std. Piston	.015 O.S. Piston	.030 O.S. Piston	Std. Rings	.015 O.S. Rings	.030 O.S. Rings
30 Jet (40 HP)	4	OC159200	& UP	2.562	18-4620	18-4621	18-4622	18-3966	18-3967	18-3968
35	2	6445653	& UP	2.875	—	18-4520	18-4535	18-3918	18-3916	18-3920
40 (4 cyl)	4	1279085	1476509	2.562	—	—	—	18-3903	—	—
40	2	2045260	C159199	2.875	—	18-4520	18-4535	18-3918	18-3916	18-3920
40, 402	2	3336258	6445652	2.875	—	18-4520	18-4535	18-3918	18-3916	18-3920
40	4	OC159200	& UP	2.562	18-4620	18-4621	18-4622	18-3966	18-3967	18-3968
45	4	1476510	& UP	2.562	18-4620	18-4621	18-4622	18-3966	18-3967	18-3968
45	4	5531630	OB110788	2.562	18-4620	18-4621	18-4622	18-3966	18-3967	18-3968
45	4	OB110789	& UP	2.562	18-4620	18-4621	18-4622	18-3966	18-3967	18-3968
45 JET	3	D000750	G589999	2.955	—	18-4017	18-4018	18-4019	—	—
50,500	4	2116318	6428680	2.562	18-4620	18-4621	18-4622	18-3966	18-3967	18-3968
50	3	6428681	B122929	2.875	18-4500	18-4515	18-4530	18-3918	18-3916	18-3920
50	3	B122930	D000749	2.875	18-4500	18-4515	18-4530	18-3918	18-3916	18-3920
50	3	D000750	G589999	2.955	—	18-4017	18-4018	18-4019	—	—
55	3	6428681	OB122929	2.875	18-4500	18-4515	18-4530	18-3918	18-3916	18-3920
55	3	B122930	D000749	2.875	18-4500	18-4515	18-4530	18-3918	18-3916	18-3920
55	3	D000750	G589999	2.955	—	18-4017	18-4018	18-4019	—	—
60	6	1303411	1542744	2.562	—	—	—	18-3903	—	—
60	3	6428681	B122929	2.875	—	18-4520	18-4535	18-3918	18-3916	18-3920
60	3	B122930	D000749	2.875	—	18-4520	18-4535	18-3918	18-3916	18-3920
60	3	D000750	G589999	2.955	—	18-4017	18-4018	18-4019	—	—
65,650	3	3293184	4382056	2.875	—	18-4520	18-4535	18-3918	18-3916	18-3920
65,650	3	4382057	4571651	2.875	—	18-4520	18-4535	18-3918	18-3916	18-3920
70	3	4571652	A996141	2.875	—	18-4520	18-4535	18-3918	18-3916	18-3920
70 (3 cyl.) w/Rod #646-8188461	3	A996142	& UP	3.375	18-4623	18-4624	18-4625	18-3979	—	—
75	4	6432901	& UP	2.875	—	18-4520	18-4535	18-3918	18-3916	18-3920
75 (3 cyl) w/Rod #646-818846	3	C222000	D283221	3.375	18-4623	18-4624	18-4625	18-3979	—	—
75 (3 cyl.)	3	D283222	& UP	3.5	18-4626	18-4627	18-4628	18-3982	—	—
80,800	4	2559001	3493912	2.875	—	18-4520	18-4535	18-3918	18-3916	18-3920
80,800	4	4831999	6432900	2.875	—	18-4520	18-4535	18-3918	18-3916	18-3920
80 Jet	3	D283222	& UP	3.5	18-4626	18-4627	18-4628	18-3982	—	—
85,850	4	3493913	4831998	2.875	—	18-4520	18-4535	18-3918	18-3916	18-3920
85,850	4	4366802	4831998	2.875	—	18-4520	18-4535	18-3918	18-3916	18-3920
85 Mar.	4	4731898	4842728	2.875	—	18-4520	18-4535	18-3918	18-3916	18-3920
90,900	6	4845301	& UP	2.875	—	18-4520	18-4535	18-3918	18-3916	18-3920
90 (3 cyl) w/Rod #646-818846	3	A9964142	D283221	3.375	18-4623	18-4624	18-4625	18-3979	—	—
90 (3 cyl.)	3	D283222	& UP	3.5	18-4626	18-4627	18-4628	18-3982	—	—
95	6	1869776	2318585	2.875	—	—	—	18-3918	18-3916	18-3920
100 SS	6	2318586	2836018	2.875	—	—	—	18-3918	18-3916	18-3920
100 BP	6	2399698	3253111	2.875	—	—	—	18-3918	18-3916	18-3920
100 (4 cyl) w/Rod #646-818846	4	B209468	D283221	3.375	18-4623	18-4624	18-4625	18-3979	—	—
100 (4cyl)	4	D283222	& UP	3.5	18-4626	18-4627	18-4628	18-3982	—	—
115 1150	6	2836019	5829643	2.875	—	18-4520	18-4535	18-3918	18-3916	18-3920
115 Merc.	6	5829644	B209467	2.875	18-4500	18-4515	18-4530	18-3918	18-3916	18-3920
115 Mar.	6	5738891	5861526	2.875	—	18-4520	18-4535	18-3918	18-3916	18-3920
115 Mar.	6	5861527	C100000	2.875	18-4500	18-4515	18-4530	18-3918	18-3916	18-3920
115 (4 cyl) w/Rod #646-818846	4	C100000	D283221	3.375	18-4623	18-4624	18-4625	18-3979	—	—
115 (4cyl)	4	D283222	& UP	3.5	18-4626	18-4627	18-4628	18-3982	—	—
125 BP	6	2641855	3253111	2.875	—	18-4520	18-4535	18-3918	18-3916	18-3920
135	6	2839369	3293233	2.875	—	18-4520	18-4535	18-3918	18-3916	18-3920
140 1400	6	3293234	3502805	2.875	—	18-4520	18-4535	18-3918	18-3916	18-3920
140 1400	6	4865678	& UP	2.875	18-4500	18-4515	18-4530	18-3918	18-3916	18-3920
150 1500	6	3502806	5327622	2.875	18-4500	18-4515	18-4530	18-3918	18-3916	18-3920

2 RING INLINE PISTON & RINGS APPLICATION

H.P.	Cyl.	Beginning Serial No.	Ending Serial No.	Dia. (Bore)	Pistons					Piston Rings			
					Std. (Port)	Stbd.	.015" O.S.	Stbd.	.030" O.S.	Std.	.015" O.S.	.030" O.S.	
105 JET	V-6	D082000	& UP	3.125	—	—	—	18-4013	—	—	18-3921	18-3922	18-3923
V-135	V-6	A904646	C239552	3.125	—	—	—	18-4560	18-4540	—	18-3921	18-3922	18-3923
V-135	V-6	C239553	G960499	3.125	—	—	—	18-4013	—	—	18-3921	18-3922	18-3923
(w/ rod 644-8141)													
V-135 (2.5L)	V-6	C239553	G960499	3.125	—	—	—	—	18-4540	—	18-3921	18-3922	18-3923
(w/o rod 636-818141)													
V-140 JET	V-6	D082000	G960499	3.5	18-4635	18-4636	18-4637	18-4638	NA	NA	18-3982	—	—
V-140 JET	V-6	G960500	UP	3.5	18-4635	18-4636	18-4637	18-4638	NA	NA	18-3982	—	—
V-150 MAR	V-6	5600162	6038680	3.125	—	—	—	—	18-4540	—	18-3921	18-3922	18-3923
V-150 MAR	V-6	6038681	C239552	3.125	—	—	—	—	18-4540	—	18-3921	18-3922	18-3923
V-150,	V-6	4868998	6042945	3.125	—	—	—	—	18-4540	—	18-3921	18-3922	18-3923
1,501,500													
V-150	V-6	6042946	C239552	3.125	—	—	—	—	18-4540	—	18-3921	18-3922	18-3923

APPLICATION CONTINUED ON NEXT PAGE

③ Chart is for referencing only, pistons received will be 2 ring version

2 RING INLINE PISTON & RINGS APPLICATION





H.P.	Cyl.	Beginning Serial No.	Ending Serial No.	Dia. (Bore)	Pistons						Piston Rings		
					Std. (Port)	Stbd.	.015" O.S.	Stbd.	.030" O.S.	Stbd.	Std.	.015" O.S.	.030" O.S.
V-150 (w/ rod) 644-8141)	V-6	C239553	G960499	3.125	—	—	—	18-4013	—	—	18-3921	18-3922	18-3923
V-150 (2.5L) (w/o rod) 636-818141)	V-6	C239553	G960499	3.125	—	—	—	18-4560	18-4540	18-4575	18-3921	18-3922	18-3923
V-150 EFI XR6 MAGIII	V-6	D082000	G960499	3.5	18-4635	18-4636	18-4637	18-4638	NA	NA	18-3982	—	—
V-150 XR4 MAGIII	V-6	B242885	C239552	3.375	—	—	—	18-4570	—	—	18-3924	18-3925	—
V-150 XR4 MAGIII	V-6	C239553	D081999	3.375	—	—	—	—	—	—	18-3924	18-3925	—
V-175,175,1750	V-6	4301235	6618750	3.125	—	—	—	18-4560	18-4540	18-4575	18-3921	18-3922	18-3923
V-175	V-6	6618751	C239552	3.375	—	—	—	—	—	—	18-3927	—	—
V-175	V-6	C239553	D081999	3.375	—	—	—	—	—	—	18-3924	18-3925	—
V-175	V-6	D082000	G960499	3.5	18-4635	18-4636	18-4637	18-4638	NA	NA	18-3982	—	—
V-175	V-6	G960500	& UP	3.5	18-4635	18-4636	18-4637	18-4638	NA	NA	18-3982	—	—
V-175 I XRI EF	V-6	D000750	D081999	3.5	18-4635	18-4636	18-4637	18-4638	NA	NA	18-3982	—	—
V-175	V-6	D000750	D081999	3.5	18-4635	18-4636	18-4637	18-4638	NA	NA	18-3982	—	—
V-175 XRI EFI	V-6	D082000	G303045	3.5	18-4635	18-4636	18-4637	18-4638	NA	NA	18-3982	—	—
V-175 XRI EFI	V-6	G303046	& UP	3.5	18-4635	18-4636	18-4637	18-4638	NA	NA	18-3982	—	—
V-200, 2,002.000	V-6	4839034	6203990	3.375	—	—	—	—	—	—	18-3927	—	—
V-200 (2.4L)	V-6	6203991	C291519	3.375	—	—	—	—	—	—	18-3927	—	—
V-200 (2.5L) w/ rod	V-6	C291520	D081999	3.5	18-4635	18-4636	18-4637	18-4638	NA	NA	18-3982	—	—
#644-818141)													
V-200 (2.5L)	V-6	D082000	& UP	3.5	18-4635	18-4636	18-4637	18-4638	NA	NA	18-3982	—	—
V-200 XRI EFI	V-6	C100861	C291519	3.375	—	—	—	—	—	—	18-3927	—	—
V-200 XRI EFI	V-6	C291520	G960499	3.375	18-4635	18-4636	18-4637	18-4638	NA	NA	18-3982	—	—
V-220	V-6	B117316	UP	3.375	—	—	—	—	—	—	18-3927	—	—
V-225	V-6	5628028	D280812	3.375	—	—	—	—	—	—	18-3927	—	—
V-225 (3.0L)	V-6	D280813	UP	3.625	—	—	—	—	—	—	18-4050	—	—

Sierra V-6 Piston Kit Contents (See Application Charts for Specific Applications)

Model / HP	Cyl.	Bore size	Piston	OEM Part #	Piston Ring	OEM Part #	Wrist Pin	Circlips
135, 150 2 Liter	V-6	3.125 / Std. (port)	—	765-7442T32	18-3921	39-93481A12	—	N.S.S.
135, 150 2 Liter	V-6	3.125 / Std. (stbd)	—	765-7441T32	18-3921	39-93481A12	—	N.S.S.
135, 150 2 Liter	V-6	3.140 / .015 (port)	—	765-7444A11	18-3922	39-78918A4	—	N.S.S.
135, 150 2 Liter	V-6	3.140 / .015 (stbd)	18-4013	765-7443A11	18-3922	39-78918A4	—	N.S.S.
135, 150 2 Liter	V-6	3.155 / .030 (port)	—	765-7446A11	18-3923	39-85636A4	—	N.S.S.
135, 150 2 Liter	V-6	3.155 / .030 (stbd)	—	765-7445T11	18-3923	39-85636A4	—	N.S.S.
135-175	V-6	3.125 / Std. (port)	—	765-7442A3, A36	18-3921	39-93481A12	—	N.S.S.
135-175	V-6	3.125 / Std. (stbd)	18-4545	765-7441A3, A36	18-3921	39-93481A12	—	N.S.S.
135-175	V-6	3.140 / .015 (port)	—	765-7442A2, A12	18-3922	39-78918A4	—	N.S.S.
135-175	V-6	3.140 / .015 (stbd)	18-4560	765-7443A2, A12	18-3922	39-78918A4	—	N.S.S.
135-175	V-6	3.155 / .030 (port)	18-4540	N/A	18-3923 ④	39-85636A4	—	N.S.S.
135-175	V-6	3.155 / .030 (stbd)	18-4575	N/A	18-3923 ④	39-85636A4	—	N.S.S.
175-225	V-6	3.375 / Std. (port)	—	766-8667A41/ T41	18-3927	39-813011A12	—	N.S.S.
175-225	V-6	3.375 / Std. (stbd)	—	766-8666A41/ T41	18-3927	39-813011A12	—	N.S.S.
175-225	V-6	3.390 / .015 (port)	—	766-8667A36/ A43	18-3925	39-815267A4	—	N.S.S.
175-225	V-6	3.390 / .015 (stbd)	—	766-8666A36/ A43	18-3925	39-815267A4	—	N.S.S.
175-225	V-6	3.405 / .030 (port)	—	NLA	—	NLA	—	N.S.S.
150 XR4/MAG II	V-6	3.375 / Std. (port)	—	766-8667A42/ T42	18-3924	39-18487A12	—	N.S.S.
150 XR4/MAG II	V-6	3.375 / Std. (stbd)	—	766-8666A42/ T42	18-3924	39-18487A12	—	N.S.S.
150 XR4/MAG II	V-6	3.390 / .015 (port)	—	766-8667A36/ A43	18-3925	39-815267A4	—	N.S.S.
150 XR4/MAG II	V-6	3.390 / .015 (stbd)	—	766-8666A36/ A43	18-3925	39-815267A4	—	N.S.S.
150 XR4/MAG II	V-6	3.405 / .030 (port)	—	NLA	—	NLA	—	N.S.S.
140-200, XR6/MAG III	V-6	3.500 / Std. (port)	18-4635	785-9737T9	18-3982	39-822321A12	—	N.S.S.
140-200, XR6/MAG III	V-6	3.500 / Std. (stbd)	18-4636	785-9738T9	18-3982	39-822321A12	—	N.S.S.
140-200, XR6/MAG III	V-6	3.515 / .015 (port)	18-4637	785-9737A10	—	39-822321A1	—	N.S.S.
140-200, XR6/MAG III	V-6	3.515 / .015 (stbd)	18-4638	785-9738T10	—	39-822321A1	—	N.S.S.
225 (3.0L)	V-6	3.6265 / Std. (port)	—	700-858294T1	18-4050	39-827179A12	—	N.S.S.
225 (3.0L)	V-6	3.6265 / Std. (stbd)	—	700-858295T1	18-4050	39-827179A12	—	N.S.S.
225 (3.0L)	V-6	3.6415 / .015 (port)	—	700-878571A2	—	39-826293A12	—	N.S.S.
225 (3.0L)	V-6	3.6415 / .015 (stbd)	—	700-878572A2	—	39-826293A12	—	N.S.S.
225 (3.0L)	V-6	3.6565 / .030 (port)	—	700-878573A2	—	39-826297A12	—	N.S.S.
225 (3.0L)	V-6	3.6565 / .030 (stbd)	—	700-878574A2	—	39-826297A12	—	N.S.S.

- | | | | |
|---------------------------------|----------------------------------|---------------------------------|----------------------------------|
| 4 of — = 1 of 39-21665A12 | 3 of 18-3918 = 1 of 39-817096A6 | 2 of 18-3923 = 1 of 39-85636A4 | 6 of 18-3967 = 1 of 39-18653A1 |
| 4 of 18-3902 = 1 of 39-78816A12 | 3 of 18-3919 = 1 of 39-817096A16 | 6 of 18-3924 = 1 of 39-18487A12 | 3 of 18-4019 = 1 of 39-19721A6 |
| 4 of 18-3903 = 1 of 39-27841A12 | 3 of 18-3920 = 1 of 39-817096A26 | 2 of 18-3925 = 1 of 39-815267A4 | 6 of 18-3982 = 1 of 39-822321A12 |
| 4 of 18-3916 = 1 of 39-78811A12 | 6 of 18-3921 = 1 of 39-93481A12 | 6 of 18-3966 = 1 of 39-18653A12 | 6 of 18-4050 = 1 of 39-827179A12 |
| 4 of 18-3917 = 1 of 39-88392A12 | 2 of 18-3922 = 1 of 39-78918A4 | 6 of 18-3968 = 1 of 39-18653A2 | 6 of 18-3927 = 1 of 39-813011A12 |

④ For chrome bore blocks

 NEEDLE BEARINGS	 NEEDLE BEARINGS	 18-1186 NEEDLE BEARINGS WITH RETAINERS Replaces: 29-88258 + 12-88263 (2 pieces) For: Merc V-6 200/225/250 HP 3.0 & 3.4L	 18-1194 ROD BEARING Replaces: 31-17514A1, 8M004528 For: 30-60HP 2&3 Cyl., Mag II, V-135-200 & XR4																					
<table border="1" style="width: 100%; border-collapse: collapse;"> <thead> <tr> <th>Part #</th> <th>Replaces:</th> <th>Description</th> </tr> </thead> <tbody> <tr> <td>18-4036 ①</td> <td>29-47270</td> <td>Piston End</td> </tr> <tr> <td>18-4037 ①</td> <td>29-71422</td> <td>Main Bearing</td> </tr> </tbody> </table>	Part #	Replaces:	Description	18-4036 ①	29-47270	Piston End	18-4037 ①	29-71422	Main Bearing	<table border="1" style="width: 100%; border-collapse: collapse;"> <thead> <tr> <th>Part #</th> <th>Replaces:</th> <th>Description</th> </tr> </thead> <tbody> <tr> <td>18-4038</td> <td>31-62596A1</td> <td>Crank End-Without Cage</td> </tr> <tr> <td>18-4039</td> <td>31-17514A2</td> <td>Crank End-Without Cage</td> </tr> <tr> <td colspan="3" style="text-align: center;">16 Needles - Must re-use cage</td> </tr> </tbody> </table>	Part #	Replaces:	Description	18-4038	31-62596A1	Crank End-Without Cage	18-4039	31-17514A2	Crank End-Without Cage	16 Needles - Must re-use cage				
Part #	Replaces:	Description																						
18-4036 ①	29-47270	Piston End																						
18-4037 ①	29-71422	Main Bearing																						
Part #	Replaces:	Description																						
18-4038	31-62596A1	Crank End-Without Cage																						
18-4039	31-17514A2	Crank End-Without Cage																						
16 Needles - Must re-use cage																								



**18-1195
ROD BEARING WITH CAGE**
 Replaces: 31-43012A1
 For: 70, 75, 80, 90, 100, 115, L3, L4, 3.0L



**18-1362
SPLIT SLEEVE BEARING**
 For: 135-200 HP V-6,
 S/N A904646-C100861



**18-1153
BALL BEARING**
 Replaces: 30-63326



**18-1154
BALL BEARING**
 Replaces: 30-63742



**18-1196
UPPER MAIN BEARING**
 Replaces: 31-74248T
 For: V135, 150, 175, 200 (carb)



**18-1345
BALL BEARING**
 Replaces: 30-67923T
 For: 135-225 HP V-6



**18-1346
BALL BEARING**
 Replaces: 30-43011T
 For: 75-125 3 & 4 cyl.



**18-1398
BALL BEARING**
 Replaces: 30-72961
 For: 3.5-9.8 HP & Mercruiser
 belt driven water pump

① This product is priced per piece. To order priced per package, please add -9 to the part number.

HP	Cyl.	Beg. S/N	End S/N	Center Main Bearing	Con. Rod Crank End	Main Valve Block	Con. Rod Piston End	Lower Main Bearing	Lower O-Ring	Lower Oil Seal	Lower Oil Seal 2	Upper O-Ring	Upper Main Bearing	Upper Oil Seal	Upper Roller Bearing
3.5		6202173	& UP	—	—	—	—	—	—	—	—	18-7152	18-1398	—	—
3.6		5404657	& UP	—	—	—	—	18-1398	—	—	—	18-7152	18-1398	—	—
3.9	1	1655013	2498135	—	—	—	—	18-1398	—	—	—	18-7152	18-1398	—	—
4 (40)	1	2498136	4107219	—	—	—	—	18-1398	—	—	—	18-7152	18-1398	—	—
4	1	5595532	& UP	—	—	—	—	18-1398	—	—	—	18-7152	18-1398	—	—
4 (40)	2	5589202	& UP	—	—	—	—	18-1398	18-7102	—	—	—	—	18-0515	—
4.5 (4.5, 45)	1	4107220	& UP	—	—	—	—	18-1398	—	—	—	18-7152	18-1398	—	—
4.5	1	5595532	& UP	—	—	—	—	18-1398	—	—	—	18-7152	18-1398	—	—
6 (60)		1916139	2529894	—	—	—	—	18-1398	—	—	—	18-7459	18-1398	—	—
6		A197112	T800749	—	—	—	—	18-1397	—	—	—	—	—	—	—
7.5 (75)		2529895	5226934	—	—	—	—	18-1398	—	—	—	18-7152	18-1398	—	—
10 (100)		1290910	& UP	—	18-4035	—	—	—	—	—	—	—	—	—	—
10 (MARATHON, XR10, SEAPRO)		D038000	& UP	—	—	—	—	18-1397	—	—	—	—	—	—	—
15 (150)		1290910	1499331	—	18-4035	—	—	—	—	18-2026	18-2026	—	18-1153	—	—
15		B292414	& UP	—	—	—	—	18-1397	—	—	—	—	—	—	—
15 (EXPORT SEAPRO)		G044365	G202749	—	—	—	—	—	—	18-0537	—	—	—	—	—
15 (SEAPRO)		G438000	& UP	—	—	—	—	18-1397	—	—	—	—	—	—	—
15 (SUPER)		B238464	G202749	—	—	—	—	—	—	18-0537	—	—	—	—	—
18		5837437	6239752	—	—	—	—	—	—	18-0537	—	—	—	—	—
20		1558310	2296266	—	18-4035	—	—	—	—	18-2026	18-2026	—	18-1153	—	—
20 (200, 20)		2296267	& UP	—	18-4035	—	—	—	—	—	—	—	—	—	—
25 (KF 9)	4	377150	495761	18-4035	18-4035	—	—	—	—	—	—	—	—	—	—
10 (MK10)	2	1057994	1122327	—	18-4035	—	—	—	—	—	—	—	—	—	—
15 (MK15)	2	1200114	1287384	—	18-4035	—	—	—	—	—	—	—	—	—	—
16 (MK20)	2	ALL	—	—	18-4035	—	—	—	—	—	—	—	—	—	—
20 (MK25)	2	860979	& UP	—	18-4035	—	—	—	—	—	—	—	—	—	—

HP	Cyl.	Beg. S/N	End S/N	Center Main Bearing	Con. Rod Crank End	Main Valve Block	Con. Rod Piston End	Lower Main Bearing	Lower O-Ring	Lower Oil Seal	Lower Oil Seal 2	Upper O-Ring	Upper Main Bearing	Upper Oil Seal	Upper Roller Bearing
22 (MK28)	2	1158546	1238089	—	18-4035	—	—	—	—	—	—	—	—	—	—
30 (MK30)	4	—	ALL	18-4035	18-4035	—	—	—	—	—	—	—	—	—	—
35 (MK35)	4	1217222	1271884	18-4035	18-4035	—	—	—	—	—	—	—	—	—	—
25 (MK40)	4	711400	& UP	18-4035	18-4035	—	—	—	—	—	—	—	—	—	—
40 (MK50)	4	—	ALL	18-4035	18-4035	—	—	—	—	—	—	—	—	—	—
40(MK55)	4	831021	& UP	18-4035	18-4035	—	—	—	—	—	—	—	—	—	—
45 (MK58)	4	1139538	& UP	18-4035	18-4035	—	—	—	—	—	—	—	—	—	—
60 (MK75)	6	—	ALL	18-4037	18-4035	—	—	—	—	—	—	—	—	—	—
70 (MK78)	6	1143038	& UP	18-4037	18-4035	—	—	—	—	—	—	—	—	—	—
3.5 / 3.6 / 3.9	1	—	ALL	—	—	—	—	18-1398	—	—	—	—	—	18-1398	—
9.8	2	1865779	& UP	—	—	—	—	18-1398	—	—	—	—	—	18-1398	—
20	2	1292910	6443972	—	18-4035	—	—	18-1153	—	—	—	—	—	18-1153	—
20 (20 XD)	2	6443973	B114230	—	—	—	—	—	—	18-0537	—	—	—	—	—
25	2	1467499	1499331	—	18-4035	—	—	—	—	—	—	—	—	—	—
25	2	5705532	6241936	—	—	—	—	—	—	18-0537	—	—	—	—	—
25 (250)	—	1290910	1499331	—	18-4035	—	—	—	—	—	—	—	—	—	—
30 (300)	4	1271885	1448139	18-4035	18-4035	—	—	18-1154	18-7151	—	18-2016	18-7151	18-1154	—	—
30 (644cc)	2	G053314	D589999	—	18-4039	—	18-4036	18-1154	18-7176	18-2016	—	—	—	—	—
30 (644cc)	2	G590000	T598999	—	18-1194	—	18-4036	—	—	—	—	—	—	—	—
30 JET	4	C159200	& UP	18-4037	18-4035	—	—	18-1154	—	—	—	—	18-1154	—	—
30 JET	3	G590000	& UP	—	—	—	18-4036	18-1154	—	—	—	—	—	—	—
35 (350, 35A)	4	121722	1448139	18-4035	18-4035	—	—	18-1154	—	—	—	—	18-1154	—	—
35 (350)	2	1571114	1898815	—	—	—	—	18-1154	18-7151	—	—	—	18-1154	—	—
35	2	6445653	B110788	—	18-4038	—	18-4036	18-1154	—	—	—	—	—	—	—
40 (400E, 400M)	4	1279685	1367697	18-4035	18-4035	—	—	18-1154	—	—	—	—	18-1154	—	—
40 (400E, 400M)	4	1384806	1476509	18-4035	18-4035	—	—	—	—	—	—	—	—	—	—
40 (400)	2	2874704	3045259	—	18-4038	—	18-4036	18-1154	18-2016	18-2016	—	—	18-2016	—	—
40 (400)	2	3045260	3336257	—	18-4038	—	18-4036	—	—	—	—	—	—	—	—
40 (402)	—	3336258	4117709	—	18-4038	—	18-4036	—	—	—	—	—	—	—	—
40 (402, 40)	—	4117710	5556229	—	18-4038	—	18-4036	—	18-2016	18-2016	—	—	18-2016	—	—
40	2	5556230	6443972	—	18-4038	—	18-4036	—	—	—	—	—	—	—	—
40	2	G053314	& UP	—	18-1194	—	18-4036	18-1154	18-2016	—	—	—	—	—	—
40	3	G531301	& UP	—	18-1194	—	18-4036	18-1154	18-2016	—	—	—	—	—	—
40	4	C159200	& UP	18-4037	18-4035	—	—	18-1154	18-7161	18-2016	—	18-7151	18-1154	—	—
45 (450)	4	1476510	1531568	18-4035	18-4035	—	—	18-1154	—	18-2016	18-7151	18-1154	18-1154	—	—
45	4	5531630	& UP	18-4037	18-4035	—	—	18-1154	18-7151	18-2016	18-7151	18-1154	18-1154	—	—
45 JET	—	D000750	D589999	—	18-4039	—	18-4036	18-1154	18-7176	18-2016	—	—	—	18-2016	—
45 JET (59 CID)	3	G590000	& UP	—	18-1194	—	18-4036	18-1154	18-7176	18-2016	—	—	—	—	—
50 (500)	4	1421113	1755548	18-4035	18-4035	—	—	18-1154	18-7151	—	18-2016	18-7151	18-1154	18-2016	—
50 (500)	—	1770179	2305100	18-4035	18-4035	—	—	—	—	—	—	—	—	—	—
50 (500, 50)	—	2305151	5193253	18-4035	18-4035	—	—	—	—	—	—	—	—	—	—
50	4	5193259	5531629	18-4037	18-4035	—	—	18-1154	—	—	—	—	18-1154	—	—
50	4	5531630	& UP	18-4037	18-4035	—	—	—	—	—	—	—	—	—	—
50	3	6428681	D000749	18-4037	18-4038	—	18-4036	—	18-7161	18-2016	18-2016	18-7415	—	18-2016	—
50	3	D000750	G589999	—	18-4039	—	18-4036	18-1154	18-7176	18-2016	—	—	—	18-2016	—
50	3	G590000	& UP	—	18-1194	—	18-4036	18-1154	18-7176	18-2016	—	—	—	—	—
55	3	D000750	G589999	—	18-4039	—	18-4036	18-1154	18-7176	18-2016	—	—	—	18-2016	—
55	3	G590000	& UP	—	18-1194	—	18-4036	18-1154	18-7176	18-2016	—	—	—	—	—
60 (600)	4	1303411	1542744	18-4037	18-4035	—	—	18-1154	18-7151	—	18-2016	18-7151	18-1154	18-2016	—
60	3	6428681	D000749	18-4037	18-4038	—	18-4036	—	18-7161	18-2016	18-2016	18-7415	—	18-2016	—
60	3	D000750	G589999	—	18-4038	—	18-4036	18-1154	18-7176	18-2016	—	—	—	18-2016	—
60 (59 CID)	3	G590000	& UP	—	18-1194	—	18-4036	18-1154	—	—	—	—	—	—	—
65 (650)	4	1545745	1765043	18-4037	—	—	—	18-1154	18-7151	—	18-2016	—	—	—	18-2016
65 (650)	4	1765044	2119748	18-4037	—	—	—	—	—	—	—	—	—	—	—
65 (650)	4	2119749	2309310	18-4034	—	—	—	—	—	—	—	—	—	—	—
65 (650)	4	2309311	3293183	18-4037	—	—	—	—	—	—	—	—	—	—	—
65 (650)	3	3293184	4571651	18-4037	18-4038	—	18-4036	—	18-7161	18-2016	18-2016	18-7961	—	18-2016	—
65 (650)	3	8006640	8042349	18-4037	18-4038	—	18-4036	—	—	—	—	—	—	—	—
65 (650)	3	9020074	9135824	18-4037	18-4038	—	18-4036	—	—	—	—	—	—	—	—
65 (650)	3	7013633	7087822	18-4037	18-4038	—	18-4036	—	—	—	—	—	—	—	—
65 JET	—	D283222	& UP	—	—	—	—	18-1346	—	18-2016	—	18-7414	—	18-0523	—
70 (700)	6	1296411	1566239	18-4037	18-4035	—	—	18-1154	18-7151	—	18-2016	18-7151	18-1154	18-2016	—
70	3	4571652	5579016	18-4037	18-4038	—	18-4036	—	18-7161	18-2016	18-2016	18-7415	—	18-2016	—
70	3	5579017	6428680	18-4037	18-4038	—	18-4036	—	—	—	—	—	—	—	—
70	3	A996142	C221999	—	—	—	—	18-1346	—	18-2016	—	18-7414	—	18-0523	—
CONNECTING ROD #638-8532-1	—	—	—	—	—	—	—	—	—	—	—	—	—	—	—
75	4	6432901	& UP	18-4037	18-4038	—	18-4036	18-1154	18-7161	18-2016	18-2016	18-7961	—	18-2016	—
75	3	C222000	& UP	—	—	—	—	18-1346	—	18-2016	—	18-7414	—	18-0523	—
CONNECTING ROD #638-8532-1	—	—	—	—	—	—	—	—	—	—	—	—	—	—	—
75 DFI (1.5L)	—	T980000	B189548	—	—	—	—	18-1346	—	18-2016	—	—	—	—	—
80 (800)	6	1335465	1566239	18-4037	—	—	—	18-1154	18-7151	—	18-2016	18-7151	18-1154	18-2016	—
80 (800)	4	2559001	2670574	18-4037	18-4038	—	18-4036	18-1154	18-2016	18-2016	18-2016	18-7961	—	18-2016	—
80 (800)	4	2783253	3493912	18-4037	18-4038	—	18-4036	—	—	—	—	—	—	—	—
80 (800, 80)	4	4831999	5582561	18-4037	18-4038	—	18-4036	18-1154	18-7161	18-2016	18-2016	18-7961	—	18-2016	—
80 (80)	4	5582562	6422900	18-4037	18-4038	—	18-4036	—	—	—	—	—	—	—	—
80	3	A996142	C221999	—	—	—	—	18-1346	—	18-2016	—	18-7414	—	18-0523	—
CONNECTING ROD #638-8532-1	—	—	—	—	—	—	—	—	—	—	—	—	—	—	—
80 JET	—	D283222	& UP	—	—	—	—	18-1346	—	18-2016	—	18-7414	—	18-0523	—
85 (850, 76 CID)	6	1460999	1464848	18-4037	—	—	—	18-1154	18-7151	—	18-2016	18-2016	—	18-2016	—
85 (850, 90 CID)	6	1566240	1766823	18-4037	—	—	—	18-1345	18-2016	—	18-2016	—	—	18-2016	—
85 (850)	4	3493913	3865694	18-4037	18-4038	—	18-4036	18-1154	18-7161	18-2016	18-2016	18-7961	—	18-2016	—
85 (850)	4	3865695	4831998	18-4037	18-4038	—	18-4036	—	—	—	—	—	—	—	—
90 (900)	6	1766824	1850448	18-4037	—	—	—	18-1154	18-2016	—	18-2016	—	—	18-2016	—
90 (900)	6	1850449	1869775	18-4037	—	—	—	—	—	—	—	—	—	—	—
90 (900, 90)	6	4845301	5594656	18-4037	18-4038	—	18-4036	18-1154	18-7161	18-2016	18-2016	—	—	18-2016	—
90 (90)	6	5594657	& UP	18-4037	18-4038	—	18-4036	—	—	—	—	—	—	—	—

HP	Cyl.	Reg. S/N	End S/N	Center Main Bearing	Con. Rod Crank End	Main Valve Block	Con. Rod Piston End	Lower Main Bearing	Lower O-Ring	Lower Oil Seal	Lower Oil Seal 2	Upper O-Ring	Upper Main Bearing	Upper Oil Seal	Upper Roller Bearing
90 (90) CONNECTING ROD #638-8532-1	3	A996142	D283221	—	—	—	—	18-1346	—	18-2016	—	18-7414	—	18-0523	—
95 (950E)	6	1869776	2318585	18-4037	—	—	—	18-1154	18-7151	—	18-2016	—	—	18-2016	—
95 (950E-SS)		1869776	2318585	18-4037	—	—	—	18-1154	18-2016	—	18-2016	—	—	18-2016	—
95 (950E-SS-1)		1869776	2318585	18-4037	—	—	—	—	—	—	—	—	—	—	—
100 (1000)	6	1464949	2318585	18-4037	—	—	—	18-1154	18-7151	—	18-2016	—	—	18-2016	—
100 (1000SS)		2318586	2836018	18-4037	—	—	—	18-1154	18-7151	—	18-2016	—	—	18-2016	—
100 (1000BP)		2399698	2641854	18-4037	—	—	—	—	—	—	—	—	—	—	—
100 (1000BP)		2641855	3253111	18-4037	18-4038	—	18-4036	18-1154	18-7151	18-2016	18-2016	18-7961	—	18-2016	—
100	4	B209468	& UP	—	—	—	—	18-1346	—	—	—	—	—	—	—
105 JET		D820000	& UP	—	18-1194	—	—	18-1345	—	—	—	—	—	—	—
110 (1100E)		1870204	2314955	18-4037	—	—	—	18-1154	18-7151	—	18-2016	—	—	18-2016	—
110 (1100-SS)	6	1870204	2314955	18-4037	—	—	—	18-1154	18-2016	—	18-2016	—	—	18-2016	—
110 (1100E-SS-1)	6	1870204	2314955	18-4037	—	—	—	—	—	—	—	—	—	—	—
115 (1150)	6	2836019	3525440	18-4037	18-4038	—	18-4036	18-1154	18-7151	18-2016	18-2016	18-7961	—	18-2016	—
115 (1150, 115)		3525441	5600966	18-4037	18-4038	—	18-4036	—	—	—	—	—	—	—	—
115	6	5600967	6262960	18-4037	18-4038	—	—	—	—	—	—	—	—	—	—
115	6	6262961	C099999	18-4037	18-4038	—	18-4036	—	—	—	—	—	—	—	—
115	4	C100000	D283221	—	—	—	—	18-1346	—	18-2016	—	18-7414	—	18-0523	—
CONNECTING ROD #638-8532-1															
115 OPTIMAX	6	G960500	T178499	—	18-1194	—	—	—	—	—	—	—	—	—	—
125 (1250, 1250BP)	6	2314956	2641954	18-4037	18-4038	—	18-4036	18-1154	18-2016	—	—	18-7961	—	18-2016	—
125 (1250BP)		2641955	3253111	18-4037	18-4038	—	—	—	—	—	—	—	—	—	—
125	4	D283222	& UP	—	—	—	—	18-1346	—	18-2016	—	18-7414	—	18-0523	—
135 (1350)		2839369	3293233	18-4037	18-4038	—	18-4036	18-1154	18-7151	18-2016	18-2016	18-7961	—	18-2016	—
1400		3293234	3502805	18-4037	18-4038	—	18-4036	18-1154	—	—	—	—	—	—	—
1400-140		4865678	& UP	18-4037	18-4038	—	18-4036	—	—	—	—	—	—	—	—
140 JET	V-6	D082000	& UP	—	18-4039	—	—	18-1345	18-0860	18-2016	18-2016	18-0858	—	18-2016	—
V-135	V-6	A904646	C239552	—	18-1194	—	—	—	—	—	—	—	—	—	—
WMETAL CAGED MAIN BRG															
V-135	V-6	A904646	C239552	—	18-1194	—	—	—	—	—	—	—	—	—	—
WIPLASTIC CAGED MAIN BRG															
V-135	V-6	C239553	D082000	—	18-1194	—	—	—	—	—	—	—	—	—	—
CONNECTING ROD #636-8118															
V-135	V-6	D082000	& UP	—	18-1194	—	—	—	—	—	—	—	—	—	—
V-135 DFI	V-6	D082000	G760299	—	18-4039	—	—	18-1345	—	—	—	—	—	—	—
V-135 DFI	V-6	G760300	& UP	—	18-1194	—	—	—	—	—	—	—	—	—	—
1500-1500XS	V-6	3502806	5327662	18-4037	18-4038	—	18-4036	18-1154	18-7161	18-2016	18-2016	18-7961	—	18-2016	—
1500-1500XS	V-6	8005615	8052649	18-4037	18-4038	—	18-4036	—	—	—	—	—	—	—	—
1500-1500XS	V-6	7010533	7112772	18-4037	18-4038	—	18-4036	—	—	—	—	—	—	—	—
V-150 (V-1500)	V-6	4868998	C100860	—	18-4039	—	—	18-1345	—	18-2016	18-2016	—	—	18-2016	18-1196
V-150	V-6	C100861	C239552	—	18-1194	—	—	18-1345	18-0860	18-2016	18-2016	18-0858	—	18-2016	—
V-150	V-6	C239553	D081999	—	18-1194	—	—	18-1345	18-0860	18-2016	18-2016	18-0858	—	18-2016	—
CONNECTING ROD #636-8118															
V-150	V-6	C239553	D081999	—	18-1194	—	—	—	—	—	—	—	—	—	—
CONNECTING ROD #644-818141															
V-150 DFI	V-6	D082000	& UP	—	18-1194	—	—	18-1345	18-0860	18-2016	18-2016	18-0858	—	18-2016	—
V-150 EFI	V-6	D082000	& UP	—	18-4039	—	—	18-1345	—	—	—	—	—	—	—
150	V-6	4868998	D081999	—	18-1194	—	—	—	—	—	—	—	—	—	—
XR-4	V-6	G760300	& UP	—	18-1194	—	—	—	—	—	—	—	—	—	—
XR-4	V-6	B242885	C239552	—	18-1194	—	—	—	—	—	—	—	—	—	—
XR-4	V-6	C239553	D081999	—	18-1194	—	—	—	—	—	—	—	—	—	—
XR-6	V-6	D082000	& UP	—	18-4039	—	—	18-1345	—	—	—	—	—	—	—
V-175 (1750)	V-6	4301235	6618750	—	18-4039	—	—	18-1345	—	18-2016	18-2016	—	—	18-2016	18-1196
V-175	V-6	6618751	C239552	—	18-1194	—	—	18-1345	18-0860	18-2016	18-2016	18-0858	—	18-2016	—
V-175	V-6	C239553	D081999	—	18-1194	—	—	18-1345	18-0860	18-2016	18-2016	18-0858	—	18-2016	—
V-175	V-6	D082000	& UP	—	18-1194	—	—	—	—	—	—	—	—	—	—
V-175 XRI	V-6	D000750	D081999	—	18-1194	—	—	18-1345	18-0860	18-2016	18-2016	18-0858	—	18-2016	—
V-175 EFI	V-6	D082000	& UP	—	18-4039	—	—	18-1345	—	—	—	—	—	—	—
V-175	V-6	T178500	& UP	—	18-1194	—	—	18-1345	18-0860	18-2016	18-2016	18-0858	—	18-2016	—
DFI & PRO XS															
175 (1750)II	V-6	8058870	& UP	—	18-1194	—	—	—	—	—	—	—	—	—	—
V-200 (V2000)	V-6	4839034	5363917	—	18-1194	—	—	18-1345	—	—	—	—	—	—	—
V-200 (V2000)	V-6	5363918	6073191	—	18-1194	—	—	18-1345	—	18-2016	18-2016	—	—	18-2016	18-1196
V-200 (2.4L)	V-6	6073192	C291519	—	18-1194	—	—	18-1345	18-0860	18-2016	18-2016	18-0858	—	18-2016	—
V-200 (2.5L)	V-6	C291520	D081999	—	18-1194	—	—	—	—	—	—	—	—	—	—
CONNECTING ROD #636-8118															
V-200 (2.5L)	V-6	C291520	D081999	—	18-1194	—	—	—	—	—	—	—	—	—	—
CONNECTING ROD #644-818141															
V-200	V-6	D082000	& UP	—	18-4039	—	—	18-1345	—	—	—	—	—	—	—
V-200 EFI	V-6	C100861	C291519	—	18-1194	—	—	18-1345	18-0860	18-2016	18-2016	18-0858	—	18-2016	—
V-200 EFI	V-6	C291520	D081999	—	18-1194	—	—	—	—	—	—	—	—	—	—
CONNECTING ROD #644-818141															
V-200 EFI	V-6	C291520	D081999	—	18-1194	—	—	—	—	—	—	—	—	—	—
CONNECTING ROD #636-8118															
V-200 EFI (2.5L)	V-6	D082000	B226999	—	18-4039	—	—	18-1345	—	—	—	—	—	—	—
V-220	V-6	B117316	& UP	—	18-1194	—	—	—	—	—	—	—	—	—	—
V-225	V-6	5628028	D280812	—	18-1194	—	—	18-1345	18-0860	18-2016	18-2016	—	—	18-2016	—
V-225 (225, SEAPRO)	V-6	D280813	& UP	—	18-4039	—	—	18-1345	—	—	—	—	—	—	—
V-225 DFI	V-6	G590000	T325116	—	—	—	—	18-1345	18-0860	—	—	18-7414	—	—	—
V-225	V-6	G129222	& UP	—	—	—	—	18-1345	18-0860	—	—	18-7414	—	—	—
V-250 EFI	V-6	G129222	T325116	—	—	—	—	18-1345	18-0860	—	—	18-7414	—	—	—
V-250	V-6	C101891	& UP	—	18-4039	—	—	18-1345	—	—	—	18-7414	—	18-2016	—
V-250 DFI & PRO XS	V-6	B528615	& UP	—	—	—	—	18-1345	18-0860	—	—	18-7414	—	—	—
V-275	V-6	C101891	& UP	—	—	—	—	—	—	—	—	18-7414	—	—	—
V-3.4L	V-6	5611648	& UP	—	18-4039	—	—	18-1345	—	—	—	18-7414	—	—	—



**18-2143
MOTOR MOUNT**
Replaces: 78249
Large Diameter
Lower Motor Mount
Includes: (1) Lower Motor Mount and (2) 1 1/4" O.D. x 1/2" I.D. Stainless Steel Washers



**18-2144
MOTOR MOUNT**
Replaces: 78687, 78687T
Small Diameter
Upper Motor Mount
Includes: (1) Upper Motor Mount and (1) 1 1/4" O.D. x 1/2" I.D. Stainless Steel Washer



**18-7901
OIL FILTER**
Replaces: 825467A1, T1
For: 9.9HP S/N OH000058-OH017099 (1995-98)



**18-7758
OIL FILTER**
Replaces: 35-877761K01, 35-877761Q01
For: 75/90/115 hp. (S/N 1B366823 (2006) & Up)



**18-7918
OIL FILTER**
Replaces: 35-883701K01, 35-877769K01
For: Verado 200-300 HP, Inline 6 cylinder



**18-7921
OIL FILTER**
Replaces: 35-896546T, 35-877767K01
For: Verado 135-200 HP, Inline 4 cylinder



**18-7906-1
OIL FILTER**
Replaces: 35-822626T7 & 35-822626Q15
Fits: 225 HP (Non-Verado)



**18-7913
OIL FILTER**
Replaces: 35-822626Q1
For: 8 HP (323cc) 2001-2004 / 9.9 HP (323cc) 1999-2004 / 15 HP. (323cc) 1998 and NEWER / 20 HP. 2008 and NEWER / 30 HP (492cc) 2006 and NEWER



**18-7914
OIL FILTER**
Replaces: 35-822626Q2, Q04
For: 25 HP. (498cc) 1998-2005 / 30 HP. (747cc) 1999-2005 / 40, 50, 60 HP. 1995 and NEWER / 75, 90 Carbureted 2000-2005 / 115 EFI (S/N 1B366822 and BELOW)

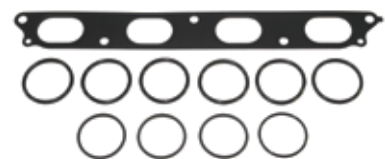

**18-0663
PLENUM GASKET KIT**
Fits: Mercury 75 4-Stroke (2000-03), 90 4-Stroke (2000 & Up),



**18-4334
POWERHEAD GASKET SET**
Replaces: 27-41499A87
For: 15HP, 18HP, 20HP & 25HP outboards

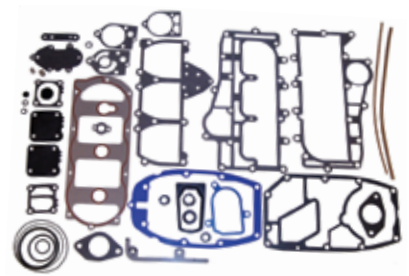

**18-4326
POWERHEAD GASKET SET**
Replaces: 27-43779A87
For: 50,55,60 HP, 3 cyl.

-- CONTAINS --

Part #	Desc.	O.E.#	Qty.
18-4261	Fiber Washer	19643	1
18-0320	Gasket	27-13937-6	6
18-0324	Gasket	27-15172-3	3
18-0670	Gasket	27-43007 5	1
18-2565	Gasket	27-43047-1	1
18-2945	Washer	12-20260	3
18-7164	O-Ring	25-33466	1
18-7198	O-Ring	25-45710	1
18-7167	O-Ring	25-45254	1
18-0182	Gasket	27-62386	1
18-2740	Cylinder Block Gasket	27-43005 7	1
18-2741	Gasket	27-43004 7	2
18-0339	Thermostat Gasket	27-43006-2	1
18-0341	Exhaust Gasket	27-43008	1
18-2563	Gasket	27-43034-1	1
18-2564	Gasket	22-43033-1	1
18-2566	Impeller Gasket	27-817277	1
18-7105	O-Ring	25-62705	2
18-7414	O-Ring	25-64067	1
18-0858	O-Ring	25-54029	1
18-7803	Diaphragm Kit	21-857005A1	1

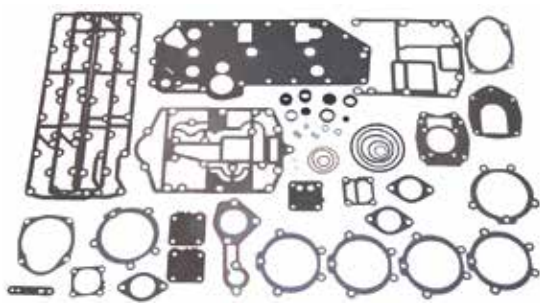

**18-4336
POWERHEAD GASKET SET**
Replaces: 27-43004A99
For: 70, 80, 90HP 3 cyl outboards

GASKET SET APPLICATION BEGINS ON PAGE 359
***POWER HEAD GASKET SETS DO NOT INCLUDE HEAD GASKETS**

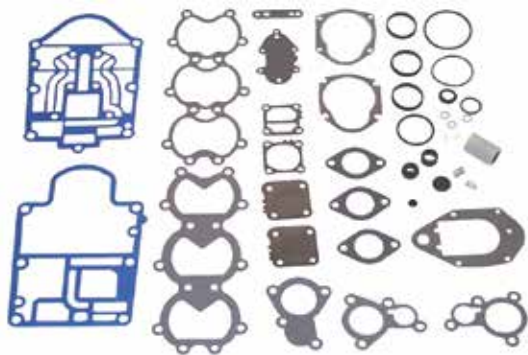

18-4337
POWERHEAD GASKET SET
 Replaces: 27-812867A97
 For: 45 Jet, 50HP, 55HP, 60HP, 3 cyl outboards

CONTAINS —

Part #	Desc.	O.E.#	Qty.
18-7152	O-Ring	25-20863	1
18-2244	Washer	10-79953A2	3
18-7173	O-Ring	25-30224	1
18-0182	Thermostat Gasket	27-62386	1
18-2719	Induction Manifold Gasket	27-812869	1
18-2721	Adapter Plate Gasket	27-827284	1
18-2729	Thermostat Cover Gasket	27-812867 2	1
18-2749	Thermostat Gasket	27-812867 1	1
NSS	Exhaust Gasket	27-812866	1
18-0319	Exhaust Cover Gasket	27-828533	1
18-0622	Lower Wear Plate Gasket	27-19701	1
18-0345	Water Pump Gasket	27-722189	1
18-2593	Water Pump Gasket	N/A	1
18-2566	Impeller Gasket	27-817277	1
18-7176	O-Ring	25-90011	1
18-7950	O-Ring	25-45258	1
18-7817	Diaphragm Kit	21-857005A1	1

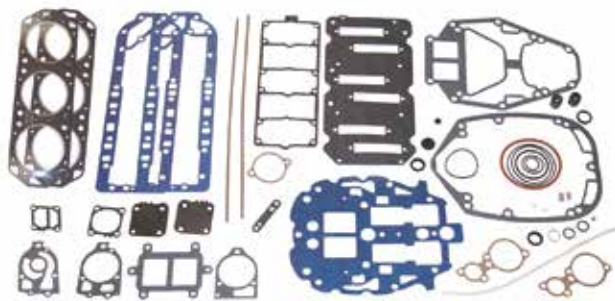

18-4339
POWERHEAD GASKET SET
 Replaces: 27-14697A87
 For: V200EFI and V220 outboards

CONTAINS —

Part #	Desc.	O.E.#	Qty.
18-7196	O-Ring	25-38099	1
18-3862	Head Gasket	27-41246-1	2
18-7153	O-Ring	25-21836	1
18-7164	O-Ring	25-33466	1
18-7159	O-Ring	25-31534	1
18-0135	Gasket	27-78246	1
18-7426	Slinger	25-30271	1
18-0182	Gasket	27-62386	2
18-0860	O-Ring	25-62700	1
18-0936	Gasket	27-78690	2
18-2919	Gasket	27-42631-1	1
18-2915	Gasket	27-85609-1	1
18-2506-1	Exhaust Plate Gasket	27-99176-3	1
18-2503	Drive Shft Gasket	27-99177-1	1
18-2513	Cork	27-11338	2
18-0644	Reed Plate Gasket	27-14697-2	1
18-0645	Gasket	27-16737-1	1
18-2502	Gasket	27-90484-1	2
18-2511	Gasket	27-99173-2	1
18-2914	Gasket	27-85608-1	1
18-3110	Grommet	26-38970	2
18-7174	O-Ring	25-45711	2
18-7176	O-Ring	25-90011	1
18-8305	Divider Plate Seal	26-814754	1
18-0858	O-Ring	25-54029	1
18-0952	Gasket	27-88907	1
18-7421	O-Ring	25-20415	1
18-0970	Fuel Pump Gasket	27-98769-1	1
18-7817	Diaphragm Kit	21-857005A1	1

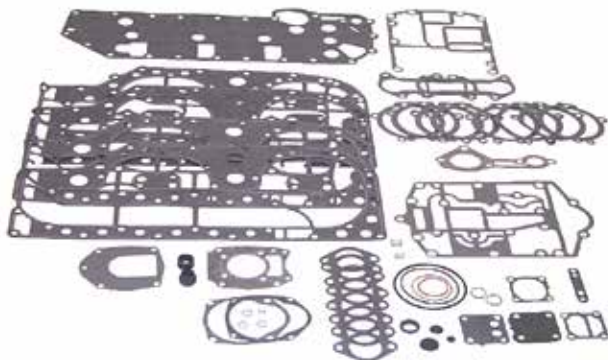

18-4340
POWERHEAD GASKET SET
 Replaces: 27-13461A99
 For: 80 Jet, 100HP, 115HP, and 125HP 4 cyl outboards

CONTAINS —

Part #	Desc.	O.E.#	Qty.
18-4261	Fiber Washer	19643	1
18-7961	O-Ring	25-47254	1
18-0320	Gasket	27-13937-6	8
18-0324	Gasket	27-15172 4	8
18-0670	Gasket	27-43007-5	1
18-2565	Gasket	27-43047-2	1
18-2945	Washer	12-19183	3
18-7198	O-Ring	25-45710	1
18-0182	Gasket	27-62386	1
18-2942	Gasket	27-13461-2	2
18-2943	Cylinder Block Gasket	27-44328-4	1
18-2621	Outer Exhaust Plate Gasket	27-13958-1	2
18-2610	Baffle Plate Gasket	27-812775-4	1
18-2611	Inner Exhaust Plate Gasket	27-812775-5	1
18-0339	Thermostat Gasket	27-43006-2	1
18-0341	Exhaust Gasket	27-43008-6	1
18-2563	Gasket	27-43034-1	1
18-2564	Gasket	27-43033-1	1
18-2566	Impeller Gasket	27-817277	1
18-7105	O-Ring	25-62705	1
18-7414	O-Ring	25-64067	1
18-0858	O-Ring	25-54029	1
18-0970	Fuel Pump Gasket	27-98769-1	1
18-7817	Diaphragm Kit	21-857005A1	1

GASKET SET APPLICATION BEGINS ON PAGE 359
 *POWER HEAD GASKET SETS DO NOT INCLUDE HEAD GASKETS

-- CONTAINS --

Part #	Desc.	O.E.#	Qty.
18-0182	Thermostat Gasket	27-62386	2
18-0858	O-Ring	254029	1
18-0860	O-Ring	25-62700	1
18-0129	Reed Block Gasket	27-65744-3	6
18-0135	Adapter Cover Gasket	27-78246	1
18-0936	Relief Valve Plate Gasket	27-78690	2
18-0952	Relief Valve Plate Gasket	27-88907	2
18-7421	O-Ring	25-20415	2
18-7411	O-Ring	25-35480	1
18-2501	Reed Block Housing Gasket	27-93536-1	1
18-2502	Divider Plate Gasket	27-90484-1	2
18-2503	Drive Shaft Hsg. to Exhaust Plate Gasket	27-99177-1	1
18-2506	Exhaust Plate Gasket	27-99176-3	1
18-2508	Exhaust Plate Gasket	27-99776-1	2
18-2509	Carb. Mtg. Gasket	27-67751	3
18-2510	Reed Block Housing Gasket	27-96761-1	1
18-2511	Drive Shaft Housing to Plate Gasket	27-99173-2	1
18-2513	Cyl Block Sealing Gasket	27-11338	2
18-2803	Carb. Mounting Gasket	27-90430	3
18-2808	Cyl. Cover	27-96278	2
18-2826	Water Pump Base to Gear Housing Gasket	27-85610-1	1
18-2914	Water Pump Gasket	27-85608-1	1
18-2915	Water Pump Gasket	27-85609-1	1
18-3110	Bushing	26-38970	2
18-7153	O-Ring	25-25439	1
18-7157	O-Ring	25-29976	1
18-7159	O-Ring	25-31534	1
18-7162	O-Ring	25-33145	1
18-7164	O-Ring	25-33466	1
18-7168	O-Ring	25-48171	4
18-7174	O-Ring	25-45711	2
18-7176	O-Ring	25-90011	1
18-7196	O-Ring	25-38099	1
18-7812	Fuel Pump Kit	89031A2	1
18-7816	Fuel Pump Diaphragm Kit	21-42990A9	1
18-3863	Head Gasket	27-96542-1	2
18-0359	Induction Silencer Cover Gasket	27-67275-1	1
18-0384	Carburetor Gasket	27-89221-1	3
18-2919	Water Pump Gasket	27-42631-1	1
18-7406	O-Ring	—	1

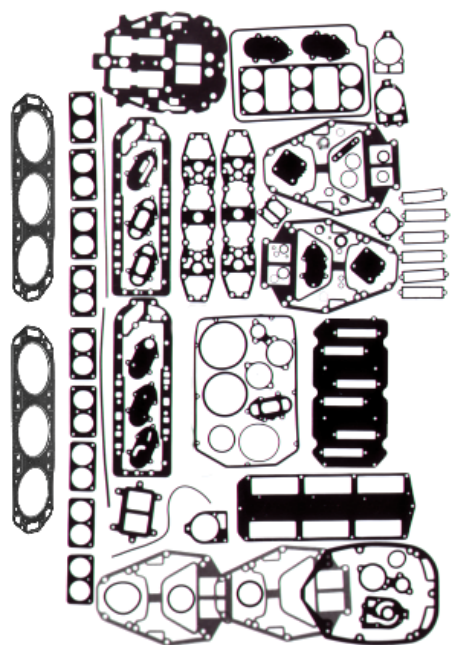

**18-4317
POWERHEAD GASKET SET**
Replaces: 27-90484A88

-- CONTAINS --

Part #	Desc.	O.E.#	Qty.
18-0182	Thermostat Gasket	27-62386	2
18-0858	O-Ring	254029	1
18-0860	O-Ring	25-62700	1
18-0129	Reed Block Gasket	27-65744-3	6
18-0135	Adapter Cover Gasket	27-78246	1
18-0936	Relief Valve Plate Gasket	27-78690	2
18-0952	Relief Valve Plate Gasket	27-88907	2
18-7421	O-Ring	25-20415	2
18-7411	O-Ring	25-35480	1
18-2501	Reed Block Hsg. Gasket	27-93536-1	1
18-2502	Divider Plate Gasket	27-90484-1	2
18-2503	Drive Shaft Hsg. to Exhaust Plate Gasket	27-99177-1	1
18-2506	Exhaust Plate Gasket	27-99176-3	1
18-2508	Exhaust Plate Gasket	27-99776-1	2
18-2509	Carb. Mtg. Gasket	27-67751	3
18-2510	Reed Block Hsg. Gasket	27-96761-1	1
18-2511	Drive Shaft Hsg. to Plate Gasket	27-99173-2	1
18-2513	Cyl Block Sealing Gasket	27-11338	2
18-2803	Carb. Mtg. Gasket	27-90430	3
18-2808	Cyl. Cover	27-96278	2
18-2826	Water Pump Base to Gear Housing Gasket	27-85610-1	1
18-2914	Water Pump Gasket	27-85608-1	1
18-2915	Water Pump Gasket	27-85609-1	1
18-3110	Bushing	26-38970	2
18-7153	O-Ring	25-25439	1
18-7157	O-Ring	25-29976	1
18-7159	O-Ring	25-31534	1
18-7162	O-Ring	25-33145	1
18-7164	O-Ring	25-33466	1
18-7168	O-Ring	25-48171	4
18-7174	O-Ring	25-45711	2
18-7176	O-Ring	25-90011	1
18-7196	O-Ring	25-38099	1
18-7812	Fuel Pump Kit	89031A2	1
18-7816	Fuel Pump Diaphragm Kit	21-42990A9	1
18-3862	Head Gasket	27-41246-1	2
18-0359	Induction Silencer Cover Gasket	27-67275-1	1
18-0384	Carburetor Gasket	27-89221-1	3
18-2919	Water Pump Gasket	27-42631-1	1
18-7406	O-Ring	—	1
18-7176	O-Ring	25-90011	1

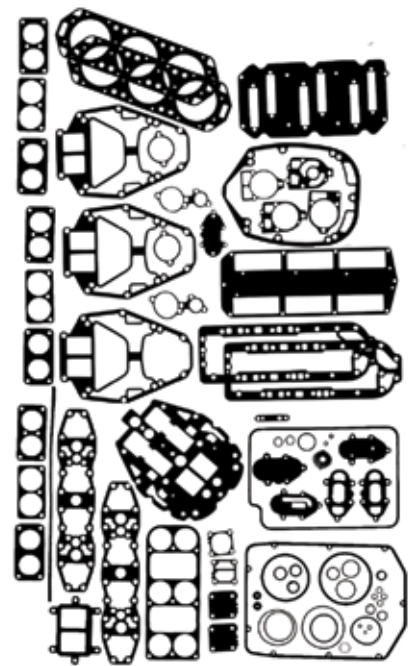

**18-4319
POWERHEAD GASKET SET**
Replaces: 27-11338A88, 27-89221A88

-- CONTAINS --

Part #	Desc.	O.E.#	Qty.
18-0940	Baffle Plate to Exhaust Gasket	27-85488-2	1
18-0879	Adapter Plate Gasket	27-38501-1	1
18-2810	Block Cover Gasket	27-43777-2	1
18-0103	Powerhead to Ext. Plate Gasket	27-79650-1	2
18-0137	Baffle Plate Gasket	27-85492-2	1
18-2800	Carb. Flange Gasket	27-75791-1	2
18-0870	Transfer Port Cover Gasket	27-27936-1	2
18-0539	Rubber Seal Gasket	37721	1
18-7161	O-Ring	25-32546	1
18-2844	Thermostat Gasket	27-48818-1	1
18-2823	Lower Water Pump Base to Face Plate Gasket	27-19553	1
18-0938	Water Inlet Tube Gasket	27-79797-1	1
18-2825	Water Pump Base Gasket	27-32771	1
18-7153	O-Ring	25-25439	1
18-7151	O-Ring	25-20081	1



***18-4325
POWERHEAD GASKET SET**
Replaces: 27-85491A90

GASKET SET APPLICATION BEGINS ON PAGE 359
***POWER HEAD GASKET SETS DO NOT INCLUDE HEAD GASKETS**

— CONTAINS —

Part #	Desc.	O.E.#	Qty.
18-0912	Drive Shaft Hsg. Plate Gasket	27-66102-1	1
18-0133	Water Jacket Cover Gasket	27-73665	1
18-0944	Water Jacket Cover Gasket	27-85496-1	1
18-0107	Exhaust Cover Gasket	27-85498-1	1
18-7421	O-Ring	25-20415	1
18-3110	Grommet	26-38970	2
18-7411	O-Ring	25-35480	1
18-2500	VC Gasket	27-85493	1
18-2514	Crankcase to Cyl Block Gasket	27-53650	2
18-2802	Carb. Flange Gasket	27-48164-1	2
18-2826	Water Pump Base to Gear Housing Gasket	27-85610	1
18-2835	Powerhead Gasket	27-69238	1
18-2914	Water Pump Gasket	27-85608	1
18-2915	Water Pump Gasket	27-85609-1	1
18-7153	O-Ring	25-25439	1
18-7157	O-Ring	25-29976	1
18-7161	O-Ring	25-32546	1
18-7162	O-Ring	25-33145	1
18-7167	O-Ring	25-47254	2
18-7827	Filter Screen	35-59072	1
18-7807	Fuel Pump Kit	55278A1	1
18-0351	Distributor Cap Gasket	27-55896	1
18-7426	O-Ring	25-30271	1
18-4261	Washer	19643	1

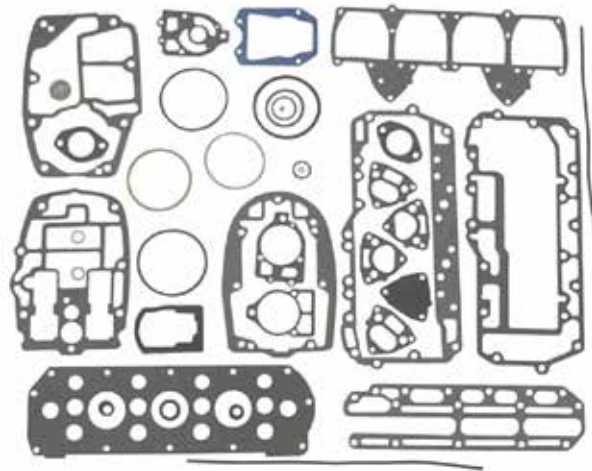

***18-4351
POWERHEAD GASKET SET**
Replaces: 27-64203A75

— CONTAINS —

Part #	Desc.	O.E.#	Qty.
18-0123	End Cap Cover Gasket	27-25725	1
18-0870	Transfer Port Cover Gasket	27-27936-1	2
18-0879	Adapter Plate Gasket	27-30501-1	1
18-0901	Driver Cap Gasket	27-47190	1
18-0103	Powerhead to Ext. Plate Gasket	27-79650-1	2
18-0938	Water Inlet Tube Gasket	27-79797-1	1
18-0942	Baffle Plate Gasket	27-85491-2	1
18-0137	Baffle Plate Gasket	27-85492-2	1
18-7421	O-Ring	25-20415	1
18-2507	Cyl Block Cover Gasket	27-85487	1
18-2800	Carb. Flange Gasket	27-75791-1	2
18-2810	Block Cover Gasket	27-43777-2	1
18-2823	Lower Water Pump Base to Face Plate Gasket	27-32769, 27-19553	1
18-2824	Upper Face Plate to Pump Body Gasket	27-32770, 27-19551	1
18-2825	Water Pump Base Gasket	27-32771	1
18-2841	Water Pump Base Gasket	27-77417, 27-19552	1
18-7151	O-Ring	25-20081	2
18-7153	O-Ring	25-25439	1
18-7115	O-Ring	25-26722	1
18-7155	O-Ring	25-26855	1
18-7160	O-Ring	25-31986	1
18-7197	O-Ring	25-29619	1
18-7413	O-Ring	25-62702	2
18-7804	Fuel Pump Kit	23014A1	1
18-2571	Carb Flange Gasket	27-31402	2



***18-4353
POWERHEAD GASKET SET**
Replaces: 27-72486A32

— CONTAINS —

Part #	Desc.	O.E.#	Qty.
18-0912	Drive Shaft Hsg. Plate Gasket	27-66102-1	1
18-0926	Transfer Port Cover Gasket	27-73645	1
18-0133	Water Jacket Cover Gasket	27-73665	1
18-0101	Carb. Plate Gasket	27-76952	2
18-0944	Baffle to Exchange Cover Gasket	27-85496-1	1
18-0107	Exhaust Cover Gasket	27-85498-1	1
18-7421	O-Ring	25-20415	1
18-3110	Grommet	26-38970	1
18-7411	O-Ring	25-35480	2
18-2500	Exhaust Cover Gasket	27-85493	1
18-2505	Cyl Block Cover Gasket	27-96171-1	1
18-2514	Crankcase to Cyl Block Gasket	27-53650	2
18-2804	Carb. Flange Gasket	27-73377-1	2
18-2826	Water Pump Base to Gear Housing Gasket	27-85610-1	1
18-2835	Powerhead Gsk	27-69238-1	1
18-2914	Water Pump Gasket	27-85608-1	1
18-2915	Water Pump Gasket	27-85609-1	1
18-7153	O-Ring	25-25439	1
18-7157	O-Ring	25-29976	1
18-7161	O-Ring	25-32546	2
18-7162	O-Ring	25-33145	1
18-7164	O-Ring	25-33466	1
18-7167	O-Ring	25-47254	2
18-7413	O-Ring	25-62702	2
18-7808	Fuel Pump Kit	55278A5	1
18-7816	Fuel Pump Diaphragm Kit	21-42990A9	1
18-7426	O-Ring	25-30271	1
18-4261	Washer	19643	1

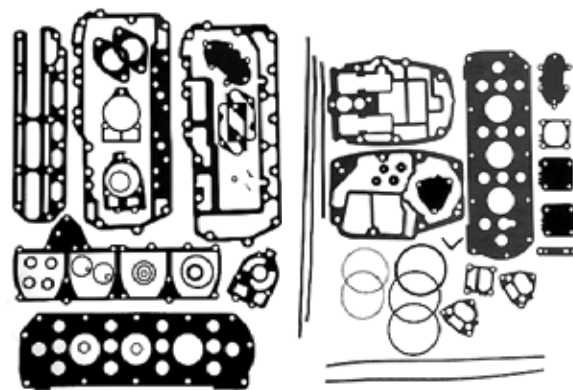

***18-4354
POWERHEAD GASKET SET**
Replaces: 27-73645A87

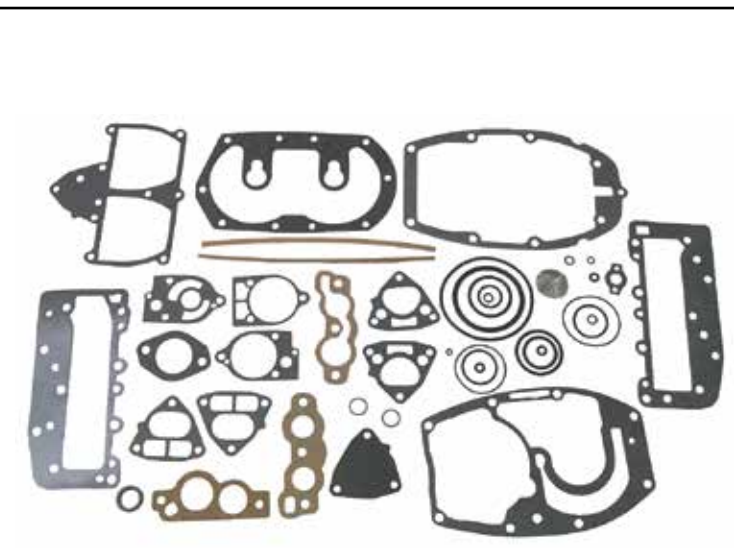

***18-4355**
POWERHEAD GASKET SET
 Replaces: 27-78028A78

-- CONTAINS --

Part #	Desc.	O.E.#	Qty.
18-0182	Thermostat Gasket	27-62386	1
18-0879	Adapter Plate Gasket	27-38501-1	1
18-0988	Powerhead to Plate Gasket	27-62860-1	1
18-0914	Thermostat Cover Gasket	27-66847	1
18-0938	Water Inlet Tube Gasket	27-79797-1	1
18-0940	Baffle Plate to Exhaust Gasket	27-85488-2	1
18-0105	Baffle Plate to Block Gasket	27-85489-2	1
18-7421	O-Ring	25-20415	1
18-7411	O-Ring	25-35480	1
18-2802	Carb Flange Gasket	27-48164-1	1
18-2805	Block Cover Gasket	27-85490-2	1
18-2823	Lower Water Pump Base to Face Plate Gasket	27-19553	1
18-2824	Upper Face Plate to Pump Body Gasket	27-19551	1
18-2825	Water Pump Base Gasket	27-32771	1
18-2838	Transfer Port Cover Gasket	27-55279-1	1
18-2841	Water Pump Base Gasket	27-19552	1
18-7115	O-Ring	25-26722	1
18-7143	O-Ring	25-65936	2
18-7145	O-Ring	25-64068	3
18-7153	O-Ring	25-25439	1
18-7155	O-Ring	25-26855	1
18-7160	O-Ring	25-31986	1
18-7167	O-Ring	25-47254	1
18-7412	O-Ring	25-62457	1
18-7413	O-Ring	25-62702	3
18-7414	O-Ring	25-64067	1
18-7827	Filter Screen	35-59072	1
18-7807	Fuel Pump Kit	55278A1	1
18-4261	Washer	19643	1

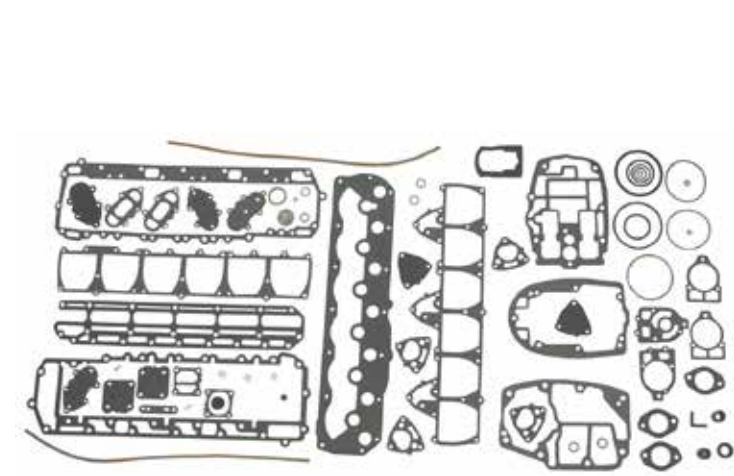

***18-4356**
POWERHEAD GASKET SET
 Replaces: 27-85653A87

-- CONTAINS --

Part #	Desc.	O.E.#	Qty.
18-7153	O-Ring	25-25439	1
18-7120	O-Ring	25-38933	1
18-3110	Bushing	26-38970	2
18-7164	O-Ring	25-33466	1
18-7167	O-Ring	25-47254	1
18-2802	Carb. Flange Gasket	27-48164-1	3
18-7413	O-Ring	25-62702	2
18-7161	O-Ring	25-32546	2
18-7173	O-Ring	25-30224	1
18-3110	Grommet	26-38970	1
18-7421	O-Ring	25-20415	1
18-7162	O-Ring	25-33145	1
18-7157	O-Ring	25-29976	1
18-2914	Water Pump Gasket	27-85608-1	1
18-2915	Water Pump Gasket	27-85609-1	1
18-2801	Water Pump Gasket	27-32438	1
18-2826	Water Pump Base to Gear Housing Gasket	27-85610-1	1
18-0912	Drive Shaft Hsg. Gasket	27-66102-1	1
18-2573	Water Jacket Cover Gasket	27-72142-1	1
18-2574	Exhaust Cover Gasket	27-85495-2	1
18-0946	Transfer Port Gasket	27-85653-1	1
18-2515	Crankcase to Cyl. Block Gasket	27-53862	2
18-2807	Block Cover Gasket	27-98185	1
18-2835	Powerhead Gasket	27-69238-1	1
18-2839	Exhaust Cover	27-85497-2	1
18-7807	Fuel Pump Kit	55278A1	2
18-7813	Fuel Pump Kit	89031A3	1
18-7816	Fuel Pump Diaphragm Kit	21-42990A9	1
18-0351	Distributor Cap Gasket	27-55896	1
18-7426	O-Ring	25-30271	1

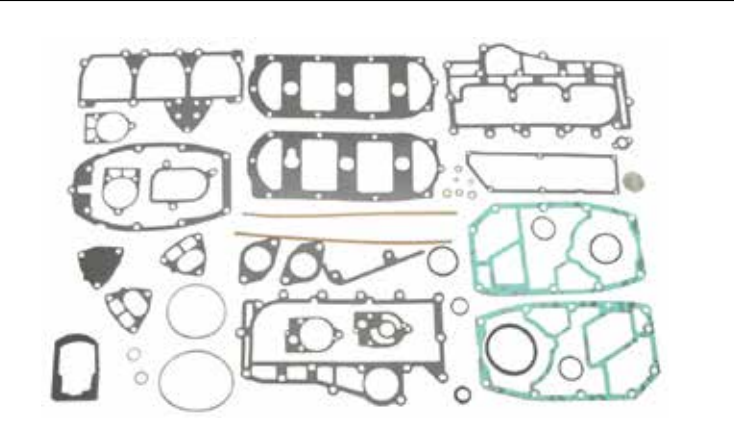

***18-4357**
POWERHEAD GASKET SET
 Replaces: 27-88449A32

-- CONTAINS --

Part #	Desc.	O.E.#	Qty.
18-0182	Thermostat Gasket	27-62386	1
18-0879	Adapter Plate Gasket	27-38501-1	1
18-0904	Powerhead to Exhaust Gasket	27-60317	1
18-0918	Plate to Exhaust Manifold Gasket	27-69524-2	1
18-0131	Baffle Plate Gasket	27-69525-2	1
18-0922	Baffle Plate Gasket	27-70335-1	1
18-0932	Transfer Passage Cover Gasket	27-76862-1	1
18-0938	Water Inlet Tube Gasket	27-79797-1	1
18-0139	Powerhead to Exhaust Plate Gasket	27-88451-1	1
18-7421	O-Ring	25-20415	1
18-2945	Drain Gasket	12-20260	2
18-7411	O-Ring	25-35480	1
18-2504	Block Cover Gasket	27-88449	1
18-2512	Crankcase to Cyl. Block Gasket	27-60286	2
18-2804	Carb. Flange Gasket	27-73377-1	2
18-2809	Block Cover Gasket	27-43779-2	1
18-2823	Lower Water Pump Base to Face Plate Gasket	27-19553	1
18-2824	Upper Face Plate to Pump Body Gasket	27-19551	1
18-2825	Water Pump Base Gasket	27-32771	1
18-2841	Water Pump Base Gasket	27-19552	1
18-7143	O-Ring	27-77417	1
18-7153	O-Ring	25-25439	1
18-7115	O-Ring	25-26722	1
18-7155	O-Ring	25-26855	1
18-7160	O-Ring	25-31986	1
18-7161	O-Ring	25-32546	1
18-7413	O-Ring	25-62702	2
18-7415	O-Ring	25-64966	1
18-7827	Filter Screen	35-59072	1
18-7809	Fuel Pump Kit	55278A4	1
18-4261	Washer	19643	1

GASKET SET APPLICATION BEGINS ON PAGE 359
***POWER HEAD GASKET SETS DO NOT INCLUDE HEAD GASKETS**

— CONTAINS —

Part #	Desc.	O.E.#	Qty.
18-0135	Gasket, Adapter	27-78246	1
18-0182	Gasket, Thermostat	27-62386	2
18-0384	Gasket, Carburetor	27-89221-1	3
18-0641	Gasket, Carb Mounting	27-828292	3
18-0642	Gasket, Divider Plate	27-19050-3	1
18-0643	Gasket, Exh. Plate	27-18307-1	1
18-0644	Gasket, Reed Plate	27-14697-2	1
18-0645	Gasket, Adapter Plate	27-16737-1	1
18-0646	Gasket, Reed Plate	27-813859	1
18-0838	O-Ring	—	1
18-0858	O-Ring	25-54029	1
18-0860	O-Ring	25-62700	1
18-0936	Gasket, Relief Valve	27-78690	2
18-2506	Gasket, Pwr Head	27-99176-3	1
18-2509	Gasket, Carb Mounting	27-67751	3
18-2511	Gasket, Drive Shaft To Hsg Plate	27-99173-2	1
18-2513	Gasket, Crankcase Cvr.	27-11338	2
18-2914	Gasket, Water Pump	27-85608-1	1
18-2915	Gasket, Water Pump	27-85609-1	1
18-2919	Gasket, Water Pump	27-42631-1	1
18-3110	Seal	26-38970	2
18-7153	O-Ring	25-25439	1
18-7157	O-Ring	25-29976	1
18-7159	O-Ring	25-31534	1
18-7174	O-Ring	25-45711	1
18-7176	O-Ring	25-90011	1
18-7816	Fuel Pump Diaphragm Kit	21-42990A10	1
18-8305	Seal, Divider Plate	26-814754	1

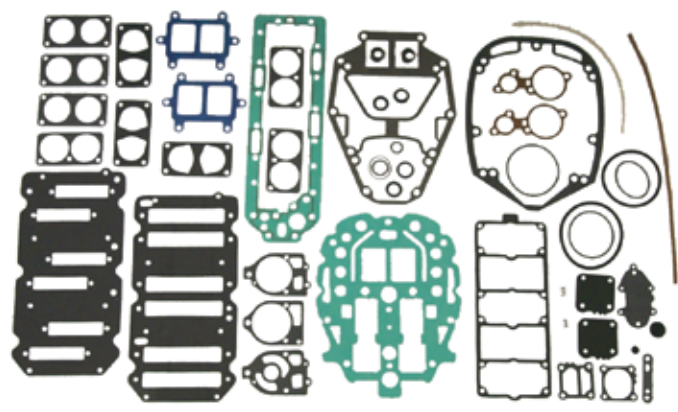

***18-4359
POWERHEAD GASKET SET**
Replaces: 27-815791A92

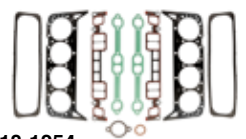

**18-1254
VORTECH
HEAD GASKET SET**
Replaces: 27-75611A03
For: Small Block GM V8 engines with Vortech heads

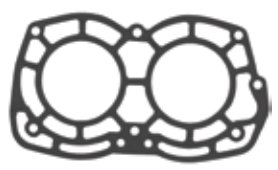

**18-2736
HEAD GASKET**
Replaces: 27-863895
For: 15-25HP 2 cyl



**18-3804
HEAD GASKET**
Replaces: 27-19138M, 19138, 27-84733M
For: Model 30A; S/N Code 689



**18-3828
HEAD GASKET**
Replaces: 27-18937M, 27-18937, 27-98990M, 27-83899M
For: Model 9.9C; S/N Code 682 & Model 15C, S/N Code 684



**18-3861
HEAD GASKET**
Replaces: 27-18785-1
For: Model 135, 150 and XR4



**18-3862
HEAD GASKET**
Replaces: 27-41246-1
For: Model 175, 200, XR4

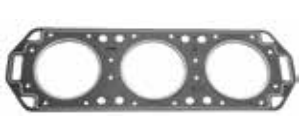

**18-3863
HEAD GASKET**
Replaces: 27-96542-1
For: Model 150



**18-3864
HEAD GASKET**
Replaces: 27-822844-1
For: Model 175, 200 and XR6



**18-3871
HEAD GASKET**
Replaces: 27-18786-1
For: Model 175, XR4, Mag II



**18-3872
HEAD GASKET**
Replaces: 27-41245-1
For: 200 and 225 HP



**18-3844
HEAD GASKET**
Replaces: 27-803508
For: 4-Stroke O/B's, 4/5/6 HP S/N OR000001 & Up

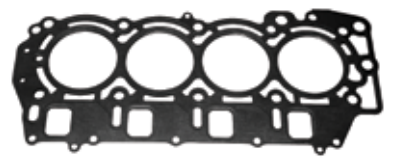

**18-3845
HEAD GASKET**
Replaces: 27-825032
For: 4-Stroke O/B's, 40/45/50 HP S/N OG760300 & Up



**18-3827
HEAD GASKET**
Replaces: 27-8254821
For: 8, 9.9 HP 4-Stroke

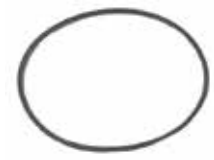

**PKG. OF 5
18-7400
18-7400-9①
O-RING HEAD GASKET**
Replaces: 25-818573
1 per cylinder, 3 per cylinder head













① Priced per Package

**GASKET SET APPLICATION ON NEXT PAGE
*POWER HEAD GASKET SETS DO NOT INCLUDE HEAD GASKETS**

HEAD GASKET/GASKET SET APPLICATION





























Model	Cyl.	Beg. S/N	End. S/N	Gasket Set	Head O-Rings	Head Gasket	Head Seals	Model	Cyl.	Beg. S/N	End. S/N	Gasket Set	Head O-Rings	Head Gasket	Head Seals
4/5/6 (4 stroke)	1 CYL	R000001	& UP	—	—	18-3844	—	140 (140, 1450)	6 CYL	4865678	& UP	18-4356	—	—	—
8 FOUR STROKE (232cc)		H000058	H017349	—	—	18-3827	—	140 (140, 1400)	6 CYL	4865678	& UP	18-4356	—	—	—
8 FOUR STROKE (232cc)		G760300	T178499	—	—	18-3827	—	150 (1500)	6 CYL	3502806	5327622	18-4356	—	—	—
9.9 FOUR STROKE (232cc)		H000058	H017349	—	—	18-3827	—	V-135	V-6	A904646	C239552	18-4317 ①	—	18-3863	—
18 (18XD)	2	6416713	6443972	18-4334	—	—	—	V-135	V-6	C239553	G960499	18-4359	—	18-3861	— 1
20 (20, 20XD, 200)	2	6443973	OT800999	18-4334	—	—	—	V-135 DFI	V-6	G590000	G960499	18-4338	—	—	— 1
20 JET	2	G044027	& UP	18-4334	—	—	—	140 JET	V-6	D082000	G960499	18-4359	—	18-3864	— 1
30 JET (40 HP)	4 CYL	C159200	& UP	18-4325	—	—	—	V-150 (150, 1500)	V-6	4868998	6042945	18-4315	—	—	—
35	2 CYL	6445653	B110788	18-4355	—	—	—	V-150	V-6	6042946	C239552	18-4317 ①	—	18-3863	—
40, 402	2 CYL	3336258	G053313	18-4355	—	—	—	V-150	V-6	C239553	G960499	18-4359	—	18-3861	— 1
40	4 CYL	C159200	& UP	18-4325	—	—	—	V-150	V-6	G960500	& UP	18-4338	—	—	— 6
40 FOUR STROKE (232cc)	3 CYL	G231123	T178499	—	—	18-3845	—	V-150 (XR/MAGNUM II)	V-6	B242885	C239552	18-4319 ①	—	—	—
45	4 CYL	5531630	0B110788	18-4353	—	—	—	V-150 XR4	V-6	C239553	D081999	18-4359	—	18-3871	— 1
45	4 CYL	B110789	& UP	18-4325	—	—	—	V-150 (XR6/MAGNUM III)	V-6	D082000	G960499	18-4359	—	18-3864 ② ④	— 1
45 Jet	3 CYL	D000750	& UP	18-4337	—	—	—	V-150 (EFI)	V-6	D082000	G960499	18-4359	N/A	—	— 1
45 FOUR STROKE (BODENSEE)		G231123	T178499	—	—	18-3845	—	150 MAR	V-6	5600162	6038680	18-4315	—	—	—
50, 500	4 CYL	2116318	& UP	18-4353	—	—	—	150 MAR	V-6	6038681	C239553	18-4317 ①	—	18-3863 ②	—
50, 60	4 CYL	6428681	B122929	18-4357	—	—	—	V-175 (175, 1750)	V-6	4301235	6618750	18-4315	—	—	—
50	3 CYL	D000750	OG589999	18-4337	—	—	—	V-175	V-6	6618751	C239552	18-4319 ①	—	18-3882	—
50	3 CYL	B122930	D000749	18-4326	—	—	—	V-175	V-6	D081999	D081999	18-4359	—	18-3871 ② ③	— 1
50 FOUR STROKE		G231123	T178499	—	—	18-3845	—	V-175 (EFI)	V-6	D000750	D081999	18-4359	—	18-3871 ② ④	— 1
55	3 CYL	6428681	B122929	18-4357	—	—	—	V-175 (EFI)	V-6	D000750	D081999	18-4359	—	18-3864 ② ④	— 1
55	3 CYL	D000750	& UP	18-4337	—	—	—	V-200 (200, 2000)	V-6	4839034	6073191	—	—	18-3872 ②	—
65 (650)	3 CYL	3293184	4382056	18-4352	—	—	—	V-200	V-6	6073192	6203990	—	—	18-3872 ②	—
65 (650)	3 CYL	4382057	4571651	18-4357	—	—	—	V-200	V-6	6203991	C291519	18-4319 ①	—	18-3862 ② ③	—
70	3 CYL	4571652	A996141	18-4357	—	—	—	V-200	V-6	C291520	D081999	18-4359	—	18-3864 ② ④	— 1
70	3 CYL	A996142	& UP	18-4336	—	—	—	V-200	V-6	D082000	G960499	18-4359	—	—	— 1
75	4 CYL	6432901	& UP	18-4354	—	—	—	V-200 (EFI)	V-6	C100861	OC291519	18-4339	—	18-3862	—
80	3 CYL	A996142	& UP	18-4336	—	—	—	V-200 (EFI)	V-6	C291520	G960499	18-4359	—	18-3864	— 1
80 Jet	4 CYL	D283222	& UP	18-4340	—	—	—	V-200 (DFI) 3.0L	V-6	G386496	G589999	—	18-7400	—	—
80, 800	4 CYL	2559001	3493912	18-4350	—	—	—	V-200 (DFI) 3.0L	V-6	G590000	G960499	18-4335	18-7400	—	— 2
80, 800	4 CYL	4831999	6432900	18-4354	—	—	—	V-200 (DFI) 3.0L	V-6	G960500	T178499	—	18-7400	—	— 3
85, 850	4 CYL	3493913	4366801	18-4351	—	—	—	V-200 XRI EFI	V-6	C100861	C291519	—	—	18-3862 ②	—
85, 850	4 CYL	4366802	4831998	18-4354	—	—	—	V-200 XRI EFI	V-6	C291520	& UP	18-4359	—	18-3864 ② ④	—
90, 900	6 CYL	4845301	& UP	18-4356	—	—	—	V-220	V-6	B117316	& UP	18-4339	—	18-3862 ②	—
90	3 CYL	A996142	& UP	18-4336	—	—	—	V-225 SEA PRO	V-6	G245605	OT408999	—	18-7400 ⑤	—	—
100	4 CYL	B209468	& UP	18-4340	—	—	—	V-225 (EFI) 3.0L	V-6	G129222	T408999	—	18-7400 ⑤	—	—
105 JET	6 CYL	D082000	& UP	18-4359	—	18-3864 ②	— 1	V-225 DFI (3.0L)	V-6	G590000	OG960499	18-4335	18-7400 ⑤	—	— 3
115	4 CYL	C100000	& UP	18-4340	—	—	—	V-225 DFI (3.0L)	V-6	G960500	T178499	—	18-7400 ⑤	—	— 3
125	4 CYL	D283222	& UP	18-4340	—	—	—	V-250 (EFI) 3.0L	V-6	G129222	T408999	—	18-7400 ⑤	—	—
140 (140, 1400)	6 CYL	3293234	3502805	18-4356	—	—	—								

- ① Gasket set includes head gasket
- ② 2 head gaskets required
- ③ Used on a 2.4L with a 3.38" bore
- ④ Used on a 2.5L with a 3.5" bore
- ⑤ Requires 3 per cylinder head
- ⑥ head gaskets not included in gskt set
- ⑦ Cyl head o-rings & seal not included in gskt kit
- ⑧ Cyl head o-rings not included in gskt kit
- ⑨ Cyl head gaskets & seal not included in gskt set

 18-0101 CARB TO SILENCER BOX GASKET Replaces: 27-76952 4 Cyl.	 18-0324 CARB TO MANIFOLD GASKET Replaces: 27-15172 3, 27-151724	 18-0384 CARB GASKET Replaces: 27-892211 200/225 HP	 18-0633 CARB MOUNTING GASKET Replaces: 27-192061
 18-0641 CARB MOUNTING GASKET Replaces: 27-828292	PKG. OF 3  18-2509 18-2509-9 ⑥ CARB MOUNTING GASKET Replaces: 27-67751 V-6	PKG. OF 2  18-2571 18-2571-9 ⑥ CARB FLANGE GASKET Replaces: 27-31402	PKG. OF 2  18-2572 18-2572-9 ⑥ CARB FLANGE GASKET Replaces: 27-63309
PKG. OF 2  18-2800 18-2800-9 ⑥ CARB MOUNTING GASKET Replaces: 27-757911 20-45-50 HP	PKG. OF 2  18-2802 18-2802-9 ⑥ CARB FLANGE GASKET Replaces: 27-481641	PKG. OF 3  18-2803 18-2803-9 ⑥ CARB MOUNTING GASKET Replaces: 27-90430, 27-904301 V-6	PKG. OF 4  18-2804 18-2804-9 ⑥ CARB MOUNTING GASKET Replaces: 27-733771 3-4 Cyl.

SEE PAGES 166-167 FOR OUR COMPLETE LINE OF GASKET SEALANTS



















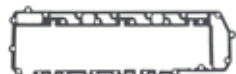









© Priced per Package

<p>PKG. OF 2</p>  <p>18-2568 18-2568-9^① STRAINER COVER SCREW GASKET Replaces: 27-25848</p>	<p>PKG. OF 2</p>  <p>18-2569 18-2569-9^① FILTER COVER GASKET Replaces: 27-25849</p>	<p>PKG. OF 2</p>  <p>18-2570 18-2570-9^① STRAINER COVER GASKET Replaces: 27-25851</p>	<p>PKG. OF 2</p>  <p>18-2575 18-2575-9^① CARB BOWL GASKET Replaces: 1399-99</p>	<p>PKG. OF 2</p>  <p>18-0970 18-0970-9^① FUEL PUMP GASKET Replaces: 27-987691</p>												
 <p>18-0359 INDUCTION SILENCER COVER GASKET Replaces: 27-672751</p>	 <p>18-0129 REED BLOCK GASKET Replaces: 27-657443 V-6</p>	 <p>18-0320 REED BLOCK GASKET Replaces: 27-13937-6</p>	 <p>18-0644 REED PLATE GASKET Replaces: 27-146972</p>	 <p>18-0646 REED PLATE GASKET Replaces: 27-813859</p>												
 <p>18-0866 REED BLOCK GASKET Replaces: 27-12775-2 200-225 HP</p>	<p>PKG. OF 2</p>  <p>18-2501 18-2501-9^① REED BLOCK HOUSING GASKET Replaces: 27-935361 V-6</p>	<p>PKG. OF 2</p>  <p>18-2510 18-2510-9^① REED BLOCK HOUSING GASKET Replaces: 27-967611 V-200</p>	<p>PKG. OF 5</p>  <p style="text-align: center;">CRANKCASE GASKETS</p> <table border="1" style="width: 100%; border-collapse: collapse;"> <thead> <tr> <th style="text-align: left;">Part #</th> <th style="text-align: left;">Replaces:</th> <th style="text-align: left;">Description</th> </tr> </thead> <tbody> <tr> <td>18-2512 ^②</td> <td>27-60286</td> <td>Crankcase to Cyl. Block 3 Cyl.</td> </tr> <tr> <td>18-2513 ^②</td> <td>27-11338</td> <td>Cyl. Block Sealing V-6</td> </tr> <tr> <td>18-2514 ^②</td> <td>27-53650</td> <td>Crankcase to Cyl. Block 4 Cyl.</td> </tr> </tbody> </table>		Part #	Replaces:	Description	18-2512 ^②	27-60286	Crankcase to Cyl. Block 3 Cyl.	18-2513 ^②	27-11338	Cyl. Block Sealing V-6	18-2514 ^②	27-53650	Crankcase to Cyl. Block 4 Cyl.
Part #	Replaces:	Description														
18-2512 ^②	27-60286	Crankcase to Cyl. Block 3 Cyl.														
18-2513 ^②	27-11338	Cyl. Block Sealing V-6														
18-2514 ^②	27-53650	Crankcase to Cyl. Block 4 Cyl.														
 <p>18-0645 ADAPTER PLATE GASKET Replaces: 27-167371</p>	 <p>18-0105 BAFFLE GASKET Replaces: 27-85489-2</p>	 <p>18-0107 EXHAUST COVER GASKET Replaces: 27-85498-1 4 Cyl.</p>	 <p>18-0131 BAFFLE GASKET Replaces: 27-695252 3 Cyl.</p>	 <p>18-0133 WATER JACKET GASKET Replaces: 27-73665 4 Cyl.</p>												
 <p>18-0137 BAFFLE GASKET Replaces: 27-85492-2 50HP</p>	 <p>18-0371 BAFFLE GASKET Replaces: 27-78409 20 HP</p>	 <p>18-0373 BAFFLE GASKET Replaces: 27-78411 20 HP</p>	 <p>18-0918 PLATE TO EXHAUST MANIFOLD GASKET Replaces: 27-695242 3 Cyl.</p>	 <p>18-2712 ADAPTER PLATE GASKET Replaces: 27-414181 For: 15-25 2 cyl</p>												
 <p>18-2621 BAFFLE GASKET Replaces: 27-139581 For: 100HP 4 cyl, 115HP 4 cyl</p>	 <p>18-2710 REED BLOCK GASKET Replaces: 27-414172 For: 15-25HP 2 cyl</p>	 <p>18-2721 THERMOSTAT GASKET Replaces: 27-827284 For: 30-60HP 3 cyl outboards</p>	 <p>18-2729 THERMOSTAT GASKET Replaces: 27-8128672 For: 30-40HP 2 cyl, 45 Jet, 50-60 3 cyl</p>	 <p>18-2749 THERMOSTAT GASKET Replaces: 27-8128671 For: 45 Jet, 50-60 HP 3 cyl</p>												

SEE PAGES 166-167 FOR OUR COMPLETE LINE OF GASKET SEALANTS

















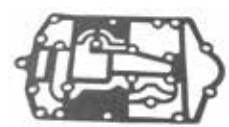

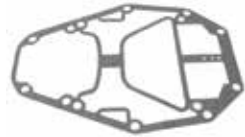

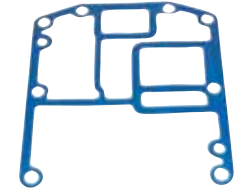

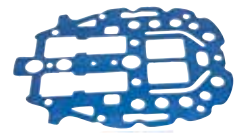





① Priced per Package

② This product is priced per piece. To order priced per package, please add -9 to the part number

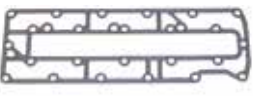

 <p>18-3675 THERMOSTAT GASKET Replaces: 27-8503181 For: 200-250HP 3.0L, (DFI and EFI)</p>	<p>PKG. OF 2</p>  <p>18-0922 18-0922-9① BAFFLE GASKET Replaces: 27-703351 3 Cyl.</p>	 <p>18-0940 BAFFLE GASKET Replaces: 27-854882</p>	 <p>18-0942 BAFFLE GASKET Replaces: 27-85491-2, 27-854913 45/50 HP</p>	 <p>18-0944 BAFFLE GASKET Replaces: 27-854961</p>
 <p>18-0232 COVER GASKET Replaces: 27-81031M</p>	<p>PKG. OF 2</p>  <p>18-2573 18-2573-9① WATER JACKET GASKET Replaces: 27-721421 6 Cyl.</p>	<p>PKG. OF 2</p>  <p>18-2574 18-2574-9① EXHAUST COVER GASKET Replaces: 27-854952 6 Cyl.</p>	<p>PKG. OF 2</p>  <p>18-2836 18-2836-9① BAFFLE GASKET Replaces: 27-78035 7.5-10 HP</p>	<p>PKG. OF 2</p>  <p>18-2839 18-2839-9① EXHAUST COVER GASKET Replaces: 27-854972</p>
 <p>18-0151 DIVIDER PLATE GASKET Replaces: 27-76636 V-6</p>	 <p>18-0642 DIVIDER PLATE GASKET Replaces: 27-190503</p>	<p>PKG. OF 2</p>  <p>18-2502 18-2502-9① DIVIDER PLATE GASKET Replaces: 27-904841 V-6</p>	 <p>18-0870 TRANSFER PORT COVER GASKET Replaces: 27-279361</p>	 <p>18-0926 TRANSFER PORT COVER GASKET Replaces: 27-73645</p>
 <p>18-0932 TRANSFER PASSAGE COVER GASKET Replaces: 27-768621 3 Cyl.</p>	 <p>18-0946 TRANSFER PORT GASKET Replaces: 27-85653-1, 27-856730 6 Cyl.</p>	<p>PKG. OF 3</p>  <p>18-2838 18-2838-9① TRANSFER PORT COVER GASKET Replaces: 27-552791</p>	 <p>18-0372 20 HP CYLINDER BLOCK GASKET Replaces: 27-78410</p>	 <p>18-2740 CYLINDER BLOCK GASKET Replaces: 27-430057 For: 65 Jet, 75HP 3 cyl, 90HP 3 cyl</p>
 <p>18-2943 CYLINDER BLOCK GASKET Replaces: 27-443284 For: 81 Jet, 100HP, 115HP, and 125HP 4 cyl outboards</p>	<p>PKG. OF 2</p>  <p>18-2500 18-2500-9① EXHAUST COVER GASKET Replaces: 27-85493 80 HP</p>	<p>PKG. OF 2</p>  <p>18-2505 18-2505-9① CYLINDER BLOCK GASKET Replaces: 27-961711 75-80 HP</p>	<p>PKG. OF 2</p>  <p>18-2507 18-2507-9① CYLINDER BLOCK GASKET Replaces: 27-85487 40-50 HP</p>	<p>PKG. OF 2</p>  <p>18-2805 18-2805-9① CYLINDER BLOCK COVER GASKET Replaces: 27-85490-2 35-40 HP</p>
<p>PKG. OF 2</p>  <p>18-2504 18-2504-9① BLOCK COVER GASKET Replaces: 27-88449 3 Cyl.</p>	<p>PKG. OF 2</p>  <p>18-2806 18-2806-9① CYLINDER COVER GASKET Replaces: 27-65788 V-6</p>	<p>PKG. OF 2</p>  <p>18-2807 18-2807-9① BLOCK COVER GASKET Replaces: 27-981853 90-115 HP</p>	<p>PKG. OF 2</p>  <p>18-2808 18-2808-9① CYLINDER COVER GASKET Replaces: 27-96278 V-6</p>	<p>PKG. OF 2</p>  <p>18-2809 18-2809-9① CYLINDER COVER GASKET Replaces: 27-437792 50-60-HP</p>

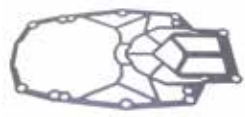
SEE PAGES 166-167 FOR OUR COMPLETE LINE OF GASKET SEALANTS

① Priced per Package

<p>PKG. OF 2</p>  <p>18-2810 18-2810-9① BLOCK COVER GASKET Replaces: 27-437772 45-50 HP</p>	<p>PKG. OF 2</p>  <p>18-2837 18-2837-9① BLOCK COVER GASKET Replaces: 27-41382</p>	 <p>18-0333 POWERHEAD BASE GASKET Replaces: 27-39401</p>	 <p>18-0334 MOUNTING PLATE TO DRIVESHAFT HOUSING GASKET Replaces: 27-39402</p>	 <p>18-0336 ADAPTER PLATE GASKET Replaces: 27-41670-3, 27-41670-5 18 HP</p>
<p>18-0649 SHIFT ROD HOUSING GASKET Replaces: 27-858935 For: 200 HP T801000 & UP, 200 HP OPTIMAX DFI G438000 & UP, 225 HP EFI G438000 & UP, 225 HP OPTIMAX DFI G590000-G960499, 250 HP EFI G438000 & UP, (MODELS WITH "C-3 CASTING": 200 HP OPTIMAX DFI G386496-G437999, 225 HP D280813-G437999, 225 HP EFI G129222-G437999, 250 HP EFI G129222-G437999)</p> 	 <p>18-0341 EXHAUST PLATE GASKET Replaces: 27-430086 For: 70-90, 100, 115 & 125 HP</p>	 <p>18-0791 SHIFT SHAFT COVER GASKET Replaces: 27-880729 For: All Verado's 135/150/175/200 225/250/275</p>	 <p>18-0369 POWERHEAD BASE GASKET Replaces: 27-75909 V-6</p>	 <p>18-0378 POWERHEAD BASE GASKET Replaces: 27-823142, 27-823142 2</p>
 <p>18-0670 POWERHEAD BASE GASKET Replaces: 27-430075</p>	 <p>18-0385 POWERHEAD BASE GASKET Replaces: 27-89937 4.5-9.8 HP</p>	 <p>18-0643 POWERHEAD BASE GASKET Replaces: 27-18307-1, 27-183076</p>	 <p>18-0879 ADAPTER PLATE GASKET Replaces: 27-385011</p>	 <p>18-0904 POWERHEAD BASE GASKET Replaces: 27-60317 65 HP</p>
 <p>18-0135 ADAPTER COVER GASKET Replaces: 27-78246, 27-78246 1</p>	 <p>18-0103 POWERHEAD BASE GASKET Replaces: 27-796501</p>	 <p>18-0139 POWERHEAD BASE GASKET Replaces: 27-884511</p>	 <p>18-2735 DIVIDER PLATE GASKET Replaces: 27-190506 For: 140 Jet, 115-200HP (2.5L), XR-6</p>	 <p>18-2713 DRIVESHAFT HOUSING GASKET Replaces: 27-433374 For: 15-25 2 cyl</p>
 <p>18-2714 EXHAUST COVER GASKET Replaces: 27-41499-5 For: 15-25 HP, 2 Cyl.</p>	 <p>18-2716 EXHAUST COVER GAS-KET Replaces: 27-414991 For: 18XD, 20XD (2 cyl), 25XD</p>	 <p>18-2741 EXHAUST COVER PLATE GASKET Replaces: 27-43004-7 For: 65 Jet, 75HP 3 cyl, 90HP 3 cyl</p>	 <p>18-2717 EXHAUST MANIFOLD GASKET Replaces: 27-41475-8 For: 15-25HP 2 cyl</p>	 <p>18-0319 POWERHEAD BASE GASKET Replaces: 27-828553 For: 30-60HP 2 cyl and 3 cyl</p>
 <p>18-2610 OUTER EXHAUST PLATE GASKET Replaces: 27-812775-4 For: 81 Jet, 100HP, 115HP, and 125HP 4 cyl outboards</p>	 <p>18-2739 EXHAUST PLATE GASKET Replaces: 27-832933-5 For: 250XS (3.0L) DFI</p>	 <p>18-2611 INNER EXHAUST PLATE GASKET Replaces: 27-812775-5 For: 80 Jet, 100HP, 115HP, and 125HP 4 cyl outboards</p>	 <p>18-0912 DRIVE SHAFT HOUSING PLATE GASKET Replaces: 27-661021</p>	<p>SEE PAGES 166-167 FOR OUR COMPLETE LINE OF GASKET SEALANTS</p>

① Priced per Package

 <p>18-0934-1 POWERHEAD BASE GASKET Replaces: 27-78069</p>	 <p>18-0988 POWERHEAD BASE GASKET Replaces: 27-628601</p>	<p>PKG. OF 2</p>  <p>18-2503 18-2503-9^① DRIVE SHAFT HOUSING TO EXHAUST PLATE GASKET Replaces: 27-99177-1, 27-99177 2 V-6</p>	<p>PKG. OF 2</p>  <p>18-2506-1 18-2506-1-9^① EXHAUST PLATE GASKET Replaces: 27-99176-3, 27-99176 4 V-175/V-200</p>	<p>PKG. OF 2</p>  <p>18-2508-1 18-2508-1-9^① EXHAUST PLATE GASKET Replaces: 27-997761 V-135/V-150</p>
<p>PKG. OF 2</p>  <p>18-2511 18-2511-9^① DRIVE SHAFT HOUSING TO EXHAUST PLATE GASKET Replaces: 27-99173-2 V-6</p>	<p>PKG. OF 2</p>  <p>18-2835 18-2835-9^① POWERHEAD BASE GASKET Replaces: 27-692381 52-90-115-140 HP</p>	<p>PKG. OF 2</p>  <p>18-2846 POWERHEAD GASKET Replaces: 27-47257</p>	<p>PKG. OF 2</p>  <p>18-0182 18-0182-9^① THERMOSTAT GASKET Replaces: 27-62386</p>	 <p>18-0323 THERMOSTAT GASKET Replaces: 27-14318-2, 27-14318 3</p>
 <p>18-0339 THERMOSTAT GASKET Replaces: 27-43006-2 70-90 HP</p>	 <p>18-0835 THERMOSTAT GASKET Replaces: 27-824853 Fits: Mercury 9.9-60 H.P., 4-Stroke</p>	<p>PKG. OF 2</p>  <p>18-0914 THERMOSTAT GASKET Replaces: 27-66847</p>	 <p>18-1508 THERMOSTAT SEAL Replaces: 25-8071341 Fits: Vazer (2007 & UP), GM V6 & V8 with closed cooling systems (1996 & UP)</p>	<p>PKG. OF 2</p>  <p>18-0936 18-0936-9^① RELIEF VALVE PLATE GASKET Replaces: 27-78690 V-6</p>
<p>PKG. OF 2</p>  <p>18-0952 18-0952-9^① RELIEF VALVE PLATE GASKET Replaces: 27-88907 V-6</p>	<p>PKG. OF 2</p>  <p>18-2558 18-2558-9^① IMPELLER GASKET 6/8/9.9/15 Replaces: 27-19204-2</p>	<p>PKG. OF 2</p>  <p>18-0292 WEAR PLATE TO PUMP HOUSING GASKET Replaces: 27-81417M</p>	<p>PKG. OF 2</p>  <p>18-0294 18-0294-9^① WEAR PLATE TO PUMP BASE GASKET Replaces: 27-81421M</p>	<p>PKG. OF 2</p>  <p>18-2559 18-2559-9^① IMPELLER GASKET 6/8/9.9/15 Replaces: 27-42206, 27-19202</p>
<p>PKG. OF 2</p>  <p>18-2561 18-2561-9^① IMPELLER GASKET 18/25 S/N 6443972 & Below Replaces: 27-85087</p>	<p>PKG. OF 2</p>  <p>18-2562 18-2562-9^① IMPELLER GASKET 18/20/25 S/N 6443973 & Above Replaces: 27-993261</p>	<p>PKG. OF 2</p>  <p>18-2563 18-2563-9^① IMPELLER GASKET 70/75/80/90/100/115 Replaces: 27-430341</p>	<p>PKG. OF 2</p>  <p>18-2564 18-2564-9^① IMPELLER GASKET 70/75/80/90/100/115 Replaces: 27-430331</p>	<p>PKG. OF 2</p>  <p>18-2565 18-2565-9^① IMPELLER GASKET 70/75/80/90/100/115 Replaces: 27-430472</p>

SEE PAGES 166-167 FOR OUR COMPLETE LINE OF GASKET SEALANTS

^① Priced per Package

PKG. OF 2



18-2566
18-2566-9①
IMPELLER GASKET
 75/90/100/115
 Replaces: 27-817277

PKG. OF 2



18-2801
18-2801-9①
WATER PUMP GASKET
 Replaces: 27-32438
 4-6 Cyl.

PKG. OF 2



18-2823
18-2823-9①
LOWER, WATER PUMP GASKET
 Replaces: 27-32769,
 27-19553
 40-50-70 HP

PKG. OF 2

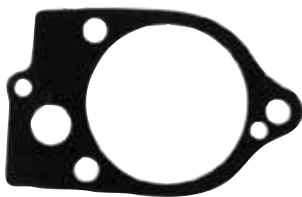

18-2824
18-2824-9①
UPPER, WATER PUMP GASKET
 Replaces: 27-32770,
 27-19551

PKG. OF 2



18-2825
18-2825-9①
WATER PUMP BASE GASKET
 Replaces: 27-32771
 40-50-70

PKG. OF 2



18-2826
18-2826-9①
WATER PUMP BASE GASKET
 Replaces: 27-85610 1,
 27-85670 4

PKG. OF 2



18-2827
18-2827-9①
UPPER FACE PLATE GASKET
 Replaces: 27-39623
 20 HP

PKG. OF 2



18-2828
18-2828-9①
LOWER WATER PUMP GASKET
 Replaces: 27-39625
 20 HP



18-0622
LOWER WEAR PLATE GASKET
 Replaces: 27-19701



18-2593
WATER PUMP GASKET
 Replaces: 27-194541
 For: 45 Jet, 50HP, 55HP, 60HP
 3 cyl outboards



18-0345
WATER PUMP GASKET
 Replaces: 27-822189
 For: 25-60HP outboards,
 2, 3 cyl. & 4 stroke models

PKG. OF 2



18-2841
18-2841-9①
WATER PUMP BASE GASKET
 Replaces: 27-77417,
 27-19552

SEE PAGES 166-167 FOR OUR COMPLETE LINE OF GASKET SEALANTS

① Priced per Package

<p>PKG. OF 2</p>  <p>18-2914 18-2914-9① WATER PUMP GASKET Replaces: 27-856081</p>	<p>PKG. OF 2</p>  <p>18-2915 18-2915-9① WATER PUMP GASKET Replaces: 27-85609-1, 27-858524</p>	<p>PKG. OF 2</p>  <p>18-2919 18-2919-9① WATER PUMP GASKET Replaces: 27-426311</p>
 <p>18-0514 WATER TUBE RUBBER SEAL Replaces: 26-25329</p>	 <p>18-0521 WATER TUBE RUBBER SEAL Replaces: 26-36557</p>	 <p>18-0539 EXHAUST LEG RUBBER SEAL Replaces: 37721</p>
 <p>18-0563 WATER TUBE RUBBER SEAL Replaces: 26-36556</p>	<p>PKG. OF 2</p>  <p>18-2560 18-2560-9① IMPELLER GASKET 18/20/25 Replaces: 12-86645, 12-86645 1</p>	<p>PKG. OF 2</p>  <p>18-2430 18-2430-9① 18-24301-9① (PKG. OF 50) DRAIN SCREW GASKET Mercury 26-830749 For: All Verado</p>

 <p>18-2728 WATER TUBE SEAL Replaces: 26-421021</p>	<p>PKG. OF 2</p>  <p>18-2945 18-2945-9① DRAIN SCREW GASKET Replaces: 12-20260, 12-19183, 12-19183 2 Used in most lower units and sea water pumps</p>	<p>PKG. OF 2</p>  <p>18-2948 18-2948-9① RUBBER WASHER Replaces: 12-49221-1, 12-49221 For plastic flush screw and fuel tank vent</p>	<p>PKG. OF 2</p>  <p>18-4858-9① WASHER Replaces: 12-45176 Fits: Mercury Outboard 25 H.P. and Up, Mercuriser #1, R, MR, Alpha I Gen II and Bravo Drive Units</p>
--	--	--	--

SEE PAGES 166-167 FOR OUR COMPLETE LINE OF GASKET SEALANTS

① Priced per Package

 18-4261 WASHER Replaces: 19643	PKG. OF 4  18-0568-9^③ INSULATOR BUSHING Replaces: 23-43045	 18-8305 DIVIDER PLATE SEAL Replaces: 26-814754
 18-8309 WATER COOLED REGULATOR SEAL Replaces: 18717	 18-4698 18-46981-9^③ (PKG. OF 50) DRAIN FILL WASHER Replaces: 27-81987M	 18-4275 WASHER Replaces: 12-29245
 18-4915 STARTER ROPE Replaces: 50-12066A9, 50-12066Q9	 18-6506 REWIND SPRING Replaces: 24-29340A1, T1	

REWIND SPRING APPLICATION

Model/HP	Beg S/N	End S/N	Rewind Spring	Model/HP	Beg S/N	End S/N	Rewind Spring
Merc 4	2498136	4107219	18-6506	Merc 35	1217222	1271884	18-6506
Merc 4.5	4107220	& UP	18-6506	Merc 35	1356948	1448139	18-6506
Merc 6	1408611	2387383	18-6506	Merc 35	1571114	1960826	18-6506
Merc 7.5	2529895	& UP	18-6506	Merc 35	1960827	2097279	—
Mar 8	M-677-000101	& UP	—	Merc 35	2097832	2258863	—
Merc 9.8		ALL	18-6506	Merc 35	2300962	2453068	—
Mar 9.9	M-682-000551	M-682-032885	—	Merc 35	2487558	2874703	—
Mark (10) 10		ALL	18-6506	Merc 35	6445653	& UP	—
Merc 10	1290910	1455239	18-6506	Mark (55) 40	831021	&UP	18-6506
Mark (15) 15		ALL	18-6506	Merc 40	1279685	1476509	18-6506
Merc 15	1288910	1349697	18-6506	Mar 40		ALL	—
Mar15	M-684-000101	& UP	—	Merc 40	2874704	3336257	—
Merc 20	3537531	6443972	18-6506	Merc 40	3326258	& UP	—
Merc 20	1292910	3537530	18-6506	Merc 40	C159200	& UP	—
Mar 20	M-653-07615	& BELOW	—	Mark (58) 45	1139538	& UP	18-6506
Mar 20	M-653-07616	& UP	—	Merc 45	1476510	1531568	18-6506
Mar 20	M-6A9-000101	& UP	—	Merc 50	1421113	2116317	18-6506
Mark (28) 22		ALL	18-6506	Merc 50	5531630	& UP	— ^②
Merc 25	1467499	1499331	18-6506	Merc 50	1770179	& UP	—
Mar 25	M-648-19025	& BELOW	—	Mark (75) 60		ALL	18-6506
Mar 25	M-695-000101	& UP	—	Merc 60		ALL	18-6506
Mar 28		ALL	—	Merc 65	1542745	1765043	18-6506
Merc 30	1271885	1356947	18-6506	Mark (78) 70		ALL	18-6506
Mar 30		ALL	18-6521	Merc 70		ALL	18-6506

① Above Prop Exhaust ② 4 cyl. only

③ Priced per Package



**THERE ARE NO SURPRISES WITH
THE SIERRA WARRANTY.**

We are dedicated to protecting you and
your investment.
We've got you covered because we believe
your boat should always be running.

the best in the business

Sierra
Marine Engine and Drive Parts

WARRANTY

ENGINE & DRIVE PARTS - SWITCHES - MARINE HOSE - INSTRUMENTATION

35 & 40 2 Cylinder

Serial # 2736807-G053313

50, 60, 65 3 Cylinder

Serial # 3293184-D000749

70 3 Cylinder

Serial # 4571652-6428680

40, 45, 50 4 Cylinder

Serial # 4357640 & later

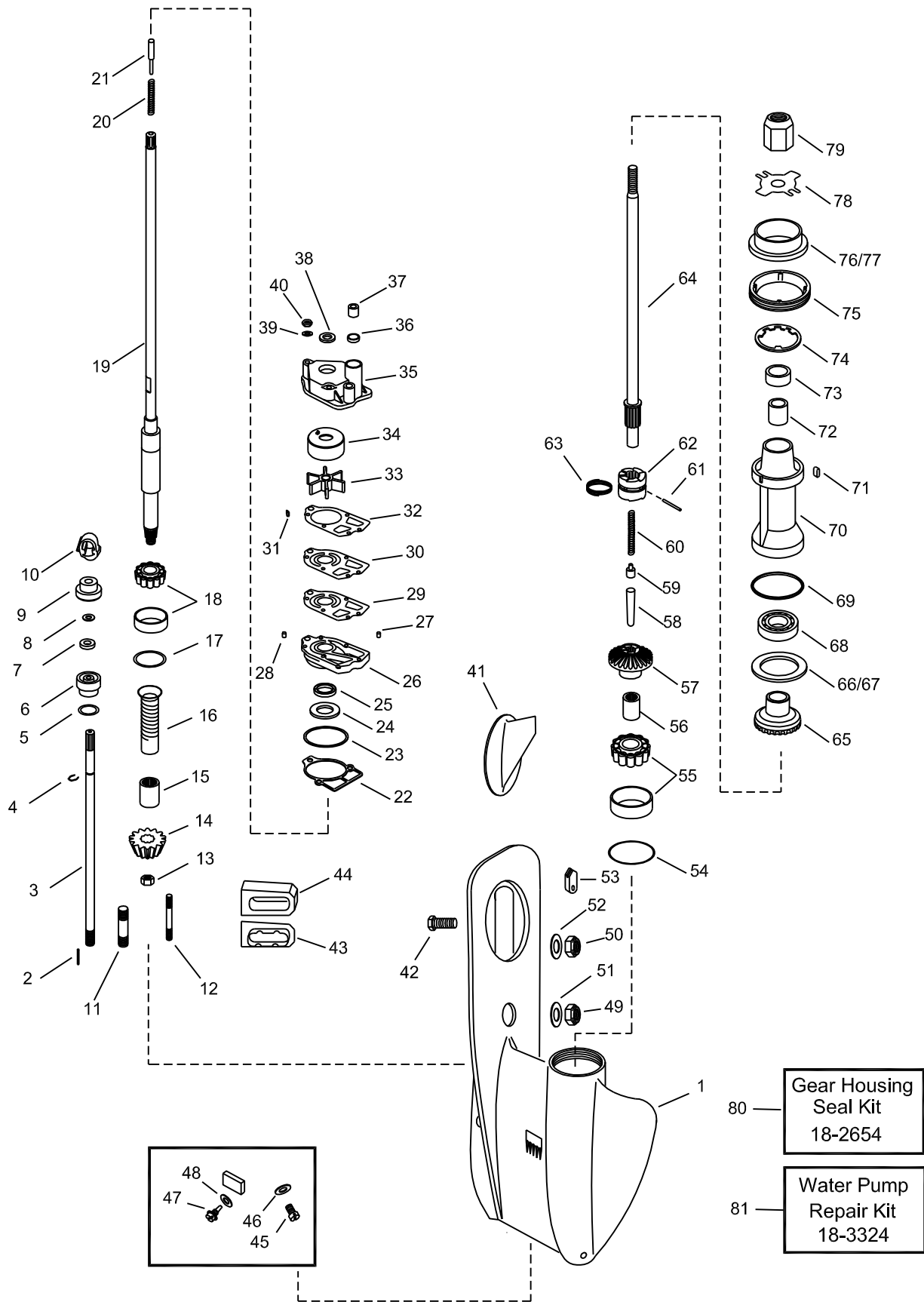

Figure #	Description	Part #	O.E.M. #	Qty.	Figure #	Description	Part #	O.E.M. #	Qty.
1	Gear Housing	—	1643-9539A1	1	48	Flush Plug Washer	18-2948	12-492211	1
2	Dowel Pin	—	17-85500	2	49	Nut	18-2361	11-34933	1
3	Shift Shaft	—	76163A1	1	50	Nut	—	1134863	1
4	E-Clip	18-4295	53-29641	1	51	Washer	—	12-65791	1
5	O-Ring	18-7153	25-21836	1	52	Washer	—	12-45175	1
6	Shift Shaft Bushing	18-2155	23-77631A2	1	53	Shift Cam	—	76039	1
7	Seal	18-2054	26-816461	1	54	Shim Set	—	15-38374A1	AR
8	Washer	18-2316	12-77674	1	55	Tapered Roller Bearing	18-1162	31-38356A1	1
9	Reverse Lock Base	—	78036	1	56	Roller Bearing	18-1096	31-21739	1
10	Reverse Lock Cam	—	433081	1	57	Forward Gear	—	43-55608A4	1
11	Stud	—	16-33778	3	58	Cam Follower	—	38441	1
12	Stud	—	16-57933	2	59	Slide	—	20843	1
13	Pinion Nut	—	11-55910	1	60	Spring	—	24-38114	1
14	Pinion Gear	—	43-98097	1	61	Cross Pin	—	17-38113	1
15	Roller Bearing	—	31-62091	1	62	Clutch	—	52-92911	1
16	Sleeve	—	88181	1	63	Spring	—	24-39845	1
17	Shim Set	—	15-92881A1	AR	64	Prop Shaft	—	44-75365	1
18	Tapered Bearing	—	31-77420A1	1	65	Reverse Gear	—	43-79158	1
19	Drive Shaft	—	45-981801	1	66	Thrust Washer	—	12-32004	1
20	Spring	—	24-20254	1	67	Shim Set	—	15-20927A1	AR
21	Pin	—	17-30545	1	68	Ball Bearing	18-1190	30-20839T	1
22	Gasket	18-2841	27-19552	1	69	O-Ring	18-7160	2531986	1
23	O-Ring	18-7115	25-26722	1	70	Bearing Carrier	—	69386A1	1
24	Seal	18-2055	26-79831	1	71	Key	—	28-30281	1
25	Seal	18-2011	26-90562	1	72	Roller Bearing	18-1095	3121700	1
26	Water Pump Base	18-3424	46-77177A1	1	73	Seal	18-2051,	26-69188,	
27 & 28	Pin, Dowel	—	17-35973	1			18-2052	26-619189	1
29	Gasket	18-2823	27-19553	1	74	Tab Washer	—	14-53012	1
30	Face Plate	18-3107	54705	1	75	Cover Nut	—	11-87763	1
31	Key	—	28-56662	1	76	Thrust Hub	18-4233	73345A1	1
32	Gasket	18-2824	27-19551	1	77	Thrust Hub	18-3204	14-76281	1
33	Impeller	18-3007	47-89983	1	78	Tab Washer	18-3204	14-76281	1
34	Insert	18-3115	48753	1	79	Nut	18-3702	11-69578A	1
35	Water Pump body	18-3118	46-77822A1	1	80	Gear Housing Seal Kit	18-2654	26-79831A1	1
36	Nylon Washer	—	12-38453	1	81	Water Pump Repair Kit	18-3324	46-77177A3	1
37	Seal	—	26-38452	1					
38	Slinger	—	25-20273	1					
39	Washer	18-4275	12-29245	3					
40	Nut	—	11-13438	3					
41	Trim Tab	18-6011	31640A1	1					
42	Screw	—	10-66024	1					
43	Support Plate	—	92815	1					
44	Exhaust Tube Seal	18-0539	37721	1					
45	Drain Plug	18-2244	10-79953	2					
46	Washer	18-2945	12-19183	2					
47	Flush Plug	—	19-48750	1					

AR As required

70, 75, 80, 90

Serial # A996142 & later

100, 115, 125 4 Cylinder

Serial # B209468 & later

68 — Gear Housing Seal Kit 18-2626

69 — Water Pump Repair Kit 18-3214

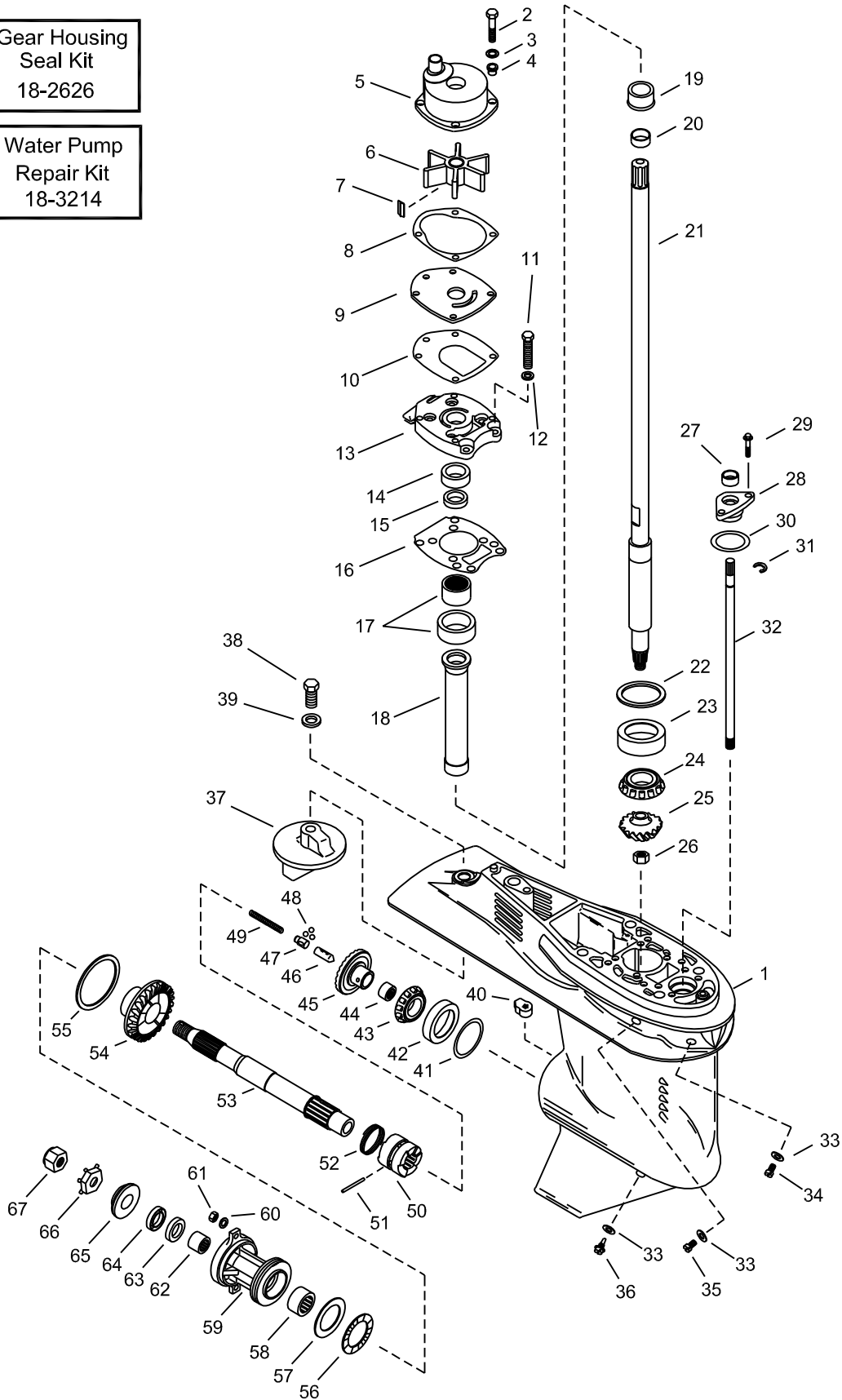

Figure #	Description	Part #	O.E.M. #	Qty.	Figure #	Description	Part #	O.E.M. #	Qty.
1	Gear Housing	—	1667-9011A73	1	49	Spring	—	24-30622	1
2	Screw	—	10-8248327	4	50	Clutch	18-2236	52-822539	1
3	Washer	18-4275	12-29245	4	51	Cross Pin	18-2357	17-30632	1
4	Insulator	18-0568	23-43045	4	52	Spring	18-2348	24-30893	1
5	Water Pump Housing	18-3572	817275A2	1	53	Prop Shaft	—	44-12238T	1
6	Impeller	18-3056	47-430262	1	54	Reverse Gear	—	43-12635	1
7	Impeller Key	18-3293	28-43037	1	55	O-Ring	18-7961	25-97386	1
8	Gasket	18-2566	27-817277	1	56	Thrust Bearing	18-1112	31-12576	1
9	Face Plate	18-3122	817276	1	57	Thrust Washer	18-1191	12-12577	1
10	Gasket	18-2564	27-430331	1	58	Roller Bearing	18-1113	31-12578	1
11	Screw	—	10-824832-6	6	59	Bearing Carrier	—	12596A2	1
12	Washer	18-4275	12-29245	6	60	Washer	—	12-70132	2
13	Pump Base	—	43055A4	1	61	Nut	—	11-401198	2
14	Seal	18-0583	26-43035	1	62	Roller Bearing	18-1158	31-30956	1
15	Seal	18-0522	26-43036	1	63	Seal	18-2002	26-76868	1
16	Gasket	18-2565	27-430472	1	64	Seal	18-2053	26-70081	1
17	Carrier w/Bearing	—	43040A1	1	65	Thrust Washer	18-4221	13191A1	1
18	Tube, Oiler	—	43046	1	66	Tab Washer	18-3200	14-31210	1
19	Sleeve	—	42461A1	1	67	Prop Nut	18-3700	11-52707	1
20	Ring	—	42461A1	1					
21	Drive Shaft	—	45-43031A1	1					
22	Shim Assembly	—	15-44492A1	AR					
23	Race (sold with #24)	18-1118	31-42677A1	1					
24	Bearing (sold with #23)	18-1118	31-42677A1	1					
25	Pinion Gear	—	43-44484	1					
26	Pinion Nut	18-3719	11-35921	1					
27	Seal	18-2054	26-8164641	1					
28	Bushing Assembly	—	23-43052A4	1					
29	Screw	—	10-824832-6	2					
30	O-Ring	18-7198	25-45710	1					
31	E-Ring	18-4295	53-29641	1					
32	Shift Shaft	—	43048A1	1					
33	Gasket	18-2945	12-19183	3					
34	Plug	—	10-28653	1					
35	Plug	18-2244	10-79953	1					
36	Plug	18-2375	22-67892A1	1					
37	Trim Tab	18-6011	31640A1	1					
38	Bolt, Anode Mounting	—	10-15942	1					
39	Washer, Anode Mounting	18-4858-9	12-45176	1					
40	Shim Cam	—	76039	1					
41	Shim Assembly	—	15-44491A1	AR					
42 & 43	Bearing & Race	18-1156	13-30894A1	1					
44	Roller Bearing	18-1157	31-30895	1					
45	Forward Gear	—	43-12634A2	1					
46 & 47	Cam Follower Assembly	—	12239A1	1					
48	Ball Bearing	—	30-44530	3					

AR As required

V-150

Serial # A904645 & earlier

V-175

Serial # 6648750 & earlier

V-200

Serial # 6625220 & earlier

86 — Gear Housing Seal Kit
18-2653

87 — Water Pump Repair Kit
(with housing)
18-3217

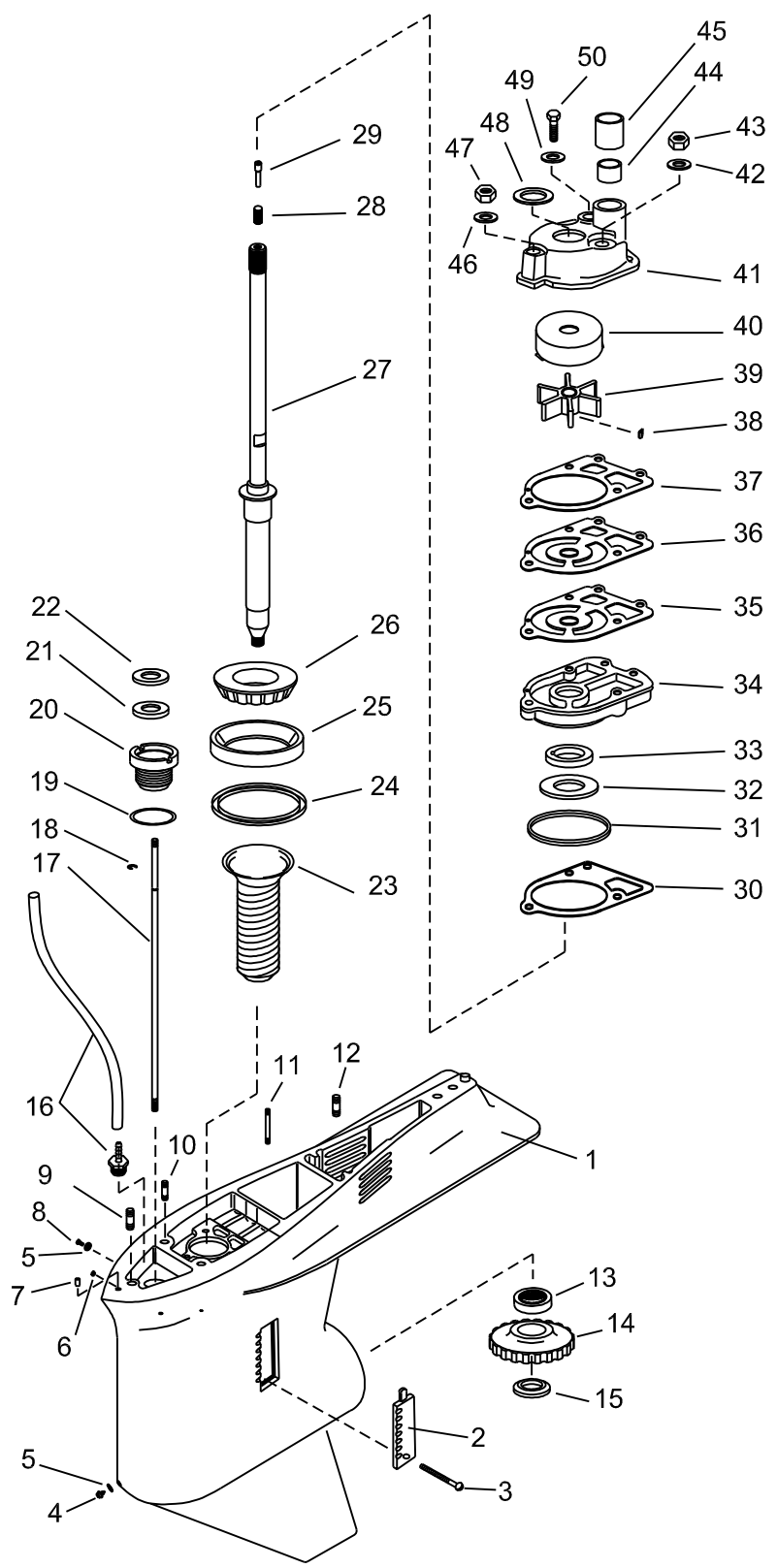

Complete Gear Housings Listed on Page 379

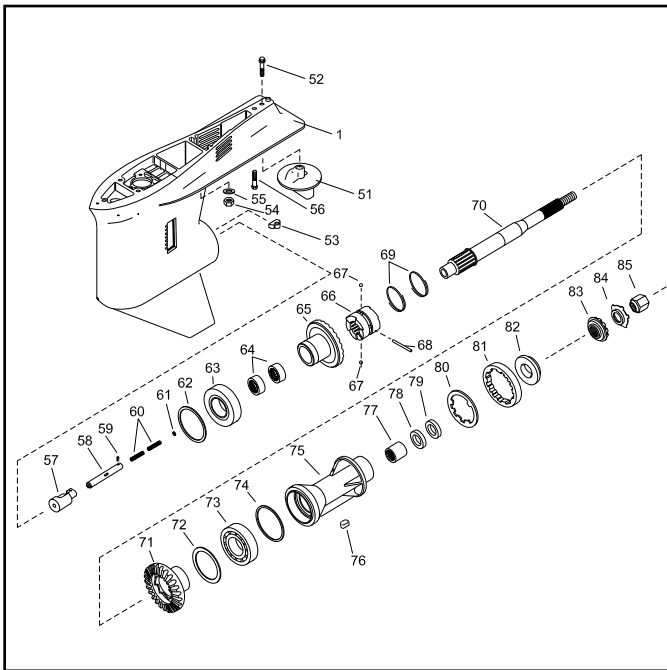

Figure #	Description	Part #	O.E.M. #	Qty.
34	Water Pump Base	18-3416	46-96146A6	1
35	Gasket	18-2914	27-856081	1
36	Face Plate	18-3117	32435	1
37	Gasket	18-2915	27-856091	1
38	Key	~	28-56654	1
39	Impeller	18-3017	47-899842	1
40	Insert	18-3114	48752	1
41	Water Pump Body	18-3116	43-96148A1	1
42	Washer	18-4275	12-29245	3
43	Nut	18-3722	11-20361	2
44	Seal	18-3110	26-38970	1
45	Guide Sleeve	18-3109	23-29804	1
46	Washer	18-4270	12-36001	1
47	Nut	18-3722	11-45592	1
48	Slinger	18-7426	25-30271	1
49	Washer	18-4275	12-29245	3
50	Screw	~	10-96411	1
51	Trim Tab	18-6011	3164A1	1
52	Screw	~	10-66024	1
53	Shift Cam	~	78956	1
54	Nut	18-3721	11-34933	1
55	Washer	~	12-45176	2
56	Screw	~	10-65210	1
57	Cam Follower	~	89594A1	1
58	Actuator Rod	~	79911 1	1
59	Locating Pin	~	17-78906	1
60	Spring	~	24-749910	2
61	Washer	~	12-78910	1
62	Shim Assembly	18-2285	15-47397A1	AR
63	Bearing	18-1166	31-78172A1	1
64	Forward Gear	~	43-78082A3	1
65	Roller Bearing	18-1122	31-73363	2
66	Clutch	~	52-823174	1
67	Detent Pin	~	17-78909	2
68	Cross Pin	~	17-78905	1
69	Retaining Spring	~	24-78962	2
70	Prop Shaft	18-2239	44-94148	1
71	Reverse Gear	~	43-85462	1
72	Thrust Ring	~	68100 1	1
73	Ball Bearing	18-1155	30-88957	1
74	O-Ring	18-7159	25-31534	1
75	Bearing Carrier	18-1567	43567T1	1
76	Key	~	28-30281	1
77	Roller Bearing	18-1158	31-30956	1
78	Seal (Inner)	18-2002	26-76868	1
79	Seal (Outer)	18-2053	26-70081	1
80	Tab Washer	18-2299	14-79447	1
81	Cover Nut	18-3751	79448	1
82	Thrust Hub	18-4220	13171	1
83	Spline Washer	18-3714	12-31211A2	1
84	Tab Washer	18-3200	14-31210	1
85	Prop Nut	18-3700	11-52707	1

Figure #	Description	Part #	O.E.M. #	Qty.
1	Gear Housing	~	1647-9148A65	1
2	Water Insert (Starboard)	~	66885	1
	Water Insert (Port)	~	66884	1
3	Screw	18-3197	10-76156	1
4	Drain Screw	18-2375	22-67892A1	1
5	Washer	18-2945	12-19183	2
6	Nut	18-2344	11-45812	1
7	Dowel Pin	~	17-43044	2
8	Vent Screw	18-2244	10-79953	1
9	Stud	~	16-78638	1
10	Stud	~	16-56297	1
11	Stud	~	16-30667	2
12	Stud	~	16-579201	2
13	Roller Bearing	~	31-35934A1	1
14	Pinion Gear	~	43-780811	1
15	Pinion Nut	18-3719	11-35921	1
16	Speedometer Tube	~	22-85822A10	1
17	Shift Shaft	~	78902 2	1
18	E-Clip	18-4295	53-29641	1
19	O-Ring	18-7153	25-21836	1
20	Shift Shaft Bushing	18-2155	23-77631A2	1
21	Seal	18-2054	26-816461	1
22	Rubber Washer	18-2316	12-77674	1
23	Sleeve	~	23-98621	1
24	Shim Assembly	18-2295	15-57007A1	AR
25	Roller Bearing	18-1164	31-53079A1	1
26	Roller Bearing	18-1164	31-53079A1	1
27	Drive Shaft Assembly	~	45-98682A1	1
28	Spring	~	24-34576	1
29	Pin	~	17-30545	1
30	Gasket	18-2826	27-856101	1
31	O-Ring	18-7162	25-33145	1
32	Seal	18-2014	26-89238	1
33	Seal	18-2013	26-16977	1

AR As required

 <p>18-1190 BALL BEARING Replaces: 30-20839T Reverse gear for Force, Mercury, Mariner from 25-60HP (2, 3 cylinders, & 4-stroke) including 30Jet - 45Jet</p>	 <p>18-1191 THRUST WASHER Replaces: 12-12577 30-125HP</p>	 <p>18-1112 REVERSE GEAR THRUST BEARING Replaces: 31-12576</p>	 <p>18-1113 REVERSE GEAR BEARING Replaces: 31-12578, 31-12578T</p>
 <p>18-1115 PINION BEARING Replaces: 31-32898, 31-32898T</p>	 <p>18-1117 PINION BEARING Replaces: 31-42647A1</p>	 <p>18-1118 DRIVE SHAFT BEARING Replaces: 31-42677A1</p>	 <p>18-1121 DRIVE SHAFT BEARING Replaces: 31-69220, 31-69220T</p>
 <p>18-1122 INSIDE FORWARD GEAR BEARING Replaces: 31-73363, 31-73363T</p>	 <p>18-1143 TAPERED ROLLER BEARING Replaces: 31-36387A1</p>	 <p>18-1144 BEARING ASSEMBLY Replaces: 31-48939A2</p>	 <p>18-1153 BALL BEARING Replaces: 30-63326, 30-63326T</p>
 <p>18-1154 BALL BEARING Replaces: 30-63742, 30-63742T</p>	 <p>18-1155 BALL BEARING Replaces: 30-88957A1, 30-88957T</p>	 <p>18-1197 TAPERED ROLLER BEARING Replaces: 31-828439A2 Fits:Mercury/Mariner 200 (3.0L DFI), 225 (3.0L Carb), 225/250 (3.0L EFI) S/N G437999 & Below</p>	 <p>18-1156 FORWARD GEAR BEARING Replaces: 31-30894A1</p>
 <p>18-1157 FORWARD GEAR INNER BEARING Replaces: 31-30895, 31-30895T</p>	 <p>18-1158 CARRIER BEARING Replaces: 31-30956, 31-30956T</p>	 <p>18-1159 TAPERED ROLLER BEARING Replaces: 31-35928A1, 31-35928T1</p>	 <p>18-1162 TAPERED ROLLER BEARING Replaces: 31-38356A1</p>

APPLICATION BEGINS ON NEXT PAGE



**18-1164
TAPERED ROLLER
BEARING**
Replaces: 31-53079A1

**18-1166
TAPERED ROLLER
BEARING**
Replaces: 31-78172A1

**18-1170
LOWER PINION BEARING**
Replaces: 31-81276A1

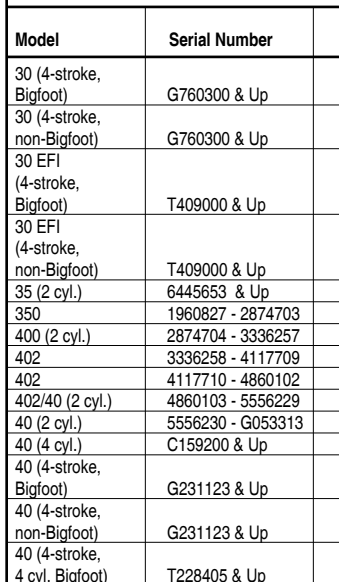

**18-0557
SEAL CARRIER**
Replaces: 888909A1
For: All Verado's
135/150/175/200/225/250/275

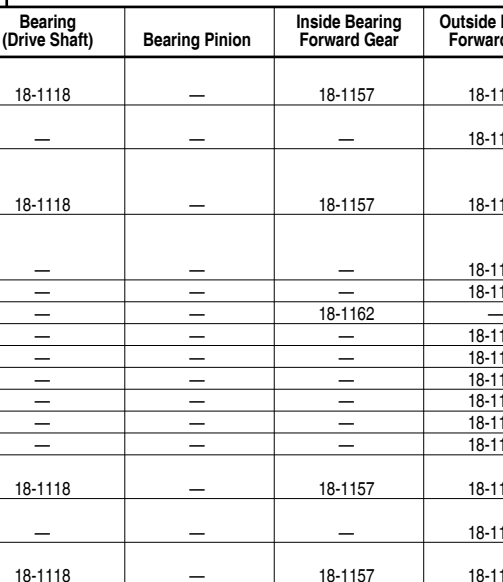

**18-1567
CARRIER BEARING**
Replaces: 43567T1
Fits: V-115 DFI 2.5L (2000), V-135 (1986 & Up),
V-135 DFI 2.5L (1998 & Up), V-150 (1978 & Up),
V-150 EFI (1996-01), V-150 DFI 2.5L (1998 & Up),
V-175 (1976-99), V-175 EFI (1996-01), V-175 DFI 2.5L
(2001 & Up), V-200 (1978 & Up), V-200 EFI (1989-01), V-200 EFI
2.5L (2002 & Up), XR-6 (1992-99)

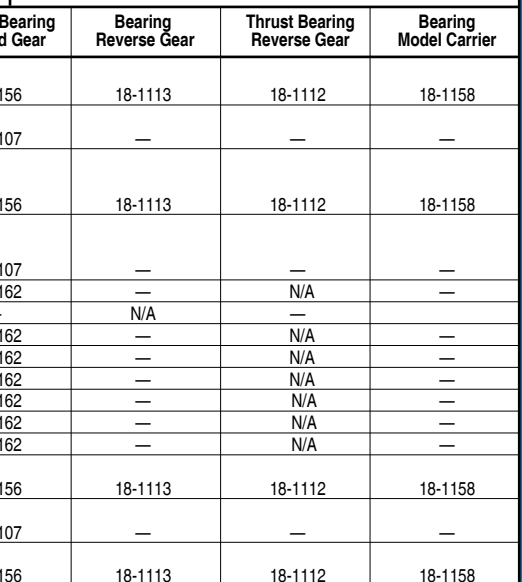

**18-2370
CARRIER BEARING**
Replaces: 19291A3
(Force 40/50 HP 1995-99, 70 HP 1991-95, 75 HP 1996-98)
(Mercury/Mariner 30/40 HP 2 cyl 9854537-P016999, 30/40
4-stroke G760300-up, 40/50 HP/30Jet 3 cyl 9973100-up, 60
HP 3 cyl D000750-up, 60 HP 4-stroke 9973100-up)

Model	Serial Number	Bearing (Drive Shaft)	Bearing Pinion	Inside Bearing Forward Gear	Outside Bearing Forward Gear	Bearing Reverse Gear	Thrust Bearing Reverse Gear	Bearing Model Carrier
30 (4-stroke, Bigfoot)	G760300 & Up	18-1118	—	18-1157	18-1156	18-1113	18-1112	18-1158
30 (4-stroke, non-Bigfoot)	G760300 & Up	—	—	—	18-1107	—	—	—
30 EFI (4-stroke, Bigfoot)	T409000 & Up	18-1118	—	18-1157	18-1156	18-1113	18-1112	18-1158
30 EFI (4-stroke, non-Bigfoot)	T409000 & Up	—	—	—	18-1107	—	—	—
35 (2 cyl.)	6445653 & Up	—	—	—	18-1162	—	N/A	—
350	1960827 - 2874703	—	—	18-1162	—	N/A	—	—
400 (2 cyl.)	2874704 - 3336257	—	—	—	18-1162	—	N/A	—
402	3336258 - 4117709	—	—	—	18-1162	—	N/A	—
402	4117710 - 4860102	—	—	—	18-1162	—	N/A	—
402/40 (2 cyl.)	4860103 - 5556229	—	—	—	18-1162	—	N/A	—
40 (2 cyl.)	5556230 - G053313	—	—	—	18-1162	—	N/A	—
40 (4 cyl.)	C159200 & Up	—	—	—	18-1162	—	N/A	—
40 (4-stroke, Bigfoot)	G231123 & Up	18-1118	—	18-1157	18-1156	18-1113	18-1112	18-1158
40 (4-stroke, non-Bigfoot)	G231123 & Up	—	—	—	18-1107	—	—	—
40 (4-stroke, 4 cyl. Bigfoot)	T228405 & Up	18-1118	—	18-1157	18-1156	18-1113	18-1112	18-1158
40 (4-stroke, 4 cyl. non-Bigfoot)	T228405 & Up	—	—	—	18-1170	—	—	—
40 EFI (4-stroke, 3 cyl. non-Bigfoot)	T409000 & Up	—	—	—	18-1103	18-1190	—	—
40 EFI (4-stroke, 3 cyl. Bigfoot)	T409000 & Up	18-1118	—	18-1157	18-1156	18-1113	18-1112	18-1158
40 EFI (4-stroke, 4 cyl. non-Bigfoot)	T409000 & Up	—	—	—	18-1170	—	—	—
45 (4 cyl.)	5531630 & Up	—	—	—	18-1162	—	N/A	—
45 (Bodensee 4-stroke, Bigfoot)	G231123 - T178499	18-1118	—	18-1157	18-1156	18-1113	18-1112	18-1158
45 (Bodensee 4-stroke, non-Bigfoot)	G231123 - T178499	—	—	—	18-1103	—	—	—
500	2305101 - 2858813	—	—	—	18-1162	—	N/A	—
500	2858814 - 4140999	—	—	—	18-1162	—	N/A	—
500	4141000 - 4357639	—	—	—	18-1162	—	N/A	—
500 / 50	4357640 - 4962055	—	—	—	18-1162	—	N/A	—
500 / 50	4962056 - 5531629	—	—	—	18-1162	—	N/A	—
50 (4 cyl.)	5531630 & Up	—	—	—	18-1162	—	N/A	—
50 (3 cyl.)	6428681 - D000749	—	—	—	18-1162	—	N/A	—
50 (3 cyl.)	D000750 - G589999	—	—	—	18-1170	—	N/A	—
50 (4-stroke, Bigfoot)	G231123 & Up	18-1118	—	18-1157	18-1156	18-1113	18-1112	18-1158
50 (4-stroke, non-Bigfoot)	G231123 & Up	—	—	—	18-1107	—	—	—

① Standard Rotation Only. ⑤ Two Bearings Required.
 ③ For Units With A Casting Number Of 1655-9572C Only. ⑥ For 5/8 Dual Bearing Application.
 ④ For Units With A Casting Number Of 1674-814247C Only. ⑦ Use 18-1155 For Counter Rotation Applications.

Model	Serial Number	Bearing (Drive Shaft)	Bearing Pinion	Inside Bearing Forward Gear	Outside Bearing Forward Gear	Bearing Reverse Gear	Thrust Bearing Reverse Gear	Bearing Model Carrier
30 (4-stroke, Bigfoot)	G760300 & Up	18-1118	—	18-1157	18-1156	18-1113	18-1112	18-1158
30 (4-stroke, non-Bigfoot)	G760300 & Up	—	—	—	18-1107	—	—	—
30 EFI (4-stroke, Bigfoot)	T409000 & Up	18-1118	—	18-1157	18-1156	18-1113	18-1112	18-1158
30 EFI (4-stroke, non-Bigfoot)	T409000 & Up	—	—	—	18-1107	—	—	—
35 (2 cyl.)	6445653 & Up	—	—	—	18-1162	—	N/A	—
350	1960827 - 2874703	—	—	18-1162	—	N/A	—	—
400 (2 cyl.)	2874704 - 3336257	—	—	—	18-1162	—	N/A	—
402	3336258 - 4117709	—	—	—	18-1162	—	N/A	—
402	4117710 - 4860102	—	—	—	18-1162	—	N/A	—
402/40 (2 cyl.)	4860103 - 5556229	—	—	—	18-1162	—	N/A	—
40 (2 cyl.)	5556230 - G053313	—	—	—	18-1162	—	N/A	—
40 (4 cyl.)	C159200 & Up	—	—	—	18-1162	—	N/A	—
40 (4-stroke, Bigfoot)	G231123 & Up	18-1118	—	18-1157	18-1156	18-1113	18-1112	18-1158
40 (4-stroke, non-Bigfoot)	G231123 & Up	—	—	—	18-1107	—	—	—
40 (4-stroke, 4 cyl. Bigfoot)	T228405 & Up	18-1118	—	18-1157	18-1156	18-1113	18-1112	18-1158
40 (4-stroke, 4 cyl. non-Bigfoot)	T228405 & Up	—	—	—	18-1170	—	—	—
40 EFI (4-stroke, 3 cyl. non-Bigfoot)	T409000 & Up	—	—	—	18-1103	18-1190	—	—
40 EFI (4-stroke, 3 cyl. Bigfoot)	T409000 & Up	18-1118	—	18-1157	18-1156	18-1113	18-1112	18-1158
40 EFI (4-stroke, 4 cyl. non-Bigfoot)	T409000 & Up	—	—	—	18-1170	—	—	—
45 (4 cyl.)	5531630 & Up	—	—	—	18-1162	—	N/A	—
45 (Bodensee 4-stroke, Bigfoot)	G231123 - T178499	18-1118	—	18-1157	18-1156	18-1113	18-1112	18-1158
45 (Bodensee 4-stroke, non-Bigfoot)	G231123 - T178499	—	—	—	18-1103	—	—	—
500	2305101 - 2858813	—	—	—	18-1162	—	N/A	—
500	2858814 - 4140999	—	—	—	18-1162	—	N/A	—
500	4141000 - 4357639	—	—	—	18-1162	—	N/A	—
500 / 50	4357640 - 4962055	—	—	—	18-1162	—	N/A	—
500 / 50	4962056 - 5531629	—	—	—	18-1162	—	N/A	—
50 (4 cyl.)	5531630 & Up	—	—	—	18-1162	—	N/A	—
50 (3 cyl.)	6428681 - D000749	—	—	—	18-1162	—	N/A	—
50 (3 cyl.)	D000750 - G589999	—	—	—	18-1170	—	N/A	—
50 (4-stroke, Bigfoot)	G231123 & Up	18-1118	—	18-1157	18-1156	18-1113	18-1112	18-1158
50 (4-stroke, non-Bigfoot)	G231123 & Up	—	—	—	18-1107	—	—	—
50 EFI (4-stroke, non-Bigfoot)	T409000 & Up	—	—	—	18-1107	—	—	—
50 EFI (4-stroke, Bigfoot)	T409000 & Up	18-1118	—	18-1157	18-1156	18-1113	18-1112	18-1158
55 (3 cyl.)	D000750 - G589999	—	—	—	18-1170	—	N/A	—
55 Seapro, Marathon, Pontoon	D000750 & Up	18-1118	—	18-1157	18-1156	18-1113	18-1112	18-1158
60 (3 cyl.)	6428681 - D000749	—	—	—	18-1162	—	N/A	—
60 (3 cyl.)	D000750 - G589999	—	—	—	18-1170	—	N/A	—
60 EFI (4-stroke, non-Bigfoot)	T409000 & Up	—	—	—	18-1103	—	—	—
60 EFI (4-stroke, Bigfoot)	T409000 & Up	18-1118	—	18-1157	18-1156	18-1113	18-1112	18-1158
650 (4 cyl.)	1542745 - 1765403	18-1153	—	18-1157	18-1156	—	N/A	18-1158
650 (4 cyl.)	2119749 - 2309310	18-1153	—	18-1157	18-1156	—	N/A	18-1158
650 (4 cyl.)	2309311 - 2452709	18-1153	—	18-1157	18-1156	—	N/A	18-1158
650 (4 cyl.)	2503991 - 2803561	18-1153	—	18-1157	18-1156	—	N/A	18-1158
650 (4 cyl.)	2803562 - 2874263	—	—	18-1157	18-1156	—	N/A	18-1158
650 (4 cyl.)	2997339 & Up	—	—	18-1157	18-1156	—	N/A	18-1158
650 (3 cyl.)	3293184 - 3525440	—	—	—	18-1162	—	N/A	—
650 (3 cyl.)	3547987 - 4571651	—	—	—	18-1162	—	N/A	—
70 (3 cyl.)	4571652 - 4977156	—	—	—	18-1162	—	N/A	—
70 (3 cyl.)	4977157 - 5579016	—	—	—	18-1162	—	N/A	—
70 (3 cyl.)	5579017 - 6428680	—	—	—	18-1162	—	N/A	—
70 (3 cyl.)	A996142 - & Up	18-1118	N/A	18-1157	18-1156	18-1113	18-1112	18-1158
75 (4 cyl.)	6432901 & Up	18-1121	—	18-1157	18-1156	N/A	N/A	18-1158
75 (3 cyl.)	A996142 - & Up	18-1118	N/A	18-1157	18-1156	18-1113	18-1112	18-1158
800 (4 cyl.)	2559001 - 3144218	18-1153	—	18-1157	18-1156	—	N/A	18-1158
800 (4 cyl.)	3144219 - 3493912	—	—	18-1157	18-1156	—	N/A	18-1158
80 (4 cyl.)	4831999 - 6432900	18-1121	—	18-1157	18-1156	N/A	N/A	18-1158
80 (3 cyl.)	A996142 & Up	18-1118	N/A	18-1157	18-1156	18-1113	18-1112	18-1158
850 (4 cyl.)	3493913 - 4831998	—	—	18-1157	18-1156	—	N/A	18-1158
900 (6 cyl.)	1766824 - 1869775	18-1153	—	18-1157	18-1156	—	N/A	18-1158
900/90 (6 cyl.)	4845301 - & Up	18-1121	—	18-1157	18-1156	N/A	N/A	18-1158
90 (3 cyl.)	A996142 & Up	18-1118	N/A	18-1157	18-1156	18-1113	18-1112	18-1158

① Standard Rotation Only.

③ For Units With A Casting Number Of 1655-9572C Only.

④ For Units With A Casting Number Of 1674-814247C Only.

⑤ Two Bearings Required.

⑥ For 5/8 Dual Bearing Application.

⑦ Use 18-1155 For Counter Rotation Applications.

⑧ Using pinion stamped 43-19672.

Model	Serial Number	Bearing (Drive Shaft)	Bearing Pinion	Inside Bearing Forward Gear	Outside Bearing Forward Gear	Bearing Reverse Gear	Thrust Bearing Reverse Gear	Bearing Model Carrier
100 (4 cyl.)	B209468 - & Up	18-1118	N/A	18-1157	18-1156	18-1113	18-1112	18-1158
1150	2836019 - 2933900	18-1153	—	18-1157	18-1156	—	N/A	18-1158
1150	2933901 - 3525440	18-1153	—	18-1157	18-1156	—	N/A	18-1158
1150	3525441 - 4112634	18-1153	—	18-1157	18-1156	—	N/A	18-1158
1150	4112635 - 4855152	18-1121	—	18-1157	18-1156	—	N/A	18-1158
1150 / 115	4855153 - 5314655	18-1121	—	18-1157	18-1156	N/A	N/A	18-1158
115 (6 cyl.)	5314656 - 5600966	18-1121	—	18-1157	18-1156	N/A	N/A	18-1158
115 (6 cyl.)	5600967 - 6436122	18-1121	—	18-1157	18-1156	N/A	N/A	18-1158
115 (6 cyl.)	6436123 & Up	18-1121	—	18-1157	18-1156	N/A	N/A	18-1158
115 (4 cyl.)	C100000 & Up	18-1118	N/A	18-1157	18-1156	18-1113	18-1112	18-1158
125 (4 cyl.)	0T627234 & Below ⑥	18-1118	N/A	18-1157	18-1156	18-1113	18-1112	18-1158
1250	2314956 - 2839368	18-1153	—	18-1157	18-1156	—	N/A	18-1158
1350	2839369 - 2940020	18-1153	—	18-1157	18-1156	—	N/A	18-1158
1350	2940021 - 3293233	18-1153	—	18-1157	18-1156	—	N/A	18-1158
1400	3293234 - 3502805	18-1153	—	18-1157	18-1156	—	N/A	18-1158
140	4865687 & Up	18-1121	—	18-1157	18-1156	N/A	N/A	18-1158
1500	3502806 - 4121434	18-1153	—	18-1157	18-1156	—	N/A	18-1158
1500	4121435 - 4865677	18-1121	—	18-1157	18-1156	—	N/A	18-1158
V-135	A904646 & Up	18-1143	18-1117	18-1122 ⑤	18-1166	18-1155	N/A	18-1158
V-135	C100861 & Up	18-1143	18-1117	18-1122 ⑤ ①	18-1166 ① ⑦	18-1155 ①	N/A	18-1158
V-135	C239553 & Up	18-1143	18-1117	18-1122 ⑥ ①	18-1166 ① ⑦	18-1155 ①	N/A	18-1158
V-135	D082000 & Up	18-1143	18-1117	18-1115 ①	18-1166 ① ⑦	18-1155 ①	N/A	18-1158
V-150	4868998 - 5432021	18-1164	—	18-1122 ⑤	18-1166	18-1155	N/A	18-1158
V-150	5432022 - 6042945	18-1164	—	18-1122 ⑤	18-1166	18-1155	N/A	18-1158
V-150	6042946 - 6443212	18-1164	—	18-1122 ⑤	18-1166	18-1155	N/A	18-1158
V-150	6443213 - 6616990	18-1164	—	18-1122 ⑤	18-1166	18-1155	N/A	18-1158
V-150	6616991 - A904645	18-1164	—	18-1122 ⑤	18-1166	18-1155	N/A	18-1158
V-150	A904646 & Up	18-1143	18-1117	18-1122 ⑤	18-1166	18-1155	N/A	18-1158
V-150	C100861 & Up	18-1143	18-1117	18-1122 ⑤ ①	18-1166 ①	18-1155	N/A	18-1158
V-150	C239553 & Up	18-1143	18-1117	18-1122 ⑤ ①	18-1166 ① ⑦	18-1155 ①	N/A	18-1158
V-150	D082000 & Up	18-1143	18-1117	18-1115 ①	18-1166 ① ⑦	18-1155 ①	N/A	18-1158
V-150XRI (EFI)	D082000 & Up	18-1143	—	18-1157	18-1156 ①	N/A	N/A	18-1158
V-150XRI (EFI)	D082000 & Up	18-1143	18-1117	18-1115 ⑤ ①	18-1166 ① ⑦	18-1155 ①	N/A	18-1158
V-150XRI (EFI)	D082000 & Up	18-1143	18-1117	18-1115 ⑤ ①	18-1166 ① ⑦	18-1155 ①	N/A	18-1158
V-175	4301235 - 5393736	18-1164	—	18-1122 ⑤	18-1166	18-1155	N/A	18-1158
V-175	5393737 - 6618750	18-1164	—	18-1122 ⑤	18-1166	18-1155	N/A	18-1158
V-175	6618751 & Up	18-1143	18-1117	18-1122 ⑤	18-1166	18-1155	N/A	18-1158
V-175	C100861 & Up	18-1143	18-1117	18-1122 ⑤ ①	18-1166 ① ⑦	18-1155 ①	N/A	18-1158
V-175	C239553 & Up	18-1143	18-1117	18-1122 ⑥ ①	18-1166 ① ⑦	18-1155 ①	N/A	18-1158
V-175	D082000 & Up	18-1143	18-1117	18-1115 ①	18-1166 ① ⑦	18-1155 ①	N/A	18-1158
V-175XRI (EFI)	D000750 & Up	18-1143	18-1117	18-1122 ⑤ ⑥	18-1166	18-1155	N/A	18-1158
V-175XRI (EFI)	D000750 & Up	18-1143	18-1117	18-1122 ⑤ ⑥	18-1166	18-1155	N/A	18-1158
V-175XRI (EFI)	D082000 & Up	18-1143	—	18-1157	18-1156 ①	N/A	N/A	18-1158
V-175XRI (EFI)	D082000 & Up	18-1143	18-1117	18-1115 ⑤ ①	18-1166 ① ⑦	18-1155 ①	N/A	18-1158
V-175XRI (EFI)	D082000 & Up	18-1143	18-1117	18-1115 ⑤ ①	18-1166 ① ⑦	18-1155 ①	N/A	18-1158
V-200	4839034 - 5363917	18-1164	—	18-1122 ⑤	18-1166	18-1155	N/A	18-1158
V-200	5363918 - 6073191	18-1164	—	18-1122 ⑤	18-1166	18-1155	N/A	18-1158
V-200	6073192 - 6203990	18-1164	—	18-1122 ⑤	18-1166	18-1155	N/A	18-1158
V-200	6203991 - 6435502	18-1164	—	18-1122 ⑤	18-1166	18-1155	N/A	18-1158
V-200	6435503 - 6625220	18-1164	—	18-1122 ⑤	18-1166	18-1155	N/A	18-1158
V-200	6625221 - C100860	18-1143	18-1117	18-1122 ⑤	18-1166	18-1155	N/A	18-1158
V-200/								
V-200 (EFI)	C100861 - C291519	18-1143	18-1117	18-1122 ⑤	18-1166	18-1155	N/A	18-1158
V-200 (2.5L)	C291520 - D081999	18-1143	18-1117	18-1122 ⑥ ①	18-1166 ① ⑦	18-1155 ①	N/A	18-1158
V-200	D082000 & Up	18-1143	18-1117	18-1115 ①	18-1166 ① ⑦	18-1155 ①	N/A	18-1158
V-200XRI (EFI)	C291520 & Up	18-1143	18-1117	18-1122 ⑤	18-1166	18-1155	N/A	18-1158
V-200XRI (EFI)	D082000 & Up	18-1143	—	18-1157	18-1156 ①	N/A	N/A	18-1158
V-200XRI (EFI)	D082000 & Up	18-1143	18-1117	18-1115 ⑤ ①	18-1166 ① ⑦	18-1155 ①	N/A	18-1158
V-200XRI (EFI)	D082000 & Up	18-1143	18-1117	18-1115 ⑤ ①	18-1166 ① ⑦	18-1155 ①	N/A	18-1158
V-220	B117316 & Up	18-1143	18-1117	18-1122 ⑤	18-1166	18-1155	N/A	18-1158
V-225	5628028 & Up	18-1164	—	18-1122 ⑤	18-1166	18-1155	N/A	18-1158
225	D280813 & Up	18-1143	18-1117	18-1157 ①	18-1159 ①	18-1155 ①	N/A	18-1158
XR-4 ③	B242885 & Up	18-1143	—	18-1157	18-1156	N/A	N/A	18-1158
XR-4	B242885 & Up	18-1143	—	18-1157	18-1156	N/A	N/A	18-1158
XR-4 ③	C100861 & Up	18-1143	—	18-1157	18-1156	N/A	N/A	18-1158
XR-4 ④	C100861 & Up	18-1143	—	18-1157	18-1156	N/A	N/A	18-1158
XR-4	C239553 & Up	18-1143	—	18-1157	18-1156	N/A	N/A	18-1158
XR-6	D082000 & Up	18-1143	—	18-1157	18-1156	N/A	N/A	18-1158

- ① Standard Rotation Only.
- ② For Units With A Casting Number Of 1655-9572C Only.
- ③ For Units With A Casting Number Of 1674-814247C Only.
- ④ Two Bearings Required.
- ⑤ For 5/8 Dual Bearing Application.
- ⑥ Use 18-1155 For Counter Rotation Applications.
- ⑦ Using pinion stamped 43-19672.

 <p>18-2244 18-22441-9① (PKG. OF 50 WITHOUT GASKET) DRAIN PLUG Replaces: 10-79953A2,Q2</p>	 <p>18-2375 18-23751-9① (PKG. OF 50 WITHOUT GASKET) DRAIN PLUG Replaces: 10-14834A1, 22-67892A1</p>	 <p>18-2165 CONTROL BOX CAM Replaces: 59369</p>	 <p>18-2155 SHIFT SHAFT HOUSING BUSHING Replaces: 23-77631A2 35-200 HP</p>
--	---	---	---

① Priced per Package ② Items ending in "D" are Display Packaged - Regular number is Non-Display



**18-3719
PINION NUT**
Replaces: 11-35921



**18-2359
DRIVE SHAFT NUT SET**
— INCLUDES —

Sierra #	Description	Replaces:
18-3719	Pinion Nut	11-35921
18-2343	Pinion Nut Washer	12-92721



**18-1736
DRIVESHAFT ASSEMBLY**
Replaces: 45-43031A1
Fits: 100 4 cyl (1988 & Up), 115 4 cyl (1989 & Up),
125 4 cyl (1994 & Up)



**18-1737
DRIVESHAFT**
Replace: 45-440001
Fits: V-115 DFI 2.5L (2000), V-135 (1986 & Up), V-135 DFI 2.5L (1998 & Up), V-150 (1978 & Up), V-150 EFI (1996-01), V-150 Mag/EFI (1993-95), V-150 DFI 2.5L (1998 & Up), V-150 Mag (1980-85), V-175 (1976-99), V-175 EFI (1996 & Up), V-175 Mag/EFI (1991-95), V-175 DFI 2.5L (2001 & Up), V-175 XRI EFI (1991-95), V-200 (1978 & Up), V-200 EFI (1989-01), V-200 Mag/EFI (1992-95), V-200 EFI 2.5L (2002 & Up), V-200 XRI/EFI (1991-95), XR-4 (1988-91), XR-6 (1992 & Up)



**18-2254
PROP SHAFT**
Replaces: 44-850308



**18-2239
PROP SHAFT**
Replaces: 44-94148



**18-2260
PROP SHAFT**
Replaces: 44-17915



**18-2236
SLIDING CLUTCH**
Replaces: 52-822539, 52-822539T



**18-1550
COMPLETE GEAR SET**
Replaces: 43-850036T+
43-881260A3+52-850048T
Forward, Pinion, Reverse and Clutch for 4 cyl.: Fits: 100 4 cyl with 6 JAW reverse clutch(1988-98), 115 4 cyl with 6 JAW reverse clutch(1989-98), 125 4 cyl with 6 JAW reverse clutch(1994-98) (2.07:1 Ratio)



**18-1551
COMPLETE GEAR SET**
Replaces: 43-803615T2+
52-859340T+43-828175A1
Forward, Pinion, Reverse and Clutch for V-6:
Fits: V-150 (XR6, Mag III)(1997 & Up), V-150 EFI (1997 & Up), V150 DFI (1998 & Up), V-175 (1997 & Up), V-175 EFI (1997 & Up), V-175 DFI (2001 & Up), V-200 (1997 & Up), V-200EFI 2.5L (1997 & Up) (1.87:1 Ratio)



**18-1560
REVERSE GEAR**
Replaces: 43-850036T
Fits: 75 4-Stroke (2000-02), 90 4-Stroke (2000-02), 100 4 cyl with 6 JAW Rev Clutch (1988 & Up), 115 4 cyl with 6 JAW Rev Clutch (1989 & Up), 115 4-Stroke EFI (2001 & Up), 125 4 cyl with 6 JAW Rev Clutch (1994 & Up) (2.07:1 Ratio)



**18-1562
CLUTCH**
Replaces: 52-850048T
Fits: 40 4-Stroke 4cyl Bigfoot(2001 & Up), 50 4-Stroke Bigfoot (1995 & Up), 60 3 cyl with 6 JAW Rev (1998 & Up), 60 4-Stroke Bigfoot (2001 & Up), 70 3 cyl with 6 JAW Rev Clutch (1987 & Up), 75 3 cyl with 6 JAW Clutch (1990-98), 75 3 cyl (1999 & Up), 75 4-Stroke 1596cc (2000-03), 80 3 cyl with 6 JAW Rev Clutch (1987 & Up), 90 3 cyl with 6 JAW Rev Clutch (1987-98), 90 3 cyl (1999 & Up), 90 4-Stroke 1596cc (2000-03), 100 4 cyl w 6 JAW Rev Clutch (1988-98), 100 4 cyl (1999 & Up), 115 4 cyl with 6 JAW Rev Clutch (1989-98), 115 4 cyl (1999 & Up), 115 4-Stroke 1741cc (2001-03), 125 4 cyl with 6 JAW Rev Clutch (1994-98), 125 4 cyl (1999 & Up)



**18-1564
GEAR SET**
Replaces: 43-803615T2
Fits: V-150 (1978 & Up), V-150 EFI (1996-01), V-150 DFI 2.5L (1998 & Up), V-150 EFI 2.5L (2002 & Up), V-175 DFI 2.5L (2001 & Up), V-175 EFI 2.5L (2002-03), V-200 (1978 & Up), V-200 EFI (1989-01), V-200 EFI 2.5L (2002 & Up) (1.87:1 Ratio)



**18-1565
CLUTCH**
Replaces: 52-859340T
Fits: V-115 DFI 2.5L (2000), V-135 (1986 & Up), V-135 DFI 2.5L (1998 & Up), V-150 (1978 & Up), V-150 EFI (1996-01), V-150 Mag/EFI (1993-95), V-150 DFI 2.5L (1998 & Up), V-150 Mag (1980-85), V-175 (1976-99), V-175 EFI (1996 & Up), V-175 Mag/EFI (1991-95), V-175



**18-1566
REVERSE GEAR**
Replaces: 43-828175A1
Fits: V-150 (1978 & Up), V-150 EFI (1996-01), V-150 DFI 2.5L (1998 & Up), V-175 (1976-99), V-175 EFI (1996-01), V-175 DFI 2.5L (2001 & Up), V-200 (1978 & Up), V-200 EFI (1989-01), V-200 EFI 2.5L (2002 & Up), XR-6 (1992-99) **(1.87:1 Ratio)**



**18-4830
GEAR HOUSING ASSEMBLY**
Replaces: 1667-9011G59
Fits: 100 4cyl (1988-99), 115 4cyl (1989 & Up), 115 3cyl DFI (2004 & Up), 115 EFI 4-Stroke(2001 & Up), 125 4cyl (1994 & Up), 30 4-Stroke (1999-01), 30 Carb 3cyl 4-Stroke (2002 & Up), 40 4-Stroke (1998-01), 40 4-Stroke 4cyl (2001-02), 40 Carb 3cyl 4-Stroke (2002 & Up), 40 EFI 4cyl 4-Stroke (2002 & Up), 40 Jet (2001 & Up), 45 Jet (1994-98), 50 4-Stroke (1995-00), 50 4cyl 4-Stroke (2001-02), 50 Bigfoot 4-Stroke(1995-00), 50 EFI 4cyl 4-Stroke (2002 & Up), 55 3cyl (1996 & Up), 60 3cyl (1984 & Up), 60 3cyl Bigfoot (1998), 60 4cyl 4-Stroke (2001-02), 60 EFI 4cyl 4-Stroke (2002 & Up), 65 Jet (1994 & Up), 75 3cyl (1987 & Up), 75 4-Stroke (2000 & Up), 75 3cyl 1.5L DFI (1995 & Up), 80 Jet (1994 & Up), 90 3cyl (1987 & Up), 90 4-Stroke (2000 & Up), 90 3cyl 1.5L DFI (2004 & Up) with 6 Jaw Clutch (Design II)



**18-4832
GEAR HOUSING ASSEMBLY**
Replaces: 1647-9148T93
Fits: 140 Jet (All), Magnum III (1992-99), V-115 DFI 2.5L (2000), V-135 (1986 & Up), V-135 DFI 2.5L (1998 & Up), V-150 (1978 & Up), V-150 EFI (1996-01), V-150 DFI 2.5L (1998 & Up), V-175 (1976-99), V-175 EFI (1996-01), V-175 DFI 2.5L (2001 & Up), V-200 (1978 & Up), V-200 EFI (1989-01), V-200 EFI 2.5L (2002 & Up), XR6 (1992 & Up)



**18-4850
COMPLETE GEARCASE**
Replaces: 1667-9011G77, 1667-9011G78, 1667-9011G10, 1667-9011G11, 1667-9011G51, 1667-9011J6, 1667-9011R6,
Fits: 100/115/125 4-cyl with 6 Jaw Clutch (Design II) **(2.07:1 Ratio)**



**18-4851
COMPLETE GEARCASE**
Replaces: 1647-6693A3, 1647-7350A5, 1647-7350A26, 1647-8688A1, 1647-9148A69, 1647-9148A8, 1647-9148A84, 1647-9148T84, 1647-9148R84,
Fits: 135/150/200/225 V6 **(1.87:1 Ratio)**

MERCURY OUTBOARD LOWER UNIT APPLICATIONS

Model	Serial Number	Drive Shaft	Pinion Nut	Propeller Shaft	Clutch
40 Four Stroke - BigFoot	0T178500 - 1B226999		18-3719	18-2254	18-1562
50 Four Stroke - BigFoot	0G231123 - 1B226999		18-3719	18-2254	18-1562
60 Sea Pro/Marathon/BigFoot	0G590000 & UP		18-3719	18-2254	18-1562 ④
60 Four Stroke - BigFoot	0T178500 - 1B226999		18-3719	18-2254	18-1562
650 (4 cyl.)	1542745 - 1765403	N.L.A.	—	—	18-2236
650 (4 cyl.)	2119749 - 2309310	—	—	—	18-2236
650 (4 cyl.)	2309311 - 2452709	—	18-3719	—	18-2236
650 (4 cyl.)	2503991 - 2803561	—	18-3719	—	18-2236
650 (4 cyl.)	2803562 - 2874263	—	18-3719	—	18-2236
650 (4 cyl.)	2997339 & Up	—	18-3719	—	18-2236
70 (3 cyl.)	A996142 - & Up	—	18-3719	—	18-2236 ⑤
70 (3 cyl.)	A996142 - & Up	—	18-3719	18-2254	18-1562
75 (4 cyl.)	6432901 & Up	—	18-3719	—	18-2236
75 (3 cyl.)	A996142 - & Up	—	18-3719	—	18-2236 ⑤
75 (3 cyl.)	A996142 - 0G760299	—	18-3719	18-2254	18-1562
75 (3 cyl.)	0G760300 & Up	—	18-3719	18-2254	18-1562
75 DFI	0T980000 & Up	—	18-3719	18-2254	18-1562
75 Four Stroke	0G960500 - 0T800999	—	18-3719	18-2254	18-1562
800 (4 cyl.)	2559001 - 3144218	—	18-3719	—	18-2236
800 (4 cyl.)	3144219 - 3493912	—	18-3719	—	18-2236
80 (4 cyl.)	4831999 - 6432900	—	18-3719	—	18-2236
80 (3 cyl.)	A996142 & Up	—	18-3719	—	18-2236 ⑤
80 (3 cyl.)	A996142 & Up	—	18-3719	18-2254	18-1562 ④
850 (4 cyl.)	3493913 - 4831998	—	18-3719	—	18-2236
900 (6 cyl.)	1766824 - 1869775	N.L.A.	—	—	18-2236
900/90 (6 cyl.)	4845301 - & Up	—	18-3719	—	18-2236
90 (3 cyl.)	A996142 - 0G760299	—	18-3719	—	18-2236 ⑤
90 (3 cyl.)	A996142 - 0G760299	—	18-3719	18-2254	18-1562 ④
90 (3 cyl.)	0G760300 & Up	—	18-3719	18-2254	18-1562
90 DFI	0T801000 & Up	—	18-3719	18-2254	18-1562
90 Four Stroke	0G960500 - 0T800999	—	18-3719	18-2254	18-1562

① Long shaft only ③ Offshore only ⑤ 3 Jaw reverse clutch nut
 ② Standard rotation only ④ 6 Jaw reverse clutch ⑥ Pre-load pin, w/o driveshaft N.L.A. No longer available

APPLICATION CONTINUED ON NEXT PAGE

MERCURY OUTBOARD LOWER UNIT APPLICATIONS

Model	Serial Number	Drive Shaft	Pinion Nut	Propeller Shaft	Clutch
100 (4 cyl.)	B209468 - 0G760299	—	18-3719	—	18-2236 ⑤
100 (4 cyl.)	B209468 - 0G760299	—	18-3719	18-2254	18-1562 ④
100 (4 cyl.)	0G760300 & Up	—	18-3719	18-2254	18-1562
1150	2836019 - 2933900	—	18-3719	—	18-2236
1150	2933901 - 3525440	—	18-3719	—	18-2236
1150	3525441 - 4112634	—	18-3719	—	18-2236
1150	4112635 - 4855152	—	18-3719	—	18-2236
1150 / 115	4855153 - 5314655	—	18-3719	—	18-2236
115 (6 cyl.)	5314656 - 5600966	—	18-3719	—	18-2236
115 (6 cyl.)	5600967 - 6436122	—	18-3719	—	18-2236
115 (6 cyl.)	6436123 & Up	—	18-3719	—	18-2236
115 (4 cyl.)	C100000 - 0G760299	—	18-3719	—	18-2236 ⑤
115 (4 cyl.)	C100000 - 0G760299	—	18-3719	18-2254	18-1562 ④
115 (4 cyl.)	0G760300 & Up	—	18-3719	18-2254	18-1562
115 DFI	0T801000 & Up	—	18-3719	18-2254	18-1562
115 Four Stroke	0T178500 - 0T800999	—	18-3719	18-2254	18-1562
1250	2314956 - 2839368	—	18-3719	—	18-2236
125 (4 cyl.)	0D283222 - 0G760299	—	18-3719	—	18-2236 ⑤
125 (4 cyl.)	0D283222 - 0G760299	—	18-3719	18-2254	18-1562 ④
125 (4 cyl.)	0G760300 & Up	—	18-3719	18-2254	18-1562
1350	2839369 - 2940020	—	18-3719	—	18-2236
1350	2940021 - 3293233	—	18-3719	—	18-2236
1400	3293234 - 3502805	—	18-3719	—	18-2236
140	4865687 & Up	—	18-3719	—	18-2236
1500	3502806 - 4121434	—	18-3719	—	18-2236
1500	4121435 - 4865677	—	18-3719	—	18-2236
V-135	0A904646 - 0G437999	18-1737	18-3719	18-2239	—
V-135	0G438000 - 0T178499	18-1737	18-3719	18-2239 ②	—
V135 DFI	G590000 - 1B417701	18-1737	18-3719	18-2239	18-1565
V140	T178500 & Up	—	18-3719	18-2239	—
V-150 (Casting # 1647-6670C)	4868998 - 0A904645	—	18-3719	—	—
V-150 (Casting #1647-8675C)	4868998 - 0A904645	—	18-3719	18-2239	—
V-150	4868998 - 0A904645	18-1737	18-3719	18-2239	—
V-150	0A904646 - 0G437999	18-1737	18-3719	18-2239	—
V-150	0G438000 & Up	18-1737	18-3719	18-2239	18-1565
V-150 XR-4 (Casting #1655-9572C)	B242885 - 0D081999	—	18-3719	—	18-2236
V-150 XR-4 (Casting #1674-814247C)	B242885 - 0D081999	—	18-3719	—	18-2236
V-150 XR-6	D082000 - 0G303045	18-1737	18-3719	18-2239	18-2236
V-150 XR-6	0G438000 & Up	18-1737	18-3719	18-2239	18-1565
V-150XRI (EFI)	D082000-0G437999	18-1737	18-3719	— ②	18-2236 ②
V-150XRI (EFI)	0G438000 & Up	18-1737	18-3719	18-2239 ②	18-1565
V150 DFI	G590000 & Up	18-1737	18-3719	18-2239	—
V-175	4301235 - 5393736	— ⑥	18-3719	—	—
V-175	5393737 - 6618750	— ⑥	18-3719	18-2239	—
V-175	6618751 - 0G437999	18-1737	18-3719	18-2239	—
V-175	0G438000 & Up	18-1737	18-3719	18-2239	18-1565
V-175XRI (EFI)	D000750 - 0G437999	18-1737	18-3719	18-2239	—
V-175XRI (EFI)	0G438000 & Up	18-1737	18-3719	18-2239	18-1565
V-200	4839034 - 6625220	— ⑥	18-3719	18-2239	—
V-200	6625221 - 0G437999	18-1737	18-3719	18-2239	—
V-200	0G438000 & Up	18-1737	18-3719	18-2239	18-1565
V-200 (EFI)	C100861 - 0G437999	18-1737	18-3719	18-2239	—
V-200 (EFI)	0G438000 & Up	18-1737	18-3719	18-2239	18-1565
V-200 (2.5L)	C291520 - D081999	—	18-3719	18-2239 ②	—
V-200 DFI	0G438000 & Up	—	18-3719	—	18-1565
V-220	B117316 & Up	—	18-3719	18-2239	—
V-225	5628028 & Up	— ①	18-3719	18-2239	—
225	D280813 & Up	—	18-3719	—	—
HIGH PERFORMANCE MODELS					
2.4 EFI	B290010 & Up	—	18-3719	18-2260 ② ③	—
XR-2	B290314 - C276429	—	18-3719	18-2260 ②	—
MOD-VP	B290066 - C276379	—	18-3719	18-2260	—

- ① Long shaft only
- ② Standard rotation only
- ③ Offshore only
- ④ 6 Jaw reverse clutch
- ⑤ 3 Jaw reverse clutch
- ⑥ Pre-load pin, w/o driveshaft
- nut
- N.L.A. No longer available

<p>PKG. OF 10</p>  <p>18-0202-9③ INSERT Replaces: 8227731 Fits: Mercury/Mariner 25-125hp Outboards</p>	 <p>18-3751 SPANNER NUT Replaces: 79448 For V-6</p>	 <p>18-2298 TAB WASHER Replaces: 14-18323</p>
--	--	--

 <p>18-2299 TAB WASHER Replaces: 14-79447</p>	 <p>STAINLESS STEEL LOCKNUTS</p>	<table border="1" style="width: 100%; border-collapse: collapse;"> <thead> <tr> <th>Part #</th> <th>O.E. #</th> <th>Thread Size</th> <th>Std. Pkg.</th> </tr> </thead> <tbody> <tr> <td>18-3720 ⑦</td> <td>11-34932</td> <td>3/8" - 24</td> <td>1</td> </tr> <tr> <td>18-3721 ⑦</td> <td>11-34933</td> <td>7/16" - 20</td> <td>6</td> </tr> <tr> <td>18-3722 ⑦</td> <td>11-35888, 11-20361</td> <td>1/4" - 28</td> <td>1</td> </tr> <tr> <td>18-3723 ⑦</td> <td>11-45592</td> <td>5/16" 24</td> <td>1</td> </tr> </tbody> </table>	Part #	O.E. #	Thread Size	Std. Pkg.	18-3720 ⑦	11-34932	3/8" - 24	1	18-3721 ⑦	11-34933	7/16" - 20	6	18-3722 ⑦	11-35888, 11-20361	1/4" - 28	1	18-3723 ⑦	11-45592	5/16" 24	1
Part #	O.E. #	Thread Size	Std. Pkg.																			
18-3720 ⑦	11-34932	3/8" - 24	1																			
18-3721 ⑦	11-34933	7/16" - 20	6																			
18-3722 ⑦	11-35888, 11-20361	1/4" - 28	1																			
18-3723 ⑦	11-45592	5/16" 24	1																			

⑦ This product is priced per piece. To order priced per package, please add -9 to the part number.
⑧ Priced per package

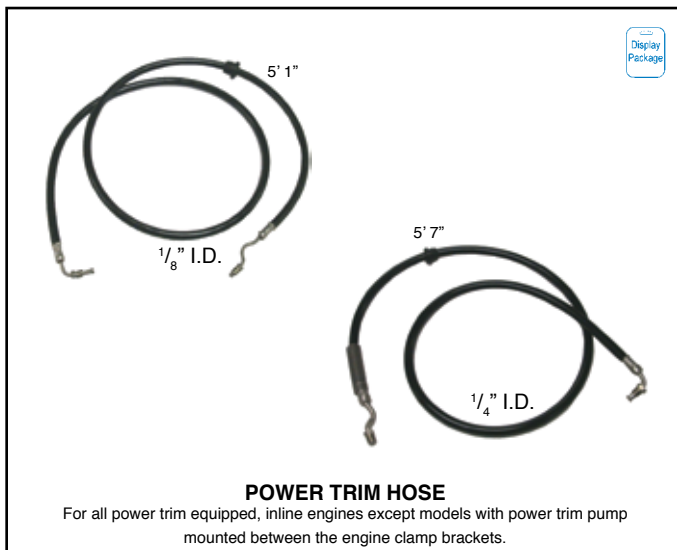

POWER TRIM HOSE

For all power trim equipped, inline engines except models with power trim pump mounted between the engine clamp brackets.

Part #	Replaces:	Description	Qty
18-2110	32-88005	Small Diameter	2 required per engine
18-2111	32-88006	Large Diameter	2 required per engine

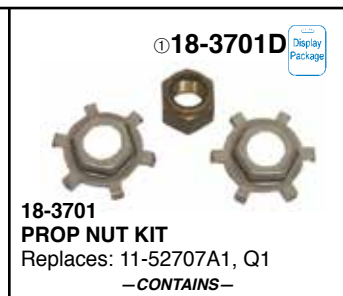

18-3701D PROP NUT KIT
Replaces: 11-52707A1, Q1
— CONTAINS —

Part #	O.E. #	Description
18-3200	14-31210, 14-816629	Tab Washer
18-3700	11-52707	Prop Nut



18-3200-9 PROP NUT KIT
Replaces: 14-31210, 14-816629



18-3702D PROP NUT KIT
Replaces: 11-69578A1, T1, Q1
— CONTAINS —

Part #	O.E. #	Description
18-3204	14-76281	Tab Washer
18-3704	11-69578	Prop Nut

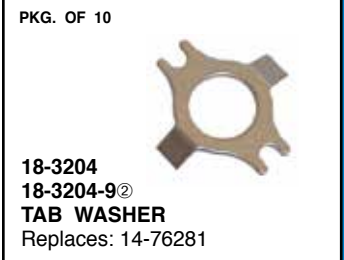

18-3204-9 PROP NUT KIT
Replaces: 14-76281



18-3700 PROP NUT
Replaces: 11-52707



18-3704 PROP NUT
Replaces: 11-69578



18-3703 PROP NUT
Replaces: 11-88228
For: 9.9-25 HP 1986-Up



18-3714 BRASS CASTLE WASHER
Replaces: 12-31211A2
For: 135-275 HP (V6 2 cycle)

TAB WASHER/PROP NUT/PROP NUT KIT APPLICATION

HP	Beg. S/N	End. S/N	Tab Washer	Prop Nut	Prop Nut Kit	HP	Beg. S/N	End. S/N	Tab Washer	Prop Nut	Prop Nut Kit
9.9 ④	G760300	& UP	—	18-3703	—	80	2559001	& UP	18-3200	18-3700	18-3701
15 ④	G590000	& UP	—	18-3703	—	85	1460999	3493912	18-3200	—	—
18	5837437	& UP	—	18-3703	—	85	3493913	4831998	18-3200	18-3700	18-3701
20	6443973	& UP	—	18-3703	—	90	1766824	4845300	18-3200	—	—
25	6416713	& UP	—	18-3703	—	90	4845301	& UP	18-3200	18-3700	18-3701
35	— ③	—	18-3204	18-3704	18-3702	95	1869776	2318585	18-3200	—	—
40	— ③	—	18-3204	18-3704	18-3702	100	1464949	2484632	18-3200	—	—
50	— ③	—	18-3204	18-3704	18-3702	100	2484633	2836018	18-3200	18-3700	18-3701
60	— ③	—	18-3204	18-3704	18-3702	100	B209468	& UP	18-3200	18-3700	18-3701
65	1542745	2503990	18-3200	—	—	110	1870204	2314955	18-3200	—	—
65	2503991	3293183	18-3200	18-3700	18-3701	115	2836019	& UP	18-3200	18-3700	18-3701
70	1482212	1566239	18-3200	—	—	125	2314956	2536209	18-3200	—	—
70	— ③	A996141	18-3204	18-3704	18-3702	125	2536210	2839368	18-3200	18-3700	18-3701
70	A996142	& UP	18-3200	18-3700	18-3701	135	2839369	3293233	18-3200	18-3700	18-3701
75	6432901	& UP	18-3200	18-3700	18-3701	140	3293234	& UP	18-3200	18-3700	18-3701
80	1405637	1566239	18-3200	—	—	150(Inline)	3502806	& UP	18-3200	18-3700	18-3701
③ Fits most applications ④ 4-Stroke Bigfoot						V-6	All	—	18-3200	18-3700	18-3701



18-4444 PROP WRENCH
Replaces: 91-95830A1

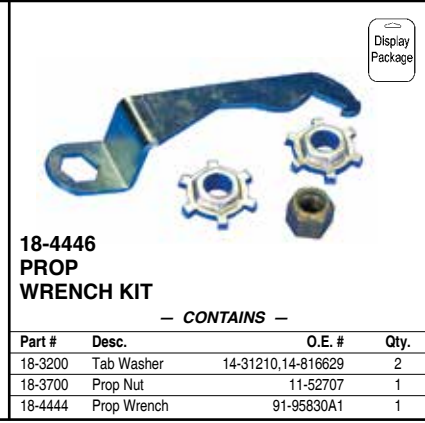

18-4446 PROP WRENCH KIT
— CONTAINS —

Part #	Desc.	O.E. #	Qty.
18-3200	Tab Washer	14-31210, 14-816629	2
18-3700	Prop Nut	11-52707	1
18-4444	Prop Wrench	91-95830A1	1

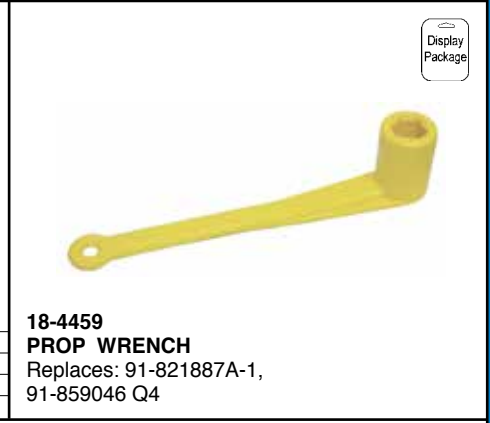

18-4459 PROP WRENCH
Replaces: 91-821887A-1, 91-859046 Q4

① Items ending in "D" are Display Packaged - Regular number is Non-Display
② Priced per Package



**18-9075
SPACER**
Replaces: 23-888690
For: 2-Stroke: 115hp. - 300hp. (1993-Current)
4-Stroke: 115hp. - 225hp. (2002-Current)



**18-9076
COLLAR**
Replaces: 23-888690-1
For: 2-Stroke: 115hp. - 300hp. (1993-Current)
4-Stroke: 115hp. - 225hp. (2002-Current)



**18-9077
WAVE WASHER**
Replaces: 13-888363-2
For: 2-Stroke: 115hp. - 300hp. (1993-Current) 4-Stroke: 115hp. - 225hp. (2002-Current)



**18-9079
WAVE WASHER KIT**
Replaces:
Fits: Yamaha 2-stroke 115-300hp (1993 & Up); Yamaha 4-stroke 115-225hp (2002 & Up); Mercury 4-stroke 225 EFI S/N OT653945 & Up



**18-9078
STAINLESS STEEL WASHER**
Replaces: 12-855682-2
For: 2-Stroke: 115hp. - 300hp. (1993-Current)
4-Stroke: 115hp. - 225hp. (2002-Current)



THRUST WASHER

Part #	Replaces
18-4220	13171,77987,12-835467-1 V-6 Outboards & Mercruiser Stemdrives
18-4221	13191A1,75282A1 4 & 6 Inline - 75-150 HP



**18-4233
THRUST WASHER**
Replaces: 73345A1
(35-70 HP)



**18-9010
MOTOR FLUSHER**
Replaces: 73971A2, 44357A2, Q2
Heavy Duty



**18-3607
RETAINER BRACKET**
Replaces: 893409
For: 200/225 4-Stroke Verado (S/N OT980000 & Up),
250/275 4-Stroke Verado (S/N OT801000 & Up)



**18-2700
STEERING CYLINDER SEAL KIT**
Replaces: 896173A01
For: 200/225 4-Stroke Verado (S/N OT980000 & Up),
250/275 4-Stroke Verado (S/N OT801000 & Up)

Zinc is for saltwater only applications.
Magnesium is for fresh water only applications.
Aluminum is for brackish water or salt water environments.



**18-6156A
18-6156M
ANODE KIT**
Verado 4 cyl. All Models



**18-6157A
18-6157M
ANODE KIT**
Verado 6 cyl. All Models



② **18-6241**
③ **18-6011**
① **18-6011A**
ANODE
Replaces:
31640, 31640A1, 31640Q4
Use on inline 3, 4 & 6 Cyl, V6



③ **18-6014**
① **18-6014A**
ANODE
Replaces:
46399A1, 822777A1, 822777Q1
For use with 225 (3.0L Carb.) models



③ **18-6016**
③④ **18-60161**
③⑤ **18-60161-9**
① **18-6016A**
② **18-6244**
ANODE
Replaces:
76214, 76214T3, 76214Q5
200, 225, 250HP, V-155-V-200, & All Bravos



③ **18-6068**
ANODE
Replaces: 826134, Q

① Aluminum ② Magnesium ③ Zinc
④ Standard package of 10 priced per piece ⑤ Standard package of 10 priced per package



③ 18-6249
① 18-6249A
ANODE
Replaces: 43396A2, 818298A1, Q1
For use on transom mount bracket: 175HP/150EFI/200EFI (S/N OG303046 & Up)



18-6245
ANODE MOUNTING BOLT
Replaces: 10-32470
For use with: 18-6011, 18-6014, 18-6016
7/16" X 1 3/4" Allen Head Cap Screw



18-2599
FACE SEAL AND TOOL
Replaces: 26-816575A2



18-2742
SHIFT SHAFT BOOT
Replaces: 85552

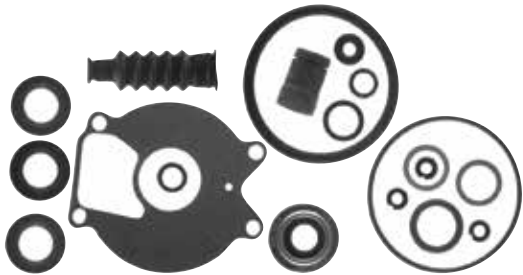

18-2624
LOWER UNIT SEAL KIT
Replaces: 26-85090A2

— CONTAINS —

Part #	Desc.	O.E.#	Qty.
18-0579	Oil Seal	26-41131	1
18-0580	Oil Seal	26-41132	1
18-0586	Seal	26-99325	2
18-7419	O-Ring	25-69202	1
18-2562	Gear Hsg to Face Plate Gasket	27-99326-1	1
18-2945	Washer	12-20260	2
18-2742	Boot	85552	1
18-2560	Washer	12-86645	2
18-7135	O-Ring	25-35276	1
18-7188	O-Ring	25-805726	2
18-7956	O-Ring	25-85549	1
18-7100	O-Ring	25-85594	1
18-7959	O-Ring	25-99691	1
18-8348	Slinger	25-86203	1

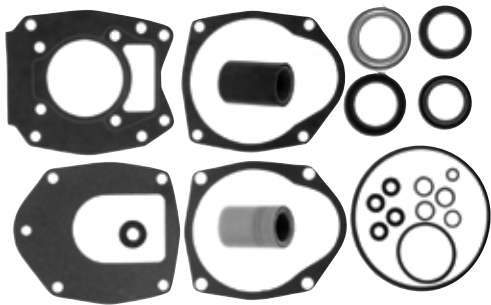

18-2626
LOWER UNIT SEAL KIT
Replaces: 26-43035A4

— CONTAINS —

Part #	Desc.	O.E.#	Qty.
18-0522	Oil Seal	26-43036	1
18-0583	Oil Seal	26-43035	1
18-2002	Oil Seal	26-76868	1
18-2053	Oil Seal	26-70081	1
18-2054	Oil Seal	26-816464	1
18-2563	Face Plate to Water Pump Cover Gasket	27-43034-1	1
18-2564	Water Pump Base to Face Plate Gasket	27-43033-1	1
18-2565	Water Pump Base to Gear Housing Gasket	27-43047-2	1
18-2566	Face Plate to Water Pump Cover Gasket	27-817277	1
18-2945	Washer	12-19183	3
18-4261	Washer	19643	1
18-7188	O-Ring	25-805726	1
18-7198	O-Ring	25-45710	1

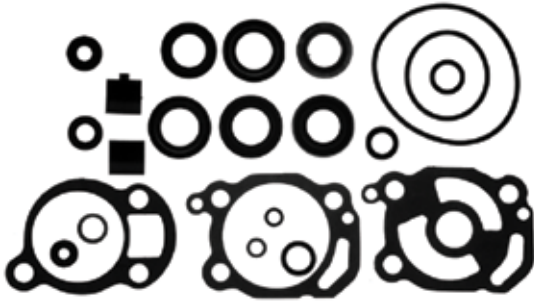

18-2627
LOWER UNIT SEAL KIT
Replaces: 26-66303A1

— CONTAINS —

Part #	Desc.	O.E.#	Qty.
18-0595	Seal	26-66303	2
18-2004	Seal, Water Pump Base	26-20070	2
18-2006	Seal, Water Pump Base	26-33467	1
18-2019	Seal	26-26805	1
18-2827	Upper Face Plate to Water Pump Gasket	27-39623	1
18-2828	Lower Water Pump Base to Face Gasket	27-39625	1
18-2945	Washer	12-20260	1
18-4261	Washer	12-20262	1
18-7120	O-Ring	25-38933	1
18-7163	O-Ring	25-33465	1
18-7164	O-Ring	25-33466	1
18-7180	O-Ring	25-26802	2

① Aluminum ③ Zinc

APPLICATION BEGINS ON PAGE 387

— CONTAINS —

Part #	Desc.	O.E.#	Qty.
18-8346	Nylon Bushing	23-86214	1
18-0584	Oil Seal, Prop Shaft	26-66022	1
18-2010	Seal, Wtr Pump Base	26-96063	1
18-2945	Washer, Fill Screw	12-20260	1
18-4261	Washer, Fill Screw	12-20262	1
18-7116	O-Ring	25-62704	1
18-7120	O-Ring	25-38933	1
18-7156	O-Ring	25-29439	1
18-7168	O-Ring	25-48171	1
18-7171	O-Ring	25-30529	1
18-7180	O-Ring	25-26802	1
18-8308	Seal, Shift Shaft	26-30696	1
18-8310	Seal, Water Pump Base	26-30900	1

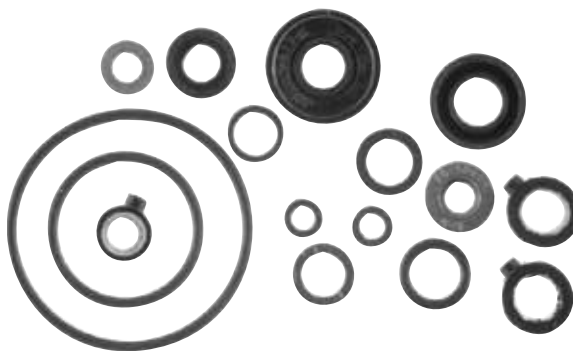

18-2628
LOWER UNIT SEAL KIT
Replaces: 26-77066A1

— CONTAINS —

Part #	Desc.	O.E.#	Qty.
18-2006	Seal	26-33467	2
18-2560	Washer	12-86645	2
18-2562	Gear Housing to Face Plate Gasket	27-99326-1	1
18-2742	Boot	85552	1
18-2945	Washer	12-20260	2
18-7135	O-Ring	25-35276	1
18-7419	O-Ring	25-69202	1
18-7956	O-Ring	25-85549	1
18-7100	O-Ring	25-85594	1
18-8348	Slinger	25-86203	1



18-2629
LOWER UNIT SEAL KIT
Replaces: 26-85090A1

— CONTAINS —

Part #	Desc.	O.E.#	Qty.
18-0500	Seal	26-817472	1
18-0622	Gasket, Lower Wear Plate	27-19701	1
18-2051	Seal	26-69188	1
18-2052	Seal	26-69189	1
18-2945	Washer	12-19183	3
18-7168	O-Ring	25-48171	2
18-7173	O-Ring	25-30224	1
18-7950	O-Ring	25-45258	1



18-2635
LOWER UNIT SEAL KIT
Replaces: 26-814669A2

— CONTAINS —

Part #	Desc.	O.E.#	Qty.
18-2563	Face Plate to Water Pump Gasket	27-43034-1	1
18-2564	Water Pump Base to Face Plate Gasket	22-43033-1	1
18-2945	Drain Screw Gasket	12-19183,12-20260	2
18-2599	Face Seal & Tool	26-816575A2	1
18-2014	Oil Seal	26-89238	1
18-2013	Oil Seal	26-16977	1
18-7159	O-Ring	25-31534	1
18-7176	O-Ring	25-90011	1
18-7420	O-Ring	25-21836	2
18-7440-1	O-Ring	25-36318	2



18-2642
LOWER UNIT SEAL KIT
Replaces: 26-816575A5

APPLICATION BEGINS ON PAGE 387



18-2646-1
LOWER UNIT SEAL KIT
 Replaces: 26-816575A3

-- CONTAINS --			
Part #	Desc.	O.E.#	Qty.
18-2599	Face Seal and Tool	26-818575A2	1
18-2564	Water Pump Base To Face Plate Gasket	27-43033-1	1
18-2566	Face Plate to Water Pump Cover Gasket	27-817277	1
18-2945	Sealing Washer	12-19183	1
18-2944	Seal	26-45577	1
18-2002	Oil Seal	26-76868	1
18-2013	Oil Seal	26-16977	1
18-2014	Oil Seal	26-89238	1
18-2054	Oil Seal	26-81646-1	1
18-2076	Oil Seal	26-12224	1
18-2077	Oil Seal	26-14077	1
18-7159	O-Ring	25-31534	1
18-7168	O-Ring	25-48171	2
18-7176	O-Ring	25-90011	1
18-7420	O-Ring	25-21836	2
18-7440-1	O-Ring	25-36318	2
18-2056	Oil Seal	26-66302	2
18-7413	O-Ring	25-62702	1



18-2653
LOWER UNIT SEAL KIT
 Replaces: 26-55682A1

-- CONTAINS --			
Part #	Desc.	O.E.#	Qty.
18-3110	Grommet	26-38970	1
18-2002	Oil Seal	26-76868	2
18-2007	Oil Seal	26-94038	1
18-2009	Oil Seal	26-89236	1
18-2013	Oil Seal	26-16977	1
18-2014	Oil Seal	26-89238	1
18-2048	Oil Seal	26-24590	1
18-2050	Oil Seal	26-55682	1
18-2053	Oil Seal	26-70081	1
18-2826	Water Pump Base to Gear Housing Gasket	27-85610-1	1
18-2914	Water Pump Gasket	27-85608-1	1
18-2915	Water Pump Gasket	27-85609-1	1
18-2948	Rubber Washer	12-49221-1	1
18-7153	O-Ring	25-25439	1
18-7157	O-Ring	25-29976	1
18-7158	O-Ring	25-30613	1
18-7159	O-Ring	25-31534	1
18-7161	O-Ring	25-32546	1
18-7162	O-Ring	25-33145	1
18-7173	O-Ring	25-30224	1
18-2801	Water Pump Gasket	27-32438	1
18-7426	O-Ring	25-30271	1
18-2945	Drain Screw Gasket	12-20260, 12-19183	2

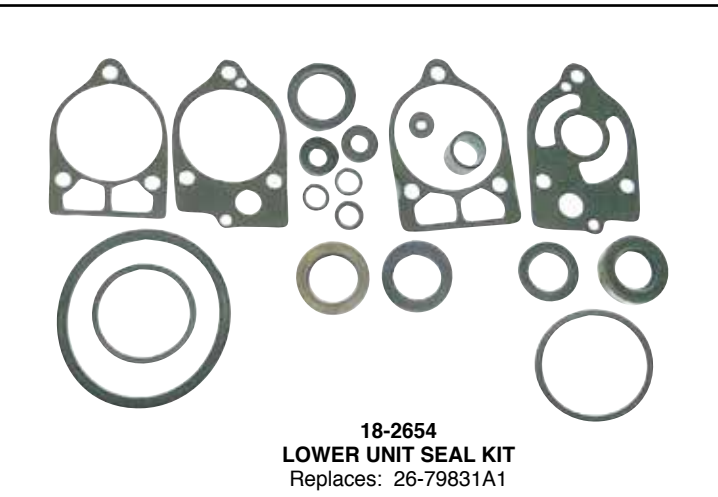

18-2654
LOWER UNIT SEAL KIT
 Replaces: 26-79831A1

-- CONTAINS --			
Part #	Desc.	O.E.#	Qty.
18-2008	Oil Seal	26-56788	1
18-2011	Oil Seal	26-90562	1
18-2048	Oil Seal	26-24590	1
18-2051	Oil Seal	26-69188	1
18-2052	Oil Seal	26-69189	1
18-2054	Oil Seal	26-81646A	1
18-2055	Oil Seal	26-79831	1
18-2823	Lower Water Pump Base to Face Plate Gasket	27-32769	1
18-2824	Upper Face Plate to Pump Body Gasket	27-19551	1
18-2825	Water Pump Base Gasket	27-32770	1
18-2841	Water Pump Base Gasket	27-19552, 27-77417	1
18-2948	Rubber Washer	12-49221-1	1
18-7153	O-Ring	25-25439	1
18-7155	O-Ring	25-26855	1
18-7160	O-Ring	25-31986	1
18-7115	O-Ring	25-26722	1
18-2945	Drain Screw Gasket	12-20260, 12-19183	2

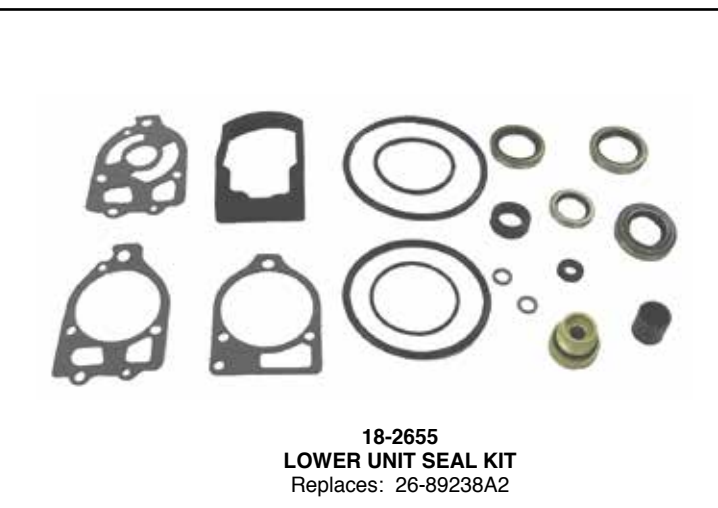

18-2655
LOWER UNIT SEAL KIT
 Replaces: 26-89238A2

-- CONTAINS --			
Part #	Desc.	O.E.#	Qty.
18-2155	Bushing Gasket	23-77631A2	1
18-2919	Gasket	27-42631-1	1
18-2002	Oil Seal	26-76868	2
18-2013	Oil Seal	26-16977	1
18-2014	Oil Seal	26-89238	1
18-2914	Water Pump Gasket	27-85608-1	1
18-2915	Water Pump Gasket	27-85609-1	1
18-3110	Bushing	26-38970	1
18-7159	O-Ring	25-31534	1
18-7176	O-Ring	25-90011	1
18-7157	O-Ring	25-29976	1
18-7153	O-Ring	25-25439	1
18-2009	Oil Seal	26-89236	1
18-7426	O-Ring	25-30271	1
18-2945	Drain Screw Gasket	12-20260, 12-19183	2

— CONTAINS —

Part #	Desc.	O.E.#	Qty.
18-0581	Oil Seal	26-41365	2
18-0584	Oil Seal	26-66022	1
18-0585	Oil Seal	26-821928	1
18-0586	Oil Seal	26-99325	1
18-2728-1	Water Tube Seal	26-42102-1	1
18-2945	Washer	12-19183	2
18-3149-1	Water Pump Base	46-42040A5	1
18-4261	Washer	19643	1
18-7162	O-Ring	25-33145	1



18-2697-1
LOWER UNIT SEAL KIT
 Replaces: 26-41365A3



18-2725
LOWER UNIT SEAL KIT
 Replaces: 26-830749A01

For: 135/150/175 4-Stroke Verado (S/N 1B227000 & Up), 200/225 4-Stroke Verado (S/N OT980000 & Up), 250/275 4-Stroke Verado (S/N OT801000 & Up)

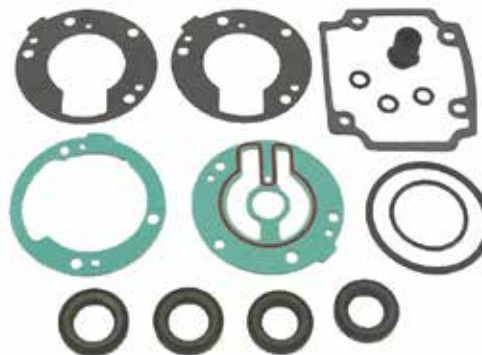

18-2785
LOWER UNIT SEAL KIT
 Replaces: 27-41899M

— CONTAINS —

Part #	Desc.	O.E.#	Qty.
18-0776	Grommet	—	1
18-0552	Grommet	26-84818M	1
18-4698	Drain or Fill Washer Gasket	27-81987M	3
18-0554	Oil Seal	26-84813M	1
18-0296	Oil Seal	26-83406M, 26-82233M	2
18-7405	O-Ring	25-84054M	1
18-0773	Wear Plate Gasket	—	1

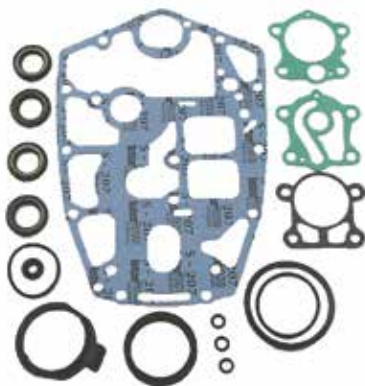

18-2787
LOWER UNIT SEAL KIT
 Replaces: 27-92648M

— CONTAINS —

Part #	Desc.	O.E.#	Qty.
18-4698	Drain or Fill Washer Gasket	27-81987M	3
18-0296	Oil Seal	26-83406M, 82233M	2
18-0297	Oil Seal	26-82234M	2
18-0298	O-Ring	25-82275M	1
18-0299	O-Ring	25-82289M	1
18-0292	Wear Plate to Pump Housing Gasket	27-81417M	1
18-0284	Grommet	27-81440M	1
18-0267	Oil Seal	26-82257M	1
18-0294	Wear Plate to Pump Base Gasket	27-81421M	1



18-8382
LOWER UNIT SEAL KIT
 Replaces: 26-816575A4

For: 200 HP (T801000 & UP), 200 HP OPTIMAX DFI (G438000 & UP), 225 HP EFI (G438000 & UP), 225 HP OPTIMAX DFI (G590000-G960499), 250 HP EFI (G438000 & UP), MODELS WITH "C-3 CASTING": 200 HP OPTIMAX DFI (G386496-G437999), 225 HP (D280813-G437999), 225 HP EFI (G129222-G437999), 250 HP EFI (G129222-G437999)

GEAR HOUSING SEAL KIT APPLICATION

HP	Beg. Serial #	End. Serial #	Part #	HP	Beg. Serial #	End. Serial #	Part #
4 (1cyl)	5595532	A809600	18-2628	60 (3 cyl)	6428681	D000749	18-2654
4.5 (1 cyl)	4107220	& UP	18-2628	60 (3 cyl)			
6	A197112	& UP	18-2697-1	non-Bigfoot	D000750	& UP	18-2635
7.5	4851693	& UP	18-2628	60 (3 cyl)			
8	A197112	& UP	18-2697-1	Bigfoot	D000750	& UP	18-2626
8 Bodensee (4-stroke)	G760300	T178499	18-2697-1	60 (4-stroke) Bigfoot	T178500	& UP	18-2626
9.8	4839254	& UP	18-2628	60 (4-stroke)			
9.9	A197112	& UP	18-2697-1	non-Bigfoot	T178500	& UP	18-2635
9.9 (4-stroke) non-Bigfoot	G760300	& UP	18-2697-1	60 Seapro/ Marathon/ Big Foot (3 cyl)	D000750	& UP	18-2626
9.9 (4-stroke) Bigfoot	G760300	& UP	18-2624	70	4571652	A996141	18-2654
Seapro/XR10	D038000	& UP	18-2697-1	70	A996142	& UP	18-2626
15	A197112	& UP	18-2697-1	75 (4 cyl)	6432901	& UP	18-2653
15 (4-stroke) non-Bigfoot	G760300	& UP	18-2697-1	75 (3 cyl)	A996142	& UP	18-2626
15 (4-stroke) Bigfoot	G760300	& UP	18-2624	75 (4-stroke)	G960500	& UP	18-2626
Magnum/ Marathon 15XD/ Super 15	ALL		18-2624	80 (4 cyl)	4831999	6432900	18-2653
18	5837437	6443972	18-2629	80 (3 cyl)	A966142	& UP	18-2626
18	6443973	& UP	18-2624	90 (6 cyl)	4845301	& UP	18-2653
20	4709593	6443972	18-2627	90 (3 cyl)	A996142	& UP	18-2626
20	6443973	& UP	18-2624	90 (4-stroke)	G960500	& UP	18-2626
25	5705532	6443972	18-2629	100 (4 cyl)	B209468	& UP	18-2626
25	6443973	& UP	18-2624	115 (6 cyl)	4855153	B209467	18-2653
25 Lightning (3 cyl)	E268781	& UP	18-2624	115 (4 cyl)	C100000	& UP	18-2626
30 (4-stroke) (3 cyl) Bigfoot	G760300	& UP	18-2626	115EFI (4-stroke)	T178500	& UP	18-2626
35	6445653	& UP	18-2654	125 (4 cyl)	D283222	& UP	18-2626
40 (2 cyl)	4860103	G053313	18-2654	V-135	A904646	& UP	18-2655
40 (4 cyl)	C159200	& UP	18-2654	V-135 DFI	G590000	& UP	18-2655
40 (4-stroke) (3 cyl) Bigfoot	G760300	& UP	18-2626	140 (6 cyl)	4865678	& UP	18-2653
45	5531630	& UP	18-2654	V-150	4868648	A904645	18-2653
50 (4 cyl)	4357640	& UP	18-2654	V-150 (carb)	A904646	& UP	18-2655
50 (3 cyl)	6428681	D000749	18-2654	V-150 XR4, XR6, MAGII, III	B242885	& UP	18-2655
50 (3 cyl)	D000750	G589999	18-2635	V-150 EFI	D820000	& UP	18-2655
50 (4-stroke) (4 cyl) Bigfoot	G760300	& UP	18-2626	V-150 DFI	G590000	& UP	18-2655
50 (4-stroke) Bigfoot	G231123	& UP	18-2626	V-175	4301235	6618750	18-2653
50 (4-stroke) non-Bigfoot	T178500	& UP	18-2635	V-175 (carb)	6618751	& UP	18-2655
55 (3 cyl)	D000750	& UP	18-2635	V-175 XRI(EFI)	D000750	& UP	18-2655
				V-200	4839034	6625220	18-2653
				V-200 (carb)	6625221	& UP	18-2655
				V-200 XRI(EFI)	C100861	& UP	18-2655
				V-200 DFI (3.0L)	G386496	G960499	18-2642
				V-220	B117316	& UP	18-2655
				V-225	5628028	& UP	18-2653
				V-225	D280813	& UP	18-2646-1
				V-225/225 DFI	G386496	& UP	18-2642
				V-250	G386496	& UP	18-2642

MARINER LOWER UNIT SEAL KITS (Japanese Models)

Model	Serial #	O.E. Kit #	Part #
20C	(6A9-) ALL	27-41899M/27-95660M	18-2785
25C	(695-) ALL	27-41899M/27-95660M	18-2785
30A	(689-) ALL	27-41899M/27-95660M	18-2785
W48	(670-) ALL	27-92648M	18-2787
55/W55	(663-) ALL	27-92648M	18-2787
60	(675-) ALL (6F0-) ALL	27-92648M	18-2787



OIL SEALS

Part #	O.E. #	Shaft Size (inches)	Dimensions (inches)	
			O.D.	Width
18-0172	26-97530	0.845	1.500	0.315
18-0267	26-82257M	0.354	0.748	0.197
18-0296	26-83406M, 26-82233M	0.866	1.417	0.236
18-0297	26-82234M	0.906	1.457	0.236
18-0515	26-30530	0.540	1.004	0.303
18-0516	26-30913	0.500	0.839	0.187
18-0517	26-32911	1.100	1.260	0.127
18-0518 ②	26-34217	0.282	0.394	0.083
18-0519	26-14240	3.792	4.536	0.482
18-0522	26-43036	1.045	1.474	0.187
18-0523	26-43993	1.640	2.132	0.282
18-0525	26-45587	0.390	0.628	0.124
18-0526	26-48443	0.750	1.379	0.256
18-0527	26-56397	0.750	1.127	0.343
18-0529	26-62818	1.640	2.256	0.319
18-0531	26-72785	0.790	1.880	0.248
18-0537	26-85107	1.020	1.507	0.251
18-0554	26-84813M	0.787	1.339	0.260
18-0560 ③	26-896600	1.250	1.690	0.256
18-0564 ④	26-888483	1.250	1.690	0.256
18-0579	26-41131	1.141	1.313	0.344
18-0580	26-41132	0.750	1.250	0.312
18-0581	26-41365	0.500	0.984	0.200

- ① Line Cutter Seal ② Pkg. of 4
- ③ Metal ④ Rubber

OIL SEALS

Part #	O.E. #	Shaft Size (inches)	Dimensions (inches)	
			O.D.	Width
18-0583	26-43035	1.063	1.496	0.197
18-0584	26-66022	0.056	1.000	0.312
18-0585	26-821928	0.687	1.125	0.312
18-0586	26-99325	0.675	1.125	0.250
18-0595	26-66303	0.688	1.125	0.250
18-2002	26-76868	1.188	1.692	0.250
18-2003	26-68493, 26-823894	2.250	3.000	0.437
18-2004	26-20070	0.625	1.000	0.250
18-2006	26-33467	0.625	1.125	0.312
18-2007	26-94038	1.000	1.500	0.312
18-2008	26-56788	0.875	1.250	0.375
18-2009	26-89236, 26-892361	0.375	0.750	0.250
18-2010	26-96063	0.437	0.875	0.250
18-2011	26-90562	0.750	1.250	0.312
18-2013	26-16977	0.875	1.250	0.188
18-2014	26-89238	0.875	1.500	0.312
18-2015	26-23517	0.750	1.250	0.250
18-2016	26-41953	1.187	1.875	0.250
18-2017	26-32121	0.750	1.000	0.125
18-2019	26-27163	0.688	1.124	0.250
18-2019	26-26805	0.688	1.124	0.250
18-2048	26-24590	0.400	0.566	0.094
18-2049	26-32511	1.250	2.005	0.388
18-2050	26-55682	1.000	1.253	0.125
18-2051	26-69188	0.875	1.253	0.278
18-2052	26-69189	0.875	1.314	0.322
18-2053	26-70081	1.185	1.754	0.360
18-2054	26-816464 26-76384	0.375	0.750	0.243
18-2055	26-79831	0.750	1.127	0.149
18-2056	26-66302 26-965031	0.875	1.375	0.250
18-2076 ①	26-12224	1.188	1.690	0.360
18-2077	26-14077	1.188	1.689	0.247
18-8308	26-30696	0.297	0.625	0.156
18-8310	26-30900	0.453	0.828	0.172

POWERHEAD SEALS APPLICATION

HP	Cyl.	Beginning Serial No.	Ending Serial No.	Upper Crankshaft	Qty.	Lower Crankshaft	Qty.
3.5	1	6202173	UP	—	—	18-0527	1
3.6	1	5404657	UP	—	—	18-0527	1
4	1	2771622	4107219	—	—	18-0527	1
4	1	5589202	UP	18-0515	1	—	—
4.5	1	4107220	UP	—	—	18-0527	1
7.5/9.8/110	2	2810637	3274633	—	—	18-0527	1
10/15/20/25	2	1290910	1499331	—	—	18-2013	1
20	2	1558310	2031773	—	—	18-2013	2
20	2	2031774	2827677	—	—	18-2013	2
18,20,25XD	2	6443973	UP	—	1	18-0537	1
20 JET	2	G053314	UP	—	1	18-0537	1
30	2	1271885	1356947	18-2016	1	18-2016	1
30JET	2	C159200	UP	18-2016	1	18-2016 ①	2
MK 35 A	2	1217222	1271884	18-2016	1	18-2016	1
35	2	1356948	1571113	18-2016	1	18-2016	1
35	2	1571114	2874703	—	—	18-2016 (lower)	1
35	2	6445653	UP	18-2016	1	18-2016	2
40	4	1279685	2874703	18-2016	1	18-2016	1
40	2	2874704	3336257	18-2016	1	18-2016	2
40	2	3336258	4117709	18-2016	1	18-2016	1
40	2	4117710	5556229	18-2016	1	18-2016	1
40	2	5556230	6445653	18-2016	1	18-2016	2
40	4	C159200	UP	18-2016	1	18-2016 ①	2
45	4	1476510	1531568	18-2016	1	18-2016	1
45	4	5531630	UP	18-2016	1	18-2016	2
45 JET	3	ALL	—	—	—	18-2016 (inner)	1
50	4	1421113	2858813	18-2016	1	18-2016 (inner)	1
50	4	2855514	UP	18-2016	1	18-2016	2
50/60	3	6428681	D000750	18-2016	1	18-2016	2
50/55/60	3	D000750	UP	—	—	18-2016 (inner)	1
60	6	1303411	1542744	18-2016	1	18-2016	1
65	4	1542745	2803561	18-2016	1	18-2016 (inner)	1

① Fits most models

POWERHEAD SEALS APPLICATION

HP	Cyl.	Beginning Serial No.	Ending Serial No.	Upper Crankshaft	Qty.	Lower Crankshaft	Qty.
65	4	2803562	3293183	18-2016	1	18-2016	2
65	3	3293184	3547986	18-2016	1	18-2016	2
65	3	3547987	4571651	18-2016	1	18-2016	2
65 JET	3	D283222	UP	18-0523	1	18-2016	1
70	6	1296411	1566239	18-2016	1	18-2016 (inner)	1
70	3	4571652	6428680	18-2016	1	18-2016	2
70	3	A996142	UP	18-0523	1	18-2016	1
75	4	6432901	A996141	18-2016	1	18-2016	2
75	3	A996142	D283221	18-0523	1	18-2016	1
75	3	D283222	UP	18-0523	1	18-2016	1
80	6	1335465	1566239	18-2016	1	18-2016	1
80	4	2559001	4831998	18-2016	1	18-2016	2
80	4	4831999	UP	18-2016	1	18-2016	2
80	3	A996142	UP	18-0523	1	18-2016	1
80 JET	4	D283222	UP	18-0523	1	18-2016	1
85	6	1460999	1766823	18-2016	1	18-2016	1
85	4	3493913	4831998	18-2016	1	18-2016	2
90	6	1766824	1869775	18-2016	1	18-2016 (outer)	1
90	6	4845301	A996141	18-2016	1	18-2016	2
90	3	A996142	D283221	18-0523	1	18-2016	1
90	3	D283221	UP	18-0523	1	18-2016	1
95	6	1869776	2318585	18-2016	1	18-2016 (inner)	1
100	6	1464949	2836018	18-2016	1	18-2016	1
100BP	6	2641855	3253111	18-2016	1	18-2016	2
100	4	B209468	D283221	18-0523	1	18-2016	1
100	4	D283222	UP	18-0523	1	18-2016	1
105JET	V-6	D082000	UP	18-2016	1	18-2016	2
110	6	1870204	2314955	18-2016	1	18-2016	1
115	6	2836019	3525440	18-2016	1	18-2016	2
115	6	3525441	C100000	18-2016	1	18-2016	2
125	6	2314956	3253111	18-2016	1	18-2016 (inner)	1
135	6	2839369	3293233	18-2016	1	18-2016	2
135	V-6	A904646	UP	18-2016	1	18-2016	2
140	6	3293234	UP	18-2016	1	18-2016	2
140JET	V-6	D082000	UP	18-2016	1	18-2016	2
150	6	3502806	5327662	18-2016	1	18-2016	2
150	V-6	4868998	6042945	18-2016	1	18-2016	2
150	V-6	6042946	UP	18-2016	1	18-2016	2
175	V-6	4301235	5875203	18-2016	1	18-2016	2
175	V-6	5875204	6618751	18-2016	1	18-2016	2
175	V-6	6618751	UP	18-2016	1	18-2016	2
200	V-6	4839034	5875303	18-2016	1	18-2016	2
200	V-6	5875303	6073191	18-2016	1	18-2016	2
200	V-6	6073192	UP	18-2016	1	18-2016	2
220	V-6	B117316	UP	18-2016	1	18-2016	2
225	V-6	5628028	UP	18-2016	1	18-2016	2

① Fits most models

LOWER UNIT SEALS APPLICATION

HP	Beginning Serial No.	Ending Serial No.	Prop Shaft Inner/Outer	Water Pump Base Upper/Lower	Water Pump Housing	Shift Shaft
3.5/3.6	5404657	UP	-	18-2010	18-0516	-
3.9	1655013	2498135	18-0515	-	18-0516	-
4	2498136	5589201	18-0515	-	18-0516	-
4	5589202	5595531	-	18-2010	18-0516	-
4/4.5	5589203	A809601	-	18-2010	② 18-0516	-
6	1408611	2529894	18-0515	-	18-0516	-
7.5	2529895	3801457	18-0515	-	18-0516	-
7.5	3801458	5206549	-	-	18-0516	-
7.5	5206550	UP	-	18-2010	② 18-0516	-
9.8	1470349	3795657	18-0515	-	18-0516	-
9.8	3795658	5206549	-	-	18-0516	-
9.8	5206550	UP	-	18-2010	② 18-0516	-
18	5837437	6443972	-	18-2006/18-2006	-	-
20	1558310	1866494	18-2019/18-2019	18-2006	18-2004	-
20	1866495	6443972	18-2019/18-2019	18-2004/18-2006	18-2004	-
25	5705532	6443972	-	18-2006/18-2006	-	-
30	1271885	1356947	18-2011	18-2011	18-2015	18-2009
30	G055314	UP	18-2051/18-2052	-	-	-
MK 35A	1217222	1271884	18-2011	18-2011	18-2015	18-2009
35	1356948	1448139	18-2011	18-2011	18-2015	18-2009
35	1571114	1960826	18-2011	18-2011	18-2017	18-2009
35	1960827	2874703	18-2011/18-2015	18-2011/18-2055	18-2017	18-2009
35	6445653	UP	18-2051/18-2052	18-2011/18-2055	-	18-2054
40	1279685	2874703	18-2011	18-2011	18-2015	18-2009
40	2874704	3336257	18-2008	18-2011/18-2055	18-2017	18-2009
40	3336258	4117709	18-2008	18-2011/18-2055	18-2017	18-2048
40	4117710	4860102	18-2051/18-2052	18-2011/18-2055	-	18-2009/18-2048

② .438 ID ONLY

LOWER UNIT SEALS APPLICATION (Cont.)

HP	Beginning Serial No.	Ending Serial No.	Prop Shaft Inner/Outer	Water Pump Base Upper/Lower	Water Pump Housing	Shift Shaft
40	4860103	6445652	18-2051/18-2052	18-2011/18-2055	-	18-2054
40 4cyl	C159200	G053313	18-2051/18-2052	18-2011/18-2055	-	18-2054
40 2cyl	G055314	UP	18-2051/18-2052	-	-	-
45	1476510	1531568	18-2011	18-2011	18-2017	18-2009
45 4cyl	5531630	UP	18-2051/18-2052	18-2011/18-2055	-	18-2054
50	1421113	1639472	18-2011	18-2011	18-2017	18-2009
50	1639473	1770178	18-2011	18-2011	18-2017	18-2009
50	1770179	2305100	18-2011/18-2015	18-2011/18-2055	18-2017	18-2009
50	2305101	2858813	18-2011/18-2015	18-2011/18-2055	18-2017	18-2048
50	2858814	4140999	18-2008	18-2011/18-2055	18-2017	18-2009/18-2048
50	4141000	4962055	18-2051/18-2052	18-2011/18-2055	-	18-2009/18-2048
50	4962056	5531630	18-2051/18-2052	18-2011/18-2055	-	18-2054
50 3cyl	6428681	D000750	18-2051/18-2052	18-2011/18-2055	-	18-2054
50/55/60 3 cyl	D000751	UP	18-2051/18-2052	-	-	18-2054
60	1303411	1542744	-	18-2011	18-2015	-
60	6428681	D000750	18-2051/18-2052	18-2011/18-2055	-	18-2054
65	1542745	2874263	18-2002/18-2002	18-2007	18-2013	18-2009
65	2874263	3293183	18-2002/18-2002	18-2007/18-2050	18-2013	18-2009/18-2048
65 3cyl	3293184	4136684	18-2008	18-2011/18-2055	18-2017	18-2009/18-2048
65 3cyl	4136685	4571651	18-2051/18-2052	18-2011/18-2055	18-2017	18-2009/18-2048
70	1296411	1413610	18-2011	-	18-2015	-
70	1413611	1566239	18-2002/18-2002	18-2007	18-2013	18-2009
70 3cyl	4571652	4977156	18-2051/18-2052	18-2011/18-2055	-	18-2009/18-2048
70 3cyl	4977157	5579016	18-2051/18-2052	18-2011/18-2055	-	18-2054
70 3cyl	5579017	A996142	18-2051/18-2052	18-2011/18-2055	-	18-2009
70/75 3cyl	A996142	UP	18-2002/18-2053	18-0522 (lower)	-	-
75 4cyl	6432901	A996142	18-2002/18-2053	18-2013/18-2007	-	18-2054
80	1335465	1398629	18-2002/18-2002	18-2007	18-2013	18-2009
80	1398630	1566239	18-2002/18-2002	18-2007	18-2013	18-2009
80 4cyl	2559001	3144218	18-2002/18-2002	18-2013/18-2007	18-2013	18-2009/18-2048
80 4cyl	3144219	4831998	18-2002/18-2002	18-2050/18-2007	18-2013	18-2009/18-2048
80 4cyl	4831999	5582561	18-2002/18-2002	18-2013/18-2007	-	18-2054
80 4cyl	5582562	A996142	18-2002/18-2053	18-2013/18-2007	-	18-2054
80 3cyl	A996142	UP	18-2002/18-2053	18-0522 (lower)	-	-
85	1460999	1766823	18-2002/18-2002	18-2007	18-2013	18-2009
85 4cyl	3493913	4590511	18-2002/18-2002	18-2050/18-2007	-	18-2009/18-2048
85 4cyl	4590512	4831998	18-2002/18-2002	18-2013/18-2007	-	18-2009/18-2048
90	1766824	1869775	18-2002/18-2002	18-2013/18-2007	18-2013	18-2009
90	4845301	5594656	18-2002/18-2002	18-2013/18-2007	-	18-2054
90	5594657	A996142	18-2002/18-2053	18-2013/18-2007	-	18-2054
90 3cyl	A996142	UP	18-2002/18-2053	18-0522 (lower)	-	-
95	1869776	2318585	18-2002/18-2002	18-2013/18-2007	18-2013	18-2009/18-2048
100,100SS	1464949	2836018	18-2002/18-2002	18-2013/18-2007	18-2013	18-2009
100BP	2399698	2641854	18-2002/18-2002	18-2013/18-2007	18-2013	18-2009/18-2048
100 4cyl	B209468	UP	18-2002/18-2053	18-0522 (lower)	-	-
110	1870204	2314955	18-2002/18-2002	18-2013/18-2007	18-2013	18-2009/18-2048
115	2836019	3525440	18-2002/18-2002	18-2013/18-2007	18-2013	18-2009/18-2048
115	3525440	4112634	18-2002/18-2002	18-2013/18-2007	-	18-2009/18-2048
115	4112635	4855152	18-2002/18-2002	18-2013/18-2007	-	18-2009/18-2048
115	4855153	5600966	18-2002/18-2002	18-2013/18-2007	-	18-2054
115	5600967	C100000	18-2002/18-2053	18-2013/18-2007	-	18-2054
115 4cyl	C100000	UP	18-2002/18-2053	18-0522 (lower)	-	-
125	2314956	2839368	18-2002/18-2002	18-2013/18-2007	18-2013	18-2009
135	2839369	3293233	18-2002/18-2002	18-2013/18-2007	18-2013	18-2009
140	3293234	3502805	18-2002/18-2002	18-2013/18-2007	18-2013	18-2009/18-2048
140	4865678	UP	18-2002/18-2002	18-2013/18-2007	-	18-2054
150	3502806	4121434	18-2002/18-2002	18-2013/18-2007	-	18-2009/18-2048
150	4121434	5327662	18-2002/18-2002	18-2013/18-2007	-	18-2009/18-2048

V-6'S

150/150XR2	4868998	5432021	18-2002/18-2002	18-2013/18-2014	-	18-2054
150/150XRS	5432021	A904646	18-2002/18-2002	18-2013/18-2014	-	18-2054
135/150/XR2	A904646	UP	18-2002/18-2002	18-2013/18-2014	-	18-2054
175	4301235	6618750	18-2002/18-2002	18-2013/18-2014	-	18-2054
175	6618751	UP	18-2002/18-2002	18-2013/18-2014	-	18-2054
200	4839034	6073191	18-2002/18-2002	18-2013/18-2014	-	18-2054
200	6073192	UP	18-2002/18-2002	18-2013/18-2014	-	18-2054
220	B117316	UP	18-2002/18-2002	18-2013/18-2014	-	18-2054
225	5628028	D280813	18-2002/18-2002	18-2013/18-2014	-	18-2054
250/275	C101891	UP	18-2002/18-2002	-	-	18-2054
3.4	5611648	UP	18-2002/18-2002	-	-	18-2054

POWER TRIM OIL SEAL

H.P.	Beginning S/N	Ending S/N	Oil Seals	Qty.	Desc.
115	2836019	3525440	18-2048	1	Starboard Mounting Bracket
140	3293234	UP	18-2048	1	Starboard Mounting Bracket
150	3502806	4865677	18-2048	1	Starboard Mounting Bracket
150 XS	4868648	5327662	18-2048	1	Starboard Mounting Bracket

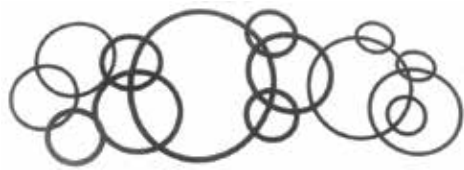

O-RINGS

Part #	O.E. #	Dimensions		Part #	O.E. #	Dimensions	
		I.D.	Width (inches)			I.D.	Width (inches)
18-0175 ③④	25-26543	.220	.103	18-7164 ②④	25-33466	1.375	.100
18-0858 ③④	25-54029	2.425	.103	18-7165 ②④	25-45253	.500	.065
18-0860 ③④	25-62700	3.237	.103	18-7165 ②④	25-32509	.500	.065
18-7102 ②④	25-62706	.426	.070	18-7166 ②④	25-45254	.615	.065
18-7103 ②④	25-29845	.924	.103	18-7167 ②④	25-97386	3.609	.139
18-7105 ②④	25-62705	.750	.065	18-7168 ②④	25-48171	.370	.065
18-7107 ②④	25-67202	4.750	.135	18-7169 ②④	25-70937	3.500	.135
18-7114 ②④	25-23145	1.000	.135	18-7170 ②④	25-33504	1.365	.135
18-7115 ①	25-26722	1.735	.135	18-7171 ②④	25-30529	1.920	.100
18-7116 ①	25-62704	.360	.100	18-7172 ②④	25-31305	3.250	.135
18-7117 ①	25-35027	1.046	.139	18-7173 ②④	25-30224	1.875	.135
18-7120 ①	25-38933	.215	.065	18-7174 ②④	25-45711	.620	.100
18-7121 ①	25-35029	3.100	.135	18-7175 ②④	25-62817	3.750	.270
18-7124		2.500	.103	18-7176 ②④	25-90011	2.160	.100
18-7125		2.300	.103	18-7177 ②④	25-53421	2.625	.065
18-7135 ①	25-35276	.750	.135	18-7180 ②④	25-26802	.445	.090
18-7143 ②④	25-65936	1.310	.100	18-7188 ②	25-805726	.361	.0635
18-7145 ②④	25-64068	.250	.100	18-7198 ②④	25-45710	1.430	.100
18-7146 ②④	25-47632	1.120	.100	18-7411 ②④	25-35480	1.250	.100
18-7151 ②④	25-20081	3.000	.135	18-7413 ②④	25-62702	.301	.070
18-7152 ②④	25-20863	2.625	.135	18-7414 ②④	25-64067, 25-823683	1.989	.070
18-7153 ②④	25-21836	.862	.103	18-7415 ②④	25-64966	3.739	.070
18-7155 ②④	25-26855	1.620	.135	18-7419 ②④	25-69202	2.675	.103
18-7156 ②④	25-29439	1.185	.100	18-7420 ②④	25-25439	.862	.139
18-7157 ②④	25-29976	3.500	.210	18-7421 ②④	25-20415	.150	.065
18-7158 ②④	25-30613	.740	.100	18-7422 ②④	25-30271	.740	.310
18-7159 ②④	25-31534	3.855	.210	18-7426 ③④	25-30271	.740	.310
18-7160 ②④	25-31986	2.635	.210	18-7440-1 ③	25-36318	.799	.103
18-7161 ②④	25-32546	3.250	.070	18-7445 ③④	25-55801	.801	.070
18-7162 ②④	25-33145	2.025	.135	18-7449 ①	25-97387	4.487	.103
18-7163 ②④	25-33465	2.415	.100	18-7459 ①	25-20826	2.234	.139
				18-7464 ①	25-39695	4.234	.139
				18-7467 ②④	25-54030	2.987	.103
				18-7474 ①	25-94288	1.239	.070
				18-7956 ③④	25-85549	2.480	.1969
				18-7100 ②④	25-85594	.2362	.1575
				18-7961	25-47254	3.650	.135

① Pkg. of 1 ② Pkg. of 5 ③ Pkg. of 2

MARINER O-RINGS (Japanese Models)

Part No.	O.E. No.	Dimensions		Part No.	O.E. No.	Dimensions	
		I. D.	Width (mm)			I. D.	Width (mm)
18-0298	25-82275M	41.50	3.0	18-0299	25-82289M	66.04	5.33

POWERHEAD O-RING APPLICATION

HP	Cyl.	Beginning Serial No.	Ending Serial No.	Upper End Cap	Lower End Cap
3.5	1	6202173	UP	18-7152	-
3.6	1	5404657	UP	18-7152	-
3.9/4	1	1655013	2498135	18-7152	-
4	1	2771622	4107219	18-7152	-
4	1	5589202	UP	-	18-7102
4.5	1	4107220	UP	18-7152	-
6	2	1408611	2529894	18-7152	-
7.5/9.8/110	2	2810637	3274633	18-7152	-
7.5/9.8/110	2	3274633	UP	18-7152	-
20	2	2031774	2827677	18-7151	-
30	2	1271885	1356947	18-7151	18-7151
30JET	2	C159200	UP	18-7151	18-7161
MK 35 A	2	1217222	1271884	18-7151	18-7151
35	2	1356948	1571113	18-7151	18-7151
35	2	1571114	2874703	18-7172	18-7151
35	2	6445653	UP	18-7167	18-7414
40	4	1279685	2874703	18-7151	18-7151
40	2	2874704	3336257	18-7167	-
40	2	3336258	4117709	18-7167	-
40	2	4117710	5556229	18-7167	18-7414
40	2	5556230	6445653	18-7167	18-7414
40	4	C159200	UP	18-7151	18-7161
45	4	1476510	1531568	18-7151	18-7151
45	4	5531630	UP	18-7151	18-7151
45 JET	3	ALL	-	18-7176	-
50	4	1421113	2858813	18-7151	18-7151
50	4	2855514	UP	18-7151	18-7151
50/60	3	6428681	D000750	18-7415	18-7161
50/55/60	3	D000750	UP	-	18-7176
60	6	1303411	1542744	18-7151	18-7151
65	4	1542745	2803561	18-7172	18-7151
65	4	2803562	3293183	18-7172	18-7151
65	3	3293184	3547986	18-7167	18-7161
65	3	3547987	4571651	18-7415	18-7161
70	6	1296411	1566239	18-7151	18-7151

④ This product is priced per piece. To order priced per package, please add -9 to the part number.

POWERHEAD O-RING APPLICATION (Cont.)

HP	Cyl.	Beginning Serial No.	Ending Serial No.	Upper End Cap	Lower End Cap
70	3	4571652	6428680	18-7415	18-7161
70	3	A996142	UP	18-7414	-
75	4	6432901	A996141	18-7167	18-7161
75	3	A996142	D283221	18-7414	-
80	6	1335465	1566239	18-7151	18-7151
80	4	2559001	4831998	18-7167	18-7151
80	4	4831999	UP	18-7167	18-7161
80	3	A996142	UP	18-7414	-
85	6	1460999	1766823	18-7151	18-7151
85	4	3493913	4831998	18-7167	18-7161
90	6	1766824	1869775	18-7172	18-7151
90	6	4845301	A996141	18-7167	18-7161
90	3	A996142	D283221	18-7414	-
95	6	1869776	2318585	18-7172	18-7151
100	6	1464949	2836018	18-7172	18-7151
100BP	6	2641855	3253111	18-7172	18-7167
100	4	B209468	D283221	18-7414	-
105JET	V-6	D082000	UP	18-0858	18-0860
110	6	1870204	2314955	18-7172	18-7151
115	6	2836019	3525440	18-7167	18-7151
115	6	3525441	C100000	18-7167	18-7161
125	6	2314956	3253111	18-7167	18-7151
135	6	2839369	3293233	18-7167	18-7151
135	V-6	A904646	UP	18-0858	18-0860
140	6	3293234	UP	18-7167	18-7161
140JET	V-6	D082000	UP	18-0858	18-0860
150	6	3502806	5327662	18-7167	18-7161
150	V-6	6042946	UP	18-0858	18-0860
175	V-6	5875204	6618751	-	18-0860
175	V-6	6618751	UP	18-0858	18-0860
200	V-6	5875303	6073191	-	18-0860
200	V-6	6073192	UP	18-0858	18-0860
220	V-6	B117316	UP	18-0858	18-0860
225	V-6	5628028	UP	-	18-0860

LOWER UNIT O-RING APPLICATION

HP	Beginning Serial No.	Ending Serial No.	Bearing Carrier	Water Pump Base	Shift Shaft	Drive Shaft
3.9	1655013	2498135	18-7121	18-7156	18-7180	18-7168
4	2498136	5589201	18-7121	18-7156	18-7180	18-7168
4/4.5	5589203	A809601	18-7171	18-7156	18-7180	-
6	1408611	2529894	18-7171	18-7156	18-7180	18-7168
6	A197112	UP	18-7162	-	-	-
7.5	2529895	3801457	18-7171	18-7156	18-7180	18-7168
7.5	3801458	5206549	18-7171	18-7156	18-7180	-
7.5	5206550	UP	18-7171	18-7156	18-7180	18-7116
8	A197112	UP	18-7162	-	-	-
9.8	1470349	3795657	18-7171	18-7156	18-7180	18-7168
9.8	3795658	5206549	18-7171	18-7156	18-7180	-
9.8	5206550	UP	18-7171	18-7156	18-7180	18-7116
9.9/15	A197112	UP	18-7162	-	-	-
18	5837437	6443972	-	18-7419	-	-
20	1558310	1866494	18-7163	18-7164	18-7180	18-7180
20	1866495	6443972	18-7163	18-7164	18-7180	18-7180
25	5705532	6443972	-	18-7419	-	-
18/20/25XD	6443973	UP	-	18-7419	18-7135 ②	-
30	1271885	1356947	18-7152	18-7115	18-7153	-
30	G055314	UP	-	-	18-7155 ②	-
MK 35A	1217222	1271884	18-7152	18-7115	18-7153	-
35	1356948	1448139	18-7152	18-7115	18-7153	-
35	1571114	1960826	18-7160	18-7155	18-7153	-
35	1960827	2874703	18-7160	18-7155	18-7153	-
35	6445653	UP	18-7160	18-7115	18-7153	-
40	1279685	2874703	18-7152	18-7115	18-7153	-
40	2874704	3336257	18-7160	18-7155	18-7153	-
40	3336258	4117709	18-7160	18-7155	18-7153	-
40	4117710	4860102	18-7160	18-7155	18-7153	-
40	4860103	6445652	18-7160	18-7115	18-7153	-
40 4cyl	C159200	G053313	18-7160	18-7115	18-7153	-
40 2cyl	G055314	UP	-	-	18-7155 ②	-
45	1476510	1531568	18-7160	18-7155	18-7153	-
45 4cyl	5531630	UP	18-7160	18-7115	18-7153	-
50	1421113	1639472	18-7152	18-7155	18-7153	-
50	1639473	1770178	18-7160	18-7155	18-7153	-
50	1770179	2305100	18-7160	18-7155	18-7153	-
50	2305101	2858813	18-7160	18-7155	18-7153	-
50	2858814	4140999	18-7160	18-7155	18-7153	-
50	4141000	4962055	18-7160	18-7155	18-7153	-
50	4962056	5531630	18-7160	18-7155	18-7153	-
50 3cyl	6428681	D000750	18-7160	18-7155	18-7153	-
50/55/60 3 cyl	D000751	UP	-	18-7173	-	-
60	1303411	1542744	-	18-7115	-	-
60	6428681	D000750	18-7160	18-7155	18-7153	-
65	1542745	2874263	18-7157	18-7173	18-7153	18-7158
65	2874263	3293183	18-7157	18-7162	18-7153	18-7158

① Requires 2 ② Shift Shaft Retainer ④ Fits most applications

LOWER UNIT O-RING APPLICATION (Cont.)

HP	Beginning Serial No.	Ending Serial No.	Bearing Carrier	Water Pump Base	Shift Shaft	Drive Shaft
65 3cyl	3293184	4136684	18-7160	18-7155	18-7153	-
65 3cyl	4136685	4571651	18-7160	18-7155	18-7153	-
70	1296411	1413610	18-7114	18-7155 ①	-	-
70	1413611	1566239	18-7157	18-7173	18-7153	18-7158
70 3cyl	4571652	4977156	18-7160	18-7155	18-7153	-
70 3cyl	4977157	5579016	18-7160	18-7115	18-7153	-
70 3cyl	5579017	A996142	18-7160	18-7115	18-7153	-
70/75 3cyl	A996142	UP	-	-	18-7198	-
75 4cyl	6432901	A996142	18-7157	18-7162	18-7153	-
80	1335465	1398629	18-7157	18-7155	18-7153	18-7158
80	1398630	1566239	18-7157	18-7173	18-7153	18-7158
80 4cyl	2559001	3144218	18-7157	18-7157	18-7153	18-7158
80 4cyl	3144219	4831998	18-7157	18-7162	18-7153	-
80 4cyl	4831999	5582561	18-7157	18-7162	18-7153	-
80 4cyl	5582562	A996142	18-7157	18-7162	18-7153	-
80 3cyl	A996142	UP	-	-	18-7198	-
85	1460999	1766823	18-7157	18-7173	18-7153	18-7158
85 4cyl	3493913	4590511	18-7157	18-7162	18-7153	-
85 4cyl	4590512	4831998	18-7157	18-7162	18-7153	-
90	1766824	1869775	18-7157	18-7162	18-7153	18-7158
90	4845301	5594656	18-7157	18-7162	18-7153	-
90	5594657	A996142	18-7157	18-7162	18-7153	-
90 3cyl	A996142	UP	-	-	18-7198	-
95	1869776	2318585	18-7157	18-7173	18-7153	18-7158
100,100SS	1464949	2836018	18-7157	18-7173	18-7153	18-7158
100BP	2399698	2641854	18-7157	18-7173	18-7153	18-7158
100 4cyl	B209468	-	-	-	18-7198	-
110	1870204	2314955	18-7157	18-7173	18-7153	18-7158
115	2836019	3525440	18-7157	18-7173	18-7153	18-7158
115	3525440	41122634	18-7157	18-7173	18-7153	-
115	41122635	4855152	18-7157	18-7162	18-7153	-
115	4855153	5600966	18-7157	18-7162	18-7153	-
115	5600967	C100000	18-7157	18-7162	18-7153	-
115 4cyl	C100000	UP	-	-	18-7198	-
125	2314956	2839368	18-7157	18-7173	18-7153	18-7158
135	2839369	3293233	18-7157	18-7173	18-7153	18-7158
140	3293234	3502805	18-7157	18-7173	18-7153	-
140	4865678	UP	18-7157	18-7162	18-7153	-
150	3502806	4121434	18-7157	18-7173	18-7153	-
150	4121434	5327662	18-7157 ④	18-7162	18-7153	-

V-6

150/150XR2	4868998	5432021	18-7159	18-7162	18-7153	-
150/150XRS	5432021	A904646	18-7159	18-7176	18-7153	-
135/150/XR2	A904646	UP	18-7159	18-7176	18-7153	-
175	4301235	6618750	18-7159	18-7162	18-7153	-
175	6618751	UP	18-7159	18-7176	18-7153	-
200	4839034	6073191	18-7159	18-7162	18-7153	-
200	6073192	UP	18-7159	18-7176	18-7153	-
220	B117316	UP	18-7159	18-7176	18-7153	-
225	5628028	D280813	18-7159	18-7162	18-7153	-
250/275	C101891	UP	18-7159	-	18-7153	-
3.4	5611648	UP	18-7159	-	18-7153	-

① Requires 2 ② Shift Shaft Retainer ④ Fits most applications

SWIVEL BRACKET ASSEMBLY O-RING APPLICATION

HP	Beginning Serial No.	Ending Serial No.	O-Ring	Qty.	Desc.	HP	Beginning Serial No.	Ending Serial No.	O-Ring	Qty.	Desc.
3.9	1655013	2498135	18-7153	2	SB	V 135	A904646	UP	18-7174	1	TT
4	2498136	3529445	18-7153	1	SB	V 150	4868998	UP	18-7164	1	SB
6	1436115	2529894	18-7153	2	SB	V 150	5432022	6606990	18-7168	2	TLL
7.5	2529895	3488152	18-7153	2	SB	V 150	6443213	UP	18-7174	1	TT
9.9	1470349	3482752	18-7153	2	SB	V 175	4301235	UP	18-7164	1	SB
35 ①	B110789	C159199	18-7164	1	SB,U	V 175	5488752	6618750	18-7168	2	TLL
35 ①	B110789	C159199	18-7174	1	TT	V 175	6618751	UP	18-7174	1	TT
45 4 Cyl ①	B110789	UP	18-7174	1	TT	V 200	4839034	UP	18-7164	1	SB
45 4 Cyl ①	B110789	UP	18-7164	1	SB,U	V 200	5464486	6625220	18-7168	2	TLL
50 3 Cyl ①	B122930	C160935	18-7164	1	SB,U	V 200	6625221	UP	18-7174	1	TT
50 3 Cyl ①	B122930	C160935	18-7174	1	TT	V 200 EFI	C100861	UP	18-7174	1	TT
60 3 Cyl ①	B122930	C160935	18-7174	1	TT	V 200 EFI	C100861	UP	18-7164	1	SB
60 3 Cyl ①	B122930	C160935	18-7164	1	SB,U	V 220	B117316	UP	18-7174	1	TT
70	A996142	UP	18-7174	2	TT	V 220	B117316	UP	18-7164	1	SB
70	A996142	UP	18-7164	1	SB	V 225	5628028	UP	18-7164	1	SB
75	6432901	UP	18-7174	2	TT	V 225	5628028	UP	18-7168	2	TLL
75	6432901	UP	18-7164	1	SB	V 250	C101891	UP	18-7168	2	TLL
80	A996142	UP	18-7164	1	SB	V 250	C101891	UP	18-7174	1	TT
80	A996142	UP	18-7174	2	TT	V 275	C101891	UP	18-7174	1	TT
90	6436123	UP	18-7164	1	SB	V 275	C101891	UP	18-7168	2	TLL
90	6436123	UP	18-7174	2	TT	3.4 LT	5611648	UP	18-7168	2	TLL
100	B209468	UP	18-7164	1	SB	3.4 LT	5611648	UP	18-7174	1	TT
100	B209468	UP	18-7174	1	TT	3.4 LT	5611648	UP	18-7164	1	SB
115	6436123	UP	18-7164	1	SB	XR-4/Magnum II	B242885	UP	18-7174	1	TT
115	6436123	UP	18-7174	2	TT	XR-4/Magnum II	B242885	UP	18-7164	1	SB
V 135	A904646	UP	18-7164	1	SB						

① Models with power trim only SB Swivel Bracket SB,U Swivel Bracket, Upper TLL Tilt Lock Lever TT Tilt Tube



**18-5225
SPARK PLUG WIRE KIT**
Kit includes 25 ft. Roll of 7 MM Hypalon Ignition Wire With a Metallic Core and a Large Assortment of Three Different End Fittings to Fit Outboard Motors.



**18-5226
IGNITION WIRE**
Metallic Core
100' Spool
7mm Hypalon

PKG. OF 10



**18-5224
18-5224-9①
SPARK PLUG WIRE TERMINAL**

PKG. OF 10



**18-5750
18-5750-9①
UNIVERSAL SPARK
PLUG BOOTS**
Supplied complete w/Terminal Connector



**18-5752
UNIVERSAL
SPARK PLUG BOOT**
8mm



NEW

**18-6865
COMPLETE TRIM ASSEMBLY**
Replaces: Tohatsu Universal
Fits: Engines with 3-Ram Trim Assembly,



NEW

**18-6823
WIRING HARNESS**
Replaces: Universal
Converts 3-wire Tilt and Trim motors to 2-Wire design



**18-6418
OUTBOARD STARTER**
Replaces: Tohatsu 353-76010-4
Fits: M45A2, M50C, M60A, M70A2, M90A, M140A, NS45A2, NS50C, NS60A, NS70A2, NS90A, NSD90A, NS120A, NS140A (9 Tooth)



**18-6430
OUTBOARD STARTER**
Replaces: Tohatsu B29A-90500A
Fits: 1981-on 2WT60A



**18-6431
OUTBOARD STARTER**
Replaces: Tohatsu 346-76010-0A0
Fits: 2cyl Engines 40C, 50C & 50A, 70A, NS25C, NS30A, NS35C, NS40C



**18-6432
OUTBOARD STARTER**
Replaces: Tohatsu 3C8-76010-1
Fits: M50D, M60B, M60C, MD40D, MD50A, MFS25A, MFS30A, NS40D, NS50D, NS60C, NS70B, NS70C, NSD25A, NSD30A, NSD50A

① Priced per Package



**18-56001
BRUSH
HOLDER ASSEMBLY**
Fits:90-140 HP 2 Stroke
Use with **18-6418** Starter Assembly



**18-56002
BRUSH
HOLDER ASSEMBLY**
Replaces: 3C8-75014-0
Fits: 25-70 HP 2 Stroke
Use with **18-6432** Starter Assembly



**18-7712
FUEL FILTER (INLINE)**
Replaces: 369022300M
Fits: 2 stroke, 5 HP thru 9.8 HP/4 stroke, 4 HP thru 30 HP



FUEL FILTERS

18-7828-1
(1/4" Small) Small Capacity
(For 1/4" Fuel Line)

18-7829
(1/4" Large) Large Capacity
(For 1/4" Fuel Line)

18-7830 (5/16")
18-7831 (3/8")

FUEL WATER SEPARATORS



Sierra offers a complete line of 10 and 21 micron fuel water separating filters including drainable bowl filters to protect your carbureted and fuel injected engine.

Refer to pages 126-130 for a complete listing of OEM and universal applications.

Sierra fuel water separators remove over 99.8% of emulsified water from your gasoline. Sierra's 10 micron filters are over 90% efficient at removing particles as small as 10 micron. All filters flow @ 90 GPH to feed even the hungriest motor. Sierra 10 micron filters are recommended to prevent damage to sensitive inboard and outboard fuel injection systems.

8' LENGTH COMPLETE FUEL LINE ASSEMBLIES

3/8"
FUEL LINE ASSEMBLY



**18-8078
TANK
CONNECTOR**
(SOLD SEPARATELY)

*

18-8027EP-1 SILVERADO 4000 Premium



**18-8079
FUEL
CONNECTOR**



**18-8005EP-1
PRIMER
BULB**



**18-8088
FUEL
CONNECTOR**



**18-8089
FUEL
CONNECTOR**
(SOLD SEPARATELY)

*

FUEL LINE ASSEMBLY COMPONENTS

* Tanks and Engines for picture purpose only.



18-8002EP-1
18-8002EP-1-10②
PRIMER BULB
1/4"



18-8004EP-1
18-8004EP-1-10②
PRIMER BULB
5/16"
Large capacity bulb

18-8005EP-1
18-8005EP-1-10②
PRIMER BULB
3/8"
Large capacity bulb



18-8078
TANK CONNECTOR
1/4" N.P.T .508 O.D.
Nissan Tank Large Inlet
Fits: All models
Mates with 18-8079
(Male)



18-80410
FUEL CONNECTOR
Replaces: 394-70250-0
5/16"
(Female)
Fits: 4HP-30HP 4-stroke
Mates with 18-80417



18-80417
FUEL CONNECTOR
Replaces: 394-70260-0
Fits: 4HP-30HP 4-stroke
Mates with 18-80410



18-8079
FUEL CONNECTOR
Large Inlet
Replaces: 3B2-70281-0, 65750-95500
Fits: All models
Mates with 18-8078
(Female)



18-8088
FUEL CONNECTOR
(Engine End)
Replaces: 345-70250-0
3/8" Hose
Fits: 5-90HP 2-stroke and TLDI models
Mates with 18-8089



18-8089
FUEL CONNECTOR
(Engine End)
Replaces: 3B2-70260-0
(Metric Threads)
5/16" Hose
Fits: 5-90HP 2-stroke and TLDI models
Mates with 18-8088



PKG. OF 10



SNAPPER CLAMPS
18-8020 **18-8021**
18-8020-9① **18-8021-9①**
#8 For 5/16" Hose #10 For 3/8" Hose

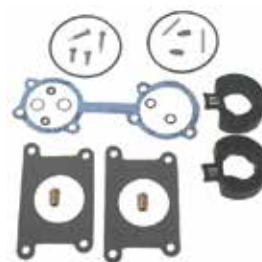

18-7290
CARB KIT
Replaces: 345-87122-0
Kit contains enough components to rebuild 2 carburetors
FOR: ALL 35/40C HP (1 per engine)



18-7291
CARB KIT
Replaces: 346-87122-0
FOR: ALL 25/30 HP (1 per engine);
ALL 45A2, 50C, 60C, 70A2 (2 per engine)



18-7765
CARB KIT
Replaces: 369-87122-1
FOR: ALL 4/5 HP (1 per engine)



18-8920
IMPELLER
Replaces: 3B2-65021-1
Fits: 8 (8B models), 9.8 (9.8B model), 8
4-Stroke (All), 9.8 4-Stroke (All)



18-8921
IMPELLER
Replaces: 334-65021-0
Fits: 9.9 (All), 15 (All), 18 (All), 9.9
4-Stroke (All B Models), 15 4-Stroke (All
B Models), 18 4-Stroke (All)



18-8922
IMPELLER
Replaces: 3C8-65021-2
Fits: 40 3-cyl (D models), 40 TLDI
2-Stroke (All) 50 3-cyl (D models), 50
TLDI 2-Stroke (All), 70 TLDI 2-Stroke
(All), 90 TLDI 2-Stroke



18-8923
IMPELLER
Replaces: 345-65021-0
Fits: 25 (25C model), 25 4-Stroke (All A
Models, B Models with white bushing),
30 (30A model), 30 4-Stroke (All A
Models, B models with white bushing),
40 2-cyl (40C model)



18-8924
IMPELLER
Replaces:
3C7-65021-1, 3B7-65021-2
Fits: 60 3-cyl (B & C models), 70 3-cyl (B
& C models), MD 70, MD 90 (TLDI), 115,
140, 90 2-Stroke



18-7911-1
OIL FILTER
Replaces: 3R0076150M
Fits: 9.9-30HP

① Priced per Package

② Discount shop pack of 10 - Priced per package



Suzuki Model Identification

Model Description	Horsepower	Model Variation Length	Shaft Year	Model
DT = 2-cycle DF = 4-cycle PU = Jet Drive	Examples: 9.9 40 115 250	E - Elec. Start w/Tiller Handle R - Elec. Start w/Remote Control C - Oil Injection G - Counter Rotation N - High Thrust Propeller T - Power Tilt & Trim w/Elec. Start w/Remote Control H - Power Tilt & Trim w/Elec. Start w/Tiller Handle SF - Super Four SS - Super Six M - Manual Start w/Tiller Handle V - Comlink Voice Caution System	S = 15" L = 20" X = 25"	D = 1983 E = 1984 F = 1985 G = 1986 H = 1987 J = 1988 K = 1989 L = 1990 M = 1991 N = 1992 P = 1993 R = 1994 S = 1995 T = 1996 V = 1997 W = 1998 X = 1999 Y = 2000 K1 = 2001 K2 = 2002 K3 = 2003 K4 = 2004 K5 = 2005 K6 = 2006 K7 = 2007 K8 = 2008

EXAMPLE: DT40CRSN - 2-cycle, 40 HP, Oil Injection, Elec. Start w/remote control, 15", 1992 Model Year

	
<p>18-5225 SPARK PLUG WIRE KIT Kit includes 25 ft. Roll of 7 MM Hypalon Ignition Wire With a Metallic Core and a Large Assortment of Three Different End Fittings to Fit Outboard Motors.</p>	<p>18-5226 IGNITION WIRE Metallic Core 100' Spool 7mm Hypalon</p>

<p>PKG. OF 10</p> 	<p>PKG. OF 10</p> 	
<p>18-5224 18-5224-9① SPARK PLUG WIRE TERMINAL</p>	<p>18-5750 18-5750-9① UNIVERSAL SPARK PLUG BOOTS Supplied complete w/Terminal Connector</p>	<p>18-5752 UNIVERSAL SPARK PLUG BOOTS 8mm</p>

	
<p>18-6416 OUTBOARD STARTER Replaces: Suzuki 31100-94610 Fits: 115, 140 H.P. (9 Tooth) (1984-UP)</p>	<p>18-6417 OUTBOARD STARTER Replaces: Suzuki 31100-92E00 Fits: 150, 200, 225 H.P. (1985-UP)</p>

① Priced per Package



18-6429
OUTBOARD STARTER
Replaces: Suzuki 31100-94702
Fits: DT 55/65 (1985-88)



18-6414
OUTBOARD STARTER
Replaces: Suzuki 31100-95600
Fits: 75 HP



18-6419
OUTBOARD STARTER
Replaces: Suzuki/Nissan 31100-89J00
Fits: 4 Stroke DF40 (1999-01) (8 tooth)



18-6827
STARTER
Replaces: 31100-94600, 31100-94601,
31100-94610
Fits: 115, 140HP engines



18-6831
STARTER
Replaces: Suzuki 31100-90J00, Hitachi
S114-837, A
Fits: Suzuki 90-115HP 2001-08



18-6941
STARTER
Replaces: 31100-93J00, 96J00, 96J01
Fits: 70-300HP 2004-up



18-6945
STARTER
Replaces: Suzuki 31100-95J00, 95J01
Fits: Johnson, Suzuki 25HP 2006-11



18-56008
BRUSH HOLDER ASSY
Replaces: 31173-95310
Fits: 90-100, 150-225 HP 2 Stroke
Use with 18-6414 Starter



**18-56009
BRUSH HOLDER ASSY**
Replaces: 31173-99E00
Fits: 115-140 HP 2 Stroke
Use with 18-6416 Starter



**18-9802
TIMING LIGHT**
Self-powered accurate up to 10,000 RPM's



**MP51010 – CLAMSHELL
MP51012 – BULK 100 PCS/CTN
IGNITION SWITCH**
Suzuki 2 & 4 Stroke Outboards
Replaces: 37110-99E00
Colors on wires match factory color codes



**18-6793
TRIM MOTOR**
Replaces: 38100-87J11, 38100-87J20
Fits: DF40, DF50 (2001-08)



**18-6785
TILT/TRIM MOTOR**
Replaces: 38100-87E10-0ED,
38100-87000-0IT, 38100-87E20-0ED
For: V-4 & V-6 1986-1990
V-6/3 wire hook-up 3 bolt flange



**18-6786-1
TILT/TRIM MOTOR**
Replaces: 38100-87D10-0ED,
38100-87D10-35J, 38100-87D10-0IT,
38100-92E00-0ED
For: V4 & V6 (1990-up), DT90 (1991-97), DT100 &
DT200 (1991-2000), DT150 & DT225 (1991-2003),
DT175 (1991-92)
3 Bolt flange 2 wire connection



**18-6837
TRIM MOTOR**
Replaces: 38100-87J11, 38100-87J20
Fits: 40-50HP 4-Stroke Engines



**18-6865
COMPLETE TRIM ASSEMBLY**
Replaces: Suzuki 48600-94511-0ED
Fits: Engines with 3-Ram Trim Assembly, 115-225HP
Johnson/Evinrude Engines



**18-6823
WIRING HARNESS**
Replaces: Universal
Converts 3-wire Tilt and Trim motors to 2-Wire design

4 STROKE FUEL SYSTEM KITS



**18-7761
CARBURETOR
REBUILD KIT**
Fits: Suzuki DF4-DF6 (2005 & Up)



**18-7773
CARB KIT**
Replaces: 13910-89J01
Fits: DF 25/30 (All Years)



**18-3495
DIAPHRAGM KIT**
Replaces: 15170-93911
Fits: DT8(All 1988-97), DT9.9(All 1988-97),
DT15(All 1988-97)



**18-3496
DIAPHRAGM KIT**
Replaces: 15170-94320
Fits: DT25(All 1989-99), DT30(All 1989-
99), DT40(All 1986-98), DT55(All 1988-
97), DT65(All 1988-97)



**18-3497
DIAPHRAGM KIT**
Replaces: 15170-91J00
DF4-DF6 (2003 & UP)



**18-3498
DIAPHRAGM KIT**
Replaces: 15170-94J00, 15170-94J0V
DF9.9-DF15 HP(2005 & UP)



**18-3499
DIAPHRAGM KIT**
Replaces: 15170-99E00
DF9.9,DF15 (1997-2004), DF25 (2000-2006)
(Non-V twin), DF40,DF50 (1999-2006),
DF60,DF70 (1998-2007),

2 STROKE FUEL SYSTEM KITS

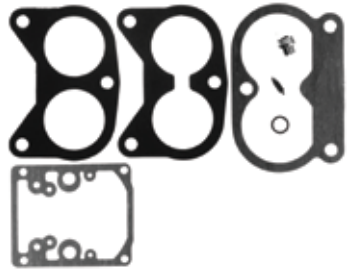

18-7752
CARB KIT
Replaces: 13910-87D00



18-7753
CARB KIT
Replaces: 13910-94400



18-7754
CARB KIT
Replaces: 13910-94701



18-7755
CARB KIT
Replaces: 13910-95D00

CARBURETOR KIT APPLICATION

HP/Model	Year	Part #	HP/Model	Year	Part #	HP/Model	Year	Part #
DT25C	1989-98	18-7755	DT65	1985-97	18-7753	DT100	1989-98	18-7752
DT30C	1988-97	18-7755	DT75	1985-97	18-7754	DT115	1986-98	18-7754
DT40C	1984-98	18-7753	DT85	1985-98	18-7753	DT140	1986-98	18-7753
DT55	1985-97	18-7754	DT90	1989-97	18-7752	V-6	ALL	18-7752

FUEL WATER SEPARATORS



Sierra offers a complete line of 10 and 21 micron fuel water separating filters including drainable bowl filters to protect your carbureted and fuel injected engine.

Refer to pages 126-130 for a complete listing of OEM and universal applications.

Sierra fuel water separators remove over 99.8% of emulsified water from your gasoline. Sierra's 10 micron filters are over 90% efficient at removing particles as small as 10 micron. All filters flow @ 90 GPH to feed even the hungriest motor. Sierra 10 micron filters are recommended to prevent damage to sensitive inboard and outboard fuel injection systems.

Sierra #	Suzuki #	Description
18-7953	15410-87J30	Fuel Filter Fits: DF25, DF70, DF90, DF115, DF140 (Incl.140T & 140Z) (2006 & Newer)
18-7936	15412-93J00	Fuel Filter Element
18-7947	99105-20006	Spin on Replacement Filter
18-7987	99105-20006-BWL	AquaVue™ Mini Collection Bowl
18-7948	99105-20005	Spin on Replacement Filter
18-7922	99105-20004BWL	AquaVue™ Collection Bowl
18-7735	15410-94400	Fuel Filter Kit
18-7711	15410-96J00	Fuel Filter (Inline)
18-7716	15410-87J10	Fuel Filter
18-7719	15410-98500	Fuel Filter

8' LENGTH COMPLETE FUEL LINE ASSEMBLIES

3/8"
FUEL LINE ASSEMBLY

18-8018EP-1 *SILVERADO 4000 Premium*

OE# 65700-95513



18-8078
TANK
CONNECTOR
(SOLD SEPARATELY)

*



18-8079
FUEL
CONNECTOR

18-8005EP-1
PRIMER
BULB

18-8079
FUEL
CONNECTOR



*

FUEL LINE ASSEMBLY COMPONENTS

8' LENGTH COMPLETE FUEL LINE ASSEMBLIES

3/8"
FUEL LINE ASSEMBLY

18-8019EP-1 *SILVERADO 4000 Premium*



18-8071
TANK
CONNECTOR
(SOLD SEPARATELY)

*



18-8062
FUEL
CONNECTOR

18-8005EP-1
PRIMER
BULB

18-8062
FUEL
CONNECTOR



*

FUEL LINE ASSEMBLY COMPONENTS

6' LENGTH COMPLETE FUEL LINE ASSEMBLIES

3/8"
FUEL LINE ASSEMBLY

18-8035EP-1 *SILVERADO 4000 Premium*

OE# 65700-87J10



18-8078
TANK
CONNECTOR
(SOLD SEPARATELY)

*



18-80405
FUEL
CONNECTOR

18-8005EP-1
PRIMER
BULB

18-80404
FUEL
CONNECTOR



*

FUEL LINE ASSEMBLY COMPONENTS

Fits: DF25-140 HP (2000-05)



18-8002EP-1
18-8002EP-1-10①
PRIMER BULB
1/4"

18-8004EP-1
18-8004EP-1-10①
PRIMER BULB
5/16"

Large capacity bulb

18-8005EP-1
18-8005EP-1-10①
PRIMER BULB
3/8"

Large capacity bulb



18-80409
FUEL CONNECTOR
Motor Side
Replaces: 65720-94401
Fits: DT4-DT65
Mates with 18-80418



18-80418
FUEL CONNECTOR
Replaces: 65750-94404
Fits: DT4-DT140
Mates with 18-80409 & 18-8087





















18-80419
FUEL CONNECTOR
Replaces: 65750-87J10, 65750-87J11
Fits: DF25-DF140 (5/16" version of 18-80404)
Mates with 18-80425



18-80425
FUEL CONNECTOR
Replaces: 65720-986B0
Fits: DF25-DF140
Mates with 18-80404 & 18-80419



* Tanks and Engines for picture purpose only. ① Discount shop pack of 10 - Priced per package

 <p>18-8062 FUEL CONNECTOR Replaces: 65750-98505 Mates with 18-8071</p>	 <p>18-8071 TANK CONNECTOR 1/4" NPT .432 O.D. Replaces: 99105-00192 Mates with 18-8062 (Male)</p>	 <p>18-8078 TANK CONNECTOR 1/4" N.P.T .508 O.D. Replaces: 65740-95500, 99105-00193 Fits: All models Mates with 18-8079 (Male)</p>	 <p>18-8079 FUEL CONNECTOR (Tank End) Replaces: 65750-95510, 65750-95500 Fits: All models Mates with 18-8078 (Female)</p>
 <p>18-8087 FUEL CONNECTOR Motor Side Replaces: 65720-94411 Fits: DT75-DT140 Mates with 18-80418</p>	 <p>18-80404 FUEL CONNECTOR 3/8" Fits: DF25-DF140 HP Mates with 18-80425</p>	 <p>18-80405 FUEL CONNECTOR Female to 3/8" hose barb Mates with 18-8078</p>	 <p>18-8090 FUEL CONNECTOR (1/4" NPT)</p>
 <p>18-3000 IMPELLER Replaces: 17461-92D02 Fits: DT 8C/9.9C (1989-97)</p>	 <p>18-3035 IMPELLER Replaces: 17461-93J00 For: DF200, DF225, DF250 (2004-05)</p>	 <p>18-3049 IMPELLER Replaces: 17461-87E11, 17461-87E12 Fits: DF 60/70 (1998-01), DF 90-100 (1989-01)</p>	 <p>18-3023 IMPELLER Replaces: 17461-90J00, 17461-90J01, 17461-94500, 17461-94501, 17461-94502, 17461-94503, 17461-94504, 17461-94505, 17461-94506, 17461-94510, 17461-94511, 17461-94520 Fits: 2 Stroke DF90, DF115, DF140 (2000-05), DT115 (1981-01), DT140 (1981-01), DT150 (1986-01), DT200 (1986-00)</p>
 <p>18-3092 IMPELLER Replaces: 17461-93001, 17461-93003, 17461-93004</p>	 <p>18-3094 IMPELLER Replaces: 17461-94700, 17461-94701</p>	 <p>18-3095 IMPELLER Replaces: 17461-95300, 17461-95301, 17461-95302</p>	 <p>18-3096 IMPELLER Replaces: 17461-96301, 17461-96311, 17461-96312</p>
 <p>18-3097 IMPELLER Replaces: 17461-98501, 17461-98502, 17461-98503</p>	 <p>18-3099 IMPELLER Replaces: 17461-93902, 17461-93901, 17461-93903 For: DT 9.9, 15 (1983-97), DF 9.9, 15 (1997-05)</p>	 <p>18-3291 IMPELLER KEY Replaces: 09420-05006 Fits: V-6 2-Stroke (1986-03), DF90 /115/140(2001-04)</p>	 <p>18-3292 IMPELLER KEY Replaces: 17462-93990 Fits: DT 8C/9.9C (1989-97), DF 9.9/15 (1997-04), DT 9.9 (1985-87), DT 15 (1983-88), DT 15C (1989-97)</p>
 <p>18-3296 IMPELLER KEY Replaces: 09420-05005 Fits: DT 115/140 (1983-01)</p>	 <p>18-3404 IMPELLER KEY Replaces: 09420-04009 Fits: DF 60/70 (1998-01), DF 90-100 (1989-01)</p>	 <p>18-3188 IMPELLER PLATE Replaces: 17471-98503 Fits: DT 6 (1984-02), DT 8 (1986-97)</p>	 <p>18-3189 IMPELLER PLATE Replaces: 17471-87D01 Fits: V-6 2-Stroke (1986-03)</p>



**18-3190
IMPELLER PLATE**
Replaces: 17471-93902
Fits: DF 9.9/15 (1997-04), DT 9.9 (1985-87), DT 15 (1983-88), DT 15C (1989-97)



**18-3191
IMPELLER PLATE**
17471-94501
Fits: DT 115/140 (1983-01)



**18-3192
IMPELLER PLATE**
17471-87E01
Fits: DF 60/70 (1998-01), DF 90-100 (1989-01), DF 90/115/140 (2001-04)



**18-3193
IMPELLER PLATE**
17471-92D10
Fits: DT 8C/9.9C (1989-97)



**18-3242
IMPELLER REPAIR KIT**
Replaces: 17400-96350, 17400-96351



**18-3243
IMPELLER REPAIR KIT**
Replaces: 17400-94700

— CONTAINS —

Part #	Description	O.E. #
18-3096	Impeller	17461-96311
18-0461	Gasket	17472-96301

MODEL	YEAR	MODEL	YEAR
DT20	1986-88	DT35	1987-89
DT25	1984-88	DT40C	1984-88
DT30	1984-87		

— CONTAINS —

Part #	Description	O.E. #
18-3094	Impeller	17461-94700
18-0460	Gasket	17472-95310

MODEL	YEAR	MODEL	YEAR
DT55	1985-95	DT65	1985-95



**18-3244
IMPELLER REPAIR KIT**
Replaces: 17400-95550
Fits: DT75, DT85 (1985-95)

— CONTAINS —

Part #	Description	O.E. #
18-3095	Impeller	17461-95300
18-0459	Gasket	17472-95200



**18-3253
WATER PUMP KIT**
Replaces: 17400-87D11
Fits: V6 2-Stroke (1986-03)



**18-3254
WATER PUMP KIT**
Replaces: 17400-87E03
Fits: DF 60/70 (1998-06), DT 90-100 (1989-01)



**18-3255
WATER PUMP KIT**
Replaces: 17400-92D01
Fits: DT 8C/9.9C (1989-97)



**18-3256
WATER PUMP KIT**
Replaces: 17400-93951
Fits: DF 9.9/15 (1997-06), DT 9.9 (1985-87), DT 15 (1983-88), DT 15C (1989-97)



**18-3257
WATER PUMP KIT**
Replaces: 17400-94611
Fits: DT 115/140 (1983-01)



**18-3258
WATER PUMP KIT**
Replaces: 17400-90J11
Fits: DF 90/115/140 (2001-05)



**18-3259
WATER PUMP KIT**
Replaces: 17400-98551
Fits: DT 6 (1984-02), DT8 (1986-97)



**18-3260
WATER PUMP KIT**
Replaces: 17400-98652
Fits: DT 4 (1984-98), DT 5 (1999-02)



**18-3264
WATER PUMP REPAIR KIT**
Replaces: 17400-93J00
For: DF200, DF225, DF250 (2004-09)

IMPELLER APPLICATION ON NEXT PAGE



**18-3266
WATER PUMP
REPAIR KIT**
Replaces: 17400-98661
For: DF4, DF6 (2003-07)



**18-3267
WATER PUMP KIT**
Replaces: 17400-98J00
Fits: DF300 (2007-Current)



NEW

**18-3480
WATER PUMP HOUSING**
Replaces: 17411-93901
Fits: DT9.9(1983-87, 2004-10),
DT15(1983-97, 2004-10)



NEW

**18-3481
WATER PUMP HOUSING**
Replaces: 17411-94421
Fits: DF25(All models 2000-05)
DF25(models DF25Q, DF25Q(QR), DF25T 2006-07),
DF30(All 2000-07), DT40C(1986-98),
DF40(All 2000-07), DF50(All 1999-10)



**18-0761
PUMP CASE GASKET**
Replaces: 17472-91J00
For: DF4 (2003-05), DF6 (2003-05)



**18-0778
PUMP CASE GASKET**
Replaces: 17472-93J00
For: DF150(2006-10), DF175(2006-10),
DF200(2004-10), DF225(2004-10),
DF250(2004-10)



**18-0459
WATER PUMP GASKET**
Replaces: 17472-95200



**18-0460
WATER PUMP GASKET**
Replaces: 17472-95310



**18-0461
WATER PUMP GASKET**
Replaces: 17472-96301

PKG. OF 5



**18-0477-9^①
WATER PUMP GASKET**
Replaces: 17472-98503
Fits: DT 6 (1984-02), DT8 (1986-97)



**18-0478
WATER PUMP GASKET**
Replaces: 17472-93911
Fits: DF 9.9/15 (1997-04), DT 9.9
(1985-87), DT 15 (1983-88),
DT 15C (1989-97)



**18-0479
WATER PUMP GASKET**
Replaces: 17472-92D10
Fits: DT 8C/9.9C (1989-97)



**18-0480
WATER PUMP GASKET**
Replaces: 17472-98611
Fits: DT 4 (1984-98), DT 5 (1999-02)



**18-0792
THERMOSTAT GASKET**
Replaces: 13119-91J00



**18-0793
THERMOSTAT GASKET**
Replaces: 17582-93J00



**18-0794
THERMOSTAT GASKET**
Replaces: 17685-97J00



**18-0795
THERMOSTAT GASKET**
Replaces: 17685-89J00



**18-0796
THERMOSTAT GASKET**
Replaces: 17685-99E00



**18-0797
THERMOSTAT GASKET**
Replaces: 17685-87D10

HP/Model	Year	Impeller	Gasket	Water Pump Kit	HP/Model	Year	Impeller	Gasket	Water Pump Kit
DT2/2.2	1983-97	18-3097	—	—	DT50M	1980-84	18-3094	18-0460	18-3243
DT3.5	1983-84	18-3097	—	—	DF50	1999-09	18-3096	18-0461	18-3242
DT4	1984-98	18-3097	18-0480	18-3260	DF50	2010	18-3096	18-0461	—
DF4	2003-10	18-3097	18-0761	18-3266	DT55	1985-97	18-3094	18-0460	18-3243
DT5	1977-83, 1999-02	18-3097	18-0480	18-3260	PU55 (jet)	1989-94	18-3094	18-0460	—
DT6	1984-02	18-3097	18-0477-9	18-3259	DT60	1983	18-3094	18-0460	18-3243
DF6	2003-10	18-3097	18-0761	18-3266	DT60	1984	18-3095	18-0460	—
DT8	1980-87	18-3097	18-0477-9	18-3259	DF60	1998-09	18-3049	—	—
DT8	1988-97	18-3000	18-0479	18-3255	DF60	2010	18-3096	18-0461	—
DF8	2010	18-3099	—	—	DT65	1982-prior	18-3094	18-0459	—
DT9.9	1977-82	18-3092	—	—	DT65	1985-97	18-3094	18-0460	18-3243
DT9.9	1983-87	18-3099	18-0478	18-3256	DF70	1998-09	18-3049	—	—
DT9.9	1988-97	18-3000	18-0479	18-3255	DF70	2010	18-3096	18-0461	—
DF9.9	1997-10	18-3099	18-0478	18-3256	DT75	1983-97	18-3095	18-0459	18-3244
DT14	1977-80	18-3092	—	—	DF80	2009-10	18-3049	—	—
DT15	1983-97	18-3099	18-0478	18-3256	DT85	1983-00	18-3095	18-0459	18-3244
DT15C	1989-97	18-3099	18-0478	—	PU85 (jet)	1989-97	18-3095	18-0459	—
DF15	1997-10	18-3099	18-0478	18-3256	DT90	1989-97	18-3049	—	18-3254
DT16	1977-82	18-3092	—	—	DF90	2001-08	18-3023	—	—
DT20	1986-88	18-3096	18-0461	18-3242	DF90	2009-10	18-3049	—	—
DT25	1980-82	18-3092	—	—	DT100	1987-01	18-3049	—	18-3254
DT25	1983-88	18-3096	18-0461	18-3242	DF100	2009-10	18-3023	—	—
DF25	2000-06	18-3096	18-0461	18-3242	DT115	1986-01	18-3023	—	18-3257 **
DF25 V-Twin	2006-10	18-3096	18-0461	—	DF115	2001-10	18-3023	—	18-3258 *
DT30	1983-87	18-3096	18-0461	18-3242	DT140	1986-01	18-3023	—	18-3257
DT30	1988-97	—	18-0461	—	DF140	2002-10	18-3023	—	—
DF30	2000-07	18-3096	18-0461	18-3242	DT150	1986-03	18-3023	—	18-3253
DT35	1980-82	18-3094	18-0459	—	DF150	2006-10	18-3023	18-0778	—
DT35	1987-89	18-3096	18-0461	18-3242	DT175	1987-92	18-3023	—	18-3253
DT40	1980-82	18-3094	18-0459	—	DF175	2006-10	18-3023	18-0778	—
DT40	1983	18-3096	18-0460	—	DT200	1986-00	18-3023	—	18-3253
DT40/DT40C	1984-98	18-3096	18-0461	18-3242	DF200	2004-10	18-3035	18-0778	18-3264
DF40	1999-09	18-3096	18-0461	18-3242	DT225	1990-03	18-3023	—	18-3253
DF40	2010	18-3096	18-0461	—	DF225	2004-10	18-3035	18-0778	18-3264
PU40 (jet)	1989-94	18-3096	18-0461	—	DF250	2004-10	18-3035	18-0778	18-3264
DT50	1982-prior	18-3094	18-0459	—	DF300	2007-10	18-3035	18-0651	18-3267
DT50	1983-84	18-3094	18-0460	18-3243	—	—	—	—	—





① Priced per Package

* SN 681517 & earlier

** SN 812175 & Later





		O.E. INTERCHANGE		
		Part #	Description	O.E. #
		18-39480	Piston Rings	12140-93121
		18-39530	Piston Rings	12140-96351-050
		18-39540	Piston Rings	12140-94400
		18-40110	Piston Kit	12110-94400
		18-40140	Piston Kit	12110-93120
		18-42850	Piston Pin	12151-94400
		18-42860	Wrist Pin	12151-93100
		18-42870	Wrist Pin	12151-92502
		18-42940-9	① ② Circlips	09381-14001
		18-42950-9	① ② Circlips	09381-18002
18-42960-9	① ② Circlips	09381-20003		

		PISTON		RINGS		WRIST PIN		CIRCLIP	
HP/Model	Years	Std.	.50mm	Std.	.50mm	Std.	.50mm	Std.	.50mm
DT9.9	1983-87	18-40140	—	18-39480	—	18-42860	—	18-42940-9	—
DT15	1983-88	18-40140	—	18-39480	—	18-42860	—	18-42940-9	—
DT25	1983-88	—	—	—	18-39530	—	18-42870	—	18-42950-9
DT30	1983-87	—	—	—	18-39530	—	18-42870	—	18-42950-9
DT40	1984-98	18-40110	—	18-39540	—	18-42850	—	18-42960-9	—

 <p>18-1757 CONNECTING ROD Replaces: 12161-93902 Fits: DT9.9, DT15 (1983-97)</p>	 <p>18-1758 CONNECTING ROD Replaces: 12161-96300 Fits: DT25 (1983-88), DT30 (1983-87)</p>	 <p>18-1759 CONNECTING ROD Replaces: 12161-94400 Fits: DT 40 (1984-98)</p>	 <p>18-1757K CONNECTING ROD KIT Replaces: 12161-93902 Fits:DT9.9 (1983-87), DT15 (1983-97)</p>
--	---	---	--

 <p>18-1759K CONNECTING ROD KIT Replaces: 12161-94400 Fits: DT40 (1986-98)</p>	 <p>18-1412 ROD BEARING Replaces: 09263-20051 Fits: DT9.9 (1983-87), DT15 (1983-97)</p>	 <p>18-1414 ROD BEARING Replaces: 09263-14022 Fits:DT9.9 (1983-87), DT15 (1983-97), DT14/16 (1980-82)</p>	 <p>18-1415 ROD BEARING Replaces: 09263-18016 Fits: DT25 (1983-88), DT30 (1983-87)</p>
---	--	---	---

 <p>18-1416 ROD BEARING Replaces: 09263-27005 Fits: 40 (1984-98)</p>	 <p>18-1417 WRIST PIN BEARING Replaces: 09263-20072 Fits: 40 (1984-98)</p>	 <p>18-3806 HEAD GASKET Replaces: 11141-98401</p>	 <p>18-3807 HEAD GASKET Replaces: 11141-98101</p>
--	--	--	---

 <p>18-3808 HEAD GASKET Replaces: 11141-93901</p>	 <p>18-3809 HEAD GASKET Replaces: 11141-96303</p>	 <p>18-3810 HEAD GASKET Replaces: 11141-94401</p>	 <p>18-3813 HEAD GASKET Replaces: 11141-95305</p>
---	---	--	---

① Priced per Package

② Pkg. of 2

APPLICATION BEGINS ON NEXT PAGE



18-3814
HEAD GASKET
Replaces: 11141-95505



18-3816
HEAD GASKET
Replaces: 11141-98504, 11141-98522



18-3817
HEAD GASKET
Replaces: 11141-92D01

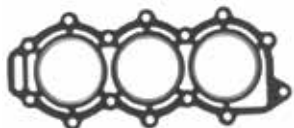

18-3819
HEAD GASKET
Replaces: 11141-95D90



18-3820
HEAD GASKET
Replaces: 11141-94701, 11141-94702



18-3822
HEAD GASKET
Replaces: 11141-87E90



18-3823
HEAD GASKET
Replaces: 11141-94506



18-3824
HEAD GASKET
Replaces: 11141-94600



18-3825
HEAD GASKET
Replaces: 11141-87D90

Model	Year	Cyl	Head Gasket	Model	Year	Cyl	Head Gasket	Model	Year	Cyl	Head Gasket
2	1983-89	1	18-3806	25	1989	3	18-3819	85	1983-87	3	18-3814
5	1983	2	18-3816	30	1983-87	2	18-3809	90	1989	V-4	18-3822
6	1984-89	2	18-3807	30	1988-89	3	18-3819	100	1989	V-4	18-3822
8	1983-87	2	18-3807	35	1987-89	2	18-3810	115	1983-85	4	18-3823
8	1988-89	2	18-3817	40	1984-89	2	18-3810	115	1986-89	4	18-3824
9.9	1983-87	2	18-3808	50	1984	2	18-3813	140	1983-85	4	18-3823
9.9	1988-89	2	18-3817	55	1985-89	3	18-3820	140	1986-89	4	18-3824
15	1983-89	2	18-3808	65	1985-89	3	18-3820	150	1986	V-6	18-3825
25	1983-88	2	18-3809	75	1983-87	3	18-3814	200	1986	V-6	18-3825



18-7896
OIL FILTER
Replaces: 16510-61A20-MHL
Fits: DF70A, DF80A, DF90A, DF90-DF115



18-7897
OIL FILTER
Replaces: 16510-82703
Fits: DF140



18-7903
OIL FILTER
Replaces: 16510-05240
For: DF9.9, DF15 (1996-06)



18-7905
OIL FILTER
Replaces: 16510-96J00
Fits: DF150-DF300



18-7915-1
OIL FILTER
Replaces: 16510-87J00,
Fits: DF25-DF70



**18-0650
OIL SEAL
HOUSING GASKET**
Replaces: 56132-95J00
Fits: F 25 V-Twin (2006-07)



**18-0651
PUMP CASE
PANEL GASKET**
Replaces: 17472-98J00
Fits: F300 (2007)



PKG. OF 5
**18-8331
18-8331-9①
DRAIN PLUG GASKET**
Replaces: 09168-10022



**18-8334
SHIFT SHAFT SEAL**
Replaces: 25223-94400



PKG. OF 10
COTTER PINS
Part # Replaces
18-3737 ② 09204-02004
For: DT9.9 & 15C, DF9.9 & 15, 8 & 9.9C
Oil Injected
18-3735 ② 09204-03003,
09204-03004
For: DT20, 25C, 30C



**18-3726
PROP NUT**
Replaces: 09141-18005



**18-3710
PROP NUT**
Replaces: 09141-14008



**18-3774
PROP NUT KIT**
Replaces: 57630-94500
For: DT75/85/90/100/115, 140
with V-Style, DF60/70 with V Style
— CONTAINS —
Part # O.E. # Desc.
18-3726 09141-18005 Prop Nut
18-3735 09204-03003, 09204-03004 Cotter Pin
— 09160-18028 Washer
18-3798 57633-94500 Spacer



**18-3775
PROP NUT KIT**
Replaces: 57630-92E00
For: V-6
— CONTAINS —
Part # O.E. # Description
18-3726 09141-18005 Prop Nut
18-3735 09204-03003, 09204-03004 Cotter Pin
— 09160-18019 Washer
18-3795 57633-87D30 Spacer



**18-3777
PROP NUT KIT**
Replaces: 57630-94300
For: DT40/55/65
— CONTAINS —
Part # O.E. # Description
18-3726 09141-18005 Prop Nut
18-3735 09204-03003, 09204-03004 Cotter Pin
— 09160-18028 Washer



**18-3778
PROP NUT KIT**
Replaces: 57630-96300
For: DT20/25C/30C
— CONTAINS —
Part # O.E. # Description
18-3735 09204-03003, 09204-03004 Cotter Pin
— 09160-14028 Washer
18-3710 09141-14008 Prop Nut
18-3799 57633-96300 Spacer



③ **18-6032
ANODE**
Replaces: 55320-95310
55-140 H.P.



③ **18-6033
ANODE**
Replaces: 55125-87D00
150-200 H.P.



③ **18-6098
ANODE**
Replaces: 55125-96310
DF25, DF30, DT20, DT25, DT25C,
DT30, DT30C, DT35



**18-8380
LOWER UNIT SEAL KIT**
Replaces: 25700-93J00
For: All DF150/DF175/DF200/DF225/DF250



**18-8381
LOWER UNIT SEAL KIT**
Replaces: 25700-99E00
For: DF 60(2001 & Up), DF70(2001 & Up)

① Priced per Package ② This product is priced per piece. To order priced per package, please add -9 to the part number ③ Zinc

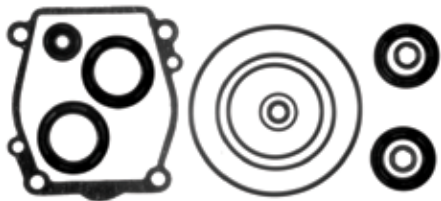

18-8335
LOWER UNIT SEAL KIT
 Replaces: 25700-87D00

— CONTAINS —

Part #	Description	O.E. #	Qty.
18-7118	O-Ring	09280-08008	1
18-7183	O-Ring	09280-69001	2
18-8331	Drain Plug Gasket	09168-10022	2



18-8337
LOWER UNIT SEAL KIT
 Replaces: 25700-94400

— CONTAINS —

Part #	Description	O.E. #	Qty.
18-0461	Water Pump Gasket	17472-96301	1
18-7151	O-Ring	09280-75001	1
18-7413	O-Ring	09280-08005	2
18-8331	Drain Plug Gasket	09168-10022	3
18-8334	Shift Shaft Seal	25223-94400	1
18-8345	Seal	09289-22007	2

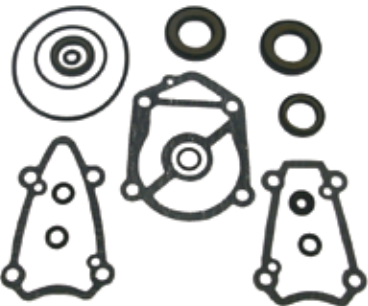

18-8338
LOWER UNIT SEAL KIT
 Replaces: 25700-94500

— CONTAINS —

Part #	Description	O.E. #	Qty.
18-0458	Water Pump Gasket	17472-94510	1
18-7118	O-Ring	09280-08008	1
18-7191	O-Ring	09280-15003	1
18-8321	Seal	09282-24003	2
18-8331	Drain Plug Gasket	09168-10022	3



18-8339
LOWER UNIT SEAL KIT
 Replaces: 25700-94700

— CONTAINS —

Part #	Description	O.E. #	Qty.
18-0460	Water Pump Gasket	17472-95310	1
18-7151	O-Ring	09280-76006	1
18-7413	O-Ring	09280-08005	1
18-8329	Seal	09289-17005	1
18-8331	Drain Plug Gasket	09168-10022	3
18-8334	Shift Shaft Seal	25223-94400	1
18-8345	Seal	09289-22007	2

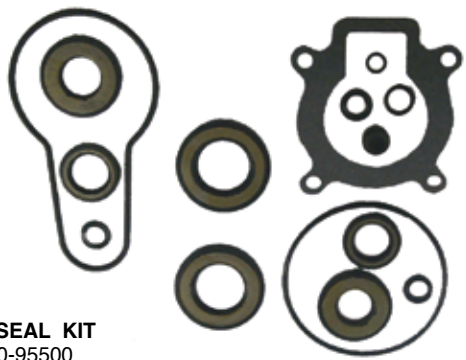

18-8340
LOWER UNIT SEAL KIT
 Replaces: 25700-95500

— CONTAINS —

Part #	Description	O.E. #	Qty.
18-0459	Water Pump Gasket	17472-95200	1
18-8331	Drain Plug Gasket	09168-10022	3
18-8334	Shift Shaft Seal	25223-94400	1

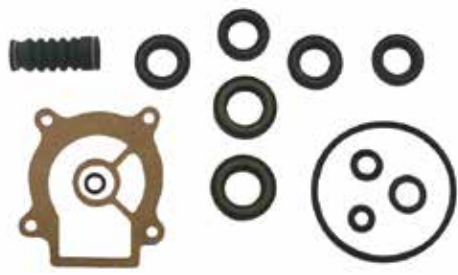

18-8341
LOWER UNIT SEAL KIT
 Replaces: 25700-95D00

— CONTAINS —

Part #	Description	O.E. #	Qty.
18-0461	Water Pump Gasket	17472-96301	1
18-7118	O-Ring	09280-50005	1
18-7413	O-Ring	09280-08005	1
18-7140	O-Ring	09282-17006	1
18-8331	Drain Plug Gasket	09168-10022	3



18-8373
LOWER UNIT SEAL KIT
 Replaces: 25700-90J01
 Fits: DF 90/115 (All Years)



18-8374
LOWER UNIT SEAL KIT
 Replaces: 25700-92J00
 Fits: DF140 (All Years)



18-8385
SEAL KIT
 Replaces: 25700-95J00
 Fits: DF25 V-Twin (2006-07)

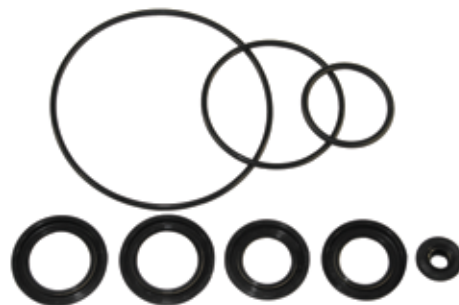

18-8386
SEAL KIT
 Replaces: 25700-98J00
 Fits: DF300 (2007)

SEAL KIT APPLICATION

HP/MODEL	YEAR	PART #	HP/MODEL	YEAR	PART #
DT25C	All	18-8341	DT115	All	18-8338
DF25	All	18-8341	DF115	All	18-8373
DF25 V-Twin	2006-07	18-8385	DT140	All	18-8338
DT30C	All	18-8341	DF140	All	18-8374
DF30	All	18-8341	DT150	All	18-8335
DT40C	All	18-8337	DF150	All	18-8380
DF40	All	18-8337	DT175	All	18-8335
DF50	All	18-8337	DF175	All	18-8380
DT55	All	18-8339	DT200	All	18-8335
DF60	2001-07	18-8381	DF200	All	18-8380
DT65	All	18-8339	DT225	All	18-8335
DF70	2001-07	18-8381	DF225	All	18-8380
DT75	All	18-8340	DF250	All	18-8380
DT85	All	18-8340	DF300	All	18-8386
DF90	All	18-8373			

PKG. OF 2



OIL SEALS

Part #	O.E. #	I.D.	Dimensions O.D. (mm)	Width
18-0544	09282-24004	23.2	40.3	7
18-0545	09289-10002	9	22.2	8
18-0546	09282-30007	29.5	50.25	6
18-0551	09283-10011	9	22.2	8
18-0569	09284-08003			
18-8345	09289-22007	22.2	35	5
18-8375		29	45	6
18-8377		7	22	7
18-8378		8	22	7

PKG. OF 5



O-RINGS

Part No.	O.E. No.	I. D.	Dimensions Width (mm)
18-7118 ①	09280-08008	69.40	3.10
18-7140 ①	09280-75002	69.00	3.50

① This product is priced per piece. To order priced per package, please add -9 to the part number

Model Description	Horsepower	Trim & Tilt/Starting Method	Shaft Length	Control Method	Model Year	Special Model Variation Code (Used on 25HP engines)
B = Inshore series C = C series model CV = C series D = Twin rotating propellers DX = Twin rotating propellers OX66 EFI E = Enduro series model F = Four stroke engine model LF = Left hand four stroke L = Left hand engine model LX = Left hand OX66 EFI LZ = Left hand HPDI P = Pro series model PX = Pro series OX66 EFI S = Saltwater series model SX = Saltwater series OX66 EFI T = Four stroke engine with high thrust V = V max series model VX = V max OX66 EFI VZ = V max HPDI Z = HPDI series	Example: 6 9.9 200 250	T = Power tilt or trim/tilt (1984-1990) P = Power tilt with electric start E = Electric start (1984-1990) M = Manual tilt with manual start	S = 15" L = 20" X = 25" U = 30"	R = Remote control H = Tiller handle J = Jet drive unit	N = 1984 K = 1985 J = 1986 H = 1987 G = 1988 F = 1989 D = 1990 P = 1991 Q = 1992 R = 1993 S = 1994 T = 1995 U = 1996 V = 1997 W = 1998 X = 1999 Y = 2000 Z = 2001 A = 2002 B = 2003 C = 2004 D = 2005	2 = 3 Cyl. 1997 3 = 3 Cyl.

Starting in April 2005 (2006 Model Year and newer) Yamaha no longer designated model years at the end of the model number identification. Beginning at this time any subsequent "new model" will have a letter designation between the Horsepower and the Control / Tilt Method.
 Example:
 VZ300TLRD = 2005 VZ300TLR = New model after April 2005. VZ300BTLR = Newest Model and direct replacement for previous models.
EXAMPLE: SX150TLRY - Saltwater EFI, 150 HP, Trim & Tilt w/electric start, 20", Remote control, 2000 model



NEW

18-5130
CDI
 Replaces: 688-85540-16
 Fits: 90(1988-91), C75(1994-96), C85(1991-96), CV85(1989-90), E75(1995-96)



NEW

18-5131
CDI
 Replaces: 695-85540-11, 695-85540-12
 Fits: 9.9(1984-95), 15(1984-95), C25(1992-97), CV25(1990)



NEW

18-5132
CDI
 Replaces: 63V-85540-01
 Fits: 9.9(1999-09), 15(1999-09)



18-5110
IGNITION COIL
 Replaces: 6E5-85570-11-00
 For: 115 (4 cyl.) 1985-91



18-5111
IGNITION COIL
 Replaces: 697-85570-11-00
 For: 55 (2 cyl.) 1989-94



18-5112
IGNITION COIL
 Replaces: 6E7-85570-19-00, 680-85570-09-00
 For: 9.9/15 1988-93



18-5128
IGNITION COIL
 Replaces: 6R3-85570-01-00
 For: 115/130/150HP (1994-04) 175HP (1994-95, 1997-98, 2000) 200HP (1994-98) 225HP (1997) B115HP 1998-99) C115HP (1997-98) for late model V4 & V6



NEW

18-5183
COIL, CHARGE
 Replaces: 63V-85520-00, 63V-85520-01
 Fits: 9.9(1996-03), 15(1996-03)



NEW

18-5195
COIL, IGNITION
 Replaces: 689-81311-40
 Fits: 25(1984-87), 30(1984-86), C30(1991-92), C40(1994-97), CV30(1989-90), CV40(1990)



MP39160
MOMENTARY
PUSH SWITCH
 For outboard installations.



MP51020 – CLAMSHELL
MP51022 – BULK 100 PCS/CTN
IGNITION SWITCH
 Replaces: 703-82510-12-00
 Yamaha Control Box 2 & 4 stroke
 Colors on wires match factory color codes



MP51030 – CLAMSHELL
MP51032 – BULK 100 PCS/CTN
IGNITION SWITCH
 Replaces: 61B-82510-01-00
 Yamaha Dash Mount 2 Stroke
 Dual Engine Application
 Colors on wires match factory color codes



MP51040 – CLAMSHELL
MP51042 – BULK 100 PCS/CTN
IGNITION SWITCH
 Replaces: 703-82510-43-00
 Yamaha Control Box 2 & 4 stroke
 Push to Choke
 Colors on wires match factory color codes



MP51050 – CLAMSHELL
MP51052 – BULK 100 PCS/CTN
IGNITION SWITCH
 Replaces: 6K1-82510-06-00
 Yamaha Dash Mount 2 & 4 Stroke
 Dual Engine Application, Push to Choke
 Colors on wires match factory color codes



MP28860
IGNITION LANAYARD
 Replaces: 682-82556-00-00



18-5225
SPARK PLUG WIRE KIT
 Kit includes 25 ft. Roll of 7 MM Hypalon Ignition Wire With a Metallic Core and a Large Assortment of Three Different End Fittings to Fit Outboard Motors.



18-5226
IGNITION WIRE
Metallic Core
 100' Spool
 7mm Hypalon



PKG. OF 10
18-5750
18-5750-9①
UNIVERSAL SPARK
PLUG BOOTS
 Supplied complete w/Terminal Connector
 Replaces: OMC 581027, 580339



18-5752
UNIVERSAL
SPARK PLUG BOOTS
 8mm

PKG. OF 10



18-5224
18-5224-9①
SPARK PLUG WIRE TERMINAL
 Replaces: Mercury 20121
 OMC 510364



18-5819
SOLENOID
 Replaces: 65W-81941-00-00
 For: F25 (1998-04), F30 (2001-04), F40 (2000-04)



18-5853
SOLENOID
 Replaces:
 61A-81941-00-00, 6E5-81941-11-00,
 6E5-81941-10-00, 6E5-81941-00-00
 For: 2-Stroke: 115hp - 150hp. (1994-Current); 175hp
 (1994-2000); 200hp (1994-2005); 225hp. (1995-2004);
 250hp (1990-2004)



18-5879
SOLENOID
 Replaces:
 688-81950-10-00, 688-81941-00-00
 For: 2-Stroke: 40hp (1984-88); 50hp (1984-88); 60hp.
 (2001-06); 70hp. (1991-Current); 90hp. (1984-91)



18-5821
STARTER
SOLENOID
 Replaces: 6G1-81941-10-00
 Fits: 9.9/15(1988-97), 20(1996-97), 25(1985, 1988-99),
 30(1985-87, 1989-93, 1996-99, 2001), 40(1989-90,
 1992-01), 50(1989-97, 1999-02), 1990(1992-02),
 F15(1998-03), F40(1999), F50(1996-02), F60(2002-03),
 F75(2003-04), F80(1999-03), F90(2003-04), F100(1999-02)



18-5746
STATOR ASSY
 Replaces: 6H3-85510-A0, 6H3-85510-A1
 Fits: E60(1995-99), P60(1991), 70(1984-91)



18-6410
OUTBOARD STARTER
 Replaces: Yamaha 689-81800-13-00,
 689-81800-11, 689-81800-12
 Fits: 25-40HP (11 tooth)



18-6411
OUTBOARD STARTER
 Replaces: 6H3-81800-11-00, 6H3-81800-10
 Fits: 60HP



18-6412
OUTBOARD STARTER
 Replaces: 697-81800-12, 99999-03249-00
 Fits: 55-60HP 2 cylinder (9 tooth)



18-6413
OUTBOARD STARTER
 Replaces: 6E5-81800-11-00,
 6E5-81800-12-00
 Fits: 55-60HP 2 cylinder (9 tooth)



18-6415
OUTBOARD STARTER
 Replaces: 6N7-81800-10-00
 Fits: 115-250HP (9 tooth)



18-6420
OUTBOARD STARTER
 Replaces: 6L2-81800-20-00
 Fits: 20HP MLHU & MSHU (1996),
 20HP MLHV & MSHV 1997-25 (1988-98)



18-6421
OUTBOARD STARTER
 Replaces: 6F5-81800-11, 6J4-81800-01-00
 Fits: 25HP (1999&2001), 30HP (1996-99 & 2001),
 40HP (1992-03) C40 1997-02, P40 (1998),
 50 (1992-97 & 2000 & 2002-03) C50 (1998-01), P50 (1993-96)



18-6422
OUTBOARD STARTER
 Replaces: 6H4-81800-12-00
 Fits: 40HP (1984-86), 50HP (1986-88), Pro 50 (1987-88)



18-6423
OUTBOARD STARTER
 Replaces: 688-81800-12-00
 Fits: C75 (1994-96), (1998-99), P75 (1996-99),
 C80 TLRV (1997), C85 (1991-96),
 CV85 (1990), 90 (1984-03), B90 (1998-99) C90 (1997-01)



18-6425
OUTBOARD STARTER
 Replaces: 67F-81800-02-00
 Fits: F75 (2003), F80 (2001-02), F90 (2003), F100 (2001-02)



18-6426
OUTBOARD STARTER
 Replaces: 68F-81800-01-00
 Fits: LZ150(00-05), LZ200(00-11), VZ150(00-11),
 VZ175(01-11), VZ200(01-04), Z150(00-05), Z175(01-05),
 Z200(00-11)



18-6427
OUTBOARD STARTER
 Replaces: 68V-81800-01-00
 Fits: F115 2001-03



18-6832
STARTER
 Replaces: 60V-81800-00-00,
 60X-81800-00-00
 Fits: 250HP engines 2003-04



18-6833
STARTER
 Replaces: 69J-81800-00-00
 Fits: 2002-2004 200-225HP

**18-6861
STARTER**

Replaces: Yamaha 61A-81800-01-00, 61H-81800-01-00, 69L-81800-00-00, Hitachi S114-559B
Fits: Yamaha 200-250HP Engines



**18-6942
STARTER**

Replaces: Yamaha 69W-81800-00-00, Hitachi S114-682
Fits: 2002-04 60HP, 2003-04 50HP



**18-6943
STARTER**

Replaces: Yamaha 66M-81800-01-00, 02-00
Fits: 9.9-15HP Engines



**18-6811
TRIM MOTOR**

Replaces: 62X-43880-00-00, -01-00, -09-00
Fits: 1995-99 40-50HP 4-Stroke



**18-6812
TRIM MOTOR**

Replaces: 62X-43880-00-00, 62X-43880-01-00, 62X-43880-09-00
Fits: 1995-03 Yamaha 40-100HP



**18-6821
TRIM MOTOR**

Replaces: 688-43880-11-00, 6E5-43880-01-00, -02-00
Fits: Yamaha 50-200HP 1985-86



**18-6836
TRIM MOTOR**

Replaces: 6C5-43880-00-00
Fits: 2005-06 F50 and F60



**18-6865
COMPLETE TRIM ASSEMBLY**

Replaces: Yamaha
Fits: Engines with 3-Ram Trim Assembly, 115-225HP Johnson/Evinrude Engines



**18-6823
WIRING HARNESS**

Replaces: Universal
Converts 3-wire Tilt and Trim motors to 2-Wire design



**18-56002
BRUSH HOLDER ASSY**

Replaces: 689-81840-11-00
Fits: F6/F8/T8 (2001-05), F9.9 (1985-90, 1999-05), T9.9 (1991-97, 1999, 2001-05), 25 (1984-87) (1999-00), C25 (1991, 1993-97), CV25 (1990), 30 (1984-01), C30 (1991-97), CV30 (1990), 40 (1984-05), P40 (1998), C40 (1991-01), CV40 (1990), 50 (1986-05), C50 (1998-01), P50 (1991-96), PRO50 (1987-90), 60 (2001-05), C60 (1996-01), P60 (1991-99), 70 (1984-05), C70 (2000-01)
Use with 18-6410 Starter



**18-56004
BRUSH HOLDER ASSY**

Replaces: 663-81840-11-00
Fits starters: 689-81800-13-00(18-6410), 6H3-81800-11-00(18-6410), 6F5-81800-11-00, 6J4-81800-01-00 (18-6421) 6H4-81800-12-00(18-6422), 697-81800-12, 99999-03249-00-00 (18-6412)



**18-56005
BRUSH HOLDER ASSY**

Replaces: 6E5-81840-10-00
Fits starters: 689-81800-13-00(18-6410), 6H3-81800-11-00(18-6410), 6F5-81800-11-00, 6J481800-01-00(18-6421) 6H4-81800-12-00(18-6422), 6E5-81800-11-00, 6E5-81800-12-00 (18-6413)



**18-56006
BRUSH HOLDER ASSY**

Replaces: 6N7-81840-00-00
Fits: 115, 130, 150 HP (1997-04), 175, 200 HP (1997-98), 225 HP (1997)
Use with 18-6415 Starter



**18-56007
BRUSH HOLDER ASSY**

Replaces: 61A-81840-00-00

Fits starters: 61A-81800-00-00, 61A-81800-01-00, 69L-81800-00-00 Fits:225 (1991-96), 250 (1990-95), L225 (1994-99), L250 (1990-99), LX225,LX250(2000-03), P150,P175 (1994-96, P200 1991-96, S225/S250 1996-99), SX225,SX250 (2000-03), V200/V225 (1998-99), VX200 (2000-05), VX225 (2000-04), VX250 (2002-04)



**18-6798
TRIM MOTOR**

Replaces: 69J-43880-00-00, 60V-43880-00-00

Fits: F200, F225 (2004-06), F250 (2005-06), LF200, LF225, LF250, LZ200, LZ225, LZ250 (2004-06)



HP/Model	Year	Starter	HP/Model	Year	Starter
9.9	1984-97	18-6420	130	1988-96	18-6413
15	1984-97	18-6420	130	2000-04	18-6415
25 (2 cyl)	1984-87	18-6410	L130	1989-96	18-6413
25 (2 cyl)	1988-09	18-6420	L130	2000-01	18-6415
C25	1991-97	18-6410	S130	1996	18-6413
CV25	1990	18-6410	150	1984-96	18-6413
30	1984-86	18-6410	150	2000-09	18-6415
30	1987-01	18-6421	C150	1996	18-6413
C30	1991-97	18-6410	DX150	1999-05	18-6415
CV30	1989-90	18-6410	L150	1986-96	18-6413
40	1984-88	18-6422	LX150	1999-01	18-6415
40	1989-05	18-6421	LZ150	2000-05	18-6426
C40	1991-97	18-6410	Z150	2000-05	18-6415
P40	1998	18-6421	P150	1991-96	18-6413
50	1984-88	18-6422	PX150	1999	18-6415
50	1989-09	18-6421	PRO V150	1986-90	18-6413
C50	1998-01	18-6421	S150	1996	18-6413
F50	1995-02	18-6413	SX150	2000-01	18-6415
P50	1991-96	18-6421	V150	2000-08	18-6415
T50	1996-02	18-6413	VX150	2000-04	18-6415
C55	1991-95	18-6412	VZ150	2000-11	18-6426
CV55	1989-90	18-6412	175	1984-95	18-6413
60	2001-05	18-6411	175	2000	18-6415
C60	1996-01	18-6411	P175	1994-96	18-6413
P60	1991-99	18-6411	S175	1996-	18-6413
70	1984-09	18-6411	V175	2000	18-6415
C70	2000-01	18-6411	VZ175	2001-11	18-6426
C75	1994-99	18-6423	Z175	2001-05	18-6426
F75	2003-04	18-6425	200	1984-96	18-6413
F75	2005-11	18-6427	L200	1986-96	18-6413
P75	1996-99	18-6423	LX200	1999-01	18-6415
C80	1997	18-6423	LZ200	2002-11	18-6426
F80	1999-03	18-6425	S200	1996	18-6413
C85	1991-96	18-6423	SX200	1999-05	18-6415
CV85	1989-90	18-6423	V200	1998-99	18-6424
90	1984-09	18-6423	VX200	2000-03	18-6424
B90	1997-99	18-6423	VZ200	2001-04	18-6426
C90	1997-01	18-6423	Z200	2000-11	18-6426
F90	2003-04	18-6425	V6 Special	1984-86	18-6413
F90	2006-11	18-6427	L225	1994-99	18-6424
F100	1999-03	18-6425	LX225	2000-03	18-6424
115	1984-96	18-6413	S225	1996-99	18-6424
115	2000-09	18-6415	SX225	2000-03	18-6424
C115	1991-96	18-6413	V225	1998-99	18-6424
C115	2000	18-6415	VX225	2000-03	18-6424
F115	2000-11	18-6427	250	1990-95	18-6424
LF115	2000-11	18-6427	L250	1990-99	18-6424
P115	1993-96	18-6413	LX250	2000-03	18-6424
S115	1996	18-6413	S250	1996-99	18-6424
			SX250	2000-03	18-6424



18-6259
TILT/TRIM MOTOR
 Replaces: 6H1-43880-00-00
 Fits: 70/90HP (1987-91), C85/P60HP (1991)



18-6787
TILT/TRIM MOTOR
 Replaces: 67F-43880-00-00
 Fits: Yamaha 4-Stroke F75 (2003-04), F80 (1999-03), F90 (2003-04), F100 (1999-02)



18-6788
TILT/TRIM MOTOR
 Replaces: 6H5-43880-02-00
 Fits: Yamaha 40-50hp (1985-92)



18-6789
TILT/TRIM MOTOR
 Replaces: 62X-43880-09-00
 Fits: Yamaha 40-100hp (1995-03)



18-6760
TRIM MOTOR
 Replaces: 6G5-43880-02-00
 For: 115-200HP (1987-96)



18-6781
TILT/TRIM MOTOR
 Replaces: 6HI-43880-02-00
 2-wire connection, 3 bolt mount
 For: 40HP (1994) 50HP (1992-95) 60HP (1997-up) 70HP (1996-up) 90HP (1992-up)



18-6782
TILT/TRIM MOTOR
 Replaces: 61A-43880-01-00, 61A-43880-02-00
 3-bolt mount, 4 wire connection
 For: 225-250HP



18-6783
TILT/TRIM MOTOR
 Replaces: 64E-43880-00-00, 64E-43880-01-00
 2-wire ring terminal connection 4-bolt mount
 For: 115-225HP (1997-2002)



18-7484
BACK-UP RING
 Replaces: 65W-43871-00-00
 For: F25-F40 1999-2008 w/Power Trim



18-9802
TIMING LIGHT
Self-powered accurate up to 10,000 RPM's



18-7058
CARBURETOR KIT
 Replaces: 61N-14392-00, 6L2-14392-00
 Fits: 9.9(1996-09), 15(1996-09)



18-7059
CARBURETOR KIT
 Replaces: 677-W0093-00, -04
 Fits: 9.9(1984-85), 15(1984-85)



18-7002
CARBURETOR KIT
 Replaces: 6E5-W0093-06-00
 Fits: 115 (1986-88, 1992-93, 1995), 130 (1988, 1992-93, 1995), 150, 175 (1986-87, 1992-95), 200 (1986-87, 1992-95), 225 (1992-93)



18-7290*
CARB KIT
 Replaces: 696-W0093-02-00
 *Kit contains enough components to rebuild 2 carburetors



18-7291
CARB KIT
Replaces: 6H1-W0093-01-00
(3) of 18-7291 = (1) of 6H1-W0093-01-00



18-7293
CARB KIT
Replaces: 6A1-W0093-01-00



18-7736
CARB KIT
Replaces: 67D-W0093-00-00
For: (1999-02) F4



18-7737
CARB KIT
Replaces: 61N-W0093-00-00
For: (1993-97) C30



18-7738
CARB KIT
Replaces: 66M-W0093-01-00
For: (1998-02) F15



18-7739
CARB KIT
Replaces: 6L2-W0093-00-00
For: (1996-97) 20 (1988-02) 25 3 cyl



18-7740
CARB KIT
Replaces: 6E9-W0093-02-00
For: (1990-94) C40 2 cyl



18-7741
CARB KIT
Replaces: 6E9-W0093-03-00
For: (1995-98) C40 2 cyl



18-7742
CARB KIT
Replaces: 6H0-W0093-00-00
For: (1997) C80



18-7743
CARB KIT
Replaces: 67F-W0093-00-00
For: (1999-02) F80/F100



18-7744
CARB KIT
Replaces: 6N6-W0093-02-00
For: (1990-91) 115, 130, L130



18-7747
CARB KIT
Replaces: 6G5-W0093-08-00
For: (1985-86) 150/175/200, V6 Special



18-7756
CARB KIT
Replaces: 64D-W0093-00-00
For: (1996-01) 150/150L/175 (1996-99) 200/L200 (2000-01) 150/175 (1997-98) D150

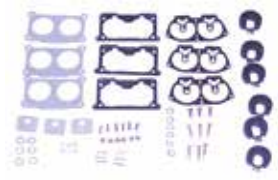

18-7759
CARB KIT
Replaces: 6K7-W0093-09-00
For: (1990-91) 150/175/200 (1991-92) P200



18-7765
CARB KIT
Replaces: 6G1-W0093-00-00



18-7766
CARB KIT
Replaces: 6H3-W0093-02-00
(3) of 18-7766 = (1) of 6H3-W0093-02-00



18-7767
CARB KIT
Replaces: 6H4-W0093-01-00
(3) of 18-7767 = (1) of 6H4-W0093-01-00



**18-7768
CARB KIT**
Replaces: 6H4-W0093-03-00
(3) 18-7768 = (1) 6H4-W0093-03-00



**18-7769
CARB KIT**
Replaces: 6E7-W0093-04-00



**18-7770
CARB KIT**
Replaces: 689-W0093-02-00



**18-7772
CARB KIT**
Replaces: 61A-W0093-01-00
For: (1991-96) 225/250 3.1 liter, L225, L250



**18-7049
NEEDLE VALVE**
Replaces: Yamaha
61N-14392-00, 6L2-14392-00
Fits: C30(1993-97)



**18-7054
NEEDLE VALVE**
Replaces: Yamaha
6G1-14546-00, -01
Fits: 3(1988-02), 6(1986-00), 8(1984-03), 9.9(1996-03), 15(1996-03), F25(1998-03), F30(2000-02), F40(2000-02), T25(2001-03)



**18-7055
NEEDLE VALVE**
Replaces: 6E5-14546-00
Fits: 25 MLHV3(1997), 25MLHW3(1998), 25 MSHV3(1997), 25 MSHW3(1998), 30(1987-98), 115(1986-09), 130(1988-04), 150(1986-09), 175(1986-95, 2000), 200(1986-98), 225(1990-97), B115(1998-99), 250(1991-95), C115(1991-00), C150(1996-99), D150(1997-99), L130(1989-01), L150(1986-99), L200(1986-99), L225(1994-96), L250(1990-96), P115(1993-96), P150(1991-99), P175(1994-99), P200(1991-99), S115(1996-99), S130(1996-99), S150(1996-99), S175(1996-99), S200(1996-99), S225(1996), S250(1996), V150(2000-08), V175(2000)



**18-7056
NEEDLE VALVE**
Replaces: 6H3-14590-00, -01
Fits: 40(1984-92), 50(1984-92), 70(1984-01), C40(1991-94), C60(1996-01), C70(2000-01), CV40(1990), E60(1995-00), F80(2000-02), F100(2000-02), P50(1991-92), P60(1991-99)



**18-7060
NEEDLE VALVE**
Replaces: 692-14590-00, -01
Fits: 90(1984-02), B90(1997-99), C75(1994-99), C80(1997), C85(1991-96), C90(1997-01), CV85(1989-90), E75(1995-00), P75(1996-99)



**18-7073
NEEDLE VALVE**
Replaces: 6E8-14390-12
Fits: 9.9(1986-95), 15(1986-95)



**18-7079
NEEDLE VALVE**
Replaces: 626-14390-90
Fits: 9.9(1984-85), 15(1984-85)



**18-7063
FLOAT**
Replaces: 6L2-14385-00
Fits: 20(1996-97), 25(1988-09), C30(1993-97), F15(1989-06), F40(1999), F50(1995-03), F60(2002-04), F9.9(2005-06), T50(1996-04), T60(2003-04), T9.9(2005-06)



**18-7064
FLOAT**
Replaces: 63V-14985-00
Fits: 9.9(1996-09), 15(1996-09), F25(1998-13), F30(2001-05), F40(2000-08), T25(2001-13)



**18-7065
FLOAT**
Replaces: 647-14385-00
Fits: 4(1984-85), 5(1984-85), 9.9(1984-85), 15(1984-85)



**18-7066
FLOAT**
Replaces: 648-14385-00
Fits: 25(1984-87), 30(1984-86), C25(1991-97), C30(1991-92), Cv25(1990), CV30(1989-90)



**18-7067
FLOAT**
Replaces: 6G1-14985-00
Fits: 3(1988-02), 6(1986-00), 8(1984-00), 40(1984-88), 50(1984-88), 70(1984-91), C60(1996-01), E60(1995-00), PRO 50(1987-88), P60(1991)



**18-7068
FLOAT**
Replaces: 6E5-14385-01
Fits: 115(1984), 150(1984), 175(1984), 200(1984)



**18-7069
FLOAT**
Replaces: 6E5-14385-02
Fits: 115(1986-09), 130(1988-04), 150(1986-09), 175(1986-00), 200(1986-98), 200(1990-97), B115(1998-99), C115(1991-00), C150(1996-99), D150(1997-99), L130(1989-01), L150(1986-99), L200(1986-99), P115(1993-96), P150(1991-99), P175(1994-99), P200(1991-99), PRO150(1986-90), S115(1996-99), S130(1996-99), S150(1996-99), S175(1996-99), S200(1996-99), V150(2000-08), V6 Excell(1987-89), V6 Special(1986)



**18-7392
FLOAT**

Replaces: 676-14985-01
Fits: 90(1984-90), C40(1991-97), C75(1994-99), C80(1997), C85(1991-96), CV40(1990), CV85(1989-90), E75(1995-00)



**18-7393
FLOAT**

Replaces: 6E7-14385-00
Fits: 4(1986-94), 5(1994), 9.9(1986-95), 15(1986-95)



**18-0710
FLOAT CHAMBER GASKET**

Replaces: 68V-14984-00
Fits: F115 (2000-10), LF115 (2000-10), F200 (2002-10), LF200(2002-10), F225(2002-05), LF225(2002-05), F225TXR models(2007-10), LF225TXR models(2007-10)



**18-0711
FLOAT CHAMBER GASKET**

Replaces: 66K-14984-00
Fits: DX 150(1999-05), LX 150(1999-01), LZ 150(2000-05), PX 150(1999), VX 150(2000-04), VZ 150(2000-10), Z 150(2000-05), VZ 175(2001-10), Z175(2001-05), LX200(1999-01), LZ200(2000-10), SX200(1999-05), V200(1999), VX200(2000-05), VZ200(2001-09), Z200(2000-10), L225(1999), LX225(2000-03), S225(1999), SX225(2000-03), V225(1999), VX225(2000-04), VZ225(2003-09), L250(1999), LX250(2000-03), LZ250(2003-05), S250(1999), SX250(2000-03), VX250(2002-04), VZ250(2003-09), Z250(2003-05), LZ300(2004-06), VZ300(2004-09), Z300(2004-06)



**18-0712
FLOAT CHAMBER GASKET**

Replaces: 63P-14984-00
Fits: F150 TLR (2004-10), F150 TXR (2004-10), LF150 TXR (2004-10)



**18-0713
FLOAT CHAMBER GASKET**

Replaces: 6P2-14984-00
Fits: F225TLR(2007-09), F250(2005-10), LF250(2005-10)



**18-0714
FLOAT CHAMBER GASKET**

Replaces: 6AW-14984-00
Fits: F300(2007-09), LF300(2007-09), F350(2007-10), LF350(2007-10)



**18-0715
FLOAT CHAMBER GASKET**

Replaces: 65L-14984-00
Fits: V200(1998), L225(1997-98), S225(1997-98), V225(1998), L250(1997-98), S250(1997-98),



**18-99146
Float Chamber Gasket**













Replaces: 677-14384-01
Fits: 9.9(1984-95), 15(1984-95)

H.P.	Year	Carb Kit	Per Engine	Needle Valve Assy	Per Engine	H.P.	Year	Carb Kit	Per Engine	Needle Valve Assy	Per Engine
2	1984-88	18-7293	1			40	1984-88	18-7767	3	18-7056	3
3	1988-02	18-7765	1	18-7054	1	40	1989-92	18-7768	3	18-7056	3
F4	1999-02	18-7736	1			40	1993-05	18-7768	3		
6	1986-96	18-7765	1	18-7054	1	F40	2000-02			18-7054	3
6	1997-00		1	18-7054	1	C40	1991-93	18-7740	1	18-7056	2
8	1984-96	18-7765	1	18-7054	1	C40	1994-97	18-7741	1		
8	1997-00		1	18-7054	1	C40	2002-03	18-7768	3		
9.9	1984-85	18-7059	1	18-7079	1	P40	1998	18-7768	1		
9.9	1986-95	18-7769	1	18-7073	1	E48	1995-00	18-7290	2		*
9.9	1996-03	18-7058	1	18-7054	1	50	1984-88	18-7767	3	18-7056	3
9.9	2004-09	18-7058	1			50	1989-92	18-7768	3	18-7056	3
F9.9	2006	18-7738	1			50	1993 & Up	18-7768	3		
T9.9	2005-06	18-7738	1			C50	1998-01	18-7768	3		
15	1984-85	18-7059	1	18-7079	1	PRO 50	1987-88	18-7767	3		
15	1986-92	18-7769	1	18-7073	1	PRO 50	1989-90	18-7768	3		
15	1993-95			18-7073	1	P50	1991-92	18-7768	3	18-7056	3
15	1996-03	18-7058	1	18-7054	1	P50	1993-96	18-7768	3		
15	2004-09	18-7058	1			C55	1991-95	18-7290	2		*
F15	1998-05	18-7738	1			CV55	1989-90	18-7290	2		*
20	1996-97	18-7739	1			60	2001-02			18-7056	3
25 (2 cyl)	1984-87	18-7770	1			C60	1996-01	18-7766	3	18-7056	3
25 (2 cyl)	1988-09	18-7739	1			E60	1995-00	18-7766	3	18-7056	3
F25	1998-03		1	18-7054	1	P60	1991	18-7766	3	18-7056	3
C25	1991-1997	18-7770	1			P60	1992-99			18-7056	3
CV25	1990	18-7770	1			70	1984-91	18-7766	3	18-7056	3
T25	2001-03		1	18-7054	1	70	1992-01			18-7056	3
30	1984-86	18-7770	1			C70	2000-01			18-7056	3
30	1987-98		1	18-7055	1	C75	1994-97	18-7291	3	18-7060	3
F30	2000-02		1	18-7054	1	C75	1998-99	18-7742	3	18-7060	3
C30	1991-92	18-7770	1			E75	1995-00	18-7291	3	18-7060	3
C30	1993-97	18-7737	1	18-7049	1	P75	1996-99			18-7060	3
CV30	1989-90	18-7770	1			C80	1997	18-7742	3	18-7060	3

① Kit contains enough components to rebuild 2 carburetors

H.P.	Year	Carb Kit	Per Engine	Needle Valve Assy	Per Engine	H.P.	Year	Carb Kit	Per Engine	Needle Valve Assy	Per Engine
F80	1999-02	18-7743	3	18-7056	3	P150	1992-95	18-7002	3	18-7055	6
C85	1991-96	18-7291	3	18-7060	3	P150	1996-99	18-7756	3	18-7055	6
CV85	1989-90	18-7291	3	18-7060	3	PRO V150	1987	18-7002	3		
90	1984-91	18-7291	3	18-7060	3	PRO V150	1990	18-7759	1		
90	1992-02			18-7060	3	S150	1996-99	18-7756	3	18-7055	6
B90	1997-99			18-7060	3	V150	2000-01	18-7756	3		
C90	1997-01			18-7060	3	V150	2002-08			18-7055	6
F100	1999-02	18-7743	3	18-7056	3	175	1985-86	18-7747	2		
115	1986-88, 1992-95	18-7002	2	18-7055	4	175	1987, 1992-95	18-7002	3	18-7055	6
115	1990-91	18-7744	2	18-7055	4	175	1990-91	18-7759	1	18-7055	6
115	1992-09		2	18-7055	4	175	1992-95			18-7055	6
B115	1998-99			18-7055	4	175	2000	18-7756	3	18-7055	6
C115	1991			18-7055	4	P175	1994-95	18-7002	3	18-7055	6
C115	1992-95	18-7002	2	18-7055	4	P175	1996-99	18-7756	3	18-7055	6
C115	1996-00			18-7055	4	S175	1996-99	18-7756	3	18-7055	6
P115	1993-96	18-7002	2	18-7055	4	V175	2000	18-7756	3		
S115	1996-99			18-7055	4	200	1985	18-7747	2		
130	1988, 1992-95	18-7002	2	18-7055	4	200	1986-87, 1992-95	18-7002	3	18-7055	6
130	1990-91	18-7744	1	18-7055	4	200	1990-91	18-7759	1	18-7055	6
130	1992-04			18-7055	4	200	1996-98	18-7756	3	18-7055	6
L130	1989			18-7055	4	L200	1988, 1992-95	18-7002	3	18-7055	6
L130	1990-91	18-7744	1	18-7055	4	L200	1990-91	18-7759	1	18-7055	6
L130	1992-95	18-7002	2	18-7055	4	L200	1996-99	18-7756	3	18-7055	6
L130	1996-01			18-7055	4	P200	1991	18-7759	1	18-7055	6
S130	1996-99			18-7055	4	P200	1993-95	18-7002	3	18-7055	6
150	1985-86	18-7747	1	18-7055	6	P200	1996-99	18-7756	3	18-7055	6
150	1987, 1992-95	18-7002	3	18-7055	6	S200	1996-99	18-7756	3	18-7055	6
150	1990-91	18-7759	1	18-7055	6	V6 Special	1984-86	18-7747	2		
150	1996-01	18-7756	3	18-7055	6	V6 Excel	1987-89	18-7759	1		
150	2002-09			18-7055	6	225	1990-91	18-7759	1	18-7055	6
C150	1996-99	18-7756	3	18-7055	6	225	1992-95	18-7002	3	18-7055	6
D150	1997-99	18-7756	3	18-7055	6	225	1996-97	18-7756	3	18-7055	6
L150	1988, 1992-95	18-7002	3	18-7055	6	L225	1994-96	18-7772	6	18-7055	6
L150	1990-91	18-7759	1	18-7055	6	S225	1996	18-7772	6	18-7055	6
L150	1996-99	18-7756	3	18-7055	6	250	1990-95	18-7772	6	18-7055	6
Z150						L250	1991-96	18-7772	6	18-7055	6
P150	1991	18-7759	1	18-7055	6	S250	1996	18-7772	6	18-7055	6

* Carb Kit contains enough componenets to rebuild 2 carburetors

 <p>18-7334 FUEL PUMP Replaces: 692-24410-00-00, 663-24410-00-00, 6A0-24410-00-00, 6A0-24410-05-00, 6A0-24410-04-00, 6A0-24410-03-00, 6A0-24410-02-00, 6A0-24410-01-00 For: 2-Stroke 40 HP - 90 HP (1984-2009)</p>	 <p>18-7340 FUEL PUMP Replaces: 68V-13907-00, 68V-13907-03 Fits: F115(2000-04, 2006-11), LF115(2000-11)</p>	 <p>18-7341 FUEL PUMP Replaces: 66K-13907-00 Fits: DX150(1999-01), LX150(1999-01), LX200(1999-01), LX225(2000-01), LX250(2000-01), PX150(1999), SX150(1999-01), SX200(1999-01), SX225(2000-01), SX250(2000-01), V200(1999), V225(1999), VX150(2000-01), VX200(2000-01), VX225(2000-01)</p>	 <p>18-7342 FUEL PUMP Replaces: 68F-13907-00, 68F-13907-01 Fits: LZ150(2000-05), LZ200(2000-12), VZ150(2000-12), VZ175(2001-12), VZ200(2001-04), Z150(2000-05), Z175(2001-05), Z200(2000-12)</p>															
 <p>18-7343 FUEL PUMP Replaces: 60V-13907-00 Fits: LZ250(2003-05), LZ300(2004-06), VZ200(2005-09), VZ225(2003-09), VZ250(2003-09), VZ300(2004-09), Z250(2003-05), Z300(2004-06)</p>	 <p>18-7349 FUEL PUMP Replaces: 6E5-24410-03-00, 6E5-24410-10-00, 6E5-24410-04-00, 6E5-24410-02-00, 6E5-24410-01-00, 6E5-24410-00-00 For: 2-Stroke 115 HP - 300 HP (1984-2004)</p>	 <p>18-7388 DIAPHRAGM Replaces: 6G1-24411-00 Fits: 3(1988-02), 6(1986-00), 8(1984-09), 9,9(1996-09), 15(1996-09)</p>	 <p>18-7389 DIAPHRAGM Replaces: 6E0-24411-00 Fits: 4(1984-99), 5(1984-85, 1994-02)</p>															
 <p>18-7390 DIAPHRAGM Replaces: 63V-24411-00 Fits: 9.9(1996-09), 15(1996-09)</p>	 <p>18-7391 DIAPHRAGM Replaces: 692-24411-00 Fits: 40(1995-05), 50(1995-09), 60(2001-05), 70(1995-09), 90(1995-09), B90(1997-99), C25(1996-97), C30(1996-97), C40(1995-03), C50(1998-01), C55(1995), C60(1996-01), C70(2000-01), C75(1995-99), C80(1997), C85(1995-96), C90(1997-01), E48(1995-00), E60(1995-00), E75(1995-00), P40(1998), P50(1995-96), P60(1995-99), P75(1996-99)</p>	 <p>18-7787 FUEL PUMP KIT For: 40-90 HP — CONTAINS — <table border="1"> <thead> <tr> <th>Part #</th> <th>Description</th> <th>O.E. #</th> </tr> </thead> <tbody> <tr> <td>18-7840</td> <td>Diaphragm (Front)</td> <td>663-24411-00-00</td> </tr> </tbody> </table></p>	Part #	Description	O.E. #	18-7840	Diaphragm (Front)	663-24411-00-00	 <p>18-7788 FUEL PUMP KIT For: V-4, V-6 — CONTAINS — <table border="1"> <thead> <tr> <th>Part #</th> <th>Description</th> <th>O.E. #</th> </tr> </thead> <tbody> <tr> <td>18-7843</td> <td>Gasket (Rear)</td> <td>6E5-24411-00-00</td> </tr> <tr> <td>18-7842</td> <td>Diaphragm (Top)</td> <td>6E5-24471-00-00</td> </tr> </tbody> </table></p>	Part #	Description	O.E. #	18-7843	Gasket (Rear)	6E5-24411-00-00	18-7842	Diaphragm (Top)	6E5-24471-00-00
Part #	Description	O.E. #																
18-7840	Diaphragm (Front)	663-24411-00-00																
Part #	Description	O.E. #																
18-7843	Gasket (Rear)	6E5-24411-00-00																
18-7842	Diaphragm (Top)	6E5-24471-00-00																



18-7797
FUEL PUMP KIT
Contains: 18-7839 & 18-7840



18-7798
FUEL PUMP KIT
Contains: 18-7838 & 18-7837



18-7799
FUEL PUMP KIT
Contains: 18-7842 & 18-7843



18-7833
FUEL PUMP DIAPHRAGM
Replaces: 6G1-24471-00-00
(6 & 8 HP)



18-7834
FUEL PUMP DIAPHRAGM
Replaces: 6E0-24471-00-00
(4 HP)



18-7837
FUEL PUMP DIAPHRAGM
Replaces: 677-24411-02-00
(9.9, 15 HP)



18-7838
FUEL PUMP DIAPHRAGM
Replaces: 677-24471-01-00
(9.9, 15 HP)



18-7839
FUEL PUMP DIAPHRAGM
Replaces: 648-24411-00-00
(25, 40, 50, 70, 90 HP)



18-7840
FUEL PUMP DIAPHRAGM
Replaces: 663-24411-00-00
(25, 40, 50, 70, 90 HP)



18-7841
FUEL PUMP DIAPHRAGM
Replaces: 6J8-24471-00-00
(30 HP)



18-7842
FUEL PUMP DIAPHRAGM
Replaces: 6E5-24471-00-00
(115, 150, 175, 200 HP)



18-7843
FUEL PUMP DIAPHRAGM
Replaces: 6E5-24411-00-00
(115, 150, 175, 200 HP)

Model	Year	Diaphragms	Kits	Model	Year	Diaphragms	Kits	Model	Year	Diaphragms	Kits
3	1988-02	18-7833 / 18-7388	18-7367	C75	1995-99	18-7840		VZ175	2002-04	18-7842 / 18-7843	18-7799
4	1984-99	18-7834 / 18-7389	18-7368	E75	1995-00	18-7840		Z175	2001-01	18-7842	
5	1984-85	18-7834 / 18-7389	18-7368	P75	1996-99	18-7840		Z175	2002-04	18-7842 / 18-7843	18-7799
5	1986-91	18-7834		C80	1997	18-7840		200	1984-98	18-7842 / 18-7843	18-7799
5	1994-02	18-7834 / 18-7389	18-7368	85	1990	18-7798		L200	1986-99	18-7842 / 18-7843	18-7799
6	1986-00	18-7833 / 18-7388	18-7367	C85	1991-94	18-7839 / 18-7840	18-7797	LX200	1999-01	18-7842	
8	1984-09	18-7833 / 18-7388	18-7367	C85	1995-96	18-7840		LZ200	2000-01	18-7842	
9.9	1984-95	18-7837 / 18-7388	18-7798	CV85	1989-90	18-7839 / 18-7840	18-7797	LZ200	2002-04	18-7842 / 18-7843	18-7799
9.9	1996-09	18-7388 / 18-7390	18-7369	90	1984-94	18-7839 / 18-7840	18-7797	P200	1991-99	18-7842 / 18-7843	18-7799
15	1984-95	18-7837 / 18-7388	18-7798	90	1995-09	18-7840		S200	1996-99	18-7842 / 18-7843	18-7799
15	1996-09	18-7388 / 18-7390	18-7369	B90	1997-99	18-7840		SX200	1999-01	18-7842	
20	1996-97	18-7837		C90	1997-01	18-7840		SX200	2002-04	18-7842 / 18-7843	18-7799
25	1984-87	18-7840		115	1984-04	18-7842 / 18-7843	18-7799	V200	1999	18-7842	
25	1984-87	18-7939		B115	1998-99	18-7842 / 18-7843	18-7799	V200	1998	18-7842 / 18-7843	18-7799
25	1988-09	18-7837		C115	1991-00	18-7842 / 18-7843	18-7799	VX200	2000-01	18-7842	
C25	1991-95	18-7939 / 18-7840	18-7797	P115	1993-96	18-7842 / 18-7843	18-7799	VX200	2002-04	18-7842 / 18-7843	18-7799
C25	1996-97	18-7840		S115	1996-99	18-7842 / 18-7843	18-7799	VZ200	2001	18-7842	
CV25	1990	18-7839 / 18-7840	18-7797	130	1988-04	18-7842 / 18-7843	18-7799	VZ200	2002-04	18-7842 / 18-7843	18-7799
25	1990	18-7837		C150	1996-99	18-7842 / 18-7843	18-7799	Z200	2000-01	18-7842	
30	1984-86	18-7839 / 18-7840	18-7797	L130	1989-99	18-7842 / 18-7843	18-7799	Z200	2002-04	18-7842 / 18-7843	18-7799
30	1987-90	18-7841		L130	2000-01	18-7842		225	1990-97	18-7842 / 18-7843	18-7799
30	1991-02	18-7841		S130	1996-99	18-7842 / 18-7843	18-7799	L225	1994-99	18-7842 / 18-7843	18-7799
C30	1991-95	18-7839 / 18-7840	18-7797	150	1984-04	18-7842 / 18-7843	18-7799	LX225	2000-01	18-7842	
C30	1996-97	18-7840		D150	1997-99	18-7842 / 18-7843	18-7799	LX225	2002-03	18-7842 / 18-7843	18-7799
CV30	1989-90	18-7839 / 18-7840	18-7797	L150	1986-99	18-7842 / 18-7843	18-7799	S225	1996-99	18-7842 / 18-7843	18-7799
40	1984-94	18-7839 / 18-7840	18-7797	LX150	1999-01	18-7842		SX225	2000-01	18-7842	
40	1995-01	18-7840		LZ150	2000-01	18-7842		SX225	2002-03	18-7842 / 18-7843	18-7799
C40	1991-94	18-7839 / 18-7840	18-7797	LZ150	2002-04	18-7842 / 18-7843	18-7799	V225	1999	18-7842	
C40	1995-02	18-7840		DX150	1999-01	18-7842		V225	1998	18-7842 / 18-7843	18-7799
CV40	1990	18-7839 / 18-7840	18-7797	DX150	2002-04	18-7842 / 18-7843	18-7799	VX225	2000-01	18-7842	
P40	1998	18-7840		P150	1991-99	18-7842 / 18-7843	18-7799	VX225	2002-04	18-7842 / 18-7843	18-7799
E48	1995-00	18-7840		S150	1996-99	18-7842 / 18-7843	18-7799	VZ225	2003-04	18-7842 / 18-7843	18-7799
50	1986-94	18-7839 / 18-7840	18-7797	SX150	1999-01	18-7842		250	1990-95	18-7842 / 18-7843	18-7799
50	1995-09	18-7840		SX150	2002-04	18-7842 / 18-7843	18-7799	L250	1990-99	18-7843	
C50	1998-01	18-7840		V150	2000-01	18-7842		LX250	2000-01	18-7842	
P50	1991-94	18-7839 / 18-7840	18-7797	V150	2002-04	18-7842 / 18-7843	18-7799	LX250	2002-03	18-7842 / 18-7843	18-7799
P50	18-1995-96	18-7840		VX150	2000-01	18-7842		LZ250	2003-04	18-7842 / 18-7843	18-7799
55	1990	18-7798		VX150	2002-01	18-7842 / 18-7843	18-7799	S250	1996-99	18-7842 / 18-7843	18-7799
C55	1991-94	18-7839 / 18-7840	18-7797	VZ150	2000-04	18-7842		SX250	2000-01	18-7842	
CV55	1989-90	18-7839 / 18-7840	18-7797	VZ150	2002-04	18-7842 / 18-7843	18-7799	SX250	2002-03	18-7842 / 18-7843	18-7799
60	2001-05	18-7840		Z150	2000-01	18-7842		VX250	2002-04	18-7842 / 18-7843	18-7799
C60	1996-01	18-7840		Z150	2002-04	18-7842 / 18-7843	18-7799	VZ250	2003-04	18-7842 / 18-7843	18-7799
E60	1995-00	18-7840		PRO 150H	1987	18-7798		Z250	2003-04	18-7842 / 18-7843	18-7799
P60	1991-94	18-7839		175	1984-95	18-7842 / 18-7843	18-7799	LZ300	2004	18-7842 / 18-7843	18-7799
70	1984-94	18-7839 / 18-7840	18-7797	175	1996-00	18-7842		VZ300	2004	18-7842 / 18-7843	18-7799
70	1995-09	18-7840		P175	1994-99	18-7842 / 18-7843	18-7799	Z300	2004	18-7842 / 18-7843	18-7799
C70	2000-01	18-7840		S175	1996-99	18-7842 / 18-7843	18-7799	V6			
C75	1994	18-7839 / 18-7840	18-7797	V175	2000	18-7842		Special	1984-86	18-7842 / 18-7843	18-7799
				VZ175	2001	18-7842		V6 Excel	1987-89	18-7842 / 18-7843	18-7799

- UNIVERSAL DESIGN -
FUEL WATER SEPARATOR BRACKETS



Bracket Type	Part #	Replaces	Bracket Type	Part #	Replaces
1/4" Stainless Steel	18-7777	MAR-FLTHD-SS-12	1/4" Aluminum	18-7853-1	MAR-FLTHD-AL-12
3/8" Stainless Steel	18-7776		3/8" Aluminum	18-7775	

FUEL WATER SEPARATOR KITS



21 Micron filter kits - for carbureted engines

Kit Type	Part #	Micron Rating	Contents	Replaces
1/4" Aluminum (Short Filter)	18-7848-1	21	1 - 18-7844 filter & 1 18-7853-1 bracket 2 - 18-4256 1/4" pipe plugs	
1/4" Aluminum Bonus Pack Contains spare filter	18-7848-2	21	2 - 18-7844 filter & 1 18-7853-1 bracket 2 - 18-4256 1/4" pipe plugs	
1/4" Aluminum (Tall Filter)	18-7852-1	21	1 - 18-7845 filter & 1 18-7853-1 bracket 2 - 18-4256 1/4" pipe plugs	MAR-SEPAR-AT-OR
1/4" Aluminum Bonus Pack Contains spare filter	18-7852-2	21	2 - 18-7845 filter & 1 18-7853-1 bracket 2 - 18-4256 1/4" pipe plugs	
3/8" Aluminum (Tall Filter)	18-7775-1	21	1 - 18-7845 filter & 1 18-7775 bracket 2 - 18-4264 3/8" pipe plugs	
1/4" Stainless Steel (Tall Filter)	18-7777-1	21	1 - 18-7845 filter & 1 18-7777 bracket 2 - 18-4256 1/4" pipe plugs	ABB-SPRTR-HD-SS
3/8" Stainless Steel (Tall Filter)	18-7776-1	21	1 - 18-7845 filter & 1 18-7776 bracket 2 - 18-4264 3/8" pipe plugs	



10 MICRON FILTER KITS FOR FUEL INJECTED ENGINES

Kit Type	Part #	Micron Rating	Contents	Replaces
1/4" Aluminum (Short Filter)	18-7983-1	10	1 - 18-7944 filter & 1 18-7853-1 bracket 2 - 18-4256 1/4" pipe plugs	
1/4" Aluminum Bonus Pack Contains spare filter	18-7983-2	10	2 - 18-7944 filter & 1 18-7853-1 bracket 2 - 18-4256 1/4" pipe plugs	
1/4" Aluminum (Tall Filter)	18-7982-1	10	1 - 18-7945 filter & 1 18-7853-1 bracket 2 - 18-4256 1/4" pipe plugs	
1/4" Aluminum Bonus Pack Contains spare filter	18-7982-2	10	2 - 18-7945 filter & 1 18-7853-1 bracket 2 - 18-4256 1/4" pipe plugs	
1/4" Aluminum (High Capacity Filter)	18-7966-1	10	1 - 18-7866 filter & 1 18-7853-1 bracket 2 - 18-4256 1/4" pipe plugs	MAR-SEPAR-AT-OR
3/8" Aluminum (Tall Filter)	18-7986-1	10	1 - 18-7945 filter & 1 18-7775 bracket 2 - 18-4264 3/8" pipe plugs	
1/4" Stainless Steel (Tall Filter)	18-7984-1	10	1 - 18-7945 filter & 1 18-7777 bracket 2 - 18-4256 1/4" pipe plugs	MAR-SPRTR-HD-SS
3/8" Stainless Steel (Tall Filter)	18-7985-1	10	1 - 18-7945 filter & 1 18-7776 bracket 2 - 18-4264 3/8" pipe plugs	



10 MICRON FILTER KITS WITH DRAIN BOWLS

Sierra AquaVue™ and metal bowl separator filters allow water to be drained from the filter to extend service life. Use the AquaVue™ bowl for outboard, above deck installations. USCG regulations require the use of the flame resistant metal bowl below deck.

Kit Type	Part #	Micron Rating	Contents
1/4" Aluminum w/ AquaVue™ bowl	18-7932	10	1 - 18-7919 filter & 1 18-7853-1 bracket 1 - 18-7922 AquaVue™ bowl 2 - 18-4256 1/4" pipe plugs
1/4" Aluminum w/ metal drain bowl	18-7951	10	1 - 18-7919 filter & 1 18-7853-1 bracket 1 - 18-7924 metal bowl 2 - 18-4256 1/4" pipe plugs
1/4" Stainless Steel w/ AquaVue™ bowl	18-7937	10	1 - 18-7919 filter & 1 18-7777 bracket 1 - 18-7922 AquaVue™ bowl 2 - 18-4256 1/4" pipe plugs
1/4" Stainless Steel w/ metal drain bowl	18-7938	10	1 - 18-7919 filter & 1 18-7777 bracket 1 - 18-7924 metal bowl 2 - 18-4256 1/4" pipe plugs

COMPACT BRACKET AND SEPARATOR KIT - FOR SMALL OUTBOARDS AND FRESH WATER APPLICATIONS

**18-7774
COMPACT ALUMINUM BRACKET**



**18-7965-1
10 MICRON COMPACT SEPARATOR KIT**
Replaces: MAR-MINIF-LT-AS
Contains:
1 - 18-7774 bracket
1 - 18-7865 filter



REPLACEMENT FILTERS

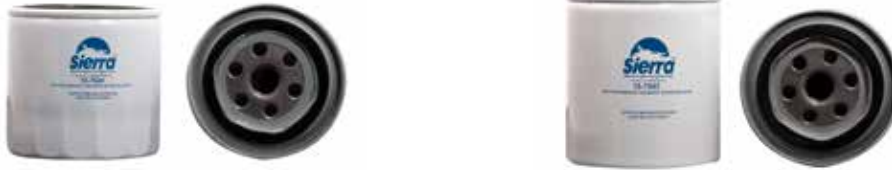

UNIVERSAL DESIGN - DIRECT REPLACEMENT FOR MERCURY AND YAMAHA

10 MICRON REPLACEMENT FILTERS			21 MICRON REPLACEMENT FILTERS		
Part #	Description	Replaces	Part #	Description	Replaces
18-7944	Short - 3.875"		18-7844	Short - 3.875"	
18-7945	Long - 4.35"	ABB-FUELF-IL-TR	18-7845	Long - 4.35"	ABB-FUELF-IL-TR
18-7866	High Capacity - 6"	MAR-FUELF-IL-TR			
18-7865	Compact 10 Micron	MAR-MINIF-IL-TR			



10 Micron replacement filters and kits with drain bowls

REPLACEMENT FILTERS			REPLACEMENT BOWLS		
Part #	Description	Replaces	Part #	Description	Replaces
18-7919	Spin on replacement	MAR-24563-00-00 Racor S3213	18-7922	AquaVue™ Collection Bowl	
18-7920	Spin on replacement	Racor S3214	18-7924	Metal Collection Bowl	MAR-10171-00-10
18-7947	Spin on replacement Fits - 120RRAC01	Racor S3240	FILTER & BOWL KITS		
18-7948	Spin on replacement Fits - 320RRAC01	Racor S3227	Part #	Description	
18-7949	Spin on replacement Fits - 660RRAC02	Racor S3232	18-7928	Filter & AquaVue™ Bowl Mercury/Yamaha Style Contains: 18-7919 filter, 18-7922 bowl	
			18-7929	Filter & Metal Bowl Mercury/Yamaha Style Contains: 18-7919 filter, 18-7924 bowl	



18-79905
10 MICRON FUEL FILTER
 Replaces: 69J-24501-10-00
 Fits: F150 - F225 (2006 - Current), F250 - (2005 - Current)



18-7955
10 MICRON FUEL FILTER ELEMENT
 Replaces: 68F-24563-10-00
 Fits: 150hp -300hp. (2004-2006)
 Models Z, VZ, LZ



18-7488
GASKET, FUEL FILTER BOWL
 Replaces: 6P3-24564-00-00
 Fits: F/LF 150 - F300 (2006 - Current), VZ150 - VZ300 (2006 - Current), Z200 - Z300 (2006 - Current)



18-7710
FUEL FILTER
 Replaces: 68T-24251-00-00
 Fits: F6, F8 (2001 & Up)



18-7713
FUEL FILTER (INLINE)
 Replaces: 646-24251-02-00
 Fits: 6 (1989, 1992-99), 8 (1989-99, 2001-02), F4 (1999-02), F9.9 (1989-95, 1997-99, 2001-02), FT 9.9 (1988-90)



18-7780
FUEL FILTER
 Replaces: 6F5-24563-00-00
 For: 9.9 - 225NR



18-7781
FUEL FILTER
 Replaces: 61N-24563-00-00
 For: 9.9/90° SX



18-7782
FUEL FILTER
 Replaces: 61A-24563-00-00
 For: V6, 3.1L, D-T



FUEL FILTERS

Part #	Application:
18-7828-1	1/4" Small Capacity (For 1/2" Fuel Line)
18-7829	1/4" Large Capacity (For 1/2" Fuel Line)
18-7830	5/16" Replaces: 65W-24251-10-00
18-7831	3/8"

Display Package



18-7979
FUEL FILTER
 Replace: 68V-24563-00-00



18-79799
FUEL FILTER
 Replaces: 6D8-WS24A-00-00
 F50-F115 after April 2006
For filter housing marked "6D8" ONLY!



18-79809
FUEL FILTER
 Replaces: 6P3-WS24A-00-00
 F150, F200, F225, F250, Z-VZ 150 to 300 hp. after April 2006
For filter housing marked "6P3" ONLY!



18-79970
FUEL FILTER
 Replaces: 6BG-13915-00
 Fits: F30(2013), F40(2008-13), F50(2005-13), F60(2005-13), F70(2010-13), F75(2005-13), F90(2005-13), T50(2005-13), T60(2005-13)

NEW



18-79972
ELEMENT, FILTER (CARB INLET)
 Replaces: 67F-14371-01
 Fits: F75(2003-04), F80(2002-03), F90(2003-04), F100(2002-03)



18-79973
FUEL FILTER
 Replaces: 6C5-13915-00
 Fits: F50(2005-13), F60(2005-13), F70(2010-13), F75(2005-13), F90(2005-13), T50(2005-13), T60(2005-13)



18-79977
FUEL FILTER
 Replaces: 6L5-24251-00
 Fits: 3(1992-02), F2.5(2003-12), F4(1999-08)



18-79907
VST FILTER
 Replaces: 60V-24251-01-00
 Fits: LZ150(2005), VZ150(2005-10), Z150(2005), VZ175(2005-10), Z175(2005), LZ200(2005-10), VZ200(2005-09), Z200(2005-10), VZ225(2005-09), LZ250(2005), VZ250(2005-09), Z250(2005), LZ300(2005-06), VZ300(2005-09), Z300(2005-06)



18-79900
VST FILTER
 Replaces: 66K-13915-00-00
 Fits: DX150 (1999-05), LX150 1999-01), PX150 (1999), SX150 (1999-04), VX150 (2000-04), LX200 (1999-01), SX200 (1999-05), V200 (1999), VX200 (2000-05), L225 (1999), LX225 (2000-03), S225 (1999), SX225 (2000-03), V225 (1999), VX225 (2000-04), L250 (1999), LX250 (2000-03), SX250 (2000-03), VX250 (2002-04)



18-79901
VST FILTER
 Replaces: 66L-13915-00-00
 Fits: L225 (1997-98), S225 (1997-98), L250 (1997 - 98), V200 (1998), V225 (1998)



18-79902
VST FILTER
 Replaces: 63P-13915-00-00
 Fits: F150 TXR(2004-09), F150 TLR(2004-09), F150 TJR(2009), LF150 TXR(2004-09), F250 TXR(2005-09), F250 TUR(2005-09), F300 TXR(2007-09), F300 TUR(2007-09), F350 TXR(2007-09), F350 TUR(2007-09), F225TLR (2007-09)



18-79903
VST FILTER
 Replaces: 68V-13915-00-00
 Fits: F115 (2000-09), F200 TXR(2002-09), LF200 TXR(2002-09), F225 TXR(2002-09), F225 TUR(2002-09)



18-79904
VST FILTER
 Replaces: 68F-13915-00-00
 Fits: HPDI 150(2000-05), V-Max HPDI 150(2000-09), V-Max HPDI 175(2001-09), HPDI 200(2000-09), HPDI 225(2003-09), HPDI 250 (2003-09), HPDI 300(2004-09)



18-79910
FUEL FILTER ASSY
 Replaces: 61N-24560-00, 61N-24560-10
 Fits: 15(1994-09), 20(1996-97), 25(1994-09), 30(1995-01), 40(1994-05), 50(1994-09), 60(2001-05), 70(1994-09), 9.9(1994-09), 90(1994-09), B90(1997-99), C25(1994-97), C30(1994-97), C40(1994-03), C50(1998-01), C55(1994-95), C60(1996-01), C75(1994-99), C80(1997), C85(1994-96), C90(1997-01), E48(1995-00), E60(1995-00), E75(1995-00), F15(2005-10), F20(2006-10), F25(2005, 2009-10), F40(1999), F50(1995-04), F9.9(2005-06),



18-79950
VST KITS
 Replaces: Kit 1
 Fits: F150(04-12), LF150(04-12)



18-79951
VST KITS
 Replaces: Kit 2
 Fits: F115(00-11), F200(02-10), F225(02-06), F225TXR(07-10), LF115(00-11), LF200(02-10), LF225(02-06), LF225 TXR(07-10)



18-79952
VST KITS
 Replaces: Kit 3
 Fits: DX150(99-05), L225(99), L250(99), LX150(99-01), LX200(99-01), LX225(00-03), LX250(00-03), PX150(99), S225(99), S250(99), SX150(99-04), SX200(00-05), SX225(00-03), SX250(00-03), V200(99), V225(99), VX150(00-04), VX200(00-05), VX225(00-04), VX250(02-04)

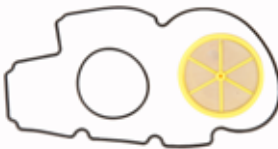

**18-79953
VST KITS**
Replaces: Kit 4
LZ150(00-05), LZ200(00-11), LZ250(03-05), LZ300(04-06), VZ150(00-11), VZ175(01-11), VZ200(01-09), VZ225(03-09), VZ250(03-09), VZ300(04-09), Z150(00-05), Z175(01-05), Z200(00-11), Z250(03-05), Z300(04-06)



**18-7655
OXYGEN SENSOR**
Replaces: 67H8592A0100



**18-7656
OXYGEN SENSOR**
Replaces: 68F8592A0000



**18-7606
WATER SENSOR PROBE**
Replaces: MAR-10171-30-00

8' LENGTH COMPLETE FUEL LINE ASSEMBLIES

**3/8"
FUEL LINE ASSEMBLY**



**18-8077-1
TANK CONNECTOR**
(SOLD SEPARATELY)

*

18-8017EP-1 SILVERADO 4000 Premium



18-80415 FUEL CONNECTOR **18-8005EP-1 PRIMER BULB** **18-80415 FUEL CONNECTOR**

FUEL LINE ASSEMBLY COMPONENTS
Fits: F75-F250 and 115-300 HP

*

OE# 6YL-24306-60-00



*



**18-4462
TANK CONNECTOR**
(Clip Style Fitting)
(Female Twist-on)

Display Package



**18-8002EP-1
18-8002EP-1-10①
PRIMER BULB**
1/4"

**18-8004EP-1
18-8004EP-1-10①
PRIMER BULB**
5/16"
Large capacity bulb

**18-8005EP-1
18-8005EP-1-10①
PRIMER BULB**
3/8"
Replaces: 174512
Large capacity bulb

Display Package



**18-8040
FUEL TANK ELBOW**
Universal Fitting with
1/4" NPT Threads
Replaces: ABA-FBARB-90-DG
(Brass)

Display Package



**18-8055
HOSE BARB**
1/4" NPT threads for
connection of 5/16" I.D. hose
Replaces: ABA-FLINE-BA-RB
(Brass)

Display Package



**18-80414
FUEL CONNECTOR**
(5/16")
Replaces: 6G1-24305-05-00, 6G1-24305-04
Fits: 6(1989, 1992-93), 8(1984-85, 1989-93, 2001-02), 9.9(1984-93, 2000-03), 15(1984-93, 2000-03), 25(1984-85, 1988-93, 2000-03), 30(1984-87, 1989-93, 1999, 2001-02), 40(1984-86, 1988-90, 1992-93, 2000-03), 50(1986-93, 2000-03), 60(2001-03), 70(1984-93, 2000-03), 90(1984-93, 2000-03), C25(1991, 1993), C30(1991-93), C40(1991-93, 2000-02), C50(2000-01), C55(1991-93), C60(2000-01), C70(2000-01), C85(1991-93), C90(2000-01), E48(2000), F6(2001-03), F8(2001-03), F9.9(1985-93, 2001-03), F15(1998-99, 2000-01), F25(1998-99, 2000-03), F30(2001-03), F40(1999, 2000-03), F50(1999, 2000-03), F60(2002-03), T8(2001-03), T9.9(1991-93, 1999, 2001-03), T25(2001-03), T50(1999, 2000-03), T60(2003)
Mates with 18-8077-1

Display Package



**18-80413
FUEL CONNECTOR**
1/4"
Replaces: 6Y1-24305-04
Mates with 18-8077-1

Display Package



**18-80415
FUEL CONNECTOR**
(3/8")
Replaces: 6E5-24305-05, 6Y2-24305-05
Mates with 18-8077-1

Display Package



**18-8077-1
18-8077-1-10①
TANK CONNECTOR**
(1/4" NPT)
Fits: F75-F250 and 115-300HP
Mates with 18-80413, 18-80414, 18-80415

Display Package

* Tanks and Engines for picture purpose only. ① Discount shop pack of 10 - Priced per package



**18-9145
OETIKER CLAMP KIT**
Replaces: YB-6AW04-A
Fits: All F115-F350 and HPDI Models.
Kit includes **18-9146-9** replaces: **YB-6AW04-3**
19.8 mm clamp and **18-9133-9** replaces:
YB-6AW04-1 15.7 mm clamp. Package of 10,
available individually.



**18-8911
IMPELLER**
Replaces: 67F-44352-00-00
Fits: 3(1988-02), F2.5(2003-12)



**18-3042
IMPELLER**
Replaces: 67F-44352-00-00
Fits: F75 (03-05), F80 Jet Drive (2001-02),
F80 (1999-03), F100 (1999-02), F90
(2003-05), F90 Jet Drive (2003-04)



**18-8910
IMPELLER**
Replaces: 68T-44352-00-00
For: F6, F8 (2001-Up)



**18-3040
IMPELLER**
Replaces: 63V-44352-01-00
For: T8 (2001-Up) /9.9/15 (2-Stroke)
(1996-Up)/F15 (1998-Up), F20 (2006-Up)



**18-3063
IMPELLER**
Replaces: 662-44352-01-00
(6/8 HP)



**18-3065
IMPELLER**
Replaces: 6L2-44352-00-00
(25 HP)



**18-3066
IMPELLER**
Replaces: 6G1-44352-00-00
(6 & 8 HP)



**18-3067
IMPELLER**
Replaces: 689-44352-02-00
(25 HP)



**18-3068
IMPELLER**
Replaces: 6H4-44352-00-00,
6H4-44352-02-00
(30,40,50 HP)



**18-3069
IMPELLER**
Replaces: 6H3-44352-00-00,
697-44352-00-00
55, 60, 70 HP F50, T50



**18-3070
IMPELLER**
Replaces: 688-44352-03-00
(C75, C85, 90 HP)



**18-3071
IMPELLER**
Replaces: 6E5-44352-00-00,
6E5-44352-01-00
(115, 150, 175, 200, 250 HP)



**18-3072
IMPELLER**
Replaces: 646-44352-01-00
(2 HP)



**18-3073
IMPELLER**
Replaces: 6E0-44352-00-00
(4 & 5 HP)



**18-3074
IMPELLER**
Replaces:
682-44352-01-00 (9.9,15 HP)



**18-3088
IMPELLER**
Replaces:
6F5-44352-00-00 (C40 HP)



**18-8925
IMPELLER**
Replaces: 6AW-44352-00-00
Fits: Yamaha F350 2006 & Up



**18-3162
CUP**
Replaces: 67F-44322-00-00
For: F75 (2003-04), F80(1999-03),
F90(2003-04), F100(1999-02)



**18-3164
CUP**
Replaces: 6L5-44322-00-00
For: F2.5 (2003-04), 3 (1988-99, 2002)



**18-3456
CUP**
Replaces: 6G1-44322-00-00
Fits: 6 (1986-00), 8 (1984-05)



**18-3333
INSERT CUP**
Replaces: 61A-44322-00-00



**18-3435
INSERT CUP**
Replaces: 663-44322-00-00



**18-3443
INSERT CUP**
Replaces: 61N-44322-01-00
Fits: (1998-03) F25, (1993-97) C30



**18-3444
INSERT CUP**
Replaces: 63V-44322-00-00
Fits: 9.9/15 (1996-04), F15 (1998-04), F6/F8/T8 (20001-04)



**18-3449
INSERT CUP**
Replaces: 63D-44322-00-00
Fits: 40 (1995-04), 50 (1995-97, 1999-04)



**18-3519
WATER PUMP
HOUSING INSERT**
Replaces: 61A-44322-02-00
Fits: F225 Produced after 04/2007 / F250
Produced after 4/2006



**18-3185
WATER PUMP HOUSING**
Replaces: 61N-44311-01-00, 61A-44311-01-00
Fits: C30 (1993-97), F25 (1998-06)



**18-3170
WATER PUMP HOUSING**
Replaces: 6E5-44311-00-00



**18-3171
WATER PUMP HOUSING**
Replaces: 688-44311-01-00



**18-3173
WATER PUMP HOUSING**
Replaces: 61A-44311-00-00, 61A-44311-01-00



**18-3356
WATER PUMP HOUSING**
Replaces: 63V-44301-00-00
Fits: Two-Stroke: 9.9hp-15hp (1996-Current), Four-Stroke: 6hp-8hp (2001-Current); 9.9hp. (2006-Current); 15hp (1998-Current)

BOLTS

Part #	O.E. #	Application
18-0256	97095-08045-00	8-1.25 x 45mm
18-2602	97080-08045-00	F6 (2001-05), F8 (2001-05) M8-1.25x45mm 18-8S/S
18-2605	90119-08M87-00	F80 (1999-03), F90 (2003-04), F100 (1999-02) M8-1.25x75mm 18-8 S/S
18-2606	90119-08M13-00	F80 (1999-03), F90 (2003-04), F100 (1999-02) M8-1.25x50mm 18-8 S/S
18-2607	97095-06040-00	For: 3HP (1988-99, 2002) M8-1.0x40mm 18-8 S/S
18-8400-9 ^{①②}	90119-08M15-00	8-1.25 x 29mm



IMPELLER KEYS

18-3297	90280-03M03-00
18-3305	90280-03024-00
18-3300	90280-04M00-00
18-3301	90280-04M04-00
18-3302	90280-04M05-00



**18-3518
WATER PUMP
BASE OUTER PLATE**
Replaces: 6P2-44323-00-00
Fits: F225 Produced after 04/2007 / F250
Produced after 4/2006



**18-3520
WATER PUMP
BASE OUTER PLATE**
Replaces: 60X-44323-00-00
Fits: VZ200 (3.3L) 2005-2010, VZ225 (3.3L) 2003-2010, VZ250 (3.3L) 2003-2010, VZ300 (3.3L) 2005-2010



**18-3521
WATER PUMP
BASE OUTER PLATE**
Replaces: 68V-44323-00-00
Fits: F115 2002-2010 / LF115 2002-2010



**18-3194
PLATE**
Replaces: 61N-44323-00
Fits: C30 (1993-97), F25 (1998-06)



18-3328
CUP
Replaces: 646-44322-00-00
Fits: 2 (1989, 1991-99, 2002)



18-3357
PLATE
Replaces: 646-44323-00-00
Fits: 2 (1989, 1991-99, 2002)



18-3142
IMPELLER PLATE
Replaces: 68T-44323-00-00
For: F6, F8 (2001-05)



18-3143
IMPELLER PLATE
Replaces: 67F-44323-00-00
For: F75 (2003-04), F80(1999-03), F90(2003-04), F100(1999-02)



18-3163
IMPELLER PLATE
Replaces: 6L5-44323-00-00
For: 3HP (1988-99, 2002)



18-3344
WEAR PLATE
Replaces: 6E5-44323-00-00



18-3345
WEAR PLATE
Replaces: 6G5-44323-00-00



18-3186
IMPELLER PLATE
Replaces: 63D-44323-00-00
Fits: 40 (1995-04), 50 (1995-97, 1999-04)



18-3195
IMPELLER PLATE
Replaces: 63V-44323-00-00
Fits: 9.9/15 (1996-04), F15 (1998-04)



18-3196
IMPELLER PLATE
Replaces: 66T-44323-00-00
Fits: F30 (2001-04), F40 (2000-04), T25 (2001-04)



18-3436
WEAR PLATE
Replaces: 663-44323-00-00



18-1831
WATER SEAL DAMPER
Replaces: 682-44366-00
Fits: 9.9(1984-95), 15(1984-95)



18-1832
WATER SEAL DAMPER
Replaces: 682-44367-00
Fits: 9.9(1984-95), 15(1984-95)

18-1830
WATER SEAL DAMPER
Replaces: 663-44366-00

Fits: 25 ML, MS(1997-02), 30(1987-01), 40(1984-05), 50(1986-09), 60(2001-05), 70(1984-09), 90(1984-09), B90(1997-99), C30(1995), C40(1991-01), C50(1998-01), C55(1991-95), C60(1996-01), C70(2000-01), C75(1994-99), C80(1997), C85(1991-96), C90(1997-01), E48(1995-00), E60(1995-00), E75(1995-00), F30(2001-05, 2013), F40(1999-13), F50(1995-13), F60(2002-13), F70(2010-13), F75(2003-11), F80(1999-03), F90(2003-13), F100(1999-03), F200(2002-12), F225(2002-12), F250(2005-12), L225(1994-99), L250(1990-99), LF200(2002-12), LF225(2002-10), LF250(2005-12), LX225(2000-03), LX250(2000-03), LZ250(2003-05), LZ300(2004-06), P40(1998), P50(1991-96), P60(1991-99), P75(1996-99), S225(1996-99), S250(1996-99), SX225(2000-03), SX250(2000-03), T25(2001-13), T50(1996-13), T60(2003-13), V200(1998-99), V225(1998-99), VX200(2000-05), VX225(2000-04), VX250(2002-04), VZ200(2005-09), VZ225(2005-09), VZ250(2003-09), VZ300(2004-09), Z250(2003-05), Z300(2004-06)





18-1833
WATER SEAL DAMPER
 Replaces: 647-44366-00
 Fits: 6(1986-00), 8(1984-00), 9.9(1996-09), 15(1996-09), F9.9(2005-06), F15(1998-06), T9.9(2005-06)



18-1834
WATER SEAL DAMPER
 Replaces: 682-44365-00
 Fits: 6(1986-00), 8(1984-00), 9.9(1996-09), 15(1996-09), F9.9(2005-06), F15(1998-06), T9.9(2005-06)



18-3505
WATER SEAL DAMPER
 Replaces: 63V-44365-10-00
 Fits: 2-Stroke: 9.9hp & 15hp 1997-Current
 4-Stroke: F6 & F/T8 2001-Current; F/T 9.9 2005-Current; F15 1998-Current



18-3166
WATER SEAL DAMPER
 Replaces: 6E0-44366-00-00
 For: 2 (1984-85, 88-99, 2002), 3 (1988-99, 02), 4 (1984-85, 88-99), 5 (1984-85, 95-02), F2.5 (2003-05)



18-3176
WATER SEAL DAMPER
 Replaces: 68T-44366-00-00
 For: F6, F8 (2001-05), C30 (1993-97)



18-9075
SPACER
 Replaces: 61A-45538-00-00
 Fits: 2-Stroke: 115hp.-300hp.(1993-Current), 4-Stroke: 115hp.-225hp.(2002-Current)



18-9076
COLLAR
 Replaces: 61A-45527-00-00
 Fits: 2-Stroke: 115hp.-300hp. (1993-Current), 4-Stroke: 115hp.-225hp.(2002-Current)



18-9077
WAVE WASHER
 Replaces: 90206-22M19
 Fits: 2-Stroke: 115hp.-300hp.(1993-Current), 4-Stroke: 115hp.-225hp.(2002-Current)



18-9079
WAVE WASHER KIT
 Replaces:
 Fits: Yamaha 2-stroke 115-300hp (1993 & Up); Yamaha 4-stroke 115-225hp (2002 & Up); Mercury 4-stroke 225 EFI S/N 0T653945 & Up



18-9078
STAINLESS STEEL WASHER
 Replaces: 90201-22M01
 Fits: 2-Stroke: 115hp.-300hp.(1993-Current), 4-Stroke: 115hp.-225hp.(2002-Current)



18-3442
WATER PUMP REPAIR KIT
 Replaces: 68V-W0078-00-00
 For: F115 2002-2010 / LF115 2002-2010

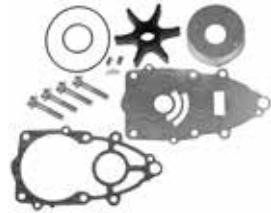

18-3515
WATER PUMP REPAIR KIT
 Replaces: 6P2-W0078-00-00
 For: F225 Produced after 04/2007 / F250 Produced after 4/2006

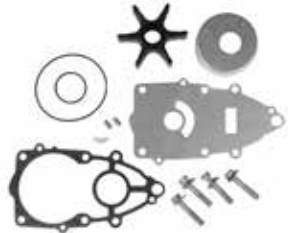

18-3516
WATER PUMP REPAIR KIT
 Replaces: 60X-W0078-00-00
 For: VZ200 (3.3L) 2005-2010, VZ225 (3.3L) 2003-2010, VZ250 (3.3L) 2003-2010, VZ300 (3.3L) 2005-2010



18-3408
WATER PUMP KIT W/HOUSING
 Replaces: 6H4-W0078-00, A0 + 663-44311-02
 For: 40(1984-87), 50(1984-87), Pro50(1987)



18-3409
WATER PUMP KIT W/HOUSING
 Replaces: 67F-W0078-00 + 67F-44311-01
 For: F75(2006-10), F80(1999-03), F90(2006-10), F100(1999-03)



18-3410
WATER PUMP KIT W/HOUSING
 Replaces: 68T-W0078-00 + 63V-44301-00
 For: F6(01-08), F8(01-09), F9.9(07-09)



18-3411
WATER PUMP KIT W/HOUSING
 Replaces: 682-W0078-A1 + 682-44300-01
 For: 9.9(1984-95), 15(1984-95), F9.9(1985-96), FT9.9(1985-90), T9.9(1991-96)



18-3412
WATER PUMP KIT W/HOUSING
 Replaces: 63V-W0078-01 + 63V-44301-00
 For: 9.9(1996-09), 15(1996-09), F9.9(2005-06), F15(1998-05), T9.9(2005-06)



18-3413
WATER PUMP KIT W/HOUSING
 Replaces: 66T-W0078-00 + 66T-44311-00
 For: F30(2001-05), F40(2000-08), T25(2001-06)



18-3415
WATER PUMP KIT W/HOUSING
 Replaces: 63D-W0078-01 + 63D-44311-00
 For: 40(1997-05), 50(1997-09), C40(1997-03), C50(1998-01), F40(1999), F50(1995-09), F60(2002-09), P40(1998),



18-3461
WATER PUMP KIT W/HOUSING
 Replaces:
 6H3-W0078-00, A0 + 6H3-44311-00
 For: 70(1984-91), P60(1991), T50(1996)



18-3466
WATER PUMP KIT W/HOUSING
 Replaces:
 6H3-W0078-01, 02 + 6H3-44311-00
 For: 70(1992-03), C60(1996-01), E60(1995-96), P60(1992-99), C70(2000-01), T50(1997-10), T60(2003-10)



18-3522
WATER PUMP KIT W/HOUSING
 Replaces:
 60X-W0078-00 + 61A-44311-01
 For: VZ200(2005-09), VZ225(2003-09), VZ250(2003-09), VZ300(2004-09)



18-3523
WATER PUMP KIT W/HOUSING
 Replaces:
 68V-W0078-00 + 61A-44311-01
 For: VZ200(2005-09), VZ225(2003-09), VZ250(2003-09), VZ300(2004-09)



18-3432
WATER PUMP KIT
 Replaces: 61N-W0078-11-00
 Fits: F25(1998-05)



18-3450
WATER PUMP KIT
 Replaces: 68T-W0078-00-00
 For: F6, F8 (2001-05)



18-3451
WATER PUMP KIT
 Replaces: 67F-W0078-00-00
 Fits: F75 (2003-06), F80(1999-03), F90(2003-04), F100(1999-02)



18-3460
WATER PUMP KIT
 Replaces: 6N0-W0078-A0-00, 6G1-W0078-A1
 Fits: 6(1986-00), 8(1984-05),



18-3462
WATER PUMP KIT
 Replaces: 6A1-W0078-02-00
 Fits: 2(1988-02)



18-3463
WATER PUMP KIT
 Replaces: 6A1-W0078-01-00
 Fits: 2(1984-87)



18-3464
WATER PUMP KIT
 Replaces: 6H3-W0078-01-00
 Fits: C60(1996), E60(1995-96), P60(1992-96), 70(1992-96)



18-3465
WATER PUMP KIT
 Replaces: 6H3-W0078-02-00
 Fits: T50(1997-05), 60(2001-03), C60(1997-01), C70(2000-01), P60(1997-99), T60(2003-05), 70(1997-03)



18-3148
WATER PUMP KIT
Without Housing
Replaces: 682-W0078-A1-00

— CONTAINS —

Part #	Desc.	O.E.#	Qty.
18-0768	Wear Plate Gasket	682-44315-A0-00	1
18-3074	Impeller	682-44352-01-00	1
18-3305	Woodruff Key	90280-03024	1



18-3310
WATER PUMP KIT
Without Housing
Replaces: 6G5-W0078-01-00

— CONTAINS —

Part #	Description	O.E.#	Qty.
18-3071	Impeller	6E5-44352-00	1
18-3345	Wear Plate	6G5-44323-00	1
18-3302	Woodruff Key	90280-04M05-00	1
18-0244	Water Pump Gasket	6E5-44315-A0-00	1
18-0256	Bolt	97395-08045-00	4
18-7483	O-Ring	93210-37M67-00	1
18-7485	O-Ring	93210-86M38-00	1



18-3311
WATER PUMP KIT
With Housing
Replaces: 6G5-W0078-A1-00

— CONTAINS —

Part #	Description	O.E.#	Qty.
18-3170	Water Pump Housing	6E5-44311-00	1
18-3071	Impeller	6E5-44352-00	1
18-3345	Wear Plate	6G5-44323-00	1
18-3302	Woodruff Key	90280-04M05-00	1
18-0244	Water Pump Gasket	6E5-44315-A0-00	1
18-0256	Bolt	97395-08045-00	4
18-7483	O-Ring	93210-37M67-00	1
18-7485	O-Ring	93210-86M38-00	1



18-3312
WATER PUMP KIT
Without Housing
Replaces: 6N6-W0078-00-00

— CONTAINS —

Part #	Description	O.E.#	Qty.
18-3302	Woodruff Key	90280-04M05-00	1
18-3333	Insert Cup	61A-44322-00	1
18-3071	Impeller	6E5-44352-00	1
18-3344	Wear Plate	6E5-44323-00	1
18-0244	Water Pump Gasket	6E5-44315-A0-00	1
18-0256	Bolt	97395-08045-00	4
18-7483	O-Ring	93210-37M67-00	1
18-7485	O-Ring	93210-86M38-00	1



18-3313
WATER PUMP KIT
With Housing
Replaces: 6N6-W0078-01-00

— CONTAINS —

Part #	Description	O.E.#	Qty.
18-3173	Water Pump Housing	61A-44311-00	1
18-3302	Woodruff Key	90280-04M05-00	1
18-3333	Insert Cup	61A-44322-00	1
18-3071	Impeller	6E5-44352-00	1
18-3344	Wear Plate	6E5-44323-00	1
18-0244	Water Pump Gasket	6E5-44315-A0-00	1
18-0256	Bolt	97395-08045-00	4
18-7483	O-Ring	93210-37M67-00	1
18-7485	O-Ring	93210-86M38-00	1



18-3370
WATER PUMP KIT
Without Housing
Replaces: 692-W0078-00-00, 692-W0078-01-00,
692-W0078-A0-00

— CONTAINS —

Part #	Description	O.E.#	Qty.
18-3301	Woodruff Key	90280-04M04-00	1
18-3070	Impeller	688-44352-03	1
18-0239	Wear Plate to Pump Housing Gasket	688-44315-A0-00	1
18-0240	Wear Plate to Gear Case Mounting Gasket	688-44316-A0-00	1
18-7436	O-Ring	93210-46044-00	1



18-3371
WATER PUMP KIT
With Housing
Replaces: 692-W0078-A0-00

— CONTAINS —

Part #	Description	O.E.#	Qty.
18-3171	Water Pump Housing	688-44311-01	1
18-3301	Woodruff Key	90280-04M04-00	1
18-3070	Impeller	688-44352-03	1
18-0239	Wear Plate to Pump Housing Gasket	688-44315-A0-00	1
18-0240	Wear Plate to Gear Case Mounting Gasket	688-44316-A0-00	1
18-7436	O-Ring	93210-46044-00	1



18-3372
WATER PUMP KIT
Without Housing
Replaces: 6E5-W0078-01-00

— CONTAINS —

Part #	Description	O.E.#	Qty.
18-3302	Woodruff Key	90280-04M05-00	1
18-3071	Impeller	6E5-44352-00	1
18-3344	Wear Plate	6E5-44323-00	1

18-3373
WATER PUMP KIT
With Housing

Replaces: 6E5-W0078-A1-00



— CONTAINS —

Part #	Description	O.E. #	Qty.
18-3170	Water Pump Housing	6E5-44311-00-00	1
18-3302	Woodruff Key	90280-04M05-00	1
18-3071	Impeller	6E5-44352-00	1
18-3344	Wear Plate	6E5-44323-00	1
18-0244	Water Pump Gasket	6E5-44315-A0-00	1
18-0256	Bolt	97395-08045-00	4
18-7483	O-Ring	93210-37M67-00	1
18-7485	O-Ring	93210-86M38-00	1

18-3374
WATER PUMP KIT
Without Housing

Replaces: 6F5-W0078-00-00



— CONTAINS —

Part #	Description	O.E. #	Qty.
18-3300	Woodruff Key	90280-04M00-00	1
18-3088	Impeller	6F5-44352-00	1
18-0256	Bolt	97395-08045-00	2

18-3375
WATER PUMP KIT
With Housing

— CONTAINS —



Part #	Description	O.E. #	Qty.
18-3300	Woodruff Key	90280-04M00	1
18-3088	Impeller	6F5-44352-00	1
18-0256	Bolt	97395-08045-00	2

18-3395
WATER PUMP KIT
Without Housing

Replaces: 61A-W0078-01-00



— CONTAINS —

Part #	Description	O.E. #	Qty.
18-3071	Impeller	6E5-44352-00	1
18-3345	Wear Plate	6G5-44323-00	1
18-3302	Woodruff Key	90280-04M05-00	1
18-3333	Insert Cup	61A-44322-00	1
18-0244	Water Pump Gasket	6E5-44315-A0-00	1
18-0256	Bolt	97395-08045-00	4
18-7483	O-Ring	93210-37M67-00	1
18-7485	O-Ring	93210-86M38-00	1

18-3396
WATER PUMP KIT
With Housing

Replaces: 61A-W0078-A2-00, 61A-W0078-A3-00



— CONTAINS —

Part #	Description	O.E. #	Qty.
18-3173	Water Pump Housing	61A-44311-00	1
18-3071	Impeller	6E5-44352-00	1
18-3345	Wear Plate	6G5-44323-00	1
18-3302	Woodruff Key	90280-04M05-00	1
18-3333	Insert Cup	61A-44322-00	1
18-0244	Water Pump Gasket	6E5-44315-A0-00	1
18-0256	Bolt	97395-08045-00	4
18-7483	O-Ring	93210-37M67-00	1
18-7485	O-Ring	93210-86M38-00	1

18-3397
WATER PUMP KIT
Without Housing

Replaces: 679-W0078-00-00, 679-W0078-A0-00



— CONTAINS —

Part #	Description	O.E. #	Qty.
18-3088	Impeller	6F5-44352-00	1
18-3300	Woodruff Key	90280-04M00-00	1
18-0256	Bolt	97395-08045-00	2

18-3398
WATER PUMP KIT
With Housing

Replaces: 6F5-W0078-A0-00



— CONTAINS —

Part #	Description	O.E. #	Qty.
18-3088	Impeller	6F5-44352-00	1
18-3300	Woodruff Key	90280-04M00-00	1
18-0256	Bolt	97395-08045-00	2

18-3425
WATER PUMP KIT
Without Housing

Replaces: 663-W0078-00-00, 663-W0078-A0-00



— CONTAINS —

Part #	Description	O.E. #	Qty.
18-0292	Wear Plate to Pump Housing Gasket	663-44315-A0-00-00	1
18-3435	Insert Cup	663-44322-00-00	1
18-0294	Wear Plate to Pump Base Gasket	663-44324-A0-00-00	1
18-3069	Impeller	6H3-44352-00-00	1
18-0256	Bolt	97395-08045-00	2
18-3436	Impeller Plate	663-44323-00-00	1

18-3426
WATER PUMP KIT
With Housing
 Replaces: 689-W0078-04-00, 689-W0078-A4-00
 — CONTAINS —

Part #	Description	O.E. #	Qty.
18-3067	Impeller	689-44352-02-00	1
18-3244	Impeller Key	664-44338-00	1
18-2730	Upper Water Tube Seal	664-44365-01	1

18-3427
WATER PUMP KIT
With Housing
 Replaces: 689-W0078-A6-00
 — CONTAINS —

Part #	Description	O.E. #	Qty.
18-0773	Wear Plate Gasket	689-44316-A0-00	1
18-3244	Impeller Key	664-44338-00	1
18-2730	Upper Water Tube Seal	664-44365-01	1
18-3067	Impeller	689-44352-02-00	1

18-3428-1
WATER PUMP KIT
Without Housing
 Replaces: 6H3-W0078-00-00, 6H3-W0078-A0-00
 — CONTAINS —

Part #	Description	O.E. #	Qty.
18-0240	Water Pump Gasket	688-44316-A0-00	1
18-3069	Impeller	6H3-44352-00-00	1
18-7436	O-Ring	93210-46044-00	1
18-0256	Bolt	97395-08045-00	2
18-0756-1	Water Pump Gasket	6H3-44315-A0-00	1
18-0757	Outer Plate Gasket	6H3-44324-A0-00	1

18-3429
WATER PUMP KIT
Without Housing
 Replaces: 6H4-W0078-00-00, 6H4-W0078-A0-00
 — CONTAINS —

Part #	Description	O.E. #	Qty.
18-0292	Wear Plate to Gear Case Mounting Gasket	688-44315-A0-00	1
18-3435	Insert Cup	663-44322-00-00	1
18-0294	Wear Plate to Pump Base Gasket	663-44324-A0-00	1
18-3068	Impeller	6H4-44352-02-00, 6H4-44352-00-00	1
18-0256	Bolt	97395-08045-00	2
18-3436	Impeller Plate	663-44323-00-00	1

18-3430
WATER PUMP REPAIR KIT
Without Housing
 Replaces: 6J8-W0078-A1-00
 — CONTAINS —

Part #	Description	O.E. #	Qty.
18-0292	Wear Plate to Gear Case Mounting Gasket	688-44315-A0-00	1
18-3435	Insert Cup	663-44322-00-00	1
18-0294	Wear Plate to Pump Base Gasket	663-44324-A0-00	1
18-3068	Impeller	6H4-44352-02-00, 6H4-44352-00-00	1
18-0256	Bolt	97395-08045-00	2
18-3436	Impeller Plate	663-44323-00-00	1

18-3431
WATER PUMP KIT
Without Housing
 Replaces: 6L2-W0078-00-00
 — CONTAINS —

Part #	Description	O.E. #	Qty.
18-3065	Impeller	6L2-44352-00-00	1
18-7483	O-Ring	93210-37M67-00	1

18-3433
WATER PUMP KIT
 Replaces: 63V-W0078-01-00
 Fits: 9.9/15(1996-04), F15 (1998-04)

18-3434
WATER PUMP KIT
 Replaces: 63D-W0078-01-00
 Fits: 40/50(1995-03), P40(1998), C40 3 cyl(1997-02), C50(1999-01), F40 2.6L(1999), F50(1995-03), P50 (1995-96), F60(2002-03)

18-3440
WATER PUMP KIT
 Replaces: 66T-W0078-00-00
 Fits: T25 (2001-04), F30 (2001-04), F40 (2000-04)

HP/Model	Year	Impeller	Cup	Plate	Housing	Kit with Housing	Kit without Housing
FOUR-STROKE MODELS							
F4	1999-01	18-3073					
F4	2002-11	18-3073				—	—
F6	2001-08	18-8910	18-3444	18-3142	18-3356	18-3410	18-3450
F6	2009-11	18-3073	—	—	—	—	—
F8	2001-11	18-8910	18-3444	18-3142	18-3356	18-3410	18-3450
T8	2001-10	18-3040	18-3444	18-3142	—	—	—
F9.9	1985-04	18-3074	—	—	—	18-3411	18-3148
F9.9	2005-06	18-3040	18-3444	18-3195	18-3356	18-3412	18-3433
F9.9	2007-11	18-8910	18-3444	18-3142	18-3356	18-3410	18-3450
FT9.9	1985-90	18-3074	—	—	—	18-3411	18-3148
T9.9	1991-96	18-3074	—	—	—	18-3411	18-3148
T9.9	2005-06	18-3040	18-3444	18-3195	18-3356	18-3412	18-3433
F15	1998-05	18-3040	18-3444	18-3195	18-3356	18-3412	18-3433
F15	2006-11	18-3040	18-3444	18-3142	—	—	—
F25	1998-05, 2009-11	18-3068	18-3443	18-3194	18-3185	18-3432	—
T25	2001-06, 2009	18-3068	18-3449	18-3196	—	18-3413	18-3440
F30	2001-05	18-3068	18-3449	18-3196	—	18-3413	18-3440
F40	1999	18-3069	18-3449	18-3186	—	18-3415	18-3434
F40	2000-08	18-3068	18-3449	18-3196	—	18-3413	18-3440
F40 2.6L	1999	18-3069	18-3449	18-3186	—	—	18-3434
F50	1995-09	18-3069	18-3449	18-3186	—	18-3415	18-3434
T50	1996	18-3069	18-3435	—	—	18-3461	18-3428-1
T50	1997-11	18-3069	18-3435	—	—	18-3466	18-3465
F60	2002-09	18-3069	18-3449	18-3186	—	18-3415	18-3434
T60	2003-11	18-3069	18-3435	—	—	18-3466	18-3465
F75	2003-11	18-3042	18-3162	18-3143	—	18-3409	18-3451
F80	1999-03	18-3042	18-3162	18-3143	—	18-3409	18-3451
F90	2003-11	18-3042	18-3162	18-3143	—	18-3409	18-3451
F100	1999-03	18-3042	18-3162	18-3143	—	18-3409	18-3451
F115/LF115	2000-11	18-3071	18-3519	18-3521	18-3173	—	18-3442
F150 / LF150	2004-11	18-3071	18-3519	18-3345	18-3173	18-3396	18-3395
F200/LF200	2002-11	18-3071	18-3519	18-3345	18-3173	18-3396	18-3395
VF200	2009-11	18-3071	18-3519	—	18-3173	—	—
F225/LF225	2002-10	18-3071	18-3519	18-3345	18-3173	18-3396	18-3395
F225/LF225	* 2007-09	18-3071	18-3519	18-3518	18-3173	—	18-3515
VF225	2009-11	18-3071	18-3519	—	18-3173	—	—
F250 / LF250	** 2005	18-3071	18-3519	18-3345	18-3173	18-3396	18-3395
F250 / LF250	** 2006-11	18-3071	18-3519	18-3518	18-3173	—	18-3515
VF250	2009-10	18-3071	18-3519	—	18-3173	—	18-3515
F300	2007-10	—	—	—	—	—	—
LF300	2007-10	—	—	—	—	—	—
Z300							18-3515
F350	2007-10	—	—	—	—	—	—
LF350	2007-10	—	—	—	—	—	—

TWO-STROKE MODELS							
HP/Model	Year	Impeller	Cup	Plate	Housing	Kit with Housing	Kit without Housing
2	1984-87	18-3072	18-3328	18-3357	—	18-3463	—
2	1988-02	18-3072	18-3328	18-3357	—	18-3462	—
4	1984-99	18-3073					—
5	1984-02	18-3073					—
6	1986-00	18-3066	18-3456		—	—	18-3460
8	1984-09	18-3066	18-3456		—	—	18-3460
9.9	1984-95	18-3074				18-3411	18-3148
9.9	1996-09	18-3040	18-3444	18-3195		18-3412	18-3433
15	1984-95	18-3074				18-3411	18-3148
15	1996-09	18-3040	18-3444	18-3195		18-3412	18-3433
20	1996-97	18-3065			—	—	18-3431
25	1984-85	18-3067				18-3426	—
25	1986-87	18-3067				18-3427	—
25 (2 cyl)	1988-09	18-3065			—	—	18-3431
25 (3 cyl)	1996-02	18-3068	—	—	—	—	—
C25	1990-97	18-3067				18-3427	—
CV25	1990	18-3067				18-3427	—
30	1984-85	18-3067				18-3426	—
30	1986	18-3067				18-3427	—
30	1987-01	18-3068	18-3435	18-3436	—	—	18-3430
C30	1990-92	18-3067				18-3427	—
C30	1993-97	18-3068	18-3443	18-3194	18-3185	18-3432	—
40	1984-87	18-3068	18-3435	18-3436	—	18-3408	18-3429
40	1988-94	18-3068	18-3435	18-3436	—	—	18-3429
40	1995-05	18-3069	18-3449	18-3186		18-3415	18-3434
C40	1990-91	18-3088	—	—	—	18-3375	18-3374
C40	1992-97	18-3088	—	—	—	18-3398	18-3397
C40	1997-03	18-3069	18-3449	18-3186		18-3415	18-3434
P40	1998	18-3069	18-3449	18-3186		18-3415	18-3434
50	1984-87	18-3068	18-3435	18-3436	—	18-3408	18-3429
50	1988-94	18-3068	18-3435	18-3436	—	—	18-3429
50	1995-09	18-3069	18-3449	18-3186		18-3415	18-3434
C50	1998-01	18-3069	18-3449	18-3186		18-3415	18-3434
PRO 50	1987	18-3068	18-3435	18-3436	—	18-3408	18-3429
PRO 50	1988-90	18-3068	18-3435	18-3436	—	—	18-3429

① 2.6L engine ② 3.1L engine * models with 20" shaft ** excludes 4.2L

HP/Model	Year	Impeller	Cup	Plate	Housing	Kit with Housing	Kit without Housing
P50	1991-93	18-3068	18-3435	18-3436	—	—	18-3429
P50	1995-96	18-3069	18-3449	18-3186	—	—	18-3434
50 Jet	1986-89	18-3068	—	—	—	—	—
C55	1991-94	18-3069	18-3435	18-3436	—	—	18-3425
CV55	1989	18-3069	18-3435	18-3436	—	—	18-3425
60	2001-03	18-3069	18-3435	—	—	—	18-3465
60	2004-05	18-3070	—	—	18-3171	18-3371	18-3370
C60	1996-01	18-3069	18-3435	—	—	18-3466	18-3465
E60	1995-96	18-3069	18-3435	—	—	18-3466	18-3465
E60	1997-00	18-3069	—	—	—	—	—
P60	1991	18-3069	18-3435	—	—	18-3461	18-3428-1
P60	1992-99	18-3069	18-3435	—	—	18-3466	18-3465
70	1984-91	18-3069	18-3435	—	—	18-3461	18-3428-1
70	1992-03	18-3069	18-3435	—	—	18-3466	18-3465
70	2004-09	18-3070	—	—	18-3171	18-3371	18-3370
C70	2000-01	18-3069	18-3435	—	—	18-3466	18-3465
C75	1994-99	18-3070	—	—	18-3171	18-3371	18-3370
E75	1995-00	18-3070	—	—	—	—	—
P75	1996-99	18-3070	—	—	—	—	—
C80	1997	18-3070	—	—	—	—	—
85	1985	18-3070	—	—	—	—	—
C85	1989-97	18-3070	—	—	18-3171	18-3371	18-3370
CV85	1989-91	18-3070	—	—	18-3171	18-3371	18-3370
90	1984-09	18-3070	—	—	18-3171	18-3371	18-3370
90 Jet	1986-89	18-3070	—	—	—	—	—
B90	1997-99	18-3070	—	—	—	—	—
C90	1997-01	18-3070	—	—	18-3171	18-3371	18-3370
C115	1991-92	18-3071	—	18-3344	18-3170	18-3373	18-3372
C115	1993-96	18-3071	18-3333	18-3344	18-3173	18-3313	18-3312
C115	1997-00	18-3071	—	18-3344	—	—	—
P115 (62A)	1993-96	18-3071	18-3333	18-3344	18-3173	18-3313	18-3312
115 (6N6), (6E5)	1984-94	18-3071	—	18-3344	18-3170	18-3373	18-3372
115 (6N6)	1994	18-3071	18-3333	18-3344	18-3173	18-3313	18-3312
130 (6L1), (6N7)	1988-92	18-3071	—	18-3344	18-3170	18-3373	18-3372
130 (6N7)	1993-96	18-3071	18-3333	18-3344	18-3173	18-3313	18-3312
130	1997-01	18-3071	—	18-3344	—	—	—
130	2002-04	—	—	18-3344	—	—	—
L130 (6L6), (6N4)	1989-92	18-3071	—	18-3344	18-3170	18-3373	18-3372
L130 (6N4)	1993-96	18-3071	18-3333	18-3344	18-3173	18-3313	18-3312
L130	1997-01	18-3071	—	18-3344	—	—	—
C150 (6E5)	1996-99	18-3071	18-3333	18-3345	18-3173	18-3396	18-3395
150 (6R2), (6G4)	1984-91	18-3071	—	18-3344	18-3170	18-3311	18-3310
150 (6R2)	1992-09	18-3071	18-3333	18-3345	18-3173	18-3396	18-3395
L150 (6R0), (6K0)	1986-91	18-3071	—	18-3344	18-3170	18-3311	18-3310
L150 (6R0)	1992-99	18-3071	18-3333	18-3345	18-3173	18-3396	18-3395
P150	1986-91	18-3071	—	18-3344	18-3170	18-3311	18-3310
P150	1992-99	18-3071	18-3333	18-3345	18-3173	18-3396	18-3395
150/175/200ETLN	1984	18-3071	—	18-3344	18-3170	18-3311	18-3310
PRO V150 (6J9)	1986-89	18-3071	—	18-3344	18-3170	18-3311	18-3310
PRO V150D (6N9)	1990	18-3071	—	18-3344	18-3170	18-3311	18-3310
PX150	1999	18-3071	18-3333	18-3345	18-3173	18-3396	18-3395
SX150	1999-04	18-3071	18-3333	18-3345	18-3173	18-3396	18-3395
V150	2000-08	18-3071	18-3333	18-3345	18-3173	18-3396	18-3395
VZ150	2001-09	18-3071	18-3333	18-3345	18-3173	18-3396	18-3395
Z150/LZ150	2001-05	18-3071	18-3333	18-3345	18-3173	18-3396	18-3395
175 (6G5)	1984-91	18-3071	—	18-3344	18-3170	18-3311	18-3310
175 (6R3)	1992-00	18-3071	18-3333	18-3345	18-3173	18-3396	18-3395
P175 (62H)	1994-99	18-3071	18-3333	18-3345	18-3173	18-3396	18-3395
VZ175	2001-09	18-3071	18-3333	18-3345	18-3173	18-3396	18-3395
Z175	2001-05	18-3071	18-3333	18-3345	18-3173	18-3396	18-3395
200 (6G6), (6R4)	1984-91	18-3071	—	18-3344	18-3170	18-3311	18-3310
200 (6R4)	1992-99	18-3071	18-3333	18-3345	18-3173	18-3396	18-3395
L200 (6K1), (6R1)	1986-91	18-3071	—	18-3344	18-3170	18-3311	18-3310
L200	1992-99	18-3071	18-3333	18-3345	18-3173	18-3396	18-3395
LX200	1999-02	18-3071	18-3333	18-3345	18-3173	18-3396	18-3395
P200	1991-99	18-3071	18-3333	18-3345	18-3173	18-3396	18-3395
SX200	1999-05	18-3071	18-3333	18-3345	18-3173	18-3396	18-3395
V200	1998-99	18-3071	18-3333	18-3345	18-3173	18-3396	18-3395
VZ200	2001-04	18-3071	18-3333	18-3345	18-3173	18-3396	18-3395
VZ200	2005-09	18-3071	18-3519	18-3520	18-3173	—	18-3516
Z200/LZ200	2000-10	18-3071	18-3333	18-3345	18-3173	18-3396	18-3395
V6 Special (6G7)	1984-86	18-3071	—	18-3344	18-3170	18-3311	18-3310
V6 Excel (6K7)	1987-89	18-3071	—	18-3344	18-3170	18-3311	18-3310
225 (6R5)	1990-91	18-3071	—	18-3344	18-3170	18-3311	18-3310
225	① 1992-97	18-3071	18-3333	18-3345	18-3173	18-3396	18-3395
225/L225/S225	② 1994-99	18-3071	18-3333	18-3345	18-3173	18-3396	18-3395
LX225/SX225	2000-03	18-3071	18-3333	18-3345	18-3173	18-3396	18-3395
V225	1998-99	18-3071	18-3333	18-3345	18-3173	18-3396	18-3395
VX225	2000-04	18-3071	18-3333	18-3345	18-3173	18-3396	18-3395
VZ225	2003-09	18-3071	18-3519	18-3520	18-3173	—	18-3516
250/L250	1990-96	18-3071	18-3333	18-3345	18-3173	18-3396	18-3395
L250/S250	1997-99	18-3071	18-3333	18-3345	18-3173	18-3396	18-3395
VX250	2002-04	18-3071	18-3333	18-3345	18-3173	18-3396	18-3395
VZ250	2003-09	18-3071	18-3519	18-3520	18-3173	—	18-3516
Z300	2006	18-3071	18-3519	—	18-3173	—	18-3515
LZ300	2006	18-3071	18-3519	—	18-3173	—	18-3515
VZ300	2004-09	18-3071	18-3519	18-3520	18-3173	—	18-3516

① 2.6L engine ② 3.1L engine * models with 20" shaft ** excludes 4.2L

60°C



**18-3625
THERMOSTAT**
(Seal Included)

Yamaha 6F5-12411-03-00
9.9EL, 9.9ES, 15EL, 15ES (1986-1995), 9.9L, 9.9S, 15L, 15S (1986-1990), 9.9M, 15ML, 15MS, C55EL (1991-1995), C25EL, C40EL (1991-1997), C25ML (1993-1997), C25MS, C40MS, C40PL (1992-1997), C30EL (1991-1992), CV30EL (1989-1990), C40ML (1994-1995), C55TL (1993-1995), CV25EL, CV25EM, CV40EL (1990), CV55EL (1989)

50°C



**18-3623
THERMOSTAT**
(Seal Included)

Yamaha 6E5-12411-02-00
8MSH-0405, 8MSH-0406, 8MSH-0407, 8MSH-0608, 8MSHD-2005

50°C



**18-3540
THERMOSTAT**

Replaces:
6E5-12411-30-00
Fits: 9.9-15 (1996-06), 20 (1996-97), 25 (1988-95), 30 3-cyl (1987-91), 40 (1986-05), C40 3-cyl (1998-02), 50 (1986-05), C50 (1998-01), P50 (1987-96), 115 (1984-05), B115 (1998-99), C115 (1991-00), P115 (1993-96), S115/S130 (1996-98), 130/L130 (1988-05), 150/175/200 (1986-05), C150 (1996-99), D150/DX150 (1997-05), L150/L200 (1986-99), LX150/LX200 (1999-01), P150 (1986-99), PX150 (1999), SX150/SX200 (1999-04), V150 (2000-05), VX150 (2000-05), VZ150/VZ175/VZ200 (2001-05), Z150/Z175/Z200 (2000-05), P200 (1991-93), V200/V225 (1998-99), VX200/VX225 (2000-05), V6 Special (1984-86), V6 Excel (1987-89), 225 2.6L (1990-97), 250/L250 2.6L (1990-95)

50°C



**18-3541
THERMOSTAT**

Replaces: 66M-12411-01-00
Fits: F6 (2001-05), F8 (2001-05), T8 (2001-05), F9.9 (1985-05), T9.9 (1985-05), T9.9 (1991-05), F15 (1998-05), F25 (1998-05), T25 (2001-05), F30 (2001-05), F40 4cyl (1999), F40 3cyl (2000-05), F50 (1995-05), T50 (1996-05), F60 (2002-05), T60 (2003-05), F80 (1999-00), F100 (1999-00)

50°C



**18-3622
THERMOSTAT KIT**

Yamaha 6H3-12411-11-00
60TLR-0405, 70TLR-0405, 70TLR-0406, 70TLR-0407, 70TLR-0408



**18-3624
THERMOSTAT KIT**

Yamaha 69M-12411-01-00
F2.5MSH-0405, F2.5MSH-0406, F2.5MSH-0407, F2.5MSH0608, F2.5MSHD-2005

① 18-3608D



**18-3608
THERMOSTAT KIT**

Fits: 115 (1991-02), C115 (1991-99), P115 (1993-96), S115 (1996-99), 130 (1991-02), L130 (1991-00), S130 (1996-99), 150 (1991-02), C150 (1996-99), L150 (1991-99), P150 (1991-99), S150 (1996-99), V150 (2000-02), Z150 (2001-02), 175 (1991-95, 97), P175 (1994-99), V175 (2000), Z175 (2001-02), 200 (1991-98), L200 (1991-99), P200 (1991-99), S200 (1996-99), V200 (1998-99), Z200 (2001-02), 225 (1991-97), V225 (1998-99)

① 18-3609D



**18-3609
THERMOSTAT KIT**

Fits: 25 (1996-98, 2001-02), 40 (1991-99, 01), C40 (1997-02), P40 (1998), 50 (1991-97, 1999-02), C50 (1998-01), P50 (1991-96), L225 (1994-99), S225 (1996-99), 250 (1991-95), L250 (1991-99), S250 (1996-99)

— CONTAINS —

— CONTAINS —			
Part #	Desc.	O.E. #	Qty.
18-3540	Thermostat	6E5-12411-30-00	1
18-0844	Gasket	688-12414-A1-00	1

— CONTAINS —			
Part #	Desc.	O.E. #	Qty.
18-3540	Thermostat	6E5-12411-30-00	1
18-0829	Gasket	61A-12414-A0-00, 6J8-12414-A0-00	1



**18-3611
THERMOSTAT KIT**

Fits: 15 (2006), F15 (1998-06), F25 (1999-06), F30 (2001-06), F40 (1999-06), F50 (1999-06), F60 (2002-06), F9.9 (2005-06), T25 (2001-06), T50 (1996-06), T60 (2003-06), T9.9 (2005-06)

① Items ending in "D" are Display Packaged - Regular number is Non-Display

THERMOSTAT APPLICATION

HP\Model	Year	Thermostat	Gasket	Thermostat Kit	HP\Model	Year	Thermostat	Gasket	Thermostat Kit
F2.5	2003-11	Kit Only	18-0754	18-3624	E75	1995-00	—	18-0844	—
4	1986-88	18-3540	—	—	P75	1996-99	—	18-0844	—
4	1989-99	18-3623	—	—	C80	1997	—	18-0844	—
F4	1999-11	18-3541	18-0754	—	F80	1999-00	18-3541	—	—
5	1995-02	18-3623	—	—	90	1984-09	—	18-0844	—
6	1986-88	18-3540	—	—	90 Jet	1986-00	—	18-0844	—
6	1989-00	18-3623	—	—	B90	1997-99	—	18-0844	—
F6	2001-04	18-3541	—	—	C90	1997-01	—	18-0844	—
F6	2005-08	18-3541	—	—	F100	1999-00	18-3541	—	—
F6	2009-11	18-3541	18-0754	—	115	1984-09	18-3540	18-0844	18-3608
8	1986-88	18-3540	—	—	B115	1998-99	18-3540	18-0844	18-3608
8	1989-09	18-3623	—	—	C115	1991-00	18-3540	18-0844	18-3608
F8	2001-04	18-3541	—	—	P115	1993-96	18-3540	18-0844	18-3608
F8	2005-11	18-3541	—	—	S115	1996-99	18-3540	18-0844	18-3608
T8	2001-04	18-3541	—	—	130	1988-04	18-3540	18-0844	18-3608
T8	2005-10	18-3541	—	—	L130	1989-01	18-3540	18-0844	18-3608
9.9	1986-95	18-3625	18-0836	—	S130	1996-99	18-3540	18-0844	18-3608
9.9	1996-09	18-3540	18-0836	—	C150	1996-99	18-3540	18-0844	18-3608
F9.9	1985-11	18-3541	—	—	150	1984	—	18-0844	—
FT9.9	1985-90	18-3541	—	—	150	1985	18-3623	18-0844	—
T9.9	1991-04, 2007-11	18-3541	—	—	150	1986-09	18-3540	18-0844	18-3608
T9.9	2005-06	18-3541	18-0835	18-3611	D150	1997-99	18-3540	18-0844	18-3608
15	1984-85	—	18-0836	—	DX150	1999-05	18-3540	18-0844	18-3608
15	1986-95	18-3625	18-0836	—	L150	1986-99	18-3540	18-0844	18-3608
15	1996-09	18-3540	18-0836	—	LX150	1999-01	18-3540	18-0844	18-3608
F15	1998-06	18-3541	18-0835	18-3611	LZ150	2000-05	18-3540	18-0844	18-3608
20	1996-97	18-3540	18-0829	18-3609	Z150	2000-05	18-3540	18-0844	18-3608
25 (2 cyl)	1984-87	—	18-0232	—	P150	1991-99	18-3540	18-0844	18-3608
25 (2 cyl)	1988-09	18-3540	18-0829	18-3609	PX150	1999	18-3540	18-0844	18-3608
C25	1991-97	18-3625	18-0232	—	PRO V150	1986-90	18-3540	18-0844	18-3608
CV25	1990	18-3625	18-0232	—	S150	1996-99	18-3540	18-0844	18-3608
F25	1998-11	18-3541	18-0835	18-3611	SX150	1999-04	18-3540	18-0844	18-3608
T25	2001-11	18-3541	18-0835	18-3611	V150	2000-08	18-3540	18-0844	18-3608
30	1984-85	—	18-0232	—	VX150	2000-04	18-3540	18-0844	18-3608
30	1986	18-3625	18-0835	—	VZ150	2000-11	18-3540	18-0844	18-3608
30	1987-88	18-3540	18-0829	18-3609	175	1984	—	18-0844	—
30	1989-91	18-3623	18-0829	—	175	1985	18-3623	18-0844	—
30	1992-02	—	18-0829	—	175	1986-00	18-3540	18-0844	18-3608
C30	1991-92	18-3625	18-0232	—	P175	1994-99	18-3540	18-0844	18-3608
C30	1993-94, 1996-97	18-3623	18-0232	—	S175	1996-99	18-3540	18-0844	18-3608
F30	2001-05	18-3541	18-0835	18-3611	V175	2000	18-3540	18-0844	18-3608
40	1984-85	—	18-0829	—	VZ175	2001-10	18-3540	18-0844	18-3608
40	1986-05	18-3540	18-0829	18-3609	Z175	2001-05	18-3540	18-0844	18-3608
C40	1991-97	18-3625	—	—	200	1984	—	18-0844	—
C40	1998-03	18-3540	18-0829	18-3609	200	1985	18-3623	18-0844	—
F40	1999-11	18-3541	18-0835	18-3611	200	1986-98	18-3540	18-0844	18-3608
F40 2.6L	1999	18-3541	18-0835	18-3611	L200	1986-99	18-3540	18-0844	18-3608
P40	1998	18-3540	18-0829	18-3609	LX200	1999-01	18-3540	18-0844	18-3608
50	1984-85	—	18-0829	—	LZ200	2000-11	18-3540	18-0844	18-3608
50	1986-09	18-3540	18-0829	18-3609	P200	1991-99	18-3540	18-0844	18-3608
C50	1998-01	18-3540	18-0829	18-3609	SX200	1999-05	18-3540	18-0844	18-3608
F50	1995-11	18-3541	18-0835	18-3611	V200	1998-99	18-3540	18-0829	18-3609
PRO 50	1987-90	18-3540	18-0829	18-3609	VX200	2000-05	18-3540	18-0829	18-3609
P50	1991-96	18-3540	18-0829	18-3609	VZ200	2001-04	18-3540	18-0844	18-3608
50 Jet	1986-00	18-3540	18-0829	18-3609	Z200	2000-11	18-3540	18-0844	18-3608
T50	1996-11	18-3541	18-0835	18-3611	V6 Special	1985-86	18-3540	18-0844	18-3608
C55	1991-95	18-3625	—	—	V6 Excel	1987-89	18-3540	18-0844	18-3608
CV55	1989-90	18-3625	—	—	225	1990-97	18-3540	18-0844	18-3608
60	2001-05	Kit Only	18-0835	18-3622	L225	1994-99	18-3540	18-0829	18-3609
C60	1996-01	Kit Only	18-0835	18-3622	S225	1996-99	18-3540	18-0829	18-3609
E60	1995-00	Kit Only	18-0835	18-3622	LX225	2000-03	18-3540	18-0829	18-3609
F60	2002-11	18-3541	18-0835	18-3611	SX225	2000-03	18-3540	18-0829	18-3609
P60	1991-99	Kit Only	18-0835	18-3622	V225	1998-99	18-3540	18-0829	18-3609
T60	2003-11	18-3541	18-0835	18-3611	VX225	2000-04	18-3540	18-0829	18-3609
70	1984-09	Kit Only	18-0835	18-3622	250	1990-95	18-3540	18-0829	18-3609
C70	2000-01	Kit Only	18-0835	18-3622	L250	1990-99	18-3540	18-0829	18-3609
F70	2010	18-3541	18-0835	18-3611	LX250	2000-03	18-3540	18-0829	18-3609
C75	1994-99	—	18-0844	—	S250	1996-99	18-3540	18-0829	18-3609
					SX250	2000-03	18-3540	18-0829	18-3609
					VX250	2002-04	18-3540	18-0829	18-3609

**ALL PISTONS
ARE SUPPLIED WITH PISTON RINGS, WRIST PIN AND CIRCLIPS**

Piston Rings are available individually



V-4 & V-6 Pistons and Rings

STANDARD			.25mm O.S.			.50mm O.S.		
18-4128 (Port) Replaces: 6G5-11642-00-93	18-4129 (Stbd.) Replaces: 6G5-11631-00-93		18-4130 (Port)	18-4131 (Stbd.)		18-4132 (Port) Replaces: 6G5-11646-01-00	18-4133 (Stbd.) Replaces: 6G5-11636-01-00	
— CONTAINS —						— CONTAINS —		
Part #	Rings	O.E. #				Part #	Rings	O.E. #
18-3934	Standard	6E5-11610-03-00				18-3936	Standard	6E5-11610-23-00

V-6 Loop Charged Engines (1992-2001)

18-4080 (Port) Replaces: 6R5-11642-11-93	18-4081 (Stbd.) Replaces: 6R5-11631-11-93		18-4082 (Port) Replaces: 6R5-11645-11-00	18-4083 (Stbd.) Replaces: 6R5-11635-11-00		18-4084 (Port) Replaces: 6R5-11646-11-00	18-4085 (Stbd.) Replaces: 6R5-11636-11-00	
— CONTAINS —								
Part #	Rings	O.E. #						
18-39320	Standard	6R5-11603-00						

★ ★ Inline Pistons and Rings ★ ★

STANDARD			.25mm O.S.			.50mm O.S.		
18-4091 Replaces: 6H3-11631-01-96 — CONTAINS —			18-4136 Replaces: 6E7-11635-00-00 — CONTAINS —			18-4093 Replaces: 6H3-11636-01-00		
Part #	Rings	O.E. #	Part #	Rings	O.E. #	18-4146 Replaces: 61N-11636-00-00		
18-3963	Standard	6K5-11601-02-00	18-3977	25mm O.S.	682-11610-11-00	18-4143 Replaces: 6H4-11636-00-00 — CONTAINS —		
18-4135 Replaces: 6E7-11631-00-97 — CONTAINS —			18-4145 Replaces: 61N-11635-00-00			Part #	Rings	O.E. #
Part #	Rings	O.E. #				18-3962	50mm O.S.	6H4-11610-20-00
18-3976	Standard	682-11610-01-00	18-4142 Replaces: 6H4-11635-01-00 — CONTAINS —			18-4099 Replaces: 6H1-11636-03-00		
18-4138 Replaces: 689-11631-00-95 — CONTAINS —			Part #	Rings	O.E. #			
Part #	Rings	O.E. #	18-3961	25mm O.S.	6H4-11610-10-00			
18-3954	Standard	689-11610-01-00	18-3970	25mm O.S.	688-11604-00-00			
18-4144 Replaces: 61N-11631-00-95								
18-4141 Replaces: 6H4-11631-00-96 — CONTAINS —								
Part #	Rings	O.E. #						
18-3960	Standard	6H4-11610-00-00						
18-4097 Replaces: 6H1-11631-03-95 — CONTAINS —								
Part #	Rings	O.E. #						
18-3969	Standard	688-11603-A0-00						

PISTON APPLICATION

HP/Model	Years	PISTON			RINGS		
		Std.	.25mm	.50mm	Std.	.25mm	.50mm
9.9/15	1984-96	18-4135	—	18-4137	18-3976	—	18-3978
9.9/15	1997-2009	18-4135	18-4136	18-4137	18-3976	18-3977	18-3978
25	1985	18-4138	—	—	18-3954	—	—
30	1984-86	18-4138	—	—	18-3954	—	—
C30	1991-92	18-4138	—	—	18-3954	—	—
C30	1993-97	18-4144	18-4145	18-4146	—	—	—
40	1984-88	18-4141	—	18-4143	18-3960	—	18-3962
C40	1997-99,2001-02	—	18-4142	18-4143	18-3960	18-3961	—
P40	1998	—	—	18-4143	18-3960	18-3961	—
E48	1997	18-4097	—	18-4099	18-3969	18-3970	—
50	1984-88	18-4141	—	18-4143	18-3960	—	18-3962
50	1996-97, 1999, 2000,2002-03	18-4141	18-4142	18-4143	18-3960	18-3961	—
C50	1998-99, 2001	—	18-4142	18-4143	18-3960	18-3961	—
P50	1996	—	18-4142	18-4143	18-3960	18-3961	—
Pro50	1987-88	18-4141	—	18-4143	18-3960	—	—
60	2001-05	18-4091	—	18-4093	18-3963	—	—
C60	1996-01	18-4091	—	18-4093	18-3963	—	—
E60 MLH,T,U,V	1995-00	—	—	18-4096	18-3963	—	—
P60	1991-99	18-4091	—	18-4093	18-3963	—	—
70	1984-09	18-4091	—	18-4093	18-3963	—	—
C70	2000-01	18-4091	—	18-4093	18-3963	—	—
75	1994-98	18-4097	—	18-4099	18-3969	—	—
C75	1996	18-4097	—	18-4099	18-3969	—	—

APPLICATION CONTINUED ON NEXT PAGE



PISTON APPLICATION (Cont.)

HP/Model	Years	PISTON			RINGS		
		Std.	.25mm	.50mm	Std.	.25mm	.50mm
C75	1998-99	18-4097	—	18-4099	18-3969	—	—
E75	1996-97	18-4097	—	18-4099	18-3969	—	—
P75	1996-99	18-4097	—	18-4099	18-3969	—	—
C80	1997	18-4097	—	18-4099	18-3969	—	—
C85	1996	18-4097	—	18-4099	18-3969	—	—
90	1994-09	18-4097	—	18-4099	18-3969	—	—
C90	1997-01	18-4097	—	18-4099	18-3969	—	—

V4 & V-6 Engines	Years	PISTON						RINGS	
		Port Std.	Stbd. Std.	Port .25mm	Stbd. .25mm	Port .50mm	Stbd. .50mm	Std.	
115 w/22mm wrist pin	V-4	1984-86	18-4128	18-4129	18-4130	18-4131	18-4132	18-4133	18-3934
115 w/22mm wrist pin	V-4	1987-92	18-4128	18-4129	18-4130	18-4131	18-4132	18-4133	18-3934
115 w/23mm wrist pin	V-4	1993-03	18-4080	18-4081	18-4082	18-4083	18-4084	18-4085	18-39320
130 w/22mm wrist pin	V-4	1984-92	18-4128	18-4129	18-4130	18-4131	18-4132	18-4133	18-3934
130 w/23mm wrist pin	V-4	1993-03	18-4080	18-4081	18-4082	18-4083	18-4084	18-4085	18-39320
150, 175 w/22mm wrist pin	V-6	1984-92	18-4128	18-4129	18-4130	18-4131	18-4132	18-4133	18-3934
150, 175 w/23mm wrist pin	V-6	1993-99	18-4080	18-4081	18-4082	18-4083	18-4084	18-4085	18-39320
200, 225 w/22mm wrist pin	V-6	1984-92	18-4128	18-4129	18-4130	18-4131	18-4132	18-4133	18-3934
200, 225 w/22mm wrist pin	V-6	1993-99	18-4080	18-4081	18-4082	18-4083	18-4084	18-4085	18-39320
SPECIAL J,K,LN,XN (6G7)	V-6	1984-86	18-4128	18-4129	18-4130	18-4131	18-4132	18-4133	18-3934

 <p>18-1755 CONNECTING ROD Replaces: 650-11651-04-00 Fits: 9.9, 15 (1996-97)</p>	 <p>18-1756 CONNECTING ROD Replaces: 688-11650-03-00 Fits: 55 (1991-95), 75 (1994-99), 80 (1997), 85 (1991-96), 90 (1997, 2000-01),</p>	 <p>18-1755K CONNECTING ROD KIT Replaces: 650-11651-04-00 Fits: E336 9.9 (1996-97), 15 (1996-97)</p>	 <p>18-4157 CONNECTING ROD Replaces: 6R5-11650-10-00 For: V6 150/175/200 (1992-03)</p>	 <p>18-1410 ROD BEARING Replaces: 93310-32337-00 Fits: 115 (1993-03), 130 (1993-00, 2002-03), 150 (1992-00, 2002-03), 175 (1992-98, 2000), 200 (1992-98), 225 (1992-93, 1997)</p>
--	---	--	--	---

 <p>18-1411 ROD BEARING Replaces: 93310-620V5-00 Fits: 9.9 (1996-97), 15 (1996-97)</p>	 <p>18-4077 ROD BEARING Replaces: 93310-730V8-00 For: 45, 55, 90 HP -3 Cyl.</p>	 <p>18-4078 ROD BEARING Replaces: 93310-836V2-00 For: V4 & V6 (1990 motors)</p>	 <p>18-0191 WASHERS Replaces: 92990-06600-00</p> <p>18-0192 Replaces: 92990-10600-00, 929-90106-00-00, 92900-10600-00, 92901-10600-00, 92902-10600-00, 92903-10600-00, 92995-10600-00</p>	 <p>18-79974 OIL STRAINER Replaces: 6J8-13411-00 Fits: 20(1996-97), 25(1988-01), 30(1987-02), 40(1989-05), 50(1989-09), 60(2001-05), 70(1989-09), C30(1995), P40(1998), P50(1991-96), P60(1991-99), PRO50(1989-90)</p>
--	---	---	--	--

 <p>18-79975 OIL STRAINER Replaces: 6E5-13411-00 Fits: 115(1988-09), 130(1988-05), 150(1989-09), 175(1989-00), 200(1989-98), 225(1990-97), B115(1988-99), D150(1997-99), DX150(1999-05), L130(1989-01), L150(1988-99), L200(1988-99), LX150(1999-01), LX200(1999-01), LZ150(2000-05), LZ200(1999-12), P115(1993-96), P150(1991-99), P175(1994-99), P200(1991-99), PRO V150(1988-90), PX150(1999), S115(1996-99), S130(1996-99), S150(1996-99), S200(1996-99), SX150(1999-04), SX200(1999-05), V150(2000-08), V175(2000), V6 Excel(1988-89), VX150(2000-04), VZ150(2000-12), VZ175(2001-12), VZ200(2001-04), Z150(2000-05), Z175(2001-05), Z200(2000-12)</p>	 <p>18-79976 OIL STRAINER Replaces: 61A-13411-00 Fits: 225(1994-95), 250(1990-95), L225(1994-99), L250(1990-99), LX225(2000-03), LX250(2000-03), LZ250(2003-05), LZ300(2004-06), S25(1996-99), S250(1996-99), SX2250(2000-03), SX250(2000-03), V200(1998-99), V225(1998-99), VX200(2000-05), VX225(2000-04), VX250(2002-04), VZ200(2005-09), VZ225(2003-09), VZ250(2003-09), VZ300(2004-09), Z250(2003-05), Z300(2004-06)</p>
---	---

 <p>18-79971 OIL STRAINER, ELECTRIC Replaces: 68F-13440-00 Fits: LZ150(2000-05), LZ200(2000-12), LZ250(2003-05), LZ300(2004-06), VZ150(2000-12), VZ175(2001-12), VZ175(2001-12), VZ200(2001-09), VZ225(2003-09), VZ250(2003-09), VZ300(2004-09), Z150(2000-05), Z175(2001-05), Z200(2000-12), Z250(2003-05), Z300(2004-06)</p>	 <p>18-7911-1 OIL FILTER Replaces: 5GH-13440-00, 5GH-13440-10</p>	 <p>18-7954 OIL FILTER Replaces: N26-13440-00-00 Fits: F350</p>	 <p>18-8700 OIL FILTER Replaces: 5GH-13440-20 Fits: F15(2006-12), F20(2006-12), F25(2009-12), F40(2008-12), F50(2005-12), F60(2005-12), F70(2010-12), T25(2009-12), T50(2005-12), T60(2005-12)</p>
--	---	--	--



4 CYCLE OUTBOARD OIL FILTERS

Make-Model	Years	Replaces:	Part No
F/T9.9	1990-03	6G8-13440-00-00	18-7901
F/T50	1995-99	3FV-13440-00-00	18-7902
F15,F25	1998-99	3FV-13440-00-00	18-7902
F80/F100	1999	3FV-13440-00-00	18-7902
F40	1999-00	3FV-13440-00-00	18-7902
F200/F225	2002-06	69J-13440-00-00	18-7906-1
F150	2004-06	69J-13440-00-00	18-7906-1
F250	2005-06	69J-13440-00-00	18-7906-1
F350	2008-up	N26-13440-00-00	18-7954

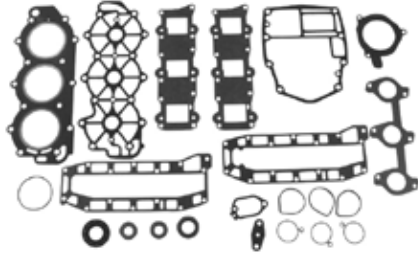

**18-99061
GASKET SET**
Replaces: 63D-W0001-00
Fits: 40(1995-05), 50(1995-06), C40(1997-02), C50(1998-01), P40(1998), P50(1995-96)



**18-99073
GASKET SET**
Replaces: 65W-W0001-20
Fits: F25(1998-00)

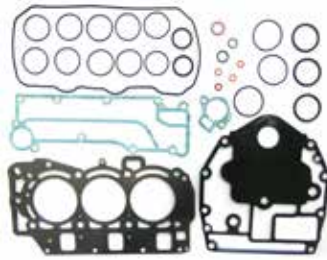

**18-99092
GASKET SET**
Replaces: 67C-W0001-00
Fits: F30(2001), F40(2000-01)

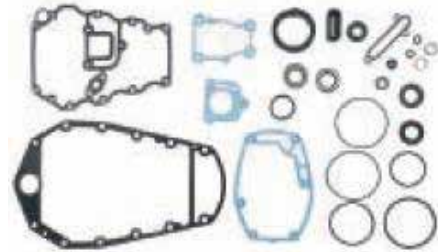

**18-99093
GASKET SET**
Replaces: 67C-W0001-20
Fits: F30(2001), F40(2000-01), T25(2001)

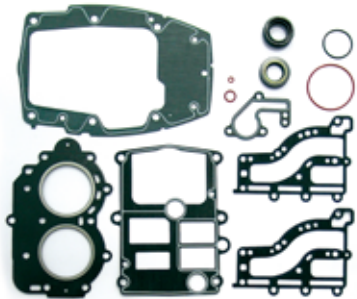

**18-99097
GASKET SET**
Replaces: 682-W0001-06
Fits: 9.9(1994-95), 15(1994-95)

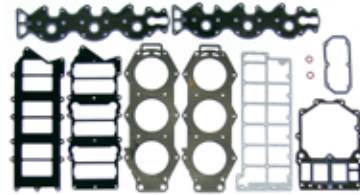

**18-99103
GASKET SET**
Replaces: 68F-W0001-01
Fits: LZ150(2004-05), LZ200(2004-10), VZ150(2004-10), VZ175(2004-10), VZ200(2004), Z150(2004-05), Z175(2004-05), Z200(2004-10)



**18-99104
GASKET SET**
Replaces: 6A0-W0001-21
Fits: C40(1992-94)

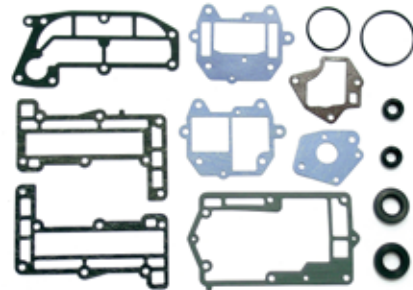

**18-99117
GASKET SET**
Replaces: 6G1-W0001-A2
Fits: 6(1996), 8(1996)

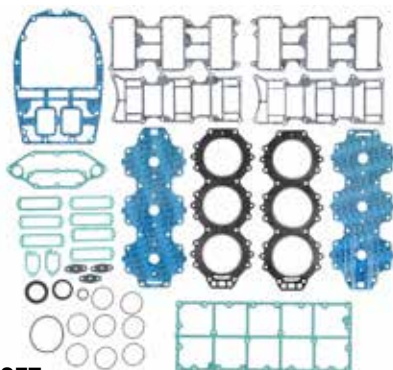

**18-4400
POWERHEAD GASKET SET**
Replaces: 61A-W0001-01-00, 61A-W0001-A1-00
— CONTAINS—

Part #	Desc.	O.E. #	Qty.
18-3891	Head Gasket	61A-11181-00-A0	2
18-7443	O-Ring	93210-81MA6-00	1

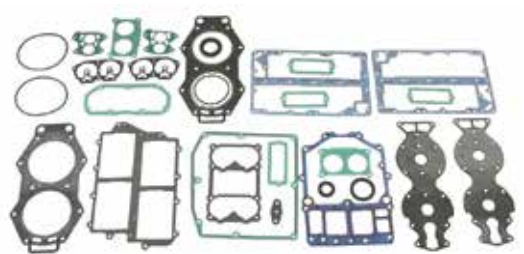

**18-4403
POWERHEAD GASKET SET**
Replaces: 6F3-W0001-04-00, 6F3-W0001-A4-00
— CONTAINS—

Part #	Desc.	O.E. #	Qty.
18-3832	Head Gasket	6E5-11181-02-00	2
18-0844	Thermostat Cover Gasket	688-12414-A1-00	2
18-2079	Oil Seal	93101-22M15-00	1
18-2085	Oil Seal	93102-35M13-00	1
18-7442	O-Ring	93210-74M35-00	1
18-7444	O-Ring	93211-04384-00	2

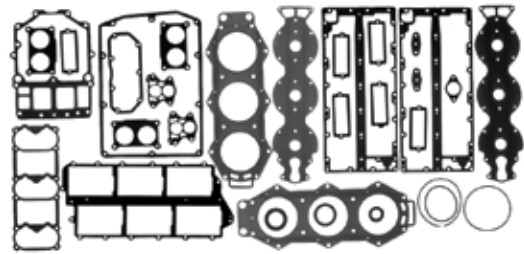

**18-4404
POWERHEAD GASKET SET**
Replaces: 6G5-W0001-03-00, 6G5-W0001-A3-00
— CONTAINS—

Part #	Desc.	O.E. #	Qty.
18-3894	Head Gasket	6G5-11181-A0-00	2
18-0844	Thermostat Cover Gasket	688-12414-A1-00	2
18-2079	Oil Seal	93101-22M15-00	1
18-2085	Oil Seal	93102-35M13-00	1
18-7442	O-Ring	93210-74M35-00	1
18-7444	O-Ring	93211-04384-00	2

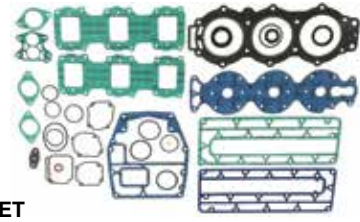

**18-4405
POWERHEAD GASKET SET**
Replaces: 6H1-W0001-00-00, 6H1-W0001-01-00, 6H1-W0001-A0-00
— CONTAINS—

Part #	Desc.	O.E. #	Qty.
18-3805	Head Gasket	688-11181-02-00	1
18-0840	O-Ring	676-14984-00-00	3
18-0844	Thermostat Cover Gasket	688-12414-A1-00	1
18-0845	Intake Manifold Reed Plate Gasket	688-13621-A1-00	2
18-0846	Carburetor Mounting Gasket	688-14198-A1-00	3
18-0847	Exhaust Cover Gasket	688-41112-A0-00	1
18-0826	Drain Screw Gasket	90430-14115-00	1
18-7434	O-Ring	93210-39ME4-00	3
18-7436	O-Ring	93210-46044-00	3
18-7441	O-Ring	93210-62269-00	1
18-0767	Water Jacket Cover Gasket	688-11193-01-00	1

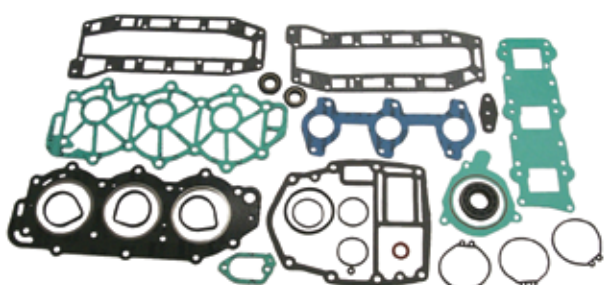

**18-4407
POWERHEAD GASKET SET**
Replaces: 6H4-W0001-01-00, 6H4-W0001-A1-00
— CONTAINS—

Part #	Desc.	O.E. #	Qty.
18-3830	Head Gasket	6H4-11181-00-00	1
18-0826	Drain Screw Gasket	90430-14115-00	1

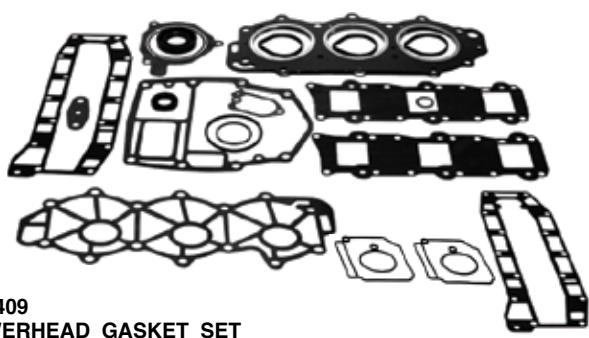

**18-4409
POWERHEAD GASKET SET**
Replaces: 6H4-W0001-03-00, 6H4-W0001-04-00
— CONTAINS—

Part #	Desc.	O.E.#	Qty.
18-3830	Head Gasket	6H4-11181-00-00	1
18-0826	Drain Screw Gasket	90430-14115-00	1
18-7432	O-Ring	93210-32768-00	1

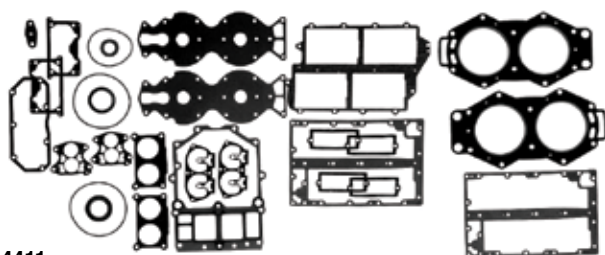

**18-4411
POWERHEAD GASKET SET**
Replaces: 6N6-W0001-03-00, 6N6-W0001-A3-00
— CONTAINS—

Part #	Desc.	O.E. #	Qty.
18-3832	Head Gasket	6E5-11181-02-00	2
18-0844	Thermostat Cover Gasket	688-12414-A1-00	2
18-2079	Oil Seal	93101-22M18-00	1
18-2085	Oil Seal	93102-35M13-00	1
18-7442	O-Ring	93210-74M35-00	1
18-7444	O-Ring	93211-04384-00	2

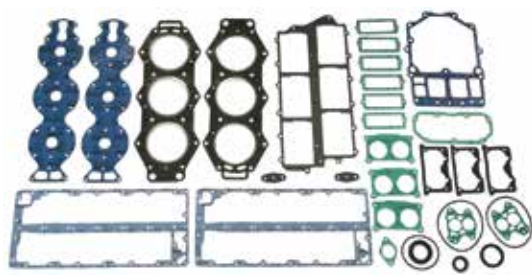

**18-4412
POWERHEAD GASKET SET**
Replaces: 6R3-W0001-03-00, 6R3-W0001-A3-00
— CONTAINS—

Part #	Desc.	O.E. #	Qty.
18-3894	Head Gasket	6G5-11181-A0-00	2
18-0844	Thermostat Cover Gasket	688-12414-A1-00	2
18-2079	Oil Seal	93101-22M18-00	1
18-2085	Oil Seal	93102-35M13-00	1
18-7442	O-Ring	93210-74M35-00	1
18-7444	O-Ring	93211-04384-00	2

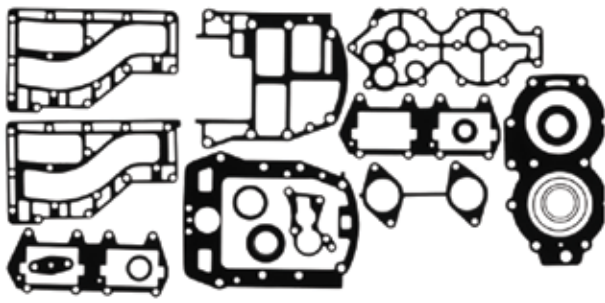

18-4413
POWERHEAD GASKET SET
 Replaces: 6R6-W0001-01-00

— CONTAINS —

Part #	Desc.	O.E. #	Qty.
18-3892	Head Gasket	676-11181-00-A0	1
18-7441	O-Ring	93210-62269-00	1

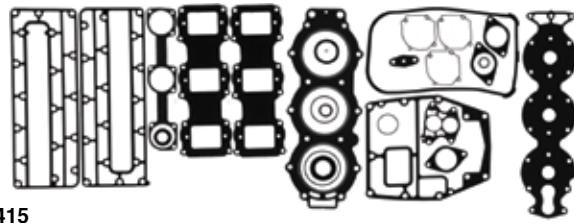

18-4415
POWERHEAD GASKET SET
 Replaces: 688-W0001-00-00, 688-W0001-A0-00

— CONTAINS —

18-0840	Fuel Bowl Seal	676-14984-00-00	3
18-3805	Head Gasket	688-11181-02-00	1
18-0844	Thermostat Cover Gasket	688-12414-A1-00	1
18-0846	Carburetor Mounting Gasket	688-14198-A1-00	3
18-0847	Exhaust Cover Gasket	688-41112-A0-00	2
18-0826	Drain Screw Gasket	90430-14115-00-00	1
18-0767	Water Jacket Cover Gasket	688-11193-01-00	1
18-0845	Intake Manifold Reed Plate Gasket	688-13621-A1-00	2
18-7441	O-Ring	93210-62269-00	1

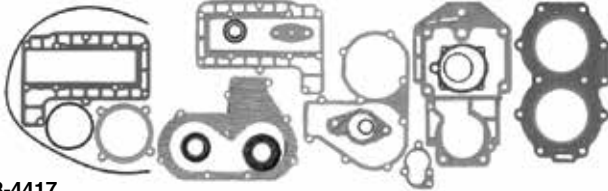

18-4417
POWERHEAD GASKET SET
 Replaces: 695-W0001-01-00, 695-W0001-02-00, 695-W0001-A2-00

— CONTAINS —

Part #	Desc.	O.E. #	Qty.
18-0231	Packing Gasket	648-13621-A1-00	1
18-0771	Intake Manifold Gasket	648-13645-A0-00	1
18-0775	Carburetor Mounting Gasket	648-14198-A0-00	1
18-0769	Bowl Gasket	648-14384-01-00	1
18-0232	Cover Gasket	655-12414-A1-00	1
18-0250	Exhaust Cover Gasket	664-41114-A0-00	2
18-2078	Oil Seal	93101-16M36-00	1
18-0570	Oil Seal	93102-23096-00	1
18-3849	Head Gasket	695-11181-A0-00	1
18-0739	Upper Casing Gasket	689-45113-A1-00	1

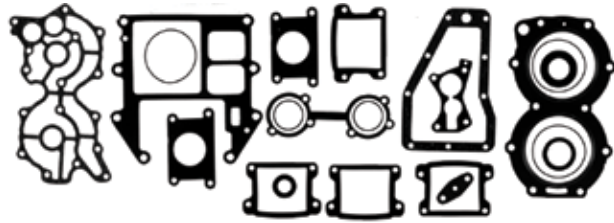

18-4418
POWERHEAD GASKET SET
 Replaces: 697-W0001-00-00, 697-E0001-A0-00

— CONTAINS —

Part #	Desc.	O.E. #	Qty.
18-0241	Valve Seat Gasket	663-13621-A0-00	2
18-0242	Valve Seat Gasket	663-13622-00-00	2
18-0246	Gasket	663-14483-A0-00	1
18-0247	Outer Cover Exhaust Gasket	663-41114-A0-00	1
18-3848	Head Gasket	695-11181-A0-00	1
18-7441	O-Ring	93210-62269-00-00	1

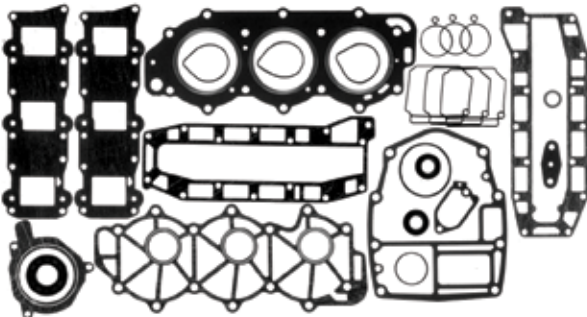

18-4419
POWERHEAD GASKET SET
 Replaces: 6H4-W0001-02-00, 6H4-W0001-A2-00

— CONTAINS —

Part #	Desc.	O.E. #	Qty.
18-3830	Head Gasket	6H4-11181-00-00	1
18-0826	Drain Screw Gasket	90430-14115-00-00	1

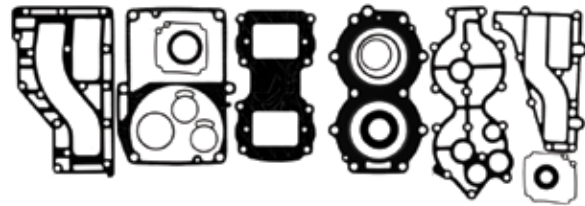

18-4422
POWERHEAD GASKET SET
 Replaces: 6L2-W0001-01-00, 6L2-W0001-02-00, 6L2-W0001-A2-00

— CONTAINS —

Part #	Desc.	O.E. #	Qty.
18-3847	Head Gasket	6L2-11181-A1-00	1
18-0765	Flat Chamber Gasket	6L2-14384-00-00	1
18-0743	Exhaust Inner Cover Gasket	6L2-41112-A1-00	1
18-0744	Exhaust Outer Cover Gasket	6L2-41114-A1-00	1
18-0748	Upper Casing Gasket	6L2-45113-A1-00	1

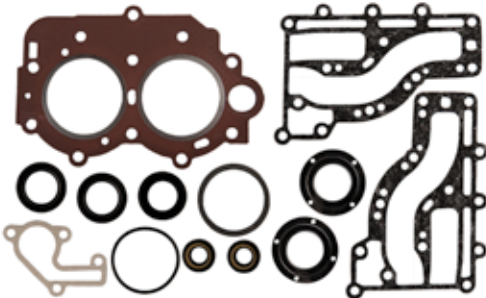

18-99175
POWERHEAD GASKET SET
 Replaces: 63V-W0001-00, 63V-W0001-01
 Fits: 9.9(1996-00), 15(1996-00)

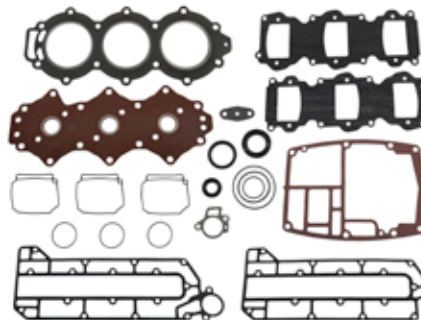

18-99176
POWERHEAD GASKET SET
 Replaces: 6H3-W0001-02
 Fits: 60(2001-05), 70(1994-09), C70(2000-01), P60(1994-99)



**18-4427
POWERHEAD GASKET SET**
Replaces: 6H3-W0001-A0-00



**18-0663
PLENUM GASKET KIT**
Fits: Yamaha F75 (2003-04), F80 (1999-03), F90 (2003-04), F100 (1999-02)



**18-99048
HEAD GASKET**
Replaces: 60V-11181-00
Fits: LZ250(2003-05), VZ200(2005-09), VZ225(2003-09), VZ250(2003-09), Z250(2003-05)



**18-99059
HEAD GASKET**
Yamaha 63D-11193-A0
Fits: 40(1995-05), 50(1995-09), C40(1997-03), C50(1998-01), P40(1998), P50(1995-96)

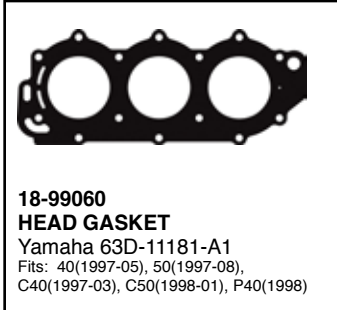

**18-99060
HEAD GASKET**
Yamaha 63D-11181-A1
Fits: 40(1997-05), 50(1997-08), C40(1997-03), C50(1998-01), P40(1998)



**18-99062
HEAD GASKET**
Yamaha 68F-11181-00
Fits: LZ150(2000-05), LZ200(2000-10), VZ150(2000-10), VZ175(2001-10), VZ200(2001-04), Z150(2000-05), Z175(2001-05), Z200(2000-10)

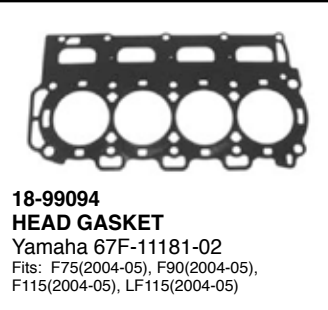

**18-99094
HEAD GASKET**
Yamaha 67F-11181-02
Fits: F75(2004-05), F90(2004-05), F115(2004-05), LF115(2004-05)



**18-3804
HEAD GASKET**
Replaces: 689-11181-02-00, 689-11181-A1-00



**18-3805
HEAD GASKET**
Replaces: 688-11181-02-00, 688-11181-A1-00



**18-3827
HEAD GASKET**
Replaces: 6G8-11181-00-00, 6G8-11181-A1-00



**18-3828
HEAD GASKET**
Replaces: 6E7-11181-00-00, 6E7-11181-A1-00



**18-3829
HEAD GASKET**
Replaces: 6J8-11181-00-00, 6J8-11181-A1-001



**18-3830
HEAD GASKET**
Replaces: 6H4-11181-00-00, 6H4-11181-A1-00



**18-3831
HEAD GASKET**
Replaces: 6H3-11181-01-00, 6H3-11181-A1-00



**18-3832
HEAD GASKET**
Replaces: 6E5-11181-02-00, 6E5-11181-A1-00

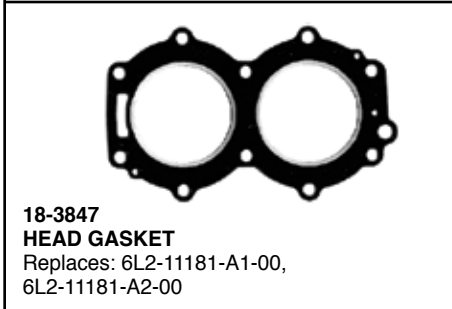

**18-3847
HEAD GASKET**
Replaces: 6L2-11181-A1-00, 6L2-11181-A2-00



**18-3848
HEAD GASKET**
Replaces: 697-11181-A0-00, 697-11181-A1-00



**18-3849
HEAD GASKET**
Replaces: 695-11181-A0-00, 695-11181-A1-00



**18-3891
HEAD GASKET**
Replaces: 61A-11181-A0-00, 61A-11181-A1-00



**18-3892
HEAD GASKET**
Replaces: 676-11181-A0-00, 676-11181-A1-00



**18-3894
HEAD GASKET**
Replaces: 6G5-11181-00-00, 6G5-11181-A0-00

SEE PAGES 166-167 FOR OUR COMPLETE LINE OF GASKET SEALANTS

APPLICATION BEGINS ON NEXT PAGE

















POWERHEAD GASKET SETS \ HEAD GASKETS APPLICATION

HP	Year	Powerhead Gasket Set	Head Gasket	HP	Year	Powerhead Gasket Set	Head Gasket
6	1988-96	18-99117		F80	1999-01		18-99094
8	1984-96	18-99117		F80	2002-03		18-99094
9.9	1984-87		18-3828	C85	1991	18-4415	18-3805
9.9	1988-91		18-3828	C85	1992-93		18-3805
9.9	1992-93		18-3828	C85	1994-96		18-3805
9.9	1994-95		18-3828	CV85	1989-90	18-4415	18-3805
9.9	1996	18-99175		90	1984-93	18-4405	18-3805
9.9	1997-00	18-99175	18-99140	90	1994-09		18-3805
9.9	2001-08		18-99140	B90	1997-99		18-3805
F9.9	1986-89		18-3827	C90	1997-01		18-3805
F9.9	1990-05		18-3827	F90	2003-04		18-99094
FT9.9	1985-87		18-3827	F90	2005-11		18-99094
FT9.9	1988-89		18-3827	F100	1999-01		18-99094
FT9.9	1990		18-3827	F100	2002-03		18-99094
T9.9	1991-05		18-3827	115	1984		18-3832
15	1984-87		18-3828	115	1985		18-3832
15	1988-91		18-3828	115	1986 ¹		18-3832
15	1992-93		18-3828	115	1986-89 ²	18-4403	18-3832
15	1994-95	18-99097		115	1990-99	18-4411	18-3832
15	1996	18-99175		115	2000-01		18-3832
15	1997-00	18-99175	18-99140	115	2002-09		18-3832
15	2001-08		18-99140	B115	1998-99		18-3832
20	1996-97		18-3847	C115	1991-95	18-4403	18-3832
25 (2 cyl)	1984-87		18-3804	C115	1996-99		18-3832
25 (2 cyl)	1988-93	18-4422	18-3847	C115	2000		18-3832
25 (2 cyl)	1994-09		18-3847	F115	2000-01		18-99094
25 (3 cyl)	1997-02		18-3829	F115	2002-05		18-99094
C25	1991-93	18-4417	18-3849	F115	2006-11		18-99094
C25	1994-97		18-3849	LF115	2000-01		18-99094
CV25	1990	18-4417	18-3849	LF115	2002-05		18-99094
F25	1998-01	18-99073		LF115	2006-11		18-99094
30	1984-86		18-3804	P115	1993-96	18-4411	18-3832
30	1987-94		18-3829	S115	1996-99	18-4411	18-3832
30	1993-02		18-3829	130	1988-99	18-4403	18-3832
C30	1991-92		18-3804	130	2000-01		18-3832
C30	1995-97		18-3829	130	2002-04		18-3832
CV30	1989-90		18-3804	L130	1989	18-4403	18-3832
F30	2000	18-99093		L130	1990-99	18-4411	18-3832
F30	2001-05	18-99092		L130	2000-01		18-3832
40	1984-88	18-4407	18-3830	S130	1996-99	18-4411	18-3832
40	1989-91	18-4419	18-3830	150	1984-89	18-4404	18-3894
40	1992-94	18-4409	18-3830	150	1990-95	18-4412	18-3894
40	1995-05	18-99061	18-99060	150	1996-03		18-3894
C40 2 Cyl	1991		18-3892	150	2004-09		18-3894
C40 2 Cyl	1992-93	18-4413	18-3892	C150	1996-99	18-4404	18-3894
C40 2 Cyl	1994-97	18-4414	18-3892	D150	1997-99		18-3894
C40 3 Cyl	1998-03	18-99061	18-99060	DX150	1999-03		18-3894
CV40	1990		18-3892	DX150	2004-05		18-3894
F40	2000-08	18-99092		L150	1986-89	18-4404	18-3894
P40	1998	18-99061	18-99060	L150	1990-95	18-4412	18-3894
50	1984-88	18-4407	18-3830	L150	1996-99		18-3894
50	1989-91	18-4419	18-3830	LX150	1999-01		18-3894
50	1992-94	18-4419	18-3830	LZ150	2000-03		18-99062
50	1995-09	18-99061	18-99060	LZ150	2004-05	18-99103	18-99062
C50	1998-01	18-99061	18-99060	Z150	2000-03		18-99062
PRO 50	1987-88	18-4407	18-3830	Z150	2004-05	18-99103	18-99062
PRO 50	1989-90	18-4419	18-3830	P150	1991-93	18-4412	18-3894
P50	1991	18-4419	18-3830	P150	1994-95	18-4410	18-3894
P50	1992-94	18-4409	18-3830	P150	1996-99		18-3894
P50	1995-96	18-99061	18-99060	PX150	1999		18-3894
C55	1991	18-4418	18-3848	PRO V150	1987-89	18-4404	18-3894
C55	1992-93		18-3848	PRO V150	1990	18-4412	18-3894
C55	1994-95		18-3848	S150	1996-99		18-3894
CV55	1989-90	18-4418	18-3848	SX150	1999-03		18-3894
60	2001-05	18-99176	18-3831	SX150	2004		18-3894
C60	1996-01		18-3831	V150	2000-03		18-3894
E60	1995-00		18-3831	V150	2004-08		18-3894
P60	1991	18-4427	18-3831	VX150	2000-03		18-3894
P60	1992-93		18-3831	VX150	2004		18-3894
P60	1994-99	18-99176	18-3831	VZ150	2000-03		18-99062
70	1984-91	18-4427	18-3831	VZ150	2004-11	18-99103	18-99062
70	1992-93		18-3831	175	1984-89	18-4404	18-3894
70	1994-09	18-99176	18-3831	175	1990-95	18-4412	18-3894
C70	2000-01	18-99176	18-3831	175	2000		18-3894
C75	1994-96		18-3805	P175	1996-99		18-3894
C75	1998-99		18-3805	S175	1996-99		18-3894
E75	1995-00		18-3805	V175	2000		18-3894
F75	2003-04		18-99094	VZ175	2001-02		18-99062
F75	2005, 2007-11		18-99094	VZ175	2003-11	18-99103	18-99062
F75	2006		18-99094	Z175	2001-03		18-99062
P75	1996-99		18-3805	Z175	2004-05	18-99103	18-99062
C80	1997		18-3805	200	1984-89	18-4404	18-3894

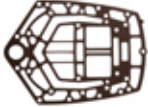
① LJ:-357803/XJ:-700843 ③ 2.6 litre engine
 ② LJ: 357804/XJ: 700844 ④ 3.1 litre engine

HP	Year	Powerhead Gasket Set	Head Gasket	HP	Year	Powerhead Gasket Set	Head Gasket
200	1990-95	18-4412	18-3894	L225 ④	1994-96	18-4400	18-3891
200	1996-98		18-3894	L225	1997-99		18-3891
L200	1986-89	18-4404	18-3894	S225	1996	18-4400	18-3891
L200	1990-95	18-4412	18-3894	S225	1997-99		18-3891
L200	1996-99		18-3894	LX225	2000-03		18-3891
LX200	1999-01		18-3894	SX225	2000-03		18-3891
LZ200	2000-03		18-99062	V225	1998-99		18-3891
LZ200	2004-11	18-99103	18-99062	VX225	2000-04		18-3891
P200	1991-95	18-4410	18-3894	VZ225	2003-04		18-99048
P200	1996-99		18-3894	VZ225	2005-09		18-99048
S200	1996-99		18-3894	250	1990-95	18-4400	18-3891
SX200	1999-03		18-3894	L250	1990-96	18-4400	18-3891
SX200	2004-05		18-3894	L250	1997-99		18-3891
V200	1998-99		18-3891	LX250	2000-03		18-3891
VX200	2000-05		18-3891	LZ250	2003-04		18-99048
VZ200	2000-03		18-99062	LZ250	2005		18-99048
VZ200	2004-09	18-99103	18-99062	S250	1996	18-4400	18-3891
Z200	2000-03		18-99062	S250	1997-99		18-3891
Z200	2004-11	18-99103	18-99062	SX250	2000-03		18-3891
V6 Special	1984-86	18-4404	18-3894	VZ250	2003-04		18-99048
V6 Excel	1987-89	18-4410	18-3894	VZ250	2005-09		18-99048
225 ③	1990-95	18-4410	18-3894	Z250	2003-04		18-99048
225	1996-97		18-3894	Z250	2005		18-99048
225 ④	1994-95	18-4400	18-3891				

- ① LJ:-357803/XJ:-700843
- ② LJ: 357804/XJ: 700844
- ③ 2.6 litre engine
- ④ 3.1 litre engine

 <p>18-0406 WATER PUMP GASKET Replaces: 60X-43315-A0-00 Fits: VZ200 (3.3L) 2005-10, VZ225 (3.3L) 2003-10, VZ250 (3.3L) 2003-10, VZ300 (3.3L) 2005-10</p>	 <p>18-0605 EXHAUST MANIFOLD SEAL Replaces: 67F-41138-00-00 Fits: F75 2003-Current: F80 1999-2003; F90 2003-Current: F100 1999-2003; F115 2000-Current.</p>	 <p>18-0617 EXHAUST SEAL Replaces: 67F-45127-00-00 Fits: F75 2003-Current: F80 1999-2003; F90 2003-Current: F100 1999-2003; F115 2000-Current.</p>	 <p>18-0618 EXHAUST MANIFOLD GASKET Replaces: 68V-45123-00-00</p>
 <p>18-0619 EXHAUST TUBE SEAL Replaces: 69J-41138-00-00</p>	 <p>18-0656 EXHAUST TUBE SEAL Replaces: 69J-45123-00-00</p>	 <p>18-0755 CRANKCASE DRAIN GASKET Replaces: 90430-14M09-00, 904-30142-28-00, 90430-14228-00 Fits: Four-Stroke 9.9hp.- 300hp. / 1999 - Current</p>	 <p>18-0849 FUEL PUMP MOUNTING GASKET Replaces: 650-24431-A0-00</p>
 <p>18-0856 GASKET Replaces: 64D-14384-01-00</p>	 <p>18-99000 EXHAUST MANIFOLD GASKET Replaces: 61A-41134-A0 Fits: 225(1994-95), 250(1992-95), L225 (1994-99), L250(1992-99), LX225(2000-03), LX250(2000-03), LZ250(2003-05), LZ300 (2004-05), S225(1996-99), S250(1996-99), SX225(2000-03), SX250(2000-03), V200(1998-99), V225(1998-99), VX200(2000-05), VX250 (2000-04), VZ200(2005), VZ225(2003-05), VZ250(2003-05), VZ300(2004-05), Z250(2003-05), Z300(2004-05)</p>	 <p>18-99001 UPPER CASING GASKET Replaces: 61A-45114-A0 Fits: 225(1994-95), 250(1992-95), L225 (1994-99), L250(1992-99), LX225(2000-03), LX250(2000-03), S225(1996-99), S250 (1996-99), SX225(2000-03), SX250 (2000-03), V200(1998-99), V225(1998-99), VX200(2000-05), VX225(2000-04), VX250(2002-04)</p>	 <p>18-99002 EXHAUST MANIFOLD GASKET Replaces: 62Y-41133-00 Fits: F25(1998-00), F40(1999), F50(1995-00), T50(1996-00)</p>
 <p>18-99003 EXHAUST GASKET Replaces: 62Y-41134-01 Fits: F30(2002-05), F40(2002-08), F50(2002-04), F60(2002-04), T25(2002-05), T50(2002-04)</p>	 <p>18-99004 UPPER CASING GASKET Replaces: 63D-45114-A0 Fits: 40(1995-05), 50(1995-09), C40(1997-03), C50(1998-01), P40(1998), P50(1995-96)</p>	 <p>18-99005 MUFFLER GASKET Replaces: 63D-45123-00 Fits: 40(1995-05), 50(1995-09), C40(1997-03), C50(1998-01), P40(1998), P50(1995-96)</p>	 <p>18-99006 EXHAUST MANIFOLD GASKET Replaces: 63V-41133-A1 Fits: 9.9(1997-09), 15(1997-09)</p>



**18-99008
EXHAUST
MANIFOLD GASKET**
Replaces: 64J-41133-10
Fits: F40(2008-10), F60(2002-04), T25(2009-10), T60(2003-04)



**18-99009
MUFFLER GASKET**
Replaces: 663-45123-00
Fits: (1985-94), (1984-94), C55(1991-95), CV55(1989-90), E48(1995-00), F40(1999), F50(1995-04), F50(1991-94), PR50(1989), PRO 50(1987-90), T50(1996-04)



**18-99010
EXHAUST
MANIFOLD GASKET**
Replaces: 664-41134-A0
Fits: C25(1992-97), C30(1992-97)



**18-99012
EXHAUST
MANIFOLD GASKET**
Replaces: 66M-41133-00
Fits: F15(1998-04)

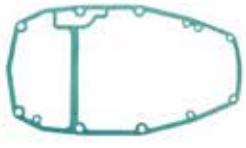

**18-99013
UPPER
CASING GASKET**
Replaces: 66M-45113-00
Fits: F9.9 (2005-06), F15(1998-05), T9.9(2005-06)



**18-99014
EXHAUST
MANIFOLD GASKET**
Replaces: 676-41133-A0
Fits: C40(1992-97)



**18-99015
UPPER
CASING GASKET**
Replaces: 676-45114-A0
Fits: C40(1991-97), CV40(1990)



**18-99016
EXHAUST
MANIFOLD GASKET**
Replaces: 67C-41133-00
Fits: F25(2001-05, 2009-10), F30(2001-05), F40(2000-08), F50(2001-04), T25(2005-06)



**18-99017
MUFFLER GASKET**
Replaces: 67C-45123-00
Fits: F30(2001-05), F40(2000-10), F60(2002-04), T25(2001-06, 2009-10), T60(2003-04)



**18-99018
EXHAUST
MANIFOLD GASKET**
Replaces: 67F-41133-A1
Fits: F75(2003-10), F90(2004-10), F115(2004-10), LF115(2004-10)



**18-99019
EXHAUST
MANIFOLD GASKET**
Replaces: 67F-41134-A0
Fits: F75(2003-10), F80(1999-03), F90(2003-10), F100(1999-03), F115(2000-10), LF115(2000-10)



**18-99020
MUFFLER GASKET**
Replaces: 67F-45123-00
Fits: F75(2003-10), F80(1999-03), F90(2003-10), F100(1999-03)



**18-99021
EXHAUST
MANIFOLD GASKET**
Replaces: 682-41133-A0
Fits: 9.9(1992-95), 15(1992-95)

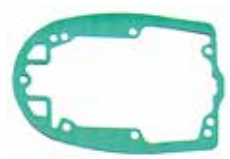

**18-99022
UPPER
CASING GASKET**
Replaces: 682-45113-A1
Fits: 9.9(1984-95), 15(1984-95)



**18-99023
EXHAUST
MANIFOLD GASKET**
Replaces: 688-41133-00
Fits: 90(1984-09), B90(1997-99), C75(1994-96, 98-99), C80(1997), C85(1991-96), C90(1997-01), CV85(1989-90), E75(1995-00), P75(1996-99)



**18-99024
EXHAUST
MANIFOLD GASKET**
Replaces: 688-41134-A0
Fits: 90(1984-09), B90(1997-99), C75(1994-99), C80(1997), C85(1991-96), C90(1997-01), CV85(1989-90), E75(1995-00), P75(1996-99)

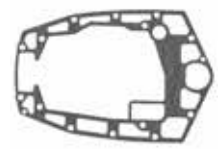

**18-99025
UPPER
CASING GASKET**
Replaces: 688-45114-A1
Fits: 90(1984-09), B90(1997-99), C75(1994-99), C80(1997), C85(1991-96), C90(1997-01), CV85(1989-90), E75(1995-00), P75(1996-99)





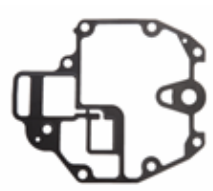



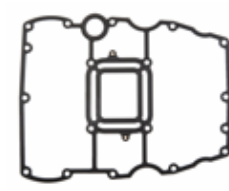











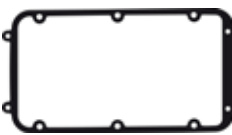

**18-99026
MUFFLER GASKET**
Replaces: 688-45123-00
Fits: 90(1984-09), B90(1997-99), C75(1994-99), C80(1997), C85(1991-96), C90(1997-01), CV85(1989-90), E75(1995-00), P75(1996-99)



**18-99027
OIL PAN GASKET**
Replaces: 68T-13475-00
Fits: F6(2001-08), F8(2001-10), F9.9(2007, 2010), T8(2001-10), T9.9(2007-10)

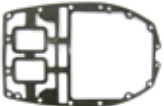

**18-99028
OIL PAN GASKET**
Replaces: 68V-15312-00
Fits: F75(2003-10), F90(2004-10), F115(2004-10), LF115(2004-10)

 <p>18-99030 UPPER CASING GASKET Replaces: 697-45114-A0 Fits: E48(1995-00), C55(1992-95)</p>	 <p>18-99032 EXHAUST MANIFOLD GASKET Replaces: 69J-41134-A0 Fits: F200(2002-05), F225(2002-05), LF200(2002-05), LF225(2002-05)</p>	 <p>18-99033 EXHAUST MANIFOLD GASKET Replaces: 69J-41135-A0 Fits: F200(2002-10), F225(2002-10), F250(2005-10), LF200(2002-10), LF225(2002-10), LF250(2005-10)</p>	 <p>18-99034 EXHAUST MANIFOLD GASKET Replaces: 69J-41136-A0 Fits: F200(2002-05), F225(2002-05), F250(2005), LF200(2002-05), LF225(2002-05), LF250(2005)</p>	
 <p>18-99037 EXHAUST MANIFOLD GASKET Replaces: 6E5-41134-A0 Fits: 115(1992-09), 130(1992-04), B115(1998-99), C115(1992-00), L130(1994-01), P115(1993-96), S115(1996-99), S130(1996-99)</p>	 <p>18-99038 EXHAUST MANIFOLD GASKET Replaces: 6E5-41135-A0 Fits: 115(1992-09), 130(1992-04), 150(1992-09), 175(1992-95), 200(1992-98), 225(1992-97), B115(1998-99), C115(1992-00), C150(1996-99), D150(1997-99), DX150(1999-05), L150(1992-01), L200(1992-99), LX150(1999-01), LX200(1999-01), LZ150(2000-05), LZ200(2000-10), P115(1993-96), P150(1992-99), P175(1994-99), P200(1992-99), PX150(1999), S115(1996-99), S130(1996-99), S150(1996-99), S175(1996-99), S200(1996-99), SX150(1999-04), SX200(1999-05), V150(2000-08), V175(2000), VX150(2000-04), VZ150(2000-10), VZ175(2001-10), VZ200(2001-04), Z150(2000-05), Z175(2001-05), Z200(2000-10)</p>	 <p>18-99039 EXHAUST MANIFOLD GASKET Replaces: 6G5-41134-A1 Fits: 115(2003-04), 130(2003-04), 150(2003-09), DX150(2003-05), LZ150(2003-05), LZ200(2003-10), SX150(2003-04), SX200(2003-05), V150(2003-08), VX150(2003-04), VZ150(2003-10), VZ175(2003-10), VZ200(2003-04), Z150(2003-05), Z175(2003-05), Z200(2003-10)</p>	 <p>18-99040 UPPER CASING GASKET Replaces: 6G5-45114-A1 Fits: 115(2003-09), 130(2003-04), 150(2003-09), DX150(2003-05), LZ150(2003-05), LZ200(2003-10), SX150(2003-04), SX200(2003-05), V150(2003-08), VX150(2003-04), VZ150(2003-10), VZ175(2003-10), VZ200(2003-04), Z150(2003-05), Z175(2003-05), Z200(2003-10)</p>	
 <p>18-99045 UPPER CASING GASKET Replaces: 6G8-45113-A1 Fits: F9.9(1997-05), T9.9(1995-05)</p>	 <p>18-99046 UPPER CASING GASKET Replaces: 6H3-45114-A1 Fits: 60(2002-05), 70(1984-069), C60(1996-01), C70(2001-02), E60(1995-00), P60(1991-99)</p>	 <p>18-99047 MUFFLER GASKET Replaces: 6H3-45123-00 Fits: 60(2001-05), 70(1984-09), C60(1996-01), C70(2000-01), E60(1995-00), P60(1991-99)</p>	 <p>18-99049 REED GASKET Replaces: 60V-13621-A0 Fits: LZ250(2003-05), LZ300(2004-06), VZ200(2005-09), VZ225(2003-09), VZ250(2003-09), VZ300(2004-09), Z250(2003-05), Z300(2004-06)</p>	 <p>18-99050 INTAKE GASKET Replaces: 60V-13645-00 Fits: LZ250(2003-05), LZ300(2004-06), VZ200(2005-09), VZ225(2003-09), VZ300(2004-09), Z250(2003-05), Z300(2004-06)</p>
 <p>18-99051 VALVE COVER GASKET Replaces: 61A-11193-A1 Fits: L225(1996-99), L250(1996-99), LX225(2000-03), LX250(2000-03), S225(1996-99), S250(1996-99), SX225(2000-03), SX250(2000-03), V200(1998-99), V225(1998-99), VX200(2000-05), VX225(2000-04)</p>	 <p>18-99052 SIDE COVER GASKET Replaces: 61A-11381-A0 Fits: 225(1994-95), 250(1992-95), L225(1994-99), L250(1992-99), LX225(2000-03), LX250(2000-03), S225(1996-99), S250(1996-99), SX225(2000-03), SX250(2000-03), V200(1998-99), V225(1998-99), VX200(2000-05), VX225(2000-04), VX250(2002-04)</p>	 <p>18-99053 INTAKE GASKET Replaces: 61A-13621-A0 Fits: 225(1994-95), 250(1992-95), DX150(1999-05), L225(1994-99), L250(1992-99), LX150(1999-01), LX200(1999-01), LX225(2000-03), LX250(2000-03), LZ150(2000-05), LZ200(2000-10), PX150(1999), S225(1996-99), S250(1996-99), SX150(1999-04), SX200(1999-05), SX225(2000-03), SX250(2000-03), V200(1998-99), V225(1998-99), VX150(2000-04), VX200(2000-05), VX225(2000-04), VX250(2002-04), VZ150(2000-10), VZ175(2001-10), VZ200(2001-04), Z150(2000-05), Z175(2001-05), Z200(2000-10)</p>	 <p>18-99054 INTAKE GASKET Replaces: 61A-13645-00 Fits: 225(1994-95), 250(1990-95), L225(1994-96), L250(1990-96), S225(1996), S250(1996)</p>	
 <p>18-99055 MANIFOLD GASKET Replaces: 61A-13646-00 Fits: 225(1994-95), 250(1990-95), L225(1994-96), L250(1990-96), S225(1996), S250(1996)</p>	 <p>18-99056 BASE GASKET Replaces: 61A-45113-A0 Fits: 225(1994-95), 250(1990-95), L225(1994-99), L250(1990-99), LX225(2000-03), LX250(2000-03), S225(1996-99), S250(1996-99), SX225(2000-03), SX250(2000-03), V200(1998-99), V225(1998-99), VX200(2000-05), VX225(2000-04), VX250(2002-04)</p>	 <p>18-99057 VALVE COVER GASKET Replaces: 61T-11193-A1 Fits: C30(1993-97)</p>	 <p>18-99063 LOWER CASING GASKET Replaces: 63V-45315-A0 Fits: 9.9(1996-09), 15(1996-09), F9.9(2005-06), F15(1998-05), T9.9(2005-06)</p>	



18-99064
INTAKE GASKET
 Replaces: 64E-13645-A0
 Fits: 150(1996-99), 200(1996-98), 225(1996-97), D150(1997-99), L150(1996-99), L200(1996-99), P150(1996-99), P175(1996-99), P200(1996-99), S150(1996-99), S175(1996-99), V150(2000-08), V175(2000)



18-99066
INTAKE GASKET
 Replaces: 65L-13645-00
 Fits: DX150(1999-05), L225(1997-99), L250(1997-99), LX150(1999-01), LX200(1999-01), LX225(2000-03), LX250(2000-03), LZ150(2000-05), LZ200(2000-10), PX150(1999), S225(1997-99), S250(1997-99), SX150(1999-04), SX200(1999-03), SX200(2000-03), SX225(2000-03), SX250(2000-03), V200(1998-99), V225(1998-99), VX150(2000-04), VX200(2000-05), VX225(2000-04), VX250(2002-04), VZ150(2000-10), VZ175(2001-10), VZ200(2001-04), VZ150(2000-05), Z175(2001-05), Z200(2000-10)



18-99067
INTAKE GASKET
 Replaces: 65L-13646-00
 Fits: DX150(1999-05), L225(1997-99), L250(1997-99), LX150(1999-01), LX200(1999-01), LX225(2000-03), LX250(2000-03), LZ150(2000-05), LZ200(2000-10), PX150(1999), S225(1997-99), S250(1997-99), SX150(1999-04), SX200(1999-03), SX200(2000-03), SX225(2000-03), SX250(2000-03), V200(1998-99), V225(1998-99), VX150(2000-04), VX200(2000-05), VX225(2000-04), VX250(2002-04), VZ150(2000-10), VZ175(2001-10), VZ200(2001-04), VZ150(2000-05), Z175(2001-05), Z200(2000-10)



18-99068
BREATHER COVER GASKET
 Replaces: 65W-11169-00
 Fits: F25(1998-01), T25(2001)



18-99069
BASE GASKET
 Replaces: 65W-11351-00
 Fits: F25(1998-02), T25(2001-02)



18-99070
CRANKCASE GASKET
 Replaces: 65W-11356-00
 Fits: F25(1998-05), T25(2001-06)



18-99071
GASKET
 Replaces: 65W-14457-10
 Fits: F25(1999-05), T25(2001-06)

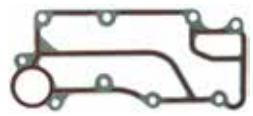

18-99072
EXHAUST GASKET
 Replaces: 65W-41114-00
 Fits: F25(1998-05), T25(2001-06)



18-99074
BASE GASKET
 Replaces: 66M-11351-10
 Fits: F9.9(2005-06), F15(2005), T9.9(2005-06)



18-99075
CYLINDER COVER GASKET
 Replaces: 66M-11356-00
 Fits: F9.9(2005-06), F15(1998-05), T9.9(2005-06)



18-99076
WATER PUMP GASKET
 Replaces: 66M-13329-10
 Fits: F9.9(2005-06), F15(2001-05), T9.9(2005-06)



18-99078
GASKET
 Replaces: 66M-41138-00
 Fits: F15(1998-04)



18-99079
UPPER CASING GASKET
 Replaces: 66M-45115-00
 Fits: F9.9(2005-06), F15(1998-05), T9.9(2005-06)



18-99080
INTAKE GASKET
 Replaces: 676-13646-A0
 Fits: C40(1991-97), CV40(1990)

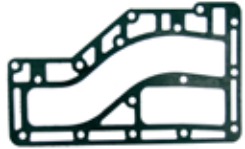

18-99081
EXHAUST GASKET
 Replaces: 676-41112-A0
 Fits: C40(1991-97), CV40(1990)



18-99082
WATER PUMP GASKET
 Replaces: 676-44315-A1
 Fits: C40(1991-97), CV40(1990)



18-99083
WATER PUMP GASKET
 Replaces: 676-44324-A0
 Fits: C40(1991-97), CV40(1990)



18-99084
EXHAUST GASKET
 Replaces: 676-45127-00
 Fits: C40(1991-97), CV40(1990)



18-99085
EXHAUST GASKET
 Replaces: 676-45128-00
 Fits: C40(1991-97), CV40(1990)













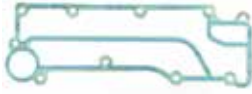

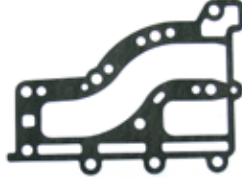

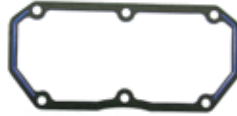
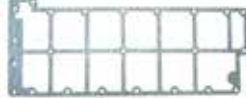
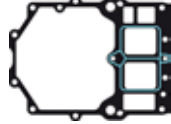





18-99086
WATER PUMP GASKET
 Replaces: 679-44316-A0
 Fits: C40(1991-97), CV40(1990)



















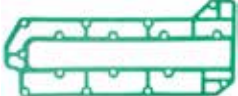
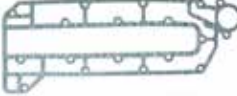





18-99087
LOWER CASING GASKET
 Replaces: 679-45315-A0
 Fits: C40(1991-94), CV40(1990)



18-99088
CYLINDER COVER GASKET
 Replaces: 67C-11356-00
 Fits: F30(2001-05), F40(2000-08)

 <p>18-99089 EXHAUST GASKET Replaces: 67C-41114-00 Fits: F30(2001), F40(2000-01)</p>	 <p>18-99091 GASKET Replaces: 67C-45113-00 Fits: F25(2001), F30(2001), F40(2000-01), t25(2001)</p>	 <p>18-99095 BASE GASKET Replaces: 682-11351-A0 Fits: 9.9(1984-95), 15(1984-95)</p>	 <p>18-99096 GASKET Replaces: 682-41112-A1 Fits: 9.9(1984-95), 15(1984-95)</p>	
 <p>18-99098 INTAKE GASKET Replaces: 688-13621-A1 Fits: 90(1992-09), B90(1997-99), C75(1994-99), C80(1997), C85(1992-96), C90(1997-01), E75(1995-00), P75(1996-99)</p>	 <p>18-99099 VALVE COVER GASKET Replaces: 68F-11193-01 Fits: LZ150(2000-05), LZ200(2000-08), VZ150(2000-08), VZ175(2001-08), VZ200(2001-04), Z150(2000-05), Z175(2001-05), Z200(2000-08)</p>	 <p>18-99100 GASKET Replaces: 68F-11381-00 Fits: LZ150(2000-05), LZ200(2000-10), VZ150(2000-10), VZ175(2001-10), VZ200(2001-04), Z150(2000-05), Z175(2001-05), Z200(2000-10)</p>	 <p>18-99101 EXHAUST GASKET Replaces: 68F-41114-00 Fits: LZ150(2000-05), LZ200(2000-10), VZ150(2000-10), VZ175(2001-10), VZ200(2001-04), Z150(2000-05), Z175(2001-05), Z200(2000-10)</p>	 <p>18-99102 BASE GASKET Replaces: 68F-45113-00 Fits: 150(2004-08), DX150(2004-05), LZ150(2000-05), LZ200(2000-08), SX150(2004), SX200(2004-05), V150(2004-08), VX150(2004), VZ150(2000-08), VZ175(2001-08), VZ200(2001-04), Z150(2000-05), Z175(2001-05), Z200(2000-08)</p>
 <p>18-99105 INTAKE GASKET Replaces: 6E5-13621-A1 Fits: 115(1992-09), 130(1992-04), 150(1992-09), 175(1992-95, 2000), 200(1992-98), B115(1998-96), C115(1992-00), C150(1996-99), L130(1992-01), L150(1992-99), L200(1992-98), P115(1993-96), P150(1993), S115(1996-99), S130(1996-99), S150(1996-99), S175(1996-99), S200(1996-99)</p>	 <p>18-99106 VALVE COVER GASKET Replaces: 6E9-11193-A0 Fits: C40(1991-97), CV40(1990)</p>	 <p>18-99107 EXHAUST GASKET Replaces: 6E9-41114-A0 Fits: C40(1992-97)</p>	 <p>18-99108 VALVE COVER GASKET Replaces: 6G1-11193-A1 Fits: 6(1986-00), 8(1984-09)</p>	 <p>18-99109 REED GASKET Replaces: 6G1-13621-A1 Fits: 6(1991-00), 8(1991-09)</p>
 <p>18-99110 INTAKE GASKET Replaces: 6G1-13645-A1 Fits: 6(1991-00), 8(1991-09)</p>	 <p>18-99111 INTAKE GASKET Replaces: 6G1-14198-A1 Fits: 6(1986-00), 8(1984-09)</p>	 <p>18-99112 EXHAUST GASKET Replaces: 6G1-41112-A1 Fits: 6(1986-00), 8(1984-09)</p>	 <p>18-99113 EXHAUST GASKET Replaces: 6G1-41114-A0 Fits: 6(1991-00), 8(1991-09)</p>	 <p>18-99114 EXHAUST GASKET Replaces: 6G1-41133-A0 Fits: 6(1992-00), 8(1992-09)</p>
 <p>18-99115 BASE GASKET Replaces: 6G1-45113-A1 Fits: 6(1986-00), 8(1984-09)</p>	 <p>18-99116 WATER PUMP GASKET Replaces: 6G1-45315-A0 Fits: 6(1986-00), 8(1984-09)</p>	 <p>18-99118 CARBURETOR GASKET Replaces: 6G5-14483-A1 Fits: C150(1996-99)</p>	 <p>18-99119 BASE GASKET Replaces: 6G8-11351-A0 Fits: F9.9(1985-05), FT9.9(1985-90), T9.9(1991-05)</p>	 <p>18-99120 THERMOSTAT GASKET Replaces: 6G8-12414-A0 Fits: F6(2001-04), F8(2001-04), F9.9(1985-05, 2007, 2010), FT9.9(1985-90), T8(2001-04), T9.9(1991-05, 2007-10)</p>

SEE PAGES 166-167 FOR OUR COMPLETE LINE OF GASKET SEALANTS

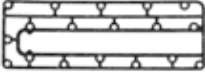
 <p>18-99121 INTAKE GASKET Replaces: 6G8-13646-A0 Fits: F9.9(1985-05), FT9.9(1985-90), T9.9(1991-05)</p>	 <p>18-99122 INTAKE GASKET Replaces: 6G8-14198-A0 Fits: F9.9(1992-05), T9.9(1992-05)</p>	 <p>18-99123 GASKET Replaces: 6G8-15374-00 Fits: F9.9(1985-05), FT9.9(1985-90), T9.9(1991-05)</p>	 <p>18-99124 THERMOSTAT GASKET Replaces: 6H3-12414-A1 Fits: 60(2001-05), 70(1984-09), C60(1996-01), C70(2000-01), E60(1995-00), P60(1991-99)</p>	 <p>18-99125 INTAKE GASKET Replaces: 6H3-13622-00 Fits: 70(1985-91), P60(1991)</p>
 <p>18-99126 INTAKE GASKET Replaces: 6H3-14198-01 Fits: 70(1984-91), P60(1991)</p>	 <p>18-99128 EXHAUST GASKET Replaces: 6H3-41114-AO Fits: 60(2001-05), 70(1992-09), C60(1996-01), C70(2000-01), E60(1995-00), P60(1992-99)</p>	 <p>18-99129 EXHAUST GASKET Replaces: 6H3-41112-AO Fits: 60(2001-05), 70(1986-09), C60(1996-01), C70(2000-01), E60(1995-00), P60(1991-99)</p>	 <p>18-99130 EXHAUST GASKET. Replaces: 6H3-45113-A0 Fits: 60(2001-025), 70(1984-09), C60(1996-01), C70(2000-01), E60(1995-00), P60(1991-99)</p>	 <p>18-99132 REED GASKET Replaces: 6H4-13621-A1 Fits: 40(1984-05), 50(1984-09), C40(1997-03), C50(1998-01), P40(1998), P50(1991-96), PR50(1989), Pro 50(1987-90)</p>
 <p>18-99133 GASKET Replaces: 6H4-14198-01 Fits: 40(1989-05), 50(1989-09), C40(1997-03), C50(1998-01), P40(1998), P50(1991-96), PR50(1989), Pro 50(1989-90)</p>	 <p>18-99134 END CAP GASKET Replaces: 6H4-15369-A1 Fits: 40(1984-01), 50(1984-09), C40(1997-03), C50(1998-01), P40(1998), P50(1991-96), PR50(1989), Pro 50(1987-90)</p>	 <p>18-99135 EXHAUST GASKET Replaces: 6H4-41112-A0 Fits: 40(1992-05), 50(1992-09), C40(1997-03), C50(1998-01), P40(1998), P50(1992-96)</p>	 <p>18-99136 INTAKE GASKET Replaces: 6K7-13646-A1 Fits: 225(1990-95), P150(1994-95), P175(1994-95), P200(1992-95), V6 Excel(1987-89)</p>	 <p>18-99137 EXHAUST GASKET Replaces: 6L2-41133-A2 Fits: 25(2004-08)</p>
 <p>18-99138 WATER PUMP GASKET Replaces: 6L2-45315-A0 Fits: 20(1996-97), 25(1992-09)</p>	 <p>18-99139 INTAKE GASKET Replaces: 6OV-13646-00 Fits: LZ250(2003-05), LZ300(2004-06), VZ200(2005-09), VZ225(2003-09), VZ250(2003-09), VZ300(2004-09), Z250(2003-05), Z300(2004-06)</p>	 <p>18-99140 HEAD GASKET Replaces: 63V-11181-A1, 63V-11181-A2 Fits: 9.9(1997-08), 15(1997-08)</p>	 <p>18-99141 COVER GASKET Replaces: 6H3-11193-A1 Fits: 60(2001-05), 70(1984-09), C60(1996-01), C70(2000-01), E60(1995-00), P60(1991-99)</p>	 <p>18-99142 THERMOSTAT GASKET Replaces: 6E9-12414-A0, 6E9-12414-A1 Fits: C40(1992-97)</p>
 <p>18-99143 VALVE SEAL GASKET Replaces: 6H3-13621-A1 Fits: 60(2001-05), 70(1992-09), C60(1996-01), C70(2000-01), E60(1995-00), P60(1992-99)</p>	 <p>18-99144 MIXING COVER GASKET Replaces: 6E7-14227-00 Fits: 9.9(1984-95), 15(1984-95)</p>	 <p>18-99145 CARBURETOR GASKET Replaces: 677-14198-00, 677-14198-A1 Fits: 9.9(1984-91), 15(1984-91)</p>	 <p>18-99147 FUEL PUMP GASKET Replaces: 6G1-24431-01 Fits: 3(1990-02), 6(1990-00), 8(1990-09), 9.9(1996-09), 15(1996-09)</p>	 <p>18-99148 OUTER EXHAUST COVER GASKET Replaces: 688-41114-A0 Fits: 90(1992-09), B90(1998-99), C75(1994-99), C80(1997), C85(1992-96), C90(1997-01), E75(1995-00), P75(1996-99)</p>

SEE PAGES 166-167 FOR OUR COMPLETE LINE OF GASKET SEALANTS

NEW

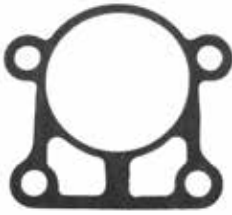

18-99149
WATER PUMP GASKET
 Replaces: 663-44316-A0
 Fits: 25(1997-02), 30(1992-01), 40(1992-94), 50(1992-94), C30(1995), C55(1992-95), E48(1995-00), P50(1992-94)

NEW

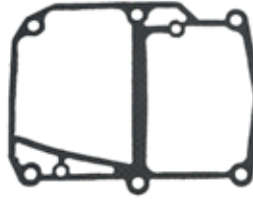

18-99150
UPPER CASING GASKET
 Replaces: 63V-45113-A1
 Fits: 9.9(1997-09), 15(1997-09)

NEW

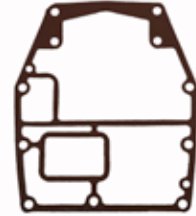

18-99151
UPPER CASING GASKET
 Replaces: 688-45113-A0
 Fits: 90(1984-09), B90(1997-99), C75(1994-99), C80(1997), C85(1991-96), C90(1997-01), C85(1989-90), E75(1995-00), P75(1996-99)

NEW



18-99152
LOWER CASING GASKET
 Replaces: 683-45315-A0
 Fits: 9.9(1984-95), 15(1984-95), F9.9(1986-05)



18-0765
FLOAT CHAMBER GASKET
 Replaces: 6L2-14384-00-00

PKG. OF 2



18-0775
18-0775-9①
CARB MOUNTING GASKET
 Replaces: 648-14198-A0-00



18-0785
CARB MOUNTING GASKET
 Replaces: 6E5-14198-A1-00

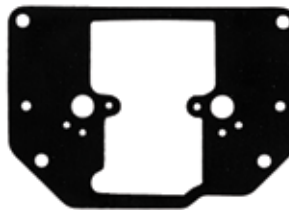

18-0786
FLOAT CHAMBER GASKET
 Replaces: 6E5-14384-02-00



18-2592
FLOAT BOWL GASKET
 Replaces: 6E5-14384-03-00
 For: V-4 Outboards: 115, 130, 150, 175, 200, 225 (1986-96) V-6 Special & Excel (1986-89)



18-0840-1
FLOAT CHAMBER GASKET
 Replaces: 676-14984-00-00

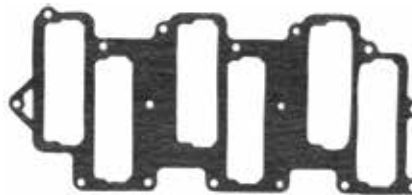











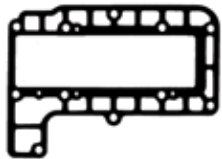
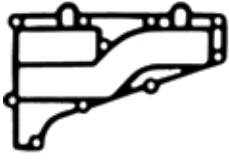



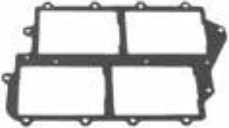





18-0807-1
REED PLATE GASKET
 Replaces: 6K7-13645-A1-00





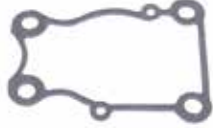

18-0809
REED BLOCK GASKET
 Replaces: 6G5-13645-A1-00

SEE PAGES 166-167 FOR OUR COMPLETE LINE OF GASKET SEALANTS

① Priced per Package

 <p>18-0808 VALVE COVER GASKET Replaces: 6G5-11382-A1-00</p>	 <p>18-0250 EXHAUST COVER GASKET Replaces: 664-41114-A0-00</p>	 <p>18-0743 INNER EXHAUST COVER GASKET Replaces: 6L2-41112-A1-00</p>	 <p>18-0744 OUTER EXHAUST COVER GASKET Replaces: 6L2-41114-A1-00</p>	 <p>18-0798 EXHAUST COVER GASKET Replaces: 6H4-41114-A0-00</p>
 <p>18-0799 EXHAUST COVER GASKET Replaces: 6E5-41112-A1-00</p>	 <p>18-0812 EXHAUST COVER GASKET Replaces: 6G5-41112-A1-00</p>	 <p>18-0823 EXHAUST MANIFOLD GASKET Replaces: 6E5-13645-A1-00</p>	 <p>18-0847 90 HP EXHAUST COVER GASKET Replaces: 688-41112-A0-00</p>	 <p>18-0739 UPPER CASING GASKET Replaces: 689-45113-A1-00</p>
 <p>18-0813 POWERHEAD BASE GASKET Replaces: 6G5-45113-A0-00</p>	 <p>18-0232 COVER GASKET Replaces: 655-12414-A1-00</p>	 <p>18-0782 COVER GASKET Replaces: 6E5-11381-A1-00</p>	 <p>18-0829 COVER GASKET Replaces: 61A-12414-A0-00 6J8-12414-A0-00</p>	 <p>18-0754 THERMOSTAT GASKET Replaces: 68D-E2414-A0-00 Fits: F2.5MSH-0405, F2.5MSH-0406, F2.5MSH-0407, F2.5MSH0608, F2.5MSHD-2007</p>
 <p>18-0835 THERMOSTAT GASKET Replaces: 62Y-12414-00-00 Fits: F 9.9, T9.9 (2005-06), 15 (2006), F15, F25 (1998-06), T25, F30 (2001- 06), F40 4cyl (1999), F40 3cyl (2000- 06), F50 (1996-06), T50 (1996-06), F60 (2002-06), T60 (2003-06)</p>	 <p>18-0836 THERMOSTAT GASKET Replaces: 682-12414-A1-00 Fits: 9.9, 15 (1984-06)</p>	 <p>18-0844 THERMOSTAT GASKET Replaces: 688-12414-A1-00 Fits: 90 HP V-4, V-6</p>	 <p>18-0767 WATER JACKET GASKET Replaces: 688-11193-01-00 Fits: 90 HP</p>	 <p>18-0779 WATER JACKET GASKET Replaces: 6G5-11193-A0-00</p>
 <p>18-0781 WATER JACKET GASKET Replaces: 6E5-11193-A0-00</p>	 <p>18-0815 WATER JACKET GASKET Replaces: 6H4-11193-A1-00</p>	 <p>18-0483 PUMP CASE GASKET Replaces: 63D-44316-00-00 Fits: 40 (1995-04), 50 (1995-97, 1999-04)</p>	 <p>18-0753 WATER PUMP GASKET Replaces: 6G1-44315-A0-00 Fits: 6 (1986-00), 8 (1984-05)</p>	 <p>18-0239 WATER PUMP GASKET Replaces: 688-44315-A0-00</p>

SEE PAGES 166-167 FOR OUR COMPLETE LINE OF GASKET SEALANTS

				
18-0240 WATER PUMP GASKET Replaces: 688-44316-A0-00	18-0244 WATER PUMP GASKET Replaces: 6E5-44315-A0-00	18-0292 WEAR PLATE TO PUMP HOUSING GASKET Replaces: 663-44315-A0-00	PKG. OF 2 18-0294 18-0294-9① WEAR PLATE TO PUMP BASE GASKET Replaces: 663-44324-A0-00	18-0756-1 WATER PUMP GASKET Replaces: 6H3-44315-A0-00

			
18-0757 OUTER PLATE GASKET Replaces: 6H3-44324-A0-00	PKG. OF 2 18-0768 18-0768-9① WEAR PLATE GASKET Replaces: 682-44315-A0-00	18-0826 DRAIN SCREW GASKET Replaces: 90430-14115-00-00 Fits: 40-90 HP	18-1079 OIL SEAL PROTECTOR Replaces: 6A1-44325-00-00 Fits: 2(1984-85, 1988-89)

SEE PAGES 166-167 FOR OUR COMPLETE LINE OF GASKET SEALANTS

			
18-4274 PROP SPACER Replaces: 688-45997-01-00	18-4698 18-46981-9① (PKG. OF 50) DRAIN FILL WASHER Replaces: 90430-08020-00	18-2371 18-23711-9① (PKG. OF 50) DRAIN SCREW Replaces: 90340-08002-00, 90340-08M04-00	18-2374 18-23741-9① (PKG. OF 50) MAGNETIC DRAIN SCREW Replaces: 688-45341-00-00, 688-45341-10-00

		
18-2388 PROP SHAFT Replaces: 688-45611-00-00 For: F40 (1999) F50(1999-00) C60/C70/C90 (2000-01) C75 (1994) C85 (1991-94)	18-2385 PROP SHAFT Replaces: 6E5-45611-01-00 For: 115/130HP	18-2247 PROP SHAFT Replaces: 679-45611-01-00 For: 40-50HP

Model No.	Year	Part #	Model No.	Year	Part #
40	1984-86, 89-90, 92-94	18-2247	C90	2000-2001	18-2388
C40	1991-93, 95-97	18-2247	115	1984-2000, 2002-2003	18-2385
CV40	1990	18-2247	C115	1991, 1993-2000	18-2385
50	1986-1994	18-2247	F115, LF115	2000-2003	18-2385
P50	1991-1994	18-2247	S115	1996-1999	18-2385
PRO50	1987-1990	18-2247	130	1984-2000, 2002-2003	18-2385
T50	1999-2000	18-2388	L130	1994-2000	18-2385
C60, C70	2000-2001	18-2388	S130	1996-1999	18-2385
C75	1994	18-2388	150	1985, 1997	18-2385
E75	2000	18-2388	175	1985	18-2385
C85	1991-1994	18-2388	200	1984-1985	18-2385
CV85	1990	18-2388	V6 Special	1985-1986	18-2385

① Priced per Package

18-2773

CARRIER BEARING

Replaces: 663-45331-00-94

For: E48 (1995, 1997-00) / C55 (1991-95)



18-2782

CARRIER BEARING

Replaces: 688-45331-00-94

For: F40 (1999) F50/T50 (1996-00) 60 (2002-03) C60 (1996-01) E60 (1995-99) P60 (1991-99) 70 (1984-03) C70 (2000-01) C75 (1994-96 / 1998-99) E75 (1995-00) P75 (1996-99) C80 (1997) C85 (1991-96)



Zinc is for saltwater only applications.
Magnesium is for fresh water only applications.
Aluminum is for brackish water, or if boat is used in both fresh and salt environments.

18-6118A①

CYLINDER BLOCK ANODE

Replaces: 68V-11325-01-00

Fits: F75-F250 / 2004 through April 2006 Production



18-6119A①

18-6119Z③

TRIM TAB ANODE

Replaces: 61A-45371-00-00



18-6120A①

18-6120Z③

GEARCASE ANODE

Replaces: 61N-45251-01-00



18-6121A①

18-6121Z③

TRIM TAB ANODE

Replaces: 6K1-45371-02-00

Fits: FL150 (2004-2005); L150 - L200 (1987-2002)



18-6122A①

18-6122Z③

TRIM TAB ANODE

Replaces:

69L-45371-00-00

Fits: VZ200 - VZ300 / 3.3L (2005-Current), VX225 - VX250 / 2.6L (2002-2005), Z250 - Z300 / 3.3L (2004-Current)



18-6246

TRIM TAB BOLT

Replaces: 90105-10M00-00



③ 18-6034

ANODE

Replaces:

6K1-45371-00-00

For use on lower drive 150,200 HP (1986)



② 18-6112

③ 18-6035

ANODE

Replaces:

6J9-45371-01-00

For: 150-200 HP



② 18-6111

③ 18-6070

ANODE

Replaces:

688-45371-02-00

For use on lower casing drive

For: 60, 70, 90HP (1984-04) C60, C75, C85, C90 (1994-01), E60, E75 (1995-00), F50 (1996-00), P60, P75 (1991-99), T50 (1996-00)

③ 18-6090

ANODE

Replaces:

6G5-45251-01-00

For use on transom bracket

For: 115-225HP (1988-02)



③ 18-6091

ANODE

Replaces:

6H1-45251-02-00

For: 40-90 HP



③ 18-6096

ANODE

Replaces:

664-45371-01-00

For: 20-50 HP



③ 18-6097

ANODE

Replaces:

6E5-45371-01-00

For use on lower casing drive

For: 115, 130 HP(1984-04), V6 Special (1985-86)



② 18-6132A

③ 18-6132M

ANODE

For: Yamaha 200-250 Outboards



NEW

NEW

② 18-6133A

③ 18-6133M

ANODE

Fits: Yamaha 150-200 Outboards



NEW

18-3709

Prop Nut

Replaces: 647-45616-02

Fits: 4(1984-91), 5(1984-85)



18-3726

PROP NUT

Replaces: 90171-18M04

For: ALL V-4 & V-6 (Except D150)



18-3732

PROP NUT

Replaces: 90171-16011-00,

95307-16900-00



NEW

18-3773

Prop Nut

Replaces: 90171-10M01

Fits: 6(1986-00), 8(1986-09), 9.9(1984-09), 15(1984-09), F6(2001-08), F8(2001-12), F9.9(1985-12), F15(1998-13), F20(2006-13)



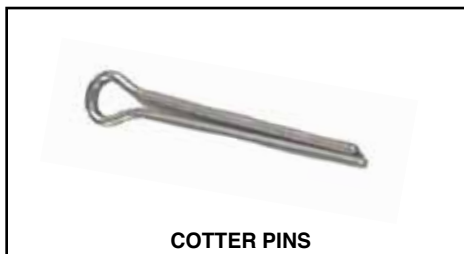

COTTER PINS

Part #	O.E. #	Pkg of
18-2380 ④	91490-30030-00	10
18-3735 ④	91490-40030-00	10
18-3748 ④	91490-30045-00	5



**18-3781
PROP NUT KIT**

Replaces: 6H1-W4599-00-00
For: T50, C60, E60, P60, 70, C75, C80, C85, 90
— CONTAINS —

Part #	O.E. #	Desc.
18-4274	688-45997-01	Spacer
18-2380	91490-30030	Cotter Pin



**18-3782
PROP NUT KIT**

Replaces: 6G5-W4599-00-00
— CONTAINS —

Part #	O.E. #	Desc.
18-3726	90171-18M04	Prop Nut
18-4274	688-45997-01	Spacer
18-3735	91490-40030	Cotter Pin

ALL V-4 & V-6 (Except D150)

HP/Model	Years	Nut #	Spacer #	Cotter Pin #	Kit #
2(6A1)	1984-95	—	—	18-3748	—
4(6E0)	1984-90	—	—	18-3748	—
4(6E0)	1991	—	—	18-2380	—
5	1984-85	—	—	18-3748	—
9.9(6GB)	1984-85	—	—	18-3748	—
20	1996-97	18-3792	18-3791	18-2380	18-3771
25(6H7)(6L2)	1984-09	18-3792	18-3791	18-2380	18-3771
C25(695)	1991-97	18-3792	18-3791	18-2380	18-3771
CV25	1990	18-3792	18-3791	18-2380	18-3771
F25	1998-05, 2009-10	18-3792	18-3791	18-2380	18-3771
30(689)(6J8)	1984-02	18-3792	18-3791	18-2380	18-3771
C30(689)(61T)	1991-97	18-3792	18-3791	18-2380	18-3771
CV30	1990	18-3792	18-3791	18-2380	18-3771
40(6H4)(63B,C,D)	1984-05	18-3732	—	18-2380	—
C40(6R6)	1990-03	18-3732	—	18-2380/18-3748	—
50(6H5)(62X)	1984-09	18-3732	—	18-2380/18-3748	—
PRO50(6H5)(62X)	1987-90	18-3732	—	18-2380	—
T50	2001-10	18-3732	18-3789	18-3735	18-3772
C55(697)	1991-95	18-3732	—	18-3735	—
60	2004-05	18-3732	18-3789	18-3735	18-3772
P60(6H2)	1991-99	18-3732	18-4274	18-3735	18-3781
T60	2003-10	18-3732	18-3789	18-3735	18-3772
70(6H3)	1984-03	18-3732	18-4274	18-3735	18-3781
70	2004-09	18-3732	18-3789	18-3735	18-3772
F70	2010	18-3732	18-3789	18-3735	18-3772
C75(692)	1994-99	18-3732	18-4274	18-3735	18-3781
F75	2003-10	18-3732	18-3789	18-3735	18-3772
F80	1999-03	18-3732	18-3789	18-3735	18-3772
C85(688)	1991-96	18-3732	18-4274	18-3735	18-3781
90(6H1)	1984-03	18-3732	18-4274	18-3735	18-3781
90	2004-09	18-3732	18-3789	18-3735	18-3772
F90	2003-10	18-3732	18-3789	18-3735	18-3772
F100	1999-03	18-3732	18-3789	18-3735	18-3772
115(6E5)(6N6)	1984-09	18-3726	18-4274	18-3735	18-3782
C115(6E5)	1991-00	18-3726	18-4274	18-3735	18-3782
P115(62A)	1993-96	18-3726	18-4274	18-3735	18-3782
130(6L1)(6N7)	1988-04	18-3726	18-4274	18-3735	18-3782
L130(6L6)(6N4)	1989-01	18-3726	18-4274	18-3735	18-3782
150(6G4)(6R2)	1984-09	18-3726	18-4274	18-3735	18-3782
PRO V 150, (6J9)(6N9)	1986-90	18-3726	18-4274	18-3735	18-3782
P150(6N9)	1991-99	18-3726	18-4274	18-3735	18-3782
L150(6RO)	1986-99	18-3726	18-4274	18-3735	18-3782
175(6G5)(6R3)	1984-00	18-3726	18-4274	18-3735	18-3782
P175(62H)	1994-99	18-3726	18-4274	18-3735	18-3782
200(6G6)(6R4)	1984-95	18-3726	18-4274	18-3735	18-3782
L200(6K1)(6R1)	1987-99	18-3726	18-4274	18-3735	18-3782
P200(61H)	1991-99	18-3726	18-4274	18-3735	18-3782
225(6R5)(62J)	1990-97	18-3726	18-4274	18-3735	18-3782
L225(62K)	1994-99	18-3726	18-4274	18-3735	18-3782
250(61A)	1990-95	18-3726	18-4274	18-3735	18-3782
L250(61B)	1990-99	18-3726	18-4274	18-3735	18-3782
V6 SPECIAL(6G7)	1984-86	18-3726	18-4274	18-3735	18-3782
V6 EXCEL(6K7)	1987-89	18-3726	18-4274	18-3735	18-3782

① Items ending in "D" are Display Packaged - Regular number is Non-Display
② This product is priced per piece. To order price per package, please add -9 to the part number.

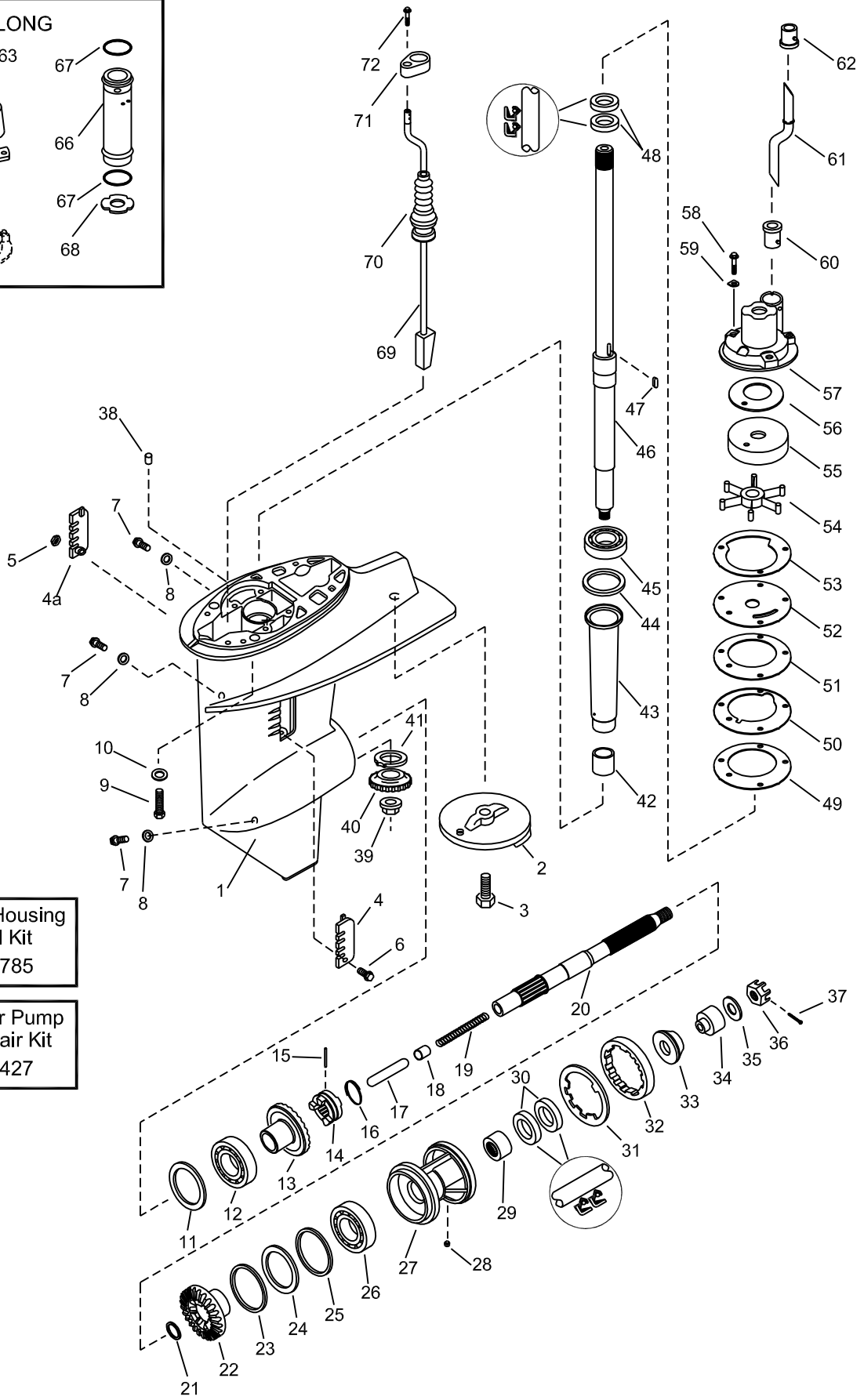
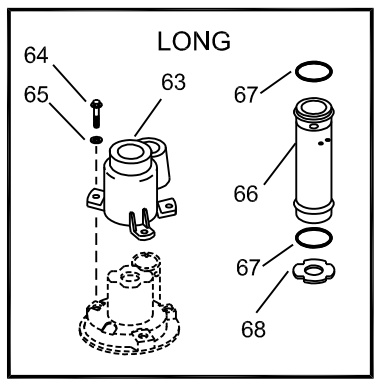

Figure #	Description	Part #	O.E.M. #	Qty.	Figure #	Description	Part #	O.E.M. #	Qty.
1	Housing, Gearcase	—	689-45311-04-EK3	1	37	Cotter Pin	18-2380	91490-30030-00	
2	Trim Tab	18-6096A, 18-6113	664-45371-01-00	1	38	Pin, Dowel	—	93606-12019-00	2
					39	Nut, Pinion	—	90179-09M02-00	2
3	Bolt, Trim Tab	—	90105-08M02-00	1	40	Gear, Pinion	—	689-45551-00-00	1
4	Cover, Water Inlet (port)	—	689-45214-01-01	1	41	Bearing, Thrust	—	664-45552-09-00	1
4a	Cover, Water Inlet (stbd)	—	689-45215-01-00	1	42	Bearing, Pinion	—	93315-017U4-00	1
5	Nut, Nylock	—	90185-05904-00	1	43	Sleeve, Drive Shaft	—	689-45536-00-00	1
6	Bolt, Water Inlet	—	98680-05525-00	1	44	Shim Pinion Gear (0.5mm)	—	664-45587-00-05	AR
7	Plug, Drain & Vent	—	90340-08M04-00	3		Shim Pinion Gear (0.8mm)	—	664-45587-00-08	AR
8	Gasket, Plug	—	90430-08020-00	3		Shim Pinion Gear (0.12mm)	—	664-45587-01-12	AR
9	Bolt, Gearcase Mounting	—	90105-10059-00	2		Shim Pinion Gear (0.30mm)	—	664-45587-01-30	AR
10	Washer, Gearcase Mounting	—	92990-10600-00	4		Shim Pinion Gear (0.50mm)	—	664-45587-01-50	AR
11	Shim Forward Gear (0.5mm)	—	664-45567-00-05	AR	45	Bearing, Drive Shaft	—	93332-000U4-00	1
	Shim Forward Gear (0.8mm)	—	664-45567-00-08	AR	46	Drive Shaft (long)	—	689-45501-10-00	1
	Shim Forward Gear (0.12mm)	—	664-45567-01-12	AR	47	Key, Impeller	—	664-44338-00-00	1
	Shim Forward Gear (0.30mm)	—	664-45567-01-30	AR	48	Oil Seal, Pump Base	18-0296	93101-22067-00	2
	Shim Forward Gear (0.50mm)	—	664-45567-01-50	AR	49	Gasket, Base	18-0773	689-44316-A0-00	1
12	Bearing, Forward Gear	—	93332-00005-00	1	50	Base, Water Pump	—	689-44325-02-5B	1
13	Gear, Forward	—	689-45560-00-00	1	51	Gasket, Base	18-0773	689-44316-A0-00	1
14	Clutch, Dog	—	664-45631-01-00	1	52	Impeller Plate	—	689-44323-03-00	1
15	Pin, Clutch Dog	—	90250-05010-00	1	53	Gasket, Impeller Plate	—	689-44324-A0-00	1
16	Ring, Cross Pin	—	648-45633-00-00	1	54	Impeller	18-3067	689-44352-02-00	1
17	Plunger, Shift	—	648-45635-00-00	1	55	Insert Cup	18-3439	689-W4432-02-00	1
18	Slide, Shift	—	648-45634-00-00	1	56	Damper, Water Seal	—	689-44367-01-00	1
19	Spring, Compression	—	90501-10065-00	1	57	Housing, Water Pump	—	689-44311-03-00	1
20	Shaft, Propeller	—	689-45611-00-00	1	58	Bolt, Pump Housing	—	90101-06M56-00	3
21	Thrust, Washer, Prop Shaft	—	90201-20417-00	1	59	Washer, Housing (short shaft)	—	90209-06M04-00	3
22	Gear, Reverse	—	689-45571-00-00	1	60	Seal, Lower Water Tube	—	626-44365-01-00	1
23	Shim Reverse Gear (0.5mm)	—	664-45577-00-05	AR	61	Water Tube (long shaft)	—	689-44361-10-00	1
	Shim Reverse Gear (0.8mm)	—	664-45577-00-08	AR	62	Seal, Upper Water Tube	18-0552	689-44366-00-00	1
	Shim Reverse Gear (0.12mm)	—	664-45577-01-12	AR	63	Extension, Housing (long shaft)	—	689-44312-00-5B	1
	Shim Reverse Gear (0.30mm)	—	664-45577-01-30	AR	64	Bolt, Extension (long shaft)	—	97080-06035-00	3
	Shim Reverse Gear (0.50mm)	—	664-45577-01-50	AR	65	Washer, Bolt (long shaft)	—	92990-06600-00	3
24	Washer Thrust	—	664-45576-00-00	1	66	Extension Tube (long shaft)	—	689-44362-00-94	1
25	O-Ring, Bearing Carrier	—	93210-30MA3-00	1	67	O-Ring, Extension Tube	—	93210-26240-00	2
26	Bearing, Reverse Gear	—	93306-00612-00	1	68	Plate (long shaft)	—	689-44328-03-00	1
27	Bearing, Carrier	—	689-45331-01-94	1	69	Shift Cam Assembly (short shaft)	—	664-44150-01-00	1
28	Key, Bearing Carrier	—	90282-04010-00	1	69	Shift Cam Assembly (long shaft)	—	664-44150-11-00	1
29	Bearing, Prop Shaft	—	93315-22004-00	1	70	Boot, Shift Rod	—	664-44147-00-00	1
30	Seal, Prop Shaft	18-0554	93101-20M07-00	2	71	Bracket, Shift Shaft	—	689-44176-01-00	1
31	Tab Washer	—	90214-45M02-00	1	72	Screw, Bracket	—	97780-50610-00	1
32	Nut, Cover	—	664-45384-00-00	1	73	Gear Housing Seal Kit	18-2785	689-W0001-22-00	1
33	Prop Spacer (fore)	—	664-45987-01-00	1	74	Water Pump Repair Kit	18-3427	689-W0078-A6-00	1
34	Prop Spacer (aft)	—	689-45997-00-00	1					
35	Washer, Prop Mounting	—	92990-14200-00	1					
36	Nut, Propeller	—	90171-14013-00	1					

AR As required

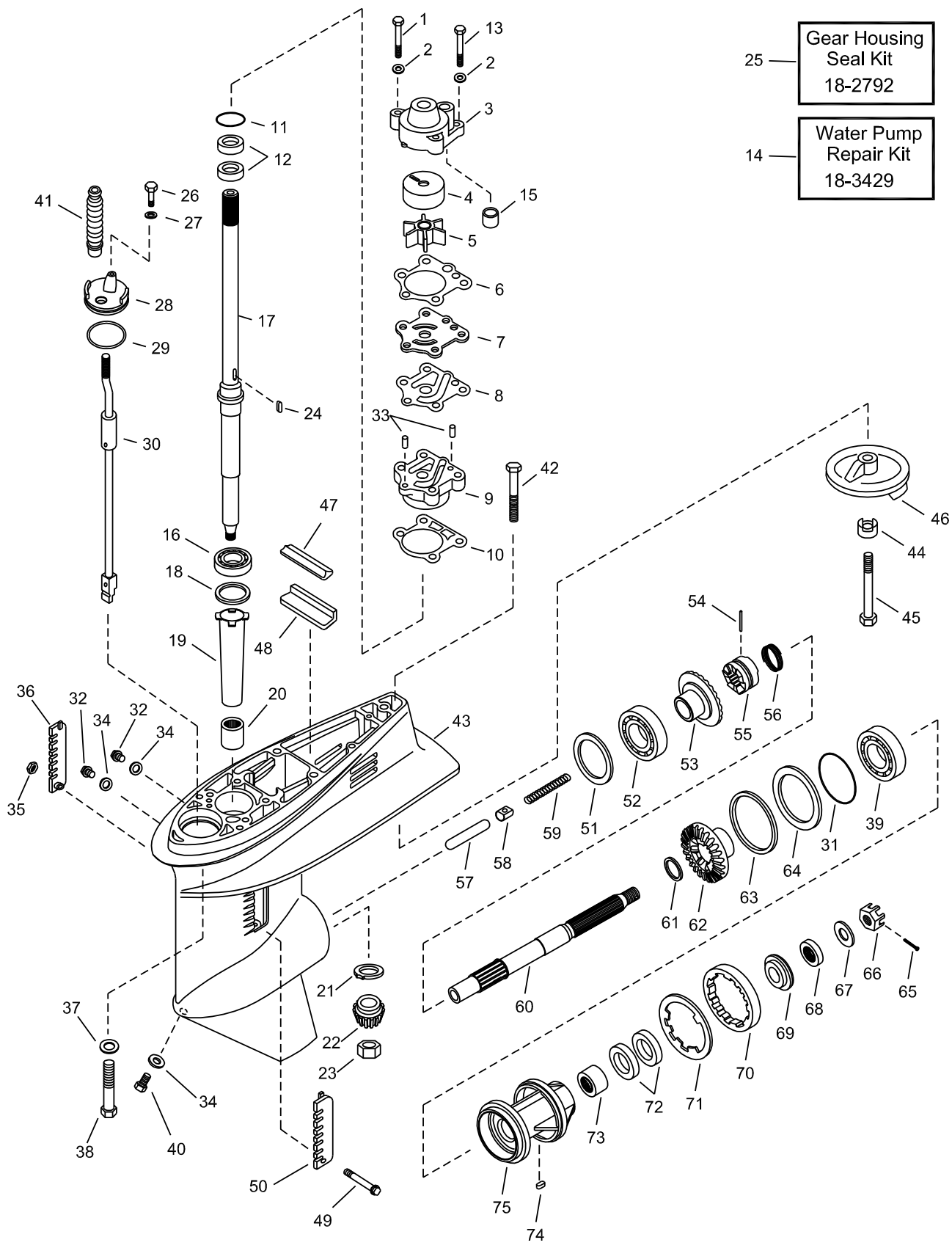
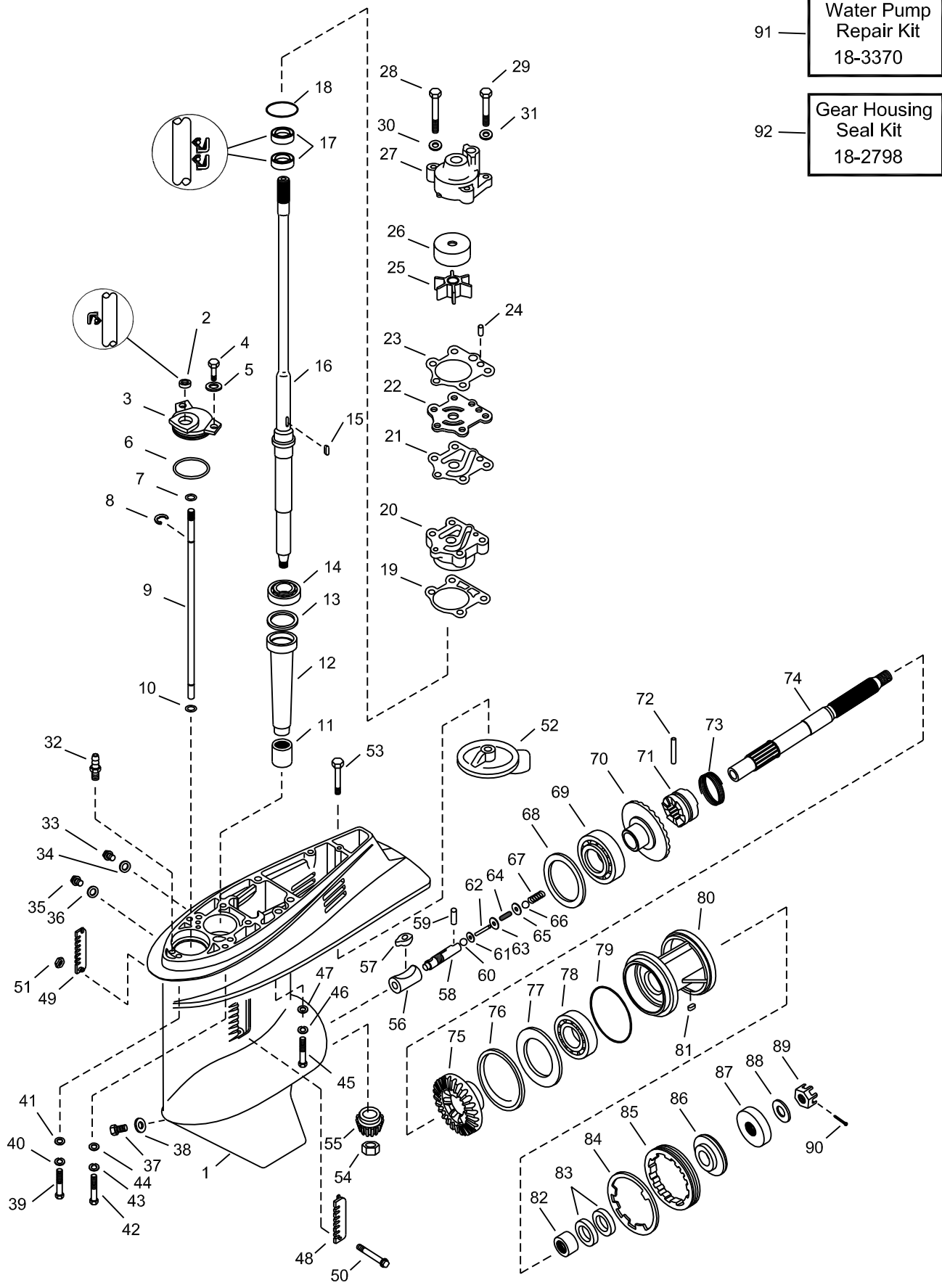

Figure #	Description	Part #	O.E.M. #	Qty.	Figure #	Description	Part #	O.E.M. #	Qty.
1	Bolt, Water Pump Housing	—	97395-08055-00	2	39	Bearing, Ball	—	93306-00702-00	1
2	Washer, Water Pump Housing	—	92990-08600-00	4	40	Plug, Drain	18-2374	688-45341-00-00	1
3	Housing, Water Pump	—	663-44311-02-00	1	41	Propeller	—	various	1
4	Insert, Water Pump	18-3435	663-44322-00-00	1	42	Bolt, Trim Tab	—	97575-08675-00	1
5	Impeller	18-3068	6H4-44352-02-00	1	43	Casing, Lower	—	6H4-45301-01-EK	1
6	Gasket, Wear Plate to Water Pump	18-0292	663-44315-A0-00	1	44	Washer, Locking	—	92990-08100-00	1
					45	Bolt, Lower Casing	—	97095-08085-00	1
7	Wear Plate, Water Pump	18-3436	663-44323-00-00	1	46	Tab, Trim	18-6096A	664-45371-01-00	1
8	Gasket, Wear Plate to Water Pump	18-0294	663-44324-A0-00	1	47	Seal Rubber	—	688-45375-00-00	1
					48	Guide, Seal Rubber	—	663-45376-00-94	1
9	Base, Water Pump	—	663-44341-00-94	1	49	Screw Ovalhead	—	98780-05535-00	1
10	Gasket, Pump Base	—	663-44316-A0-00	1	50	Cover, Water Inlet (port)	—	668-45214,02-00	1
11	O-Ring, Pump Base	18-0298	93210-41042-00	1	51	Shim Forward Gear (0.5mm)	—	6H4-45567-00-05	1
12	Oil Seal, Pump Base	18-0297	93101-23070-00	2		Shim Forward Gear (0.8mm)	—	6H4-45567-00-08	AR
13	Bolt, Water Pump Housing	18-0256	97095-08045-00	2		Shim Forward Gear (0.12mm)	—	6H4-45567-01-12	AR
14	Water Pump Repair Kit	18-3429	6H4-W0078-00-00	1		Shim Forward Gear (0.30mm)	—	6H4-45567-01-30	AR
15	Water Seal	—	663-44366-00-00	1		Shim Forward Gear (0.50mm)	—	6H4-45567-01-50	AR
16	Bearing, Tapered Roller	—	93332-00079-00	1	52	Bearing, Tapered Roller	—	93332-000V4-00	1
17	Drive Shaft (Short)	—	6H4-45501-00-00	1	53	Gear, Forward	—	6H4-45560-00-00	1
17	Drive Shaft (Long)	—	6H4-45501-10-01	1	54	Pin, Cross (clutch dog)	—	90250-06023-00	1
18	Shim (0.5mm)	—	663-45587-00-05	AR	55	Clutch, Sliding	—	663-45631-01-00	1
	Shim (0.8mm)	—	663-45587-00-08	AR	56	Retainer Ring, Cross Pin	—	663-45633-00-00	1
	Shim (0.12mm)	—	663-45587-01-12	AR	57	Plunger, Shift	—	676-45635-00-00	1
	Shim (0.30mm)	—	663-45587-01-30	AR	58	Slide, Shift	—	663-45634-00-00	1
	Shim (0.50mm)	—	663-45587-01-50	AR	59	Spring, Compression	—	60501-16M01-00	1
19	Sleeve, Drive Shaft	—	6H4-45536-00-0	1	60	Shaft, Propeller	18-2247	679-45611-01-00	1
20	Bearing, Needle	—	93315-32224-00	1	61	Washer, Plate	—	90201-22429-00	1
21	Bearing (not used 1988 & later)	—	663-45552-00-00	1	62	Gear, Reverse	—	6H4-45571-00-00	1
22	Gear, Pinion	—	6H4-45551-00-00	1	63	Shim Reverse Gear (0.5mm)	—	663-45577-00-05	AR
23	Nut, Pinion Gear	—	90170-12138-00	1		Shim Reverse Gear (0.8mm)	—	663-45577-00-08	AR
24	Key, Woodruff	18-3305	90280-03024-00	1		Shim Reverse Gear (0.12mm)	—	663-45577-01-12	AR
25	Gearcase Seal Kit	18-2792	6H4-W0001-20-00	1		Shim Reverse Gear (0.30mm)	—	663-45577-01-30	AR
26	Bolt, Plate	—	97095-06016-00	1		Shim Reverse Gear (0.50mm)	—	663-45577-01-50	AR
27	Washer, Plate	—	92990-06600-00	1	64	Washer, Thrust	—	663-45576-00-00	1
28	Plate	—	6H4-45321-01-00	1	65	Pin, Cotter	18-2380	91490-30030-00	1
29	O-Ring, Plate	—	93210-49046-00	1	66	Nut, Castle	18-3732	90171-16011-11	1
30	Shift Cam Assembly (short shaft)	—	6H4-44150-01-00	1	67	Washer	—	92990-16200-00	1
	Shift Cam Assembly (long shaft)	—	6H4-44150-12-01	1	68	Spacer, Prop Mounting (aft)	—	670-45997-02-00	1
31	O-Ring, Bearing Housing	18-0299	93210-66M98-00	1	69	Spacer, Prop Mounting (fore)	—	663-45987-02-00	1
32	Plug, Vent	—	90340-08M04-00	2	70	Nut, Cover	—	697-45385-00-00	1
33	Pin, Dowel	—	93604-08062-00	2	71	Washer, Tab	—	90214-48M03-00	1
34	Gasket, Drain Plug	—	90430-08020-00	3	72	Oil Seal, Bearing Housing	18-0296	93101-22067-00	2
35	Nut, Nylock	—	90185-05904-00	1	73	Bearing, Needle	—	93317-22204-00	1
36	Cover, Water Inlet (stbd)	—	688-45215-02-00	1	74	Key, Bearing Housing	—	90282-04010-00	1
37	Washer, Locking	—	92990-10100-00	4	75	Housing, Bearing	—	679-45331-00-94	1
38	Bolt	—	97078-10040-00	4					

AR As required



91 — Water Pump
Repair Kit
18-3370

92 — Gear Housing
Seal Kit
18-2798

Figure #	Description	Part #	O.E.M. #	Qty.	Figure #	Description	Part #	O.E.M. #	Qty.
1	Gearcase	—	6H1-45301-04-EK	1	50	Screw, Water Inlet	—	98680-05545-00	1
2	Oil Seal, Shift Shaft	18-0267	93106-09014-00	1	51	Nut, Water Inlet	—	90185-05002-00	1
3	Plate, Shift Rod	—	688-45321-00-00	1	52	Trim Tab	18-6070	988-45371-02-00	1
4	Bolt, Shift Rod Retainer	—	97395-06016-00	2	53	Bolt, Anode Mounting	—	90105-10M00-00	1
5	Washer	—	92990-06600-00	2	54	Nut, Pinion	—	90170-16M01-00	1
6	O-Ring	—	93210-49046-00	1	55	Gear, Pinion	—	688-45551-01-00	1
7	O-Ring	—	93210-07540-01	1	56	Shifter	—	6H1-45641-01-00	1
8	Circlip	—	99001-08600-00	1	57	Shift Cam	—	6H1-44151-00-00	1
9	Rod, Shift	—	6H1-44144-00-00	1	58	Shift Slide	—	6H1-45634-02-00	1
10	Circlip	—	93450-07M00-00	1	59	Pin	—	93603-12M11-00	1
11	Bearing, Pinion	—	93315-325V1-00	1	60	Nut, Spring	—	90183-02M03-00	1
12	Sleeve, Drive shaft	—	688-45536-01-00	1	61	Shift Plunger	—	6H1-45635-00-00	1
13	Shim Drive Shaft (0.10mm)	—	688-45587-01-10	AR	62	Shaft	—	6H1-45668-00-00	1
	Shim Drive Shaft (0.12mm)	—	688-45587-01-12	AR	63	Shift Plunger	—	6H1-45635-00-00	1
	Shim Drive Shaft (0.15mm)	—	688-45587-01-15	AR	64	Spring, Compression	—	90501-12M48-00	1
	Shim Drive Shaft (0.18mm)	—	688-45587-01-30	AR	65	Washer, Plate	—	90201-03313-00	1
	Shim Drive Shaft (0.30mm)	—	688-45587-01-40	AR	66	Nut, Spring	—	90183-02M03-00	1
	Shim Drive Shaft (0.40mm)	—	688-45587-01-50	AR	67	Spring, Compression	—	90501-16M65-00	1
	Shim Drive Shaft (0.50mm)	—	688-45587-01-16	AR	68	Shim Forward Gear (0.10mm)	—	688-45567-01-10	AR
14	Bearing, Upper Drive Shaft	—	93332-000U3-00	1		Shim Forward Gear (0.12mm)	—	688-45567-01-12	AR
15	Key, Impeller	18-3301	90280-04M04-00	1		Shim Forward Gear (0.15mm)	—	688-45567-01-15	AR
16	Drive Shaft	—	6H1-45501-11-00	1		Shim Forward Gear (0.18mm)	—	688-45567-01-18	AR
17	Oil Seal, Pump Base	18-0587	93101-25M03-00	2		Shim Forward Gear (0.30mm)	—	688-45567-01-30	AR
18	O-Ring, Base	18-7436	9321-46044-00	1		Shim Forward Gear (0.40mm)	—	688-45567-01-40	AR
19	Gasket, Base	18-0240	688-44316-A0-00	1		Shim Forward Gear (0.50mm)	—	688-45567-01-50	AR
20	Base, Water Pump	—	688-44341-01-94	1	69	Bearing, Forward Gear	—	93332-000W7-00	1
21	Gasket, Wear Plate to Base	—	688-44324-A0-00	1	70	Gear, Forward	—	688-45560-00-00	1
22	Wear Plate	18-3341	688-44323-00-00	1	71	Clutch, Dog	—	6H1-45631-01-00	1
23	Gasket, Wear Plate to Housing	18-0239	688-44315-A0-00	1	72	Pin, Cross	—	90250-07M02-00	1
24	Pin	—	93604-10M03-00	1	73	Spring, Cross Pin	—	688-45633-00-00	1
25	Impeller	18-3070	688-44352-03-00	1	74	Shaft, Propeller	—	6H1-45611-01-00	1
26	Insert, Water Pump	—	688-44322-00-00	1	75	Gear, Reverse	—	6H1-45571-00-00	1
27	Housing, Water Pump	18-3171	688-44311-01-00	1	76	Shim Reverse Gear (0.10mm)	—	688-45577-01-10	AR
28	Bolt, Water Pump	—	97395-08070-00	2		Shim Reverse Gear (0.12mm)	—	688-45577-01-12	AR
29	Bolt, Water Pump	—	97395-08050-00	2		Shim Reverse Gear (0.15mm)	—	688-45577-01-15	AR
30 &						Shim Reverse Gear (0.18mm)	—	688-45577-01-18	AR
31	Washer, Water Pump	—	90209-08M02-00	4		Shim Reverse Gear (0.30mm)	—	688-45577-01-30	AR
32	Nipple, Hose	—	6E5-45378-00-00	1		Shim Reverse Gear (0.40mm)	—	688-45577-01-40	AR
33	Plug, Drain	18-2371	90340-08M04-00	1		Shim Reverse Gear (0.50mm)	—	688-45577-01-50	AR
34	Gasket, Vent & Drain Plugs	18-46981-9	90430-08020-00	1	77	Washer, Thrust	—	688-45576-00-00	1
35	Plug, Drain	18-2371	90340-08M04-00	1	78	Bearing, Reverse Gear	—	93306-207U0-00	1
36	Gasket, Vent & Drain Plugs	18-46981-9	90430-08020-00	1	79	O-Ring, Bearing Housing	—	93210-85M97-00	1
37	Plug, Drain	18-2374	688-45341-00-00	1	80	Housing, Bearing	18-2782	688-45331-00-94	1
38	Gasket, Vent & Drain Plugs	18-46981-9	90430-08020-00	1	81	Key	—	90282-04010-00	1
39	Bolt	—	97395-10040-00	2	82	Bearing, Needle	—	93317-325U0-00	1
40	Washer, Lock	—	92990-10100-00	2	83	Oil Seal	18-0587	93101-25M03-00	2
41	Washer, Flat	—	92990-10600-00	2	84	Washer, Tab	—	688-45383-02-00	1
42	Bolt	—	97395-10040-00	2	85	Nut, Cover	—	688-45384-00-00	1
43	Washer, Lock	—	92990-10100-00	2	86	Spacer, Forward	—	688-45987-01-00	1
44	Washer, Flat	—	92990-10600-00	2	87	Spacer	18-4274	688-45997-01-00	1
45	Bolt	—	97395-08060-00	1	88	Washer, Propeller	—	90201-17M00-00	1
46	Washer, Lock	—	92990-08100-00	1	89	Nut, Castle	18-3732	90171-16011-00	1
47	Washer, Lock	—	92990-08100-00	1	90	Pin, Cotter	18-3735	91490-40030-00	1
48	Cover, Water Inlet (Port)	—	688-45214-02-00		91	Water Pump Repair Kit	18-3370	692-W0078-00-00	1
49	Cover, Water Inlet (Stbd)	—	688-45215-02-00	1	92	Gear Housing Seal Kit	18-2798	688-W0001-20-00	1

AR As required

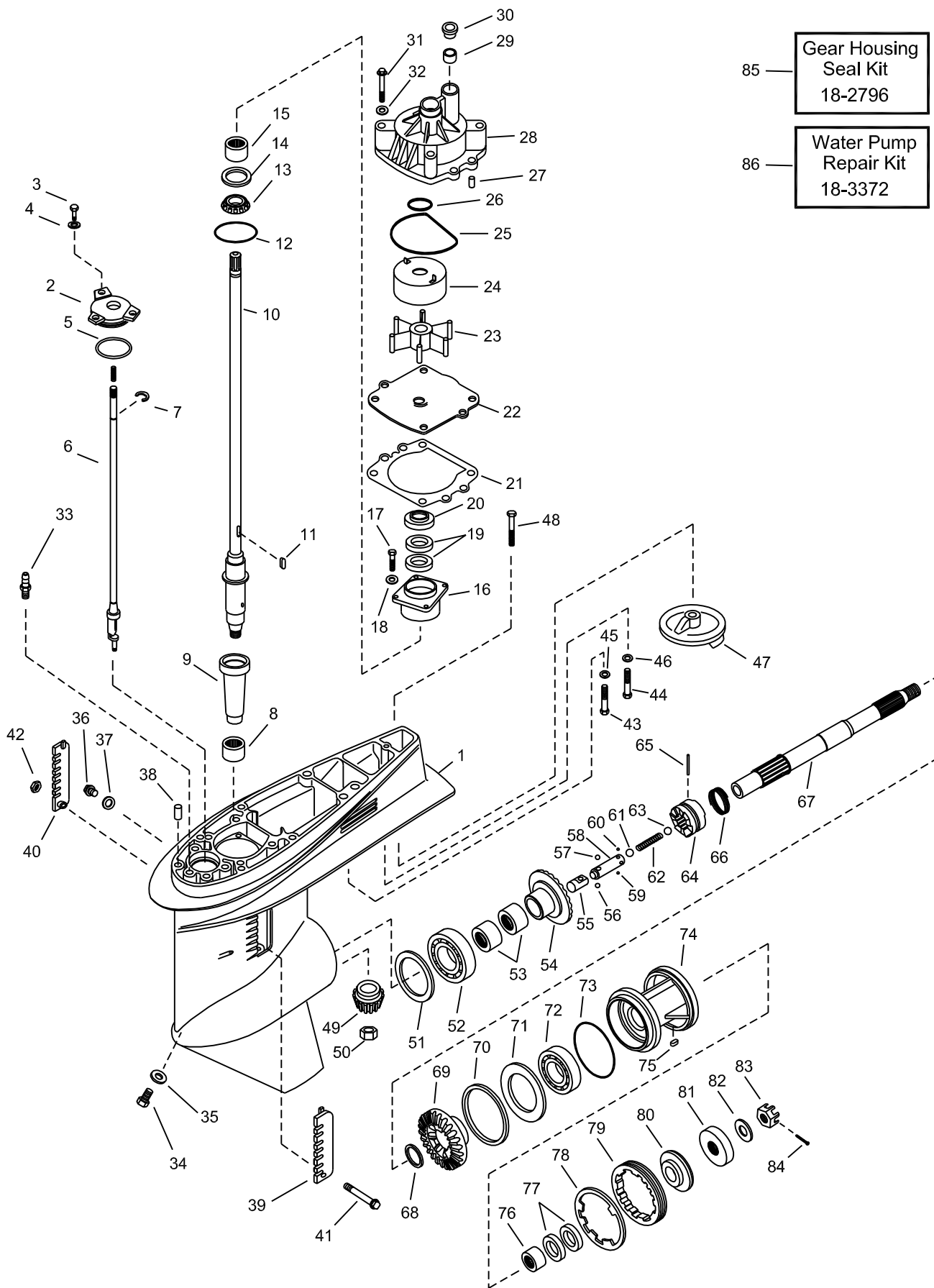

Figure #	Description	Part #	O.E.M. #	Qty.	Figure #	Description	Part #	O.E.M. #	Qty.
1	Housing, Gearcase	—	6E5-45301-03EK	1	47	Trim Tab	18-6097A	6E5-45371-01-00	1
2	Plate, Shift Rod Cover	—	6E5-45321-00-00	1	48	Bolt, Trim Tab	—	90105-10M00-00	1
3	Bolt, Shift Rod Cover	—	97395-06020-00	3	49	Gear Pinion	—	6E5-45551-02-00	1
4	Washer	—	90209-06M04-00	3	50	Nut, Pinion	—	90170-16M01-00	1
5	O-Ring, Plate	—	93210-5867-00	1	51	Shim (0.10mm)	—	6E5-45567-01-10	AR
6	Shift Rod Assembly	—	6E5-44150-01-00	1		Shim (0.12mm)	—	6E5-45567-01-12	AR
7	Circlip	—	99001-08600-00	1		Shim (0.15mm)	—	6E5-45567-01-15	AR
8	Bearing, Needle	—	93315-628U9-00	1		Shim (0.18mm)	—	6E5-45567-01-18	AR
9	Sleeve, Drive Shaft	—	6E5-45536-00-00	1		Shim (0.30mm)	—	6E5-45567-01-30	AR
10	Drive Shaft (long)	—	6E5-45501-01-00	1		Shim (0.40mm)	—	6E5-45567-01-40	AR
	Drive Shaft (x-long)	—	6E5-45501-21-00	1		Shim (0.50mm)	—	6E5-45567-01-50	AR
11	Key, Impeller	—	90280-04M05-00	1	52	Bearing, Forward Gear	—	93332-000U7-00	1
12	O-Ring, Housing	—	93210-54534-00	1	53	Bearing, Needle	—	93315-425U7-00	2
13	Bearing, Tapered	—	93341-930U0-00	1	54	Gear, Forward	—	6E5-45560-01-00	1
14	Shim (0.10mm)	—	6E5-45587-01-10	AR	55	Shifter	—	6E5-45641-01-00	1
	Shim (0.12mm)	—	6E5-45587-01-12	AR	56	Ball, Detent	—	93507-32031-00	1
	Shim (0.15mm)	—	6E5-45587-01-15	AR	57	Ball, Detent	—	93507-32031-00	1
	Shim (0.18mm)	—	6E5-45587-01-18	AR	58	Slide, Shift	—	6E5-45634-01-00	1
	Shim (0.30mm)	—	6E5-45587-01-30	AR	59	Ball, Detent	—	93503-16010-00	1
	Shim (0.40mm)	—	6E5-45587-01-40	AR	60	Ball, Detent	—	93503-16010-00	1
	Shim (0.50mm)	—	6E5-45587-01-50	AR	61	Ball, Detent	—	93511-32027-00	1
15	Bearing, Needle	—	93315-430V5-00	1	62	Spring, Compression	—	90501-16M37-00	1
16	Housing, Bearing	—	6E5-45331-0094	1	63	Ball, Detent	—	93511-32027-00	1
17	Bolt, Bearing Housing	—	97395-08025-00	4	64	Clutch, Dog	—	6R5-45631-01-00	1
18	Washer	—	92990-08600-00	4	65	Cross Pin, Clutch	—	90250-08M07-00	1
19	Seal, Drive Shaft	18-0265	93101-28M16-00	2	66	Retainer, Cross Pin	—	6E5-45631-01-00	1
20	Cover, Oil Seal	—	6E5-45344-00-00	1	67	Shaft, Propeller	18-2385	6E5-45611-01-00	1
21	Gasket, Wear Plate	18-0244	6E5-44315-A0-00	1	68	Washer, Thrust	—	90201-30M92-00	1
22	Wear Plate	18-3344	6G5-44323-00-00	1	69	Gear, Reverse	—	6E5-45571-04-00	1
23	Impeller	18-3071	6E5-44352-00-00	1	70	Shim (0.10mm)	—	6L6-45577-00-10	AR
24	Insert, Water Pump	—	6E5-44322-00-00	1		Shim (0.12mm)	—	6L6-45577-00-12	AR
25	O-Ring, Water Pump	18-7485	93210-86M38-00	1		Shim (0.15mm)	—	6L6-45577-00-15	AR
26	O-Ring, Water Pump	18-7483	93210-37M67-00	1		Shim (0.18mm)	—	6L6-45577-00-18	AR
27	Pin, Water Pump Housing	—	93606-12019-00	2		Shim (0.30mm)	—	6L6-45577-00-30	AR
28	Housing, Water Pump	18-3170	6E5-44311-00-00	1		Shim (0.40mm)	—	6L6-45577-00-40	AR
29	Damper, Water Seal	—	6E5-44365-00-00	1		Shim (0.50mm)	—	6L6-45577-00-50	AR
30	Cover, Pump Housing	—	6E5-44312-00-0	1	71	Washer, Thrust	—	6E5-45576-00-00	1
31	Bolt, Water Pump	—	97080-08045-00	4	72	Bearing, Reverse Gear	—	93306-208U0-00	1
32	Washer	—	90209-08M02-00	4	73	O-Ring, Bearing Housing	—	93210-86M39-00	1
33	Nipple, Hose	—	6E5-45378-00-00	1	74	Housing, Bearing	—	6E5-45332-00-94	1
34	Drain, Plug Lower	18-2374	688-45341-00-00	1	75	Key, Bearing Housing	—	90282-04010-00	1
35	Gasket, Drain Plug	18-4698	90430-08020-00	1	76	Bearing, Needle	—	93315-430U8-00	1
36	Drain Plug Upper	—	90340-08M04-00	1	77	Seal, Prop Shaft	18-0266	93101-30M17-00	2
37	Gasket, Drain Plug	18-4698	90430-08020-00	1	78	Washer, Tab	—	688-45383-02-00	1
38	Pin, Locating	—	93608-12M05-00	2	79	Nut, Cover	—	688-45384-00-00	1
39	Cover, Water Inlet (Port)	—	688-45214-02-00	1	80	Washer, Thrust	—	6E5-45987-01-00	1
40	Cover, Water Inlet (Stbd)	—	688-45215-02-00	1	81	Spacer, Prop	18-4274	688-45997-01-00	1
41	Screw, Water Inlet	—	90142-05M03-00	1	82	Washer, Prop	—	92990-18200-00	1
42	Nut, Water Inlet	—	90185-05002-00	1	83	Nut, Prop	18-3726	90171-18M04-00	1
43	Bolt	—	97395-10070-00	1	84	Pin, Cotter	18-3735	91490-40030-00	1
44	Bolt	—	97395-10070-00	1	85	Gear Housing Seal Kit	18-2796	6E5-W0001-51-00	1
45	Washer	—	92990-10100-00	1	86	Water Pump Repair Kit	18-3372	6E5-W0078-00-00	1
46	Washer	—	92990-10100-00	1					

AR As required

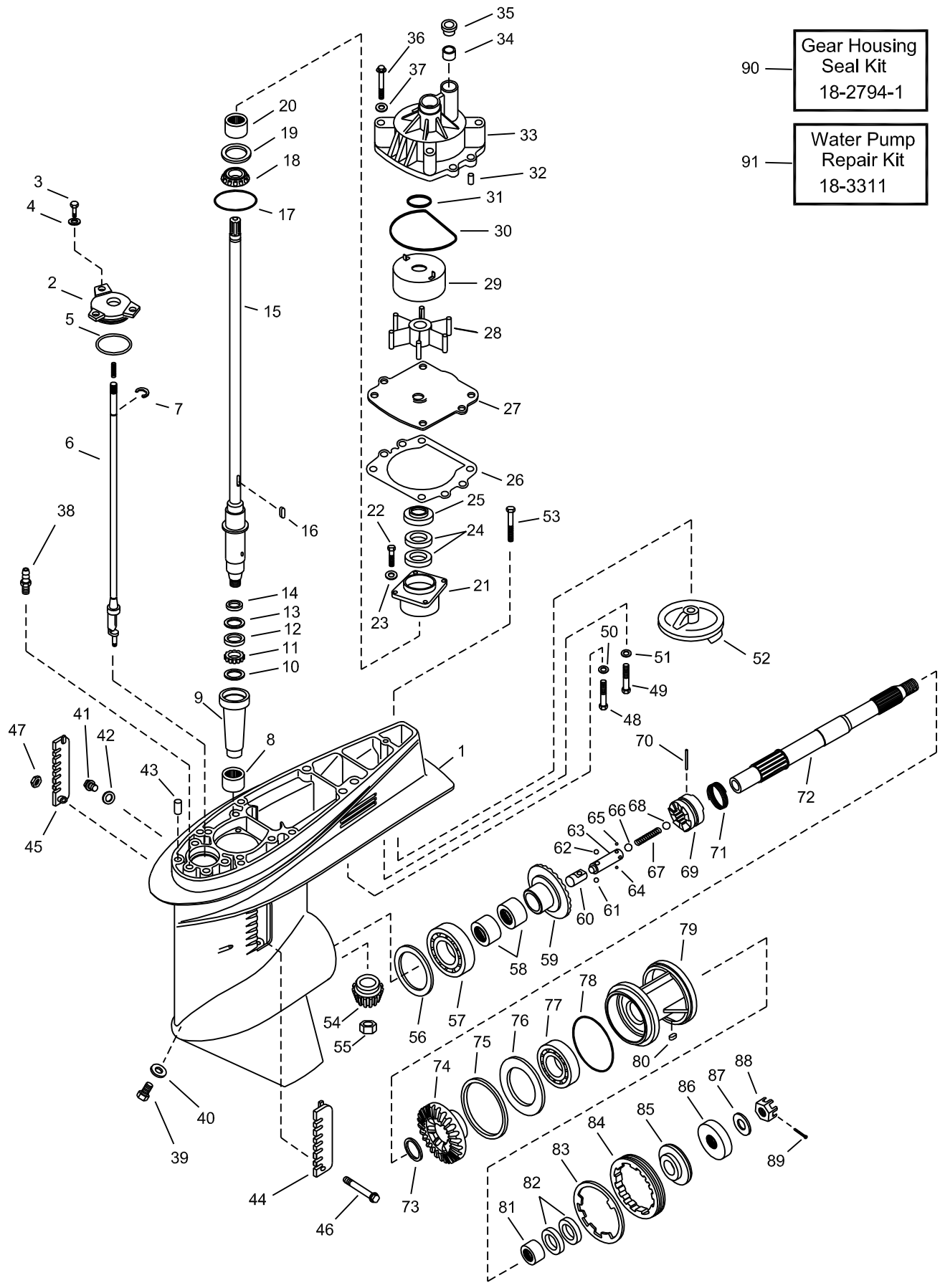
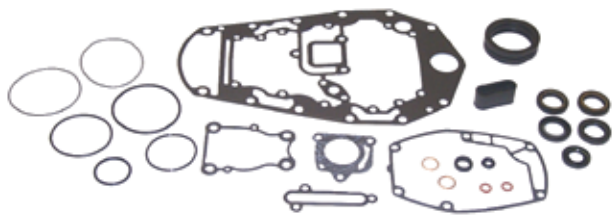

Figure #	Description	Part #	O.E.M. #	Qty.	Figure #	Description	Part #	O.E.M. #	Qty.
1	Housing, Gearcase	—	6J9-45301-02-Ek	1	49	Bolt	—	97395-10070-00	1
2	Plate, Shift Rod Cover	—	6E5-45321-00-00	1	50	Washer	—	92990-10100-00	1
3	Bolt, Shift Rod Cover	—	97395-06020-00	3	51	Washer	—	92990-10100-00	1
4	Washer	—	90209-06M04-00	3	52	Trim Tab	18-6035	6J9-45371-01-00	1
5	O-Ring, Plate	—	93210-58677-00	1	53	Bolt, Trim Tab	—	90105-10M00-00	1
6	Shift Rod Assembly	—	6G5-44150-01-00	1	54	Gear Pinion	—	6G5-45551-01-00	1
7	Circlip	—	99001-08600-00	1	55	Nut, Pinion	—	90170-16M01-00	1
8	Bearing, Needle	—	90250-08M07-00	1	56	Shim (0.10mm)	—	6G5-45567-01-10	AR
9	Sleeve, Drive Shaft	—	6G5-45536-01-00	1		Shim (0.12mm)	—	6G5-45567-01-12	AR
10	Washer	—	90209-33M13-00	1		Shim (0.15mm)	—	6G5-45567-01-15	AR
11	Spring, Compression	—	90501-05M64-00	AR		Shim (0.18mm)	—	6G5-45567-01-30	AR
12	Collar	—	90387-33M00-00	1		Shim (0.30mm)	—	6G5-45567-01-40	AR
13	Washer	—	90209-33M13-00	1		Shim (0.40mm)	—	6G5-45567-01-50	AR
14	Washer	—	90209-33M12-00	1		Shim (0.50mm)	—	6G5-45567-01-10	AR
15	Drive Shaft (long)	—	6G5-45501-01-00	1	57	Bearing, Forward Gear	—	93332-00V3-00	1
	Drive Shaft (x-long)	—	6G5-45501-21-00	1	58	Bearing, Needle	—	93315-425V3-00	2
16	Key, Impeller	—	90280-04M05-00	1	59	Gear, Forward	—	6G5-45631-00-00	1
17	O-Ring, Housing	—	93210-54534-00	1	60	Shifter	—	6E5-45641-01-00	1
18	Bearing, Tapered	—	93341-930U0-00	1	61	Ball, Detent	—	93507-32031-00	1
19	Shim (0.10mm)	—	6E5-45587-01-10	AR	62	Ball, Detent	—	93507-32031-00	1
	Shim (0.12mm)	—	6E5-45587-01-12	AR	63	Slide, Shift	—	6E5-45634-01-00	1
	Shim (0.15mm)	—	6E5-45587-01-15	AR	64	Ball, Detent	—	93503-16010-00	1
	Shim (0.18mm)	—	6E5-45587- 01-18	AR	65	Ball, Detent	—	93503-16010-00	1
	Shim (0.30mm)	—	6E5-45587-01-30	AR	66	Ball, Detent	—	93511-32027-00	1
	Shim (0.40mm)	—	6E5-45587-01-40	AR	67	Spring, Compression	—	90501-16M37-00	1
	Shim (0.50mm)	—	6E5-45587-01-50	AR	68	Ball, Detent	—	93511-32027-00	1
20	Bearing, Needle	—	93315-430V5-00	1	69	Clutch, Dog	—	6E5-45633-01-00	1
21	Housing, Bearing	—	6E5-45331-00-94	1	70	Cross Pin, Clutch	—	90250-08M07-00	1
22	Bolt, Bearing Housing	—	97395-08025-00	4	71	Retainer, Cross Pin	—	6E5-45633-01-00	1
23	Washer	—	92990-08600-00	4	72	Shaft, Propeller	—	6J9-45611-01-00	1
24	Seal, Drive Shaft	18-0265	93101-28M16-00	2	73	Washer, Thrust	—	90201-30M92-00	1
25	Cover, Oil Seal	—	6E5-45344-00-00	1	74	Gear, Reverse	—	6G5-45571-02-00	1
26	Gasket, Wear Plate	18-0244	6E5-44315-A0-00	1	75	Shim (0.10mm)	—	6G5-45577-02-10	AR
27	Wear Plate	18-3345	6G5-44323-00-00	1		Shim (0.12mm)	—	6G5-45577-02-12	AR
28	Impeller	18-3071	6E5-44352-00-00	1		Shim (0.15mm)	—	6G5-45577-02-15	AR
29	Insert, Water Pump	—	6E5-44322-00-00	1		Shim (0.18mm)	—	6G5-45577-02-18	AR
30	O-Ring, Water Pump	18-7485	93210-86M38-00	1		Shim (0.30mm)	—	6G5-45577-02-30	AR
31	O-Ring, Water Pump	18-7483	93210-37M67-00	1		Shim (0.40mm)	—	6G5-45577-02-40	AR
32	Pin, Water Pump Housing	—	93606-12019-00	2		Shim (0.50mm)	—	6G5-45577-02-50	AR
33	Housing, Water Pump	18-3170	6E5-44311-00-00	1	76	Washer, Thrust	—	6G5-45576-00-00	1
34	Damper, Water Seal	—	6E5-44365-00-00	1	77	Bearing, Reverse Gear	—	93306-209U0-00	1
35	Cover, Pump Housing	—	6E5-44312-00-00	1	78	O-Ring, Bearing Housing	18-0275	93210-97M55-00	1
36	Bolt, Water Pump	—	97080-08045-00	4	79	Bearing Housing Assembly	—	6J9-45332-00-94	1
37	Washer	—	90209-08M02-00	4	80	Key, Bearing Housing	—	90282-04010-00	1
38	Nipple, Hose	—	6E5-45378-00-00	1	81	Bearing, Needle	—	93315-430U8-00	1
39	Drain, Plug Lower	18-2374	688-45341-00-00	1	82	Seal, Prop Shaft	18-0266	93101-30M17-00	2
40	Gasket, Drain Plugs	—	90430-08020-00	2	83	Washer, Tab	—	9G5-45383-01-00	1
41	Drain Plug Upper	—	90340-08M04-00	1	84	Nut, Cover	—	6G5-45384-00-00	1
42	Gasket, Drain Plugs	—	90430-08020-00	2	85	Washer, Thrust	—	6E5-45987-00-00	1
43	Pin, Locating	—	93608-12M05-00	2	86	Spacer, Prop	18-4274	688-45997-01-00	1
44	Cover, Water Inlet (Port)	—	6J9-45214-00-00	1	87	Washer, Prop	—	92990-18200-00	1
45	Cover, Water Inlet (Stbd)	—	6J9-45215-00-00	1	88	Nut, Prop	18-3726	90171-18M04-00	1
46	Screw, Water Inlet	—	90142-05M04-00	1	89	Pin, Cotter	18-3735	91490-40030-00	1
47	Nut, Water Inlet	—	90185-05002-00	1	90	Gear Housing Seal Kit	18-2794-1	6G5-W0001-21-00	1
48	Bolt	—	97395-10070-00	1	91	Water Pump Repair Kit	18-3311	6G5-W0078-00-00	1

AR As required



18-0020
GEAR HOUSING SEAL KIT

Replaces: 67C-W0001-21-00
For: T25 (2001-02) / F30 (2002) F40 (2002) 3 cyl model
— CONTAINS —

Part #	Desc.	O.E.#	Qty.
18-0296	Seal, Propshaft	93101-22067	2



18-0021
GEAR HOUSING SEAL KIT

Replaces: 688-W0001-22-00
For: C75 (1994-99) / E75 (1995-00) / P75 (1996-99)
C80 (1997) / C85 (1992-96) / 90 (1992-02) B90(1998-99) / C90 (1997-01)
— CONTAINS —

Part #	Desc.	O.E.#	Qty.
18-0239	Gasket	688-44315-A0	1
18-0240	Gasket	688-44316-A0	1
18-0267	Oil Seal	93106-09014	1
18-0587	Oil Seal	93101-25M03	4
18-4698	Plug, Drain	90430-08020	2



18-0022
GEAR HOUSING SEAL KIT

Replaces: 689-W0001-23-00
For: C25 (1992-97) / C30 (1992)
— CONTAINS —

Part #	Desc.	O.E.#	Qty.
18-0296	Seal, Propshaft	93101-22067	2
18-0554	Seal	93101-20M07	2
18-7405	O-Ring	93210-40M10	1
18-0773	Gasket	689-44316-A0	1
18-4698	Plug, Drain	90430-08020	3



18-0023
GEAR HOUSING SEAL KIT

Replaces: 689-W0001-C2-00
For: C25 (1986-87) C25 (1990-91) 30 (1986) C30 (1990-91)
— CONTAINS —

Part #	Desc.	O.E.#	Qty.
18-0554	Seal	93101-20M07	2
18-7405	O-Ring	93210-40M10	1
18-0773	Gasket	689-44316-A0	1
18-4698	Plug, Drain	90430-08020	3



18-0024
GEAR HOUSING SEAL KIT

Replaces: 698-W0001-21-00
For: E48 (1995-00) / C55 (1989-94)
— CONTAINS —

Part #	Desc.	O.E.#	Qty.
18-0292	Gasket	663-44315-A0	1
18-0294	Gasket	663-44324-A0	1
18-0297	Seal, Drive Shaft	93101-23070	2
18-0296	Seal, Propshaft	93101-22067	2
18-0298	O-Ring	93210-41042	1
18-7160	O-Ring	93210-66M98	1
18-4698	Plug, Drain	90430-08020	3



18-0025
GEAR HOUSING SEAL KIT

Replaces: 69G-W0001-20-00
For: T 8 (2001-04)
— CONTAINS —

Part #	Desc.	O.E.#	Qty.
18-7442	O-Ring	93210-74M68	1
18-4698	Plug, Drain	90430-08020	2



18-0026
GEAR HOUSING SEAL KIT
 Replaces: 6A1-W0001-22-00
 For: 2HP (1986-88)

— CONTAINS —

Part #	Desc.	O.E.#	Qty.
18-4698	Plug, Drain	90430-08020	2



18-0027
GEAR HOUSING SEAL KIT
 Replaces: 6A1-W0001-23-00
 For: 2HP (1989-02)

— CONTAINS —

Part #	Desc.	O.E.#	Qty.
18-4698	Plug, Drain	90430-08020	2



18-0028
GEAR HOUSING SEAL KIT
 Replaces: 6E0-W0001-C1-00
 For: 4HP (1984-99) / F4 (1999-02) / 5HP (1984-02)

— CONTAINS —

Part #	Desc.	O.E.#	Qty.
18-4698	Plug, Drain	90430-08020	3



18-0029
GEAR HOUSING SEAL KIT
 Replaces: 6G1-W0001-C1-00
 For: 6HP (1986-96) 8HP (1984-96)

— CONTAINS —

Part #	Desc.	O.E.#	Qty.
18-4698	Plug, Drain	90430-08020	1



18-0030
GEAR HOUSING SEAL KIT
 Replaces: 6L2-W0001-C3-00
 For: 20HP (1996-97) 25HP (1988-02) 2 cyl model

— CONTAINS —

Part #	Desc.	O.E.#	Qty.
18-0554	Seal	93101-20M07	2
18-0747	Damper, Water Seal	6L2-44367-00	1
18-4698	Plug, Drain	90430-08020	2



18-0031
GEAR HOUSING SEAL KIT
 Replaces: 6N0-W0001-C0-00
 For: 6HP (1997-00), 8HP (1997-04)

— CONTAINS —

Part #	Desc.	O.E.#	Qty.
18-4698	Plug, Drain	90430-08020	3



18-2785
GEAR HOUSING SEAL KIT
 Replaces: 689-W0001-21-00, 689-W0001-C1-00

— CONTAINS —

Part #	Desc.	O.E.#	Qty.
18-0776	Grommet	682-44365-00-00	1
18-0552	Grommet	689-44366-00-00	1
18-4698	Drain or Fill Washer Gasket	YSG-14090-90-8G	3
18-0554	Oil Seal	93101-20M07-00	1
18-0296	Oil Seal	93101-22067-00	2
18-7405	O-Ring	93210-40M10-00	1
18-0766	Exhaust Tube Gasket	664-41134-A0-00	1
18-0773	Wear Plate Gasket	689-44316-A0-00	1

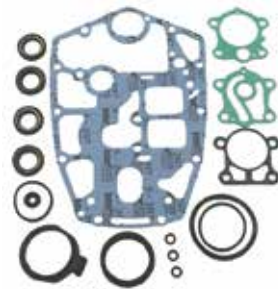

18-2787
GEAR HOUSING SEAL KIT
 Replaces: 698-W0001-20-00, 698-W0001-C0-00

— CONTAINS —

Part #	Desc.	O.E.#	Qty.
18-4698	Drain or Fill Washer Gasket	YSG-14090-90-8G	3
18-0296	Oil Seal	93101-22067-00	2
18-0297	Oil Seal	93101-23070-00	2
18-0298	O-Ring	93210-41042-00	1
18-0299	O-Ring	93210-66M98-00	1
18-0292	Wear Plate to Pump Housing Gasket	663-44315-A0-00	1
18-0267	Oil Seal	93106-09014-00	1
18-0294	Wear Plate to Pump Base Gasket	663-44324-A0-00	1

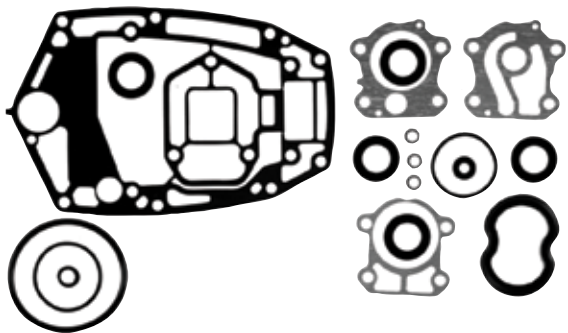

18-2788
LOWER UNIT SEAL KIT
 Replaces: 6H3-W0001-21-00, 6H3-W0001-C1-00
 — CONTAINS —

Part #	Desc.	O.E. #	Qty.
18-0240	Wear Plate to Gear Case Mounting Gasket	688-44316-A0-00	1
18-0756	Water Pump Gasket	6H3-44315-A0-00	1
18-0757	Outer Plate Gasket	6H3-44324-A0-00	1
18-4698	Drain or Fill Washer	YSG-14090-90-8G	3
18-0297	Oil Seal	93101-23070-00	2
18-0267	Oil Seal	93106-09014-00	1
18-7436	O-Ring	93210-46044-00	1

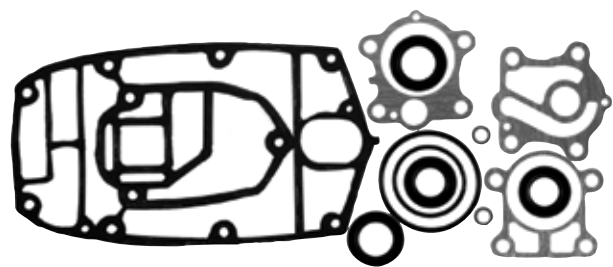

18-2789
LOWER UNIT SEAL KIT
 Replaces: 6J8-W0001-21-00, 6J8-W0001-C2-00
 — CONTAINS —

Part #	Desc.	O.E. #	Qty.
18-0292	Wear Plate to Pump Housing Gasket	663-44315-A0-00	1
18-0294	Wear Plate to Pump Base Gasket	663-44324-A0-00	1
18-4698	Drain or Fill Washer	YSG-14090-90-8G	2
18-0554	Oil Seal	93101-20M07-00	2
18-0297	Oil Seal	93101-23070-00	2
18-0298	O-Ring	93210-41042-00	1

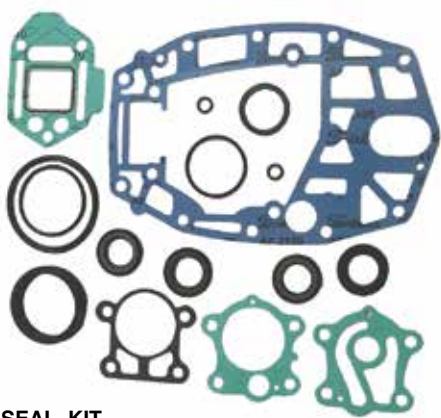

18-2792
LOWER UNIT SEAL KIT
 Replaces: 6H4-W0001-21-00, 6H4-W0001-20-00
 — CONTAINS —

Part #	Desc.	O.E. #	Qty.
18-0292	Wear Plate to Pump Housing Gasket	663-44315-A0-00	1
18-0294	Wear Plate to Pump Base Gasket	663-44324-A0-00	1
18-4698	Drain or Fill Washer Gasket	YSG-14090-90-8G	2
18-0296	Oil Seal	93101-22067-00	2
18-0297	Oil Seal	93101-23070-00	2
18-0298	O-Ring	93210-41042-00	1
18-0299	O-Ring	93210-66M98-00	1
18-0293	Pump Base to Gearcase Gasket	663-44316-A0-00	1

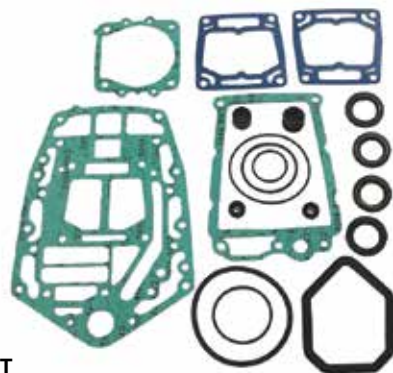

18-2794-1
LOWER UNIT SEAL KIT
 Replaces: 6F3-W0001-21-00, 6F3-W0001-C1-00
 6E5-W0001-51-00, 6E5-W0001-F1-00
 6G5-W0001-21-00, 6G5-W0001-C1-00
 — CONTAINS —

Part #	Desc.	O.E. #	Qty.
18-0244	Water Pump Gasket	6E5-44315-A0-00	1
18-4698	Drain or Fill Washer Gasket	YSG-14090-90-8G	2
18-0265	Oil Seal	93101-28M16-00	2
18-0266	Oil Seal	93101-30M17-00	2
18-0267	Oil Seal	93106-09014-00	1
18-7483	O-Ring	93210-37M67-00	1
18-7485	O-Ring	93210-86M38-00	1
18-0275	O-Ring	93210-97M55-00	1

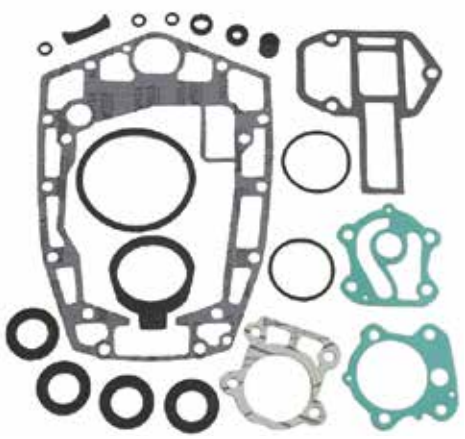

18-2798
LOWER UNIT SEAL KIT
 Replaces: 688-W0001-20-00, 688-W0001-C0-00
 — CONTAINS —

Part #	Desc.	O.E. #	Qty.
18-0240	Wear Plate to Gear Case Mounting Gasket	688-44316-A0-00	1
18-4698	Drain or Fill Washer Gasket	YSG-14040-90-8G	3
18-7436	O-Ring	93210-46044-00	1
18-0239	Wear Plate to Pump Housing Gasket	688-44315-A0-00	1
18-0267	Oil Seal	93106-09014-00	1

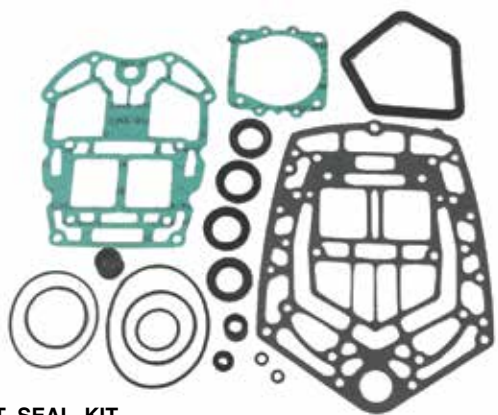

18-2799
LOWER UNIT SEAL KIT
 Replaces: 61A-W0001-21-00, 61A-W0001-C1-00
 — CONTAINS —

Part #	Desc.	O.E. #	Qty.
18-0244	Water Pump Gasket	6E5-44315-A0-00	1
18-4698	Drain or Fill Washer Gasket	YSG-14040-90-8G	2
18-0265	Oil Seal	93101-28M16-00	2
18-0267	Oil Seal	93101-30M17-00	1
18-0267	Oil Seal	93106-09014-00	1
18-7483	O-Ring	93210-37M67-00	1
18-7485	O-Ring	93210-86M38-00	1
18-7444	O-Ring	93210-04384-00	1

GEAR HOUSING SEAL KIT APPLICATION

Model #	Year	Lower Unit Gasket Kit	Model #	Year	Lower Unit Gasket Kit	Model #	Year	Lower Unit Gasket Kit
2	1986-88	18-0026	C55	1992-95	18-0024	SX150	1999-04	18-2794-1
2	1989-02	18-0027	CV55	1989-90	18-2787	V150	2000-08	18-2794-1
4	1984-99	18-0028	P60	1991	18-2788	VX150	2000-04	18-2794-1
F4	1999-08	18-0028	70	1984-85, 1988-91	18-2788	VZ150	2000-11	18-2794-1
5	1984-02	18-0028	C75	1994-99	18-0021	175	1984-00	18-2794-1
6	1988-96	18-0029	E75	1995-00	18-0021	P175	1994-99	18-2794-1
6	1997-00	18-0031	P75	1996-99	18-0021	S175	1996-99	18-2794-1
8	1984-96	18-0029	C80	1997	18-0021	V175	2000	18-2794-1
8	1997-09	18-0031	C85	1991	18-2798	VZ175	2001-11	18-2794-1
T8	2001-10	18-0025	C85	1992-96	18-0021	Z175	2001-05	18-2794-1
20	1996-97	18-0030	CV85	1989-90	18-2798	200	1984-98	18-2794-1
25 ①	1984-85	18-2785	90	1984-91	18-2798	L200	1986-99	18-2794-1
25 ①	1986-87	18-0023	90	1992-09	18-0021	LX200	1999-01	18-2794-1
25 ①	1988-09	18-0030	B90	1997-99	18-0021	LZ200	2000-11	18-2794-1
25 ②	1997-02	18-2789	C90	1997-	18-0021	P200	1991-99	18-2794-1
C25	1991	18-0023	115	1986-09	18-2794-1	S200	1996-99	18-2794-1
C25 ①	1992-97	18-0022	C115	1992-00	18-2794-1	SX200	1999-05	18-2794-1
CV25	1990	18-0023	P115	1993-96	18-2794-1	VZ200	2001-04	18-2794-1
T25 ①	2002	18-0020	S115	1996-99	18-2794-1	Z200	2000-11	18-2794-1
30	1984-85	18-2785	130	1988-04	18-2794-1	V6 Special	1984-86	18-2794-1
30	1986	18-0023	L130	1989-01	18-2794-1	V6 Excel	1987-89	18-2794-1
30	1987-02	18-2789	S130	1996-99	18-2794-1	225 ③	1990-97	18-2794-1
C30	1991	18-0023	150	1984-09	18-2794-1	225 ④	1994-96	18-2799
C30	1992	18-0022	C150	1996-99	18-2794-1	L225 ④	1994-96	18-2799
F30 ②	2002	18-0020	L150	1986-99	18-2794-1	S225	1996	18-2799
40	1984-94	18-2792	LX150	1999-01	18-2794-1	250	1990-95	18-2799
C40	1992-94	18-99104	LZ150	2000-05	18-2794-1	L250	1990-96	18-2799
F40 ②	2002	18-0020	Z150	2000-05	18-2794-1	S250	1996	18-2799
50	1986-94	18-2792	P150	1991-99	18-2794-1			
PRO 50	1987-90	18-2792	PX150	1999	18-2794-1			
P50	1992-94	18-2792	PRO V150	1987-90	18-2794-1			
C55	1991	18-2787	S150	1996-99	18-2794-1			

- ① 2 cylinder model ② 3 cylinder model ④ 3.1 liter engine
 ③ 2.6 liter engine

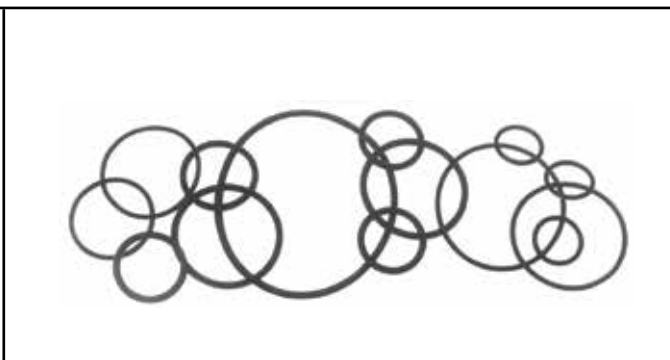

OIL SEALS

Part #	O.E. #	I.D.	Dimensions	
			O.D. (mm)	Width
18-0265	93101-28M16-00	27	43.25	7
18-0266	93101-30M17-00	28.5	45.25	7
18-0267	93106-09014-00	8.75	19.2	5.25
18-0296	93101-22067-00	23	36.25	6
18-0297	93101-23070-00	22.75	37.25	6
18-0554	93101-20M07-00	21.5	34	6.25
18-0570	93102-23096-00	22.75	38.25	7
18-0587	93101-25M03-00	24	40.25	6
18-2079	93101-22M15-00	21.75	35.2	6
18-2085	93102-35M13-00	34	52.25	8

O-RINGS

Part #	Std. Pkg.	O.E. #	Part #	Std. Pkg.	O.E. #
18-0275	1	93210-97M55-00	18-7444	1	93211-04384-00
18-0298	1	93210-41042-00	18-7463	1	93210-19123-00
18-0299	1	93210-66M98-00	18-7468	1	6G5-43864-00-00
18-7119	1	93210-33M85-00	18-7469	1	64E-43869-00-00
18-7432 ⑤	2	93210-32738-00	18-7470	1	65W-43865-00-00
18-7436	1	93210-46044-00	18-7483	1	93210-37M67-00
18-7442	1	93210-74M35-00	18-7485	1	93210-86M38-00

⑤ This product is priced per piece. To order priced per package, please add -9 to the part number.

NEW



**18-6859
SOLENOID**
Replaces: Sea-Doo 278-001-376, 278-001-802
Sea-Doo PWC

NEW



**18-6860
SOLENOID PLUG**
Replaces: Sea-Doo used on Sea-Doo 1995 and UP

NEW



**18-6862
STARTER**
Replaces: Yamaha 6M6-81800-10-00

NEW



**18-6866
Starter**
Replaces: Sea-Doo 278-000-576, 278-000-577, 278-001-038, 278-001-301

NEW



**18-6867
STARTER**
Replaces: Sea-Doo 278-000-484, 278-000-485, 278-001-300, 278-001-935
Denso 228000-4550

NEW



**18-6868
STARTER**
Replaces: Sea-Doo 278-000-186, 311, 316
Denso 995435, 128000-4860, 61, 62, 63, 64

NEW



**18-6869
STARTER**
Replaces: Sea-Doo 278-001-497, 278-001-936

NEW



**18-6873
STARTER**
Replaces: Kawasaki 21163-3715, 21163-3719
Denso 428000-0081
99-2005 JH1200 Ultra 150 w/1176cc, 2002-05 JT1200 STX-R w/1176cc

NEW



**18-6877
STARTER**
Replaces: Honda PWC 31200-HW1-671

NEW



**18-6905
STARTER**
Replaces: Sea-Doo 290-888-993, 999, 420-888-9933, -994, -996

NEW



**18-6906
STARTER**
Replaces: Yamaha PWC 64X-81800-00-00

NEW



**18-6907
STARTER**
Replaces: Yamaha PWC 6D3-81800-00-00
2005-08 VX1100 Wave Runner w/1100cc



**18-6908
STARTER**
Replaces: Yamaha PWC 63M-81800-00-00



**18-6909
STARTER**
Replaces: Yamaha PWC 6S5-81800-00-00



**18-6919
STARTER**
Replaces: Arctic Cat PWC 3008-093, 3008-327, 3008-462, 3008-536



**18-6921
STARTER**
Replaces: Yamaha PWC 60E-81800-00-00



**18-6871
TRIM MOTOR**
Replaces: Sea-Doo 278-001-292



**18-6875
TRIM MOTOR**
Replaces: Kawasaki PWC 21174-3703 Super Sport 750,900,110 ZXI, STX, XI



**18-6904
TRIM MOTOR**
Replaces: Kawasaki 21163-3720, 21163-3721



**18-6857
VOLTAGE REGULATOR**
Replaces: Yamaha PWC 63M-81960-00-00 800 1998-05; 1100 WR 1995-96; 1100 WV 1997



**18-6858
VOLTAGE REGULATOR**
Replaces: Yamaha PWC 6H2-81960-00-00 GP1200 1997-99



**18-6874
VOLTAGE REGULATOR**
Replaces: Sea-Doo 278-001-581 GTX 4-Tec 2003-04



**18-6876
VOLTAGE REGULATOR**
Replaces: Sea-Doo 278-001-554















**18-6878
VOLTAGE REGULATOR**
Replaces: Sea-Doo 278-000-123



**18-6879
VOLTAGE REGULATOR**
Replaces: Sea-Doo 278-001-239

Model	Year	Starter	Trim Motor	Voltage Regulator	Model	Year	Starter	Trim Motor	Voltage Regulator
Yamaha					HX w/ 718cc	96-97	18-6867		18-6878
EXS1200 Exciter	98-99	18-6908			LRV DI	2002			18-6876
EXT1100 Exciter	96-98	18-6908			RX	2001-02		18-6871	
EXT1200 Exciter	98-99	18-6908			RX DI	00-03		18-6871	18-6876
FX700 FX1 w/ 701cc	94-95	18-6862			RX limited	2000		18-6871	
FX1000 Wave Runner w/ 998cc	2002-05	18-6921			RXP w/ 1494cc	2004-05	18-6905	18-6871	
FX1100 Wave Runner w/ 1100cc	2004-05	18-6921			RXP w/ 1494cc	2006-07	18-6905		
FX1800 FX Waverunner w/ 1812cc	2008	18-6909			RXP 155 w/ 1494cc	2008	18-6905		
GP760 Wave Runner w/ 760cc	97-00	18-6906			RXP 215 w/ 1494cc	2008	18-6905		
GP800 Wave Runner w/ 784cc	98-05	18-6908		18-6857	RXP X 255 w/ 1494cc	2008	18-6905		
GP1200 Wave Runner w/ 1176cc	97-99	18-6908		18-6858	RXT w/ 1494cc	2005-07	18-6905		
GP1200 Wave Runner w/ 1176cc	2000-02	18-6908			RXT 215 w/ 1494cc	2008	18-6905		
GP1300 Wave Runner w/ 1300cc	2003-08	18-6908			RXT 255 w/ 1494cc	2008	18-6905		
LST1200	99-05	18-6908			SP w/ 581cc	92-94	18-6868		
RA700 Wave Raider w/701cc	94-97	18-6862			SP w/ 581cc	1995	18-6867		
RA760 Wave Raider w/ 760cc	1996	18-6906			SP w/ 581cc	1996	18-6867		18-6878
RA1100 Wave Raider w/ 1100cc	95-96	18-6908			SP w/ 718cc	1997	18-6867		
SJ650 Super Jet w/ 650cc	90-93	18-6862			SPI w/ 581cc	93-94	18-6868		
SJ700 Super Jet w/ 701cc	94-08	18-6862			SPI w/ 581cc	1995	18-6867		
SRT1000	2003-05	18-6921			SPI w/ 581cc	1996	18-6867		18-6878
SRT1100	2005	18-6921			SPX w/ 581cc	1993	18-6868		
SUV 1200 w/1176cc	99-04	18-6908			SPX w/ 650cc	1994	18-6868		
Wave Runner 1100cc	1995-96			18-6857	SPX w/ 650cc	1995	18-6867		
WB700 Wave Blaster w/ 701cc	93-96	18-6862			SPX w/ 718cc	1996	18-6867	18-6871	18-6878
WR650 Wave Runner LX w/ 650cc	90-94	18-6862			SPX w/ 782cc	1997	18-6867	18-6871	
WB760 Wave Blaster w/ 760cc	96-97	18-6906			SPX w/ 782cc	98-99	18-6866	18-6871	
WRA650 Wave Runner III w/650cc	90-96	18-6862			XP w/ 581cc	1992	18-6868		
WRA700 Wave Runner III w/ 701cc	94-97	18-6862			XP w/ 650cc	93-94	18-6868		
WRB650 Wave Runner w/ 650cc	91-95	18-6862			XP w/ 718cc	1995	18-6867	18-6871	
WRB700 Wave Runner w/ 700cc	93-94	18-6862			XP w/ 782cc	96-97	18-6866	18-6871	
WVT700 Wave Vent w/ 701cc	95-98	18-6862			XP	2002		18-6871	
WVT760 Wave Venture w/ 760cc	1997	18-6906			XP800	ALL (EXCEPT 1995)			18-6878
WVT1100 Wave Vent w/ 1100cc	1996	18-6908			XP800	1995		18-6871	
WVT1100 Wave Vent w/ 1100cc	1997	18-6908		18-6857	XP DI	2003-04			18-6876
VX1100 Wave Runner w/ 1100cc	2005-08	18-6907			XP Limited VTS motor	98-05		18-6871	
XL700 Wave Runner w/ 701cc	99-04	18-6862			Challenger	1998	18-6867		
XL760 Wave Runner w/ 760cc	1997	18-6906			Challenger	96-99	18-6866		
XL800 Wave Runner w/ 784cc	00-01	18-6908			Challenger	2004-07	18-6905		
XL1200 Wave Runner w/ 1176cc	98-00	18-6908			Challenger 180, 230	2008	18-6905		
XLT800 Wave Runner w/ 784cc	2002-04	18-6908			Islandia	2004-08	18-6905		
XLT1200 Wave Runner w/ 1176cc	2001-05	18-6908			Speedster	98-99	18-6866		
XRT1200	00-01	18-6908			Speedster	95-99	18-6867		
					Speedster	2004-07	18-6905		
					Speedster 150, 200	2008	18-6905		
					Speedster Wake	2008	18-6905		
					Sportster	95-99	18-6867		
					Sportster	2003-06	18-6905		
					Utopia	2004-08	18-6905		
Sea-Doo					Arctic Cat				
3D DI w/ 782cc	2004-05	18-6869			Barracuda 639cc	94-95	18-6919		
3D DI w/ 1494cc	2007	18-6905			Daytona w/ 639cc	93-95	18-6919		
Explorer	93-94	18-6868			Daytona 770 w/ 768cc	96-97	18-6919		
Explorer	95-97	18-6867			Daytona 1000 w/ 999cc	1997	18-6919		
GS w/ 718cc	97-01	18-6867		18-6879	Monte Carlo 640 w/ 639cc	94-97	18-6919		
GSI w/ 718cc	1997	18-6867	18-6871	18-6879	Monte Carlo 770 w/ 768cc	96-97	18-6919		
GSX RFI w/ 782cc	1999	18-6869			Monte Carlo 900 w/ 900cc	1996	18-6919		
GSX RFI w/ 782cc	2000	18-6869		18-6876	Monte Carlo 1000 w/ 999cc	1997	18-6919		
GSX RFI w/ 782cc	2001	18-6869			Montego 640 w/ 639cc	94-97	18-6919		
GSX w/ 782cc	1996	18-6866	18-6871		Montego Dix 640 w/639cc	94-97	18-6919		
GSX w/ 782cc	1997	18-6866	18-6871	18-6879	Tigershark 640 w/639cc	1993	18-6919		
GSX limited	1998		18-6871		Tigershark 900 w/900cc	1995	18-6919		
GTI w/ 718cc	1996-97	18-6867		18-6878	TS640 w/639cc	1993	18-6919		
GTI w/ 718cc	98-04	18-6867		18-6879	TS770, 770L, 770R w/ 768cc	98-99	18-6919		
GTI w/ 718cc	2005	18-6867			TS900L w/ 900cc	1999	18-6919		
GTI LE w/ 718cc	2002	18-6867		18-6879	TS1000L, R w/ 999cc	1998	18-6919		
GTI LE w/ 718cc	2003	18-6867			TS1100Li, R w/ 1100cc	1999	18-6919		
GTI LE w/ 718cc	2004	18-6867							
GTI LE w/ 782cc	2005	18-6869							
GTI LE RFI	2004			18-6876					
GTI w/ 1494cc	2006-08	18-6905							
GTI RFI	2004			18-6876					
GTI SE w/ 1494cc	2006-07	18-6905							
GTS w/ 581cc	92-94	18-6868							
GTS w/ 718cc	97-00	18-6867		18-6878					
GTS w/ 718cc	2001	18-6867		18-6879					
GTS - 2 passenger w/ 581cc	1995	18-6867			Kawasaki				
GTS - 3 passenger w/ 581cc	95-96	18-6867			JH1200 Ultra 150 w/ 1176cc	99-05	18-6873		
GTX w/ 581cc	1992	18-6868			JT1200 STX-R w/ 1176cc	2002-05	18-6873		
GTX w/ 650cc	93-94	18-6868			JT1200 STX-12F w/1199cc	2003-07		18-6904	
GTX - 2 passenger w/ 650cc	1995	18-6867			JT1500 STX-15F w/1498cc	2004-09		18-6904	
GTX - 3 passenger w/ 650cc	1995	18-6867			JT1500 Ultra 250X w/ 1498cc	2007-09		18-6904	
GTX w/ 782cc	96-97	18-6866			JT1500 Ultra LX w/ 1498cc	2007-09		18-6904	
GTX DI	2000-03			18-6876	Super Sport 750	ALL		18-6875	
GTX RFI w/ 782cc	1998	18-6866			Super Sport 900	ALL		18-6875	
GTX RFI	2000-02			18-6876	Super Sport 110	ALL		18-6875	
GTX 155 w/ 1494cc	2008	18-6905			Super Sport ZLI	ALL		18-6875	
GTX 215 w/ 1494cc	2008	18-6905			Super Sport STX	ALL		18-6875	
GTX 4-Tec w/ 1494cc	2002	18-6905			Super Sport XI	ALL		18-6875	
GTX 4-Tec w/ 1494cc	2003-04	18-6905		18-6874					
GTX 4-Tec w/ 1494cc	2005-08	18-6905			Honda				
GTX Wake w/ 1494cc	2005-07	18-6905			Aquatrax F-12 w/ 1235cc	2002-07	18-6877		
GTX Wake 155 w/ 1494cc	2005-08	18-6905			Aquatrax F-12X w/ 1235cc	2002-07	18-6877		
GTX Wake 215 w/ 1494cc	2008	18-6905			Aquatrax F-12X GPSC w/ 1235cc	2005-07	18-6877		
HX w/ 718cc	1995	18-6867			Aquatrax R-12 w/ 1235cc	2004-06	18-6877		
					Aquatrax R-12X w/ 1235cc	2003-07	18-6877		

IMPELLERS/IMPELLER KITS FOR JABSCO

 <p>18-3275 IMPELLER KIT Replaces: Jabsco 17935-0001 For: TAMD74A, A-A, A-B (2000-05); TAMD74C-A, C-B (2000-05); TAMD74L-A, B (1999-2005); TAM-D74P-A, P-B (1998-2005); TAMD75P-A (1998-2005); TAMD71B (1989-2000); TAMD73P-A (1997-98); TAMD73WJ-A (1997-99)</p>	 <p>18-3304 IMPELLER KIT Replaces: Jabsco 6760-0001 For F9B Pumps DIA. 3 3/4" SIDE WIDTH 3 1/2" (Neoprene)</p>	 <p>18-3076 IMPELLER KIT Includes: Impeller & Gaskets Replaces: Jabsco 22405-0001</p>
 <p>18-3306 IMPELLER KIT Replaces: Jabsco 13554-0001, Yanmar 119773-42600-00 DIA 2 1/4" SIDE WIDTH 1 15/16" (Neoprene)</p>	 <p>18-3036 IMPELLER KIT Replaces: Jabsco 673-0003 (Nitrile)</p>	 <p>18-3038 IMPELLER KIT Replaces: Jabsco 920-0003, 17937-0003 (Nitrile)</p>
 <p>18-3077 IMPELLER KIT Replaces: Jabsco 920-0001 12 SPLINES 8 FINS (Neoprene)</p>	 <p>18-3046 IMPELLER KIT Replaces: Jabsco 18838-0001</p>	 <p>18-3047 IMPELLER KIT Replaces: Jabsco 18948-0001</p>
 <p>①18-3081D Display Package 18-3081 IMPELLER KIT Replaces: Jabsco 1210-0001 12 SPLINES 12 FINS</p>	 <p>18-3080 IMPELLER KIT Replaces: Jabsco 673-0001; Diameter 2" • Side Width 7/8" (Neoprene)</p>	 <p>18-3078 IMPELLER KIT Replaces: Jabsco 836-0001, Cummins 160596, 166758, 556540, 556850, 21601R Diameter 3 3/4" • Side Width 2 1/2" (Neoprene)</p>
 <p>18-3079 IMPELLER KIT Replaces: Jabsco 4528-0001 Diameter 1 9/16" • Side Width 3/4" (Neoprene)</p>	 <p>①18-3075D Display Package 18-3075 IMPELLER KIT Replaces: Jabsco 4568-0001, 2877-0001, 14510-46090, 124310-46090 Diameter 2 1/4" • Side Width 1 1/4" (Neoprene)</p>	 <p>18-3037 IMPELLER KIT Replaces: Jabsco 836-0003 Diameter 3 3/4" • Side Width 2 1/2" (Nitrile)</p>

① Items ending in "D" are Display Packaged - Regular number is Non-Display



**18-3020
IMPELLER**
Replaces:
Jabsco 1210-0003
(Nitrile)



**18-3021
IMPELLER**
Replaces: Jabsco 4598-0001
Diameter 2 9/16" • Side Width 2"
(Neoprene)

PKG. OF 2



**18-3125
18-3125-9①
WATER PUMP GASKET**
Replaces: Jabsco 3101-0000



**18-2005
SEAL**
Replaces: Jabsco 92700-0060

JABSCO COMPONENT APPLICATIONS

Pump Model	Impeller Kit	Oil Seal	Pump Model	Impeller Kit	Oil Seal	Pump Model	Impeller Kit	Oil Seal
777-0001	18-3077	18-2005	1673-9051	18-3081	—	3890-9011	18-3077	—
777-0003	18-3077	—	2300-9001	18-3077	—	5330-9001	18-3077	—
777-9003	18-3077	—	2300-9003	18-3077	—	5330-9101	18-3077	—
777-9004	18-3077	—	2300-9004	18-3077	—	5560-0001	18-3077	18-2005
777-9005	18-3077	—	2300-9005	18-3077	—	5660-0001	18-3077	18-2005
777-9051	18-3077	—	3270-0001	18-3081	18-2005	5850-0001	18-3081	18-2005
1673-0001	18-3081	18-2005	3270-0003	18-3081	18-2005	7120-9001	18-3077	—
1673-0003	18-3081	18-2005	3290-9001	18-3081	—	7320-9001	18-3077	—
1673-1001	18-3081	18-2005	3380-0001	18-3081	18-2005	8170-9001	18-3077	—
1637-1003	18-3081	18-2005	3480-9002	18-3081	—	17120-0001	18-3079	18-2005
1673-9001	18-3081	—	3480-9011	18-3081	—	22740-0301	—	18-2005
1673-9003	18-3081	—	3590-9001	18-3079	—	22740-0351	—	18-2005

IMPELLERS/IMPELLER KITS FOR JOHNSON PUMP



**18-3275
IMPELLER KIT**
Replaces: Johnson Pump 09-819B
For: TAMD74A, A-A, A-B (2000-05); TAMD74C-A, C-B (2000-05); TAMD74L-A, B (1999-2005); TAM-D74P-A, P-B (1998-2005); TAMD75P-A (1998-2005); TAMD71B (1989-2000); TAMD73P-A (1997-98); TAMD73WJ-A (1997-99)



**18-3080
IMPELLER KIT**
Replaces: Johnson Pump 09-1026B
Diameter 2" • Side Width 7/8"
(Neoprene)



**18-3077
IMPELLER KIT**
Replaces: Johnson Pump 09-1028B,
Yanmar 127610-42200, Cummins 650607
12 SPLINES 8 FINS



②18-3081D Display Package
**18-3081
IMPELLER KIT**
Replaces: Johnson Pump 09-1027B
12 SPLINES 12 FINS



②18-3075D Display Package
**18-3075
IMPELLER KIT**
Replaces: Johnson Pump 09-801B
Diameter 2 1/4" • Side Width 1 1/4"
For Johnson Pump # F4B-8007
(Neoprene)



**18-3079
IMPELLER KIT**
Replaces: Johnson Pump 09-806B,
Yanmar 104211-42070
Diameter 1 9/16" • Side Width 3/4"
(Neoprene)



**18-3037
IMPELLER KIT**
Replaces: Johnson Pump 09-1029B-9
(Nitrile)



**18-3306
IMPELLER KIT**
Replaces: 09-812B



**18-3036
IMPELLER KIT**
Replaces: Johnson Pump 09-1026B-9
(Nitrile)

① Priced per Package

② Items ending in "D" are Display Packaged - Regular number is Non-Display



**18-3038
IMPELLER KIT**
Replaces: Johnson 09-1028B-9
(Nitrile)



**18-3076
IMPELLER KIT**
Includes: Impeller & Gaskets
Replaces: Johnson Pump 09-808B,
09-45589



**18-3089
WATER PUMP KIT**
Includes: Impeller, Seal, Gasket, End & Cover Screws
Replaces: Johnson Pump 09-45825
Use with 18-3587 Pump



**18-3510
WATER PUMP KIT**
Includes: Neoprene Impeller, Seal, Gasket, End & Cover Screws
Replaces: Johnson Pump 09-45589
For: F35B-8 Pumps



**18-3020
IMPELLER**
Replaces:
Johnson Pump 09-1027B-9
(Nitrile)



PKG. OF 2
**18-3125
18-3125-9①
WATER PUMP GASKET**
Replaces: 3298-0000



**18-3303
COVER PLATE GASKET**
Replaces: Johnson Pump 01-42401
For: Johnson Pump JN-F6



**18-3586
WATER PUMP**
Replaces: Johnson Pump 10-24228-1
For Impeller Repair Kit use 18-3081



**18-3587
WATER PUMP**
Replaces: Johnson Pump 10-24232-1
For Impeller Repair Kit use 18-3089

IMPELLERS FOR OBERDORFER PUMPS



**18-3061
IMPELLER**
Replaces: Oberdorfer 8922
Sherwood 10615
12 FINS
For: GM engines with V-Belt



②18-3075D Display Package
**18-3075
IMPELLER KIT**
Replaces:
Oberdorfer B6620
12 FINS



**18-3077
IMPELLER KIT**
Replaces:
Oberdorfer C7441, Sherwood 18200
12 SPLINES 8 FINS



**18-3078
IMPELLER KIT**
Replaces: Oberdorfer 7054
12 SPLINES 9 FINS



**18-3046
IMPELLER KIT**
Replaces: Sherwood 9959K
with 18-3060 Impeller
Replaces: Sherwood 9959



**18-3047
IMPELLER KIT**
Replaces: Sherwood
10615K with 18-3061 Impeller
Replaces: Sherwood 10615

① Priced per Package
② Items ending in "D" are Display Packaged - Regular number is Non-Display



**18-3060
IMPELLER**
Replaces: Sherwood 9959
Onan 132-0317
12 FINS



**18-3021
IMPELLER**
Replaces:
Oberdorfer 6603
Diameter 2 9/16" • Side width 2"
(Neoprene)



**18-3140
18-3140-9①
WATER PUMP GASKET**
Replaces: Sherwood 10931



**18-3168
SEAL & SEAT**
Replaces: Sherwood 10927



**18-3169
SEAL & SEAT**
Replaces:
Sherwood 12859, 12322

SHERWOOD COMPONENT APPLICATIONS

Pump #	Impeller Kit	Impeller	Seal & Seat Assembly	Pump #	Impeller Kit	Impeller	Seal & Seat Assembly	Pump #	Impeller Kit	Impeller	Seal & Seat Assembly
A-03	—	18-3060	—	G-50	18-3047	18-3061	18-3169	N-10460	—	18-3060	—
B-04	18-3047	18-3061	18-3168	G-55-2	—	18-3061	18-3169	N-10470	—	18-3060	—
C-03	18-3047	18-3061	18-3168	G-56	—	18-3061	18-3169	N-10510G	18-3046	18-3060	—
D-05	—	18-3061	18-3168	G-85	18-3047	18-3061	18-3169	P-101	—	18-3061	18-3169
D-55	18-3046/ 18-3047	18-3060/ 18-3061	18-3168	G-1004	—	18-3061	—	P-102	—	18-3061	—
D-60	18-3046	18-3060	18-3168	G-1005	—	18-3061	—	P-105	18-3047	18-3061	—
D-65	18-3046	18-3060	18-3168	G-1006	—	18-3061	—		18-3046/ 18-3047	18-3060/ 18-3061	—
D-75	18-3046	18-3060	18-3168	G-85106	—	18-3061	18-3168	P-10550G	18-3047	18-3061	—
E-35	—	18-3061	18-3168	H-85	—	18-3061	18-3169	P-10560G	18-3046	18-3060	—
F-10	18-3047	18-3061	18-3168	J-70	—	18-3060	18-3169	P-10610G	18-3046	18-3060	—
F-75	18-3047	18-3061	18-3168	K-90	—	18-3061	18-3169	P-10650G	18-3046	18-3060	—
F-95	—	18-3061	18-3168	L-10	—	18-3061	18-3069	P-10710G	18-3046	18-3060	—
G-3	—	18-3061	—	L-10B	—	18-3061	18-3169	Q-10770G	18-3046	18-3060	—
G-4	—	18-3061	—	L-80	—	18-3061	18-3169	Q-10755G	—	18-3060	—
G-5	18-3047	18-3061	18-3169	L-90	—	18-3061	18-3169	Q-10855G	18-3046	18-3060	—
G-5-1	—	18-3061	18-3169	L-9930G	18-3046	18-3060	—	R-40G	18-3046	18-3060	18-3168
G-7	—	18-3061	18-3169	M-70	—	18-3061	18-3169	R-101	—	18-3061	18-3168
G-8	—	18-3061	—	M-71	—	18-3061	18-3169	R-102	—	18-3060	—
G-7B	—	18-3061	18-3169	M-10065G	—	18-3060	—	R-10870G	18-3046	18-3060	18-3168
G-15	—	18-3060	18-3169	M-10180G	18-3046	18-3060	—	R-10920G	18-3046	18-3060	—
G-26	—	18-3061	18-3169	M-10210G	18-3046	18-3060	—	R-10930G	18-3046	18-3060	—
G-30-2	—	18-3060	18-3169	M-10263G	18-3046	18-3060	—	R-10935G	18-3046	18-3060	—
G-30-2B	—	18-3060	18-3169	M-10264G	18-3046	18-3060	—	R-10970G	18-3046	18-3060	18-3168
G-45-1	—	18-3061	—	M-10270G	18-3046	18-3060	—	RP-B-C	—	18-3061	18-3168
G-45-2	—	18-3061	18-3169	M-10280G	18-3046	18-3060	—	S-11040G	18-3046	18-3061	18-3168
G-46	—	18-3061	18-3169	N-10390G	18-3046	18-3060	—	S-11095G	—	18-3061	—
				N-10410G	18-3046	18-3060	—				



**18-2434
FLYWHEEL BELL HOUSING**
Replaces:
Crusader 96938, Marine Power 0100-000,
Mercruiser 814309A1, Pleasurecraft R142006,
Volvo Penta 3857846-4, GM V-8's Big &
Small Block inboard/Ski models.



**18-2589
TRANSMISSION OIL COOLER**
• 1" Water Hose Connection
• 9" Tube Bundle Overall Length
• Approximately 12"
• Oil-6 GPM MAX Water 25 GPM MAX
• Shipped bare metal, ready for primer and
factory paint finish.



18-2587
TRANSMISSION OIL COOLER
 Replaces: Mercruiser 99356A2

- Replacement Power Steering Cooler for Mercruiser
- Power Steering Fluid-4 GPM MAX Water 25 GPM MAX
- 6" tube bundle, overall length 8" , 1 1/4" water inlet and outlet
- Shipped bare metal, ready for primer and factory paint finish.



18-2588
TRANSMISSION OIL COOLER

- 1 1/4" Water Hose Connection
- 9" x 2" and 3/8" NPT Inlet/Outlet Oil Fitting
- Oil-6 GPM MAX Water 25 GPM MAX
- 10" tube bundle, overall length 12" , 1 1/4" water inlet and outlet
- Shipped bare metal, ready for primer and factory paint finish.

TRANSMISSION REPAIR KITS

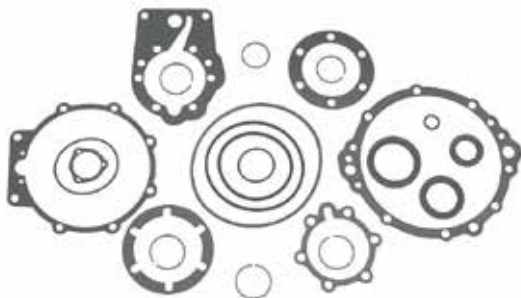

18-2590
SEAL KIT
 Replaces: Borg Warner A4876HA

- Service kit for Borg-Warner Velvet Drive 71 and 72 series transmission



18-2591
OVERHAUL KIT
 Includes: Gaskets, Seals, Sealing Rings, Bronze and Steel Plates

- Service kit for Borg-Warner Velvet Drive 71 and 72 series transmission

ANODES

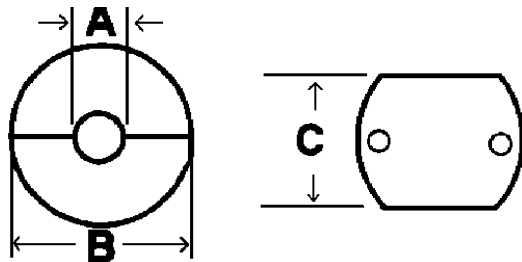

SHAFT ANODES

ZINC ANODES			NOMINAL DIMENSIONS					
PART #	NOM. WEIGHT		A-DIAMETER		DIMENSION B		DIMENSION C	
	LBS.	(KG)	IN.	(MM)	IN.	(MM)	IN.	(MM)
18-6041-1	1.65	(.75)	1 1/4	(33)	2 5/8	(67)	2 1/2	(64)
18-6043-1	1.45	(.65)	1 1/2	(38)	2 1/2	(64)	2 1/2	(64)

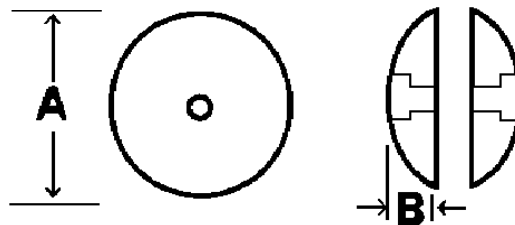

RUDDER ANODES

ZINC ANODES			NOMINAL DIMENSIONS			
PART #	NOM. WEIGHT		A-DIAMETER		DIMENSION B	
	LBS.	(KG)	IN.	(MM)	IN.	(MM)
18-6045	.20	(.09)	1 7/8	(47)	1/4	(6)
18-6046	.90	(.40)	2 13/16	(71)	1/2	(13)
18-6047	1.40	(.64)	3 3/4	(95)	1/2	(13)
18-6107	—	—	5	(127)	5/8	(16)

COMPLETE ENGINE ANODES
 (with Brass Plug)

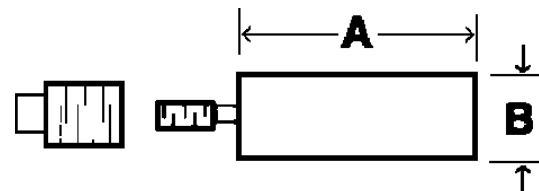

ZINC ANODES			NOMINAL DIMENSIONS					REPLACEMENT ANODE ONLY	
PART #	NOM. WEIGHT		A-LENGTH		B-DIAMETER		PLUGS (ps)		
	LBS.	(KG)	IN.	(MM)	IN.	(MM)	IN.	(MM)	
18-6134	.12	(.05)	2-0	(50)	1/4	(6)	1/8	(3)	18-6050
18-6059	.10	(.05)	1 3/4	(44)	3/8	(10)	1/4	(6)	18-6135
18-6060	.20	(.09)	2-0	(50)	1/2	(13)	3/8	(10)	18-6052
18-6136	.20	(.09)	2-0	(50)	3/8	(10)	3/8	(10)	18-6053
18-6062	.30	(.14)	2-0	(50)	5/8	(16)	1/2	(13)	18-6137

STUFFING BOXES



AP #	Shaft Diameter
49409	1"
49410	1 1/8"
49411	1 1/4"

- Durable Delrin/Selcon
- Withstands High RPM
- Corrosion Free
- High Temperature Resistance
- Constructed from non-corrosive engineered polymers
- Compatible with all materials common to marine construction
- Beveled glands force packing against shaft as it is tightened
- Will not scar, bind, freeze or contribute to misalignment of shaft
- Teflon packing is standard to reduce parasitic loss of power
- Used in ski boats and racing boats

PACKING

PREMIUM SQUARE MARINE TEFLON PACKING

AP #	Diameter	Length*	Wt. (lbs.)	Pkg.
4720	1/8"	3 ft.	—	1
4730	1/8"	—	1	1
4721	3/16"	3 ft.	—	1
4731	3/16"	—	1	1
4722	1/4"	3 ft.	—	1
4732	1/4"	—	1	1
4723	5/16"	3 ft.	—	1
4733	5/16"	—	1	1
4724	3/8"	3 ft.	—	1
4734	3/8"	—	1	1
4725	1/2"	3 ft.	—	1
4735	1/2"	—	1	1

PREMIUM SQUARE MARINE LUBRICATED FLAX PACKING

AP #	Diameter	Length*	Wt. (lbs.)	Pkg.
4700	1/8"	3 ft.	—	1
4710	1/8"	—	1	1
4701	3/16"	3 ft.	—	1
4711	3/16"	—	1	1
4702	1/4"	3 ft.	—	1
4712	1/4"	—	1	1
4703	5/16"	3 ft.	—	1
4713	5/16"	—	1	1
4704	3/8"	3 ft.	—	1
4714	3/8"	—	1	1
4705	1/2"	3 ft.	—	1
4715	1/2"	—	1	1

* All 3 foot packing comes in display packaging



18-6140
ZINC ANODE
 Replaces: 301068
 For: 5424, M-30, M-35, M3-20, M3-20A, M4-30, M4-30A, M-35A



18-6141
ZINC ANODE
 Replaces: 301069
 For: 5416, M-12, M-18, M-20, M-25, M-25XP, M-25XPA, M-30, M2-12



PROP NUT KITS

Part #	Shaft Dimensions
18-3739	1 - 1 1/8"
18-3736	1 1/4"
18-3734	1 1/2"



SHAFT KEY

Part #	Shaft Dimensions
18-2334	2 1/8" x 1/4"

① 18-5250 



**18-5250
TUNE-UP KIT**
—CONTAINS—

Part #	O.E. #	Description
18-5311	16.69-00049	Contact Set
18-5345	16.69-00050	Condenser
18-5418	16.69-00051	Rotor
Delco 4 & 6 cyl.		

① 18-5251D 



**18-5251
TUNE-UP KIT**
—CONTAINS—

Part #	O.E. #	Description
18-5314	16.69-00039	Contact Set
18-5338	16.69-00040	Condenser
18-5404-1	16.69-00149	Rotor
Mallory 8 cyl. Tall Cap		



**18-5252
TUNE-UP KIT**
—CONTAINS—

Part #	Description
18-5310	Contact Set
18-5344	Condenser
—	Rotor
Delco 8 cyl.	



**18-5255
TUNE-UP KIT**
—CONTAINS—

Part #	Description
18-5303	Contact Set
18-5345	Condenser
18-5407	Rotor
Prestolite 8 cyl.	



**18-5256
TUNE-UP KIT**
—CONTAINS—

Part #	O.E. #	Description
18-5314	16.69-00039	Contact Set
18-5338	16.69-00040	Condenser
18-5411	16.69-00042	Rotor
Mallory 8 cyl. Fiat Cap		

① 18-5258D 



**18-5258
TUNE-UP KIT**
—CONTAINS—

Part #	Description
18-5303	Contact Set
18-5347	Condenser
18-5407	Rotor
Prestolite 8 cyl.	



**18-5259
TUNE-UP KIT**
—CONTAINS—

Part #	Description
18-5303	Contact Set
18-5347	Condenser
18-5429	Rotor
Prestolite 6 & 8 cyl.	

① 18-5260D 



**18-5260
TUNE-UP KIT**
—CONTAINS—

Part #	Description
18-5303	Contact Set
18-5345	Condenser
18-5403	Rotor



**18-5266
TUNE UP KIT**
Fits: Flame Thrower Distributors 18-5481, 18-5482, 18-5483, 18-5477, 18-5478 and 18-5479



**18-5268
TUNE-UP KIT**
—CONTAINS—

Part #	O.E. #	Description
18-5311	16.69-00049	Contact Set
18-5345	16.69-00050	Condenser
18-5418	16.69-00051	Rotor
18-5385	16.69-00052	Distributor Cap
GM 4 Cyl. • Single Point		



**18-5269
TUNE-UP KIT**
—CONTAINS—

Part #	O.E. #	Description
18-5311	16.69-00049	Contact Set
18-5345	16.69-00050	Condenser
18-5418	16.69-00051	Rotor
18-5386	—	Distributor Cap
GM V-6 • Single Point		



**18-5271
TUNE-UP KIT**
—CONTAINS—

Part #	O.E. #	Description
18-5314	16.69-00039	Contact Set
18-5338	16.69-00040	Condenser
18-5376	16.69-00148	Distributor Cap
18-5404-1	16.69-00149	Rotor
Mallory Tall • V-8 • Single Point		



**18-5272
TUNE-UP KIT**
—CONTAINS—

Part #	O.E. #	Description
18-5314	16.69-00039	Contact Set
18-5338	16.69-00040	Condenser
18-5375	16.69-00100, F6900165	Distributor Cap
18-5411	16.69-00042	Rotor
Mallory Flat • V-8 • Single Point		



**18-5275
TUNE-UP KIT**
—CONTAINS—

Part #	Description
18-5303	Contact Set
18-5347	Condenser
18-5352	Distributor Cap
18-5403	Rotor
Single Point • Screw Cap • V-8	



**18-5277
TUNE-UP KIT**
—CONTAINS—

Part #	Description
18-5303	Contact Set
18-5347	Condenser
18-5369	Distributor Cap
18-5407	Rotor
Single Point • Clip Cap • V-8	



**18-5303
CONTACT SET**



**18-5307
CONTACT SET**

APPLICATION BEGINS ON PAGE 484

① Items ending in "D" are Display Packaged - Regular number is Non-Display

 <p>18-5310 CONTACT SET</p>	 <p>18-5311 CONTACT SET Replaces: 16.69-00049</p>	 <p>18-5314 CONTACT SET Replaces: 16.69-00039</p>	 <p>18-5338 CONDENSER Replaces: 16.69-00040</p>	 <p>18-5344 CONDENSER</p>
 <p>18-5345 CONDENSER Replaces: 16.69-00050</p>	 <p>18-5346 CONDENSER Replaces: 1869704</p>	 <p>18-5347 CONDENSER</p>	 <p>18-5300 ROTOR Fits: Flamethrower Distributors</p>	
 <p>18-5403 ROTOR</p>	 <p>18-5404-1 ROTOR Replaces: 16.69-00149</p>	 <p>18-5407 ROTOR</p>	 <p>18-5411 ROTOR Replaces: 16.69-00042</p>	
 <p>18-5418 ROTOR Replaces: 16.69-00051</p>	 <p>18-5419 ROTOR</p>	 <p>18-5427 ROTOR Replaces: 16.69-0022</p>	 <p>18-5429 ROTOR</p>	
 <p>18-5352 DISTRIBUTOR CAP</p>	 <p>18-5359 DISTRIBUTOR CAP</p>	 <p>18-5369 DISTRIBUTOR CAP W/Gasket 18-5399</p>	 <p>18-5375 DISTRIBUTOR CAP Replaces: 16.69-00100, FI 6900165</p>	
 <p>18-5376 DISTRIBUTOR CAP Replaces: 16.69-00148</p>	 <p>18-5385 DISTRIBUTOR CAP Replaces: 16.69-00052</p>	 <p>18-5386 DISTRIBUTOR CAP</p>	 <p>18-5301 TUNE-UP KIT Fits: male cap v-8 flamethrower distributors</p>	



**18-5302
TUNE-UP KIT**
Fits: male cap v-8 flamethrower distributors



**18-5225
SPARK PLUG WIRE KIT**
Replaces: Mercury 84-99215A26, 84-813706A26
Kit includes 25 ft. Roll of 7 MM Hypalon Ignition Wire With a Metallic Core and a Large Assortment of Three Different End Fittings.



**18-5226
IGNITION WIRE
Metallic Core**
100' Spool
7mm Hypalon

PKG. OF 10



**18-5224
18-5224-9①
SPARK PLUG WIRE TERMINAL**
Replaces: Mercury 20121
OMC 510364

PKG. OF 10





**18-5750
18-5750-9①
UNIVERSAL SPARK PLUG BOOTS**
Supplied complete w/Terminal Connector
Replaces: OMC 581027, 580339



**18-5752
UNIVERSAL
SPARK PLUG BOOTS**
8mm

PREMIUM MARINE SPARK PLUG WIRE LEADS

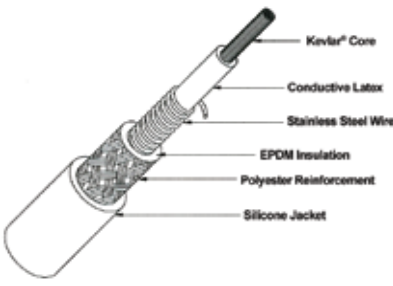
OE style boots provide a sealed barrier against heat, dirt and moisture.

Premium Marine Wire Leads
Magnetic Suppression Core
Manufactured for your specific application

- Kevlar® core for maximum durability and long life.
- Durable stainless steel wound conductor for maximum horsepower and engine performance.
- Premium silicone jacketing and boots for the ultimate in high temperature protection.
- Superior RFI suppression for the most sensitive electronic system.
- Corrosion resistant stainless steel spark plug and distributor terminals for maximum conductivity.

Model	Ignition Type	Cyl.	Part #
181 CID (3.0L)	Conventional	4	18-8800-1
350 CID (1970-90)	Conventional	8	18-8803-2
350 CID (1970-90)	Conventional	8	18-8823-1 ①
454, 502 w/straight plug boots	Conventional	8	18-8817-1

① For models with Mallory side terminal design



FEATURES

- Senses current levels in the coil and adjusts the dwell to maintain peak energy throughout the entire RPM range.
- Develops, on average, 4 times more available energy between 3000 and 5000 RPM's and twice as much plug voltage as point-type systems.
- Ignition energy is sustained and coil life is increased when peak current level is reached just prior to spark.
- More stable timing.
- Use with 18-5472 "Flame Thrower II" Coil for optimum performance



**18-5286
HI-PERFORMANCE ELECTRONIC CONVERSION KIT**
Fits: 6 Cylinder Delco Distributors



**18-5288
HI-PERFORMANCE ELECTRONIC CONVERSION KIT**
Fits: Most Prestolite V-8 with snap down cap

① Priced per Package



18-5289
HI-PERFORMANCE ELECTRONIC CONVERSION KIT
 Fits: Most Prestolite V-8 Distributors with screw down cap



18-5290
HI-PERFORMANCE ELECTRONIC CONVERSION KIT
 Fits: Most Mallory YL or YD 8 cylinder Distributors with clockwise and counter clockwise rotation

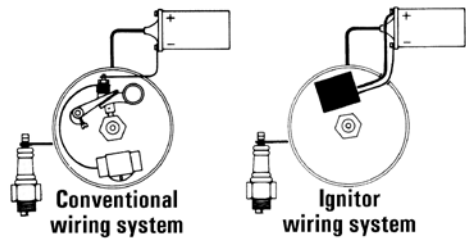

FEATURES

- Replaces points & condensers for true solid state ignition.
- Uses standard coil, cap and rotor.
- Easy to install, one-piece, 2-wire hook-up.
- Accurate to within 1/4° timing accuracy 0 to 6000 RPM range.
- Can be used with Flame Thrower coils 18-5466 & 18-5469.



18-5294
ELECTRONIC CONVERSION KIT
 Fits 6 cyl. Delco distributors



18-5295
ELECTRONIC CONVERSION KIT
 Fits most 4 cyl. Prestolite distributors. (Except IBM 7026)
 For: Onan, Universal, Waukesha, Wisconsin



18-5298
ELECTRONIC CONVERSION KIT
 (with snap down cap) For: Most Prestolite V-8 Distributors



18-5296-2D Display Package
18-5296-2
ELECTRONIC CONVERSION KIT
 Fits most Mallory V-8 YL & YD 8 cyl. Distributors with clockwise or counter clockwise rotation



18-5299
ELECTRONIC CONVERSION KIT
 (with screw down cap)
 For: Most Prestolite V-8 Distributors
 Use with 18-5403 style rotor



18-9801
MULTI METER/DVA TESTER
 Tests electrical and ignition systems. Consists of a VOA meter with built-in direct voltage adapter.



18-9802
TIMING LIGHT
 Self-powered accurate up to 10,000 RPM's

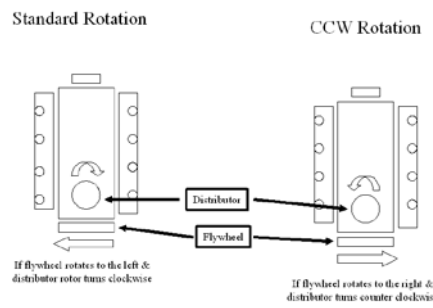

18-5483
HI-PERFORMANCE ELECTRONIC DISTRIBUTOR
 Fits: Chevrolet Marine Small and Big Block engines (Standard Deck Height)

- Distributors feature the Ignitor II ignition module with adaptive dwell control adjusts the spark timing over the entire RPM range to maximize performance
- Upper roller bearing and oil impregnated bronze sintered bottom bushing are installed and aligned bored for accuracy for maximum durability
- Machined heat treated gear with tight tolerances insures durability and consistent timing to maximize and performance. Complete with high dielectric strength cap and rotor for years of performance
- Replacement cap/rotor kit: 18-5266



APPLICATION BEGINS ON PAGE 484

① Items ending in "D" are Display Packaged - Regular number is Non-Display



**18-5313
DISTRIBUTOR**
Replaces: Mallory YL624MW
For most GM V-8 Engs.(small & large blocks)
Uses: 18-5251 TUNE-UP KIT
— CONTAINS —
Part # Desc.
18-5314 Contact Set
18-5338 Condenser
18-5404-1 Rotor
And 18-5376 CAP



**18-5494-1
ELECTRONIC DISTRIBUTOR**
U.L. Approved Conventional Rotation
For: Chevrolet All V8 (exc. 348, 409 & Tall Deck Big Block) includes 482, 502, 540 CID
USES:
Part # Description
18-5376 Distributor Cap
18-5404-1 Rotor
18-5488 Module



**18-5485
ELECTRONIC DISTRIBUTOR**
Right Hand Rotation
Replaces: Mallory YLE624BV
Late Model HEI
For V8 — 262-454 & 502 except 384/ 409 and tall block engines. Designed as a plug-in replacement for GM-style fuel injection system distributors
— CONTAINS —
Part # Description
18-5354 Distributor Cap
18-5405 Rotor



**18-5480
COMPLETE IGNITION
CONVERSION KIT**
Fits: GM SB & BB with Standard Deck Height
— CONTAINS —
Part # Description
18-5472 Coil
18-8803-2 Wire Set
18-5483 Distributor



**18-5434
IGNITION COIL**
(Uses External Resistor)



**18-5435
IGNITION COIL**
(Has Internal Resistor)

FEATURES

- Oil filled for better cooling and long life
- Low resistance and improved turn ratios produces the higher voltage needed to run larger spark plug gaps for added power and better fuel economy
- More windings maximize energy and reliability over the full RPM range
- Fits existing brackets for easy installation



**18-5466
HI-PERFORMANCE
IGNITION COIL**
1.5 ohm (oil filled), black - 8 cylinder: Flame-Thrower 40,000 volt coil.
• Designed for use with the original Ignitor Electronic Conversion Kits
• Can be used with other inductive ignition systems



**18-5469
HI-PERFORMANCE
IGNITION COIL**
3.0 ohm (oil filled), black - 4 & 6 cylinder: Flame-Thrower 40,000 volt coil.
• Designed for use with the original Ignitor Electronic Conversion Kits
• Can be used with other inductive ignition systems



**18-5472
HI-PERFORMANCE
IGNITION COIL**
0.6 ohm (oil filled), black - 4, 6, & 8 cylinder: Flame-Thrower 45,000 volt coil.
• Super low 0.6 ohm resistance coil designed for use with the Ignitor II Hi Performance Electronic Conversion Kits
• Compatible with capacitive discharge systems

Part #	Description	Recommended Coil	Resistance Ohms	Part #	Description	Recommended Coil	Resistance Ohms
18-5294	Electronic Conversion Kit	18-5469	3.0	18-5286	Hi Performance Electronic Conversion Kit	18-5472	0.6
18-5295	Electronic Conversion Kit	18-5469	3.0	18-5288	Hi Performance Electronic Conversion Kit	18-5472	0.6
18-5296-2	Electronic Conversion Kit	18-5466	1.5	18-5289	Hi Performance Electronic Conversion Kit	18-5472	0.6
18-5298	Electronic Conversion Kit	18-5466	1.5	18-5290	Hi Performance Electronic Conversion Kit	18-5472	0.6
18-5299	Electronic Conversion Kit	18-5466	1.5	18-5483	Flame-Thrower Distributor	18-5472	0.6



**18-5450
COIL RESISTOR**



**18-5464
IGNITION MODULE**
Fits: Sierra 18-5483 Billet HI-PERFORMANCE ELECTRONIC DISTRIBUTOR (except HEI/EST)

APPLICATION BEGINS ON NEXT PAGE

IGNITION/ELECTRICAL SYSTEMS APPLICATION

Year	Cyl.	Model	Distributor No.	Contact Set	Condenser	Rotor	Dist. Cap	Tune-Up Kit	Distributor	Elect. Conv. Kit
1946-62	4	B,BR,BR3	IGW-4152,C	—	—	—	18-5359	—	—	—
1946-68	4	A,B,BR,BR3	IAY-4010	18-5307	18-5345 ①	18-5427	—	—	—	—
1975-80	4	FL153,181	—	18-5311	18-5338	18-5418	18-5385	—	—	—
1947-60	6	M,ML,MLO,MO, K,KL,KLO,KO	IAY-4009	18-5307	—	18-5427	—	—	—	—
1947-63	6	KS,KSO,KR, W,WO	IAY-4009	18-5307	—	18-5427	—	—	—	—
1947-63	6	W,WO	IGC-4279B	—	18-5345 ①	—	—	—	—	—
1967-71	6	225B,BVC	1110342	18-5310	18-5346	18-5419	—	—	—	—
1958-67	8	283,283-0 Corvette Eng.	IBB-4109A	18-5303	18-5345 ①	18-5404-1	—	—	18-5313 ③ 18-5494-1 ④	18-5296-1
1963-71	8	283F,327F Corvette Eng.	IBM-4115,4116	18-5303	18-5345 ①	18-5429	—	18-5259	18-5494-1 ④	—
1958-67	8	Dual Contact	IBB-4201A,B	18-5303 ②	18-5345 ①	18-5404-1	—	—	—	18-5296-1
1958-68	8	Dual Contact	IBB-4301A,B,	18-5303 ②	18-5345 ①	18-5407	18-5369	18-5255 ⑤	—	18-5298
1958-67	8	Dual Contact	1110630	—	18-5346	—	—	—	—	—
1979-80	8	ALL	IBM-7011	18-5303	18-5345 ①	18-5407	18-5369	18-5255 ⑤	—	18-5298
1981-85	8	ALL	IBM-7013	18-5303	18-5345 ①	18-5403	18-5352	18-5260 ⑥	—	18-5299

① For Strap Type Condenser, Use 18-5347
 ② Two Required

③ Contact Controlled Distributor
 ④ Electronic Ignition Distributor

⑤ 18-5277 Kit with distributor cap
 ⑥ 18-5275 Kit with distributor cap

NEW





18-6835 STARTER
 Replaces: GM Engines Universal
 Used on Buick, Chevrolet, Oldsmobile, and Pontiac Race Engines



18-5911 STARTER
 Replacement Solenoid: 18-5837

18-5900 REMANUFACTURED STARTER (Heavy-Duty) (No Core)
 Replacement Solenoid: 18-5831
 For GM Engines, Bottom Mount Straight Across Bolt Pattern, Standard Rotation, Clockwise
 Replaces: 16.61-00042

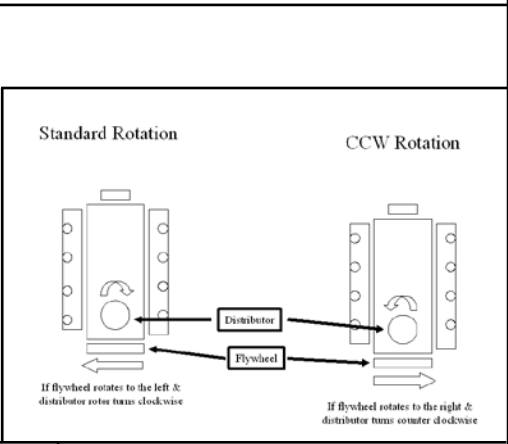
SAEJ1171

BATTERY CABLES
 Gauge cable with soldered lug terminals on each end to accept a 3/8" stud

Part #	Size	Color	Gauge	Part #	Size	Color	Gauge
BC88523	2'	red	4	BC88563	6'	red	2
BC88533	2'	black	4	BC88573	6'	black	2
BC88543	4'	red	2	BC88583	8'	red	1
BC88553	4'	black	2	BC88593	8'	black	1



18-5838 SOLENOID
 Delco



18-5717 STARTER BRUSH SET
 Delco



18-5840 SOLENOID
 Prestolite 15-79, SAW4201, SAW4207, SAW4210



18-5710 VOLTAGE REGULATOR
 Prestolite VSH-6201JY



18-5712 VOLTAGE REGULATOR
 Replaces: 16.60-00031
 Prestolite VSH-6201ACY

APPLICATION ON NEXT PAGE

VOLTAGE REGULATOR, BRUSH SET, STARTER SWITCH APPLICATION

Year	Model	Volt	Original Alt. or Gen.	Volt. Reg.	Original Starter No.	Brush Set	Starter Switch
1979-85	ALL	12	—	—	—	—	18-5840
1967-78	283,F,305,307,327,F,350,454	12	ALE,6207AY,Y,YS & ALE-6221AY,Y	18-5712	MHA,MDY,MDU 1108366,417	18-5717	18-5840 18-5838
1961-78	283,O,F,307,327,F,Q,427,F 430,H,430-0,430-HO	12	ALD-5006	—	MDY-6007,8	—	18-5840
		12	ALE-5202,B,Y	—	MDU-7032,3,4,5	—	18-5840
		12	ALE-5203	—	MHA-7005,6,9 10,12,13	—	18-5840
1947-66	K,KR,KRO,KS,KSO,KO,M,ML MLO,MO,W,WO Series	12	—	—	MAS-4011,2	—	18-5840
		12	GFW	—	MAU	—	18-5840
		12	—	—	MBG	—	18-5840
		12	—	—	MDL	—	—
1961-65	430H,430,HO	12	GHW-4807,8	—	MDL-6007	—	18-5840

18-7019
CARB KIT



18-7022
CARB KIT



18-7023
CARB KIT



18-7025
CARB KIT



18-7070
CARB KIT



18-7072
CARB KIT



18-7095
CARB KIT



18-7732
CARB KIT



18-7200
FLOAT
(ALCOHOL RESISTANT)
Brass



18-7201
FLOAT
(ALCOHOL RESISTANT)
Brass



APPLICATION ON NEXT PAGE

CARBURETOR KIT/FLOAT APPLICATION

Cyl.	Eng./Model	Mfg. Code	Carb. Model	Carburetor	Float Number	Carb. Kit ①
4	A & B (1942-55)	Z-1	63M2E10	8963, A-J	—	18-7732
4	K (1939-55)	Z-1	63M2AWEII	8983, A-H	—	18-7732
4	B (1947-Up)	Z-1	63M2E10	12206	—	18-7732
4	K (1956-62)	Z-1	63M2E11	12091, A	—	18-7732
4	153" (2.5L), 181" (3.0L)	R-2	2GC	7041187, 7042181, 17059055	18-7200	18-7070
6	225" (3.7L)	R-2	2GC	7025181, 189	—	18-7070
8	283" (4.6L)	R-2	2GC	7019082	18-7200	18-7070
8	283" (4.6L)	R-4	4GC	7013071, 7015090	—	18-7019
8	283" (4.6L)	C-4	WCFCB	2669, 3205	—	18-7025
8	283" (4.6L), 307" (5.0L), 327" (5.3L)	C-4	AFB	3660, 6310	—	18-7022
8	305" (5.0L), 350" (5.7L)	R-4	4MC	17056287, 17058280	18-7201	18-7072
8	305" (5.0L), 350" (5.7L), 454" (7.4L)	R-4	4MV	17059294, 17059295, 17059296	18-7201	18-7095
8	307" (5.0L), 327" (5.3L), 350" (5.7L)	C-4	AVS	4695, 6117	—	18-7023
8	307" (5.0L), 454" (7.4L)	R-4	4MV	7044283, 7044288, 7044289	18-7201	18-7072

① Does not include metering rods



**18-8114
FUEL LINE HOSE
UNIVERSAL**

For fuel pump to carburetor connection. Replaces copper or steel tubing 3/8" X 31" PTFE composite hose with 5/8"-18 male inverted flare straight one end, 5/8"-18 90° one end. SAE J1527 type A1



**18-8115
FUEL LINE HOSE
UNIVERSAL**

For fuel pump to carburetor connection. Replaces copper or steel tubing 3/8" X 25" PTFE composite hose with 5/8"-18 male inverted flare straight one end, 5/8"-18 90° one end. SAE J1527 type A1



**18-7260
FUEL PUMP**

(Flange I.D. #40155, M3120)
For: GM (V-8) 283, 307, 327, 350, 409



**18-7265
FUEL PUMP**

Replaces: 16.83-08758, FI8308762
(Flange I.D. #41412)
For: GM (V-8) 305, 350, 400



**18-7272
FUEL PUMP**

(Flange I.D. #41419, M73020)
For: GM (V-8) 283, 305, 350, 400



**18-7278
FUEL PUMP**

(Flange I.D. #60032)
For: GM (4 & 6 Cyl.) 153,
181, 250, 224, 225



**18-3583
CIRCULATING WATER PUMP
(Bi-Directional)**

ALL SIERRA FUEL PUMPS INCLUDE MOUNTING GASKET

FUEL WATER SEPARATORS



Sierra offers a complete line of 10 and 21 micron fuel water separating filters including drainable bowl filters to protect your carbureted and fuel injected engine.

Refer to pages 126-130 for a complete listing of OEM and universal applications.

Sierra fuel water separators remove over 99.8% of emulsified water from your gasoline. Sierra's 10 micron filters are over 90% efficient at removing particles as small as 10 micron. All filters flow @ 90 GPH to feed even the hungriest motor. Sierra 10 micron filters are recommended to prevent damage to sensitive inboard and outboard fuel injection systems.

Sierra #	Chris-Craft #	Description
18-7860	16.83-90006	Fuel Filter
18-7964	—	Transmission Filter

②18-4456D   18-4456 EXHAUST PROTECTOR VALVE Includes Stainless Steel Clamp 3"	②18-4457D   18-4457 EXHAUST PROTECTOR VALVE Includes Stainless Steel Clamp 4"	②18-4458D   18-4458 EXHAUST PROTECTOR VALVE Includes Stainless Steel Clamp 5" & 6"	PKG. OF 8  FREEZE PLUGS 18-5961 18-5962 18-5961-9① 18-5962-9① 1 5/8" 1 3/4"
---	---	---	--

① Priced per Package

② Items ending in "D" are Display Packaged - Regular number is Non-Display



Fits GM Small Block V8 283-350 cu. in.

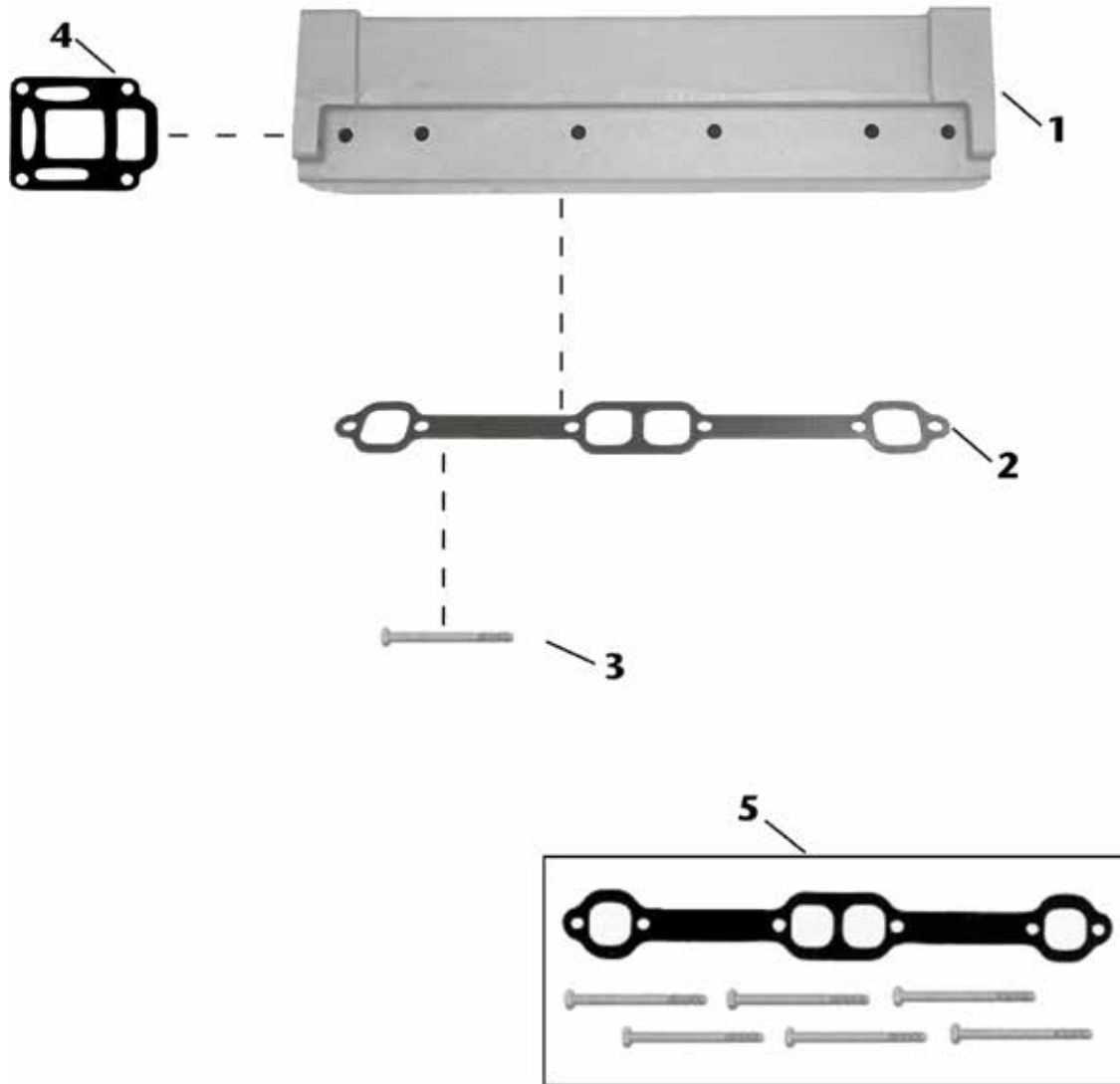

Item No	Description	OE No.	Application
1	18-1914 MANIFOLD	7056, 7686	Fits: GM Small Block 283-350 cu.in. (Port & Starboard). Use Mounting Kit 18-8516.
2	18-2949 MANIFOLD GASKET	N/A	Use with Manifold: 18-1914. Included in 18-8516 mounting kit.
3	NSS MOUNTING BOLT	N/A	Included in 18-8516 mounting kit.
4	18-0470 END PLATE GASKET	N/A	Use with Manifold: 18-1914. Fits both ends. (Port & Starboard)
5	18-8516 MOUNTING KIT	N/A	Use with Manifold: 18-1914. Includes 18-2949 gasket & mounting bolts (NSS).

Use Existing Risers, Elbows & End Plates as they are no longer available

SIERRA MANIFOLDS ARE PAINTED, PACKAGED AND LEAK TESTED



**18-1997-1
MANIFOLD**
Port & Starboard
Replaces: Barr CHV-1-83
Universal Center Riser Manifold
FITS:
Chriscraft 283, 302, 307 and 350 CID engines
Crusader 283 and 327 CID engines thru 1964; 305,
307 and 350 CID engines 1965 and later
Daytona 200-283 and 300-327
Flagship 283, 327 and 350 CID engines
Pacer 305, 307 and 350 CID engines 1965 and later
Mercury 190, 198, 225, 250, 270, 228, 898, 260, 255 and 280 models
OMC 283, 305, 307 and 350 CID engines 1968-1980
Volvo 307 and 350 CID engines
Use 18-0604 Exhaust Manifold Gasket Set
***For Exploded View - See Pages 558-559**

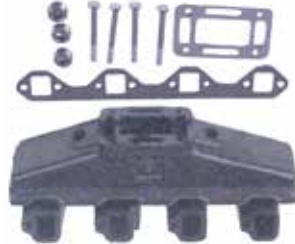

**18-1998-1
MANIFOLD**
Port & Starboard
Replaces: Barr FM-1-83
Universal Center Riser Manifold
FITS:
Crusader 302 and 351 CID engines
Interceptor 221, 260 and 289 CID engines
Commander, Mercury, OMC, Palmer, Pleasurecraft & Waukesha
Comes with 18-4363 Mounting Package
Use 18-0603 Exhaust Manifold Gasket Set
***For Exploded View - See Pages 560-561**



**18-1914
MANIFOLD**
Port & Starboard
Replaces: Chris Craft 7056, 7686
Chris Craft GM Small Block 283-350 cu.in.
Use with:
Exhaust Gasket: 18-2949
Mounting Kit: 18-8516
End Plate Gasket: 18-0470



**18-1898
MANIFOLD**
Port & Starboard
Replaces: Barr CHVA-1-84,
Marine Power 0991-110
Fits 454 cu.in. GM big block V8 engines
Use with:
Exhaust Gasket: 18-0418
Riser Gasket: 18-2854 open or 18-0476 blocked
***For Exploded View - See Pages 556-557**



**18-1999
ELBOW**
Replaces: Barr 20-0082
Comes with 18-4364 open Mounting Package
If blocked mounting kit is required use 18-8535
Use with:
Manifold: 18-1997-1 or 18-1998-1
Riser Gasket 18-2854 open or
18-0476 blocked



**18-1907
RISER**
Replaces: Barr 20-0102,
Indmar 53-2009, 53-2018
Barr and Indmar Ford Small Block V8
302-351cu.in.
Use with:
Manifolds: 18-1997-1 or 18-1998-1
Riser Gasket: 18-2854 open or
18-0476 blocked
Mounting Kit: 18-4364 open or
18-8535 blocked



**18-1939
RISER**
Replaces: Barr 20-0100,
Marine Power 0992-593
Barr, Indmar and Marine Power Ford
Small Block V8 302-351cu.in., GM Small
Block V8 305-350cu.in., GM Big Block
V8 454cu.in.
Used with:
Manifolds: 18-1898 or 18-1997-1
or 18-1998-1
Riser Gasket: 18-2854 open or
18-0476 blocked
Mounting Kit: 18-4364 open or
18-8535 blocked



**18-1991
ELBOW ADAPTER**
For use with 3" I.D. Exhaust Hose
Use with:
Manifold Riser: 18-1999
30°



**18-1992-1
EXHAUST ELBOW**
For 3" I.D. Exhaust Hose
(As used in 18-1987 Exhaust Manifold Conversion Kit)
80°



**18-1949
MANIFOLD SPACER**
Barr, Indmar and Marine Power Ford
Small Block V8 302-351cu.in., GM Small
Block V8 305-350cu.in.,
GM Big Block V8 454cu.in.
Used with:
Manifolds: 18-1998-1,
18-1997-1 and 18-1898



PIPE PLUGS

Part #	Thread Size
18-4256	1/4"
18-4257	1/4"
18-4258	3/4"
18-4263	1/8" - 27 NPT
18-4264	3/8" - 18 NPT

56507 Pipe Sealant with Teflon® is recommended for use on plug threads.



18-4461
HOSE BARB
3/4" - 14 NPT x 1" Hose
Corrosion Resistant Brass Fitting

① **18-4218D**



18-4218
DRAIN TAP
Used with:
Most O.E.M. Manifolds
18-3223-9
Bulk Pack of 12
1/4"



18-4363
EXHAUST ELBOW KIT
Replaces: Barr FM-1-83-P
Use with:
Manifold: 18-1998-1



18-4364 (Open)
EXHAUST ELBOW KIT
Replaces: Barr 20-0082-P
Use with:
Riser: 18-1999, 18-1907, 18-1939



18-8516
EXHAUST MANIFOLD MOUNTING KIT
Chris Craft GM Small Block V8
283-350cu.in.
Used with:
Manifold: 18-1914



18-8535
EXHAUST MANIFOLD MOUNTING KIT
Barr, Indmar and Marine Power Ford Small
Block V8 302-351 cu.in., GM Small Block V8
305-350 cu.in., GM Big Block V8 454cu.in.
Used with:
Risers: 18-1939, 18-1999, and 18-1907
(Blocked)



18-8536
EXHAUST ELBOW MOUNTING KIT
Barr, Indmar and Marine Power
GM Small Block V8 305-350cu.in.
Used with:
Manifold: 18-1997-1



18-8538
EXHAUST MOUNTING KIT
Barr and Indmar Ford Small
Block V8 302-351cu.in.
Used with:
Manifold: 18-1998-1



18-0603
**EXHAUST MANIFOLD
GASKET SET**
Use with:
Manifold: 18-1998-1
For: FORD 302/351 CID Engines

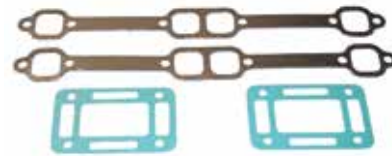

18-0604
**EXHAUST MANIFOLD
GASKET SET**
Use with:
Manifold: 18-1997-1
For: GM 305/350 CID Engines

① Items ending in "D" are Display Packaged - Regular number is Non-Display

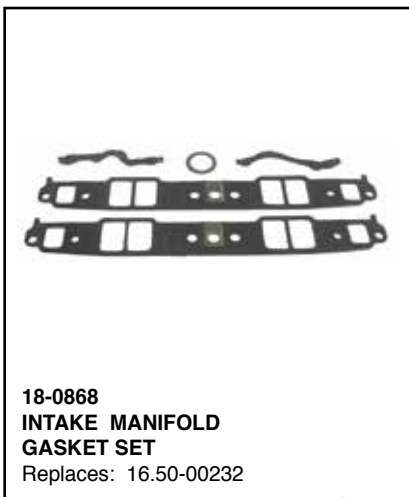

18-0868
INTAKE MANIFOLD
GASKET SET
 Replaces: 16.50-00232



18-0470
EXHAUST ELBOW GASKET
 GM Small Block V8
 283-350cu.in.
 Use with:
 Manifold: 18-1914
 (Port & Starboard)



18-0476
RISER BLOCKOFF GASKET
 Barr, Indmar & Marine Power
 Ford Small Block V8
 302-351 cu.in.
 Used with:
 Risers: 18-1939, 18-1999
 and 18-1907
 Blocked



PKG. OF 2
18-2854 (Open)
18-2854-9①
EXHAUST ELBOW GASKET
 Replaces: Barr 01-0107
 Use with:
 Riser: 18-1999, 18-1939,
 18-1907

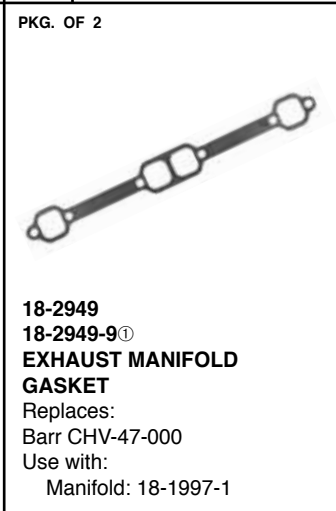

PKG. OF 2
18-2949
18-2949-9①
EXHAUST MANIFOLD
GASKET
 Replaces:
 Barr CHV-47-000
 Use with:
 Manifold: 18-1997-1

MARINE OIL FILTERS



18-7824
 (Short)
 GM 153, 181, 250
 Replaces: 16.81-08746
 For models 307G, 305K, 307K

18-7875
 FORD 302, 351
 (Long)
 Replaces:
 16.81-06536

18-7876
 (Long)
 GM 283, 305, 307,
 350, 454

SEE PAGES 152-154 FOR ADDITIONAL INFORMATION



18-2946
HEAD GASKET
 Replaces: 16.50-00204
 For: GM 181 CID Eng. (3.0L)



18-3876
HEAD GASKET
 Replaces: 16.50-00250
 For: GM 305/350 CID Eng.
 (5.0L and 5.7L)



18-3877
HEAD GASKET
 Replaces: 16.50-00259
 For: GM 454 CID Eng. (7.4L)



PKG. OF 2
18-0874
18-0874-9①
DISTRIBUTOR
GASKET
 Replaces: 16.50-00162
 GM V-6 7 V-8

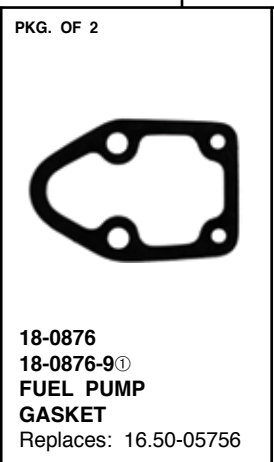

PKG. OF 2
18-0876
18-0876-9①
FUEL PUMP
GASKET
 Replaces: 16.50-05756

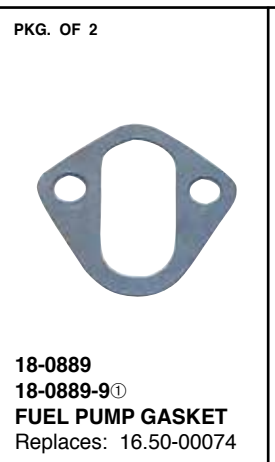

PKG. OF 2
18-0889
18-0889-9①
FUEL PUMP GASKET
 Replaces: 16.50-00074

























PKG. OF 2
18-0891
18-0891-9①
WATER PUMP GASKET
 Replaces: 16.50-00078



PKG. OF 2
18-2845
VALVE COVER GASKET
 Replaces: 16.11-01236
 V-8

SEE PAGES 166-167 FOR OUR COMPLETE LINE OF GASKET SEALANTS

① Priced per Package

<p>①18-5251D Display Package</p>  <p>18-5251 TUNE-UP KIT —CONTAINS—</p> <table border="0"> <thead> <tr> <th>Part #</th> <th>Description</th> </tr> </thead> <tbody> <tr> <td>18-5314</td> <td>Contact Set</td> </tr> <tr> <td>18-5338</td> <td>Condenser</td> </tr> <tr> <td>18-5404</td> <td>Rotor</td> </tr> <tr> <td colspan="2">Mallory 8 cyl. Tall Cap</td> </tr> </tbody> </table>	Part #	Description	18-5314	Contact Set	18-5338	Condenser	18-5404	Rotor	Mallory 8 cyl. Tall Cap		<p>Display Package</p>  <p>18-5255 TUNE-UP KIT —CONTAINS—</p> <table border="0"> <thead> <tr> <th>Part #</th> <th>Description</th> </tr> </thead> <tbody> <tr> <td>18-5303</td> <td>Contact Set</td> </tr> <tr> <td>18-5345</td> <td>Condenser</td> </tr> <tr> <td>18-5407</td> <td>Rotor</td> </tr> <tr> <td colspan="2">Prestolite 8 cyl.</td> </tr> </tbody> </table>	Part #	Description	18-5303	Contact Set	18-5345	Condenser	18-5407	Rotor	Prestolite 8 cyl.		<p>①18-5258D Display Package</p>  <p>18-5258 TUNE-UP KIT —CONTAINS—</p> <table border="0"> <thead> <tr> <th>Part #</th> <th>Description</th> </tr> </thead> <tbody> <tr> <td>18-5303</td> <td>Contact Set</td> </tr> <tr> <td>18-5347</td> <td>Condenser</td> </tr> <tr> <td>18-5407</td> <td>Rotor</td> </tr> <tr> <td colspan="2">Prestolite 8 cyl.</td> </tr> </tbody> </table>	Part #	Description	18-5303	Contact Set	18-5347	Condenser	18-5407	Rotor	Prestolite 8 cyl.		 <p>18-5259 TUNE-UP KIT —CONTAINS—</p> <table border="0"> <thead> <tr> <th>Part #</th> <th>Description</th> </tr> </thead> <tbody> <tr> <td>18-5303</td> <td>Contact Set</td> </tr> <tr> <td>18-5347</td> <td>Condenser</td> </tr> <tr> <td>18-5429</td> <td>Rotor</td> </tr> <tr> <td colspan="2">Prestolite 6 & 8 cyl.</td> </tr> </tbody> </table>	Part #	Description	18-5303	Contact Set	18-5347	Condenser	18-5429	Rotor	Prestolite 6 & 8 cyl.	
Part #	Description																																										
18-5314	Contact Set																																										
18-5338	Condenser																																										
18-5404	Rotor																																										
Mallory 8 cyl. Tall Cap																																											
Part #	Description																																										
18-5303	Contact Set																																										
18-5345	Condenser																																										
18-5407	Rotor																																										
Prestolite 8 cyl.																																											
Part #	Description																																										
18-5303	Contact Set																																										
18-5347	Condenser																																										
18-5407	Rotor																																										
Prestolite 8 cyl.																																											
Part #	Description																																										
18-5303	Contact Set																																										
18-5347	Condenser																																										
18-5429	Rotor																																										
Prestolite 6 & 8 cyl.																																											
<p>①18-5260D Display Package</p>  <p>18-5260 TUNE-UP KIT —CONTAINS—</p> <table border="0"> <thead> <tr> <th>Part #</th> <th>Description</th> </tr> </thead> <tbody> <tr> <td>18-5303</td> <td>Contact Set</td> </tr> <tr> <td>18-5345</td> <td>Condenser</td> </tr> <tr> <td>18-5403</td> <td>Rotor</td> </tr> <tr> <td colspan="2">Prestolite 8 cyl.</td> </tr> </tbody> </table>	Part #	Description	18-5303	Contact Set	18-5345	Condenser	18-5403	Rotor	Prestolite 8 cyl.		 <p>18-5303 CONTACT SET Replaces: 2421173, 2808870</p>	 <p>18-5307 CONTACT SET Replaces: 2084074, 1274092, 2421178</p>	 <p>18-5314 CONTACT SET Replaces: 2421820</p>																														
Part #	Description																																										
18-5303	Contact Set																																										
18-5345	Condenser																																										
18-5403	Rotor																																										
Prestolite 8 cyl.																																											
 <p>18-5338 CONDENSER</p>	 <p>18-5345 CONDENSER Replaces: 2098058, 2279949</p>	 <p>18-5347 CONDENSER Replaces: 1818757, 3420600</p>	 <p>18-5403 ROTOR</p>																																								
 <p>18-5404-1 ROTOR Replaces: 868096</p>	 <p>18-5407 ROTOR Replaces: 1658535</p>	 <p>18-5429 ROTOR Replaces: 2098611</p>	 <p>18-5430 ROTOR Replaces: 868095</p>	 <p>18-5300 ROTOR Fits: Flamethrower Distributors</p>																																							
 <p>18-5352 DISTRIBUTOR CAP Replaces: 4142817</p>	 <p>18-5369 DISTRIBUTOR CAP (With Gasket 18-5399) Replaces: 4142408</p>	 <p>18-5376 DISTRIBUTOR CAP</p>	 <p>18-5473 DISTRIBUTOR CAP Black Distributor Cap w/ Male Terminals Petronix Dsistributors</p>	 <p>18-5474 DISTRIBUTOR CAP Red Distributor Cap with Male Terminals Petronix Dsistributors</p>																																							

① Items ending in "D" are Display Packaged - Regular number is Non-Display

NEW



**18-5301
TUNE-UP KIT**
Replaces:
Fits: male cap v-8 flamethrower distributors

NEW



**18-5302
TUNE-UP KIT**
Replaces:
Fits: male cap v-8 flamethrower distributors

Standard Rotation

CCW Rotation

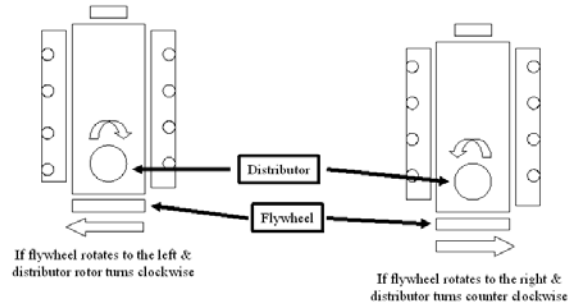

**18-5484-1
ELECTRONIC DISTRIBUTOR**
Left Hand Rotation
Replaces: Mallory YLE624AV
Late Model HEI
For V8 — 262-454 & 502 except 384/409 and tall block engines
• Designed as a plug-in replacement for GM-style fuel injection system distributors

—CONTAINS—

Description	Part #
Distributor Cap	18-5354
Rotor	18-5405



**18-5485
ELECTRONIC DISTRIBUTOR**
Right Hand Rotation
Replaces: Mallory YLE624BV
Late Model HEI
For V8 — 262-454 & 502 except 384/409 and tall block engines
• Designed as a plug-in replacement for GM-style fuel injection system distributors

—CONTAINS—

Description	Part #
Distributor Cap	18-5354
Rotor	18-5405



**18-5497-1
ELECTRONIC DISTRIBUTOR**
U.L. Approved • Conventional Rotation
For: Chrysler V-8 273, 318 (1967-Up), 340, 360 CID
"LA" Engines

USES:

Part #	Description
18-5376	Distributor Cap
18-5404-1	Rotor
18-5491	Reluctor
18-5488	Module

PREMIUM MARINE SPARK PLUG WIRE LEADS

MAGFORCE™



OE style boots provide a sealed barrier against heat, dirt and moisture.

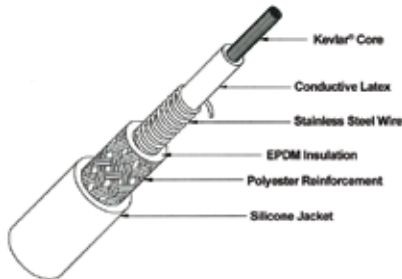

Premium Marine Wire Leads
Magnetic Suppression Core
Manufactured for your specific application

- Kevlar® core for maximum durability and long life.
- Durable stainless steel wound conductor for maximum horsepower and engine performance.
- Premium silicone jacketing and boots for the ultimate in high temperature protection.
- Superior RFI suppression for the most sensitive electronic system.
- Corrosion resistant stainless steel spark plug and distributor terminals for maximum conductivity.

Model	Ignition Type	Cyl.	Part #
318/ 340/ 360	Electronic & Conventional	8	18-8826-1
361 / 383 / 440	Electronic & Conventional	8	18-8827-1

Ignitor® II **FEATURES**
ELECTRONIC IGNITION

- *Senses current levels in the coil and adjusts the dwell to maintain peak energy throughout the entire RPM range.*
- *Develops, on average, 4 times more available energy between 3000 and 5000 RPM's and twice as much plug voltage as point-type systems.*
- *Ignition energy is sustained and coil life is increased when peak current level is reached just prior to spark.*
- *More stable timing.*
- *Use with 18-5472 "Flame Thrower II" Coil for optimum performance*

**18-5286
HI-PERFORMANCE
ELECTRONIC
CONVERSION KIT**
Fits: 6 Cylinder Delco Distributors





FEATURES

- ★ Replaces points & condensers for true solid state ignition.
- ★ Uses standard coil, cap and rotor.
- ★ Easy to install, one-piece, 2-wire hook-up.
- ★ Accurate to within 1/4° timing accuracy 0 to 6000 RPM range.
- ★ Can be used with Flame Thrower Coil 18-5469

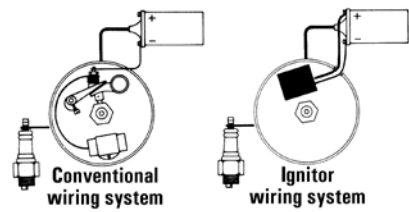

18-5294
ELECTRONIC CONVERSION KIT
Fits 6 cyl. Delco distributors

18-5295
ELECTRONIC CONVERSION KIT
Fits most 4 cyl. Prestolite distributors. (Except IBM 7026)
For: Onan, Universal, Waukesha, Wisconsin

18-5434
IGNITION COIL
Replaces: 201522, 2495531
Uses External Resistor

18-5435
IGNITION COIL
Replaces: 200691
Has Internal Resistor

FEATURES

- Oil filled for better cooling and long life
- Low resistance and improved turn ratios produces the higher voltage needed to run larger spark plug gaps for added power and better fuel economy
- More windings maximize energy and reliability over the full RPM range
- Fits existing brackets for easy installation

18-5469
HI-PERFORMANCE IGNITION COIL
3.0 ohm (oil filled), black - 4 & 6 cylinder:
Flame-Thrower 40,000 volt coil.

- Designed for use with the original Ignitor Electronic Conversion Kits
- Can be used with other inductive ignition systems

18-5472
HI-PERFORMANCE IGNITION COIL
0.6 ohm (oil filled), black - 4, 6, & 8 cylinder:
Flame-Thrower 45,000 volt coil.

- Super low 0.6 ohm resistance coil designed for use with the Ignitor II Hi Performance Electronic Conversion Kits
- Compatible with capacitive discharge systems

Sierra Part #	Description	Recommended Coil	Resistance Ohms
18-5294	Electronic Conversion Kit	18-5469	3.0
18-5295	Electronic Conversion Kit	18-5469	3.0
18-5286	Hi Performance Electronic Conversion Kit	18-5472	0.6

18-5450
COIL RESISTOR
Replaces: 4106140

18-5451
COIL RESISTOR
Replaces: 3874767

18-5102
RELUCTOR
Replaces: 3656017

18-5103
IGNITION PICKUP
Replaces: 3780600

18-5105
IGNITION MODULE
Replaces: 3874020



18-5840 SOLENOID
Replaces: Prestolite 15-79, SAW4201, SAW4207, SAW4210



18-5841 SOLENOID
Replaces: 1692658 Prestolite



BATTERY CABLES
Gauge cable with soldered lug terminals on each end to accept 3/8" stud.

Part No.	Size	Color	Gauge	Part No.	Size	Color	Gauge
BC88523	2'	red	4	BC88563	6'	red	2
BC88533	2'	black	4	BC88573	6'	black	2
BC88543	4'	red	2	BC88583	8'	red	1
BC88553	4'	black	2	BC88593	8'	black	1

BRUSH SET/STARTER SWITCH APPLICATION

Year/Model	Volt	Original Starter No.	Starter Switch
1960-88	12	MCL-6115	—
LM318X,340X,M80A,	12	MDT-6010,11	18-5840
81,170A,M225A, X,M251X,	12	MDT-7001,10	18-5841
265X,273X,M318,A,B,C,	12	MDT-7002,14	18-5840
X,M383BX,M413,B,D,E,	12	MDT-7021,22	—
X,M426B,D,E,X,M440,	12	MDU-6003,10	18-5841X,M155,200,225,
250,260,300,335,375	12	MDU-7001	18-5841
1961-69	12	MDT-6010,11	18-5841
M225,MH225,M273,A,B,	12	MDT-7002,14	18-5841
LM318,B,M318A,B,C,	12	2095150	18-5841
M383,B,X,M413,E,M426	12	1779955	18-5841
B,D,X,M426 Hemi	12	2,095,393,509	18-5841
	12	2095509	18-5841
	12	MDT-7002,14	18-5841
	12	MDT-7001,10	18-5841
	6 & 12	MDT-7001,10	18-5841
1959-69	12	MDU-6003,10	18-5841
	12	MDT-7001,10	18-5841
	12	MDT-7002	18-5841
1961-68	12	MDT-6010,11	18-5840
1961-65	12	MDU-7001	18-5841
1955-71	6	MCL-6102,M,07	—
M26,46,46-4 (Ace),M27,	6	MCL-6127,28,M	—
47,47-4, (Crown),M28,	12	MCL-6020M	—
36,37,38,44,44-3,48	12	MCL-6115	—
(Royal)M45(Imperial),	12	MDT-6010,11M	18-5840
M45-3,46-3,47-3,M49	12	MDU-7013	—



18-9802 TIMING LIGHT
Self-powered accurate up to 10,000 RPM's

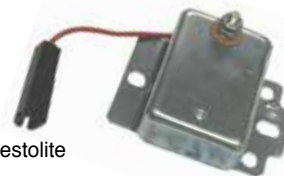

18-5710 VOLTAGE REGULATOR
Replaces: 2847527, 2098300 Prestolite VSH-6201JY

Year/Model	Volt	Original	Alt/Gen. No.
1970-88	12	M273X,LM318X	ANE-5201S,2S,2YS
1972-77			3527502
225,318X,340,X,400,440	12		

18-5723 VOLTAGE REGULATOR (Field Relay)
Replaces: 2095946 (Use with 18-5710)



Year/Model	Volt	Original	Alt/Gen. No.
1961-70	12	ALTR OUT BATTERY IGNITION	2095860
B,D,X, M426 Hemi			

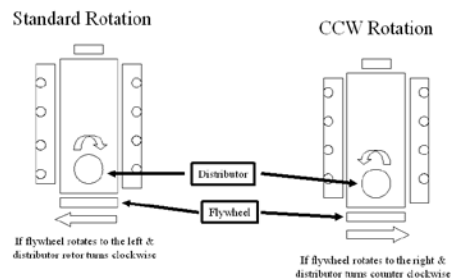

18-6270 PERMANENT MAGNET I/O Starter
Heavy Duty - 12 Volt
2 Bolt Mount - 1 Threaded Hole - CW Rotation
Fits: Ford 460
Permanent Magnet I/O



18-6835 STARTER
Replaces: GM Engines Universal
Used on Buick, Chevrolet, Oldsmobile, and Pontiac Race Engines



18-5954 ALTERNATOR
Replaces: 3527501, 3527502, 3744870
61 Amps



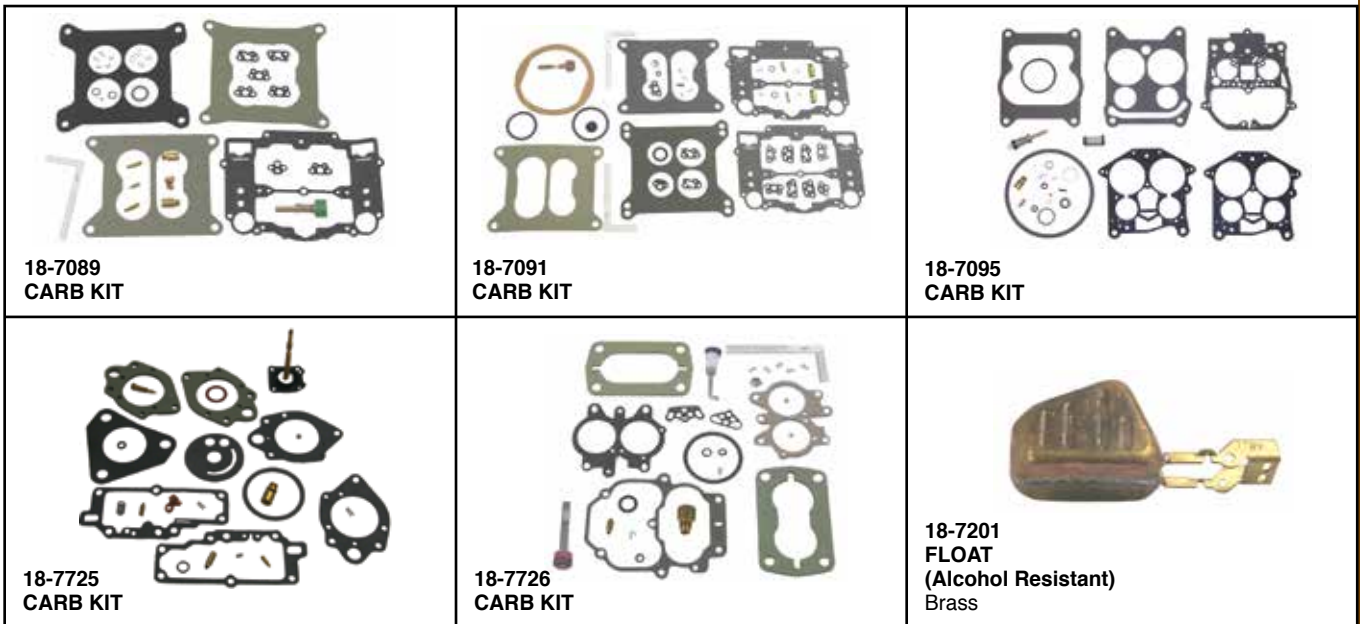

CARBURETOR KIT/FLOAT APPLICATION

Years	Cyl.	Model or Engine Displacement	Mfg. Code	Carb. Model	Carburetor Number	Float	Carb. Kit ①
1965 -Up	8	M-273-B,LM-318-B, M-340-B, M-360-B,M383-B,M-440-B	C-4	AFB	398,061,306,212	—	18-7089
1965-69	8	M-318-B,M-383, M-413,M-426, M-440	C-4	AFB	3213,3214, 3392,3543, 4476,4699,9263, 9264	—	18-7091
—	8	318" (5.2L), 360" (5.9L)	R-4	4MV	17084001,17086115, 17086116	18-7201	18-7095
—	8	M-80, M-81 318" (5.2L), 361" (5.9L) (2 Carb. Installation)	C-1	YH	2911, 3035, 3195	—	18-7725
—	6	M-225, M-225D, MH-225	C-2	BBD	3389, 3390, 4268	—	18-7726
—	8	M273A, M318A, M318G	C-2	BBD	3212, 3979, 3981	—	18-7726

① Does not include Metering Rods.

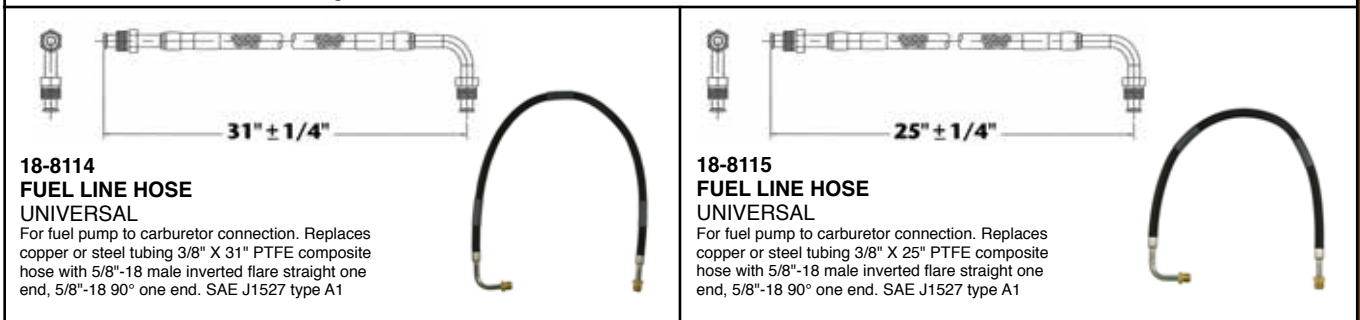

FUEL WATER SEPARATORS



Sierra offers a complete line of 10 and 21 micron fuel water separating filters including drainable bowl filters to protect your carbureted and fuel injected engine.

Refer to pages 126-130 for a complete listing of OEM and universal applications.

Sierra fuel water separators remove over 99.8% of emulsified water from your gasoline. Sierra's 10 micron filters are over 90% efficient at removing particles as small as 10 micron. All filters flow @ 90 GPH to feed even the hungriest motor. Sierra 10 micron filters are recommended to prevent damage to sensitive inboard and outboard fuel injection systems.

Sierra #	Chris-Craft #	Description
18-7964	—	Transmission Filter

ALL SIERRA FUEL PUMPS INCLUDE MOUNTING GASKET



**18-7230
FLAME ARRESTOR**
Replaces: 4142886
Ht. 2.250 Element 1.470
Throat 5.050 1 Vent Tube



**18-7254
FUEL PUMP**
Replaces: 3745414
(Flange I.D. #6766, M6766)
For: (V-8) 318,360



**18-7255
FUEL PUMP**
Replaces: 3745415
(Flange I.D. #6767, M6767)
For: (V-8) 361, 400, 413, 440



**18-7264
FUEL PUMP**
Replaces: 2279913, 1736073
(Flange I.D. #40781, M6866)
For: (V-8) 273, 318, 340, 360



**18-3551
THERMOSTAT**
Replaces: 4142885
142°



**18-3645
THERMOSTAT**
Replaces: 2463441
For: 318 & 360 CID Engines
160°



**18-3060
IMPELLER**
Replaces: Sherwood 9959



**18-3046
IMPELLER KIT**
Replaces: Sherwood 9959K
Contains: 18-3060 Impeller



**18-3047
IMPELLER KIT**
Contains: 18-3061 Impeller



**18-3061
IMPELLER**
Replaces: Sherwood 10615
For: GM engines with V-Belt



**18-3168
SEAL & SEAT**
Replaces: Sherwood 10927
For: 318 CID
Engines (1975-77)
& 360 CID Engines (1975)



**18-3581
CIRCULATING WATER PUMP**
(Bi-Directional)
Replaces: 3004886, 3745985,
3619542, 4417905
For: Engine Models 318, 340 & 360



**18-3582
CIRCULATING WATER PUMP**
(Bi-Directional)
Replaces: 3619859
For: Engine Models 383, 400 & 440



② 18-4456D Display Package
**18-4456
EXHAUST PROTECTOR VALVE**
Includes Stainless Steel Clamp
3"



② 18-4457D Display Package
**18-4457
EXHAUST PROTECTOR VALVE**
Includes Stainless Steel Clamp
4"



② 18-4458D Display Package
**18-4458
EXHAUST PROTECTOR VALVE**
Includes Stainless Steel Clamp
5" & 6"



OIL FILTERS Display Package

Part #	Replaces:
18-7875	1851658 (Long)
18-7878-1	L-19, L-1008, 3549957 (Short)
18-7879	L-319



**18-3878
HEAD GASKET**
Replaces: 4417375



**18-3860
HEAD GASKET**
Replaces: 4142880
For: 318 CID Engines



**18-0609
VALVE COVER GASKET**
Replaces: 4273129
For: 318/340/360 CID

PKG. OF 2



**18-0499
18-0499-9^①
WATER PUMP PLATE GASKET**
Replaces: 10612

SEE PAGES 152-154 FOR ADDITIONAL INFORMATION

① Priced per Package

② Items ending in "D" are Display Packaged - Regular number is Non-Display

PURE FUEL DELIVERS PURE
PERFORMANCE



SIERRA FILTERS

INDUSTRY LEADER IN 10-MICRON TECHNOLOGY

Increased levels of engine sophistication, coupled with ethanol fuel blends, necessitate the use of a high quality fuel filter. Sierra filters are engineered to offer the ultimate in filtration, separation of water from the fuel supply and provide maximum fuel flow.



Explore



www.seastarsolutions.com



SEASTAR
SOLUTIONS®

formerly known as Teleflex Marine

Fits Chrysler Small Block V8 318-360 cu. in. All Models 1966 & up with Fixed Exhaust

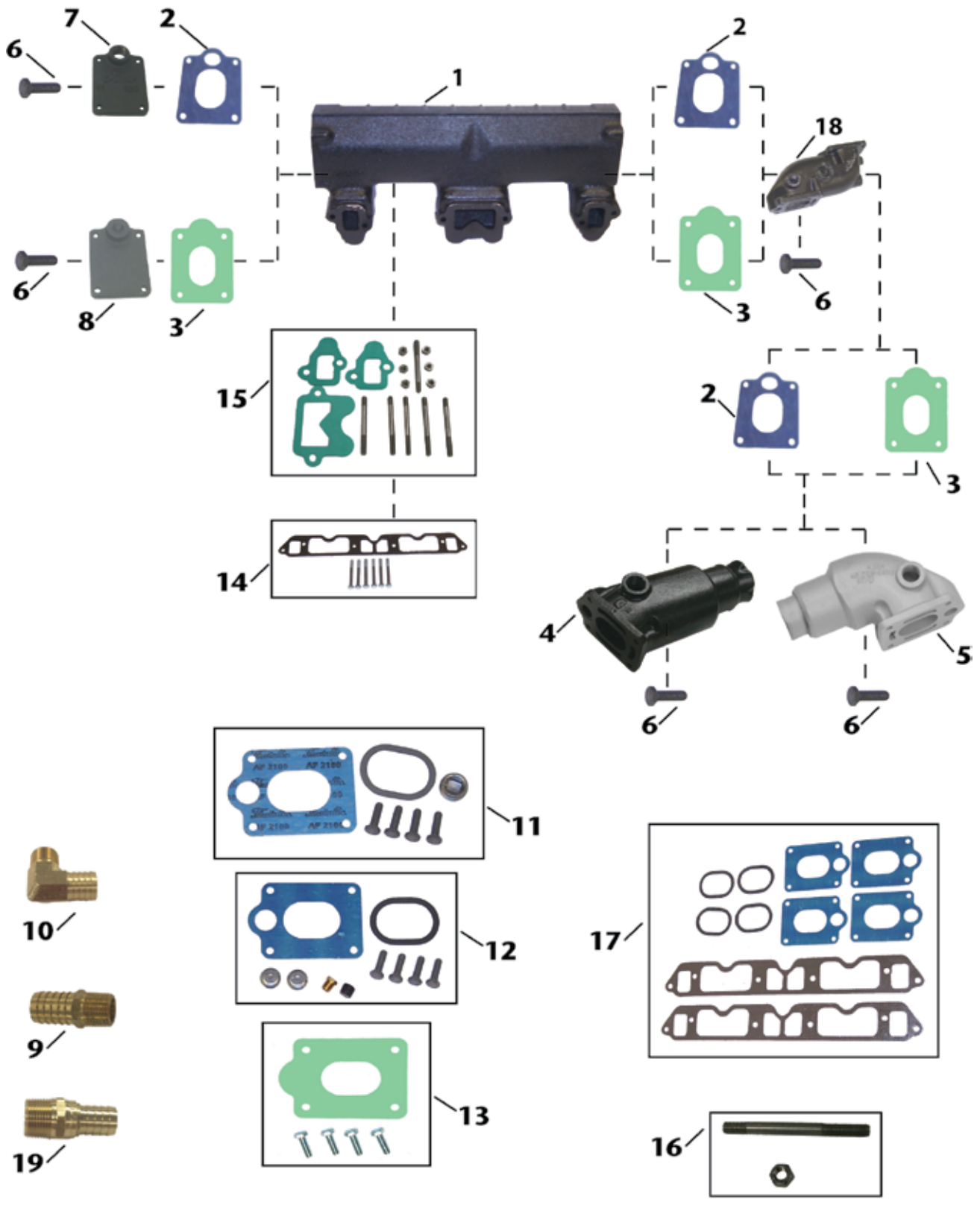

	Item No	Description	OE No.	Application
1	18-1940	MANIFOLD	4142322, 3675826	Chrysler Models 318-360CID Engines (1966 & Up); Use manifold mounting kit 18-8526 or 18-8527 (stainless).
2	18-2941	END CAP GASKET (OPEN)	2847480, 2469559	Fits: End Caps of Manifold (Starboard & Port) 18-1940; Risers: 18-1945; Elbows: 18-1946 & 18-1913
3	18-0472	END CAP GASKET (BLOCKED)	N/A	Fits: End Caps of Manifold (Starboard & Port) 18-1940; Risers: 18-1945; Elbows: 18-1946 & 18-1913
4	18-1946	MANIFOLD ELBOW	3527794	Use in conjunction with 18-1945. 3" exhaust outlet & a 20° down angle.
5	18-1913	MANIFOLD ELBOW 2847405	2469639,	Use in conjunction with 18-1945. 3" exhaust outlet & a 90° down angle.
6	NSS	MOUNTING BOLT	N/A	Included in 18-4360, 18-4361, & 18-8506 mounting kits.
7	18-1942	MANIFOLD END PLATE (OPEN)	2846106	Use with End Plate Gasket: 18-2941 (Open); Mounting Kit: 18-4360 (Open) or 18-4361 (Open); (Port & Starboard) Manifold: 18-1940
8	18-1941	MANIFOLD END PLATE (BLOCKED)	2469556, 3675826	Use with End Plate Gasket: 18-2941; Mounting Kit: 18-4360 or 18-4361; (Port & Starboard) Manifold: 18-1940
9	18-4461	HOSE FITTING	N/A	3/4" - 14NPT X 1" Hose (Corrosion Resistant Brass Fitting)
10	18-8216	HOSE FITTING	N/A	3/4" - 14NPT X 1" Hose (Corrosion Resistant Brass Fitting)
11	18-4360	MOUNTING PACKAGE (OPEN GASKET)	N/A	Use with End Plates: 18-1942 (open) or 18-1941 (Blocked); Riser/Elbow: 18-1945, 18-1946, 18-1913
12	18-4361	MOUNTING PACKAGE (OPEN GASKET)	N/A	Use with End Plates: 18-1942 (open) or 18-1941 (Blocked); Riser/Elbow: 18-1945, 18-1946, 18-1913
13	18-8506	MOUNTING KIT (BLOCKED GASKET)	N/A	Use with Riser/Elbow: 18-1945, 18-1946, 18-1913; End Plate: 18-1941 (Blocked)
14	18-8526	MOUNTING KIT	N/A	Use with Manifold: 18-1940
15	18-8527	MOUNTING KIT (STAINLESS STEEL)	N/A	Use with Manifold: 18-1940 (Kit has stainless steel studs and nuts)
16	18-8528	STAINLESS STEEL STUD & NUT	N/A	Use with Manifold: 18-1940. Included in 18-8527 manifold mounting kit
17	18-4346	EXHAUST MANIFOLD GASKET SET	3745220	318 CID Engines (1969-85)
18	18-1945	MANIFOLD RISER	2846689	Use with Manifold: 18-1940; Riser Gasket: 18-2941 (Open) or 18-0472 (Closed); Mounting Kit: 18-4361 (Open) or 18-4360 (Open) or 18-8506 (Blocked)
19	18-8215	HOSE FITTING	N/A	3/4" - 14NPT X 3/4" Hose (Corrosion Resistant Brass Fitting)

**Fits Chrysler Big Block V8 383-440 cu. in.
All Models Except 413 "E" with Staggered Bolt Pattern**

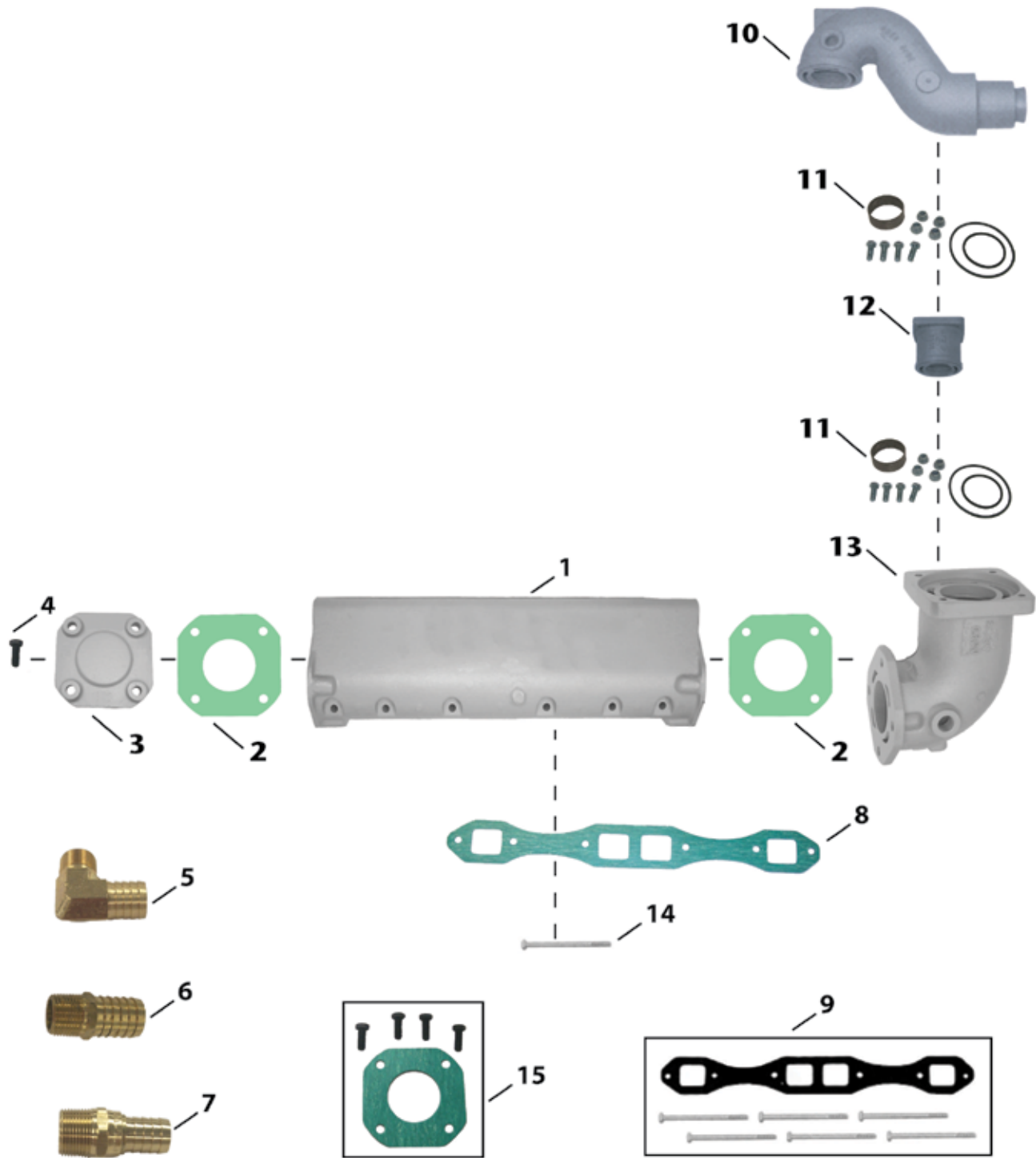

	Item No	Description	OE No.	Application
1	18-1915	MANIFOLD	E7081M, 3619659	Chrysler Models 383-440 cu.in. (V8 Big Block). Use with Manifold Gasket: 18-0474; Mounting Kit: 18-8517; Front Plate: 18-1911
2	18-0471	ELBOW GASKET	N/A	Gasket for Manifold: 18-1915 (Port & Starboard); Elbow:18-1948 ; End Plate: 18-1911
3	18-1911	END/FRONT PLATE	N/A	End/Front Plate for Manifold: 18-1915. Use with Elbow Gasket: 18-0471, &/or Mounting Kit: 18-8501
4	NSS	MOUNTING BOLT	N/A	Included in 18-8501 mounting kit.
5	18-8216	HOSE FITTING	N/A	3/4" - 14NPT X 1" Hose (Corrosion Resistant Brass Fitting)
6	18-4461	HOSE FITTING	N/A	3/4" - 14NPT X 1" Hose (Corrosion Resistant Brass Fitting)
7	18-8215	HOSE FITTING	N/A	3/4" - 14NPT X 3/4" Hose (Corrosion Resistant Brass Fitting)
8	18-0474	MANIFOLD GASKET	N/A	Gasket for 18-1915 Manifold
9	18-8517	MOUNTING KIT	N/A	Big Block (V8) 383-440 cu.in. (All models except 413"E" with offset bolt pattern) Use with Manifold: 18-1915. Includes 18-0474 Manifold Gasket
10	18-1944	RISER	2847404, 2847623, 3745639, E9923M	Use with Manifold: 18-1940; Mounting Kit: 18-8518
11	18-8518	MOUNTING KIT	N/A	Use with Riser: 18-1944 and Extension: 18-6601
12	18-6601	EXTENSION	N/A	Use in conjunction with 18-1948. Use mounting kit: 18-8518.
13	18-1948	RISER	E9234M	Riser for Manifold:18-1915. Use with 18-8501 mounting kit.
14	NSS	MOUNTING BOLT	N/A	Included in 18-8517 mounting kit.
15	18-8501	MOUNTING KIT	N/A	Used with Front Plate: 18-1911; Elbow:18-1948



Fits Chrysler Small Block V8 318-360 cu. in. All Models 1966 & up with Swivel Exhaust

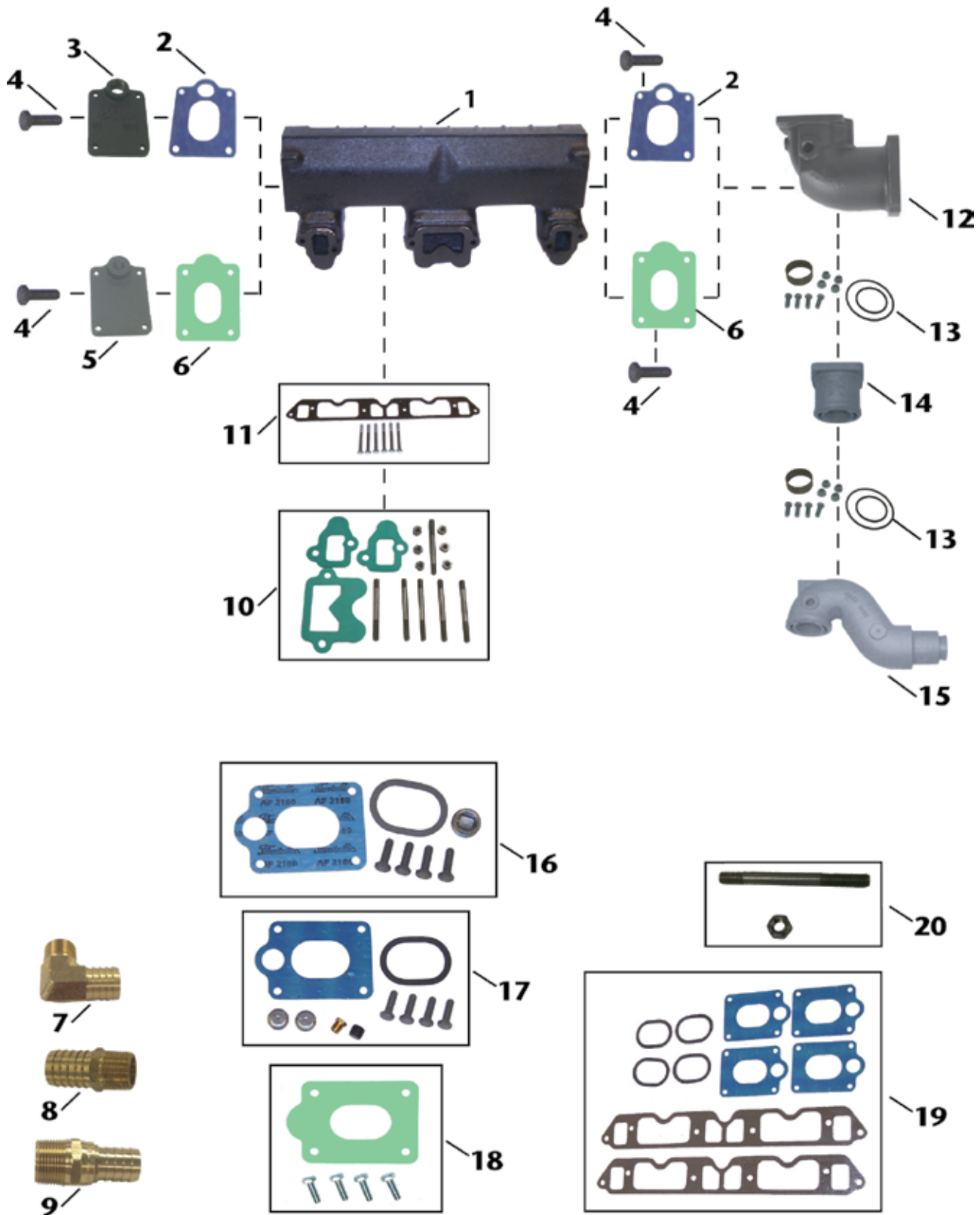

	Item No	Description	OE No.	Application
1	18-1940	MANIFOLD	4142322, 3675826	Chrysler Models 318-360CID Engines (1966 & Up); Use manifold mounting kit 18-8526 or 18-8527 (stainless).
2	18-2941	END CAP GASKET (OPEN)	2847480, 2469559	Fits: End Caps of Manifold (Starboard & Port) 18-1940; Elbow: 18-6600. Included in 18-4360, & 18-4361 mounting kits.
3	18-1942	MANIFOLD END PLATE 3675826	2469556,	Use with End Plate Gasket: 18-2941; Mounting Kit: 18-4360 or 18-4361
4	NSS	MOUNTING BOLT	N/A	Included in 18-4360, 18-4361, & 18-8506 mounting kits.
5	18-1941	MANIFOLD END PLATE	2846106	Use with End Plate Gasket: 18-0472 ; Mounting Kit: 18-8506
6	18-0472	END CAP GASKET (BLOCKED)	N/A	Fits: End Caps of Manifold (Starboard & Port) 18-1940; Elbow: 18-6600. Included in 18-8506 mounting kit.
7	18-8216	HOSE FITTING	N/A	3/4" - 14NPT X 1" Hose (Corrosion Resistant Brass Fitting)
8	18-4461	HOSE FITTING	N/A	3/4" - 14NPT X 1" Hose (Corrosion Resistant Brass Fitting)
9	18-8215	HOSE FITTING	N/A	3/4" - 14NPT X 3/4" Hose (Corrosion Resistant Brass Fitting)
10	18-8527	MOUNTING KIT (STAINLESS STEEL)	N/A	Use with Manifold: 18-1940 (Kit has stainless steel studs and nuts)
11	18-8526	MOUNTING KIT	N/A	Use with Manifold: 18-1940
12	18-6600	ELBOW	2600402	Use with Manifold: 18-1940. Use mounting kit 18-4360, 18-4361, or 18-8506.
13	18-8518	MOUNTING KIT	N/A	Use with Riser: 18-1944 & Extension: 18-6601
14	18-6601	EXTENSION	N/A	Use in conjunction with 18-6600. Use mounting kit: 18-8518.
15	18-1944	RISER	N/A	Use with Manifold: 18-1940; Elbow: 18-6600, and extension: 18-6601. Use with mounting kit: 18-8518
16	18-4360	MOUNTING PACKAGE (OPEN GASKET)	N/A	Use with End Plates: 18-1942 (open) or 18-1941 (Blocked); Riser/Elbow: 18-6600
17	18-4361	MOUNTING PACKAGE (OPEN GASKET)	N/A	Use with End Plates: 18-1942 (open) or 18-1941 (Blocked); Riser/Elbow: 18-6600
18	18-8506	MOUNTING KIT (BLOCKED GASKET)	N/A	Use with End Plate: 18-1941 (Blocked); Riser/Elbow: 18-6600
19	18-4346	EXHAUST MANIFOLD GASKET SET	3745220	318 CID Engines (1969-85)
20	18-8528	STAINLESS STEEL STUD & NUT	N/A	Use with Manifold: 18-1940. Included in 18-8527 manifold mounting kit

SIERRA MANIFOLDS ARE PAINTED, PACKAGED AND LEAK TESTED

**18-1940
MANIFOLD**

Port & Starboard
Replaces: 4142322, 3675826
Fits: Chrysler Model 273, 318, 340 & 360
CID engines (1973-1986)

Use with:
End Cap Gasket: 18-2941 Open or 18-0472 Blocked
Mounting Kit: 18-4360 Open or 18-4361 Open or 18-8506 Blocked
End Plate: 18-1941 Blocked or 18-1942 Open

Note: If using a blocked end plate either gasket will work. If using an open end plate use only an open gasket.



**18-1997-1
MANIFOLD**

Port & Starboard
Replaces: Barr CHV-1-83
Universal Center Riser Manifold

FITS:
Chriscraft 283, 302, 307 and 350 CID engines
Crusader 283 and 327 CID engines thru 1964;
305, 307 and 350 CID engines 1965 and later
Daytona 200-283 and 300-327
Flagship 283, 327 and 350 CID engines
Pacer 305, 307 and 350 CID engines 1965 and later
Mercury 190, 198, 225, 250, 270, 228, 898, 260, 255 and 280 models
OMC 283, 305, 307 and 350 CID engines 1968-1980
Volvo 307 and 350 CID engines

Use 18-0604 Exhaust Manifold Gasket Set
*For Exploded View - See Pages 558-559



**18-1915
MANIFOLD**

Port & Starboard
Replaces: Chrysler E7081M, 3619659
Fits: 383-440 cu.in. Chrysler big block V8

Use with:
Exhaust Manifold Gasket: 18-0474
Mounting Kit: 18-8517
Front Plate: 18-1911



**18-1898
MANIFOLD**

Port & Starboard
Replaces: Barr CHVA-1-84, Marine Power 0991-110
Fits 454 cu.in. GM big block V8 engines

Use with:
Exhaust Manifold Gasket: 18-0418
*For Exploded View - See Pages 556-557



**18-1945
RISER**

Replaces: 2846689
Fits: Chrysler Model 273, 318,
340 & 360 CID engines (1966-1986)

Use with:
Manifold: 18-1940
Riser Gasket: 18-2941 open or 18-0472 blocked
Mounting Kit: 18-4361 open or 18-4360 open or 18-8506 blocked



**18-1939
RISER**

Replaces: Barr 20-0100, Marine Power 0992-593 Barr, Indmar
and Marine Power Ford Small Block V8 302-351 cu.in., GM Small
Block V8 305-350cu.in., GM Big Block V8 454cu.in.

Use with:
Manifold: 18-1997-1 or 18-1998-1 or 18-1898
Riser Gasket: 18-2854 open or 18-0476 blocked
Mounting Kit: 18-4364 open or 18-8535 blocked



**18-1944
RISER**

Replaces: 2847404, 2847623,
3745639, E9923M
Chrysler Small Block V8 318-360cu.in.
(All models 1966 and up with swivel exhaust),
Big Block V8 383-440cu.in. (All models except
413"E" with offset bolt pattern)

Use with:
Manifold: 18-1940
Mounting Kit: 18-8518



**18-1907
RISER**

Replaces: Barr 20-0102, Indmar 53-2009, 53-2018
Barr and Indmar Ford Small Block V8 302-351cu.in.

Use with:
Manifold: 18-1997-1 or 18-1998-1
Riser Gasket: 18-2854 open or 18-0476 blocked
Mounting Kit: 18-4364 open or 18-8535 blocked



**18-6600
ELBOW**

Replaces: 2600402
Fits: all V8 318-360 Small Block (1966 and up) w/Swivel Exhaust





**18-1946
ELBOW**
Replaces: 3527794
Fits Chrysler Model 273, 318,
340 & 360 CID engines (1966-1986)
will work in conjunction with **18-1945**
Use with:
Manifold: 18-1940
Elbow Gasket: 18-2941 open or 18-0472 blocked
Mounting Kit: 18-4360 open or 18-4361 open or 18-8506 blocked
20°



**18-1948
ELBOW**
Replaces: Chrysler E9234M
Chrysler Big Block V8 383-440cu.in.
(All Models except 413"E" with offset bolt pattern)
Use with:
Manifold: 18-1915
Elbow Gasket: 18-0471
Mounting Kit: 18-8501



**18-1913
ELBOW**
Replaces: Chrysler 2469639, 2847405
Chrysler Small Block V8 318-360 cu.in.
(All Models 1966 and up with fixed exhaust)
For: 18-1940 Manifold will work in
conjunction with **18-1945**
Use with:
Elbow Gasket: 18-2941 open or 18-0472 blocked
Mounting Kit: 18-4360 open or 18-4361 open or 18-8506 blocked



**18-6601
SPACER**
Replaces: 0009231E
Fits: all V8 318-360 Small Block (1966 and up) w/Swivel Exhaust



**18-1911
MANIFOLD END PLATE**
Chrysler Big Block V8 383-440cu.in.
(All Models except 413"E" w/offset bolt pattern)
Used with:
Manifold: 18-1915
Front/End Plate Gasket: 18-0471
Mounting Kit: 18-8501



**18-1941
MANIFOLD END PLATE**
Replaces: 2846106
Use with:
End Plate Gasket: 18-2941 open or 18-0472 blocked
Mounting Kit: 18-4360 open or 18-4361 open
or 18-8506 blocked



**18-1942
MANIFOLD END PLATE
with hole**
Replaces: 24695566, 3675826
Use with:
End Plate Gasket: 18-2941
Mounting Kit: 18-4360 or 18-4361
Fits: 18-1940 Manifold



**18-0607
INTAKE MANIFOLD GASKET SET**
Replaces: 3745217
For: 318 CID Engines (1969-82)

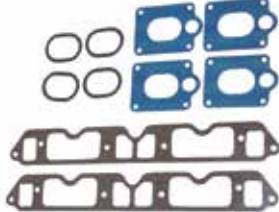

**18-4346
EXHAUST MANIFOLD GASKET SET**
Replaces: 3745220
For: 318 CID Engines (1969-85)



**18-0474
MANIFOLD GASKET**
Used with:
Manifold: 18-1915



**18-0471
ELBOW GASKET**
Used with:
Manifold: 18-1915 Port & Starboard
Elbow: 18-1948
End Plate: 18-1911

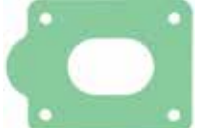

**18-0472 (Blocked)
ELBOW GASKET**
Used with:
Riser/Elbow: 18-1945, 18-1946, 18-1913
End Plate: 18-1941



**18-0956
EXHAUST MANIFOLD
GASKET**
Replaces: 118-614
For 460 CID



**18-4360 (Open)
EXHAUST ELBOW MOUNTING KIT**
Use with
Exhaust Elbow: 18-1946, 18-1913,
18-1945
End Plate: 18-1942 open or
18-1941 blocked



**18-4361 (Open)
EXHAUST ELBOW
MOUNTING KIT**
Use with:
End Plate: 18-1942 open or 18-1941 blocked
Riser: 18-1945
Elbow: 18-1946, 18-1913



**18-4364 (Open)
EXHAUST ELBOW KIT**
Replaces: Barr 20-0082-P
Use with:
Riser: 18-1999, 18-1907, 18-1939

PKG. OF 2



**18-2941 (Open)
18-2941-9①
END CAP GASKET**
Replaces:
2847480, 2469559
Use with:
End Plate: 18-1941, 18-1942
Riser/Elbow: 18-1945, 18-1946, 18-1913
For: 318CID Engines



**18-8501
EXHAUST ELBOW
MOUNTING KIT**
Chrysler Big Block V8 383-440 cu.in.
(Models: All except 413 "E" with offset bolt pattern)
Used with:
Front Plate: 18-1911
Elbow: 18-1948



**18-8506
EXHAUST ELBOW
MOUNTING KIT**
Chrysler Small Block V8 318-360 cu.in. (All models 1966 and up with swivel and fixed exhaust)
Used with:
Riser: 18-1945
Elbow: 18-1946, 18-1913
End Plate: 18-1941 blocked



**18-8517
EXHAUST MANIFOLD MOUNTING KIT**
Chrysler Big Block V8 383-440cu.in.
(All Models except 413 "E" w/offset bolt pattern)
Used with:
Manifold: 18-1915



**18-8518
EXHAUST ELBOW MOUNTING KIT**
Chrysler Small Block V8 318-360cu.in. (All models 1966 and up with swivel exhaust), Big Block V8 383-440cu.in. (All models except 413 "E" with offset bolt pattern)
Used with:
Riser: 18-1944



**18-8526
EXHAUST MANIFOLD MOUNTING KIT**
Chrysler Small Block V8 318-360cu.in. (All models 1966 and up with swivel and fixed exhaust)
Used with:
Manifold: 18-1940



**18-8527
EXHAUST MANIFOLD MOUNTING KIT**
Chrysler Small Block V8 318-360cu.in. (All models 1966 and up with swivel and fixed exhaust)
Used with:
Manifold: 18-1940
(Kit has stainless steel studs and nuts)



**18-8535
EXHAUST ELBOW MOUNTING KIT**
Barr, Indmar and Marine Power
Ford Small Block V8 302-351cu.in.,
GM Small Block V8 305-350cu.in.,
GM Big Block V8 454cu.in.
Used with:
Risers: 18-1939, 18-1999, and 18-1907



PIPE PLUGS

Part #	Thread Size
18-4256	1/4"
18-4257	1/4"
18-4258	3/4"
18-4263	1/8" - 27 NPT
18-4264	3/8" - 18 NPT

56507
Pipe Sealant with Teflon® is recommended for use on plug threads.



② **18-4218D** Display Package

**18-4218
BRASS DRAIN COCK (1/4")**
Used with:
Most O.E.M. Manifolds
18-3223-9
Bulk Pack of 12



**18-8536
EXHAUST ELBOW
MOUNTING KIT**
Barr, Indmar and Marine Power
GM Small Block V8 305-350cu.in.
Used with:
Manifold: 18-1997-1



**18-8538
EXHAUST MANIFOLD
MOUNTING KIT**
Barr and Indmar Ford Small Block V8 302-351cu.in.
Used with:
Manifold: 18-1998-1



**18-7512
EXHAUST ELBOW SEAL KIT**
Replaces: 7087-OR
For use with **18-1944**
Exhaust Riser

PKG. OF 8



FREEZE PLUGS
18-5961 **18-5962**
18-5961-9① **18-5962-9①**
1 5/8" 1 3/4"
BRONZE



**18-4461
HOSE BARB**
3/4" - 14 NPT x 1" Hose
Corrosion Resistant Brass Fitting



**18-8215
HOSE BARB**
Fits: Chrysler V8



**18-8216
HOSE BARB**
Fits: Chrysler-Small Block V8 (318-360ci), Big Block V8(383-440)

① Priced per Package ② Items ending in "D" are Display Packaged - Regular number is Non-Display

CRUSADER MODEL IDENTIFICATION

MODEL C X L X H F L 245 M SERIAL 631254

- 1st Space: **MANUFACTURER**
C - Crusader
- 2nd Space: **FACTORY FRESHWATER / CLOSED COOLING**
X-Freshwater Cooled
(Space Omitted If Raw Water Cooled)
- 3rd Space: **ENGINE ROTATION**
L - Rotation, Left-Hand from Rear
R - Rotation, Right-Hand from Rear
- 4th Space: **ENGINE TYPE**
A = 5.7L (350 CID HO) (GM)
G = 5.0L (305 CID) (GM)
Q = 6.0L (364 CID) (GM)
X = 8.1L (496 CID STD) (GM)
Z = 8.1L (496 CID HO) (GM)
- 5th Space: **DRIVE MANUFACTURER**
W - Borg-Warner
H - Hurth
T - Walters
V - Velvet Drive (cast iron units specify 71c or 72c)
- 6th Space: **DRIVE FUNCTION / APPLICATION**
R - Reverse / Reduction
V - Vee Drive / Reversed Risers
F - Full Reversing
- 7th Space: **PROPELLER SHAFT ROTATION**
L - Left-Hand Rotation
R - Right-Hand Rotation

8th 9th 10th Spaces: **DRIVE GEAR RATIO OR REDUCTION**
The drive gear ratio will appear in these spaces which identifies the production gear specs. The example gear number shown is a (2.45:1). If the gear being identified does not have 3 digits, a "0" will appear in 10th space.
Example: (2.0:1) will appear as 200
(1.5:1) will appear as 150

***MODELS ENDING WITH "000000" IN PLACE OF DRIVE I.D. ARE BOBTAIL ENGINES.**

11th Space: **IGNITION / FUEL TYPE USED**
D - DISTRIBUTOR (Carb)
E - THROTTLE BODY INJECTION
M - MULTI-PORT FUEL INJECTION

SERIAL NUMBER I.D.
1st DIGIT INDICATES DECADE ENGINE WAS MANUFACTURED (5 = 1990, 6 = 2000, 7 = 2010)
2nd DIGIT INDICATES YEAR ENGINE WAS MANUFACTURED.

① 18-5250D Display Package



18-5250 TUNE-UP KIT

Part #	—CONTAINS—	Description
18-5311		Contact Set
18-5345		Condenser
18-5418		Rotor
	Delco 4 & 6 cyl.	

Display Package



18-5251 TUNE-UP KIT

Part #	—CONTAINS—	Description
18-5314	O.E. #	Contact Set
18-5338	20117	Condenser
18-5404-1	12530	Rotor
	20223	
	Mallory 8 cyl. Tall Cap	



18-5252 TUNE-UP KIT

Part #	—CONTAINS—	Description
18-5310	O.E. #	Contact Set
18-5344	12525	Condenser
—	12526	Rotor
	12527	
	Delco 8 cyl.	

Display Package



18-5255 TUNE-UP KIT

Part #	—CONTAINS—	Description
18-5303	O.E. #	Contact Set
18-5345	41058	Condenser
18-5407	41057, 705787	Rotor
	41059	
	Prestolite 8 cyl.	

① Items ending in "D" are Display Packaged - Regular number is Non-Display

**18-5256
TUNE-UP KIT**



Part #
18-5314
18-5338
18-5411

—CONTAINS—
O.E. #
20117
12530
12531

Description
Contact Set
Condenser
Rotor

Mallory 8 cyl. Flat Cap

①18-5258D 



**18-5258
TUNE-UP KIT**

Part #
18-5303
18-5347
18-5407

—CONTAINS—
O.E. #
41058
—
41059

Description
Contact Set
Condenser
Rotor

**18-5259
TUNE-UP KIT**



Part #
18-5303
18-5347
18-5429

—CONTAINS—
O.E. #
41058
—
—

Description
Contact Set
Condenser
Rotor

①18-5260D 



**18-5260
TUNE-UP KIT**

Part #
18-5303
18-5345
18-5403

—CONTAINS—
O.E. #
41058
41057, 705787
—

Description
Contact Set
Condenser
Rotor



**18-5266
TUNE UP KIT**

Fits: Flame Thrower Distributors 18-5481, 18-5482, 18-5483, 18-5477, 18-5478, 18-5479



**18-5269
TUNE-UP KIT**

Part #
18-5311
18-5345
18-5418
18-5386

—CONTAINS—

Description
Contact Set
Condenser
Rotor
Distributor Cap

GM V-6 — Single Point





**18-5270
TUNE-UP KIT**

Part #
18-5310
18-5344
—
18-5384

—CONTAINS—
O.E. #
12525
12526
12527
12528

Description
Contact Set
Condenser
Rotor
Distributor Cap

GM V-8 — Single Point





**18-5271
TUNE-UP KIT**

Part #
18-5314
18-5338
18-5404-1
18-5376

—CONTAINS—
O.E. #
20117
12530
20223
20222

Description
Contact Set
Condenser
Rotor
Distributor Cap

Mallory V-8 Tall Cap — Single Point





**18-5272
TUNE-UP KIT**

Part #
18-5314
18-5338
18-5411
18-5375

—CONTAINS—
O.E. #
20117
12530
12531
1003317, 12532

Description
Contact Set
Condenser
Rotor
Distributor Cap

Mallory V-8 Flat Cap — Single Point - Side





**18-5275
TUNE-UP KIT**

Part #
18-5303
18-5347
18-5403
18-5352

—CONTAINS—
O.E. #
41058
—
41089, 41074
41076

Description
Contact Set
Condenser
Rotor
Distributor Cap

Prestolite V-8 - Single Point - Screw Down Cap



APPLICATION BEGINS ON PAGE 517

① Items ending in "D" are Display Packaged - Regular number is Non-Display



**18-5276
TUNE-UP KIT**
—CONTAINS—

Part #	O.E. #	Description
18-5303	41058	Contact Set
18-5347	—	Condenser
18-5403	41089, 41074	Rotor
18-5353	41069	Distributor Cap

Prestolite V-6 - Single Point - Screw Down Cap

Display Package



**18-5277
TUNE-UP KIT**
—CONTAINS—

Part #	O.E. #	Description
18-5303	41058	Contact Set
18-5347	—	Condenser
18-5407	41059	Rotor
18-5369	41052	Distributor Cap

Prestolite V-8 - Single Point - Clip Down Cap

Display Package



**18-5278
TUNE-UP KIT**
Delco EST - V-6



**18-5279
TUNE-UP KIT**
Prestolite Electronic - V-8

—CONTAINS—

Part #	Description	O.E. #	Qty.
18-5352	Distributor Cap	392-9766	1
18-5403	Rotor	392-9089	1



**18-5280
TUNE-UP KIT**
Delco EST - In-Line 4

—CONTAINS—

Part #	Description	O.E. #	Qty.
18-5361	Distributor Cap	986643	1
18-5406	Rotor, Delco	986651	1



**18-5281
TUNE-UP KIT**
Delco EST - V-8

—CONTAINS—

Part #	Description	O.E. #	Qty.
18-5354	Distributor Cap	808483	1

NEW



**18-5301
TUNE-UP KIT**
Replaces:
Fits: male cap v-8 flamethrower distributors

NEW



**18-5302
TUNE-UP KIT**
Replaces:
Fits: male cap v-8 flamethrower distributors



**18-5303
CONTACT SET**
Replaces: 41058



**18-5307
CONTACT SET**
Replaces: 705788



**18-5310
CONTACT SET**
Replaces: 12525



**18-5311
CONTACT SET**



**18-5314
CONTACT SET**
Replaces: 20117



**18-5318
CONTACT SET**
Replaces: 3000124



**18-5338
CONDENSER**
Replaces: 12530



**18-5344
CONDENSER**
Replaces: 12526



**18-5345
CONDENSER**
Replaces: 41057, 705787



**18-5347
CONDENSER**



**18-5403
ROTOR**
Replaces: 41089, 41074



**18-5404-1
ROTOR**
Replaces: 20223



**18-5405
ROTOR**
Replaces: 38071
Use with 18-5354 Distributor Cap
Fits new GM style "Module in Cap"
distributors - V-8 application



**18-5406
ROTOR**
Use with 18-5361 Distributor Cap



**18-5407
ROTOR**
Replaces: 41059



**18-5408
ROTOR**
Use with 18-5362 Distributor Cap
Fits new GM Style "Module in Cap"
Distributors
V6 Applications



**18-5411
ROTOR**
Replaces:
12531,1003318



**18-5418
ROTOR**



**18-5300
ROTOR**
Fits: Flamethrower Distributors



**18-5420
ROTOR**
Replaces: 3000122



**18-5427
ROTOR**
Replaces: 705786



**18-5429
ROTOR**



**18-5301
TUNE-UP KIT**
Replaces:
Fits: male cap v-8 flamethrower distributors



**18-5302
TUNE-UP KIT**
Replaces:
Fits: male cap v-8 flamethrower distributors



**18-5352
DISTRIBUTOR CAP**
Replaces: 41076



**18-5353
DISTRIBUTOR CAP**
Replaces: 41069



**18-5354
DISTRIBUTOR CAP**
Replaces: 38070
Fits new GM style "Module in Cap"
Distributors-V-8
applications Use 18-5405 Rotor



**18-5361
DISTRIBUTOR CAP**
Fits new GM style "Module in Cap"
Distributors - 4 cyl.
applications Use 18-5406 Rotor



**18-5362
DISTRIBUTOR CAP**
Fits new GM Style "Module in Cap" Distribu-
tors - V6
Applications Use 18-5408 Rotor



**18-5369
DISTRIBUTOR CAP
W/Gasket 18-5399**
Replaces: 41052

 <p>18-5474 DISTRIBUTOR CAP Red Distributor Cap with Male Terminals Petronix Dsistributors</p>	 <p>18-5473 DISTRIBUTOR CAP Black Distributor Cap w/ Male Terminals Petronix Dsistributors</p>	 <p>18-5375 DISTRIBUTOR CAP Replaces: 12532, 1003317</p>	 <p>18-5376 DISTRIBUTOR CAP Replaces: 20222</p>
 <p>18-5384 DISTRIBUTOR CAP Replaces: 12528</p>	 <p>18-5386 DISTRIBUTOR CAP</p>	 <p>18-5389 DISTRIBUTOR CAP Replaces: 3000121</p>	<p>PKG. OF 2</p>  <p>18-5399 18-5399-9^① DISTRIBUTOR CAP GASKET Replaces: 41061</p>



FEATURES

- Senses current levels in the coil and adjusts the dwell to maintain peak energy throughout the entire RPM range.
- Develops, on average, 4 times more available energy between 3000 and 5000 RPM's and twice as much plug voltage as point-type systems.
- Ignition energy is sustained and coil life is increased when peak current level is reached just prior to spark.
- More stable timing.
- Use with 18-5472 "Flame Thrower II" Coil for optimum performance



**18-5286
HI-PERFORMANCE
ELECTRONIC CONVERSION KIT**
Fits: 6 Cylinder Delco Distributors



**18-5288
HI-PERFORMANCE
ELECTRONIC CONVERSION KIT**
Fits: Most Prestolite V-8
Distributors with snap down cap



**18-5289
HI-PERFORMANCE
ELECTRONIC CONVERSION KIT**
Fits: Most Prestolite V-8
Distributors with screw down cap



**18-5290
HI-PERFORMANCE
ELECTRONIC CONVERSION KIT**
Fits: Most Mallory YL or YD 8 cylinder
Distributors with clockwise and counter clockwise rotation

① Priced per Package



FEATURES

- ★ Replaces points & condensers for true solid state ignition.
- ★ Uses standard coil, cap and rotor.
- ★ Easy to install, one-piece, 2-wire hook-up.
- ★ Accurate to within 1/4° timing accuracy 0 to 6000 RPM range.
- ★ Can be used with Flame Thrower Coils 18-5466 & 18-5469.

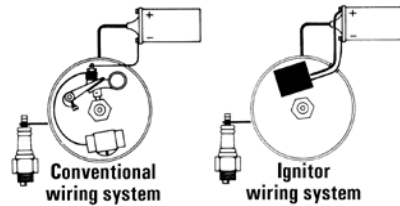

18-5294
ELECTRONIC CONVERSION KIT
Fits: 6 Cyl. Delco distributors



18-5295
ELECTRONIC CONVERSION KIT
Fits: Most 4 Cyl. Prestolite distributors (except IBM 7026)
For: Onan, Universal, Waukesha, Wisconsin



① **18-5296-2D**



18-5296-2
ELECTRONIC CONVERSION KIT
Fits: Most Mallory YL & YD 8 cyl.
Distributors with clockwise and counter clockwise rotation



18-5298
ELECTRONIC CONVERSION KIT
With snap down cap
For: Most Prestolite V-8 Distributors

① **18-5299D**



18-5299
ELECTRONIC CONVERSION KIT
With screw down cap
For: Most Prestolite V-8 Distributors
Use with 18-5403 style rotor

PREMIUM MARINE SPARK PLUG WIRE LEADS



OE style boots provide a sealed barrier against heat, dirt and moisture.

Premium Marine Wire Leads

Magnetic Suppression Core

Manufactured for your specific application

- Kevlar® core for maximum durability and long life.
- Durable stainless steel wound conductor for maximum horsepower and engine performance.
- Premium silicone jacketing and boots for the ultimate in high temperature protection.
- Superior RFI suppression for the most sensitive electronic system.
- Corrosion resistant stainless steel spark plug and distributor terminals for maximum conductivity.

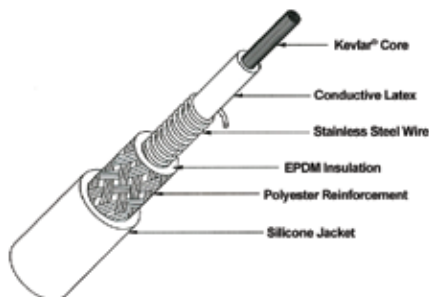

Model	Ignition Type	Cyl.	Part #
262/4.3L	Conventional	6	18-8801-1
262/4.3L	EST, EFI	6	18-8810-1
305/5.0L	Conventional	8	18-8803-2
350/5.7L	Conventional	8	18-8803-2
350/5.7L	EST, EFI	8	18-8820-1
454/ 7.4L	Conventional	8	18-8803-2
454/7.4L	XL Series	8	18-8824-1
496/8.1L	Distributorless	8	18-8838-1
502/ 8.2L	Conventional	8	18-8803-2
502/8.2L	XL Series	8	18-8824-1
454/502	XL Series	8	18-8844-1

APPLICATION BEGINS ON PAGE 467

① Items ending in "D" are Display Packaged - Regular number is Non-Display



BATTERY CABLES

Gauge cable with soldered lug terminals on each end to accept 3/8" stud.

PART NO.	SIZE	COLOR	GAUGE	PART NO.	SIZE	COLOR	GAUGE
BC88523	2'	red	4	BC88563	6'	red	2
BC88533	2'	black	4	BC88573	6'	black	2
BC88543	4'	red	2	BC88583	8'	red	1
BC88553	4'	black	2	BC88593	8'	black	1



18-5225 SPARK PLUG WIRE KIT

Replaces: Mercury 84-99215A26, 84-813706A26
Kit includes 25 ft. Roll of 7 MM Hypalon Ignition Wire With a Metallic Core and a Large Assortment of Three Different End Fittings.



18-5226 IGNITION WIRE
Metallic Core
100' Spool
7mm Hypalon

PKG. OF 10



18-5224 SPARK PLUG WIRE TERMINAL
Replaces: Mercury 20121
OMC 510364

PKG. OF 10



18-5750 UNIVERSAL SPARK PLUG BOOTS
Supplied complete w/Terminal Connector
Replaces: OMC 581027, 580339



18-5752 UNIVERSAL SPARK PLUG BOOTS
8mm

FEATURES

- Distributors feature the Ignitor II ignition module with adaptive dwell control adjusts the spark timing over the entire RPM range to maximize performance
- Upper roller bearing and oil impregnated bronze sintered bottom bushing are installed and aligned bored for accuracy for maximum durability
- Machined heat treated gear with tight tolerances insures durability and consistent timing to maximize horsepower and performance. Complete with high dielectric strength cap and rotor for years of performance

Standard Rotation

CCW Rotation

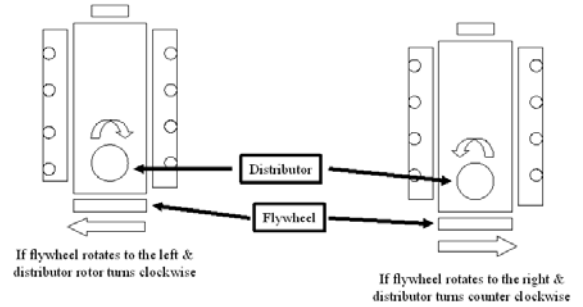

18-5483 HI-PERFORMANCE ELECTRONIC DISTRIBUTOR

Fits: Chevrolet Marine Small and Big Block engines (Standard Deck Height)
Replacement cap/rotor kit 18-5266



18-5309 DISTRIBUTOR
Replaces: Mallory YL512CV

For most Ford 302 CID V-8 Eng.
Uses: 18-5251 TUNE-UP KIT

- CONTAINS -	
Part #	Desc.
18-5314	Contact Set
18-5338	Condenser
18-5404-1	Rotor
And 18-5376 CAP	



18-5313 DISTRIBUTOR

Replaces: Crusader 37061; Mallory YL624MW

For most GM V-8 Eng. small & large block Mallory Tall Cap
Uses: 18-5251 TUNE-UP KIT

- CONTAINS -	
Part #	Desc.
18-5314	Contact Set
18-5338	Condenser
18-5404-1	Rotor
And 18-5376 CAP	



ELECTRONIC DISTRIBUTORS U.L. Approved

Part No.	Rotation	Application
18-5494-1	Conventional	Chevrolet All V8 (exc. 348,409 & Tall Deck Big Block) Includes 482, 502, 540 CID
18-5498-1*	Reverse	Chevrolet All V8 (exc. 348,409 & Tall Deck Big Block) Includes 482, 502, 540 CID
18-5495-1	Conventional	Ford V-8, 302 CID

*Older reverse rotation engines with reverse cut camshaft gear

USES:			
Part #	Description	Part #	Description
18-5376	Distributor Cap	18-5488	Module
18-5404-1	Rotor		

① Priced per Package

**18-5484-1
ELECTRONIC
DISTRIBUTOR**

Left Hand Rotation

Replaces: Mallroy YLE624AV

Late Model HEI

For V8 — 262-454 & 502 except 384/409 and tall block engines

• Designed as a plug-in replacement for GM-style fuel injection system distributors



—CONTAINS—

Description	Part #
Distributor Cap	18-5354
Rotor	18-5405

**18-5485
ELECTRONIC
DISTRIBUTOR**

Right Hand Rotation

Replaces: Mallroy YLE624BV

Late Model HEI

For V8 — 262-454 & 502 except 384/409 and tall block engines

• Designed as a plug-in replacement for GM-style fuel injection system distributors



—CONTAINS—

Description	Part #
Distributor Cap	18-5354
Rotor	18-5405

**18-5480
COMPLETE
IGNITION
CONVERSION KIT**

Fits: GM SB & BB with Standard Deck Height

—CONTAINS—

Part #	Description
18-5472	Coil
18-8803-2	Wire Set
18-5483	Distributor



**18-5108
PICKUP COIL
SENSOR**



**18-5464
IGNITION MODULE**

Fits: Sierra 18-5481, 18-5482

and 18-5483 Billet

HI-PERFORMANCE

ELECTRONIC DISTRIBUTORS

(except HEI/EST)



**18-5107-1
IGNITION MODULE**

4/6/8 cyl.

Replaces: 7243110



FEATURES

- ★ Oil filled for better cooling and long life
- ★ Low resistance and improved turn ratios produces the higher voltage needed to run larger spark plug gaps for added power and better fuel economy
- ★ More windings maximize energy and reliability over the full RPM range
- ★ Fits existing brackets for easy installation

**18-5466
HI-PERFORMANCE
IGNITION COIL**

1.5 ohm (oil filled), black - 8 cylinder:
Flame-Thrower 40,000 volt coil.

★ Designed for use with the original

Ignitor Electronic Conversion Kits

★ Can be used with other inductive
ignition systems



**18-5469
HI-PERFORMANCE
IGNITION COIL**

3.0 ohm (oil filled), black - 4 & 6 cylinder:
Flame-Thrower 40,000 volt coil.

★ Designed for use with the original

Ignitor Electronic Conversion Kits

★ Can be used with other inductive
ignition systems



**18-5472
HI-PERFORMANCE
IGNITION COIL**

0.6 ohm (oil filled), black - 4, 6, &
8 cylinder:Flame-Thrower 45,000
volt coil.

★ Super low 0.6 ohm resistance coil

designed for use with the Ignitor II

Hi Performance Electronic

Conversion Kits

★ Compatible with capacitive
discharge systems



Part #	Description	Recommended Coil	Resistance Ohms	Part #	Description	Recommended Coil	Resistance Ohms
18-5294	Electronic Conversion Kit	18-5469	3.0	18-5286	Hi Performance Electronic Conversion Kit	18-5472	0.6
18-5295	Electronic Conversion Kit	18-5469	3.0	18-5288	Hi Performance Electronic Conversion Kit	18-5472	0.6
18-5296-2	Electronic Conversion Kit	18-5466	1.5	18-5289	Hi Performance Electronic Conversion Kit	18-5472	0.6
18-5298	Electronic Conversion Kit	18-5466	1.5	18-5290	Hi Performance Electronic Conversion Kit	18-5472	0.6
18-5299	Electronic Conversion Kit	18-5466	1.5	18-5483	Flame-Thrower Distributor	18-5472	0.6

**18-5433
IGNITION COIL**
Replaces: 37068
Uses External Resistor



**18-5434
IGNITION COIL**
Replaces: 41080
Uses External Resistor



**18-5435
IGNITION COIL**
Replaces: 41080
Has Internal Resistor



**18-5436
IGNITION COIL**
Has Internal Resistor
(For Mallory Applications)



**18-5438
IGNITION COIL**
Replaces: 37068
HEI



**18-5443
IGNITION COIL**
Replaces: 7243200
4cyl./V-8
For: 3.0L (1991 & up) 5.7 & 7.4 EFI
(1995 & up)



**18-5450
COIL RESISTOR**



IGNITION/ELECTRICAL SYSTEMS APPLICATION

Cyl.	Model Engine	Year	Distributor No.	Contact Set	Condenser	Rotor	Dist. Cap	Tune-Up Kit	Distributor	Electronic Con. Kit
4	153	1961-69	YL486C,D ④	18-5314	18-5338	18-5427	—	—	—	—
4	IH60,M60, PH45,134	1971-75	IAY4010A	18-5307	18-5345 ⑤	18-5427	—	—	—	—
6	230,292 Chevy	1961-69	YL486A,B ④	18-5314	18-5338	18-5427	—	—	—	—
6	229,3.8L	1980-82	IBM7014,A	18-5303	18-5345 ⑤	18-5403	18-5353	18-5260 18-5276 ⑥	—	—
6	229,262	1983-88	IBM7018	18-5303	18-5345 ⑤	18-5403	18-5353	18-5260 18-5276 ⑥	—	—
6	229,262	1983-88	IBM7021	18-5303	18-5345 ⑤	18-5403	18-5353	18-5260 18-5276 ⑥	—	—
8	185,230, 250,280	1962	IBM4110	18-5303	18-5345 ⑤	18-5429	—	18-5259	—	—
8	283,327,348	1961-69	YL487A	18-5314	18-5338	18-5404-1	18-5376	18-5251 18-5271 ⑥	18-5494-1 ① 18-5498-1 ② 18-5313 ③	18-5296
8	185,220,230	1961-69	ZD431A, YL431A ④	18-5314	18-5338	18-5411	18-5375	18-5256	—	—
8	170,220,225HP, 275CAD	1961-69	ZD345A,B ZD345A,B	18-5314	18-5338	18-5404-1	18-5376	18-5251 18-5271 ⑥	18-5494-1 ① 18-5498-1 ② 18-5313 ③	18-5296
8	283,327,409,427	1965-71	1111161	18-5310	18-5344	—	18-5384	18-5252 18-5270 ⑥	18-5494-1 ① 18-5498-1 ② 18-5313 ③	18-5296
8	302,351	1971-75	—	18-5318	—	18-5420	18-5389	—	18-5495-1 ① 18-5309 ③	—
8	302	1975-78	IBM7007,A	18-5303	18-5345 ⑤	18-5407	18-5369	18-5258 18-5277 ⑥	18-5495-1 ① 18-5309 ③	18-5298
8	305,350,454	1977-82	IBM7011,D	18-5303	18-5345 ⑤	18-5407	18-5369	18-5258 18-5277 ⑥	18-5494-1 ① 18-5498-1 ② 18-5313 ③	18-5298
8	305,350,454	1977-82	IBM7013	18-5303	18-5345 ⑤	18-5403	18-5352	18-5260 18-5275 ⑥	18-5494-1 ① 18-5498-1 ② 18-5313 ③	18-5299
8	305,350,454	1983-87	Mallory	18-5314	18-5338	18-5404-1	18-5376	18-5251 18-5271 ⑥	18-5494-1 ① 18-5498-1 ② 18-5313 ③	18-5296
8	ALL	1987-88	IDU7801B,C B.I.D.Elec. Ign.	N/A	N/A	18-5403	18-5352	N/A	—	—

① Electronic Distributor (Standard Rotation)
② Electronic Distributor (Counter Rotation)

③ Contact Controlled Distributor (Standard Rotation)
④ Mallory Ignition Only

⑤ For Strap Type Condenser, use 18-5347
⑥ Tune-Up Kit with Distributor Cap



18-5907 STARTER
18-5901 REMANUFACTURED STARTER
(Heavy Duty) (No Core) Clockwise
Top Mount Rear Entry Starter
Will not replace non-starter mounted solenoids.
For Opposite Rotation GM & Ford Engines.
Replaces: 42090
Replacement Solenoid: 18-5837
SAEJ1171

Standard Rotation CCW Rotation

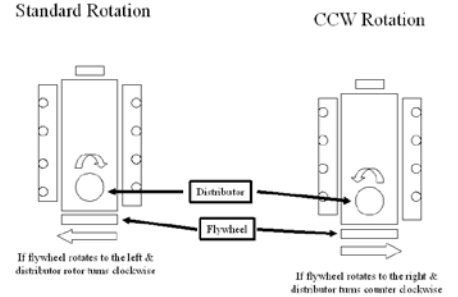

If flywheel rotates to the left & distributor rotor turns clockwise

If flywheel rotates to the right & distributor turns counter clockwise



18-5908 STARTER
18-5902 REMANUFACTURED STARTER
(Heavy Duty) (No Core) Counter-Clockwise
Top Mount Rear Entry Starter
For Standard Rotation GM & Ford Engines.
Replaces: 42091
Replacement Solenoid: 18-5837
SAEJ1171



18-6835 STARTER
Replaces: GM Engines Universal
Used on Buick, Chevrolet, Oldsmobile, and Pontiac Race Engines



18-6834 STARTER
Replaces: GM Engines Universal
Used on Buick, Chevrolet, Oldsmobile, and Pontiac Race Engines



18-9802 TIMING LIGHT
Self-powered accurate up to 10,000 RPM's



18-5717 STARTER BRUSH SET
Replaces: 42001, 707125
Delco



18-5838 SOLENOID
Delco





18-5840 SOLENOID
Prestolite 15-79,
SAW4201, SAW4207,
SAW4210



18-2434 FLYWHEEL BELL HOUSING
Replaces: 96938



BRUSH SET/STARTER SWITCH APPLICATION



Year	Voltage	Original Starter No.	Brush Set	Starter Switch
1960-75	12	MDU-7015,16	—	18-5840
1975-81	12	MEO-7004, 05	—	18-5840
1972-UP	12	96077, 96078 42031, 420036 1107710, 54,63,889	18-5717	18-5838

 18-5710 VOLTAGE REGULATOR Prestolite VSH-6201JY	PKG. OF 8  FREEZE PLUGS 18-5961 18-5962 18-5961-9① 18-5962-9② 1 5/8" 1 3/4"	 18-7600 TEMPERATURE SENSOR Replaces: 47002	 18-7630 THROTTLE POSITION SENSOR Replaces: 47032	 18-7632 IDLE AIR CONTROL MOTOR Replaces: 47033
---	--	---	--	---

VOLTAGE REGULATOR APPLICATION

Year	Model	Voltage	Original Alt./Gen. No.	Voltage Regulator
1966-75	Conqueror 190, 220, 250, 320	12	ALE-5204,S	18-5710
1961-75	150, 165, 185, 190, 230, 250, 280, 320	12	ALF-5201-1,A-1,S	—
		12	ALE-5202,S	—
		12	ALK-6204A	—
		12	ALE-5204,S	18-5710

 18-7607-1 CARBURETOR Replaces: Rochester 17082403 For: Rochester Carb: Crusader 454	 18-7019 CARB KIT	 18-7022 CARB KIT
--	---	---

 18-7070 CARB KIT	 18-7072 CARB KIT	 18-7078 CARB KIT
--	--	---

 18-7086 CARB KIT	 18-7095 CARB KIT Replaces: 45334	 18-7725 CARB KIT
--	---	--

① Priced per Package

CARBURETOR KIT APPLICATION ON NEXT PAGE



**18-7200
FLOAT**
Replaces: 45303
(Alcohol Resistant)
Brass



**18-7201
FLOAT**
(Alcohol Resistant)
Brass



**18-7202
FLOAT**
(Alcohol Resistant)
Brass

CARBURETOR KIT AND FLOAT APPLICATION

Cyl.	Model or Eng. Displacement	Mfg. Code	Carb. Model	Carburetor Number	Carb. Kit ^①	Float
4	153" (2.5L)	R-2	2GC	7025082, 7028086	18-7070	18-7200
6	225" (3.7L)	R-2	2GC	7025181	18-7070	—
8	283" (4.6L), 327 (5.3L)	R-2	2GC	7024185	18-7070	—
8	283" (4.6L)	C-1	YH	2618, 2912	18-7725	—
8	305" (5.0L)	R-2	2GV	17057134	18-7086	18-7202
8	327" (5.3L), 409 (6.6L)	R-4	4GC	7020084, 085	18-7019	—
8	327" (5.3L), 409 (6.6L)	R-4	4GC	7023084, 085, 089	18-7078	—
8	348" (5.7L)	C-4	AFB	2955	18-7022	—
8	350" (5.7L), 454 (7.4L)	R-4	4MV	17059293, 17082403	18-7095	18-7201
8	427" (7.0L)	R-4	4MV	7027081, 7028282	18-7072	18-7201

① Does Not Include Metering Rods

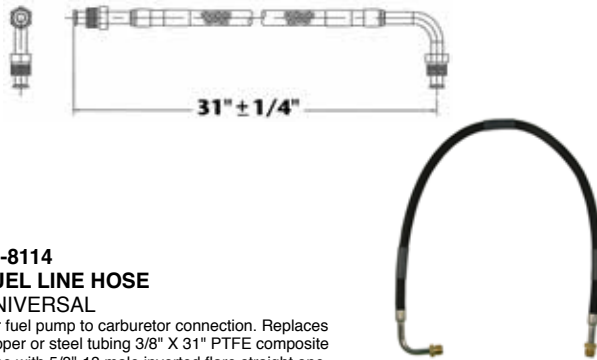

**18-8114
FUEL LINE HOSE
UNIVERSAL**
For fuel pump to carburetor connection. Replaces copper or steel tubing 3/8" X 31" PTFE composite hose with 5/8"-18 male inverted flare straight one end, 5/8"-18 90° one end. SAE J1527 type A1

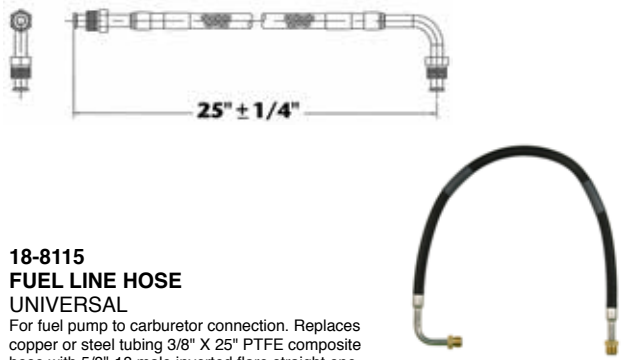

**18-8115
FUEL LINE HOSE
UNIVERSAL**
For fuel pump to carburetor connection. Replaces copper or steel tubing 3/8" X 25" PTFE composite hose with 5/8"-18 male inverted flare straight one end, 5/8"-18 90° one end. SAE J1527 type A1



**18-7231
FLAME ARRESTOR**
Replaces: 97595, 97214
V-8



**18-7232
FLAME ARRESTOR**
Replaces: 33628
Hi-Performance



**18-7256
FUEL PUMP**
Replaces: 32722
(Flange I.D. #6790, M3530)
For: GM (4 & 6 Cyl.) 153, 230, 250, 292



**18-7260
FUEL PUMP**
(Flange I.D. #40155)
For: GM (V-8) 283, 307, 327, 350, 409



**18-7267
FUEL PUMP**
(Flange I.D. #41414)
For: Ford (V-8) 302



**18-7268
FUEL PUMP**
(Flange I.D. #41415, M6948)
For: GM (V-8) 305, 307, 350, 400
(5.25 - 6.5 PSI)
Dual Diaphragm - Requires Sight Glass

**18-7270
FUEL PUMP**
(Flange I.D. #41417, M73019)
For: GM (V-8) 305, 350, 400
(5.75 - 7 PSI)
Replaces: 21140



**18-7272
FUEL PUMP**
(Flange I.D. #41419, M73020)
For: GM (V-8) 283, 305, 350, 400
(5.75 - 6.5 PSI)
Replaces: 97039



FUEL WATER SEPARATORS



Sierra offers a complete line of 10 and 21 micron fuel water separating filters including drainable bowl filters to protect your carbureted and fuel injected engine.

**Refer to pages 126-130 for a complete listing of
OEM and universal applications.**

Sierra fuel water separators remove over 99.8% of emulsified water from your gasoline. Sierra's 10 micron filters are over 90% efficient at removing particles as small as 10 micron. All filters flow @ 90 GPH to feed even the hungriest motor. Sierra 10 micron filters are recommended to prevent damage to sensitive inboard and outboard fuel injection systems.

Sierra #	Crusader #	Description
18-7976	23250	Fuel Filter with O-Rings
18-7852-1	22687	Fuel Water Separator Kit
18-7846	98041	Fuel Filter
18-7862	91606	Fuel Filter
18-7964		Fuel Filter
18-7717		Fuel Element (For: Rochester 2bbl & 4bbl Carburetors)
18-7958	47047	Fuel Element (110 Series Filter, 10 Micron)



**18-3060
IMPELLER**
Replaces: 1003026, 22212
FOR: FORD



**18-3061
IMPELLER**
Replaces: 20300
FOR: GM engines with V-Belt



**18-8926
IMPELLER**
Replaces: RP061022
Fits: Crusader 5.7 & 6.0L w/ Serpentine Belt



PKG. OF 2



**18-3140
18-3140-9①
WATER PUMP GASKET**
Replaces: 20502
For: Early 262, 305, 350
(ID) 454,502



**18-3046
IMPELLER KIT**
Replaces: 1003062
Contains: 18-3060 Impeller
Diameter 2 7/16" • Side Width 1 1/4"
with Sherwood Pumps

① Priced per Package



18-3047
IMPELLER KIT



18-3583
CIRCULATING WATER PUMP
(Bi-Directional)
Replaces: 20318, 7142520



18-3577
CIRCULATING WATER PUMP
(Bi-Directional)
Replaces: 67859, 17670, 811573, 30103
For: Big block GM engines with stamped steel timing covers



18-3584
CIRCULATING WATER PUMP
(Bi-Directional)



18-3168
SEAL & SEAT ASSEMBLY
Replaces: 20309



18-3169
SEAL & SEAT ASSEMBLY
Replaces: 40057



18-3551
THERMOSTAT
Replaces: 96319
142°
FOR:



18-3552
THERMOSTAT
Replaces: 96358
Fresh Water Cooling Only
160°
FOR:



18-3671
THERMOSTAT KIT
Replaces: 97361
Includes Thermostat 18-3551 and 18-0875 Gasket
142°
FOR:

Model No.	Cubic Inch
CH190	305
CH220	305
CH270	350
CH350	454

Model No.	Cubic Inch
165	229
CH190/CH220	305
CH270	350
CH350	454

Model No.	Cubic Inch
CH190	305
CH220	305
CH270	350
CH350	454



18-3649
THERMOSTAT
Replaces: 97895
16°
Fresh Water Cooling
Use with 18-2917 Gasket



18-5898
SENDER
Replaces: 700427
1/2" — 14 NPT



18-5899
OIL PRESSURE SENDER
Replaces: 700425



18-4456
EXHAUST PROTECTOR VALVE
Includes Stainless Steel Clamp
3"



18-4457
EXHAUST PROTECTOR VALVE
Includes Stainless Steel Clamp
4"



18-4458
EXHAUST PROTECTOR VALVE
Includes Stainless Steel Clamp
5" & 6"

① Items ending in "D" are Display Packaged - Regular number is Non-Display

Fits GM Big Block V8 454 cu. in. Models CH350 & 454XL

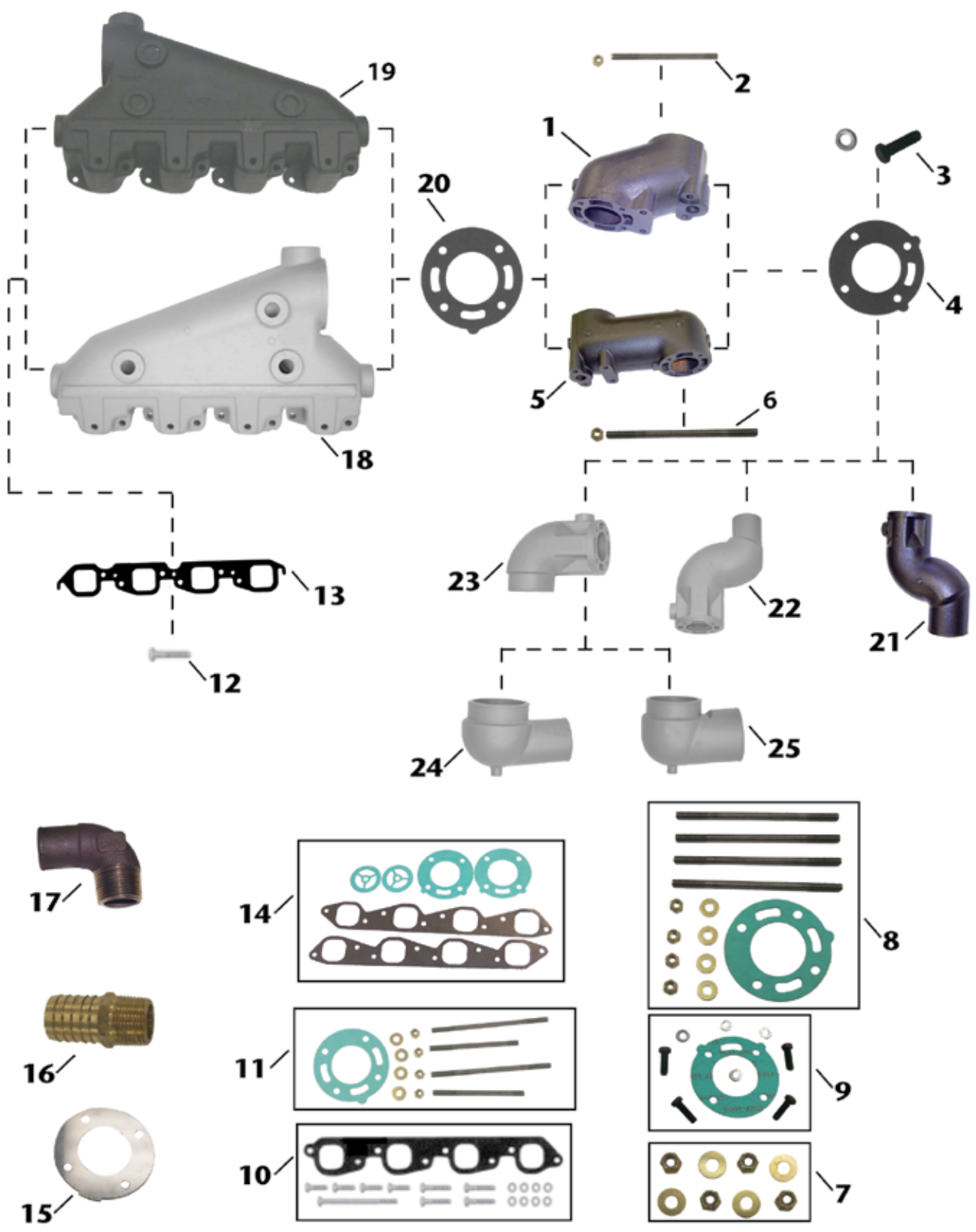

	Item No	Description	OE No.	Application
1	18-1927	4" RISER	97772	Use with Manifolds: 18-1933, & 18-1929; Elbow Gasket: 18-0309; Mounting Kit: 18-8523
2	NSS	MOUNTING HARDWARE	N/A	Included in 18-8523 mounting kit.
3	NSS	MOUNTING HARDWARE	N/A	Included in 18-8515 mounting kit.
4	18-0309	ELBOW GASKET	96562	Use with Exhaust Elbow: 18-1928, 18-1934, & 18-1918
5	18-1916	8" RISER	97169	Use with Manifolds: 18-1933, & 18-1929; Elbow Gasket: 18-0309; Mounting Kit: 18-8519
6	NSS	MOUNTING HARDWARE	N/A	Included in 18-8519 mounting kit.
7	18-8540	WASHER & NUT KIT	N/A	Used in mounting kits: 18-8515, 18-8523, & 18-8519
8	18-8519	MOUNTING KIT	N/A	Use with Riser: 18-1916
9	18-8515	MOUNTING KIT	N/A	Use with Elbows: 18-1934, 18-1928, 18-1918
10	18-8524	MOUNTING KIT	N/A	Use with Manifolds: 18-1929 & 18-1933
11	18-8523	MOUNTING KIT	N/A	Use with Riser: 18-1927
12	NSS	MOUNTING BOLT	N/A	Included in 18-8524 mounting kit.
13	18-0418	MANIFOLD GASKET	96653	Use with Manifold: 18-1929, 18-1933
14	18-0601	EXHAUST MANIFOLD GASKET SET	N/A	For: "CH" Model Big Block (V8) Chevy 454 CID (7.4L); Use with Manifolds: 18-1929, & 18-1933
15	18-1917	BLOCK OFF PLATE (STAINLESS)	97296	Use with Elbow/Riser Gasket: 18-0309, 18-0305
16	18-4461	HOSE FITTING	N/A	3/4" - 14NPT X 1" Hose (Corrosion Resistant Brass Fitting)
17	18-8112	HOSE FITTING	97296; 97854	90 degree fitting. Thread Size: 1" MPT X 1 1/4"
18	18-1929	MANIFOLD (STARBOARD)	97992, 97114	GM Big Block (V8) 454 cu.in. (Models CH350 & 454XL)(Starboard); Use with Manifold Gasket: 18-0418; Mounting Kit: 18-8524
19	18-1933	MANIFOLD (PORT)	97993, 97115	GM Big Block (V8) 454 cu.in. (Models CH350 & 454XL)(Port); Use with Manifold Gasket: 18-0418; Mounting Kit: 18-8524
20	18-0305	ELBOW GASKET	96108	Use with Exhaust Manifold: 18-1929, & 18-1933. Included in 18-8515 mounting kit.
21	18-1928	ELBOW W/ 4" OUTLET	97924	Use with Riser: 18-1927 or 18-1916; Elbow Gasket: 18-0309; Mounting Kit: 18-8515
22	18-1934	ELBOW W/ 3" OUTLET	98068	Use with Riser: 18-1927 or 18-1916; Elbow Gasket: 18-0309; Mounting Kit: 18-8515
23	18-1918	ELBOW W/ 2 1/2" INLET	97386	Use with Riser: 18-1927 or 18-1916; Elbow Gasket: 18-0309; Mounting Kit: 18-8515
24	18-1919	RE-DIRECTION ELBOW W/ 3" OUTLET	97387	Use with Elbow: 18-1918
25	18-1924	RE-DIRECTION ELBOW W/ 4" OUTLET	97624	Use with Elbow: 18-1918

Fits GM Big Block V8 454 cu. in. Models 454XL & 502XL

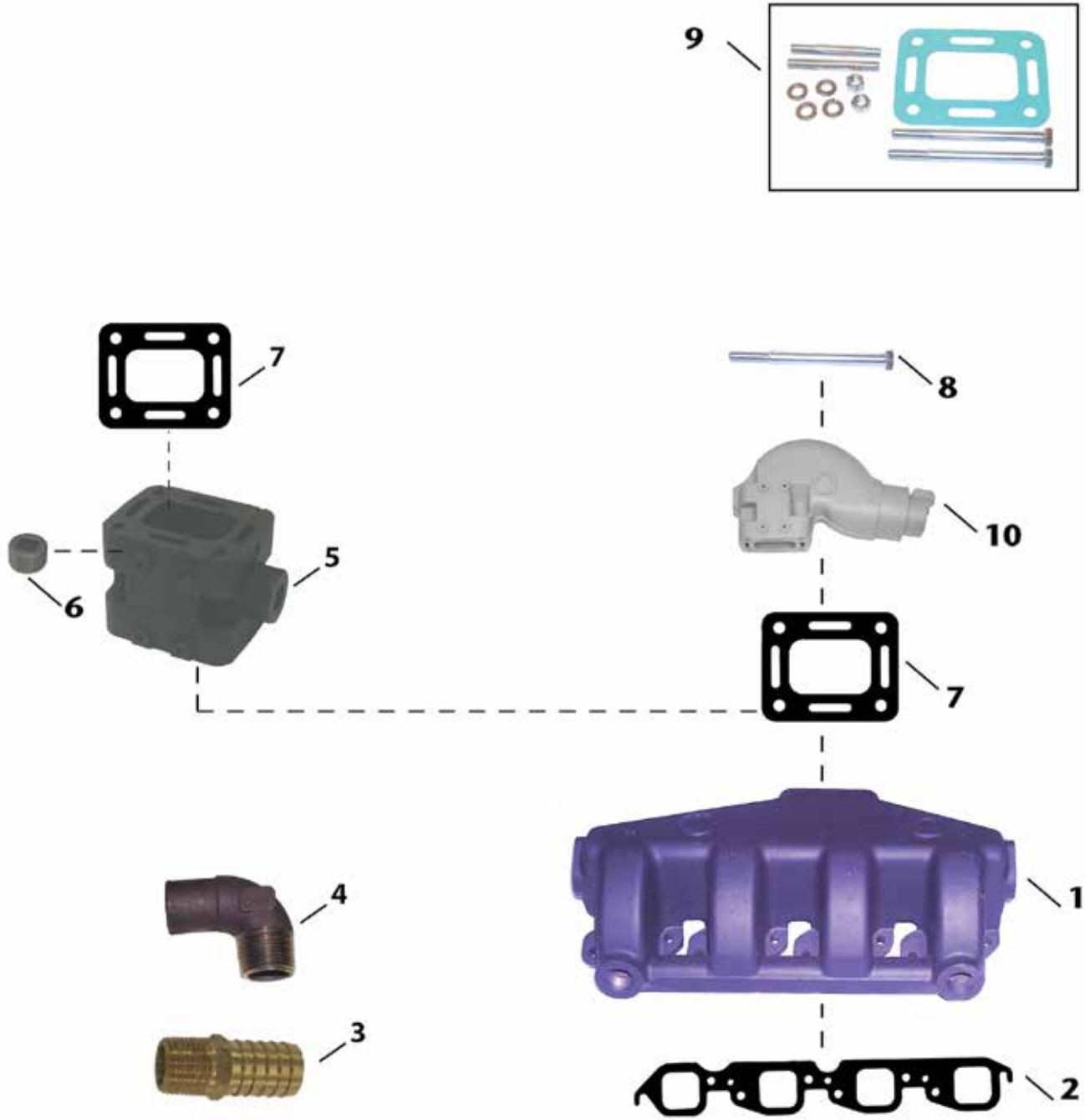

	Item No	Description	OE No.	Application
1	18-1982	MANIFOLD	98125	GM Big Block (V8) 454-502 cu.in. (Port & Starboard); Use with Manifold Gasket: 18-0418
2	18-0418	MANIFOLD GASKET	96653	Use with Manifold: 18-1982.
3	18-4461	HOSE FITTING	N/A	3/4" - 14NPT X 1" Hose (Corrosion Resistant Brass Fitting)
4	18-8112	HOSE FITTING	97296; 97854	90 degree fitting. Thread Size: 1" MPT X 1 1/4"
5	18-1984	MANIFOLD SPACER	98128	Use with Elbow Gasket: 18-0475
6	18-4258	BLACKSTEEL PLUG	113186	Thread Size: 3/4" MPT X 1". Use with Spacer: 18-1984
7	18-0475	ELBOW GASKET (BLOCKED)	98127	Blocked gasket for universal elbow; Use with Riser: 18-1938
8	NSS	MOUNTING BOLT	N/A	Included in 18-8547 mounting kit.
9	18-8547	MOUNTING KIT	N/A	Use with Riser: 18-1938. Includes 18-0475 gasket.
10	18-1938	RISER	98126	Use with Manifold: 18-1982; Riser Gasket: 18-0475; Mounting Kit: 18-8547



Fits GM Small Block V8 305-350 cu. in. Models 220 & 270

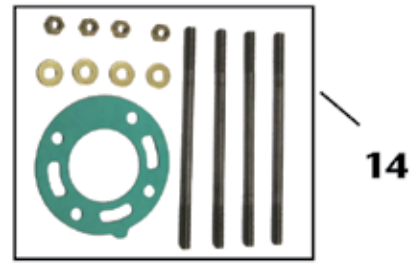
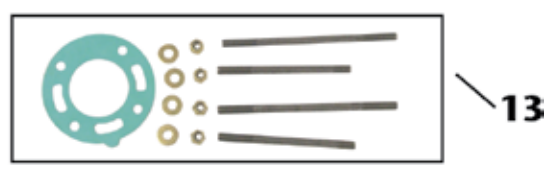
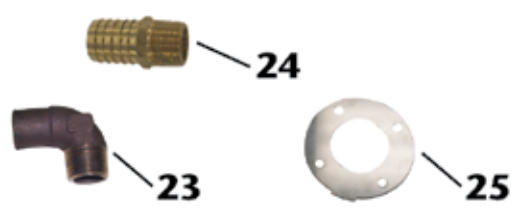
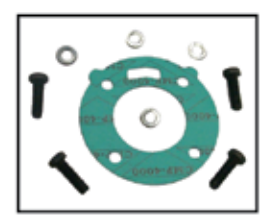
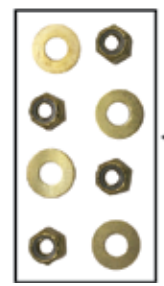
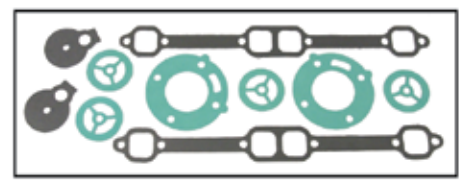
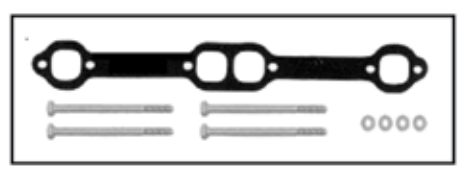
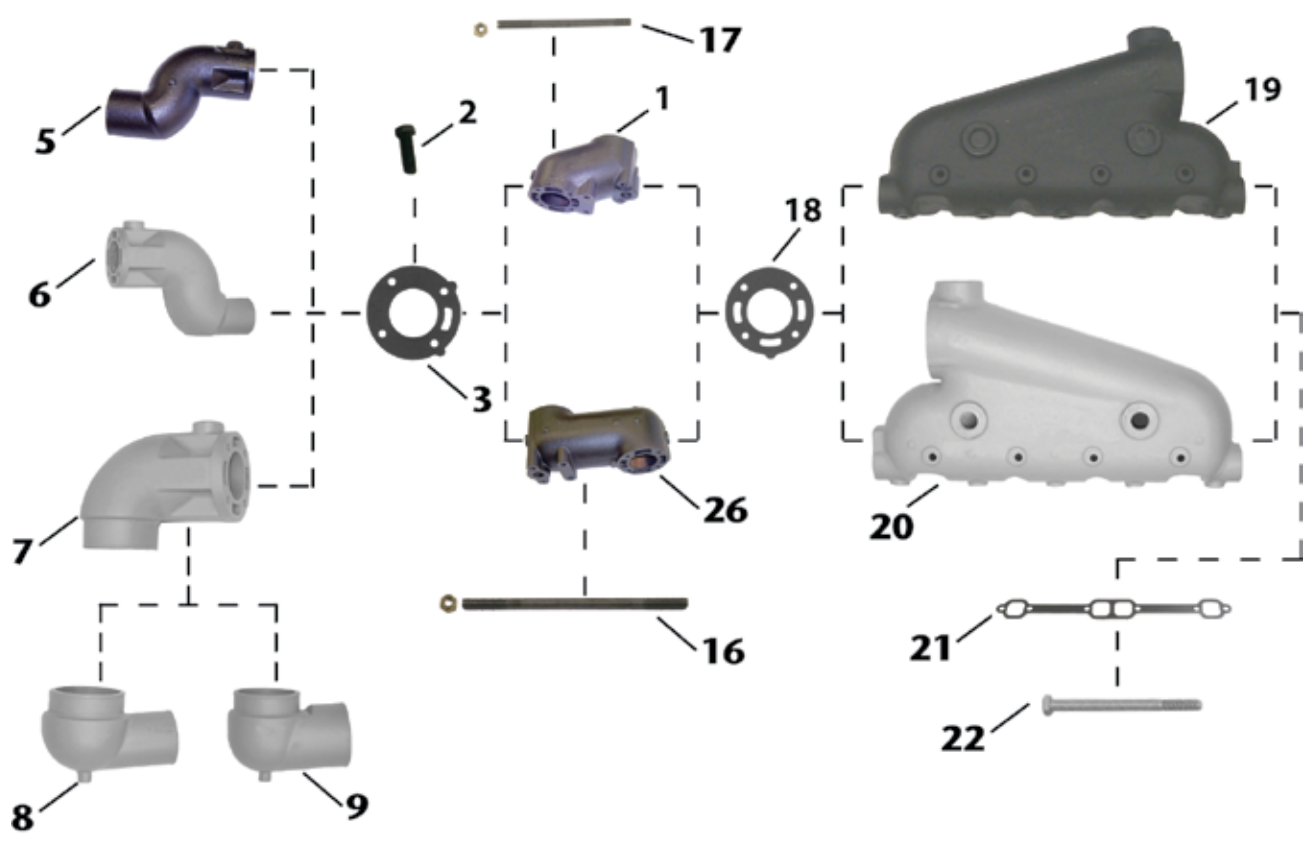

	Item No	Description	OE No.	Application
1	18-1927	4" RISER	97772	Use with Manifold: 18-1925, 18-1926, 18-1933, & 18-1929; Elbow Gasket: 18-0309; Mounting Kit: 18-8523
2	NSS	MOUNTING BOLT	N/A	Included in 18-8515 mounting kit.
3	18-0309	ELBOW GASKET	96562	Use with Exhaust Elbow: 18-1927, or 18-1916. Included in 18-8515 mounting kit.
4	—	MOUNTING KIT	N/A	Use with Manifold: 18-1926 w/ alternator bracket
5	18-1928	ELBOW W/ 4" OUTLET	97924	Use with Manifold: 18-1925, 18-1926; Elbow Gasket: 18-0309; Mounting Kit: 18-8515
6	18-1934	ELBOW W/ 3" OUTLET	98068	Use with Manifold: 18-1925, 18-1926; Elbow Gasket: 18-0309; Mounting Kit: 18-8515
7	18-1918	ELBOW W/ 2 1/2" INLET	97386	Use with Manifold: 18-1925, 18-1926; Elbow Gasket: 18-0309; Mounting Kit: 18-8515
8	18-1919	RE-DIRECTION ELBOW W/ 3" OUTLET	97387	Use with Elbow: 18-1918
9	18-1924	RE-DIRECTION ELBOW W/ 4" OUTLET	97624	Use with Elbow: 18-1918
10	18-0602	EXHAUST MANIFOLD GASKET SET	N/A	For: "CH" Model Small Block (V8) Chevy 305 CID (5.0L) & 350 CID (5.7L)
11	18-8540	WASHER & NUT KIT	N/A	Used in mounting kits: 18-8515, 18-8523, & 18-8519
12	18-8515	MOUNTING KIT	N/A	Use with Elbows: 18-1934, 18-1928, 18-1918
13	18-8523	MOUNTING KIT	N/A	Use with Riser: 18-1927
14	18-8519	MOUNTING KIT	N/A	Use with Riser: 18-1916
15	18-8521	MOUNTING KIT	N/A	Use with Manifold: 18-1925 & 18-1926
16	NSS	MOUNTING STUD	N/A	Included in 18-8519 mounting kit
17	NSS	MOUNTING STUD	N/A	Included in 18-8523 mounting kit
18	18-0305	ELBOW GASKET	96108	Use with Exhaust Manifolds: 18-1925 & 18-1926
19	18-1926	MANIFOLD (PORT)	97753, 96121	GM Small Block (V8) 305-351 cu.in. (Models: 220 & 270) (Port); Use with Manifold Gasket: 18-2949; Mounting Kit: 18-8521 (if manifold has alternator bracket)
20	18-1925	MANIFOLD (STARBOARD)	97752, 96120	GM Small Block (V8) 305-351 cu.in. (Models: 220 & 270) (Starboard); Use with Manifold Gasket: 18-2949; Mounting Kit: 18-8521
21	18-2949	MANIFOLD GASKET	96306	Use with Manifolds: 18-1925 & 18-1926
22	NSS	MOUNTING BOLT	N/A	Included in 18-8521 mounting kits
23	18-8112	HOSE FITTING	97296; 97854	90 degree fitting. Thread Size: 1" MPT X 1 1/4"
24	18-4461	HOSE FITTING	N/A	3/4" - 14NPT X 1" Hose (Corrosion Resistant Brass Fitting)
25	18-1917	BLOCK OFF PLATE (STAINLESS)	97296	Use with Elbow/Riser Gaskets: 18-0309, 18-0305
26	18-1916	8" RISER	97169	Use with Manifolds: 18-1925, 18-1926; Elbow Gasket: 18-0309; Mounting Kit: 18-8519

Fits GM Small Block V8 305-350 cu. in. Models CM305, CM350XL & CM350HT

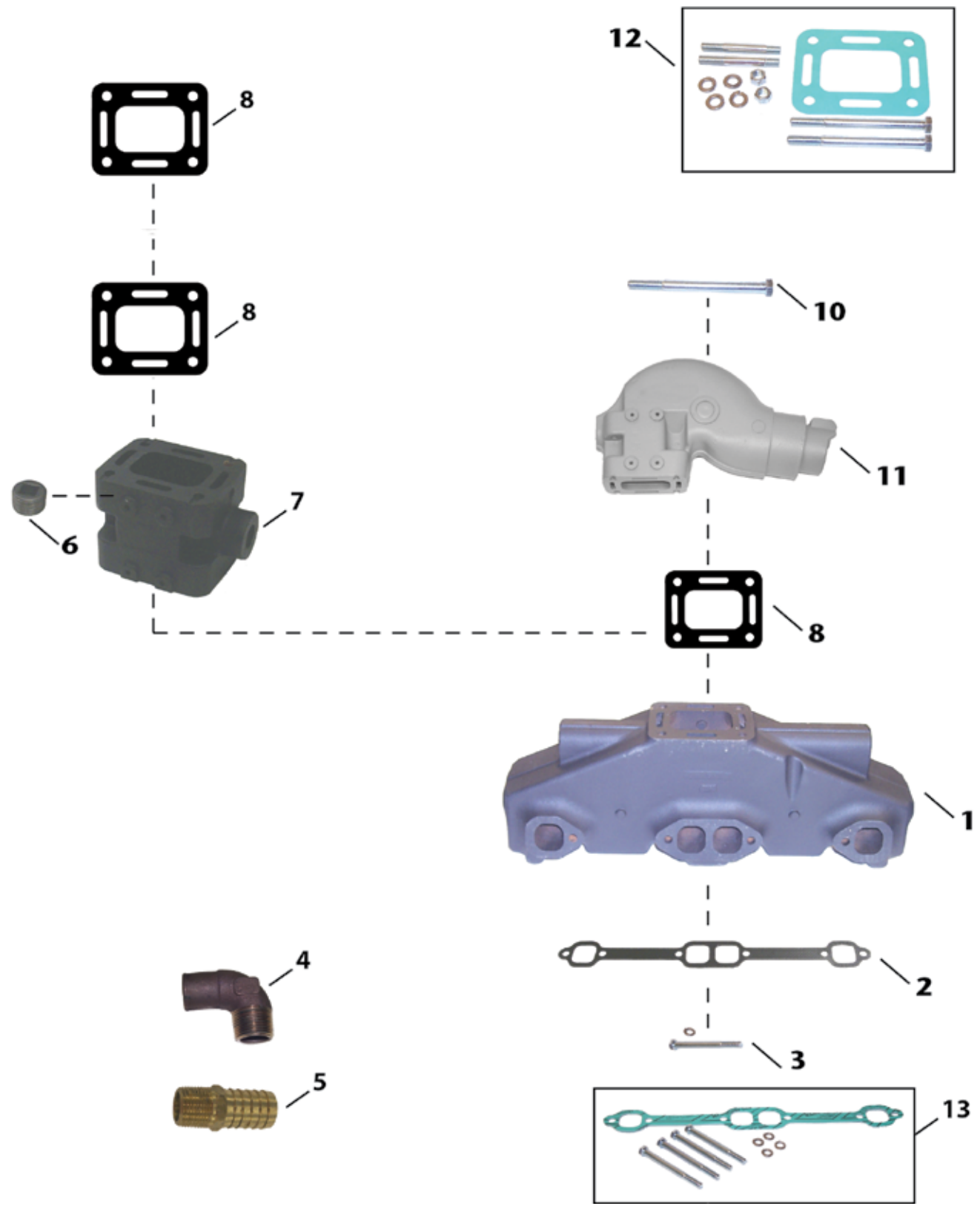

	Item No	Description	OE No.	Application
1	18-1983	MANIFOLD	98243	GM Small Block (V8) 305-351 cu.in. (Port & Starboard); Use with Manifold Gasket: 18-2949; Mounting Kit: 18-8545
2	18-2949	MANIFOLD GASKET	96306	Use with Manifold: 18-1983
3	NSS	MOUNTING HARDWARE	N/A	Included in 18-8536 mounting kit.
4	18-8112	HOSE FITTING	97296; 97854	90 degree fitting. Thread Size: 1" MPT X 1 1/4"
5	18-4461	HOSE FITTING	N/A	3/4" - 14NPT X 1" Hose (Corrosion Resistant Brass Fitting)
6	18-4258	BLACKSTEEL PLUG	113186	Thread Size: 3/4" MPT X 1". Use with Spacer: 18-1984
7	18-1984	MANIFOLD SPACER	98128	Spacer for Manifold: 18-1983.
8	18-0475	ELBOW GASKET	98127	Blocked gasket for universal elbow; Use with Riser: 18-1938
10	NSS	MOUNTING BOLT	N/A	Included in 18-8547 mounting kit.
11	18-1938	RISER	98126	Use with Manifold: 18-1983; Riser Gasket: 18-0475; Mounting Kit: 18-8547
12	18-8547	MOUNTING KIT	N/A	Use with Riser: 18-1938
13	18-8536	MOUNTING KIT	N/A	Use with Manifold: 18-1983



SIERRA MANIFOLDS ARE PAINTED, PACKAGED AND LEAK TESTED

**18-1997-1
MANIFOLD**

Port & Starboard
Replaces: Barr CHV-1-83
Universal Center Riser Manifold

FITS:
283 and 327 CID engines thru 1964; 305, 307
and 350 CID engines 1965 and later

Use with:
Exhaust Manifold Gasket Set: 18-0604
***For Exploded View - See Pages 558-559**

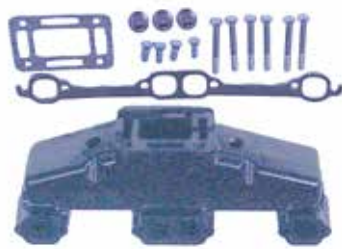

**18-1998-1
MANIFOLD**

Port & Starboard
Replaces: Barr FM-1-83
Universal Center Riser Manifold

FITS:
302 and 351 CID engines
Comes with 18-4363 Mounting Package

Use with:
Exhaust Manifold Gasket Set: 18-0603
***For Exploded View - See Pages 560-561**



**18-1999
ELBOW**

Replaces: Barr 20-0082
Comes with 18-4364 open

If blocked mounting kit is required use 18-8535

Use with:
Manifold: 18-1997-1 or 18-1998-1 or 18-1898
Riser Gasket: 18-2854 open



**18-1982
MANIFOLD**

Port & Starboard
Replaces: Crusader 98125

Use:
Exhaust Manifold Gasket: 18-0418
For: GM Big Block V-8 454-502 ci



**18-1983
MANIFOLD**

Port & Starboard
Replaces: Crusader 98243

Use with:
Exhaust Manifold Gasket: 18-2949
Mounting Kit: 18-8545
For: GM Small Block V-8 305-351 ci



**18-1929
MANIFOLD**

Starboard
Replaces: Crusader 97992, 97114
Crusader GM Big Block V8 454cu.in.
(Models: CH350 and 454XL)

Use with:
Exhaust Manifold Gasket: 18-0418
Mounting Kit: 18-8524



**18-1933
MANIFOLD**

Port
Replaces: Crusader 97993, 97115
Crusader GM Big Block V8 454cu.in.
(Models: CH350 and 454XL)

Use with:
Exhaust Manifold Gasket: 18-0418
Mounting Kit: 18-8524



**18-1925
MANIFOLD**

Starboard
Replaces: Crusader 97752, 96120
Crusader GM Small Block V8 305-350cu.in.
(Models: 220 and 270)

Use with:
Exhaust Manifold Gasket: 18-2949
Mounting Kit: 18-8521



**18-1926
MANIFOLD**

Port
Replaces: Crusader 97753, 96121
Crusader GM Small Block V8 305-350-cu.in.
(Models: 220 and 270)

Use with:
Exhaust Manifold Gasket: 18-2949
Mounting Kit: 18-8521 (if manifold has alternator bracket)



**18-1898
MANIFOLD**

Port & Starboard
Replaces: Barr CHVA-1-84,
Marine Power 0991-110
Fits 454 cu.in. GM big block V8 engines

Use with:
Exhaust Manifold Gasket: 18-0418
Riser Gasket: 18-2854 open or 18-0476 blocked
***For Exploded View - See Pages 556-557**





**18-1991
ELBOW ADAPTER**
For use with 3" I.D. Exhaust Hose
Use with:
Manifold Riser: 18-1999
30°



**18-1992-1
ELBOW ADAPTER**
For 3" I.D. Exhaust Hose
(As used in 18-1987 Exhaust Manifold Conversion Kit)
80°



**18-1919
RE-DIRECTION ELBOW W/ 3" OUTLET**
Replaces: Crusader 97387
Crusader GM Small Block V8 305-350-cu.in.
(Models: 220 and 270), GM Big Block V8 454cu.in.
(Models: CH350 and 454XL)
Use with:
Elbow: 18-1918



**18-1924
RE-DIRECTION ELBOW W/ 4" OUTLET**
Replaces: Crusader 97624
Crusader GM Small Block V8 305-350-cu.in.
(Models: 220 and 270), GM Big Block V8 454cu.in.
(Models: CH350 and 454XL)
Use with:
Elbow: 18-1918



**18-1928
ELBOW W/ 4" OUTLET**
Replaces: Crusader 97924
Crusader GM Small Block V8 305-350cu.in. (Models: 220 and 270), GM Big Block V8 454cu.in.(Models: CH350 and 454XL)
4" Hose
Use with:
Manifold: 18-1925, 18-1926, 18-1933, 18-1929
Elbow Gasket: 18-0309
Mounting Kit: 18-8515



**18-1934
ELBOW W/ 3" OUTLET**
Replaces: Crusader 98068
Crusader GM Small Block V8 305-350cu.in.(Models 220 and 270), GM Big Block V8 454cu.in.(Models: CH350 and 454XL)
3" Hose
Use with:
Manifold: 18-1925, 18-1926, 18-1933, 18-1929
Elbow Gasket: 18-0309
Mounting Kit: 18-8515



**18-1918
ELBOW**
Replaces: Crusader 97386
Crusader GM Small Block V8 305-350-cu.in.
(Models: 220 and 270), GM Big Block V8 454cu.in.
(Models: CH350 and 454XL)
2 1/2" Inlet
Use with:
Manifold: 18-1925, 18-1926, 18-1933, 18-1929
Elbow Gasket: 18-0309
Mounting Kit: 18-8515
Re-direction Elbow: 18-1919, 18-1924



**18-1916
8" RISER**
Replaces: Crusader 97169
Crusader Small Block V8 305-350-cu.in.
(Models: 220 and 270), GM Big Block V8 454cu.in.
(Models: CH350 and 454XL).
Use with:
Manifold: 18-1925, 18-1926, 18-1933, 18-1929
Riser Gasket: 18-0305
Mounting Kit: 18-8519



**18-1927
4" RISER**
Replaces: Crusader 97772
Crusader Small Block V8 305-350-cu.in.
(Models: 220 and 270), GM Big Block V8 454cu.in.
(Models: CH350 and 454XL).
Use with:
Manifold: 18-1925, 18-1926, 18-1933, 18-1929
Riser Gasket: 18-0305
Mounting Kit: 18-8523



**18-1938
RISER**
Replaces: Crusader 98126, RO29015
Crusader GM Small Block V8 305-350cu.in.(Models: CM305, CM350XL and CM350HT), GM Big Block V8 454cu.in.(Models: 454XL and 502XL)
Use with:
Manifold: 18-1982, 18-1983
Riser Gasket: 18-0475
Mounting Kit: 18-8547



18-1907
RISER
 Replaces: Barr 20-0102
 Barr and Indmar Ford Small Block V8 302-351cu.in.
 Indmar 53-2009 and 53-2018
 Use with:
 Manifold: 18-1997-1, 18-1998-1
 Riser Gasket: 18-2854 open or 18-0476 blocked
 Mounting Kit: 18-4364 open or 18-8535 blocked



18-1939
RISER
 Replaces: Barr 20-0100, Marine Power 0992-593
 Barr, Indmar and Marine Power Ford Small Block
 V8 302-351cu.in., GM Small Block V8 305-350cu.in.,
 GM Big Block V8 454cu.in.
 Use with:
 Manifold: 18-1997-1, 18-1998-1, 18-1898
 Riser Gasket: 18-2854 open or 18-0476 blocked
 Mounting Kit: 18-4364 open or 18-8535 blocked



18-8112
FUEL ELBOW
 Replaces: Crusader 97854
 GM Small Block V8 305-350cu.in. (Models: 220,
 270, CM305, CM350XL, CM350HT), GM Big Block
 V8 454 cu.in. (Models: 454XL, 502XL, CH350, 454XL)
 Use with:
 Manifold: 18-1997-1, 18-1998-1, 18-1982, 18-1983,
 18-1929, 18-1933, 18-1925, 18-1926, 18-1898
 90°

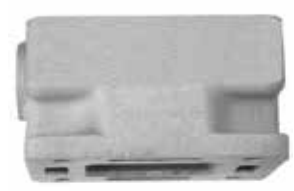

18-1949
MANIFOLD SPACER
 Barr, Indmar and Marine Power Ford Small Block
 V8 302-351cu.in., GM Small Block V8 305-350cu.in.,
 GM Big Block V8 454cu.in.
 Used with:
 Manifolds: 18-1998-1, 18-1997-1 and 18-1898



18-1984
MANIFOLD SPACER
 Replaces: 98128
 For: GM Small Block V8 305-350 cu.in., GM Big Block V8



18-4363
EXHAUST ELBOW MOUNTING KIT
 Replaces: Barr FM-1-83-P
 Use with:
 Manifold: 18-1998-1



18-4364 (Open)
EXHAUST ELBOW MOUNTING KIT
 Replaces: Barr 20-0082-P
 Use with:
 Risers: 18-1999, 18-1907, 18-1939



18-8515
EXHAUST MANIFOLD MOUNTING KIT
 Crusader GM Small Block V8 305-350cu.in. (Models: 220,
 270), GM Big Block V8 454cu.in. (Models: CH350, 454XL)
 Used with:
 Elbows: 18-1934, 18-1928, 18-1918



18-8519
EXHAUST MOUNTING KIT
 Crusader GM Small Block V8
 305 350cu.in. (Models: 220,
 270), GM Big Block V8 454cu.in.
 (Models: CH350, 454XL)
 Used with:
 Riser: 18-1916



18-8521
EXHAUST MANIFOLD MOUNTING KIT
 Crusader GM Small Block V8 305-350cu.in. (Models: 220, 270)
 Used with:
 Manifold: 18-1925 & 18-1926



18-8523
EXHAUST ELBOW MOUNTING KIT
 Crusader GM Small Block V8 305-350cu.in. (Models: 220, 270),
 GM Big Block V8 454cu.in.(Models: CH350, 454XL)
 Used with:
 Riser: 18-1927



18-8524
EXHAUST MANIFOLD MOUNTING KIT
 Crusader GM Big Block V8 454cu.in.
 (Models: CH350 and 454XL)
 Used with:
 Manifolds: 18-1929 and 18-1933



18-8535
(CLOSED)
EXHAUST ELBOW MOUNTING KIT
 Barr, Indmar and Marine Power Ford Small Block V8
 302-351cu.in., GM Small Block V8 305-350cu.in., GM Big
 Block V8 454cu.in.
 Used with:
 Risers: 18-1939, 18-1999, and 18-1907 Blocked



18-8536
EXHAUST ELBOW MOUNTING KIT
 Barr, Indmar and Marine Power GM Small
 Block V8 305-350cu.in.
 Used with:
 Manifold: 18-1997-1



18-8538
EXHAUST MANIFOLD
MOUNTING KIT
 Barr and Indmar Ford Small Block
 V8 302-351cu.in.
 Used with:
 Manifold: 18-1998-1



18-8547
EXHAUST ELBOW MOUNTING KIT
 For: GM SB V8 305-350cu.in.
 GM BB V8 454 cu. in.
 Used with
 Riser: 18-1938

PIPE PLUGS

Part #	Thread Size
18-4256	1/4"
18-4257	1/4"
18-4258	3/4"
18-4263	1/8" - 27 NPT
18-4264	3/8" - 18 NPT

56507 Pipe Sealant with Teflon®
 is recommended for use on plug threads.



18-4461
HOSE BARB
 3/4" - 14 NPT x 1" Hose
 Corrosion Resistant Brass Fitting

① **18-4218D**



18-4218
DRAIN TAP
 Used with:
 Most O.E.M. Manifolds
18-3223-9 Bulk Pack of 12
 1/4" Brass



18-0601
EXHAUST MANIFOLD
GASKET SET
 For: "CH" Model Big Block V-8 Chevy 454 CID (7.4L)
 Use with:
 Manifolds: 18-1929, 18-1933



18-0602
EXHAUST MANIFOLD
GASKET SET
 For: "CH" Model Small Block
 V-8 Chevy 305 CID (5.0L) & 350 CID (5.7L)

① Items ending in "D" are Display Packaged - Regular number is Non-Display



18-0603
EXHAUST MANIFOLD GASKET SET

For: Ford 302/351 CID Engines
Use with:
Manifold: 18-1998-1

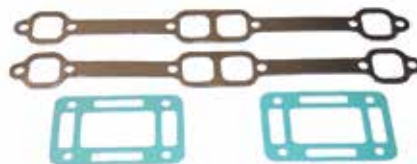

18-0604
EXHAUST MANIFOLD GASKET SET

For: GM 305/350 CID Engines
Use with:
Manifold: 18-1997-1



18-0183
EXHAUST MANIFOLD GASKET

Used with:
Manifold: 18-1998-1



18-0305
EXHAUST ELBOW GASKET

Replaces: 96108
Use with:
Exhaust Manifold: 18-1929



18-0309
EXHAUST ELBOW GASKET

Replaces: 96562
Use with:
Exhaust Elbow: 18-1928
V-6/V-8



18-0418
EXHAUST MANIFOLD GASKET

Replaces: 96653
Use with:
Manifold: 18-1957-1, 18-1982,
18-1929, 18-1933, 18-1898



18-0475
EXHAUST ELBOW GASKET

Used with:
Riser: 18-1938
Manifold: 18-1983



18-0476
BLOCK OFF GASKET

Barr, Indmar & MarinePower
Ford Small Block V8 302-351cu.in.
Use with:
Risers: 18-1939, 18-1999 and 18-1907
Blocked



18-1917
MANIFOLD BLOCK OFF PLATE (STAINLESS)

Replaces: 97296
Crusader Small Block V8 305-350 cu.in. (Models: 220 and 270), GM Big Block V8 454cu.in. (Models: CH350 and 454XL)
Use with:
Elbow/Riser Gasket: 18-0309, 18-0305



18-2854 (Open)
18-2854-9^①
EXHAUST RISER GASKET

Replaces: Barr 01-0107
Used with:
Riser: 18-1999, 18-1907, 18-1939



PKG. OF 2

18-2909
18-2909-9^①
EXHAUST MANIFOLD GASKET

Replaces: 97498
For: GM V-6
Used with:
Manifold: 18-1952-1, 18-1932



PKG. OF 2

18-2949
18-2949-9^①
EXHAUST MANIFOLD GASKET

Replaces: 96306
Barr CHV-47-000
Use with:
18-1997-1



18-4408
INTAKE MANIFOLD GASKET SET
Replaces: 33393
For: 222 CID

^① Priced per Package



OIL FILTERS

Part #	Replaces:	Application
18-7824 (Short)	201104	GM Engines + SS330 Remote Mount
18-7875 (Long)	9002514	Ford Engines
18-7876 (Long)	201104	GM Engines+ SS330 Remote Mount
18-7878-1 (Short)	—	220, 300, 320, 325 Remote Mount



**18-0306
ELBOW AND
CUP GASKET**
Replaces: 96216
V-6/V-8

SEE PAGES 152-154 FOR ADDITIONAL INFORMATION

**18-0311
262 CID
VALVE COVER GASKET**
Replaces: 97686

PKG. OF 2

**18-0875
18-0875-9①
THERMOSTAT GASKET**

PKG. OF 2

**18-0976
18-0976-9①
TIMING CHAIN COVER GASKET**
Replaces: 20129

**18-2845
VALVE COVER GASKET**
Replaces: 91351
V-8

**18-3874
HEAD GASKET**
Replaces: 31137
For: (8.2L) 502 CID/7.4L

**18-3876
HEAD GASKET**
Replaces: 7057500
For: GM 305 (5.0L)/350 (5.7L) CID Eng.

**18-3877
HEAD GASKET**
Replaces: 30266
For: GM 454 (7.4L) CID Eng.

**18-3879
HEAD GASKET**
Replaces: 33408

**18-3887
HEAD GASKET**
Replaces: 31136
For: (7.4L) 454 CID GEN V

① Priced per Package



**18-5303
CONTACT SET**



**18-5345
CONDENSER**



**18-5407
ROTOR**

PARTS FOR CONTACT CONTROLLED DISTRIBUTORS

Year	Cyl.	Model or Engine	Distributor	Contact Set	Condenser	Rotor
1979	8	ALL	IBM-7010	—	18-5345	18-5407
			IBM-7011	18-5303	18-5345	18-5407



**18-5268
TUNE-UP KIT**



**18-5271
TUNE-UP KIT**



**18-5275
TUNE-UP KIT**



**18-5276
TUNE-UP KIT**



**18-5277
TUNE-UP KIT**



**18-5278
TUNE-UP KIT**



**18-5279
TUNE-UP KIT**



**18-5280
TUNE-UP KIT**



**18-5281
TUNE-UP KIT**



**18-5283
TUNE-UP KIT**

PARTS FOR IGNITION - TUNE-UP KITS

Cyl.	Ignition System	Tune-Up Kit	Cyl.	Ignition System	Tune-Up Kit
In-Line 4	Delco Single Point	18-5268	In-Line 4	Delco EST	18-5280
V-8	Mallory Single Point	18-5271	V-6	Delco EST	18-5278
V-8	Prestolite Single Point - Screw Down Cap	18-5275	V-8	Delco EST	18-5281
V-6	Prestolite Single Point - Screw Down Cap	18-5276	In-Line 4	Mallory Single Point	18-5283
V-8	Prestolite Single Point - Clip Down Cap	18-5277	V-8	Prestolite Electronic	18-5279



**18-5480
COMPLETE IGNITION
CONVERSION KIT**
Fits: GM SB & BB with Standard Deck Height



**18-5434
IGNITION COIL**



**18-5450
COIL RESISTOR**

COIL AND RESISTOR		Service Coil	Resistor
Year	Model or Engine	18-5434	18-5450
1979	12 VOLT W/ 2 PRONG RESISTOR		

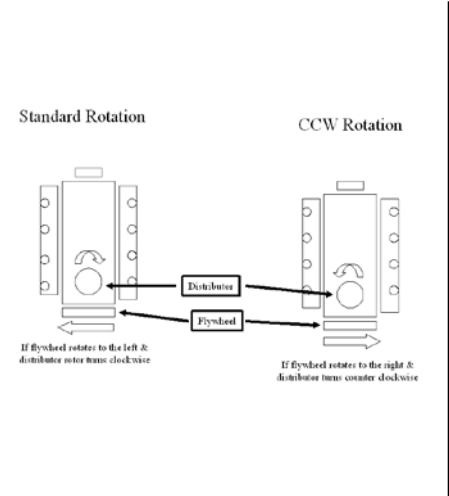

**18-5603
STARTER**
Replaces: 573001
Noseless:CCW Top mount rear entry starter for standard rotation GM & Ford engines. Can be used in place of 18-5908 and 18-5902



**18-6835
STARTER**
Replaces: GM Engines Universal
Used on Buick, Chevrolet, Oldsmobile, and Pontiac Race Engines



**18-5984
ALTERNATOR**
Replaces: 575011
7SI/70 amp, Spool Mount, Serpentine Pulley



**18-6288
ALTERNATOR**
Replaces: 575010
7SI/70 amp, Spool Mount, Single Groove V-Belt Pulley



**18-6451
ALTERNATOR**
Replaces: 575014
11SI/95 amp Spool Mount, serpentine pulley

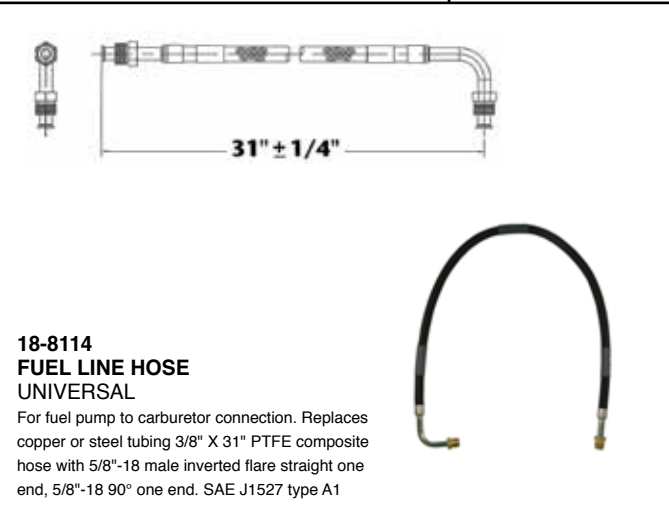

**18-8114
FUEL LINE HOSE
UNIVERSAL**
For fuel pump to carburetor connection. Replaces copper or steel tubing 3/8" X 31" PTFE composite hose with 5/8"-18 male inverted flare straight one end, 5/8"-18 90° one end. SAE J1527 type A1

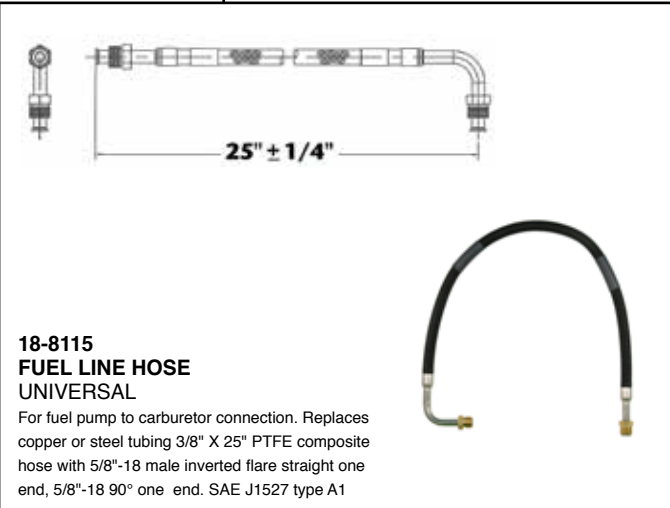

**18-8115
FUEL LINE HOSE
UNIVERSAL**
For fuel pump to carburetor connection. Replaces copper or steel tubing 3/8" X 25" PTFE composite hose with 5/8"-18 male inverted flare straight one end, 5/8"-18 90° one end. SAE J1527 type A1



FUEL WATER SEPARATORS



Sierra offers a complete line of 10 and 21 micron fuel water separating filters including drainable bowl filters to protect your carbureted and fuel injected engine.

Refer to pages 126-130 for a complete listing of OEM and universal applications.

Sierra fuel water separators remove over 99.8% of emulsified water from your gasoline. Sierra's 10 micron filters are over 90% efficient at removing particles as small as 10 micron. All filters flow @ 90 GPH to feed even the hungriest motor. Sierra 10 micron filters are recommended to prevent damage to sensitive inboard and outboard fuel injection systems.

 <p>18-8215 HOSE BARB Fits: Chrysler V8</p>	 <p>18-3304 IMPELLER Replaces: Johnson Pump 09-802-B Dia: 3 3/4" Side Width 3 1/2" Neoprene</p>	 <p>18-3586 WATER PUMP Replaces: Indmar 685011 For Impeller Repair Kit use 18-3081</p>	 <p>18-3587 WATER PUMP Replaces: Indmar 685001 For Impeller Repair Kit use 18-3089</p>															
 <p>18-0603 EXHAUST MANIFOLD GASKET SET</p>	 <p>18-0604 EXHAUST MANIFOLD GASKET SET</p>	<p>PKG. OF 2</p>  <p>18-0665 18-0665-9^① THERMOSTAT GASKET Replaces: 98-5006</p>	 <p>18-0476 RISER BLOCKOFF GASKET Replaces: Barr 1-0105</p>															
<p>MISCELLANEOUS GASKETS</p> <table border="1"> <thead> <tr> <th>Model or Engine</th> <th>Gasket Set</th> </tr> </thead> <tbody> <tr> <td>Ford 302/ 350 CID Engines</td> <td>18-0603</td> </tr> <tr> <td>GM 305/350 CID Engines</td> <td>18-0604</td> </tr> </tbody> </table>		Model or Engine	Gasket Set	Ford 302/ 350 CID Engines	18-0603	GM 305/350 CID Engines	18-0604	<p>MISCELLANEOUS GASKETS</p> <table border="1"> <thead> <tr> <th>Type</th> <th>O.E. #</th> <th>Gasket</th> </tr> </thead> <tbody> <tr> <td>Thermostat</td> <td>98-5006</td> <td>18-0665</td> </tr> <tr> <td>Block Off For: Small block GM & Ford V-8 (Use with 18-1999 Manifold)</td> <td>Barr 1-0105</td> <td>18-0476</td> </tr> </tbody> </table>		Type	O.E. #	Gasket	Thermostat	98-5006	18-0665	Block Off For: Small block GM & Ford V-8 (Use with 18-1999 Manifold)	Barr 1-0105	18-0476
Model or Engine	Gasket Set																	
Ford 302/ 350 CID Engines	18-0603																	
GM 305/350 CID Engines	18-0604																	
Type	O.E. #	Gasket																
Thermostat	98-5006	18-0665																
Block Off For: Small block GM & Ford V-8 (Use with 18-1999 Manifold)	Barr 1-0105	18-0476																

① Priced per Package

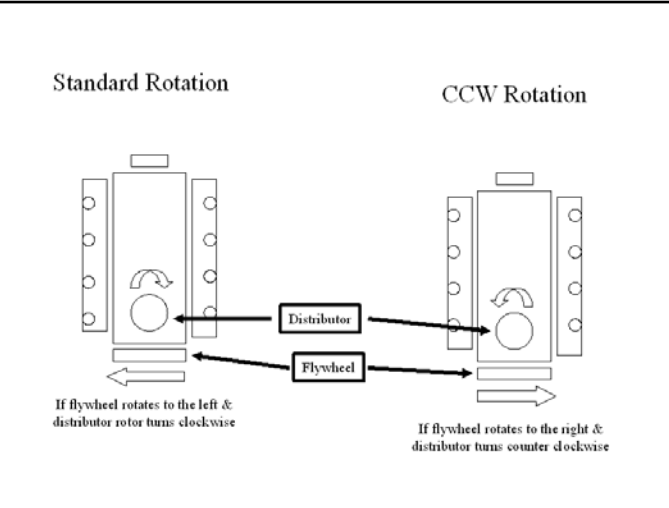

**EXHAUST MANIFOLD
HARDWARE MOUNTING KITS**

**EXHAUST ELBOW
HARDWARE MOUNTING KITS**

Exhaust Manifold	Elbow O.E. #	Kit
18-1997-1	Barr CHV-1-83 Indmar 53-1027 Marine Power 0994-000	18-8536

Exhaust Elbow	Elbow O.E. #	Closed Cooling Kit	Raw Water Cooling Kit
18-1999	Barr 20-0082	18-8535	18-4364
18-1939	Barr 20-0100	18-8535	18-4364

① Priced per Package

PLEASURECRAFT MODEL IDENTIFICATION

MODEL 0 2 - 6 0 0 V - 0 1 SERIAL 460000

1st - 2nd Space: **MANUFACTURING CODE**

3rd - 5th Space: **ENGINE CODE**

810	= 8.1L (496 CID MPI)	(GM)
811	= 8.1L (496 CID H.O. MPI)	(GM)
600	= 6.0L (364 CID MPI)	(GM)
570	= 5.7L (350 CID LH MPI)	(GM)
571	= 5.7L (350 CID RH MPI)	(GM)
572	= 5.7L (350 CID LH Carburetor)	(GM)
573	= 5.7L (350 CID RH Carburetor)	(GM)
500	= 5.0L (305 CID LH MPI)	(GM)
501	= 5.0L (305 CID RH MPI)	(GM)
502	= 5.0L (305 CID LH Carburetor)	(GM)
503	= 5.0L (305 CID RH Carburetor)	(GM)

SERIAL NUMBER I.D.

1st DIGIT INDICATES DECADE ENGINE WAS MANUFACTURED (3 = 1990, 4 = 2000, 5 = 2010)
2nd DIGIT INDICATES YEAR ENGINE WAS MANUFACTURED.

6th Space: **DRIVE CONFIGURATION**

blank - Direct Drive
V - V-Drive

7th - 8th Space: **SPECIFICATION CODE**



18-5251 TUNE-UP KIT

Part #	-CONTAINS- O.E. #	Description
18-5314	R114001, R114004	Contact Set
18-5338	R115001	Condenser
18-5404	R103001	Rotor
	Mallory 8 cyl. Tall Cap	



18-5255 TUNE-UP KIT

Part #	-CONTAINS- O.E. #	Description
18-5303	R114002	Contact Set
18-5345	R115002	Condenser
18-5407	R103003	Rotor



18-5260 TUNE-UP KIT

Part #	-CONTAINS- O.E. #	Description
18-5303	R114002	Contact Set
18-5345	R115002	Condenser
18-5403	R103004	Rotor



18-5266 TUNE UP KIT

Fits: Flame Thrower Distributors 18-5481, 18-5482, 18-5483, 18-5477, 18-5478, 18-5479



18-5271 TUNE-UP KIT

Part #	-CONTAINS- O.E. #	Description
18-5314	R114001, R114004	Contact Set
18-5338	R115001	Condenser
18-5404-1	R103001	Rotor
18-5376	R108001	Distributor Cap
	Mallory V-8 Tall Cap	



18-5275 TUNE-UP KIT

Part #	-CONTAINS- O.E. #	Description
18-5303	R114002	Contact Set
18-5347	-	Condenser
18-5403	R103004	Rotor
18-5352	RA108003	Distributor Cap
	Prestolite V-8 Screw Down Cap	



APPLICATION ON PAGE 545

Ⓛ Items ending in "D" are Display Packaged - Regular number is Non-Display



**18-5276
TUNE-UP KIT**

-CONTAINS-

Part #	O.E. #	Description
18-5303	R114002	Contact Set
18-5347	—	Condenser
18-5403	R103004	Rotor
18-5353	—	Distributor Cap

Prestolite V-6 Screw Down Cap

Display Package



**18-5277
TUNE-UP KIT**

-CONTAINS-

Part #	O.E. #	Description
18-5303	R114002	Contact Set
18-5347	—	Condenser
18-5407	R103003	Rotor
18-5369	RA108002	Distributor Cap

Prestolite V-8 Clip Down Cap

Display Package



**18-5301
TUNE-UP KIT**

Fits: male cap v-8 flamethrower distributors

NEW



**18-5302
TUNE-UP KIT**

Fits: male cap v-8 flamethrower distributors

NEW



**18-5278
TUNE-UP KIT**

Delco EST · V-6



**18-5281
TUNE-UP KIT**

Delco EST · V-8



**18-5303
CONTACT SET**

Replaces: R114002



**18-5314
CONTACT SET**

Replaces: R114001,
R114004



**18-5317
CONTACT SET**



**18-5338
CONDENSER**

Replaces: R115001



**18-5345
CONDENSER**

Replaces: R115002



**18-5346
CONDENSER**



**18-5347
CONDENSER**



**18-5245
ROTOR**

Replaces: R103011

For: Models MP 5.0L and 5.7L (2002-05)



**18-5403
ROTOR**

Replaces: R103004



**18-5404-1
ROTOR**

Replaces: R103001



**18-5407
ROTOR**

Replaces: R103003



**18-5300
ROTOR**

Fits: Flamethrower Distributors

NEW



**18-5474
DISTRIBUTOR CAP**

Red Distributor Cap with Male Terminals
Petronix Dsistributors

 <p>18-5473 DISTRIBUTOR CAP Black Distributor Cap w/ Male Terminals Petronix Dsistributors</p>	 <p>18-5244 DISTRIBUTOR CAP Replaces: RA108009 For: Models MP 5.0L and 5.7L (2002-05)</p>	 <p>18-5352 DISTRIBUTOR CAP Replaces: RA108003</p>	 <p>18-5353 DISTRIBUTOR CAP</p>
 <p>18-5359 DISTRIBUTOR CAP</p>	 <p>18-5369 DISTRIBUTOR CAP Replaces: RA108002 Includes: 18-5399 Gasket</p>	 <p>18-5376 DISTRIBUTOR CAP Replaces: R108001</p>	 <p>18-5389 DISTRIBUTOR CAP</p>

Ignitor® II
ELECTRONIC IGNITION

FEATURES

- Senses current levels in the coil and adjusts the dwell to maintain peak energy throughout the entire RPM range.
- Develops, on average, 4 times more available energy between 3000 and 5000 RPM's and twice as much plug voltage as point-type systems.
- Ignition energy is sustained and coil life is increased when peak current level is reached just prior to spark.
- More stable timing.
- Use with 18-5472 "Flame Thrower II" Coil for optimum performance

 <p>18-5286 HI-PERFORMANCE ELECTRONIC CONVERSION KIT Fits: 6 Cylinder Delco Distributors</p>	 <p>18-5288 HI-PERFORMANCE ELECTRONIC CONVERSION KIT Fits: Most Prestolite V-8 Distributors with snap down cap</p>	 <p>18-5289 HI-PERFORMANCE ELECTRONIC CONVERSION KIT Fits: Most Prestolite V-8 Distributors with screw down cap</p>	 <p>18-5290 HI-PERFORMANCE ELECTRONIC CONVERSION KIT Fits: Most Mallory YL or YD 8 cylinder Distributors with clockwise and counter clockwise rotation</p>
---	---	---	---

IGNITOR
ELECTRONIC IGNITION

FEATURES

- Replaces points & condensers for true solid state ignition.
- Uses standard coil, cap and rotor.
- Easy to install, one-piece, 2-wire hook-up.
- Accurate to within 1/4° timing accuracy 0 to 6000 RPM range.
- Can be used with Flame Thrower Coils 18-5466 & 18-5469.

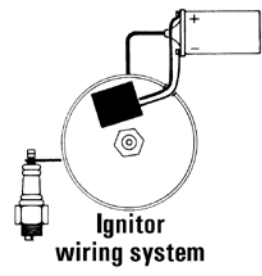
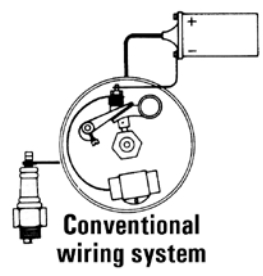

 <p>18-5294 ELECTRONIC CONVERSION KIT Fits: 6 Cyl. Delco distributors</p>	 <p>18-5295 ELECTRONIC CONVERSION KIT Fits: Most 4 Cyl. Prestolite distributors (Except IBM 7026) For: Onan, Universal, Waukesha, Wisconsin</p>	 <p>18-5296-2D Display Package 18-5296-2 ELECTRONIC CONVERSION KIT Fits: Most Mallory V-8 YL & YD 8 cyl. Distributors with clockwise and counter clockwise rotation</p>
--	--	--

APPLICATION ON PAGE 545

① Items ending in "D" are Display Packaged - Regular number is Non-Display



18-5298
ELECTRONIC CONVERSION KIT
 (with snap down cap)
 For: Most Prestolite V-8 Distributors



18-5299D Display Package
18-5299
ELECTRONIC CONVERSION KIT
 (with screw down cap)
 For: Most Prestolite V-8 Distributors
 Use with 18-5403 Style Rotor

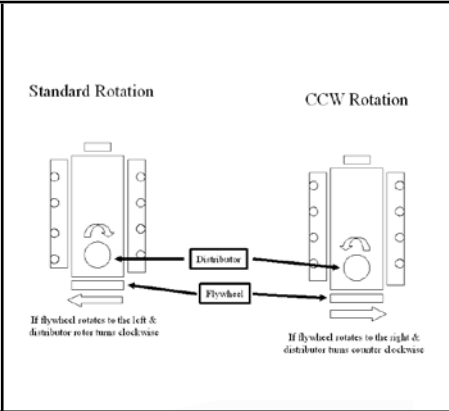

18-5309
DISTRIBUTOR
 Replaces: RA107001
 Mallory YL512CV
 For most Ford 302 CID V-8 Eng.
 Uses: 18-5251 TUNE-UP KIT
 — CONTAINS —
 Part # Desc.
 18-5314 Contact Set
 18-5338 Condenser
 18-5404-1 Rotor
 And 18-5376 CAP

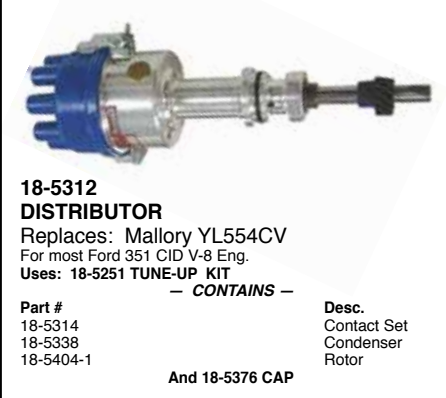

18-5312
DISTRIBUTOR
 Replaces: Mallory YL554CV
 For most Ford 351 CID V-8 Eng.
 Uses: 18-5251 TUNE-UP KIT
 — CONTAINS —
 Part # Desc.
 18-5314 Contact Set
 18-5338 Condenser
 18-5404-1 Rotor
 And 18-5376 CAP



18-5313
DISTRIBUTOR
 Replaces: Mallory YL624MW
 For most GM V-8 Eng.
 (small & large blocks)
 Uses: 18-5251 TUNE-UP KIT
 — CONTAINS —
 Part # Desc.
 18-5314 Contact Set
 18-5338 Condenser
 18-5404-1 Rotor
 And 18-5376 CAP



FEATURES

- Distributors feature the Ignitor II ignition module with adaptive dwell control adjusts the spark timing over the entire RPM range to maximize performance
- Upper roller bearing and oil impregnated bronze sintered bottom bushing are installed and aligned bored for accuracy for maximum durability
- Machined heat treated gear with tight tolerances insures durability and consistent timing to maximize horsepower and performance. Complete with high dielectric strength cap and rotor for years of performance



18-5481
HI-PERFORMANCE ELECTRONIC DISTRIBUTOR
 Fits: Ford V-8 351 Windsor
 Replacement cap/rotor kit 18-5266



18-5482
HI-PERFORMANCE ELECTRONIC DISTRIBUTOR
 Fits: Ford V-8 351 Cleveland, 351M, 400, 429 and 460 engines
 Replacement cap/rotor kit 18-5266



18-5483
HI-PERFORMANCE ELECTRONIC DISTRIBUTOR
 Fits: Chevrolet Marine Small and Big Block engines
 (Standard Deck Height)
 Replacement cap/rotor kit 18-5266

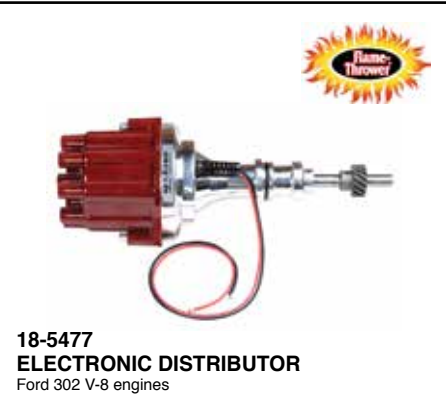

18-5477
ELECTRONIC DISTRIBUTOR
 Ford 302 V-8 engines



18-5478
ELECTRONIC DISTRIBUTOR
 Chrysler LA series V-8 engines



18-5479
ELECTRONIC DISTRIBUTOR
 GM V-8 engines-reverse rotation

APPLICATION ON PAGE 545

① Items ending in "D" are Display Packaged - Regular number is Non-Display



**18-5484-1
ELECTRONIC DISTRIBUTOR**

Left Hand Rotation
Replaces: Mallory YLE624AV
Late Model HEI

For V8 — 262-454 & 502 except 384/409 and tall block engines
• Designed as a plug-in for GM-style fuel injection system distributors
—CONTAINS—

Description	Part #
Distributor Cap	18-5354
Rotor	18-5405



**18-5485
ELECTRONIC DISTRIBUTOR**

Right Hand Rotation
Replaces: Mallory YLE624BV
Late Model HEI

For V8 — 262-454 & 502 except 384/409 and tall block engines
• Designed as a plug-in for GM-style fuel injection system distributors
—CONTAINS—

Description	Part #
Distributor Cap	18-5354
Rotor	18-5405



**18-5494-1
ELECTRONIC DISTRIBUTOR**

Conventional Rotation

For Chevrolet all V8 includes 482, 502, 540 CID (Except 348,409 & Tall Deck Big Block)

—CONTAINS—

Part #	Description	Part #	Description
18-5376	Distributor Cap	18-5404-1	Rotor
18-5488	Module		



**18-5498-1
ELECTRONIC DISTRIBUTOR**

Reverse Rotation

For Chevrolet all V8 includes 482, 502, 540 CID (Except 348,409 & Tall Deck Big Block)

—CONTAINS—

Part #	Description	Part #	Description
18-5376	Distributor Cap	18-5404-1	Rotor
18-5488	Module		



**18-5489
ELECTRONIC DISTRIBUTOR**

Conventional Rotation

For Ford V-8 351W CID

—CONTAINS—

Part #	Description	Part #	Description
18-5376	Distributor Cap	18-5404-1	Rotor
18-5488	Module		



**18-5495-1
ELECTRONIC DISTRIBUTOR**

Replaces: Mallory YLM512CV
Conventional Rotation

For Ford V8 302 CID

—CONTAINS—

Part #	Description	Part #	Description
18-5376	Distributor Cap	18-5404-1	Rotor
18-5488	Module		



**18-5496-1
ELECTRONIC DISTRIBUTOR**

Conventional Rotation

For Ford V-8 351C — 460 CID

—CONTAINS—

Part #	Description	Part #	Description
18-5376	Distributor Cap	18-5404-1	Rotor
18-5488	Module		



**18-5480
COMPLETE IGNITION CONVERSION KIT**

Fits: GM SB & BB with Standard Deck Height

—CONTAINS—

Part #	Description	Part #	Description
18-5472	Coil	18-5483	Distributor
18-8803-2	Wire Set		

PREMIUM MARINE SPARK PLUG WIRE LEADS



OE style boots provide a sealed barrier against heat, dirt and moisture.



Model	Ignition Type	Cyl.	Part #
4.3L	Delco EST	V-6	18-8810-1
V-6	Conventional	V-6	18-8801-1
V-8	Conventional	V-8	18-8803-2
5.0/5.7L	Delco EST	V-8	18-8820-1
V-8	Mallory Side Terminal	V-8	18-8823-1
7.4L	Delco EST	V-8	18-8824-1

**Premium Marine Wire Leads
Magnetic Suppression Core Manufactured
for your specific application**

- Kevlar® core for maximum durability and long life.
- Durable stainless steel wound conductor for maximum horsepower and engine performance.
- Premium silicone jacketing and boots for the ultimate in high temperature protection.
- Superior RFI suppression for the most sensitive electronic system.
- Corrosion resistant stainless steel spark plug and distributor terminals for maximum conductivity.

APPLICATION ON NEXT PAGE



**18-5225
SPARK PLUG WIRE KIT**
Replaces: Mercury 84-99215A26, 84-813706A26
Kit includes 25 ft. Roll of 7 MM Hypalon Ignition Wire With a Metallic Core and a Large Assortment of Three Different End Fittings.



BATTERY CABLES
Gauge cable with soldered lug terminals on each end to accept 3/8" stud.

Part No.	Size	Color	Gauge
BC88523	2'	red	4
BC88533	2'	black	4
BC88543	4'	red	2
BC88553	4'	black	2
BC88563	6'	red	2
BC88573	6'	black	2
BC88583	8'	red	1
BC88593	8'	black	1



**18-5226
IGNITION WIRE
Metallic Core**
100' Spool
7mm Hypalon



**18-5224
18-5224-9[®]
SPARK PLUG WIRE
TERMINAL**
Replaces: Mercury 20121
OMC 510364



**18-5750
18-5750-9[®]
UNIVERSAL SPARK
PLUG BOOTS**
Supplied complete w/ Terminal Connector
Replaces: OMC 581027, 580339



**18-5752
UNIVERSAL
SPARK PLUG BOOT**
8mm

IGNITION/ELECTRICAL SYSTEMS APPLICATION

Years	Cyl.	Model/Engine	Distributor No.	Contact Set	Condenser	Dist. Cap	Rotor	Tune-Up Kit	Coil	Distributor	Electronic Conv. Kit
1959-72	4	1C	IGW-4118A	—	18-5345	18-5359	—	—	18-5435	—	—
1959-73	4	1C	IGW-4301	—	18-5345	—	—	—	18-5435	—	—
1984-88	6	3.8L Eng.	IBM-7014A	18-5303	18-5345 ④	18-5353	18-5403	18-5260 18-5276 ⑧	18-5434 ⑥ ⑦	—	—
1973-74	8	Mercury Dist.	B64025A2	18-5317	18-5346 ④	18-5389	—	—	18-5433 ⑤	—	—
1976-82	8	305,350, 454 Eng.	IBM-7011	18-5303	18-5345 ④	18-5352	18-5403	18-5260 18-5275 ⑧	18-5434 ③ ④	18-5494-1 ① 18-5498-1 ② 18-5313 ③	18-5299
1983-88	8	305, 350, 454 Eng.	IBM-7013	18-5303	18-5345 ④	18-5352	18-5403	18-5260 18-5275 ⑧	18-5434 ⑥ ⑦	18-5494-1 ① 18-5498-1 ② 18-5313 ③	18-5299
1975-86	8	Ford 302 Eng.	IBM-7007, A	18-5303	18-5345 ④	18-5369	18-5407	18-5255 18-5277 ⑧	18-5434 ⑥ ⑦	18-5495-1 ① 18-5309 ③	18-5298
1975-86	8	Ford 351, 460 Eng.	IBM-7008, A, B, C,	18-5303	18-5345 ④	18-5369	18-5407	18-5255 18-5277 ⑧	18-5434 ⑥ ⑦	18-5496-1 ① 18-5312 ③	18-5298
1986-UP	8	Ford 302 Eng.	Prestolite	N/A	N/A	18-5352	18-5403	N/A	18-5434 ⑥ ⑦	18-5495-1 ① 18-5309 ③	18-5299
1987	8	—	Prestolite	18-5303	18-5345 ④	18-5352	18-5403	18-5260 18-5275 ⑧	18-5434 ⑥ ⑦	—	—
ALL	8	—	Mallory	18-5314	18-5338	18-5376	18-5404-1	18-5251 18-5271 ⑧	18-5434 ⑥ ⑦	—	18-5296-2

- ① Electronic Distributor (Standard Rotation)
- ② Electronic Distributor (Counter Rotation)
- ③ Contact Controlled Distributor (Standard Rotation)
- ④ For strap type, use 18-5347
- ⑤ For applications requiring internal resistor use 18-5436
- ⑥ For applications requiring internal resistor use 18-5435
- ⑦ Use 18-5450 coil resistor
- ⑧ With distributor cap

FEATURES

- Oil filled for better cooling and long life
- Low resistance and improved turn ratios produces the higher voltage needed to run larger spark plug gaps for added power and better fuel economy
- More windings maximize energy and reliability over the full RPM range
- Fits existing brackets for easy installation



**18-5466
HI-PERFORMANCE
IGNITION COIL**
1.5 ohm (oil filled), black - 8 cylinder:
Flame-Thrower 40,000 volt coil.

- Designed for use with the original Ignitor Electronic Conversion Kits
- Can be used with other inductive ignition systems



**18-5469
HI-PERFORMANCE
IGNITION COIL**
3.0 ohm (oil filled), black - 4 & 6 cylinder:
Flame-Thrower 40,000 volt coil.

- Designed for use with the original Ignitor Electronic Conversion Kits
- Can be used with other inductive ignition systems



**18-5472
HI-PERFORMANCE
IGNITION COIL**
0.6 ohm (oil filled), black - 4, 6, & 8 cylinder: Flame-Thrower 45,000 volt coil.

- Super low 0.6 ohm resistance coil designed for use with the Ignitor II Hi Performance Electronic Conversion Kits
- Compatible with capacitive discharge systems

Part #	Description	Recommended Coil	Resistance Ohms	Part #	Description	Recommended Coil	Resistance Ohms
18-5294	Electronic Conversion Kit	18-5469	3.0	18-5288	Hi Performance Electronic Conversion Kit	18-5472	0.6
18-5295	Electronic Conversion Kit	18-5469	3.0	18-5289	Hi Performance Electronic Conversion Kit	18-5472	0.6
18-5296-2	Electronic Conversion Kit	18-5466	1.5	18-5290	Hi Performance Electronic Conversion Kit	18-5472	0.6
18-5298	Electronic Conversion Kit	18-5466	1.5	18-5483	Flame-Thrower Distributor	18-5472	0.6
18-5299	Electronic Conversion Kit	18-5466	1.5	18-5483	Flame-Thrower Distributor	18-5472	0.6
18-5286	Hi Performance Electronic Conversion Kit	18-5472	0.6	18-5483	Flame-Thrower Distributor	18-5472	0.6

® Priced per Package



18-7648
IGNITION COIL
Replaces: R117012



Display Package

18-5433
IGNITION COIL
Uses External Resistor



18-5434
IGNITION COIL
Replaces: R117001
Uses External Resistor



18-5435
IGNITION COIL
Has Internal Resistor



18-5436
IGNITION COIL
Has Internal Resistor



18-5450
COIL RESISTOR
Replaces: R119001



18-9802
TIMING LIGHT
Self-powered accurate
up to 10,000 RPM's



18-5464
IGNITION MODULE
Fits: Sierra 18-5481, 18-5482 and 18-5483
Billet HI-PERFORMANCE ELECTRONIC
DISTRIBUTORS (except HEI/EST)



18-5603
STARTER
Replaces: RA122009
Noseless:CCW Top mount rear entry starter
for standard rotation GM & Ford engines. Can
be used in place of 18-5908 and 18-5902



18-6443
STARTER
Replaces: RA122019
PG260, CW that fits GM 6.0L



CE

18-5907
STARTER

18-5901
REMANUFACTURED STARTER
(Heavy-Duty) (No Core) Clockwise
Replaces: RA122008
Replacement Solenoid: 18-5837
Will not replace non-starter mounted solenoids.
Top mount rear entry started for opposite rotation GM & FORD engines.
SAEJ1171

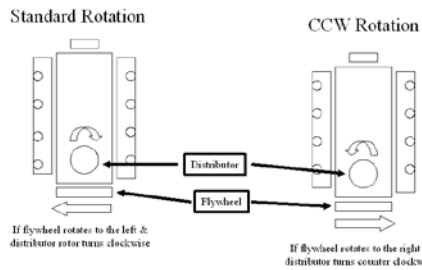

18-5908
STARTER

18-5902
REMANUFACTURED STARTER
(Heavy-Duty) (No Core) Counter-Clockwise
Replaces: RA122009
Replacement Solenoid: 18-5837
Top mount rear entry started for standard rotation GM & FORD engines.
SAEJ1171



CE

18-5902
REMANUFACTURED STARTER



**18-5903
STARTER
(No Core) Clockwise**
Replaces: RA122001
Replacement Solenoid: 18-5801
Bottom mount, two bolt pattern for standard rotation FORD engines.





**18-5920
STARTER**
For: 5.0 & 5.8 litre Ford engines.
Replaces: 987811, RRK122014, RA122001

① **18-5801D** Display Package



**18-5801
SOLENOID**
Replaces: R130001
For all engines with flat solenoid bracket

CE

**18-5957
ALTERNATOR**

**18-5951
ALTERNATOR**
Remanufactured
(3-Wire) (68 amp) (No Core)
Replaces: RA097002, RA097003, RA097006
Replaces Mando, Motorola and original equipment Delco. Uses same electrical connections and mounting method. Equipped with fan and drive pulley.
SAEJ1171



**18-5984
ALTERNATOR**
Replaces: RA097007B
7SI/70 amp, spool mount, 2 5/8" OD, 6 groove serpentine pulley
Clockwise position, 65mm



**18-6288
ALTERNATOR**
Replaces: RA097007B
7SI/70 amp, spool mount, single groove V-belt pulley



**18-6450
ALTERNATOR**
Replaces: RA97007, RA097007A
7SI/70 amp, spool mount, smaller serpentine pulley
Clockwise position, 50mm



**18-6452
ALTERNATOR**
Replaces: RA097009
11SI/95 amp spool mount, serpentine pulley



**18-6453
ALTERNATOR**
Replaces: RA097007C
7SI/70 amp spool mount, serpentine pulley



**18-7227
CHOKE THERMOSTAT**
Replaces: RN0067
For Holley Carburetors



**18-5727
VOLTAGE REGULATOR**
Replace: R098002, Prestolite VSH-6201ADY
For: FORD through 1982, GM 1976-89
Used with Alternators: ALK-6212Y,YS, ALK-6220Y,YS



**18-7206
FLOAT**
Nitrophyl

① Items ending in "D" are Display Packaged - Regular number is Non-Display



**18-7017
CARB KIT**
(Contains non-adjustable needles & seats)
Replaces: RN0118-1, RN0120-1



**18-7081
CARB KIT**
Replaces: RN0116, RN0116-2



**18-7096
CARB KIT**
Replaces: RN0118, RN0120

CARBURETOR KIT AND FLOAT APPLICATION

Engine/Model	Cyl.	Mfg. Code	Carb. Model	Carburetor No.	Float	Carb. Kit ①
155, 165, 175, 185 w/302" (5.0L)	8	H-2	2300	R-6150A, R-6317A, R-6317-1A, R-7036A (D1JJ-9510-B, D3JL-9510-S)	18-7206	18-7081
215, 255, 215 w/302" (5.0L) 351" (5.8L)	8	H-4	4160	R-4473A, R-4473AAS, R-4608A, R-4608AAS, R-6151A, R-6151AAA, R-6152A, R-6152AAA, R-6407A, R-6576A (C9FF-9510-E, D2JL-9510E)	18-7206	18-7096
215, 255 w/302" (5.0L) 351" (5.8L)	8	H-4	4160	R-7159A, R-7163A, D4JL-9510-F, D4JL-9510-G	—	18-7017

① Does not include metering rods.



**18-7646
CAMSHAFT SENSOR**
Replaces: R020035A



**18-7677
KNOCK SENSOR**
Replaces: R020027



**18-7697
IAC MOTOR**
Replaces: R084003

FUEL WATER SEPARATORS



Sierra offers a complete line of 10 and 21 micron fuel water separating filters including drainable bowl filters to protect your carbureted and fuel injected engine.

Refer to pages 126-130 for a complete listing of OEM and universal applications.

Sierra fuel water separators remove over 99.8% of emulsified water from your gasoline. Sierra's 10 micron filters are over 90% efficient at removing particles as small as 10 micron. All filters flow @ 90 GPH to feed even the hungriest motor. Sierra 10 micron filters are recommended to prevent damage to sensitive inboard and outboard fuel injection systems.

Sierra #	Pleasurecraft #	Description
18-7976	47047	Fuel Filter with O-Rings
18-7964		Fuel Filter



18-7267
FUEL PUMP
 Flange I.D. #41414
 For: Ford (V-8) 302



18-3583
CIRCULATING WATER PUMP
(Bi-Directional)
 Replaces: RA057018



18-3577
CIRCULATING WATER PUMP
(Bi-Directional)
 Replaces: RA057019



18-3584
CIRCULATING WATER PUMP
(Bi-Directional)
 Replaces: RA057004



18-3586
WATER PUMP
 Replaces: RA057023
 For Impeller Repair Kit use **18-3081**



18-3587
WATER PUMP
 Replaces: RA057024



18-5899
OIL PRESSURE SENDER
 Replaces: RO20001



18-3551
THERMOSTAT
 Replaces: R026002E
142°
 For FORD 302/351 CID Engines
 Raw Water Cooled



② **18-3671D** Display Package
18-3671
THERMOSTAT KIT
 Replaces: RP026002E
 For FORD 302/351 CID Engines Includes:
 18-3551 Thermostat and
 18-0875 Gasket
 Raw Water Cooled

PKG. OF 8



FREEZE PLUGS
18-5961 **18-5962**
18-5961-9① **18-5962-9**①
 1 5/8" 1 3/4"



18-3060
IMPELLER
 Replaces: RP061015
 Sherwood 9959
 For FORD Engines



18-3061
IMPELLER
 Replaces: RP061017
 Sherwood 10615
 For GM Engines
 With V-Belt



② **18-3081D** Display Package
18-3081
IMPELLER REPAIR KIT

PKG. OF 2

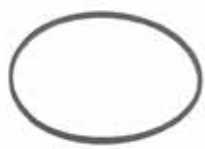

18-7480
18-7480-9①
O-RING
 Replaces: R047111
 For use with **18-3060** & **18-3061** Impeller

① Priced per Package
 ② Items ending in "D" are Display Packaged - Regular number is Non-Display

Fits Ford Small Block V8 302 & 351 cu. in.

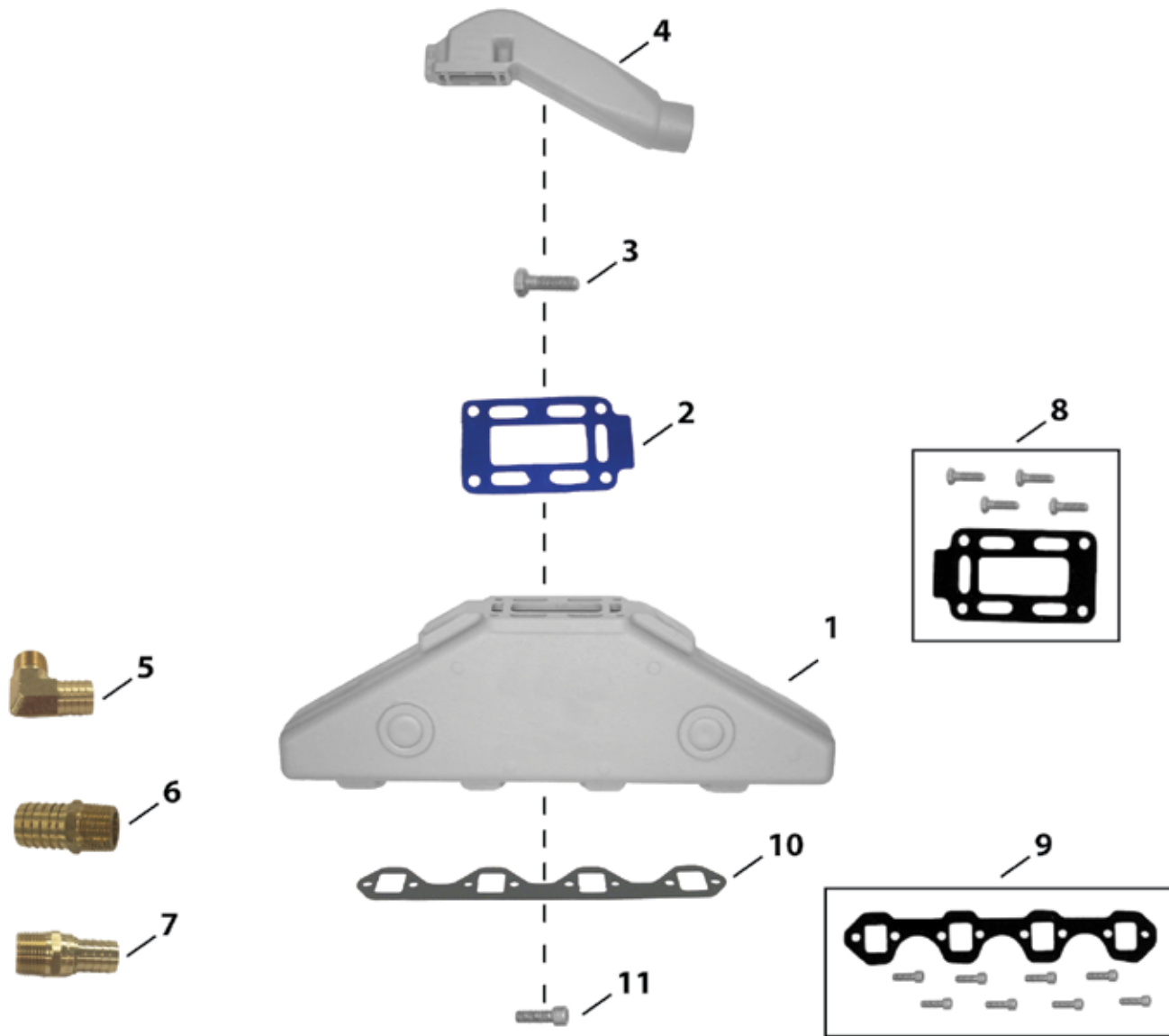

Item No	Description	OE No.	Application	
1	18-1996	MANIFOLD	RO28001	Ford Small Block (V8) 302-351 cu.in.; Use with Manifold Gasket: 18-0183; Mounting Kit: 18-8503
2	18-0677	GASKET	RM0002	Use with Riser: 18-1899; Included in 18-8504 mounting kit.
3	NSS	MOUNTING BOLT	N/A	Included in 18-8504 mounting kit.
4	18-1899	RISER W/ 3" OUTLET	RO29001	Use with Manifold: 18-1996; Riser Gasket: 18-0677; Mounting Kit: 18-8504
5	18-8216	HOSE FITTING	N/A	3/4" - 14NPT X 1" Hose (Corrosion Resistant Brass Fitting)
6	18-4461	HOSE FITTING	N/A	3/4" - 14NPT X 1" Hose (Corrosion Resistant Brass Fitting)
7	18-8215	HOSE FITTING	N/A	3/4" - 14NPT X 3/4" Hose (Corrosion Resistant Brass Fitting)
8	18-8504	MOUNTING KIT	N/A	Use with Manifold: 18-1899. Includes 18-0677 gasket.
9	18-8503	MOUNTING KIT	N/A	Use with Manifold: 18-1996. Includes 18-0183 gasket.
10	18-0183	MANIFOLD GASKET	RM0007	Use with Manifold: 18-1996; Included in 18-8503 mounting kit.
11	NSS	MOUNTING BOLT	N/A	Included in 18-8503 mounting kit.

SIERRA MANIFOLDS ARE PAINTED, PACKAGED AND LEAK TESTED



**18-1997-1
MANIFOLD**
Port & Starboard
Replaces: Barr CHV-1-83
Universal Center Riser Manifold
FITS: GM 283, 305, 307 and 350 CID engines
Use 18-0604 Exhaust Manifold Gasket Set
***For Exploded View - See Pages 558-559**



**18-1996
MANIFOLD**
Port & Starboard
Replaces: Pleasurecraft RO28001
Pleasurecraft Ford Small Block V8 302 and 351 cu. in.
Used with:
Exhaust Manifold Gasket: 18-0183
Mounting Kit: 18-8503



**18-1998-1
MANIFOLD**
Port & Starboard
Replaces: Barr FM-1-83
Universal Center Riser Manifold
FITS: Ford 302 and 351 CID engines
Use 18-0603 Exhaust Manifold Gasket Set
***For Exploded View - See Pages 560-561**



**18-1991
ELBOW ADAPTER**
For use with 3" I.D. Exhaust Hose
Use 18-1999 Manifold Riser
30°



**18-1992-1
ELBOW ADAPTER**
For 3" I.D. Exhaust Hose
(As used in 18-1987 Exhaust Manifold Conversion Kit)
80°



**18-1899
RISER**
Replaces: Pleasurecraft RO29001
Fits: small block 302/351cu.in. Ford with 3" outlet.
Fits: 18-1996 Manifold
Used with:
Manifold: 18-1996
Riser Gasket: 18-0677
Mounting Kit: 18-8504



**18-1999
ELBOW**
Replaces: Barr 20-0082
Comes with 18-4364 open Mounting Package
If blocked mounting kit is required use 18-8535
Use 18-2854 open, 18-0476 blocked
Riser Gasket
Use with;
Manifold: 18-1997 or 18-1998-1



**18-4363
EXHAUST ELBOW MOUNTING KIT**
Replaces: Barr FM-1-83-P
Use with:
Manifold: 18-1998-1



**18-4364
EXHAUST ELBOW MOUNTING KIT**
Replaces: Barr 20-0082-P
Use with:
Riser: 18-1999, 18-1907, 18-1939



**18-8503
EXHAUST MANIFOLD MOUNTING KIT**
Pleasurecraft Ford Small Block
V8 302 and 351cu.in.
Used with:
Manifold: 18-1996

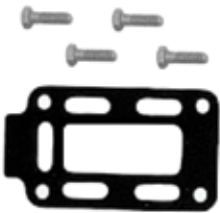

**18-8504
EXHAUST ELBOW MOUNTING KIT**
Pleasurecraft Ford Small Block
V8 302 and 351cu.in.
Used with:
Riser: 18-1899



**18-8535
EXHAUST ELBOW MOUNTING KIT**
Barr, Indmar and Marine Power Ford Small
Block V8 302-351cu.in., GM Small Block V8
305-350cu.in., GM Big Block V8 454cu.in.
Used with:
Risers: 18-1939, 18-1999, and 18-1907



18-8536
EXHAUST ELBOW MOUNTING KIT
 Barr, Indmar and Marine Power GM Small Block V8 305-350cu.in.
 Used with:
 Manifold: 18-1997-1



18-8538
EXHAUST MANIFOLD MOUNTING KIT
 Barr and Indmar Ford Small Block V8 302-351cu.in.
 Used with:
 Manifold: 18-1998-1



18-0603
EXHAUST MANIFOLD GASKET SET
 For: Ford 302/351 CID Engines
 Use with:
 Manifold: 18-1998-1

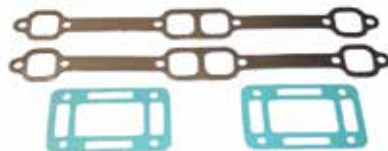

18-0604
EXHAUST MANIFOLD GASKET SET
 For: GM 305/350 CID Engines
 Use with:
 Manifold: 18-1997-1



PIPE PLUGS

Part #	Thread Size
18-4256	1/4"
18-4257	1/4"
18-4258	3/4"
18-4263	1/8" - 27 NPT
18-4264	3/8" - 18 NPT

56507 Pipe Sealant with Teflon® is recommended for use on plug threads.



18-0183
EXHAUST MANIFOLD GASKET
 Replaces: RM0007
 Use with:
 Manifold: 18-1998-1



18-0676
EXHAUST ELBOW GASKET
 Replaces: RM0099



PKG. OF 2

18-0677
18-0677-9^①
EXHAUST ELBOW GASKET
 Replaces: RM0002
 Use with:
 Mounting Kit: 18-8504
 Riser: 18-1899



PKG. OF 2
18-2854
18-2854-9^①
EXHAUST ELBOW GASKET
 Use with:
 Riser: 18-1999, 18-1907, 18-1939



PKG. OF 2
18-2949
18-2949-9^①
EXHAUST MANIFOLD GASKET
 Replaces: Barr CHV-47-000
 Use with:
 Manifold: 18-1997-1



②18-4218D 
18-4218
DRAIN TAP
 Used with most O.E.M. Manifolds
18-3223-9 Bulk Pack of 12
 1/4" Brass



PKG. OF 2
18-0875
18-0875-9^①
THERMOSTAT GASKET



PKG. OF 2
18-0878
18-0878-9^①
THERMOSTAT GASKET
 Replaces: RM0003



PKG. OF 2
18-0889
18-0889-9^①
FUEL PUMP GASKET
 Replaces: 3705042



18-0898
OIL PUMP MOUNTING GASKET
 Replaces: RM0017

^① Priced per Package

^② Items ending in "D" are Display Packaged - Regular number is Non-Display



Display Package

OIL FILTERS

Part #	Replaces:	Application
18-7824	R077002	GM Engines (Short)
18-7875	R077001	Ford Engines (Long)
18-7876	—	GM Engines, (Long)
18-7878-1	Ford (Short)	

SEE PAGES 152-154 FOR ADDITIONAL INFORMATION

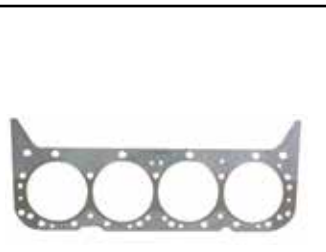

18-3876 HEAD GASKET
Replaces: GM 6269577
For: GM 305/350 CID Engines



18-3883 HEAD GASKET
Replaces: RM0032
For FORD 302 and 351 CID Engines



Display Package

18-4461 HOSE BARB
3/4" - 14 NPT x 1" Hose
Corrosion Resistant Brass Fitting



18-8215 HOSE BARB



18-2434 FLYWHEEL BELL HOUSING
Replaces: R142006
For: GM Blocks



Display Package

18-2103 POWER TRIM HOSE
Replaces: RO85035



18-2702-1 POWER TRIM BUSHING
Replaces: R094020A



18-4220 THRUST WASHER
Replaces: R096116



18-4214 LOCKING WASHER
Replaces: RO96081



Display Package

18-3701 PROP NUT KIT
-CONTAINS-
Part # O.E. # Desc.
18-3200 R096117 Tab Washer
18-3700 R017066 Prop Nut



18-3700 PROP NUT
Replaces: R017066



18-3200 TAB WASHER
Replaces: R096117



18-4446 PROP WRENCH KIT
- CONTAINS -
Part # Desc. O.E.# Qty.
18-3200 Tab Washer R096117 2
18-3700 Prop Nut R017066 1
18-4444 Prop Wrench — 1



18-4444 PROP WRENCH



② 18-4456D

Display Package

18-4456 EXHAUST PROTECTOR VALVE
Includes Stainless Steel Clamp
3"



② 18-4457D

Display Package

18-4457 EXHAUST PROTECTOR VALVE
Includes Stainless Steel Clamp
4"



② 18-4458D

Display Package

18-4458 EXHAUST PROTECTOR VALVE
Includes Stainless Steel Clamp
5" & 6"

① Priced per Package

② Items ending in "D" are Display Packaged - Regular number is Non-Display

UNIVERSAL

 18-5311 CONTACT SET	 18-5307 CONTACT SET	 18-5310 CONTACT SET	 18-5345 CONDENSER
 18-5347 CONDENSER	 18-5268 TUNE-UP KIT	 18-5354 DISTRIBUTOR CAP	 18-5359 DISTRIBUTOR CAP
 18-5385 DISTRIBUTOR CAP	 18-5418 ROTOR	 18-5427 ROTOR	
 18-5419 ROTOR	 18-5430 ROTOR	 18-5433 IGNITION COIL <small>For: Atomic Four w/resistor (1969-70), Super Sabre (1948-70)</small>	

PARTS FOR CONTACT CONTROLLED DISTRIBUTORS

Year	Cyl.	Model or Engine	Distributor	Contact Set	Condenser	Cap	Tune-Up Kit	Rotor
1969-70	4	Atomic Four	DELCO	18-5311	18-5345	18-5385	18-5268	18-5418
1961-70	4	Unimite Four, HF (Herc. IXB), LSG Super Four, BFA, BN Utility Four, BR, FA, UJ Atomic Four, UJ64	IGW	—	—	18-5354	—	—
	6	Arrow, Bluefin, Economy, Bullet, Knight, Marlin, Tarpon	IGC-5501A	18-5307	18-5347 ^①	—	—	18-5430
1954-68	6	Explorer Master, OK, OL, Z, Super Six	IAY-4009-1, IA	18-5307	—	—	—	18-5427
1963-65	6	Super Sabre	1110322	18-5310	—	—	—	18-5419
1945-60	4	HF, UJ, Atomic Four, BFA, BFS, BN, BR, EA, LSG, Racing 4, Super 4	IGW	—	—	18-5359	—	—
1955-57	6	HCS, LHS	IGW-6002B	18-5307	—	—	—	18-5430

^① For lead type, use 18-5345



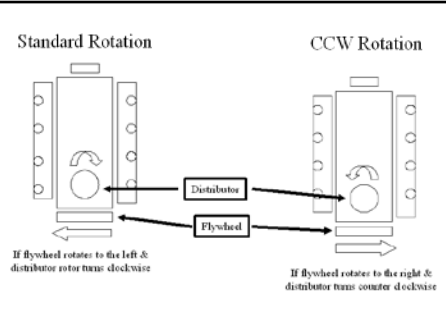

**18-6287
SOLENOID**
12 Volt, 4 Terminal
Use with 18-5910, 18-5905

**18-5804
SOLENOID**

**18-5840
SOLENOID**

**18-6263
ALTERNATOR**
Replaces: 288182, 288759
12 Volt, 51 Amp, Integral Regulator,
Negative Ground, Single Groove Pulley
For: Universal and others
(I/O)

PARTS FOR CHARGING SYSTEMS				PARTS FOR STARTING SYSTEMS			
Year	Model	Volt	Alt. or Gen. No.	Voltage Regulator	Volt	Starter No.	Starter Switch Kit
1961-68	Explorer, Master, Super Six Unimite Four, Atomic Four, Utility Four, Blue Jacket Twin	-	-	-	12	MAU-4046	18-5840
		12	ALE-5202	-	-	-	-
		12	ALE-5204S	18-5710	12	MAU-4006, 47	18-5840
		12	ALK-6204	-	12	MBG-4129, 31	18-5840
1955-68	Knight, Tarpon, Marlin, Bullet, Arrow, Bluefin	-	-	-	6	MAU-4046, 47	18-5840
1954-68	OK, OL, Z Superb, Z Series	-	-	-	6	MAU-4046, 47	18-5840
1961-64	11694 Super Sabre V-6	12	1100619, 54	-	12	1107260	18-5804
1955-57	AMS, HCS, LHS	-	-	-	12	MAB-4116	18-5840

**18-7070
CARB KIT**
For: 198(3.3L), 225(3.7L) E, 6Cyl.
Carb Type and Model: R-2, 2GC
Carb No:7023081,7025181

**18-7071
CARB KIT**
For: 225(3.7L) Eng., 6Cyl.
Carb Type and Model: R-1, BC
Carb No:7024083

FUEL WATER SEPARATORS



Sierra offers a complete line of 10 and 21 micron fuel water separating filters including drainable bowl filters to protect your carbureted and fuel injected engine.

Refer to pages 126-130 for a complete listing of OEM and universal applications.

Sierra fuel water separators remove over 99.8% of emulsified water from your gasoline. Sierra's 10 micron filters are over 90% efficient at removing particles as small as 10 micron. All filters flow @ 90 GPH to feed even the hungriest motor. Sierra 10 micron filters are recommended to prevent damage to sensitive inboard and outboard fuel injection systems.

**18-8114
FUEL LINE HOSE**
For fuel pump to carburetor connection. Replaces copper or steel tubing 3/8" X 31" PTFE composite hose with 5/8"-18 male inverted flare straight one end, 5/8"-18 90° one end. SAE J1527 type A1

**18-8115
FUEL LINE HOSE**
For fuel pump to carburetor connection. Replaces copper or steel tubing 3/8" X 25" PTFE composite hose with 5/8"-18 male inverted flare straight one end, 5/8"-18 90° one end. SAE J1527 type A1

Fits GM 454/502 CID V8 Big Block

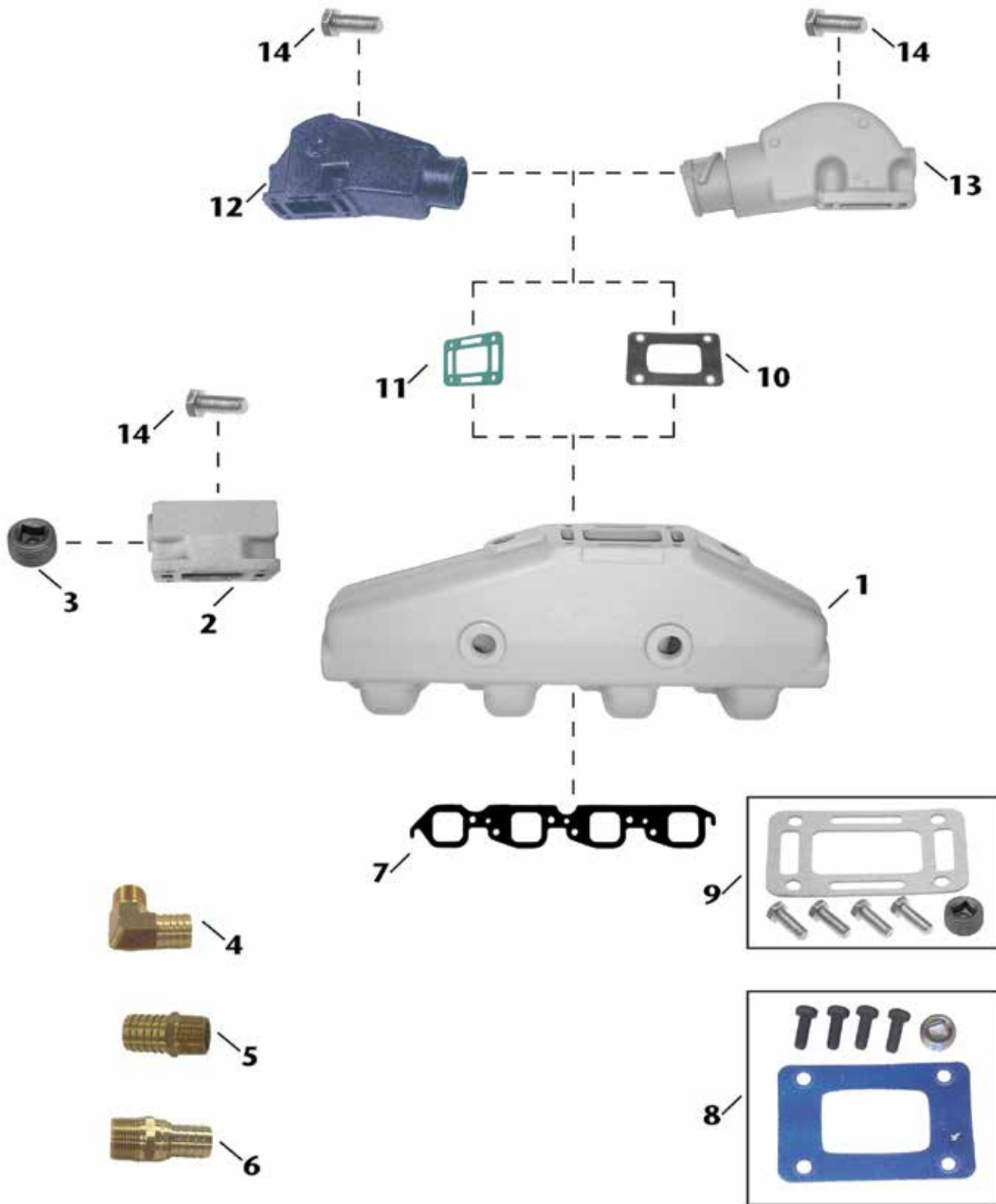

	Item No	Description	OE No.	Application
1	18-1898	MANIFOLD	BARR CHVA-1-84 MARINE POWER 0991-110	Fits 454/502 cu. in. GM Big Block V8 engines. Used with Manifold Gasket: 18-0418.
2	18-1949	MANIFOLD SPACER	N/A	Use with Manifold: 18-1898.
3	18-4258	BLACKSTEEL PLUG	N/A	Thread Size: 3/4". Use with Manifold Spacer: 18-1949.
4	18-8216	HOSE FITTING	N/A	3/4" - 14NPT X 1" Hose (Corrosion Resistant Brass Fitting)
5	18-4461	HOSE FITTING	N/A	3/4" - 14NPT X 1" Hose (Corrosion Resistant Brass Fitting)
6	18-8215	HOSE FITTING	N/A	3/4" - 14NPT X 3/4" Hose (Corrosion Resistant Brass Fitting)
7	18-0418	MANIFOLD GASKET	CRUSADER 96653	Use with Manifold: 18-1898
8	18-8535	MOUNTING KIT (BLOCKED GASKET)	N/A	Use with Risers: 18-1939, 18-1999, 18-1907. Includes 18-0476 elbow gasket. (Use with a closed cooling system)
9	18-4364	MOUNTING KIT (OPEN GASKET)	BARR 20-0082-P	Use with Risers: 18-1999, 18-1907, & 18-1939. Includes 18-2854 elbow gasket.
10	18-0476	ELBOW GASKET (BLOCKED)	BARR 01-0105	Used with Risers: 18-1939, 18-1999. Included in 18-8535 mounting kit.
11	18-2854	ELBOW GASKET (OPEN)	BARR 01-0107	Used with Risers: 18-1939, 18-1999. Included in 18-4364 mounting kit.
12	18-1999	MANIFOLD ELBOW	BARR 20-0082	Comes with 18-4364 (open) mounting package. If blocked mounting kit is required use 18-8535 mounting kit. Use with Manifold: 18-1898; Riser Gasket: 18-2854 (open) or 18-0476 (blocked)
13	18-1939	MANIFOLD ELBOW	BARR 20-0100 MARINE POWER 0992-593	Use with Manifold: 18-1898; Riser Gasket: 18-2854 (open) or 18-0476 (blocked); Mounting Kit: 18-4364 (open) or 18-8535 (blocked)
14	NSS	MOUNTING BOLT	N/A	Included in 18-4364 & 18-8535 mounting kits.



Fits GM 305/350 CID V8 Small Block

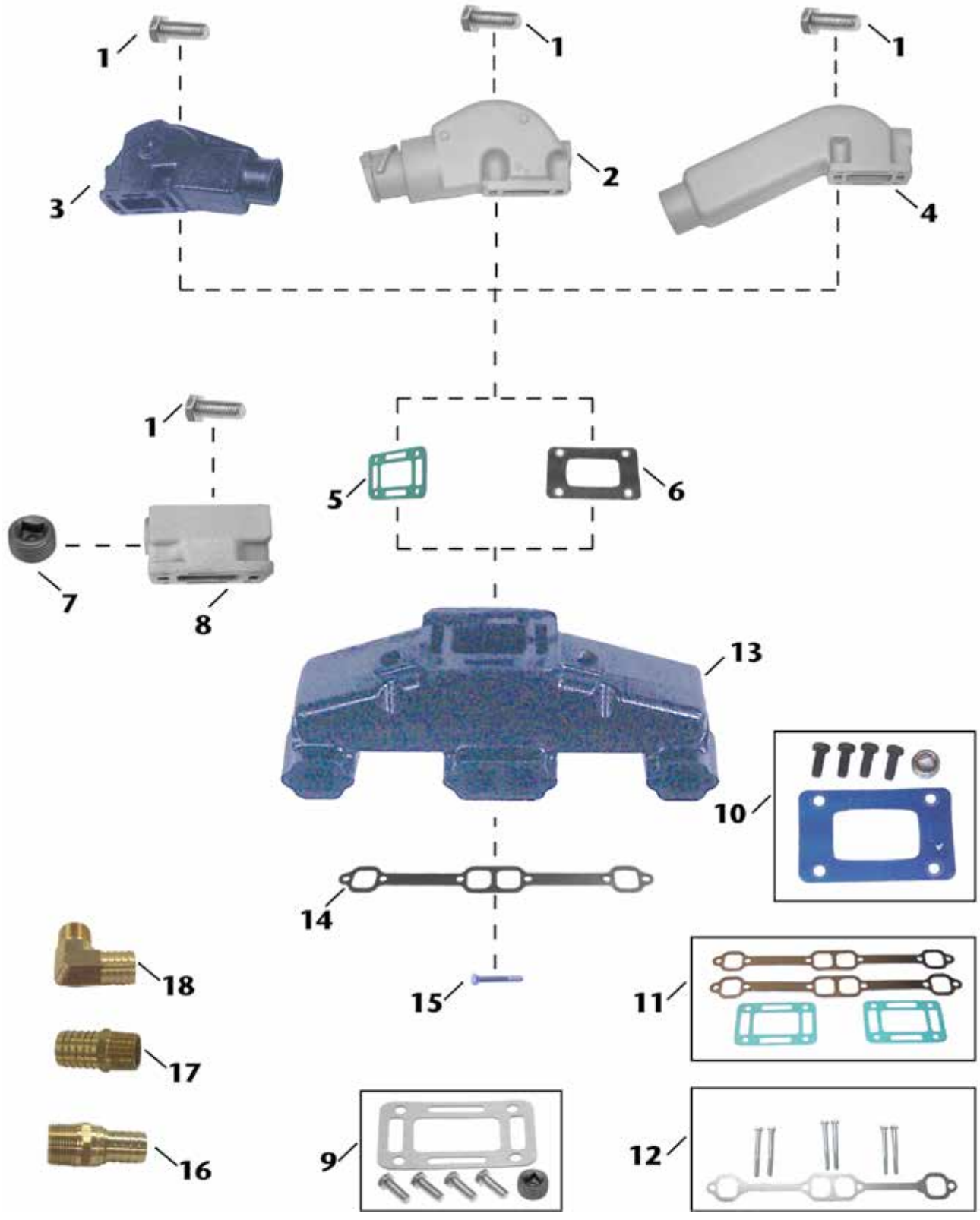

	Item No	Description	OE No.	Application
1	NSS	MOUNTING BOLT	N/A	Included in 18-4364 & 18-8535 mounting kits.
2	18-1939	MANIFOLD ELBOW	BARR 20-0100 MARINE POWER 0992-593	Use with Manifold: 18-1997-1; Riser Gasket: 18-2854 (open) or 18-0476 (blocked); Mounting Kit: 18-4364 (open) or 18-8535 (blocked)
3	18-1999	MANIFOLD ELBOW	BARR 20-0082	Comes with 18-4364 (open) mounting package. If blocked mounting kit is required use 18-8535 mounting kit. Use with Manifolds: 18-1997-1; Riser Gasket: 18-2854 (open) or 18-0476 (blocked)
4	18-1907	MANIFOLD ELBOW	BARR 20-0100 INDMAR 53-2009, INDMAR 53-2018	Use with Manifold: 18-1997-1; Riser Gasket: 18-2854 (open) or 18-0476 (blocked); Mounting Kit: 18-4364 (open) or 18-8535 (blocked)
5	18-2854	ELBOW GASKET (OPEN)	BARR 01-0107	Used with Risers: 18-1939, 18-1999, 18-1907. Included in 18-4364 mounting kit.
6	18-0476	ELBOW GASKET (BLOCKED)	BARR 01-0105	Used with Risers: 18-1939, 18-1999, 18-1907. Included in 18-8535 mounting kit.
7	18-4258	BLACKSTEEL PLUG	N/A	Thread Size: 3/4". Use with Manifold Spacer: 18-1949.
8	18-1949	MANIFOLD SPACER	N/A	Use with Manifold: 18-1997-1.
9	18-4364	MOUNTING KIT (OPEN GASKET)	BARR 20-0082-P	Use with Risers: 18-1999, 18-1907, & 18-1939. Includes 18-2854 elbow gasket.
10	18-8535	MOUNTING KIT (BLOCKED GASKET)	N/A	Use with Risers: 18-1939, 18-1999, 18-1907. Includes 18-0476 elbow gasket. (Use with a closed cooling system)
11	18-0604	EXHAUST MANIFOLD GASKET SET	N/A	GM 305-350 CID Engines; Use with Manifold: 18-1997-1
12	18-8536	MOUNTING KIT	N/A	Use with Manifold: 18-1997-1. Includes 18-2949 mounting kit.
13	18-1997-1	MANIFOLD	BARR CHV-1-83	GM Small Block (V8) 305-350 cu.in. Use with Manifold Gasket 18-2949. Mounting Kit: 18-8536.
14	18-2949	MANIFOLD GASKET	BARR CHV-47-000	Use with Manifold: 18-1997-1. Included in 18-8536 mounting kit.
15	NSS	MOUNTING BOLT	N/A	Included in 18-8536 mounting kit.
16	18-8215	HOSE FITTING	N/A	3/4" - 14NPT X 3/4" Hose (Corrosion Resistant Brass Fitting)
17	18-4461	HOSE FITTING	N/A	3/4" - 14NPT X 1" Hose (Corrosion Resistant Brass Fitting)
18	18-8216	HOSE FITTING	N/A	3/4" - 14NPT X 1" Hose (Corrosion Resistant Brass Fitting)

Fits Ford 5.0L/5.8L 302/351 CID V8

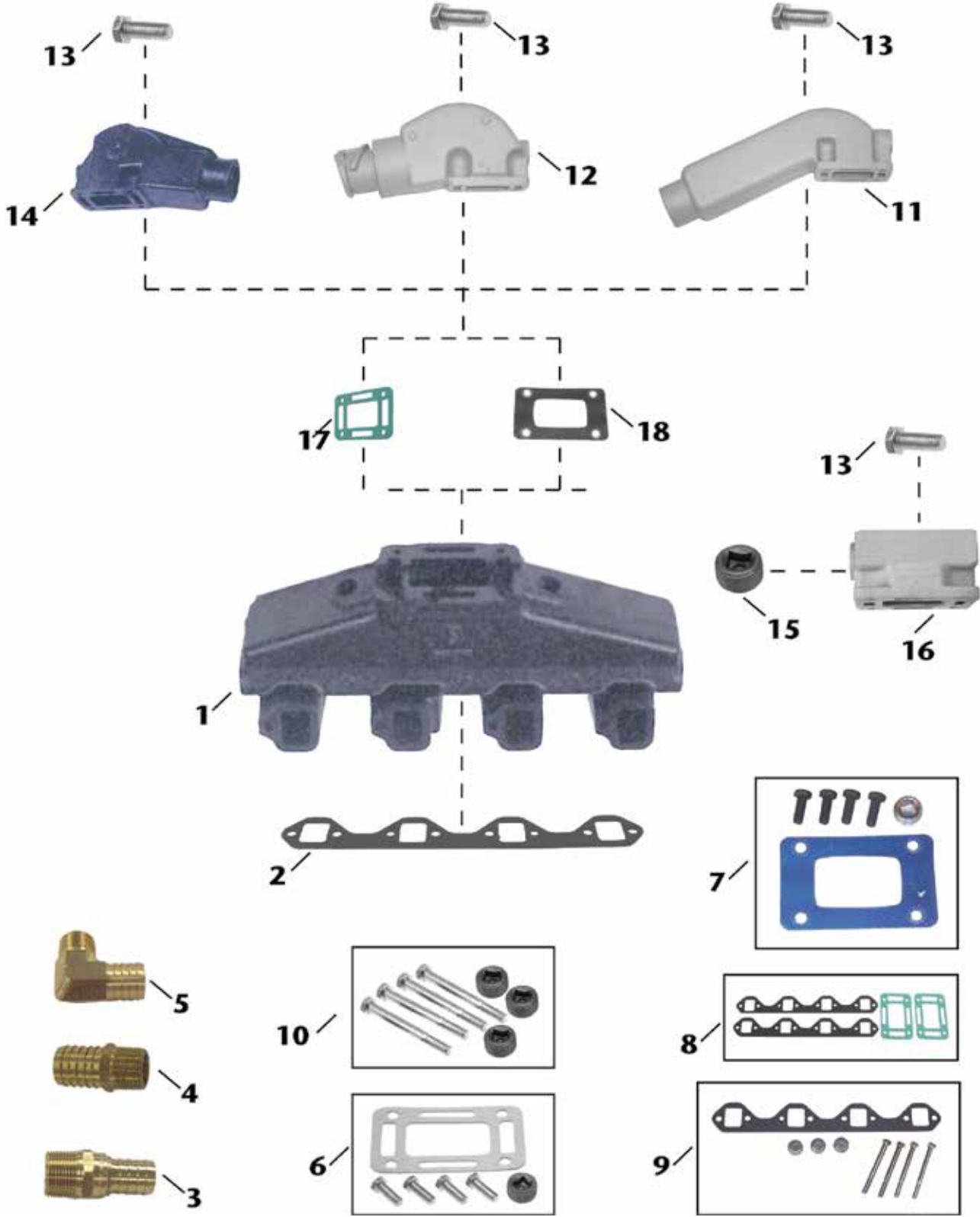

Item No	Description	OE No.	Application
1	18-1998-1 MANIFOLD	BARR FM-1-83	Ford 302-351 (V8) CID Engines. Use with Manifold Gasket: 18-0183; Mounting Kit: 18-8538
2	18-0183 MANIFOLD GASKET	PLEASURECRAFT RM0007	Use with Manifold: 18-1998-1. Included in 18-8538 mounting kit.
3	18-8216 HOSE FITTING	N/A	3/4" - 14NPT X 1" Hose (Corrosion Resistant Brass Fitting)
4	18-4461 HOSE FITTING	N/A	3/4" - 14NPT X 1" Hose (Corrosion Resistant Brass Fitting)
5	18-8215 HOSE FITTING	N/A	3/4" - 14NPT X 3/4" Hose (Corrosion Resistant Brass Fitting)
6	18-4364 MOUNTING KIT (OPEN GASKET)	BARR 20-0082-P	Use with Risers: 18-1999, 18-1907, & 18-1939. Includes 18-2854 elbow gasket.
7	18-8535 MOUNTING KIT (BLOCKED GASKET)	N/A	Use with Risers: 18-1939, 18-1999, 18-1907. Includes 18-0476 elbow gasket. (Use with a closed cooling system)
8	18-0603 EXHAUST MANIFOLD GASKET SET	N/A	Ford 302-351 CID Engines; Use with Manifold: 18-1998-1
9	18-8538 MOUNTING KIT	N/A	Use with Manifold: 18-1998-1. Includes 18-0183 manifold gasket.
10	18-4363 HARDWARE KIT	BARR FM-1-83-P	Hardware Only for Manifold: 18-1998-1
11	18-1907 ELBOW	BARR 20-0100 INDMAR 53-2009, INDMAR 53-2018	Use with Manifold: 18-1998-1; Riser Gasket: 18-2854 (open) or 18-0476 (blocked); Mounting Kit: 18-4364 (open) or 18-8535 (blocked)
12	18-1939 ELBOW	BARR 20-0100 MARINE POWER 0992-593	Use with Manifold: 18-1998-1; Riser Gasket: 18-2854 (open) or 18-0476 (blocked); Mounting Kit: 18-4364 (open) or 18-8535 (blocked)
13	NSS MOUNTING BOLT	N/A	Included in 18-4364 & 18-8535 mounting kits.
14	18-1999 MANIFOLD ELBOW	BARR 20-0082	Comes with 18-4364 (open) mounting package. If blocked mounting kit is required use 18-8535 mounting kit. Use with Manifold: 18-1998-1; Riser Gasket: 18-2854 (open) or 18-0476 (blocked)
15	18-4258 BLACKSTEEL PLUG	N/A	Thread Size: 3/4". Use with Manifold Spacer: 18-1949
16	18-1949 MANIFOLD SPACER	N/A	Use with Manifold: 18-1998-1
17	18-2854 ELBOW GASKET (OPEN)	BARR 01-0107	Used with Risers: 18-1939, 18-1999, 18-1907. Included in 18-4364 mounting kit.
18	18-0476 ELBOW GASKET(BLOCKED)	BARR 01-0105	Used with Risers: 18-1939, 18-1999, 18-1907. Included in 18-8535 mounting kit.

**MOST MANIFOLDS
ARE PAINTED, PACKAGED AND LEAK TESTED**



**18-1998-1
MANIFOLD**
Port & Starboard
Replaces: Barr FM-1-83
Universal Center Riser Manifold
FITS: Ford 302 and 351 CID engines
Comes with 18-4363 Mounting Package - Replaces: Barr FM 1-83-P
Use with:
Exhaust Manifold Gasket Set: 18-0603

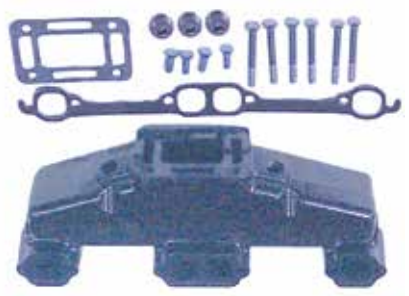

**18-1997-1
MANIFOLD**
Port & Starboard
Replaces: Barr CHV-1-83 Universal Center Riser Manifold
FITS: GM 283, 305, 307 and 350 CID engines
Use with:
Exhaust Manifold Gasket Set: 18-0604



**18-1999
ELBOW**
Replaces: Barr 20-0082
Comes with 18-4364 open Mounting Package -
Use with:
Manifold: 18-1997-1 or 18-1998-1 or 18-1898
Riser Gasket: 18-2854 open or 18-0476 blocked
Mounting Kit: 18-4364 open or 18-8535 blocked



**18-1898
MANIFOLD**
Port & Starboard
Replaces: Barr CHVA-1-84, Marine Power 0991-110
Fits 454 cu.in. GM big block V8 engines
Use with:
Exhaust Gasket: 18-0418
Riser Gasket: 18-2854 open or 18-0476 blocked



**18-1907
RISER**
Replaces: Barr 20-0100, Indmar 53-2009, 53-2018
Barr and Indmar Ford Small Block V8 302-351cu.in.
Use with:
Manifolds: 18-1997-1 or 18-1998-1
Riser Gasket: 18-2854 open or 18-0476 blocked
Mounting Kit: 18-4364 open or 18-8535 blocked



**18-1939
RISER**
Replaces: Barr 20-0100, Marine Power 0992-593
Barr, Indmar and Marine Power Ford Small Block V8
302-351cu. in. GM Small Block V8 305-350cu. in., GM
Big Block V8 454cu in.
Use with:
Manifold: 18-1997-1, 18-1998-1
Riser Gasket: 18-2854 open or 18-0476 blocked
Mounting Kit: 18-4364 open or 18-8535 blocked

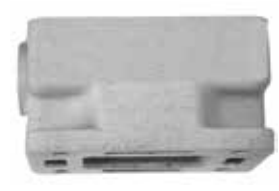

**18-1949
MANIFOLD SPACER**
Barr, Indmar and Marine Power Ford Small
Block V8 302-351cu.in., GM Small Block V8
305-350cu.in.,
GM Big Block V8 454cu.in.
Used with:
Manifolds: 18-1998-1, 18-1997-1 and
18-1898



**18-4363
EXHAUST ELBOW KIT**
Replaces: Barr FM-1-83-P
Use with:
Manifold: 18-1998-1



**18-4364 (Open)
EXHAUST ELBOW KIT**
Replaces:
Barr 20-0082-P
Use with:
Riser: 18-1999, 18-1907, 18-1939



18-8535 (Blocked)
EXHAUST MANIFOLD MOUNTING KIT
 Barr, Indmar and Marine Power
 Ford Small Block V8 302-351cu.in., GM
 Small Block V8 305-350cu.in., GM Big Block
 V8 454cu.in.
 Used with:
 Risers: 18-1939, 18-1999, and 18-1907



18-8536
EXHAUST ELBOW MOUNTING KIT
 Barr, Indmar and Marine Power GM Small
 Block V8 305-350cu.in.
 Used with:
 Manifold: 18-1997-1



18-8538
EXHAUST MANIFOLD MOUNTING KIT
 Barr and Indmar Ford Small Block V8
 302-351cu.in.
 Used with:
 Manifold: 18-1998-1



18-0603
**EXHAUST MANIFOLD
 GASKET SET**
 For: Ford 302/351 CID Engines
 For use with **18-1998-1**

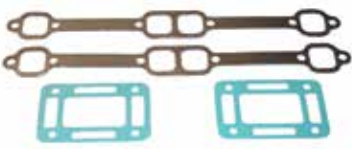

18-0604
**EXHAUST MANIFOLD
 GASKET SET**
 For: GM 305/350 CID Engines
 For use with **18-1997-1**



18-0183
EXHAUST MANIFOLD GASKET
 Replaces: Mercruiser 27-73866
 Volvo 3853742, 3852455, OMC 908717
 Used with:
 Manifold: 18-1962-1, 18-1938,
 18-1998-1, 18-1996, 18-1979



18-0418
**EXHAUST
 MANIFOLD GASKET**
 Replaces: Mercruiser 27-46820
 Use with :
 Manifolds: 18-1957-1, 18-1982,
 18-1929, 18-1933, 18-1898



18-0476
RISER BLOCKOFF GASKET
 Replaces: Barr 01-0105
 Indmar & Marine Power
 Ford Small Block V8 302-351cu.in.
 Used with:
 Risers: 18-1939, 18-1999, 18-1907



PKG. OF 2
18-2854 (Open)
18-2854-9^①
EXHAUST ELBOW GASKET
 Replaces: Barr 01-0107
 Use with :
 Riser: 18-1999, 18-1939, 18-1907



PKG. OF 2
18-2949
18-2949-9^①
EXHAUST MANIFOLD GASKET
 Replaces: Barr CHV-47-000
 Use with:
 Manifold: 18-1997-1



18-4461
HOSE BARB
 Replaces: Mercruiser 22-807155
 3/4" - 14 NPT x 1" Hose
 Corrosion Resistant Brass Fitting



18-4258
PIPE PLUG
 Replaces: Mercruiser 22-33198A1
 3/4" Thread size
 Blacksteel

^① Priced per Package

Sierra[®] High Performance

**18-5466
HI-PERFORMANCE
IGNITION COIL**

1.5 ohm (oil filled), black - 8 cylinder:
Flame-Thrower 40,000 volt coil.
★ Designed for use with the original
Ignitor Electronic Conversion Kits
★ Can be used with other inductive
ignition systems



**18-5469
HI-PERFORMANCE
IGNITION COIL**

3.0 ohm (oil filled), black - 4 & 6 cylinder:
Flame-Thrower 40,000 volt coil.
★ Designed for use with the original
Ignitor Electronic Conversion Kits
★ Can be used with other inductive
ignition systems



**18-5472
HI-PERFORMANCE
IGNITION COIL**

0.6 ohm (oil filled), black - 4, 6, & 8
cylinder: Flame-Thrower 45,000 volt coil.
★ Super low 0.6 ohm resistance coil
designed for use with the Ignitor II
Hi Performance Electronic
Conversion Kits
★ Compatible with capacitive
discharge systems



**18-8898
COIL**

High performance coil HV for Ignitor or points



**18-8899
COIL**

High performance coil HV for Ignitor II or Flamethrower



**18-5285
HI-PERFORMANCE
ELECTRONIC CONVERSION KIT**

Fits: 4 Cylinder Delco Distributors



**18-5286
HI-PERFORMANCE
ELECTRONIC CONVERSION KIT**

Fits: 6 Cylinder Delco Distributors



**18-5288
HI-PERFORMANCE
ELECTRONIC CONVERSION KIT**

Fits: Most Prestolite V-8 Distributors with snap down cap



**18-5289
HI-PERFORMANCE
ELECTRONIC CONVERSION KIT**

Fits: Most Prestolite Distributors with screw down cap



**18-5290
HI-PERFORMANCE
ELECTRONIC CONVERSION KIT**

Fits: Most Mallory YL or YD 8 cylinder Distributors
with clockwise and counter clockwise rotation



**18-5477
ELECTRONIC DISTRIBUTOR**

Fits: Ford 302 V-8 engines



**18-5478
ELECTRONIC DISTRIBUTOR**

Fits: Chrysler LA series V-8 engines



**18-5479
ELECTRONIC DISTRIBUTOR**

Fits: GM V-8 engines-reverse rotation



**18-5480
COMPLETE IGNITION
CONVERSION KIT**

Fits: GM SB & BB with Standard Deck Height



**18-5481
HI-PERFORMANCE
ELECTRONIC DISTRIBUTOR**

Fits: Ford V-8 351 Windsor
Replacement cap/rotor kit: 18-5266



Sierra® High Performance



18-5482
HI-PERFORMANCE
ELECTRONIC DISTRIBUTOR
Fits: Ford V-8 351 Cleveland, 351M, 400, 429 and 460 engines. Replacement cap/rotor kit: 18-5266



18-5483
HI-PERFORMANCE
ELECTRONIC DISTRIBUTOR
Fits: Chevrolet marine small and big block engines (standard deck height). Replacement cap/rotor kit: 18-5266



18-5473
DISTRIBUTOR CAP
Black Distributor Cap w/ Male Terminals
Petronix Distributors



18-5474
DISTRIBUTOR CAP
Red Distributor Cap with Male Terminals
Petronix Distributors



18-6834
STARTER
Replaces: GM Engines
Used on Buick, Chevrolet, Oldsmobile, and Pontiac Race Engines



18-7751
CARB KIT
Replaces: 13220
Fits: GM 420 V8 454 (1987-89), GM 425 V8 454 (1990-93), GM 425 (Gen V) V8 454 (1992-93), 440 TRS GM 454 (1983-86), GM 450 V8 454 (1995-96), 460 TRS V8 482 (1983-86), GM 465 V8 502 (1990-92), GM 465 (Gen V) V8 502 (1992-94), 500 (Gen+) GM 502 V8 (1999), 500 (Gen V) 502 V8 (1994-98), 500 Bulldog 540 V8 (1990-01)



18-7637
CARBURETOR
(REMANUFACTURED)
600 CFM Holley 4V



18-7638
CARBURETOR
(REMANUFACTURED)
600 CFM Holley 4V-side inlet



18-7775
FILTER BRACKET
3/8" Aluminum



18-7776
FILTER BRACKET
3/8" Stainless Steel



18-7232
FLAME ARRESTOR
Replaces: Crusader 33628, Mercuriser 57882, 57882T



18-7790
FUEL FILTER KIT
Complete Kit Contains: Housing, Replaceable Element & Fittings for 1/4", 5/16", & 3/8" Fuel Lines



18-7945C
FUEL WATER SEPARATER FILTER
(Chrome)
Replaces: Mercury - 35-802893Q
Yamaha - ABB-FUELF-IL-TR



18-7824C
OIL FILTER (Chrome)
Short GM
Replaces:
Chris-Craft: 16.81-08746
Crusader: 201104, Indmar: 50-1001
Mercuriser: 35-802885Q, 32716, 866340Q02, Q03, 866340K01,
Mercuriser Vazer, OMC: 173232, 502902
Pleasurecraft: R077002
Volvo-Penta: 835440
Yamaha: YSC-10231-20-0C
Thead Spec: 13/16" x 16NPT

Sierra® High Performance



**18-7866
FUEL FILTER**
Replaces: Yamaha MAR-FUELF-IL-TR
High Capacity - 6"
10 Micron

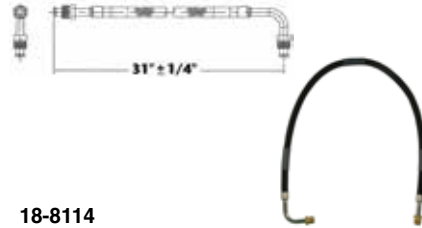

**18-8114
FUEL LINE HOSE**
For fuel pump to carburetor connection. Replaces copper or steel tubing 3/8" X 31" PTFE composite hose with 5/8"-18 male inverted flare straight one end, 5/8"-18 90° one end. SAE J1527 type A1

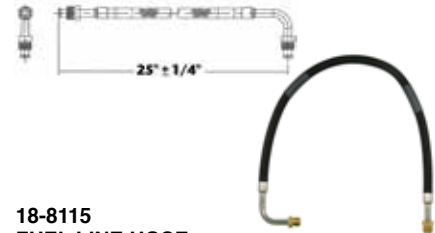

**18-8115
FUEL LINE HOSE**
For fuel pump to carburetor connection. Replaces copper or steel tubing 3/8" X 25" PTFE composite hose with 5/8"-18 male inverted flare straight one end, 5/8"-18 90° one end. SAE J1527 type A1



**18-7332
ELECTRIC FUEL PUMP**
Includes bracket and mounting hardware
43 GPH - 7 PSI Max. - 1/4 NPSF for 3/8 hose
- operates with both gasoline and diesel fuel - 24 Volt only



**18-7627
INTAKE MANIFOLD**
Small-block GM with vortec cylinder heads



**18-7628
INTAKE MANIFOLD**
Small-block GM with vortec cylinder heads
Brass lined water jackets for salt water applications



**18-7489
WEBER 750 CARBURETOR**

- Universal square flange mounting pattern
- High-luster polished exterior
- Electric choke
- Calibrated and flow-tested for mid to high range performance improvement and throttle response.



**18-1989
THERMOSTAT HOUSING**
Replaces: 87290A4, 861006A1
Stainless Steel
Use 18-1989K Thermostat Service Kit for replacement parts



**18-1989K
THERMOSTAT SERVICE KIT**
Service Kit for 18-1989 Thermostat Housing

CYLINDER HEADS High Performance

- Up to 60 HP increase over OE cylinder heads
- 185cc intake runner/ 62cc exhaust runner
- 72cc combustion chambers
- 2.02 intake/1.60 exhaust stainless steel valves
- 5 angle valve seat cut
- Double drilled intake mounting for either standard 12 bolt GM intake or late-model 8 bolt Vortec intake.
- Accepts both perimeter or center bolt valve covers
- Fits 5.7 & 6.2L small block GM V-8 applications.



18-4502

- Aluminum cylinder heads sold in pairs only
- Custom engraved with Sierra High-Performance logo
- Lightweight aluminum suitable for freshwater or closed cooling applications



18-4503

- Cast Iron cylinder heads sold in pairs only
- OE look
- Corrosion resistance heavy-duty cast iron castings suitable for saltwater usage

18-4504**CYLINDER HEAD**

- Aluminum cylinder heads sold in pairs only or 454 & 502 cu. In big-block GM applications.
- Custom engraved with Sierra High-Performance logo
- 320 cc intake runner/119cc exhaust runner
- 2.25 intake/1.88 exhaust stainless steel valves
- 5 angle valve seat cut
- Up to 65HP increase over OE cylinder heads
- Suitable for use on Mark IV, Gen V, & Gen VI GM blocks.
- Must use correct corresponding head gaskets
- Std. BBC 7/16" rocker studs and 3/8" diameter pushrod guideplates
- Rectangle intake ports
- Use on factory non-adjustable valvetrain applications require adjustable rocker arm assemblies such as Sierra's 18-4507
- Use Sierra 18-4506 guide plates to utilize factory 5/16" pushrods

**18-4506
GUIDE PLATES**

Big-Block GM with 5/16" pushrods

**18-4508
HEAD BOLT KIT**

High performance head bolt kit-small block GM

**18-4492****ROCKER ARM ASSEMBLY**

Replaces: MerCruiser 35329

Fits: MCM/MIE Gm V6 & V8(283, 305 & 350 cid) engines

**18-4507
ROCKER ARM KIT (4 VALVES)**

Big-Block GM

CYLINDER HEAD ASSEMBLIES

All cylinder heads are new castings and complete assemblies with new- stainless steel valves, hardened steel exhaust seats, valve springs, valve locks, and retainers.

All GM cylinder heads utilize high performance screw-in rocker arm studs in place of factory press in rocker arm studs.

**18-4484****CYLINDER HEAD ASSEMBLY**

Fits: 5.7L V-8 GM (1969-86) with 12 intake manifold mounting bolts, perimeter mount valve cover

**18-4485****CYLINDER HEAD ASSEMBLY**

Replaces: MerCruiser 938-883490 1

Fits: 5.7L V-8 GM (1987-95) with press in rocker arm studs with 12 intake manifold mounting bolts- (4 inside intake manifold bolts at 23 degrees), center mount valve covers

**18-4486****CYLINDER HEAD ASSEMBLY**

Replaces: MerCruiser 938-883297 1,938-803860T

Fits: 5.7L V-8 GM Vortec (1996-Up) with press in rocker arm studs with 8 intake manifold mounting bolts, composite valve cover

**18-4489****CYLINDER HEAD ASSEMBLY**

Replaces: MerCruiser 936-5544, 936-810840/986767

Fits: 2.5L/3.0L GM (1968-95) (non MerCruiser LX models) (1968-95)



18-4491
CYLINDER HEAD ASSEMBLY
 Replaces: MerCruiser 938-827178 1
 Replaces 4.3L Vortec V-6 (1996-Up) with screw in rocker arm studs (non-adjustable valve train), 8 intake manifold mounting bolts, center mount valve cover. NOTE: not for use with engines using factory roller rocker arms.



18-4495
CYLINDER HEAD ASSEMBLY
 Replaces: MerCruiser 949-4057, 949-5798, OMC 986086,988163,3854339, Volvo 3854339,3853894
 Fits: (1980& Up) 5.0L Ford with D-shape 58 cc combustion chamber



18-4501
CYLINDER HEAD
 Fits: 5.0L Vortec



18-4511
TIMING COVER
 GM 4.3L-composite with sensor port



18-4512
TIMING COVER
 GM 4.3L composite w/o sensor port



18-4513
TIMING COVER
 GM 5.0L/5.7L-composite with sensor port



18-4514
TIMING COVER
 GM 5.0L/5.7L-composite w/o sensor port



18-4516
RING GEAR-FLYWHEEL
 14" GM flywheel w/ 168 teeth



18-4517
RING GEAR-FLYWHEEL
 12" GM flywheel w/ 153 teeth



18-4518
FLYWHEEL
 14" 4.3L V-6, 1 piece main 1987 and up



18-4519
FLYWHEEL
 14" 5.0/5.7L, 1 piece main 1987 and UP



18-4521
FLYWHEEL
 14" small-block GM, 2 piece main, pre 1987



18-4522
FLYWHEEL
 14" 454, Gen IV w/ 2 piece rear main



18-4523
FLYWHEEL
 14" 454, Gen V & VI w/ 1 piece rear main



NEW

18-4726
VALVE SEAL
Fits: GM V-6 & V-8 engines



NEW

18-4727
VALVE SPRING
Fits: GM vortec style valve springs



NEW

18-4728
VALVE SPRING
Fits: GM standard style valve springs



NEW

18-4729
VALVE RETAINER, VORTEC
Fits: GM V-6 & V-8 engines



NEW

18-4730
VALVE RETAINER
Fits: GM V-6 & V-8 engines



NEW

18-4731
VALVE LOCK
Fits: GM V-6 & V-8 engines



NEW

18-4732
INTAKE VALVE (1.94")
Fits: GM V-6 & V-8 engines



NEW

18-4733
EXHAUST VALVE (1.50")
Fits: GM V-6 & V-8 engines



NEW

18-4734
INTAKE VALVE (1.84")
Fits: GM V-6 & V-8 engines



NEW

18-4735
INTAKE VALVE (2.02")
Fits: GM V-6 & V-8 engines



NEW

18-4736
EXHAUST VALVE (1.60")
Fits: GM V-6 & V-8 engines



NEW

18-4737
ROCKER ARM STUD
Fits: GM V-6 & V-8 engines

Easy to use Modular Gasket Kits for Ford & Chevrolet Marine Engines

- For most popular marine versions of: Chevrolet In-line 4 & 6 cylinder V6 & V8 Engines and Ford 5.0 L & 5.8L V8 Engines
- Minimizes inventory investment to cover most major engine applications
- Maximizes inventory utilizations via mix and match system
- Utilizes generic type gasket kits common among all engine brands., (i.e. a 350CID (5.7L) Crusader & Mercruiser would use the same short block & valve grind gasket sets, but would use different exhaust manifold gasket kits)

CHEVY 4 cyl. 153/2.5L 1965-88 ③

CHEVY 4 cyl. 181/3.0L 1973-84 ③

CHEVY 4 cyl. 181/3.0L 1985-89 (4 cyl. 181/3.0L HO 1990-98 ③)

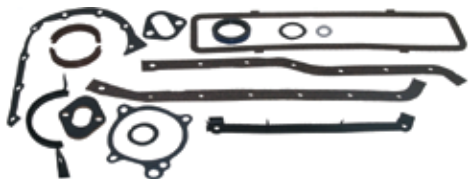

**18-1271 ① ③
SHORT BLOCK
GASKET SET**

— CONTAINS —

Description	Part #
Oil Pan Gasket	18-0466
Forward Crankshaft Seals	18-1213
Rear Crankshaft Seals	18-1211
Push Rod Cover	18-0328
Water Pump Gasket	18-0327
Fuel Pump Mounting Gasket	18-0889
Fuel Pump Mounting Gasket	NSS
Cam Gear Cover Gasket	18-0887
Distributor Mounting Gasket	18-0948
Distributor Mounting Gasket	18-0874

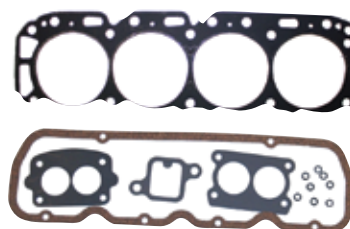

**18-1274
HEAD GASKET SET**

— CONTAINS —

Description	Part #
Head Gasket	18-2946
Mercarb Mounting Gasket	18-0994
Carb. Mounting Gasket	18-0356
Thermostat Housing Gasket	18-0164
Valve Cover Gasket	18-0347
Valve Stem Seals (8)	18-0518

4 cyl. 3.7L Mercruiser 470

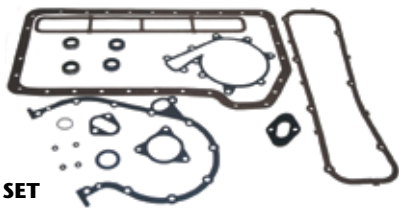

**18-1276
SHORT BLOCK GASKET SET**

— CONTAINS —

Description	Part #
Oil Seal	18-2014
Mounting Gasket	NSS
Distributor Mounting Gasket	18-0874
Fuel Pump Mounting Gasket	18-0889
O-Ring	NSS
Water Pump Seal	18-0172
O-Ring	18-7145
Oil Pan Gasket	18-4366
Water Pump Timer Cover Gasket	NSS

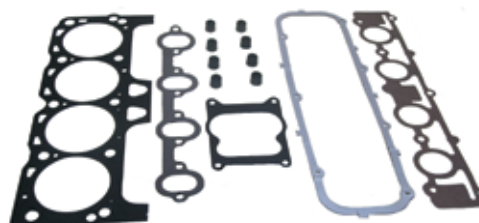

**18-1277
HEAD GASKET SET**

— CONTAINS —

Description	Part #
Intake Gasket	18-0158
Quadrajets Gasket	18-2848
Valve Grind Cover Gasket	NSS
Head Gasket	18-3878
Exhaust Manifold Mounting Gasket	18-0956
Valve Seal	NSS

CHEVY V-6 250/4.1L



**18-1255
SHORT BLOCK GASKET SET
(24 Bolt Pan Only)**

— CONTAINS —

Description	Part #
Oil Pan Gasket	18-0340
Forward Crankshaft Seals	18-1213
Rear Crankshaft Seals	18-1211
Push Rod Cover	18-0329
Water Pump Gasket	18-0327
Fuel Pump Mounting Gasket	18-0889
Timing Gear Cover Gasket	18-0887
Distributor Mounting Gasket	18-0874

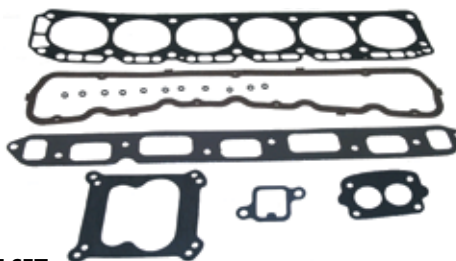

**18-1264
HEAD GASKET SET**

— CONTAINS —

Description	Part #
Head Gasket	18-3881
4BBL Carb Mounting Gasket	NSS
2BBL Carb Mounting Gasket	18-0356
Exhaust Manifold Gasket	18-2830
T-Stat Hsg. Mounting Gasket	18-0164
Valve Cover Gasket	18-0346
Valve Stem Seals (8)	18-0518

① Except models with cast push rod cover

② Does not include intake and/or exhaust manifold gaskets

③ For models with 1 piece rear main seal use 18-1206

NSS Not Sold Separately

CHEVY V-6 229/3.8L AND 4.3L



**18-1270 *
SHORT BLOCK
GASKET SET**

— CONTAINS —

Description	Part #
Oil Pan Gasket	18-0405
Oil Drain Screw Gasket	18-0905
Forward Crankshaft Seal	18-1213
Rear Crankshaft Seal	18-0519
Crankshaft Seal Retainer	18-0322
Water Pump Mounting Gasket	18-0891
Fuel Pump Plate Gasket	NSS
Fuel Pump Mounting Gasket	18-0889
Timing Chain Cover Gasket	18-0976
Timing Chain Cover Gasket	NSS

* Requires Rear Crankshaft Seal
(Not Included) in addition to short block kit

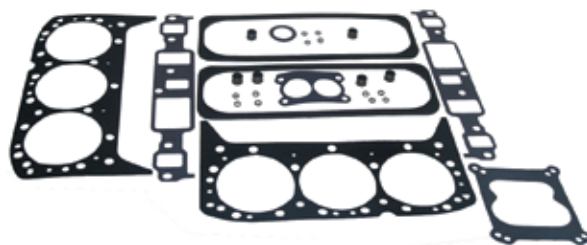

**18-1275 ①
HEAD GASKET SET**

— CONTAINS —

Description	Part #
Head Gasket	18-3879
2BBL Carb Mounting Gasket	18-0994
4BBL Carb Mounting Gasket	18-0463
Intake Manifold Gasket	18-4408
Valve Cover Gasket	18-0311
Valve Stem Seals (6)	18-4024
Valve Stem Seals (12)	18-0518
Distributor Mounting Gasket	18-0874

**CHEVY V-6 262/4.3L — 1 Piece Rear Seal
CHEVY V-6 262/4.3L GEN II — 1 Piece Rear Seal**



**18-1270
SHORT BLOCK
GASKET SET**

— CONTAINS —

Description	Part #
Oil Pan Gasket	18-0405
Oil Drain Screw Gasket	18-0905
Forward Crankshaft Seal	18-1213
Rear Crankshaft Seal	18-0519
Crankshaft Seal Retainer	18-0322
Water Pump Mounting Gasket	18-0891
Fuel Pump Plate Gasket	NSS
Fuel Pump Mounting Gasket	18-0889
Timing Chain Cover Gasket	18-0976
Timing Chain Cover Gasket	NSS

* Requires Rear Crankshaft Seal
(Not Included) in addition to short block kit



**18-1278
HEAD GASKET SET**

— CONTAINS —

Description	Part #
Head Gasket	18-3879
2BBL Carb Mounting Gasket	18-0994
4BBL Carb Mounting Gasket	18-0463
Valve Stem Seals (6)	18-4024
Valve Stem Seals (12)	18-0518
Distributor Mounting Gasket	18-0874
Intake Gasket Set	18-1238
Valve Cover Gasket (2)	18-0311

**CHEVY V-8 305/5.0L
2 Piece Rear Seal**



**18-1265
SHORT BLOCK GASKET SET
Port Dip Stick Models ONLY
Left Hand (Standard Rotation)**

— CONTAINS —

Description	Part #
Oil Pan Gasket	18-0153
Oil Drain Screw Gasket	18-0905
Oil Filter Gasket	18-0185
Forward Crankshaft Seal	18-1213
Rear Crankshaft Seal	18-1211
Water Pump Mounting Gasket	18-0891
Water Pump Plate Gasket	NSS
Fuel Pump Plate Gasket	18-0876
Fuel Pump Mounting Gasket	18-0889
Timing Chain Cover Gasket	18-0976
Vent Adapter Gasket	NSS

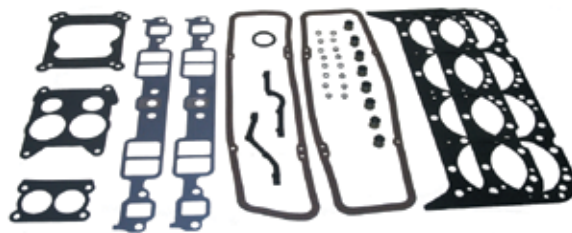

**18-1266 ②
HEAD GASKET SET**

— CONTAINS —

Description	Part #
Head Gasket	18-3876
2BBL Carb Mounting Gasket	18-0994
4BBL Carb Mounting Gasket	18-0463
4BBL Carb Mounting Gasket	18-0462
Intake Manifold Gasket	18-0868
Valve Cover Gasket (2)	18-2845
Valve Stem Seals (8)	18-4024
Valve Stem Seals (16)	18-0518
Distributor Mounting Gasket	18-0874

① Does not include oil pan gasket

② Does not include intake and/or exhaust manifold gaskets

NSS Not Sold Separately

**CHEVY V-8 305/5.0L (Right Hand Rotation)
2 Piece Rear Seal**

**18-1266 ②
HEAD GASKET SET
— CONTAINS —**

Description	Part #
Head Gasket	18-3876
2BBL Carb Mounting Gasket	18-0994
4BBL Carb Mounting Gasket	18-0463
4BBL Carb Mounting Gasket	18-0462
Intake Manifold Gasket	18-0868
Valve Cover Gasket (2)	18-2845
Valve Stem Seals (8)	18-4024
Valve Stem Seals (16)	18-0518
Distributor Mounting Gasket	18-0874

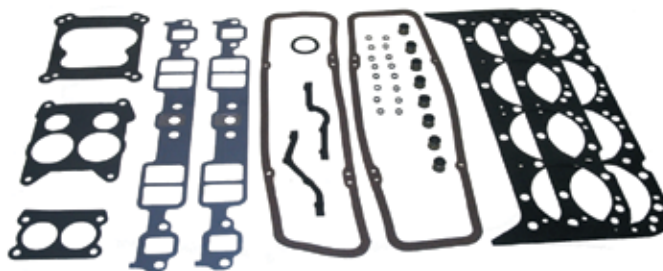

**CHEVY V-8 305/5.0L GEN II
1 Piece Rear Seal**

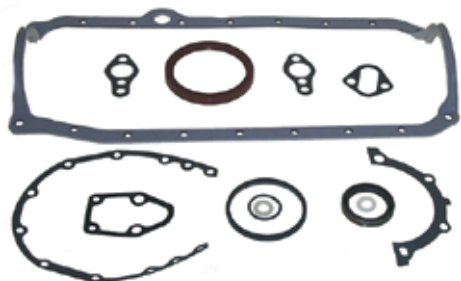

**18-1268
SHORT BLOCK GASKET SET
— CONTAINS —**

Description	Part #
Oil Pan Gasket	18-1237
Oil Drain Screw Gasket	18-0905
Oil Filter Gasket	18-0185
Forward Crankshaft Seal	18-1213
Rear Crankshaft Seal	18-0519
Rear Main Bearing Gasket	18-0322
Water Pump Mounting Gasket	18-0891
Water Pump Plate Gasket	NSS
Fuel Pump Plate Gasket	18-0976
Fuel Pump Mounting Gasket	18-0889

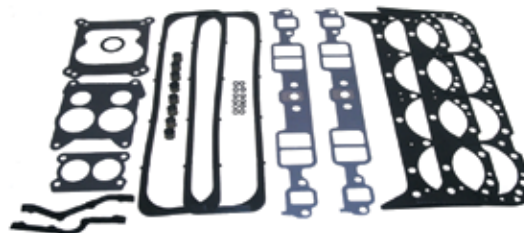

**18-1267 ②
HEAD GASKET SET
— CONTAINS —**

Description	Part #
Head Gasket	18-3876
2BBL Carb Mounting Gasket	18-0994
4BBL Carb Mounting Gasket	18-0463
4BBL Carb Mounting Gasket	18-0462
Intake Manifold Gasket Set	18-0868
Valve Cover Gasket (2)	18-0664
Valve Stem Seals (8)	18-4024
Valve Stem Seals (16)	18-0518
Distributor Mounting Gasket	18-0874

**CHEVY V-8 305/5.0L GEN II (Right Hand Rotation)
1 Piece Rear Seal**



**18-1263 ①
SHORT BLOCK GASKET SET
— CONTAINS —**

Description	Part #
Oil Drain Screw Gasket	18-0905
Oil Filter Gasket	18-0185
Forward Crankshaft Seal	18-1213
Rear Main Bearing Gasket	18-0322
Water Pump Mounting Gasket	18-0891
Water Pump Backing Plate Gasket	18-0893
Water Pump Plate Gasket	NSS
Fuel Pump Plate Gasket	18-0876
Fuel Pump Mounting Gasket	18-0889
Timing Chain Cover Gasket	18-0976

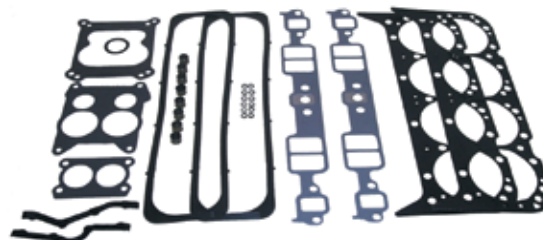

**18-1267 ②
HEAD GASKET SET
— CONTAINS —**

Description	Part #
Head Gasket	18-3876
2BBL Carb Mounting Gasket	18-0994
4BBL Carb Mounting Gasket	18-0463
4BBL Carb Mounting Gasket	18-0462
Intake Manifold Gasket Set	18-0868
Valve Cover Gasket (2)	18-0664
Valve Stem Seals (8)	18-4024
Valve Stem Seals (16)	18-0518
Distributor Mounting Gasket	18-0874

① Does not include oil pan gasket

② Does not include intake and/or exhaust manifold gaskets

NSS Not Sold Separately

CHEVY V-8 350/5.7L

2 Piece Rear Seal



**18-1265
SHORT BLOCK GASKET SET
Port Dip Stick Models ONLY
Left Hand (Standard Rotation)
— CONTAINS —**

Description	Part #
Oil Pan Gasket	18-0153
Oil Drain Screw Gasket	18-0905
Oil Filter Gasket	18-0185
Forward Crankshaft Seal	18-1213
Rear Crankshaft Seal	18-1211
Water Pump Mounting Gasket	18-0891
Water Pump Plate Gasket	NSS
Fuel Pump Plate Gasket	18-0876
Fuel Pump Mounting Gasket	18-0889
Timing Chain Cover Gasket	18-0976
Vent Adapter Gasket	NSS

* Except Stbd Dip Stick models

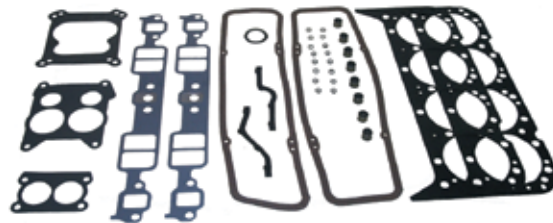

**18-1266 ②
HEAD GASKET SET
— CONTAINS —**

Description	Part #
Head Gasket	18-3876
2BBL Carb Mounting Gasket	18-0994
4BBL Carb Mounting Gasket	18-0463
4BBL Carb Mounting Gasket	18-0462
Intake Manifold Gasket	18-0868
Valve Cover Gasket (2)	18-2845
Valve Stem Seals (8)	18-4024
Valve Stem Seals (16)	18-0518
Distributor Mounting Gasket	18-0874

CHEVY V-8 350/5.7L (Right Hand Rotation)

2 Piece Rear Seal

**18-1266 ②
HEAD GASKET SET
— CONTAINS —**

Description	Part #
Head Gasket	18-3876
2BBL Carb Mounting Gasket	18-0994
4BBL Carb Mounting Gasket	18-0463
4BBL Carb Mounting Gasket	18-0462
Intake Manifold Gasket	18-0868
Valve Cover Gasket (2)	18-2845
Valve Stem Seals (8)	18-4024
Valve Stem Seals (16)	18-0518
Distributor Mounting Gasket	18-0874

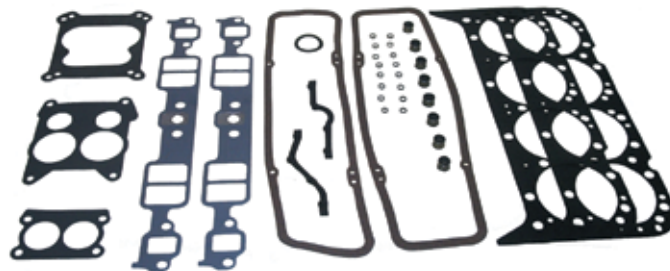

CHEVY V-8 350/5.7L GEN II

1 Piece Rear Seal

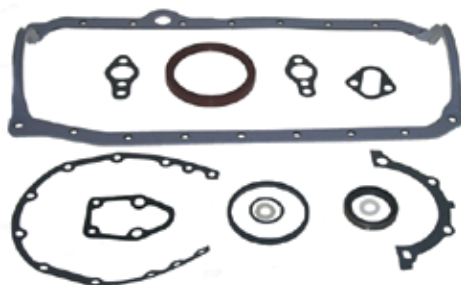

**18-1268
SHORT BLOCK GASKET SET
— CONTAINS —**

Description	Part #
Oil Pan Gasket	18-1237
Oil Drain Screw Gasket	18-0905
Oil Filter Gasket	18-0185
Forward Crankshaft Seal	18-1213
Rear Crankshaft Seal	18-0519
Rear Main Bearing Gasket	18-0322
Water Pump Mounting Gasket	18-0891
Water Pump Plate Gasket	NSS
Fuel Pump Plate Gasket	18-0976
Fuel Pump Mounting Gasket	18-0889
Timing Chain Cover Gasket	18-0468



**18-1267 ②
HEAD GASKET SET
— CONTAINS —**

Description	Part #
Head Gasket	18-3876
2BBL Carb Mounting Gasket	18-0994
4BBL Carb Mounting Gasket	18-0463
4BBL Carb Mounting Gasket	18-0462
Intake Manifold Gasket Set	18-0868
Valve Cover Gasket (2)	18-0664
Valve Stem Seals (8)	18-4024
Valve Stem Seals (16)	18-0518
Distributor Mounting Gasket	18-0874

① Does not include oil pan gasket

② Does not include intake and/or exhaust manifold gaskets

NSS Not Sold Separately

**CHEVY V-8 350/5.7L GEN II (Right Hand Rotation)
1 Piece Rear Seal**



**18-1263 ①
SHORT BLOCK GASKET SET
— CONTAINS —**

Description	Part #
Oil Drain Screw Gasket	18-0905
Oil Filter Gasket	18-0185
Forward Crankshaft Seal	18-1213
Rear Main Bearing Gasket	18-0322
Water Pump Mounting Gasket	18-0891
Water Pump Plate Gasket	NSS
Fuel Pump Plate Gasket	18-0876
Fuel Pump Mounting Gasket	18-0889
Timing Chain Cover Gasket	18-0468

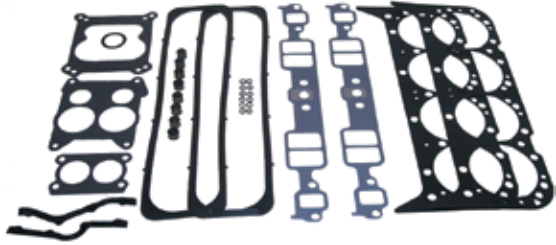

**18-1267 ②
HEAD GASKET SET
— CONTAINS —**

Description	Part #
Head Gasket	18-3876
2BBL Carb Mounting Gasket	18-0994
4BBL Carb Mounting Gasket	18-0463
4BBL Carb Mounting Gasket	18-0462
Intake Manifold Gasket Set	18-0868
Valve Cover Gasket (2)	18-0664
Valve Stem Seals (8)	18-4024
Valve Stem Seals (16)	18-0518
Distributor Mounting Gasket	18-0874

CHEVY V-8 454/7.4L

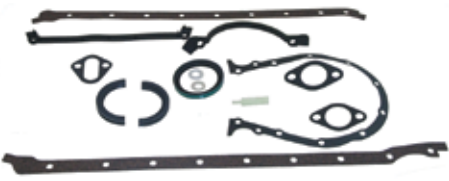

**18-1256 *
SHORT BLOCK GASKET SET
— CONTAINS —**

Description	Part #
Oil Pan Gasket	18-0348
Oil Drain Screw Gasket	18-0905
Forward Crankshaft Seal	18-1233
Rear Crankshaft Seal	18-0520
Water Pump Mounting Gasket	18-0903
Fuel Pump Mounting Gasket	18-0889
Timing Cover Gasket	18-0980

* Right Hand Rotation Engines Require



**18-1257 ②
VALUE GRIND GASKET SET
— CONTAINS —**

Description	Part #
Head Gasket	18-3877
Carb Mounting Gasket	NSS
Carb Mounting Gasket	NSS
Carb Mounting Gasket	NSS
Intake Manifold Gasket Set	NSS
Valve Cover Gasket (2)	NSS
Valve Stem Seals (16)	NSS
Distributor Mounting Gasket	18-0874

CHEVY V-8 454/7.4L w/Square Ports

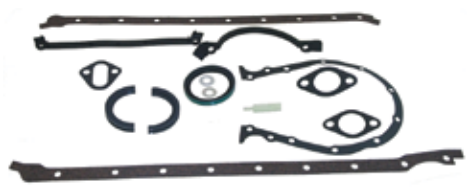

**18-1256 *
SHORT BLOCK GASKET SET
— CONTAINS —**

Description	Part #
Oil Pan Gasket	18-0348
Oil Drain Screw Gasket	18-0905
Forward Crankshaft Seal	18-1233
Rear Crankshaft Seal	18-0520
Water Pump Mounting Gasket	18-0903
Fuel Pump Mounting Gasket	18-0889
Timing Cover Gasket	18-0980

* Right Hand Rotation Engines Require

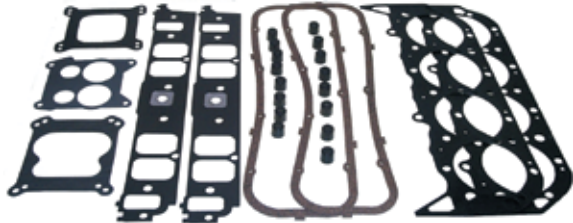

**18-1259 ②
HEAD GASKET SET
— CONTAINS —**

Description	Part #
Head Gasket	18-3877
Carb Mounting Gasket	18-0467
Carb Mounting Gasket	18-0463
Carb Mounting Gasket	18-0462
Intake Manifold Gasket Set	18-1231
Valve Cover Gasket (2)	18-0464
Valve Stem Seals (16)	18-4024
Distributor Mounting Gasket	18-0874

① Does not include oil pan gasket ② Does not include intake and/or exhaust manifold gaskets NSS Not Sold Separately

CHEVY V-8 454/7.4L GEN V
CHEVY V-8 454/7.4L GEN V (w/square ports)

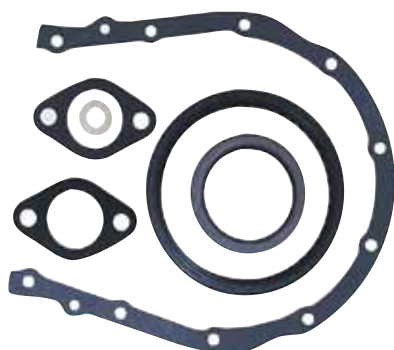

18-1261 ①
TIMING CHAIN GASKET SET
 — CONTAINS —

Description	Part #
Oil Drain Screw Gasket	18-0905
Forward Crankshaft Seals	18-1233
Rear Crankshaft Seals	18-1234
Water Pump Mounting Gasket	18-0903
Timing Cover Gasket	18-0468



18-1258 ②
VALVE GRIND GASKET SET
 — CONTAINS —

Description	Part #
Head Gasket	18-3887
Carb Mounting Gasket	18-0467
Carb Mounting Gasket	18-0463
Carb Mounting Gasket	18-0462
Intake Manifold Gasket Set	NSS
Valve Stem Seals (16)	NSS
Distributor Mounting Gasket	18-0874

CHEVY V-8 502/8.2L

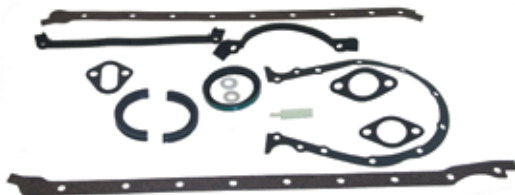

18-1256 *
SHORT BLOCK GASKET SET
 — CONTAINS —

Description	Part #
Oil Pan Gasket	18-0348
Oil Drain Screw Gasket	18-0905
Forward Crankshaft Seal	18-1233
Rear Crankshaft Seal	18-0520
Water Pump Mounting Gasket	18-0903
Fuel Pump Mounting Gasket	18-0889
Timing Cover Gasket	18-0980

* Right Hand Rotation Engines Require



18-1259 ②
HEAD GASKET SET
 — CONTAINS —

Description	Part #
Head Gasket	18-3873
Carb Mounting Gasket	18-0467
Carb Mounting Gasket	18-0463
Carb Mounting Gasket	18-0462
Intake Manifold Gasket Set	18-1231
Valve Cover Gasket (2)	18-0464
Valve Stem Seals (16)	18-4024
Distributor Mounting Gasket	18-0874

CHEVY V-8 502/8.2L GEN V

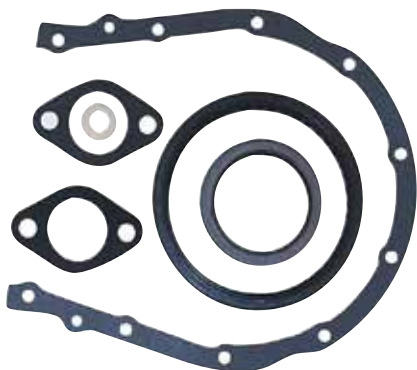

18-1261 ①
TIMING CHAIN GASKET SET
 — CONTAINS —

Description	Part #
Oil Drain Screw Gasket	18-0905
Forward Crankshaft Seals	18-1233
Rear Crankshaft Seals	18-1234
Water Pump Mounting Gasket	18-0903
Timing Cover Gasket	18-0468



18-1258 ②
VALVE GRIND GASKET SET
 — CONTAINS —

Description	Part #
Head Gasket	18-3874
Carb Mounting Gasket	18-0467
Carb Mounting Gasket	18-0463
Carb Mounting Gasket	18-0462
Intake Manifold Gasket Set	NSS
Valve Stem Seals (16)	NSS
Distributor Mounting Gasket	18-0874

① Does not include oil pan gasket ② Does not include intake and/or exhaust manifold gaskets NSS Not Sold Separately

FORD V-8 302/5.0L 1977-93

18-1273 ②
HEAD GASKET SET
— CONTAINS —

Description	Part #
Head Gasket (2)	18-3883
4BBL Carb Mounting Gasket	18-0357
2BBL Carb Mounting Gasket	18-0360
Intake Manifold Gasket Set	18-0410
Valve Cover Gasket (2)	18-0352
Valve Stem Seals (16)	18-4023

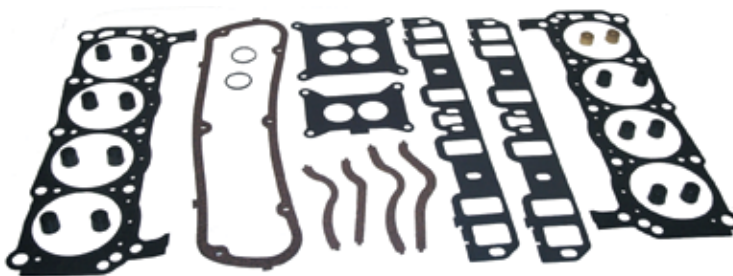

FORD V-8 351/5.8L 1977-93

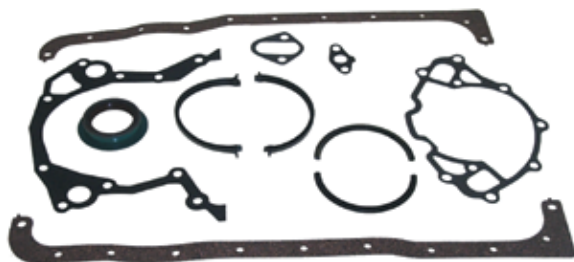

18-1269
SHORT BLOCK GASKET SET
Left Hand (Standard Rotation)
— CONTAINS —

Description	Part #
Oil Pan Gasket	18-0611
Forward Crankshaft Seal	18-1230
Water Pump Mounting Gasket	NSS
Fuel Pump Mounting Gasket	18-0889
Timing Chain Cover Gasket	NSS
Oil Pump Screen Gasket	NSS

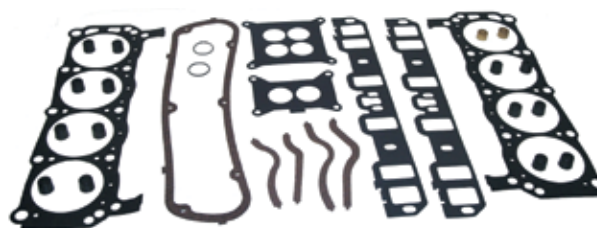

18-1273 ②
HEAD GASKET SET
— CONTAINS —

Description	Part #
Head Gasket (2)	18-3883
4BBL Carb Mounting Gasket	18-0357
2BBL Carb Mounting Gasket	18-0360
Intake Manifold Gasket Set	18-0410
Valve Cover Gasket (2)	18-0352
Valve Stem Seals (16)	18-4023

① Does not include oil pan gasket ② Does not include intake and/or exhaust manifold gaskets NSS Not Sold Separately

MODULAR GASKET APPLICATION

Engine/Model	Years	Serial No.	Short Block	Valve Grind Kit
Chevy 153-2.5L	1965-85	3377341-6229717 ⑤ ②	18-1271	18-1274
Chevy 153/2.5L	1986-88	6229718 & Up ⑤ ②	18-1271	18-1274
Chevy 181/3.0L	1973-84	3332137-6229717 ⑤ ② ⑥	18-1271	18-1274
Chevy 181/3.0L	1985-96	6229718 & Later ⑤ ② ⑥	N/A	18-1274
Chevy 181/3.0LX	1990-97	C856559 & Later ① ⑤ ②	N/A	18-1274
Mercury 165/ 3.7L (4 Cyl.)	1987-89	6916779 & Later ⑦ ③	18-1276	18-1277
Mercury 170 (4 Cyl.)	1985-86	6916779 & Later ③	18-1276	18-1277
Mercury 180/ 3.7L-LX (4 Cyl.)	1987-89	6916779 & Later ③	18-1276	18-1277
Mercury 190 (4 Cyl.)	1985-86	6916779 & Later ③	18-1276	18-1277
Mercury 470	1976-82	4208730-6218036 ③	18-1276	18-1277
Mercury 470	1983-84	6218037-6916778 ③	18-1276	18-1277
Mercury 485	1980-82	5685394-6218036 ③	18-1276	18-1277
Mercury 488	1983-84	6170297-6916778 ③	18-1276	18-1277

- ① Full circle rear crankshaft seal, one piece oil pan gasket
- ② 3.8L models require 18-1211 rear crank seal and 18-0362 oil pan gasket
- ③ Starboard dip stick models require 18-0411 oil pan gasket set
- ④ Four piece oil pan set
- ⑤ Head & valve cover gaskets included in valve grind kit
- ⑥ Intake/exhaust manifold gasket included in kit
- ⑦ Rear main crankshaft seal also required
- ⑧ Crankshaft seals also required
- ⑨ Models with cast push rod cover require 18-0328
- ⑩ Crankshaft seals not included in short block kit
- ⑪ Use 18-4349 for serial no.6218462-B525981
- ⑫ For models with one piece rear main seal use 18-1206 kit

MODULAR GASKET APPLICATION

Engine/Model	Years	Serial No.	Short Block	Valve Grind Kit
Chevy 229/3.8L	1983-84	6330183-6919655 ② ⑤	18-1270	18-1275
Chevy L6 250/4.1L	1970-81	2770032-5813433 ⑤	18-1255	18-1264
Chevy 262/4.3L (2Pc. Rm Seal)	1985	6919656-B455459 ⑤	N/A	18-1275
Chevy 262/4.3L (2Pc. Rm Seal)	1986-92	A483581 ① ⑤	18-1270	18-1275
Chevy 262/4.3L Gen II	1992	D714370-F802999 ① ⑤	18-1270	18-1278
Chevy 262/4.3L Gen II	1993-96	D714370-F802999 ① ⑤	18-1270	18-1278
Chevy 305/5.0L	1977-85	4762210-B525981 ③ ⑤	18-1265	18-1266
Chevy 305/5.0L (Rev. Rota.)	1977-85	4762210-B525981 ③ ⑤	—	18-1266
Chevy 305/5.0L (1 Pc. Rm Seal)	1986	A482027-B525981 ① ⑤	18-1258	18-1266
Chevy 305/5.0L (Rev. Rota.) (1 Pc. Rm Seal)	1986	A482027-B525981 ① ⑤	18-1263	18-1266
Chevy 305/5.0L	1987-95	B525982 & Later ① ⑤ ⑥	18-1268	18-1267
Chevy 305/5.0L Inboard	1987-95	B522506 & Later ① ⑤ ⑧	18-1268	18-1267
Chevy 305/5.0L (Rev.Rota) Inboard	1987-95	B522506 & Later ① ⑤	18-1263	18-1267
Chevy 350/5.7L	1975-86	4175500-B525982 ③ ⑤ ④	18-1265	18-1266
Chevy 350/5.7 Inboard	1975-86	4498701-B522506 ③ ⑤	18-1265	18-1266
Chevy 350/5.7 (Rev.Rota) Inboard	1975-86	4498701-B522506 ③ ⑤	—	18-1266
Chevy 350/5.7L (1Pc. Rm Seal)	1986	6218462-B522506 ① ⑤	18-1268	18-1266
Chevy 350/5.7L (1Pc. Rm Seal) Inboard	1986	A492879-B522506 ① ⑤	18-1268	18-1266
Chevy 350/5.7L (Rev.Rota) (1 Pc. Rm Seal)	1986	A492879-B522506 ① ⑤	18-1263	18-1266
Chevy 350/5.7L	1987-95	B525982 & Later ① ⑤ ⑧	18-1268	18-1267
Chevy 350/5.7L	1996-97	B525982 & Later ① ⑤ ⑧	18-1268	18-1267
Chevy 350/5.7L Inboard	1987-95	B522506 & Later ① ⑤	18-1263	18-1267
Chevy 350/5.7L Inboard	1996-97	B522506 & Later ① ⑤	18-1263	18-1267
Chevy 350/5.7L (Rev.Rota.) Inboard	1987-95	B522506 & Later ① ⑤	18-1263	18-1267
Chevy 350/5.7L (Rev. Rota.) Inboard	1996-97	B522506 & Later ① ⑤	18-1263	18-1267
Chevy 454/7.4L	1977-92	4623115-D937001 ⑤	18-1256	18-1257
Chevy 454/7.4L Inboard	1977-92	4623110 & Later ⑤ 18-1256	18-1257	
Chevy 454/7.4L (Rev.Rota.) Inboard	1977-92	4623110 & Later ⑤ ⑧	18-1256	18-1257
Chevy 454/7.4L (Sq. Ports)	1988-91	B721206-D805068 ⑤	18-1256	18-1259
Chevy 454/7.4L Gen V	1992-94	D603118 & Later ⑤ 18-1261	18-1258	
Chevy 454/7.4L Gen V	1995-97	D603118 & Later ⑤ 18-1261	18-1258	
Chevy 454/7.4L Gen V Inboard	1992-94	D715494 & Later ⑤ 18-1261	18-1258	
Chevy 454/7.4L Gen V Inboard	1995-97	D715494 & Later ⑤ 18-1261	18-1258	
Chevy 454/7.4L Gen V (Sq. Ports)	1992-94	D805069 & Later ⑤ 18-1261	—	
Chevy 454/7.4L Gen V (Sq. Ports)	1995-97	D805069 & Later ⑤ 18-1261	—	
Chevy 502/8.2L	1990-92	C84992-F213244 ⑤ 18-1256	18-1259	
Chevy 502/8.2L Inboard	1990-92	C878221-D857199 ⑤	18-1256	18-1259
Chevy 502/8.2L Gen V	1993-97	D824589 & Later ⑤ 18-1261	—	
Chevy 502/8.2L Gen V Inboard	1993-97	D857200 & Later ⑤ 18-1261	—	
Ford 302/5.0L	1971-77	3108723-4887829 ④ ⑤	—	18-1273
Ford 351/5.8L	1975-77	4173000-4902304 ④ ⑤	18-1269	18-1273
Ford 351/5.8L (Rev. Rota.)	1975-77	4173000-4902304 ④ ⑤ ①	18-1269	18-1273

① Full circle rear crankshaft seal, one piece oil pan gasket

② 3.8L models require 18-1211 rear crank seal and 18-0362 oil pan gasket

③ Starboard dip stick models require 18-0411 oil pan gasket set

④ Four piece oil pan set

⑤ Head & valve cover gaskets included in valve grind kit

⑦ Intake/exhaust manifold gasket included in kit

⑧ Rear main crankshaft seal also required

① Crankshaft seals also required

② Models with cast push rod cover require 18-0328

③ Crankshaft seals not included in short block kit

④ Use 18-4349 for serial no.6218462-B525981

⑤ For models with one piece rear main seal use 18-1206 kit



**18-5982
ALTERNATOR**
Replaces: Cummins 216040, 3604234RX
Fits: Cummins Diesel Marine



**18-6846
ALTERNATOR**
Replaces: Volvo Penta 1502272, 3803270-2, 5001677, 845940, 72021, 872022, 872757, 873635, 873757, 873757-9, 873771,



**18-6849
ALTERNATOR**
Replaces: Yanmar 119773-77200, Denso 101211-9940
Fits: Yanmar Engines



**18-6925
ALTERNATOR**
Replaces: Yanmar 128270-77200 Hitachi LR135-105
Fits: Yanmar Marine 3GM Engines



**18-6926
ALTERNATOR**
Replaces: Yanmar 119836-77200, -2, -3, 129612-77230
Fits: 3TNE84 3cyl diesel, 3TNE88 3cyl diesel, 4TNE84 4cyl, 1.995L, 4TNE88 4cyl, 2.190L



**18-6927
ALTERNATOR**
Replaces: Yanmar 119573-77200, 119573-77201, 129470-77200
Yanmar LH Engines



**18-6928
ALTERNATOR**
Replaces: Yanmar 128170-77200, 77201, 77202, Hitachi LR135-74, 74B
Fits: 3HM, 3HMF models



**18-6929
ALTERNATOR**
Replaces: Yanmar 119573-77200, 77201, 129470-77200, Hitachi LR180-03A, B, C
Fits: Yanmar LH Engines



**18-6952
ALTERNATOR**
Replaces: Cummins 214169, 3603853RX, 3920618, 10459244, Delco 1100077, 93, 1100211, 74, 1105474, 75, 76



**18-6953
ALTERNATOR**
Replaces: Volvo 3803645, 8602629, 8602710, 14 8676496, 98, 8676499
Fits: Diesel D3 Models



**18-6955
ALTERNATOR**
Replaces: Caterpillar 3001117, 10-258, Prestolite 110-258, 110-258A, Volvo 849748-9
Fits: Volvo Diesel 6 cylinder models



**18-6870
STARTER**
Replaces: Mercury 50-805833, T
Fits: D7.3L D-tronic 260 LD, 300 1999 year



**18-6872
STARTER**
Replaces: Volvo 233991, 240501, 837924, 842775, 843511, 847306-8, 881681
Fits: TAMD, MD, AQD Models



**18-6880
STARTER**
Replaces: Yanmar 129573-77010, 171008-77010, Hitachi S114-257, 257G, 483, 483A



**18-6930
STARTER**
Replaces: Yanmar 104211-77010, 77011



NEW

**18-6931
STARTER**

Replaces: Yanmar 119209-77010, 121120-77010, 77011, 77012, 124520-77010, 77011

Fits: 3 TNV-84-T engines



NEW

**18-6932
STARTER**

Replaces: Yanmar 121370-77010, 129242-77010, 129698-77010

Fits: 2QM, 3JH3, 3JH3E, 3JH3E-YEU, 3QM, 3QM30, 3QM30F, 3QM30H, 4JH3E



NEW

**18-6934
STARTER**

Replaces: Yanmar 123500-77010, 124610-77010, -77019 424610-77010, Hitachi S13-68, 68A, 68C, 86

Fits: Engine Model 2TR16, 2TR19



NEW

**18-6935
STARTER**

Replaces: Yanmar 119225-77010, 77011, 119226-77010

Fits: 3TN63, 3TN66, 3TN68



NEW

**18-6936
STARTER**

Replaces: Yanmar 114361-77011, 114362-77010, 77011, 114399-77010

Fits: L40S, L60S



NEW

**18-6937
STARTER**

Replaces: Yanmar 128170-77010, 77010D, Hitachi S114-303, 303A

Fits: GM, GM2, GM3, GM10, GM20/2-20F, GM30, GMF, 1GM, 2GM, 3GM



NEW

**18-6938
STARTER**

Replaces: Yanmar 119773-77010

Fits: 6LP-DTE, 6LP-STE Diesel models



NEW

**18-6939
STARTER**

Replaces: Yanmar 121254-77010, 77011, 77012, 77019, 129429-77010, 77011



NEW

**18-6944
STARTER**

Replaces: Bosch 0-001-109-035, Caterpillar 163-3361, Perkins 185086600, Volvo 21323043, 3583555,

Fits: 2001-07 D2-55A, B, C, 2003-07 D2-75A, 4 cyl 134.2cu in. 2.2L



NEW

**18-6947
STARTER**

Replaces: Mercruiser 50-805991

Fits: 7.3L (BRAVO & MIE) DIESEL NAV 444 V-8 1994-1996



NEW

**18-6948
STARTER**

Replaces: Mercury 882571

Fits: CMD 1.7 MI 120 I/L4, CMD 1.7 MS 120 I/L4, D1.7L DTI



NEW

**18-6949
STARTER**

Replaces: Mercruiser 50-831001562, 50-831001961

Fits: WO4CTA (150 HP) HINO 234 I/L4, WO4CTI (210 HP) HINO 234 I/L4



NEW

**18-6954
STARTER**

Replaces: Mercury 50-831001671, 672, 50-831002050, 051, 052

Fits: EH700 (175/220HP) HINO 393 I/L6, HINO Diesel (See Mercruiser)



NEW

**18-6957
STARTER**

Replaces: Mercruiser 50-801333980, 50-854178, 50-855507



NEW

**18-6958
STARTER**

Replaces: Mercury 847308-4, 870998, 881682

Fits: MD, TMD, TAMD Models



**18-79960
FUEL FILTER ELEMENT**

Replaces: Yanmar 104500-55710
Fits: All GM Series, YM Series, HM Series, QM Series



**18-8950
IMPELLER**

Replaces: Yanmar 12423-42092
For: 2GM20F, 2GMF, 2QM, 2QM20, 3GM30F, 3GMF, 3HM, 3HM35, 3HM35F, 3HMF, 3QM30, 3QM30F



**18-8951
IMPELLER**

Replaces: Yanmar 128176-42071
For: 1GM, 1GM10



**18-55500
POWER HEAD GASKET**

Replaces: Yanmar 728170-92600
For: 1GM (7hp)



**18-55502
POWER HEAD GASKET**

Replaces: Yanmar 728271-92605
For: 2GM20 (18hp), 2GM20B, 2GM20C, 2GM20F (18hp)



**18-55501
POWER HEAD GASKET**

Replaces: Yanmar 18-55501
For: 1GM10 (9hp)



**18-55503
POWER HEAD GASKET**

Replaces: Yanmar 728374-92605
For: 3GM30 (27hp), 3GM30 EU (27hp), 3GM30F (27hp), 3GM30F EU (27hp)



**18-56000
BONNET COVER GASKET**

Replaces: Yanmar 128170-11310
For: 1GM, 1GM10,



**18-56601
THERMOSTAT GASKET**

Replaces: Yanmar 104211-49160
For: 1GM, 1GM10,



**18-56602
WATER PUMP GASKET**

Replaces: Yanmar 128170-42090
For: 1GM, 1GM10,



**18-55600
HEAD GASKET**

Replaces: Yanmar 128170-01331
For: 1GM (7hp)



**18-55601
HEAD GASKET**

Replaces: Yanmar 128171-01911
For: 1GM10 (9hp)



**18-55602
HEAD GASKET**

Replaces: Yanmar 128271-01911
For: 2GM20 (18hp), 2GM20B, 2GM20C, 2GM20F (18hp)



**18-55603
HEAD GASKET**

Replaces: Yanmar 128374-01911
For: 3GM30 (27hp), 3GM30 EU (27hp), 3GM30F (27hp), 3GM30F EU (27hp)



**18-6200
Anode**

Replaces: Yanmar 27210-200200
Fits: 1GM, 1GM10, 6LY3



**18-6201
Anode**

Replaces: Yanmar 27210-200300
Fits: 2GM, 3GM, 2GMF, 3GMF, 2GM20, 3GM30, 3HM, 3HM35, 2QM15, 2QM, 3QM, 2QM20, 3QM30, YSB8, YSB12, YSM8, YSM12

OIL FILTERS

Sierra oil filters are engineered with premium grade materials that will not only withstand but excel in the extreme environment of the Marine world. Sierra ensures the excellent performance of their filters by:

- Epoxy coating all canisters for corrosion resistance.
- Using a heavy-wall steel canister for further corrosion protection.
- Using high-efficiency filter media that meets or exceeds the OE's filtration.
- Backed by Sierra's industry leading warranty.

DIESEL OIL FILTERS

 <p>18-0032 Replaces: Volvo: 847741</p>	 <p>18-0033 Replaces: Volvo: 478736</p>	 <p>18-0034 Replaces: Volvo: 477556</p>
 <p>18-0035 Replaces: Volvo: 3582732 Full Flow</p>	 <p>18-0036 Replaces: Volvo: 3582733 Bypass</p>	 <p>18-7871 Replaces: Mercuriser: 35-805809</p>
 <p>18-7880 Replaces: Caterpillar: 1R-0658 Volvo-Penta: 466634</p>	 <p>*18-7884 Replaces: Universal: 299381 Volvo-Penta: 834337 Thread Spec: 3/4" x 16NPT</p>	 <p>*18-7886 Replaces: Perkins: 2654403 Thread Spec: 3/4" x 16NPT</p>
 <p>18-7899 Replaces: Detroit Diesel: 25010495</p>	 <p>*18-7910 Replaces: Westerbeke: 30220 Yanmar: 124450-35100 Thread Spec: 20mm x 1.5</p>	 <p>*18-7917 Replaces: Yanmar: 124450-35110, 124550-35110, 171056-35110, 171056-35111 Thread Spec: 20mm x 1.5</p>
 <p>*18-7925 Replaces: Westerbeke: 21235 Thread Spec: 3/4" x 16NPT</p>	 <p>*18-7926 Replaces: Volvo: 423135, 4785974 Thread Spec: 1" x 12NPT</p>	 <p>18-7927 Replaces: Caterpillar: 1R-0714 Thread Spec: 1 1/8" x 16NPT</p>

* Anti-Drain-Back Valve
Valve eliminates dry starts, prevents oil from draining back into crankcase during engine shutdown.

SEA RAY		
MODEL NO.	S/N	YEAR
3.0L	B787205-B917529	1988
4.3L	B785483-B921276	1988
4.3LX	B785981-B922330	1988
5.7L	B784799-B917017	1988
SRX5.7L, 350 Mag	B785241-B919012	1988
SRX7.4L, 454 Mag Alpha	B785149-B924857	1988
SRX7.4L-H, 454 Mag Bravo	B721206-B919343	1988

STERN DRIVES		
MODEL NO.	S/N	YEAR
SRX7.4L, Alpha	B803866-C348032	1988
SRX7.4L-H, Bravo	B803872-B999972	1988

INBOARD ENGINES		
MODEL NO.	S/N	YEAR
5.7L	B788204-B919356	1988
7.4L	B788179-B913769	1988

RENAULT 4 CYLINDER (STERN DRIVE)		
MODEL	S/N	YEAR
60	1887079-2049044	1965-68
80	2049045-2851423	1966-69
90	2851424-3226957	1970-72

GM 4 CYLINDER (STERN DRIVE)		
MODEL	S/N	YEAR
110	1537370-2044033	1963-66
120	1666601-3377340	1964-72
120	3377341-3770649	1972-73
120	3770650-4952700	1974-77
120	4952701-5192048	1978
120	5192049-6229717	1979-82
120	6229718-6853913	1983-84
120	6853914-B531853	1985-86
120/2.5L	B531854-C853255	1987-89
140	2508261-6229717	1968-82
140/3.0L	6229718-C856558	1982-89
3.0L/LX	C856559-UP	1990-UP

MERCURY MARINE 4 CYLINDER (STERN DRIVE)		
MODEL	S/N	YEAR
470 (2bbl.)	4208730-5520114	1976-79
470 (2bbl.)	5520115-6218036	1980-82
470 (2bbl.)	6218037-6916778	1983-84
170 (2bbl.)	6916779-UP	1985-86
165/3.7L (2bbl.)	6916779-UP	1987-89
485 (2bbl.)	5685394-6218036	1980-82
488 (4bbl.)	6170297-6916778	1983-84
190 (4bbl.)	6916779-UP	1985-86
180/3.7LX (4bbl.)	6916779-UP	1987-89

GM INLINE 6 CYLINDER (STERN DRIVE)		
MODEL	S/N	YEAR
140	1538930-1725960	1963
150	1666495-2048046	1964-66
160	2048022-2770031	1967-69
165	2770032-5178958	1970-78
165	5178959-5813433	1979-81
200	2453769-2712072	1969

GM V6 (STERN DRIVE)		
MODEL	S/N	YEAR
185 (4bbl.)	6330183-6919655	1983-84
185 (2bbl.)	A331455-B527954	1985-87
175/4.3L (2bbl.)	B527955-D714106	1987-92
4.3L (GEN II)(2bbl.)	D714107-F000877	1992-93
4.3L (GEN II)(2bbl.)	F000878-F601126	1993-95
4.3L (GEN II)(2bbl.)	F601127-F000878	1996
4.3LX (GEN+)(2bbl.)	F803000-K999999	1996-97
4.3L (GEN+)(2bbl.)	L010044-UP	1998-UP
4.3L EFI (GEN+)(TBI)	L012009-UP	1998-UP
205 (4bbl.)	A331455-B527954	1985-87
205/4.3LX (4bbl.)	B527955-D714369	1987-91
4.3LX (GEN II)(4bbl.)	D714370-F001219	1992-93
4.3LX (GEN II)(4bbl.)	F001220-F601126	1993-95
4.3LX (GEN II)(4bbl.)	F601127-F802999	1996
4.3LXH (GEN+)(4bbl.)	F803114-UP	1996-97
4.3LH(GEN+)(4bbl.)	L010044-UP	1998
262 Mag. (TBI)(GEN+)	F803800-K999999	1996-97

FORD V8 (STERN DRIVE)		
MODEL	S/N	YEAR
888 (2bbl.)	3108723-4887829	1971-77
215 (4bbl.)	2781153-3385720	1970-72
225 (4bbl.)	3385721-4166999	1973-74

FORD V8 (STERN DRIVE) Cont.		
MODEL	S/N	YEAR
225-S (4bbl.)	3385721-4166999	1973-74
233	4173000-4902304	1975-77
255	3258728-4175499	1971-74

GM V8 283, 327, 305 & 350 CID		
MODEL	S/N	YEAR
190	1564539-1730903	1963-64
898 (2bbl.)	4762210-6218461	1977-82
898 (2bbl.)	6218462-B525981	1983-84
200/5.0L (2bbl.)	6218462-F600999	1985-95
5.0L (2bbl.)	L015751-UP	1998-UP
5.0L EFI	L012052-L340000	1998-99
228 (4bbl.)	4765100-5170008	1977-78
228 (4bbl.)	5170009-6218461	1979-82
228 (4bbl.)	6218462-B525981	1982-84
230 (4bbl.)	6218462-B525981	1985-86
230/5.0LX (4bbl.)	B525982-F600999	1987-95
225	1539620-2694014	1963-69
250	2314301-2639854	1968-69
255	4175500-4767999	1975-76
250	4768000-4908849	1977
260/5.7L	4908850-6218461	1978-82
260/5.7L	621462-B525981	1982-86
260/5.7L	B525982-F600999	1987-95
5.7L (2bbl.)	F601000-UP	1996-98
5.7L EFI	F225560-UP	1995-UP
5.7LX (4bbl.)	F601000-K999999	1996-97
5.7LX EFI	F752400-K999999	1996-97
5.7LX Bravo EFI	F800300-K999999	1996-97
350 Mag. Alpha	A635178-B525981	1986-87
350 Mag. Alpha	B525982-F600999	1987-95
350 Mag. Alpha	F601000-K001526	1996
350 Mag. Alpha	K001527-K999999	1997
350 Mag. Alpha EFI	F800300-K999999	1996-97
350 Mag. Bravo MPI	F415189-K999999	1995-97
350 Mag. Bravo MPI (GEN +)	F602000-K999999	1996-97
350 Mag. MPI (GEN+)	L010019-UP	1998-UP
270	2851074-3385720	1969-72
280TRS	4176250-4770199	1975-76
300 Tempest	6668677-B430367	1985-86
320 (EFI)	A543604-C622418	1987-89

GM V8 427, 454, 502, 540 & 572 (STERN DRIVE)		
MODEL	S/N	YEAR
325	2278747-3780449	1969-72
330	4623115-6083144	1977-81
330	6083145-B816450	1982-87
7.4L Bravo	B771113-D603117	1988-91
7.4L Bravo (Gen.V)	D603118-F800699	1992-96
7.4L Bravo (Gen.VI)	F800700-K999999	1996-97
7.4LX Bravo (MPI)(Gen.V)	F602010-F801999	1996
7.4LX Bravo (MPI)(Gen.VI)	F802000-K999999	1996-97
7.4L MPI (Gen.VI)	L010003-UP	1998
7.4LX Bravo (TBI)(Gen.VI)	F820000-K999999	1996-97
454 Mag. Alpha	A631894-UP	1986-88
454 Mag. Bravo (Gen.V)	D805069-F304999	1992-94
454 Mag. Bravo (Gen.V)	F305000-F801699	1995-96
454 Mag. Bravo (Gen.VI)	F801700-K999999	1996-97
454 EFI (Gen.V)	F115700-F802349	1994-96
454 Mag. MPI (Gen.VI)	F802350-K999999	1996-97
454 Mag. MPI (Gen.VI)	L010029-L085399	1998
454 Mag. MPI (Gen.VI)	L085400-UP	1999-UP
370 TRS	4179554-6721527	1978-85
370 TRS	6721528-B714586	1985-87
400 TRS	4179554-B457644	1980-86
420	A398941-D937011	1987-89
425	A398941-D937011	1990-93
440 TRS	4179554-B485220	1983-86
450 (Gen.V)	F347100-F347277	1995-96
525 SC	D456000-F348963	1991-92
525 SC (Gen.V)	D456000-F348963	1992-95
525 SC (Gen.V)	F615814-F745215	1996
525 SC (Gen.VI)	F745260-UP	1996-97
390	2781129-3042731	1969-70
460 TRS	4719554-6181046	1983-86
465	C849992-F213244	1990-92
465 (Gen.V)	C849992-F213244	1992-94
500 (Gen.V)	F213293-F745159	1994-96

GM V8 427, 454, 502, 540 & 572 (STERN DRIVE) Cont.		
MODEL	S/N	YEAR
500 (Gen.VI)	F745195-L001772	1997-98
502 Mag. Bravo	C878221-D824588	1990-92
502 Mag. Bravo (Gen.V)	D824589-F114528	1992-93
502 EFI (Gen.V)	D840650-F802599	1993-96
502 Mag.MPI (Gen.VI)	F802600-K999999	1996-97
500 EFI	L001477-UP	1999-UP
502 Mag.MPI (Gen.VI)	L085433-UP	1998
600 SC	D456489-F877642	1991-92
600 SC (Gen.V)	D456489-F877642	1992-96
600 SC (Gen.VI)	K000227-UP	1997
500 Bulldog	C577254-F745405	1990-96
500 Bulldog	K000248-UP	1997
575	A677429-D763716	1986-92
800 SC (Gen.V)	D763836-UP	1993-96

MCM 4,5,6 & V8 CYLINDER DIESEL STERN DRIVE ENGINE			
MODEL	HP	S/N	YEAR
Rover	60	3140000F-UP	1965-67
530 D-TA	150	B993000-B993492	1989
636 D-TA	180	B993500-C696047	1989
D183	140	B993493-D725149	1990-93
D219	170	C696048-D850124	1990-93
D254	200	C849484-D554729	1990-93
D3.0L	140	D725150-UP	1994-UP
D3.6L	170	D850125-UP	1994-UP
D4.2L	200	D554730-UP	1994-UP
D7.3L	238	F060000-UP	1994-UP

MERCURY MARINE MIE 4 CYLINDER (INBOARD)		
MODEL	S/N	YEAR
470	5520115-6218036	1980-81

FORD MIE V8 (INBOARD)		
MODEL	S/N	YEAR
215	2781153-3563181	1970-72
225	3385721-4176999	1970-72
233	4173000-4775784	1975-76
255	3258728-4178299	1973-74

GM MIE V8 305,327,350 CID (INBOARD)		
MODEL	S/N	YEAR
198	4762210-6218461	1977
228	4765100-5170008	1977-78
228	5170009-5907057	1979-80
230/5.0L (4bbl.)	5907058-B788151	1981-87
225	2278647-2694014	1968
250	2314301-2639854	1968-69
255	4175500-5907057	1975-80
260/5.7L	5907058-F024999	1981-93
270	2851074-3077735	1969-72
5.7L	F025000-K999999	1994-97
5.7L (Gen+)	L002003-UP	1998
5.7L MPI	K040300-K999999	1997
350 Mag. MPI (Gen+)	L002008-L304499	1998
350 Mag. MPI (Gen+)	L304500-UP	1999
350 Horizon	L304700-UP	1999-UP
5.7L Ski	A338533-B514626	1985-87
5.7L Competition Ski	B514627-F775199	1987-95
5.7L Competition Ski	F775200-K040003	1996
5.7L Competition Ski	K040004-K999999	1997
5.7L Competition Ski (Gen+)	L002005-UP	1998-UP
350 Mag. Ski	D505450-K999999	1991-97
350 Mag. EFI Ski	F215561-K999999	1994-97
350 Mag. MPI Ski	F350583-F799999	1995-98
Black Scorpion Ski	F800000-UP	1996-98

GM MIE V8 427, 454, 482 & 502 CID (INBOARD)		
MODEL	S/N	YEAR
325	2278747-3780449	1968-74
330	4623115-5889913	1977-80
340/7.4L w/B/W MK4	5889914-UP	1981-92
7.4L w/Hurth (LH) MK4	C391564-D715493	1989-92
7.4L (LH)	D715494-K999999	1992-97
7.4L MPI (LH)	F563052-K999999	1995-97
7.4L MPI (L29) Gen VI	L002006-UP	1998
7.4L TBI (LH) Gen VI	F874815-K999999	1996-97
454 Mag. MPI Horizon	L002200-L086049	1998-99
454 EFI (SKI) (Gen.V)	F215800-F820099	1995-96
454 Mag. MPI (SKI)(Gen.VI)	F820100-K999999	1996-97
350	9780450-4623109	1974-76
390	2781129-2825059	1969-70
8.2L w/ Hurth	C878221-D857199	1990-92
8.2L (Gen.V)	D857200-F819619	1993-96
8.2L MPI (LH) Gen VI	F819620-K999999	1996-97

GM MIE V8 427, 454, 482 & 502 CID (INBOARD)		
MODEL	S/N	YEAR
8.2L MPI (LH) Gen VI	L002450-L0086012	1998
8.2L MPI (LH) Gen VI	L0086013-UP	1999

MIE 5, 6 & V8 CYLINDER DIESEL INBOARD ENGINES			
MODEL	HP	S/N	YEAR
530 D-TA	150	B993002-C539258	1989
636 D-TA	180	B993750-C696011	1989
D183	150	C539259-D725149	1990-93
D219	180	C696012-D850124	1990-93
D254	210	C849461-D554729	1990-93
D3.0L	150	D725150-UP	1994-UP
D3.6L	180	D850125-UP	1994-UP
D4.2L	210	D554730-UP	1994-UP
D7.3L	262	F060000-UP	1994-UP

MC 60, 80 & 90 STERN DRIVES & TRANSOM PLATES		
MODEL	S/N	YEAR
60 (O)	1830753-2063740	1965-66
80	2063741-2898029	1966-69
90	2898020-3225967	1970-72

MC I, II & III		
MODEL	S/N	YEAR
I	1534570-1684187	1963
II (1.33:1)	1474909-2278488	1962-67

MC I, II & III Cont.		
MODEL	S/N	YEAR
II (1.78:1)	2398798-2671321	1968-69
III	2373127-3002613	1968-72
III	5128065-UP	1978-UP

MC 1A, 1B & 1C		
MODEL	S/N	YEAR
1A, 1B & 1C	1684188-1777798	1964
1A, 1B & 1C (E-Z Shift)	1776349-2065189	1965-66

MC 120, 140, 160 & 165		
MODEL	S/N	YEAR
120/140	2062141-378049	1967-73
120/140	3780850-4893634	1974-77
120/140	4893635-6225576	1978-82
160	2065190-2763441	1967-69
165	2763442-3780849	1970-73
165	3780849-4890459	1974-77
165	4890460-6268064	1978-82

MC470 & 485		
MODEL	S/N	YEAR
470	4208730-4893834	1976-77
470	4893835-6225576	1978-82
485	5487437-6225576	1980-82

MC 888, 225S & 233		
MODEL	S/N	YEAR
888	3106717-3784374	1971-73
888	3784375-4782329	1974-77
225S	3856268-4200499	1974
233	4200500-4782329	1975-77

MC 898, 228, 250 & 260		
MODEL	S/N	YEAR
898/228	4782330-4898729	1977
898/228	4898730-6229157	1978-82
250	4791300-4898729	1977
260	4898730-6229157	1978-82

MC R, MR, ALPHA ONE, ALPHA ONE SS & ALPHA ONE GEN II		
MODEL	S/N	YEAR
R	6152230-6847029	1983-84
MR	6810538-A479506	1985
Alpha One	A470165-UP	1986-90
Alpha One SS	A545004-UP	1986-89
Alpha One Gen II	D469859-UP	1991-UP

MC BRAVO & BLACKHAWK		
MODEL	S/N	YEAR
Bravo One	B664190-UP	1988-UP
Bravo Two	C564952-UP	1989-UP
Bravo Three	D763691-UP	1993-UP
Blackhawk	F186717-UP	1994-UP

MC 215E & 215H		
MODEL	S/N	YEAR
215H	2782203-2909034	1970
215E	2782203-2909034	1970-72

MC TR & TRS		
MODEL	S/N	YEAR
TR	3377316-3787239	1973
TR	3787240-4794899	1974-76
TR	4794900-5009866	1977
TR	5009867-UP	1978-UP
TRS	3787240-4203749	1974-75
TRS	4203750-4795399	1976
TRS	4795400-UP	1977-UP



**18-5291
TUNE-UP KIT**

Replaces: 808483K2
GM V-8 engines w/Delco HEI-1998 and newer
(except MPI engines with 555 ECM)



**18-5246
TUNE-UP KIT**

Replaces: 898253T28
For: Late model V-6, 4.3L (Alpha/Bravo)



**18-5247
TUNE-UP KIT**

Replaces: 898253T29
For: Late model V-8 (Alpha/Bravo 350
Mag, 5.0L, & MX 6.2L)

① **18-5250D**



**18-5250
TUNE-UP KIT**

Replaces: 34235T1, 34235Q1

-CONTAINS-		
Part #	O.E. #	Description
18-5311	34235	Contact Set
18-5345	33662	Condenser
18-5418	58217	Rotor

Delco 4 & 6 cyl.

① **18-5251D**



**18-5251
TUNE-UP KIT**

-CONTAINS-

Part #	O.E. #	Description
18-5314	391-5090	Contact Set
18-5338	391-5092	Condenser
18-5404-1	391-7057	Rotor

Mallory 8 cyl. Tall Cap



**18-5252
TUNE-UP KIT**

-CONTAINS-

Part #	O.E. #	Description
18-5310	33700	Contact Set
18-5344	33706	Condenser

Delco 8 cyl.



**18-5253
TUNE-UP KIT**

-CONTAINS-

Part #	O.E. #	Description
18-5318	58033	Contact Set
18-5346	58034, 81-64851	Condenser
18-5420	65864	Rotor

Autolite 8 cyl.



**18-5254
TUNE-UP KIT**

-CONTAINS-

Part #	O.E. #	Description
18-5317	64850, 87-71831	Contact Set
18-5346	58034, 81-64851	Condenser
18-5420	65864, 78016	Rotor

Mercury 8 cyl.



**18-5258
TUNE-UP KIT**

-CONTAINS-

Part #	O.E. #	Description
18-5303	392-6325	Contact Set
18-5347	392-6324	Condenser
18-5407	392-6326	Rotor

Prestolite 8 cyl.

① **18-5260D**



**18-5260
TUNE-UP KIT**

-CONTAINS-

Part #	O.E. #	Description
18-5303	392-6325	Contact Set
18-5345	392-6324	Condenser
18-5403	392-9767	Rotor

Prestolite 8 cyl.



**18-5266
TUNE UP KIT**

Fits: Flame Thrower Distributors 18-5481, 18-5482,
18-5483, 18-5477, 18-5478 and 18-5479



**18-5267
TUNE-UP KIT**

-CONTAINS-

Part #	O.E. #	Description
18-5318	58033	Contact Set
18-5346	58034, 81-64851	Condenser
18-5420	65864, 78016	Rotor
18-5389	393-4988T	Distributor Cap

Autolite V-8 - Single Point



**18-5268
TUNE-UP KIT**

-CONTAINS-

Part #	O.E. #	Description
18-5311	34235	Contact Set
18-5345	33662	Condenser
18-5418	58217	Rotor
18-5385	393-9459	Distributor Cap

Delco In-Line 4 - Single Point



**18-5269
TUNE-UP KIT**

-CONTAINS-

Part #	O.E. #	Description
18-5311	34235	Contact Set
18-5345	33662	Condenser
18-5418	58217	Rotor
18-5386	33765	Distributor Cap

Delco In-Line 6 - Single Point



**18-5270
TUNE-UP KIT**

-CONTAINS-

Part #	O.E. #	Description
18-5310	33700	Contact Set
18-5344	33706	Condenser
18-5384	33708	Distributor Cap

Delco V-8 - Single Point

① Items ending in "D" are Display Packaged - Regular number is Non-Display



**18-5271
TUNE-UP KIT**

—CONTAINS—

Part #	O.E. #	Description
18-5314	391-5090	Contact Set
18-5338	391-5092	Condenser
18-5404-1	391-7057, 391-5088	Rotor
18-5376	391-5075	Distributor Cap

Mallory V-8 - Single Point - Top Terminal



**18-5273
TUNE-UP KIT**

—CONTAINS—

Replaces: 805759T3 / 805759Q3

Part #	O.E. #	Description
18-5431	13524A5	Rotor
18-5395	16457A4	Distributor Cap

Mercury Thunderbolt HEI - V-8



**18-5274
TUNE-UP KIT**

—CONTAINS—

Part #	O.E. #	Description
18-5432	13524A6	Rotor
18-5396	13753A2, 815407A2	Distributor Cap

Mercury Thunderbolt HEI - V-6



**18-5275
TUNE-UP KIT**

—CONTAINS—

Part #	O.E. #	Description
18-5303	392-6325	Contact Set
18-5347	392-6324	Condenser
18-5403	392-9089	Rotor
18-5352	392-9766	Distributor Cap

Prestolite V-8 - Single Point - Screw Cap



**18-5276
TUNE-UP KIT**

—CONTAINS—

Part #	O.E. #	Description
18-5303	392-6325	Contact Set
18-5347	392-6324	Condenser
18-5403	392-9089	Rotor
18-5353	392-9086	Distributor Cap

Prestolite V-6 - Single Point - Screw Cap



**18-5277
TUNE-UP KIT**

—CONTAINS—

Part #	O.E. #	Description
18-5303	392-6325	Contact Set
18-5347	392-6324	Condenser
18-5407	392-6326	Rotor
18-5369	392-6318	Distributor Cap

Prestolite V-8 - Single Point - Clip Cap



**18-5278
TUNE-UP KIT**

Replaces: 850484T3
Delco EST - V-6



**18-5280
TUNE-UP KIT**

Replaces: 811635Q2
Delco EST - In-Line 4

—CONTAINS—

Part #	Description	O.E. #	Qty.
18-5361	Distributor Cap	811635, T3	1
18-5406	Rotor	811636, 1	1



**18-5281
TUNE-UP KIT**

Replaces: 808483Q2
Delco EST - V-8

—CONTAINS—

Part #	Description	O.E. #	Qty.
18-5354	Distributor Cap	808483	1



**18-5282
TUNE-UP KIT**

Holley, Mercury Marine -
Single Point V-8



**18-5283
TUNE-UP KIT**

For: Mallory Single Point In-Line 4



**18-5301
TUNE-UP KIT**

Replaces:
Fits: male cap v-8 flamethrower distributors



**18-5302
TUNE-UP KIT**

Replaces:
Fits: male cap v-8 flamethrower distributors



**18-5303
CONTACT SET**

Replaces: 392-898253005



**18-5310
CONTACT SET**

Replaces: 33700



**18-5311
CONTACT SET**

Replaces: 34235, 34235T



**18-5314
CONTACT SET**

Replaces: 391-5090,
391-898253004

 <p>18-5317 CONTACT SET Replaces: 64850, 87-71831</p>	 <p>18-5318 CONTACT SET Replaces: 58033, 898253007</p>	 <p>18-5338 CONDENSER Replaces: 391-5092, 391-898253001</p>	 <p>18-5344 CONDENSER Replaces: 33706</p>	 <p>18-5345 CONDENSER Replaces: 33662, 898253003</p>
 <p>18-5346 CONDENSER Replaces: 58034, 81-64851</p>	 <p>18-5347 CONDENSER Replaces: 392-6324, 392-898253002</p>	 <p>18-5402 ROTOR Replaces: 898253009 GM V-8 engines w/Delco HEI- 1998 and newer (except MPI engines with 555 ECM)</p>	 <p>18-5245 ROTOR Replaces: 884790, 898253013 For: Late model V-6, V-8 (Alpha/ Bravo 350 Mag, 5.0L, & MX 6.2L)</p>	 <p>18-5403 ROTOR Replaces: 392-9089, 392-9089T, 392-9767</p>
 <p>18-5404-1 ROTOR Replaces: 391-7057, 391-5088, 391-7057T, 391-898253029</p>	 <p>18-5405 ROTOR Replaces: 808484, 808484 1, 898253010 Use with 18-5354 Distributor Cap Fits new GM style "Module in Cap" distributors - V-8 application</p>	 <p>18-5406 ROTOR Replaces: 811636, 811636 1, 898253011 Use with 18-5361 Distributor Cap 3.0L LX</p>	 <p>18-5407 ROTOR Replaces: 392-6326, 392-6326T</p>	 <p>18-5300 ROTOR Fits: Flamethrower Distributors</p>
 <p>18-5408 ROTOR Replaces: 850485, 850485 1, 898253012 Use with 18-5362 Distributor Cap Fits new GM Style "Module in Cap" Distributors V6 Applications</p>	 <p>18-5418 ROTOR Replaces: 58217, 898253008</p>	 <p>18-5420 ROTOR Replaces: 65864, 78016</p>	 <p>18-5431 ROTOR ASSEMBLY Replaces: 13524A5, T1 V-8</p>	
 <p>18-5432 ROTOR ASSEMBLY Replaces: 13524A6 V-6</p>	 <p>18-5243 DISTRIBUTOR CAP Replaces: 888731, 898253T23 For: Late model V-6 (4.3L Alpha/Bravo)</p>	 <p>18-5244 DISTRIBUTOR CAP Replaces: 884792, 858253T22 For: Late model V-8 (Alpha/Bravo 350 Mag, 5.0L, & MX 6.2L)</p>	 <p>18-5352 DISTRIBUTOR CAP Replaces: 392-9766, Q1</p>	

 <p>18-5353 DISTRIBUTOR CAP Replaces: 392-9086, 392-9086T</p>	 <p>18-5354 DISTRIBUTOR CAP Replaces: 808483, 808483T3 Fits new GM style "Module in Cap" Distributors—V-8 applications Use 18-5405 Rotor</p>	 <p>18-5361 DISTRIBUTOR CAP Replaces: 811635, 811635T3 Use 18-5406 Rotor 3.0L LX</p>	 <p>18-5362 DISTRIBUTOR CAP Replaces: 850484, 850484T, 850484T2 Fits new GM Style "Module in Cap" Distributors – V6 Applications Use 18-5408 Rotor</p>
 <p>18-5369 DISTRIBUTOR CAP Replaces: 392-6318, 392-6318T with gasket 18-5399</p>	 <p>18-5376 DISTRIBUTOR CAP Replaces: 391-5075, 391-5075Q1</p>	 <p>18-5384 DISTRIBUTOR CAP Replaces: 33708</p>	 <p>18-5385 DISTRIBUTOR CAP Replaces: 393-9459, 393-9459Q1</p>
 <p>18-5386 DISTRIBUTOR CAP Replaces: 33765, 33765T</p>	 <p>18-5389 DISTRIBUTOR CAP Replaces: 393-4988T, 393-4988T2</p>	 <p>18-5395 DISTRIBUTOR CAP Replaces: 16457A4, 805759T, 805759T1 V-8</p>	 <p>18-5396 DISTRIBUTOR CAP Replaces: 13753A2, 815407A2 V-6</p>
 <p>18-5397 DISTRIBUTOR CAP</p>	 <p>18-5473 DISTRIBUTOR CAP Black Distributor Cap w/ Male Terminals Petronix Dsistributors</p>	 <p>18-5474 DISTRIBUTOR CAP Red Distributor Cap with Male Terminals Petronix Dsistributors</p>	<p>PKG OF 2</p>  <p>18-5399 18-5399-9^① DISTRIBUTOR CAP GASKET Replaces: 392-6329</p>

FEATURES

- Oil filled for better cooling and long life
- Low resistance and improved turn ratios produces the higher voltage needed to run larger spark plug gaps for added power and better fuel economy
- More windings maximize energy and reliability over the full RPM range
- Fits existing brackets for easy installation

<p>18-5466 HI-PERFORMANCE IGNITION COIL 1.5 ohm (oil filled), black - 8 cylinder: Flame-Thrower 40,000 volt coil.</p> <ul style="list-style-type: none"> • Designed for use with the original Ignitor Electronic Conversion Kits • Can be used with other inductive ignition systems 	<p>18-5469 HI-PERFORMANCE IGNITION COIL 3.0 ohm (oil filled), black - 4 & 6 cylinder: Flame-Thrower 40,000 volt coil.</p> <ul style="list-style-type: none"> • Designed for use with the original Ignitor Electronic Conversion Kits • Can be used with other inductive ignition systems 	<p>18-5472 HI-PERFORMANCE IGNITION COIL 0.6 ohm (oil filled), black - 4, 6, & 8 cylinder:Flame-Thrower 45,000 volt coil.</p> <ul style="list-style-type: none"> • Super low 0.6 ohm resistance coil designed for use with the Ignitor II Hi Performance Electronic Conversion Kits • Compatible with capacitive discharge systems 
---	--	--

① Priced per Package

COIL APPLICATION BEGINS ON NEXT PAGE
CAP APPLICATION BEGINS ON PAGE 593

Part #	Description	Recommended Coil	Resistance Ohms	Part #	Description	Recommended Coil	Resistance Ohms
18-5294	Electronic Conversion Kit	18-5469	3.0	18-5286	Hi Performance Electronic Conversion Kit	18-5472	0.6
18-5295	Electronic Conversion Kit	18-5469	3.0	18-5288	Hi Performance Electronic Conversion Kit	18-5472	0.6
18-5296-2	Electronic Conversion Kit	18-5466	1.5	18-5289	Hi Performance Electronic Conversion Kit	18-5472	0.6
18-5297	Electronic Conversion Kit	18-5469	3.0	18-5290	Hi Performance Electronic Conversion Kit	18-5472	0.6
18-5298	Electronic Conversion Kit	18-5466	1.5	18-5481	Flame-Thrower Distributor	18-5472	0.6
18-5299	Electronic Conversion Kit	18-5466	1.5	18-5482	Flame-Thrower Distributor	18-5472	0.6
18-5285	Hi Performance Electronic Conversion Kit	18-5472	0.6	18-5483	Flame-Thrower Distributor	18-5472	0.6



**18-5433
IGNITION COIL**
Replaces: 38547, 32193A2, 392-806529A1, 898253T24 DELCO 1115202
(Uses External Resistor)



**18-5438
IGNITION COIL**
Replaces: 392-7803A4, 392-805570A2 HEI



**18-5465
IGNITION COIL**
Replaces: 392-863704T ss 8M0054588 2001 and newer 4.3L, 5.0L, 5.7L & 6.2L with 555 ECM (OM300000 and up)



**18-7493
COIL**
Replaces: 392889925
For: 8.1L & 496 Mag OM315053 & UP



**18-7648
IGNITION COIL**
Replaces: 392881732



**18-5442
IGNITION COIL**
Replaces: 806673T, T1



**18-5443
IGNITION COIL**
Replaces: 817378T, 817378, 898253T27



**18-5117
IGNITION MODULE**
Replaces: GM 10482803
Fits: MCM MIE 4.3L MPI, 5.0L MPI, 350 Mag MPI and MX 6.2L MPI engines with ECM555 (2001 & Up) S/N OM300000 & Up



**18-5107-1
IGNITION MODULE**
4/6/8 cyl.
Replaces: 811637001



**18-5464
IGNITION MODULE**
Fits: Sierra 18-5481, 18-5482 and 18-5483 Billet HI-PERFORMANCE ELECTRONIC DISTRIBUTORS (except HEI/EST)



**18-5488
IGNITION MODULE**
Replacement module for Mallory electronic distributors



**18-5108
PICK UP
COIL SENSOR**
Replaces: 811639, T V4/V6/V8



**18-5116-1
IGNITION SENSOR KIT**
Replaces: 87-861780A2, Q4
For: V-6 & V-8 with Thunderbolt ignition (1981-1997) nut connectors



**18-7757
THROTTLE POSITION SENSOR**
Replaces: 803148
For: 350 Mag OL005900 & Up

- Senses current levels in the coil and adjusts the dwell to maintain peak energy throughout the entire RPM range.
- Develops, on average, 4 times more available energy between 3000 and 5000 RPM's and twice as much plug voltage as point-type systems.
- Ignition energy is sustained and coil life is increased when peak current level is reached just prior to spark.
- More stable timing.
- Use with 18-5472 "Flame Thrower II" Coil for optimum performance

18-5285
HI-PERFORMANCE
ELECTRONIC
CONVERSION KIT

Fits: 4 Cylinder Delco Distributors



18-5286
HI-PERFORMANCE
ELECTRONIC
CONVERSION KIT

Fits: 6 Cylinder Delco Distributors



18-5288
HI-PERFORMANCE
ELECTRONIC CONVERSION KIT

Fits: Most Prestolite V-8 Distributors with snap down cap



18-5289
HI-PERFORMANCE
ELECTRONIC CONVERSION KIT

Fits: Most Prestolite Distributors with screw down cap



18-5290
HI-PERFORMANCE
ELECTRONIC CONVERSION KIT

Fits: Most Mallory YL or YD 8 cylinder Distributors with clockwise and counter clockwise rotation



- Replaces point & condensers for true solid state ignition.
- Uses standard coil, cap and rotor.
- Easy to install, one-piece, 2-wire hook-up.
- Accurate to within 1/4° timing accuracy 0 to 6000 RPM range.
- Can be used with Flame Thrower 18-5466 & 18-5469.

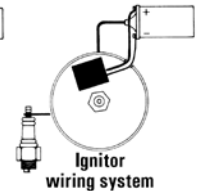
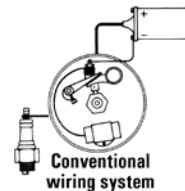

18-5294
ELECTRONIC CONVERSION KIT

Fits: 6 Cyl. Delco Distributors



18-5295
ELECTRONIC CONVERSION KIT

Fits: Most 4 Cyl. Prestolite Distributors (Except IBM7026)
For: Onan, Universal, Waukesha, Wisconsin



18-5296-2
ELECTRONIC CONVERSION KIT

Fits: Most Mallory YL or YD 8 cyl. Distributors with clockwise or counter clockwise rotation



① **18-5296-2D** Display Package

18-5297
ELECTRONIC CONVERSION KIT

For 4 Cyl. GM



① **18-5297D** Display Package

18-5298
ELECTRONIC CONVERSION KIT

(with snap down cap) For: Most Prestolite V-8 Distributors



18-5299
ELECTRONIC CONVERSION KIT

(with screw down cap) For: Most Prestolite V-8 Distributors
Use with 18-5403 Style Rotor



① **18-5299D** Display Package

APPLICATION BEGINS ON PAGE 593

① Items ending in "D" are Display Packaged - Regular number is Non-Display



FEATURES

- Distributors feature the Ignitor II ignition module with adaptive dwell control adjusts the spark timing over the entire RPM range to maximize performance
- Upper roller bearing and oil impregnated bronze sintered bottom bushing are installed and aligned bored for accuracy for maximum durability
- Machined heat treated gear with tight tolerances insures durability and consistent timing to maximize horsepower and performance. Complete with high dielectric strength cap and rotor for years of performance

Standard Rotation

CCW Rotation

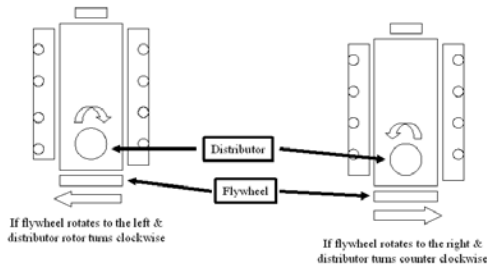

18-5481
HI-PERFORMANCE
ELECTRONIC DISTRIBUTOR
 Fits: Ford V-8 351 Windsor
 Replacement cap/rotor kit: 18-5266



18-5482
HI-PERFORMANCE
ELECTRONIC DISTRIBUTOR
 Fits: Ford V-8 351 Cleveland, 351M, 400, 429 and 460 engines
 Replacement cap/rotor kit: 18-5266



18-5483
HI-PERFORMANCE
ELECTRONIC DISTRIBUTOR
 Fits: Chevrolet marine small and big block engines (standard deck height)
 Replacement cap/rotor kit: 18-5266

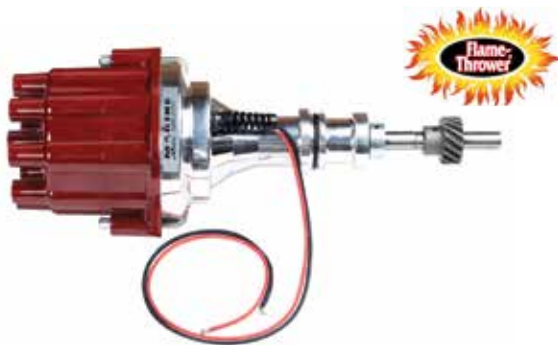

18-5477
ELECTRONIC DISTRIBUTOR
 Fits: Ford 302 V-8 engines



18-5478
ELECTRONIC DISTRIBUTOR
 Fits: Chrysler LA series V-8 engines



18-5479
ELECTRONIC DISTRIBUTOR
 Fits: GM V-8 engines-reverse rotation



18-5480
COMPLETE IGNITION
CONVERSION KIT
 Fits: GM SB & BB with Standard Deck Height
 —CONTAINS—

Part #	Description
18-5472	Coil
18-8803-2	Wire Set
18-5483	Distributor



18-5470
THUNDERBOLT IV V-8 DISTRIBUTOR
 Replaces: 805185A36
 Fits: GM V-8 engines



18-5471
THUNDERBOLT IV V-6 DISTRIBUTOR
 Replaces: 805185A37
 GM V-6 engines



18-5350
DISTRIBUTOR
 Replaces: 888751A03
 Fits: Vortec™ V-6 4.3L MPI (2002-06)



18-5351
DISTRIBUTOR
 Replaces: 884794A02
 Fits: Vortec V-8 2001 and up 5.0L/ 5.7L/ 6.2L MPI engines (S/N OM300000 and up)



18-5475
DISTRIBUTOR
 Replaces: 817377
 FITS: 4 CYL GM W/ DELCO EST IGNITION



18-5476
DISTRIBUTOR
 Replaces: 807964A1
 Fits: GM V-6 engines with Delco EST ignition HEI



18-5484-1
ELECTRONIC DISTRIBUTOR
Left Hand Rotation
 Replaces: Mallory YLE624AV
 Late Model HEI
 For V8 — 262-454 & 502 except 384/ 409 and tall block engines
 • Designed as a plug-in replacement for GM-style fuel injection system distributors

—CONTAINS—

Part #	Description
18-5354	Distributor Cap
18-5405	Rotor



18-5485
ELECTRONIC DISTRIBUTOR
Right Hand Rotation
 Replaces: Mallory YLE624BV
 Late Model HEI
 For V8 — 262-454 & 502 except 384/ 409 and tall block engines
 • Designed as a plug-in replacement for GM-style fuel injection system distributors

—CONTAINS—

Part #	Description
18-5354	Distributor Cap
18-5405	Rotor



18-5486
ELECTRONIC DISTRIBUTOR
 Conventional Rotation
 For Chevrolet L4, 153 & 181 CID

—CONTAINS—

Part #	Description
18-5397	Distributor Cap
18-5488	Module
18-5404-1	Rotor



18-5487
ELECTRONIC DISTRIBUTOR
 Conventional Rotation
 For Chevrolet L6, 194, 230, 250, 292 CID

—CONTAINS—

Part #	Description
18-5488	Module
18-5404-1	Rotor



**18-5489
ELECTRONIC
DISTRIBUTOR**
Conventional Rotation
For Ford V8 351W CID

—CONTAINS—

Part #	Description
18-5376	Distributor Cap
18-5488	Module
18-5404-1	Rotor



**18-5494-1
ELECTRONIC
DISTRIBUTOR**
Conventional Rotation
For Chevrolet all V8 includes 482, 502, 540 CID (Except 348,409 & Tall Deck Big Block)

—CONTAINS—

Part #	Description
18-5376	Distributor Cap
18-5488	Module
18-5404-1	Rotor



**18-5495-1
ELECTRONIC
DISTRIBUTOR**
Conventional Rotation
For Ford V8 302 CID

—CONTAINS—

Part #	Description
18-5376	Distributor Cap
18-5488	Module
18-5404-1	Rotor



**18-5496-1
ELECTRONIC
DISTRIBUTOR**
Replaces: YLM567CV
Conventional Rotation
For Ford V8 351C — 460 CID

—CONTAINS—

Part #	Description
18-5376	Distributor Cap
18-5488	Module
18-5404-1	Rotor



**18-5497-1
ELECTRONIC
DISTRIBUTOR**
Replaces: YLM579AV
Conventional Rotation
For Chrysler V8 273,318 (67 & UP) 340,
360 CID "LA" engines

—CONTAINS—

Part #	Description
18-5376	Distributor Cap
18-5488	Module
18-5404-1	Rotor



**18-5498-1
ELECTRONIC
DISTRIBUTOR**
Replaces: YLM624BV
Reverse Rotation
For Chevrolet all V8 includes 482, 502, 540 CID
(Except 348,409 & Tall Deck Big Block)

—CONTAINS—

Part #	Description
18-5376	Distributor Cap
18-5488	Module
18-5404-1	Rotor



**18-5309
DISTRIBUTOR**
Contact Controlled (Standard Rotation)
Replaces: Mallory YL512CV
For most Ford 302 CID V-8 Eng.
Uses: 18-5251 TUNE-UP KIT

—CONTAINS—

Part #	Description
18-5314	Contact Set
18-5338	Condenser
18-5404-1	Rotor

And 18-5376 CAP



**18-5312
DISTRIBUTOR**
Replaces: Mallory YL554CV
For most Ford 351 CID V-8 Eng.
Uses 18-5251 Tune-Up Kit
& 18-5376 Cap



**18-5313
DISTRIBUTOR**
Contact Controlled (Standard Rotation)
Replaces: 17177A1; Mallory YL624AV
For most GM V-8 Engs. (small & large blocks) Mallory
Tall Cap
Uses: 18-5251 TUNE-UP KIT

—CONTAINS—

Part #	Description
18-5314	Contact Set
18-5338	Condenser
18-5404-1	Rotor

And 18-5376 CAP



**18-5315
DISTRIBUTOR**
Contact Controlled (Standard Rotation)
Replaces: 87581; Mallory YL673AV
For most GM 4 Cyl. Engs. (120 & 140 HP)
Uses: 18-5251 TUNE-UP KIT

—CONTAINS—

Part #	Description
18-5314	Contact Set
18-5338	Condenser
18-5404-1	Rotor

And 18-5397 CAP

Model	CYL	Type of Ignition	Year	Serial #	Tune-Up Kit	Contact Set	Rotor	Dist. Cap	Coil	Distributor	Electronic Conv. Kit	Spark Plug Wires
110	153/4	⊕	1963-1966	1537370-2044033	18-5250 18-5268	★ ☐	18-5311	18-5418	18-5385	18-5433	18-5315	18-5297 18-8800-1
120	153/L4	⊕	1964-1986	1666601 - B531853	18-5250 18-5268	★ ☐	18-5311	18-5418	18-5385	18-5433	18-5315	18-5297 18-8800-1
2.5L	153/L4	⊕	1987-1989	B531854 - C853255	18-5250		18-5311			18-5433		
PRESTOLITE REPLC IGN	4 CYL	⊕	1963-1989	1537370 - C853255			18-5303	18-5403				
140	181/L4	⊕	1968-1986	2508261 - B450800	18-5250 18-5268	★ ☐	18-5311	18-5418	18-5385	18-5433	18-5315	18-5297 18-8800-1
3.0L	181/L4	⊕	1987-1989	B450801 - C856558	18-5250		18-5311			18-5433		
3.0L	181/L4	⊕	1990-1991	C856559 - D504541			18-5303	18-5403		18-5433		
3.0L	181/L4	⊕	1990-1991	C856559 - D504541								18-8811-1
3.0L	181/L4	⊕	1991-1994	D504542 - F603999				18-5361	18-5443			18-8833-1
3.0L	181/L4	⊕	1998-2010	L010042 - & UP				18-5361	18-5443			18-8833-1
3.0L MPI	181/L4	⊕	2008-2010	A072812 - & UP				18-5361	18-5443			18-8833-1
3.0LX	181/L4	⊕	1990-1991	C856559 - D504541								18-8811-1
3.0LX	181/L4	⊕	1991-1997	D504542 - K999999								18-8833-1
3.0L/LX	L4	⊕	1990-1995	C856559 - F603999	18-5262		18-5303	18-5403		18-5315		18-8800-1
3.0L/LX	L4	⊕	1990-1995	C856559 - F603999								18-8811-1
3.0L/LX	L4	⊕	1996 & UP	F604000 & UP	18-5280			18-5406	18-5361	18-5443		18-8833-1
PRESTOLITE REPLC IGN	4 CYL	⊕	1968-1991	2508261 - D504541			18-5303	18-5403				
165	224/L4	⊕	1987	B434941 - B774251	18-5250		18-5311			18-5433		
170	224/L4	⊕	1985-1986	6916779 - B434940	18-5250		18-5311			18-5433		
180	224/L4	⊕	1987	B436391 - B775248	18-5250		18-5311			18-5433		
180	224/L4	⊕	1987-1989	B436391 - B775248			18-5303	18-5403		18-5433		
190	224/L4	⊕	1985-1986	6916779 - B436390	18-5250		18-5311			18-5433		
3.7L	224/L4	⊕	1988-1989	B774252 - & UP	18-5250		18-5311			18-5433		
3.7LX	224/L4	⊕	1988-1989	B775249 - & UP	18-5250		18-5311			18-5433		
3.7LX	224/L4	⊕	1988-1989	B775249 - & UP			18-5303	18-5403		18-5433		
470	224/L4	⊕	1976-1984	4208730 - 6916778	18-5250	★	18-5311	18-5418	18-5385	18-5433	18-5297	18-8808-2
165, 170, 190	L4	⊕	1985-1989	6916779 & UP	18-5250	★	18-5311	18-5418	18-5385	18-5433	18-5297	18-8808-2
(224CID)					18-5268	☐						
180LX	L4	⊕	1987-1989	B436391 & UP	18-5250	★	18-5311	18-5418	18-5385	18-5433	18-5297	18-8808-2
180LX	L4	⊕	1987-1989	B436391 & UP	18-5262		18-5303	18-5403		18-5433		18-8808-2
160, 165(250cid)	L6	⊕	1967-1981	2048022-5813433	18-5250 18-5269	★ ☐	18-5311	18-5418	18-5386	18-5433	18-5294	18-8809-1
485	224/L4	⊕	1980-1982	5685394 - 6218036	18-5250		18-5311			18-5433		
488	224/L4	⊕	1983-1984	6170297 - 6916778	18-5250		18-5311			18-5433		
PRESTOLITE REPLC IGN	4 CYL	⊕	2010				18-5303	18-5403				
140	194/L6	⊕	1963	1538930 - 1725960	18-5250 18-5269	★ ☐	18-5311	18-5418	18-5386		18-5312	18-5294 18-8809-1
150	230/L6	⊕	1964-1966	1666495 - 2048046	18-5250 18-5269	★ ☐	18-5311	18-5418	18-5386		18-5294	18-8809-1
160	250/L6	⊕	1967-1970	2048022 - 2771483	18-5250		18-5311		18-5386	18-5433		
165	250/L6	⊕	1971-1981	2771484 - 5813433	18-5250		18-5311		18-5386	18-5433		
200	292/L6	⊕	1969	2453769 - 2712072	18-5250 18-5269	★ ☐	18-5311	18-5418	18-5386	18-5433	18-5487	18-8809-1
PRESTOLITE REPLC IGN	6 CYL	⊕	2010				18-5303	18-5403	18-5353	18-5433		
185 (4 bbl)	229/V-6	⊕	1983-1984	6330183 - 6919655	18-5262 18-5276	★ ☐	18-5303	18-5403	18-5353	18-5433		18-8801-1
175	262/V-6	⊕	1987	B527955 - B773242				18-5432	18-5396	18-5438		
175, 185, 4.3	262/V-6	⊕	1985-1993	6919656 - F000877	18-5274			18-5432	18-5396	18-5438		18-8810-1
185 (2bbl)	262/V-6	⊕	1985-1987	6919656 - B527954				18-5432	18-5396	18-5438		
205	262/V-6	⊕	1985-1987	A331455 - B775129				18-5432	18-5396	18-5438		
205, 4.3LX 4bbl	262/V-6	⊕	1985-1996	A331455 - F802999	18-5274			18-5432	18-5396	18-5438		18-8810-1
262 TBI (GEN +)	262/V-6	⊕	1996-1997	F803800 - K999999						18-5443		18-8835-1
4.3L (2bbl)	262/V-6	⊕	1988-1996	B773243 - F802999				18-5432	18-5396	18-5438		
4.3L (2bbl) (GEN +)	262/V-6	⊕	1998-2010	L010044 & UP				18-5432	18-5396			
4.3L EFI (GEN +) (TBI)	262/V-6	⊕	1998	L012009 - L359999						18-5438		18-8835-1
4.3L EFI (GEN +) (TBI)	262/V-6	⊕	1999-2001	L360000 - M299999				18-5432	18-5396	18-5438		
4.3L MPI	262/V-6	⊕	2002-2010	M300000 & UP	18-5246			18-5245	18-5243		18-5350	18-8829-1
4.3LH (GEN +) (4bbl)	262/V-6	⊕	1998-2002	L010044 - M614999				18-5432	18-5396	18-5438		
4.3LX (4bbl)	262/V-6	⊕	1988-1996	B775130 - F802999				18-5432	18-5396	18-5438		
4.3LX (GEN +) (2bbl)	262/V-6	⊕	1996-1997	F803000 - K999999				18-5432	18-5396	18-5438		
4.3L/LH/LX/LXH	V6	⊕	1996-2001	F803000 & UP	18-5274			18-5432	18-5396	18-5438		18-8810-1
Alpha(Gen+)												
4.3L/LH/LX/LXH	V6	⊕	1996-2001	F803000 & UP	18-5274			18-5432	18-5396	18-5438		18-8810-1
Bravo(Gen+)												
4.3L EFI 262	V6	⊕	1996-1998	F803000 - L359999	18-5278			18-5408	18-5362	18-5443		18-8810-1
Mag(TBI)(Gen+)												
4.3L EFI(TBI)	V6	⊕	1996 & up	L012009 - L359999	18-5278			18-5408	18-5362	18-5443	18-5476	18-8835-1
(Gen+)					L360000 & UP	18-5274		18-5432	18-5396	18-5438		18-8835-1
4.3L EFI(TBI)	V6	⊕	1999-2001	L360000 & UP	18-5274			18-5432	18-5396	18-5438		18-8810-1
215 MCM & MIE (FORD)	302/V-8	⊕	1970-1972	2781153 - 3563181	18-5253 18-5267	★ ☐	18-5318	18-5402	18-5389	18-5433	18-5495-1 18-5309	18-8803-2
215 MCM & MIE (FORD)	302/V-8	⊕	1970-1972	2781153 - 3563181	18-5251 18-5271	★ ☐	18-5314	18-5404-1	18-5376	18-5433	18-5495-1 18-5309	18-5296-2 18-8803-2
225 MCM & MIE (FORD)	302/V-8	⊕	1973-1974	3385721 - 4166999	18-5253 18-5267	★ ☐	18-5318	18-5420	18-5389	18-5433	18-5495-1 18-5309	18-8803-2
225 MCM & MIE (FORD)	302/V-8	⊕	1973-1974	3385721 - 4166999	18-5251 18-5271	★ ☐	18-5314	18-5404-1	18-5376	18-5433	18-5495-1 18-5309	18-5296-2 18-8803-2
225 MCM & MIE (FORD)	302/V-8	⊕	1973-1974	3385721 - 4166999	18-5254 18-5267	★ ☐	18-5317	18-5420	18-5389	18-5433	18-5495-1 18-5309	18-8803-2
888 (FORD)	302/V-8	⊕	1971-1977	3108723 - 4887829	18-5254		18-5317	18-5420	18-5389	18-5433	18-5495-1 18-5309	18-8803-2
888 (FORD)	302/V-8	⊕	1971-1977	3108723 - 4887829	18-5253		18-5318	18-5420	18-5389	18-5433	18-5495-1	18-8803-2
888 (FORD)	302/V-8	⊕	1971-1977	3108723 - 4887829	18-5258 18-5277	★ ☐	18-5303	18-5407	18-5369	18-5433	18-5495-1 18-5309	18-8803-2
888 (FORD)	302/V-8	⊕	1971-1977	3108723 - 4887829	18-5251 18-5271	★ ☐	18-5314	18-5404-1	18-5376	18-5433	18-5495-1 18-5309	18-5298 18-8803-2
190 (GM 283)	283/V-8	⊕	1963-1964	1564539 - 1730903	18-5252		18-5310	18-5417	18-5384	18-5438	18-5498-1 18-5494-1	N/A 18-8803-2
											18-5313	18-8803-2

- ⊕ Mallory Ignition
- ⊕ Prestolite
- ⊕ Autolite
- ⊕ Mercury Ignition
- ⊕ Holley
- ⊕ Thunderbolt IV
- ⊕ With screw down cap
- ⊕ Delco
- ⊕ Electronic dist. (std rotation) excluding Thunderbolt ignition
- ⊕ Delco EST
- ⊕ Delco digital system
- ★ With out dist cap
- ☐ With dist cap
- ☐ Mercury HEI
- ☐ Delco HEI
- ⬆ Thunderbolt V
- ⬆ Prestolite with clip down dist cap
- ⊕ Contact controlled dist. (Std. Rotation) excl. Thunderbolt ign.

Model	CYL	Type of Ignition	Year	Serial #	Tune-Up Kit	Contact Set	Rotor	Dist. Cap	Coil	Distributor	Electronic Conv. Kit	Spark Plug Wires
198 MIE	305/V-8	⊙	1977	4776402 - 4931099		18-5314	18-5404-1		18-5433			
200 (5.0L)	305/V-8	⊙	1985-1995	6899058 - F600999			18-5431	18-5395	18-5438			
228	305/V-8	⊙	1977-1982	4765100 - 6218461		18-5314	18-5401-1		18-5433			
228	305/V-8	⊙	1982-1984	6218462 - 6899268			18-5431	18-5395	18-5438			
228 MIE	305/V-8	⊙	1977-1980	4765100 - 5907057		18-5314	18-5401-1		18-5433			
228 MCM & MIE	305/V-8		1977-1984	4765100 - 6218461	18-5251 ★	18-5314	18-5404-1	18-5376	18-5433	⊙	18-5296-2	18-8803-2
					18-5271 ☐					18-5498-1 ⊙		
228	305/V-8		1985-1986	6218462 - 6899268	18-5273		18-5431	18-5395	18-5438	18-5494-1 ⊙		18-8804-1
										18-5498-1 ⊙		
230, 5.0L/LX MIE	305/V-8		1981-1995	5907058 - F600999	18-5273		18-5431	18-5395	18-5438	18-5494-1 ⊙		18-8804-1
										18-5498-1 ⊙		
198, 898 MCM &	305/V-8		1977-1982	4776402 - 6218461	18-5251 ★	18-5314	18-5404-1	18-5376	18-5433	18-5494-1 ⊙	18-5296-2	18-8803-2
					18-5271 ☐					18-5498-1 ⊙		
230	305/V-8	⊙	1985-1987	6899269 - MB773739			18-5431	18-5395	18-5438			
230 MIE	305/V-8	⊙	1981-1987	5907058 - B788151			18-5431	18-5395	18-5438			
5.0L (Gen+)	305/V-8	⬆	1998-2010	L015751 & UP			18-5431	18-5395	18-5438			
5.0L EFI (Gen+)	305/V-8	⊙	1998	L012052 - L331630	18-5281		18-5405	18-5354	18-5442	18-5494-1 ⊙		18-8836-1
										18-5498-1 ⊙		
5.0L EFI (Gen+)	305/V-8	⊙	1998	L331651 - L339999					18-5442			
5.0L EFI (Gen+)	305/V-8	⊙	1999	L331631 - L331650			18-5431		18-5438			
5.0L MPI	305/V-8	⊙	2002-2010	M300000 & UP								18-8828-1
5.0L MIE	305/V-8	⊙	1988	B788152 - C396832			18-5431	18-5395	18-5438			
5.0LX	305/V-8	⊙	1988-1995	B773740 - F600999			18-5431	18-5395				
898	305/V-8	⊙	1977-1982	4762210 - 621461		18-5314	18-5404-1		18-5433			
898	305/V-8	⊙	1983-1984	6218462 - 6899057			18-5431	18-5395	18-5438			
350MAG MPI	V8		1998-2001	L302200 & UP	18-5273		18-5431	18-5395	18-5438	18-5494-1		
(Gen+) & MIE(Gen+)										18-5498-1		
350 MAG MPI	V8		2001-2004	M300000 & UP	18-5247		18-5245	18-5244		18-5351		
350 MAG MPI					18-5247		18-5245	18-5244				
HORIZON												
350 MAG	V8		1999-2001	L304700 & UP	18-5273		18-5431	18-5395	18-5438	18-5494-1		
HORIZON MIE										18-5498-1		
350 MAG HORIZON	V8		2001-2004	M300000 & Up	18-5247		18-5245	18-5244		18-5351		
MIE												
350MAG MPI	V8		1999-2001	L304600 & up	18-5273		18-5431	18-5395	18-5438	18-5494-1		
SKI(Gen+)										18-5498-1		
350MAG SKI	V8		1991-1996	D505450 - K040399	18-5273		18-5431	18-5395	18-5438	18-5494-1		
										18-5498-1		
350MAG SKI	V8		1991-1996	D505450 - K040399	18-5273		18-5431	18-5395	18-5438	18-5494-1		
										18-5498-1		
350MAG SKI	V8		1991-1997	D505450 - K999999	18-5273		18-5431	18-5395	18-5438	18-5494-1		
										18-5498-1		
225 (GM)	327/V-8	⊙	1963-1969	1539620 - 2694014	18-5252 ★	18-5310	18-5417	18-5384	18-5433	18-5494-1 ⊙		18-8803-2
					18-5270 ☐					18-5498-1 ⊙		
										18-5313 ⚡		
225 MIE (GM)	327/V-8	⬆	1968	2278647 - 2694014	18-5282		18-5420	18-5389		18-5494-1 ⊙		18-8803-2
										18-5498-1 ⊙		
250 MCM & MIE	327/V-8	⬆	1968-1969	2314301 - 2639854	18-5282		18-5420	18-5389		18-5494-1 ⊙		18-8803-2
										18-5498-1 ⊙		
250	350/V-8	⊙	1977	4768000 - 4908849	18-5251 ★	18-5314	18-5404-1	18-5376	18-5433	18-5494-1 ⊙	18-5296-2	18-8803-2
					18-5271 ☐					18-5498-1 ⊙		
250 MCM & MIE (GM)	350/V-8	⊙	1975-1976	3258728 - 4521254		18-5317	18-5420	18-5389	18-5433			
255 MCM (GM)	350/V-8	⊙	1976	4498701 - 4767999		18-5314	18-5404-1		18-5433			
255 MIE	350/V-8	⊙	1976-1980	4498701 - 5907057		18-5314	18-5404-1					
260	350/V-8	⊙	1978-1982	4908850 - 6218461		18-5314	18-5404-1		18-5433			
270 MCM & MIE	350/V-8	⬆	1969-1972	2851074 - 3385720	18-5282		18-5420	18-5389	332-4895A 8	18-5494-1 ⊙		18-8803-2
										18-5498-1 ⊙		
280 TRS	350/V-8	⊙	1975	4176250 - 4499390		18-5317	18-5420	18-5389	18-5433			
280 TRS	350/V-8	⊙	1976	4499391 - 4770199	18-5251 ★	18-5314	18-5404-1	18-5376	18-5433	18-5494-1 ⊙	18-5296-2	18-8803-2
					18-5271 ☐					18-5498-1 ⊙		
										18-5313 ⚡		
300	350/V-8	⊙	1985-1986	6668677 - B430367			18-5431	18-5395	18-5438			
320 EFI	350/V-8	⊙	1987-1989	A543604 - C622418			18-5431	18-5395	18-5438			
350 MAG ALPHA	350/V-8	⊙, ⬆	1986-1997	A635178 - K999999			18-5431	18-5395	18-5438			
350 MAG ALPHA EFI (Gen+)	350/V-8	⊙	1996-1997	F800300 - K999999	18-5281		18-5405	18-5354	18-5442	18-5494-1 ⊙		18-8836-1
350 MAG BRAVO MPI	350/V-8	⊙	1995-1997	F415189 - K999999			18-5354	18-5443	18-5443	18-5498-1 ⊙		18-8836-1
350 MAG EFI SKI	350/V-8	⊙	1994-1997	F215561 - K999999			18-5354	18-5443				18-8832-1
350 MAG MPI (Gen+)	350/V-8	⊙	1998	L010019 - L325962	18-5281		18-5405	18-5354	18-5442	18-5494-1 ⊙		18-8832-1
										18-5498-1 ⊙		
350 MAG MPI (Gen+)	350/V-8	⬆	1999-2001	L325953 - M999999			18-5431	18-5395	18-5438			
350 MAG MPI	350/V-8	⊙	2002-2010	M300000 & UP					18-5244			18-8828-1
350 MAG MPI HORIZON	350/V-8	⊙	2002-2007	M300000 - A299999					18-5244			
350 MAG MPI HORIZON MIE	350/V-8	⬆	1999-2001	L304700 - M299999			18-5431	18-5395	18-5438			
350 MAG MPI HORIZON MIE	350/V-8	⊙	2002-2007	M300000 - A089999					18-5244			
350 MAG MPI MIE (Gen+)	350/V-8	⊙	1998	L002008 - L302199	18-5281		18-5405	18-5354	18-5443	18-5494-1 ⊙		18-8832-1
										18-5498-1 ⊙		
350 MAG MPI MIE (Gen+)	350/V-8	⬆	1998-2001	L302200 - M299999	18-5273		18-5431	18-5395	18-5438			18-8834-1
350 MAG MPI MIE	350/V-8	⊙	2002-2007	M300000 - A089999					18-5244			18-8828-1
350 MAG MPI SKI	350/V-8	⊙	1995-1998	F350583 - L304599	18-5281		18-5405	18-5354	18-5443	18-5494-1 ⊙		18-8836-1
										18-5498-1 ⊙		
350 MAG MPI SKI (Gen+)	350/V-8	⬆	1999-2001	L304600 - M299999			18-5431	18-5395	18-5438			
350 MAG MPI SKI	350/V-8	⊙	2002-2007	M300000 - A089999					18-5244			18-8828-1
350 MAG SKI	350/V-8	⊙, ⬆	1991-1997	D505450 - K999999			18-5431	18-5395	392-805570A 2			
350MAG BRAVO	V8		1995-1998	F415189 - L325952	18-5281		18-5405	18-5354	18-5443	18-5494-1 ⊙		18-8836-1
MPI & (Gen+)										18-5498-1 ⊙		
350MAG EFI SKI	V8		1996-1997	F820707 - K999999	18-5281		18-5405	18-5354	18-5443	18-5494-1 ⊙		18-8832-1
& (Gen+)										18-5498-1 ⊙		
5.0L Alpha & Bravo (Gen+)	V8		1998-2001	L015751 & up	18-5273		18-5431	18-5395	18-5438	18-5494-1 ⊙		18-8821-1
										18-5498-1 ⊙		
5.0L EFI (Gen+)	V8		1999-2001	L331631 & up	18-5273		18-5431	18-5395	18-5438	18-5494-1 ⊙		18-8834-1
										18-5498-1 ⊙		
5.0L MCM/MIE MPI,	V8		2001 & up	M300000 & UP	18-5247		18-5245	18-5244		18-5351		18-8828-1
198, 898, 5.0L GM	V8		1983-1984	6218462 - 6899057	18-5273		18-5431	18-5395	18-5438	18-5494-1		18-8804-1

- ⊙ Mallory Ignition
- ⊙ Prestolite
- ⊙ Autolite
- ⊙ Mercury Ignition

Model	CYL	Type of Ignition	Year	Serial #	Tune-Up Kit	Contact Set	Rotor	Dist. Cap	Coil	Distributor	Electronic Conv. Kit	Spark Plug Wires
(305cid)										18-5498-1		
200, 5.0L GM	V8		1985-1995	6218462 - F600999	18-5273		18-5431	18-5395	18-5438	18-5494-1		18-8804-1
(305cid)										18-5498-1		18-8834-1
200, 5.0L GM	V8		1987-1995	B525982 - F600999	18-5273		18-5431	18-5395	18-5438	18-5494-1		
(305cid)										18-5498-1		
5.7L	350/V-8	⊕, ▲	1988-2010	6218462 & UP			18-5431	18-5395				18-8828-1
5.7L EFI	350/V-8	⊕	1995-1997	F225560 - K999999				18-5354				18-8828-1
5.7L EFI (GEN +)	350/V-8	⊕	1998	L010035 - L325976				18-5354	18-5442			
5.7L EFI (GEN +)	350/V-8	⊕	1998	L326000 - L331598				18-5354	18-5442			
5.7L EFI (GEN +)	350/V-8	⊕	1998	L336000 - L339999				18-5354	18-5442			
5.7L EFI (GEN +)	350/V-8	⊕	1999	L325977 - L325999			18-5431	18-5395	18-5438			
5.7L EFI (GEN +)	350/V-8	⊕	1999	L331599 - L331991			18-5431	18-5395	18-5438			
5.7L EFI (GEN +)	350/V-8	⊕	1999	L335716 - L335999			18-5431	18-5395	18-5438			
5.7L EFI (GEN +)	350/V-8	⊕	1999-2001	L340000 - M299999			18-5431	18-5395	18-5438			
5.7L EFI MIE (GEN +)	350/V-8	⊕	1997	K040300 - K999999					18-5442			
5.7L MIE	350/V-8	⊕, ▲	1988-2010	B788152 & UP			18-5431	18-5395				
5.7L MPI HORIZON MIE	350/V-8	⊕	2008-2010	A090000 & UP				18-5244				18-8821-1
5.7L MPI MIE	350/V-8	⊕	2008-2010	A090000 & UP				18-5244				
5.7L MPI SKI	350/V-8	⊕	2008-2010	A090000 & UP				18-5244	18-5433			18-8821-1
5.7L SKI	350/V-8	⊕	1985-1995	A338553 - F775199	18-5251	★	18-5314	18-5404-1	18-5376	18-5433	18-5494-1 ⊕	18-5296-2
					18-5271	⊕					18-5498-1 ⊕	
5.7L SKI	350/V-8	⊕	1985-1996	A338553 - F775199	18-5262	★	18-5303	18-5403	18-5352	18-5433	18-5494-1 ⊕	18-5299
					18-5275	⊕					18-5498-1 ⊕	18-8802-1
5.7L SKI	350/V-8	⊕, ▲	1987-2010	B514627 & UP			18-5431	18-5395				
5.7LX	350/V-8	▲	1995-1997	F601000 - K999999			18-5431	18-5395	18-5438			
5.7LX BRAVO EFI (GEN +)	350/V-8	⊕	1996-1997	F800300 - K999999				18-5354				
5.7LX EFI	350/V-8	⊕	1996-1997	F752400 - K999999	18-5281		18-5405	18-5354	18-5442	18-5494-1 ⊕		18-8836-1
										18-5498-1 ⊕		
5.7L MIE & SKI	V8		1998 & up	L002003 & up	18-5273	★	18-5431	18-5395	18-5438			18-8830-1
5.7L EFI & (Gen+)	V8		1995-1998	F225560-L339999	18-5281	⊕	18-5405	18-5354	18-5442	18-5494-1 ⊕		18-8836-1
												18-5498-1 ⊕
5.7L EFI & (Gen+)	V8		1999-2001	L325977 & UP	18-5273		18-5431	18-5395	18-5438	18-5494-1 ⊕		18-8834-1
										18-5498-1 ⊕		
5.7L SKI	V8		1987-1997	B514627 - K999999	18-5273		18-5431	18-5395	18-5438	18-5494-1 ⊕		18-8821-1
										18-5498-1 ⊕		
5.7L SKI	V8		1987-1995	B514627 - F775199	18-5273		18-5431	18-5395	18-5433	18-5494-1 ⊕		18-8821-1
										18-5498-1 ⊕		
5.7L SKI	V8		1998-2001	L002005 & up	18-5273		18-5431	18-5395	18-5438	18-5494-1 ⊕		18-8821-1
										18-5498-1 ⊕		
260, 350MAG, 5.7L SKI/ ALPHA/ BRAVO(350cid)	V8		1987-1995	B525982 - F600999	18-5273		18-5431	18-5395	18-5438	18-5494-1		18-8804-1
										18-5498-1		
260, 350MAG, 5.7L ALPHA/ BRAVO(350cid)	V8		1987-1995	B525982 - F600999	18-5273		18-5431	18-5395	18-5438	18-5494-1		18-8821-1
										18-5498-1		
350MAG, 5.7L/ LX ALPHA &	V8		1994-2001	F353525 & UP	18-5273		18-5431	18-5395	18-5438	18-5494-1		18-8821-1
										18-5498-1		
BLACK SCORPION SKI (GEN +)	350/V-8	⊕	1996-2003	F800000 - M391599				18-5354	18-5443			18-8832-1
BLACK SCORPION SKI (GEN +)	350/V-8	⊕	2003-2007	M391600 - W698432				18-5395				
SCORPION 350	350/V-8	⊕	2008-2010	W698433 & UP				18-5395				
BLACK SCORPION SKI(Gen+) (350cid)	V8		1996	F800000 - K040000	18-5281		18-5405	18-5354	18-5443	18-5494-1		18-8832-1
										18-5498-1		
BLACK SCORPION SKI(Gen+) (350cid)	V8		1997-1998	K040001 - L005600	18-5281		18-5405	18-5354	18-5443	18-5494-1		18-8824-1
										18-5498-1		
BLACK SCORPION SKI(Gen+) (350cid)	V8		1998-2002	L005601 - M391599	18-5281		18-5405	18-5354	18-5443	18-5494-1		18-8822-1
										18-5498-1		
233 MCM & MIE (FORD)	351/V-8	⊕	1975-1977	4173000 - 4902304	18-5260	★	18-5303	18-5409	18-5352	18-5433	18-5489	18-5299
					18-5275	⊕					18-5312	
233 MCM & MIE (FORD)	351/V-8	♥	1975-1977	4173000 - 4902304	18-5258	★	18-5303	18-5407	18-5369	18-5433	18-5489	18-5298
					18-5277	⊕					18-5312	
233 MCM & MIE (FORD)	351/V-8	⊕	1975-1977	4173000 - 4902304	18-5254		18-5317	18-5420	18-5389	18-5433	18-5489	18-8803-2
											18-5312	
255 MCM & MIE	351/V-8		1973-1974	3385721 - 4166999	18-5254		18-5317	18-5420	18-5389	18-5433	18-5489	18-8803-2
											18-5312	
255 MCM & MIE	351/V-8		1973-1974	3385721 - 4166999	18-5251		18-5314	18-5404-1	18-5376	18-5433	18-5489	18-5296-2
					18-5271						18-5312	18-8803-2
255 MIE & MCM (FORD)	351/V-8	⊕	1973-1980	3258728 - 5907057			18-5314	18-5404-1		18-5433		
255 MIE & MCM (FORD)	351/V-8	⊕	1973-1980	3258728 - 5907057				18-5420	18-5389	18-5433		
255, 260MCM & MIE(350cid)	V8		1975-1982	3258728 - 6218461	18-5251		18-5314	18-5404-1	18-5376	18-5433	18-5494-1 ⊕	18-5296-2
					18-5271						18-5498-1 ⊕	18-8803-2
											18-5313	
255MCM & MIE (350cid)	V8		1975-1980	4498701 - 5907057	18-5254		18-5317	18-5420	18-5389	18-5433	18-5494-1 ⊕	18-8803-2
											18-5498-1 ⊕	
											18-5313	
260,350MAG,	V8		1982-1994	6218462 - F600999	18-5273		18-5431	18-5395	18-5438	18-5494-1 ⊕		18-8804-1
										18-5498-1 ⊕		
											18-5313	
300, 320EFI	350/V-8		1985-1989	A543604 - C622418	18-5273		18-5431	18-5395	18-5438	18-5494-1 ⊕		18-8804-1
										18-5498-1 ⊕		
377 MAG	377/V-8	⊕	2008-2010	A300000 & UP				18-5244				
377 SCORPION MCM	377/V-8	⊕	1999-2005	L416146 - M907201	18-5281		18-5405	18-5354	18-5443	18-5494-1 ⊕		
										18-5498-1 ⊕		
377 SCORPION SKI	377/V-8		1997-1998	K000656 - L00314	18-5281		18-5405	18-5354	18-5443	18-5494-1 ⊕		
										18-5498-1 ⊕		
MX 6.2L MPI	377/V-8	⊕	2000-2001	L680003 - M299999	18-5273		18-5431	18-5395	18-5438	18-5494-1 ⊕		18-8834-1
										18-5498-1 ⊕		
MX 6.2L MPI (377CID)	377/V-8	⊕	2002-2007	M300000 - A299999	18-5247		18-5245	18-5244				18-8828-1
MX 6.2L MPI	377/V-8	⊕	2001-2004	M300000 & UP	18-5247		18-5245	18-5244		18-5351		18-8828-1
MX 6.2L MPI HORIZON	377/V-8	⊕	2002-2007	M300000 - A299999	18-5247		18-5245	18-5244		18-5351		18-8828-1
MX 6.2L MPI HORIZON MIE	377/V-8	⊕	2002-2010	M300000 & UP	18-5247		18-5245	18-5244		18-5351		18-8828-1
MX 6.2L MPI MIE	377/V-8	⊕	2000-2001	L670000 - M299999			18-5431	18-5395	18-5438			
MX 6.2L MPI MIE	377/V-8	⊕	2002-2010	M300000 - & UP				18-5244				18-8828-1
MX 6.2L MPI SKI	377/V-8	⊕	2002-2007	M317000 - A089999	18-5247		18-5245	18-5244				18-8828-1
MX 6.2L BLACK SCORPION SKI	377/V-8	⊕	2001-2003	F800000 - M391599				18-5354				N/A

- ⊕ Mallory Ignition
- ⊕ Prestolite
- ⊕ Autolite
- ⊕ Mercury Ignition
- ⊕ Holley
- ⊕ Thunderbolt IV
- ⊕ With screw down cap
- ⊕ Delco
- ⊕ Electronic dist. (std rotation) excluding Thunderbolt ignition
- ⊕ Delco EST
- ⊕ Delco digital system
- ★ With out dist cap
- ⊕ With dist cap
- ⊕ Mercury HEI
- ⊕ Delco HEI
- ▲ Thunderbolt V
- ♥ Prestolite with clip down dist cap

Model	CYL	Type of Ignition	Year	Serial #	Tune-Up Kit	Contact Set	Rotor	Dist. Cap	Coil	Distributor	Electronic Conv. Kit	Spark Plug Wires
MX 6.2L BLACK SCORPION SKI	377/V-8	☉	2003-2007	M391600 - W698432				18-5395				
SCORPION 377	377/V-8	☉	2008-2010	W698433 & UP				18-5395				
325 MCM & MIE	427/V-8	☉	1969-1974	2278747 & UP	18-5282		18-5420	18-5389		18-5494-1 ☉		18-8803-2
										18-5498-1 ☉		
330 MCM & MIE	454/V-8	☉	1977-1981	4623115-6083144	18-5251 ★ 18-5271 ☽	18-5314	18-5404-1	18-5376	18-5433	18-5494-1 ☉	18-5296-2	18-8803-2
										18-5498-1 ☉		
										18-5313 ☉		
330 MCM & MIE	454/V-8	☉	1977-1981	4623115-6083144	18-5282		18-5420	18-5389		18-5494-1 ☉		18-8803-2
										18-5498-1 ☉		
										18-5313 ☉		
330	454/V-8	☉	1982-1987	6083145 - B816540			18-5431	18-5395	18-5438			
330, 340, 7.4L	454/V-8	☉	1981-1992	5889914 - D715493	18-5273		18-5431	18-5395	18-5438	18-5494-1 ☉		18-8804-1
MCM & MIE(454cid)										18-5498-1 ☉		
340 MIE	454/V-8	☉	1981-1987	5889914 - B788365			18-5431	18-5395	18-5438			
350 MIE	454/V-8	☉	1974-1976	3780450 - 4623109	18-5282		18-5420	18-5389		18-5494-1 ☉		18-8803-2
										18-5498-1 ☉		
370 TRS	454/V-8	☉	1978-1985	4179554 - 6721527	18-5251 ★ 18-5271 ☽	18-5314	18-5404-1	18-5376	18-5433	18-5494-1 ☉	18-5296-2	18-8803-2
										18-5498-1 ☉		
										18-5313 ☉		
370 TRS	454/V-8	☉	1978-1985	4883520 - 6721527	18-5254	18-5317	18-5420	18-5389	18-5433	18-5494-1 ☉		18-8803-2
										18-5498-1 ☉		
										18-5313 ☉		
370 TRS	454/V-8	☉	1985-1987	6721528 - B714586	18-5273		18-5431	18-5395	18-5433	18-5494-1 ☉		18-8804-1
										18-5498-1 ☉		
400 TRS	454/V-8	☉	1980-1986	5668232 - B457644		18-5314	18-5404-1		18-5433			
400 TRS	454/V-8	☉	1980-1986	5668232 - B457644		18-5317		18-5389	18-5433			
420	454/V-8	☉	1987-1989	A398941 - B622418	18-5273		18-5431	18-5395	18-5438	18-5494-1 ☉		18-8837-1
										18-5498-1 ☉		
425	454/V-8	☉	1990-1993	B622419 - D937011			18-5431	18-5395	18-5438			18-1837-1
440 TRS	454/V-8	☉	1983-1986	6181070 - B485220		18-5314	18-5404-1		18-5433			
450	454/V-8	☉	1995-1996	F347100 - F347277	18-5273		18-5431	18-5395	18-5438	18-5494-1 ☉		
										18-5498-1 ☉		
454 MAG ALPHA	454/V-8	☉	1986-1997	A631894 - B785148	18-5273		18-5431	18-5395	18-5438	18-5494-1 ☉		18-8804-1
										18-5498-1 ☉		
454 MAG BRAVO	454/V-8	☉, ☽	1988-1997	B721206 - K999999			18-5431	18-5395	18-5438			
454 MAG EFI	454/V-8	☉	1994-1996	F115700 - F802349				18-5354	18-5443			18-8832-1
454 MAG MPI	454/V-8	☉	1996-1998	F802350 - L085009				18-5354	18-5443			18-8832-1
454 MAG MPI	454/V-8	☉	1998-2001	L085010 - M024999				18-5354	18-5443			18-8832-1
454 MAG MPI HORIZON MIE	454/V-8	☉	1998-2001	L002200 - L674000	18-5281		18-5405	18-5354	18-5443	18-5494-1 ☉		
										18-5498-1 ☉		
454-EFI,MAG MPI & HORIZON MIE	454/V-8		1994-2001	F115700 & UP	18-5281		18-5405	18-5354	18-5443	18-5494-1 ☉		18-8832-1
										18-5498-1 ☉		
454 MAG MPI HORIZON MIE	454/V-8		1999-2001	L086001 - L674000	18-5281		18-5405	18-5354	18-5443	18-5494-1 ☉		18-8832-1
										18-5498-1 ☉		
454 MAG MPI SKI	454/V-8	☉	1995-1997	F215800 - K999999				18-5354	18-5443			18-8832-1
525 SC	454/V-8	☉, ☽	1991-1999	D456000 - L415623			18-5431	18-5395				
7.4L BRAVO	454/V-8	☉, ☽	1988-1997	B771113 - K999999			18-5431	18-5395				
7.4L MIE	454/V-8	☉, ☽	1988-1997	B788366 - K999999			18-5431	18-5395				
7.4L MPI (L29)	454/V-8	☉	1998-2001	L010003 - M024330				18-5354	18-5443			18-8832-1
7.4L MPI MIE	454/V-8	☉	1995-1997	F563052 - K999999				18-5354	18-5443			18-8832-1
7.4L MPI MIE (L29)	454/V-8	☉	1998-2001	L002006 - L674613				18-5354	18-5443			18-8832-1
7.4L TBI MIE	454/V-8	☉	1996-1997	F874815 - K999999				18-5354				N/A
7.4LX BRAVO EFI	454/V-8	☉	1996-1997	F820000 - K999999				18-5354	18-5443			18-8832-1
7.4LX BRAVO MPI	454/V-8	☉	1996-1997	F602010 - K999999				18-5354	18-5443			18-8832-1
390	482/V-8	☉	1969-1970	2781129 - 2825059	18-5282		18-5420	18-5389				18-8803-2
460 TRS	482/V-8	☉	1983-1986	6180970 - 6181046	18-5251	18-5314	18-5404-1	18-5376	18-5433	18-5494-1 ☉	18-5296-2	18-8803-2
										18-5498-1 ☉		
										18-5313 ☉		
460 TRS	482/V-8	☉	1983-1986	6180970 - 6181046	18-5254	18-5317	18-5420	18-5389	18-5433	18-5494-1 ☉		18-8803-2
										18-5498-1 ☉		
										18-5313 ☉		
465	V8		1992-1994	D763732 - F213244	18-5273		18-5431	18-5395	18-5438			18-8837-1
496 / 8.1L	V8		2000 & Up	M025000 & UP			N/A					18-8838-1
500	502/V-8	☉, ☽	1994-1999	F213293 - L601036	18-5273		18-5431	18-5395	18-5438			18-8837-1
500 EFI	502/V-8	☉	1998-2005	L001477 - M907127				18-5354	18-5443			
502 MAG	502/V-8	☉	1990-1993	C878221 - F114528	18-5273		18-5431	18-5395	18-5438			18-8804-1
502 MAG EFI	502/V-8	☉	1993-1996	D840650 - F802599				18-5354	18-5443			18-8832-1
502 MAG MPI	502/V-8	☉	1996-1998	F802600 - L085000				18-5354	18-5443			18-8832-1
500(Gen+)	502/V-8		1999	L414639 - L601036	18-5273		18-5431	18-5395	18-5438			18-8837-1
500GM EFI	502/V-8		1998-2000	0L001477 & up	18-5281		18-5405	18-5354	18-5443			
502 MAG MPI	502/V-8		1993-1998	D840650 - L085000	18-5281		18-5405	18-5354	18-5443			18-8832-1
502GM MAG	502/V-8		1998-2001	L085001 & up	18-5281		18-5405	18-5354	18-5443			18-8832-1
8.2L GM MPI MIE	502/V-8		1996-2001	F819820 & up	18-5281		18-5405	18-5354	18-5443			18-8832-1
8.2L GM MPI MIE	502/V-8		1990-1996	C878221 - F819619	18-5273		18-5431	18-5395	18-5438			18-8804-1
525 SC	502/V-8		1991-1995	0D456000-F87734	18-5273		18-5431	18-5395	18-5438			18-8804-1
525 SC	502/V-8		1996-1999	0K000012 & up	18-5273		18-5431	18-5395	18-5438			18-8837-1
575 SCi	502/V-8	☉	2000-2005	L306696 - M950526				18-5354	18-5443			
575 SCi	502/V-8		2000-2005	L306696 & UP	18-5281		18-5405	18-5354	18-5443			
600 SC	502/V-8	☉, ☽	1991-2000	D456489 - L301186			18-5431	18-5395	18-5438			
600 SC	502/V-8		1991-1993	D456489 - D763876	18-5273		18-5431	18-5395	18-5438			18-8837-1
600 SC	502/V-8		1993-2001	D763876 & UP	18-5273		18-5431	18-5395	18-5438			18-8837-1
8.2L MIE	502/V-8	☉, ☽	1990-1996	C878221 - F819619			13524 T	18-5395	18-5438			
8.2L MPI MIE	502/V-8	☉	1996-1998	F819620 - L086012				18-5354	18-5443			
8.2L MPI MIE	502/V-8	☉	1998-2001	L086013 - L674200				18-5354	18-5443			
500 BULLDOG	540/V-8	☉, ☽	1990-2001	C577003 - M050281	18-5273		18-5431	18-5395	18-5438			18-8837-1
575	540/V-8	☉	1986-1992	A677429 - D763716			18-5431	18-5395	18-5438			
800 SC	572/V-8	☉, ☽	1993-1998	D763836 & UP	18-5273		18-5431	18-5395	18-5438			18-8837-1

- ☉ Mallory Ignition
- ☉ Prestolite
- ☉ Autolite
- ☉ Mercury Ignition
- ☉ Holley
- ☉ Thunderbolt IV
- ☉ With screw down cap
- ☉ Delco
- ☉ Electronic dist. (std rotation) excluding Thunderbolt ignition
- ☉ Delco EST
- ☉ Delco digital system
- ★ With out dist cap
- ☽ With dist cap
- ☉ Mercury HEI
- ☉ Delco HEI
- ☉ Thunderbolt V
- ☉ Prestolite with clip down dist cap
- ☉ Contact controlled dist. (Std. Rotation) excl. Thunderbolt ign.

PREMIUM MARINE SPARK PLUG WIRE LEADS

MAGFORCE™



OE Style boots provide a sealed barrier against heat, dirt and moisture.

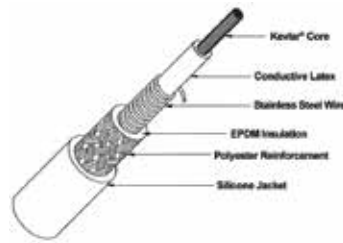

Premium Marine Wire Leads

Magnetic Suppression Core

Manufactured for your specific application

- Kevlar® core for maximum durability and long life.
- Durable stainless steel wound conductor for maximum horsepower and engine performance.
- Premium silicone jacketing and boots for the ultimate in high temperature protection.
- Superior RFI suppression for the most sensitive electronic system.
- Corrosion resistant stainless steel spark plug and distributor terminals for maximum conductivity.

O.E. #	Cyl.	Part #	O.E. #	Cyl.	Part #
84-816608Q81	8	18-8822-1	84-863656A2	V6	18-8829-1
84-847701A7	8	18-8837-1	84-813720A12, 84-816761Q12	8	18-8802-1
84-813720A2, 84-816608Q61	8	18-8804-1	84-813720A13, 84-816761Q13	4	18-8811-1
84-813720A3, 84-816761Q3	8	18-8804-1	84-816761A4, 84-816761Q4	8	18-8804-1
84-813720A3, 84-816761Q3	8	18-8821-1	84-816761A4, 84-816761Q4	8	18-8821-1
84-813720A4, 84-816761Q4	8	18-8821-1	84-816761A8, 84-816761Q8	L6	18-8809-1
84-813720A4, 84-816761Q4	8	18-8804-1	84-816761A9, 84-816761Q9	8	18-8803-2
84-813720A5, 84-816761Q5	4	18-8800-1	84-816761A17, 84-816761Q17	8	18-8821-1
84-813720A6, 84-816761Q6	4	18-8808-2	84-863656A1	8	18-8828-1
84-816761K14	L4	18-8833-1	84-816608Q80	8	18-8830-1
84-813720A7, 84-816761Q7	V6	18-8801-1	84-816608Q71	8	18-8836-1
84-813720A8, 84-816761Q8	L6	18-8809-1	84-816608K68	8	18-8832-1
84-813720A9, 84-816761Q9	8	18-8803-2	84-816608Q83	8	18-8834-1
84-813720A10, 84-816761Q10	8	18-8803-2	84-881698	8	18-8838-1
84-813720A11, 84-816761Q16	V6	18-8810-1	84-816608K68	8	18-8824-1
84-816608Q82	V6	18-8835-1			

Models	Cyl.	Ignition Type	Part #	Models	Cyl.	Ignition Type	Part #
ALL	4	Digital	18-8811-1	370	8	Conventional	18-8803-2
120 (153 CID)	4	Conventional	18-8800-1	400	8	Conventional	18-8803-2
140 (181 CID)	4	Conventional	18-8800-1	420	8	Thunderbolt	18-8804-1
150	L6	Conventional	18-8809-1	420	8	Thunderbolt	18-8837-1
160	L6	Conventional	18-8809-1	425	8	Thunderbolt	18-8837-1
165	L6	Conventional	18-8809-1	440	8	Conventional	18-8803-2
185 CID	V6	Conventional	18-8801-1	454 CID	8	Thunderbolt	18-8804-1
198 GM	8	Conventional	18-8803-2	454 MAG	8	Thunderbolt	18-8804-1
224 CID	4	Conventional	18-8808-2	454 EFI, Mag MPI and Horizin MIE	8	Delco HEI	18-8832-1
225 FORD	8	Conventional	18-8803-2	454 Hi Perf	8	Thunderbolt	18-8824-1
225 GM	8	Conventional	18-8803-2	460	8	Conventional	18-8803-2
228 GM	8	Conventional	18-8803-2	465	8	Thunderbolt	18-8837-1
229 CID	V6	Conventional	18-8801-1	496	8	Distributorless	18-8838-1
233 FORD	8	Conventional	18-8803-2	500	8	Thunderbolt	18-8837-1
250 GM	8	Conventional	18-8803-2	500 Bulldog	8	Thunderbolt	18-8837-1
255 FORD	8	Conventional	18-8803-2	502 Mag	8	Delco HEI	18-8832-1
260 GM	8	Conventional	18-8803-2	502 EFI & Mag MPI	8	Delco HEI	18-8832-1
260 TR	8	Thunderbolt	18-8804-1	525SC	8	Thunderbolt	18-8837-1
262 CID	V6	Thunderbolt	18-8810-1	600SC	8	Thunderbolt	18-8837-1
280 GM	8	Conventional	18-8803-2	800SC	8	Thunderbolt	18-8837-1
305 CID LH	8	Thunderbolt	18-8804-1	888 FORD	8	Conventional	18-8803-2
305 CID RH	8	Thunderbolt	18-8804-1	898 GM	8	Conventional	18-8803-2
320 EFI	8	Thunderbolt	18-8804-1	2.5L	4	Conventional	18-8800-1
330	8	Conventional	18-8803-2	3.0L	4	Conventional	18-8800-1
330 TR	8	Thunderbolt	18-8804-1	3.0LX	4	Delco EST	18-8833-1
350 CID LH	8	Thunderbolt	18-8804-1	3.7L	4	Conventional	18-8808-2
350 CID RH	8	Thunderbolt	18-8804-1	3.7XL	4	Conventional	18-8808-2
350 MAG	8	Thunderbolt	18-8804-1	4.3L	V6	Thunderbolt	18-8810-1
350 MAG SKI	8	Thunderbolt	18-8821-1	4.3XL	V6	Thunderbolt	18-8810-1
350 MAG BRAVO MPI & GEN +	8	Delco HEI	18-8836-1	4.3L EFI(TBI)	V6	Thunderbolt	18-8810-1
350 MAG MPI MIE (GEN +)	8	Delco HEI	18-8832-1	4.3L MPI	V6	Delco HEI	18-8835-1
350 MAG MPI MIE (GEN +)	8	Mercury HEI	18-8834-1	5.0L	8	Thunderbolt	18-8804-1
350 MAG EFI SKI	8	Delco HEI	18-8832-1	5.0L IB	8	Thunderbolt	18-8804-1
350 MAG MPI SKI (GEN +)	8	Delco HEI	18-8836-1	5.0LX	8	Thunderbolt	18-8804-1
BLACK SCORPION SKI (GEN+) 350CID	8	Delco HEI	18-8832-1	5.0L Alpha & Bravo (Gen+)	8	Thunderbolt	18-8821-1
BLACK SCORPION SKI (GEN+) 350CID	8	Delco HEI	18-8822-1	5.0L MIE MPI	8	Delco HEI	18-8828-1
MX 6.2 BLACK SCORPION SKI	8	Delco HEI	18-8822-1	5.7L	8	Thunderbolt	18-8804-1
				5.7L IB	8	Thunderbolt	18-8804-1
				5.7L SKI	8	Conventional	18-8802-1
				7.4L	8	Thunderbolt	18-8804-1
				7.4L IB	8	Thunderbolt	18-8804-1

I/O — MERCRUISER - Ignition System



**18-5225
SPARK PLUG WIRE KIT**

Replaces:
Mercury 84-99215A26,
84-813706A26
Kit includes 25 ft. roll of 7 MM hypalon ignition wire with a metallic core and a large assortment of three different end fittings.



BATTERY CABLES

Part No.	Size	Color	Gauge	Part No.	Size	Color	Gauge
BC88523	2'	red	4	BC88573	6'	black	2
BC88533	2'	black	4	BC88583	8'	red	1
BC88543	4'	red	2	BC88593	8'	black	1
BC88553	4'	black	2				

BC88563 gauge cable with 5000 series lug terminals on each end to accept a 3/8" stud



**18-5226
IGNITION WIRE**
Metallic Core
100' Spool
7mm Hypalon

PKG. OF 10



**18-5224
18-5224-9①
SPARK PLUG WIRE
TERMINAL**
Replaces: Mercury 20121

PKG. OF 10



**18-5750
18-5750-9①
UNIVERSAL SPARK
PLUG BOOTS**
Supplied complete w/Terminal Connector



**18-5752
UNIVERSAL
SPARK PLUG BOOT**
8mm

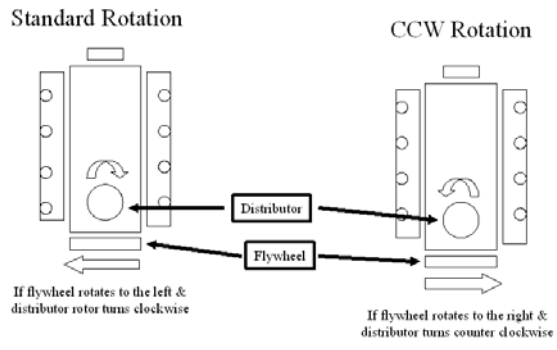

**18-6275
STARTER**
Replaces:
50-807904A1, 50-863007A1
• Permanent Magnet Gear Reduction Starter
• Inboard
• 2 Long Bolt Offset Pattern
• CW Rotation • **SAE J1171**
• Use w/ Late Model 3.0L Engines with 14" Flywheel
Fits : Volvo Penta, Mercruiser, Marine Power



**18-5603
STARTER**
Replaces: 50-808011A4
Noseless:CCW Top mount rear entry starter for standard rotation GM & Ford engines. Can be used in place of 18-5908 and 18-5902



**18-5923
STARTER**
PMGR Replacement for 18-5903;
302CID, 351CID Ford Engines



**18-5911
STARTER**
(Heavy-Duty) (No Core) (Clockwise) For GM engines, bottom mount straight across bolt pattern. Standard rotation
Replaces: 50-76965A4,50-99417A2,50-99419A3, 50-17251A3, 50-77328A3
Replacement Solenoid: 18-5837
SAEJ1171



**18-5900
REMANUFACTURED STARTER**



**18-5907
STARTER**
(Heavy-Duty) (No Core) (Clockwise) Top mount rear entry starter for opposite rotation GM & Ford engines.
Will also replace standard rotation. Will not replace non-starter mounted solenoids.
Mercuriser built 4 cyl. 165/170/180/190/470/485/488
Replaces: 50-72550A2, 50-79604A3, 50-97499A2, R4, 50-72550R2, 50-97499R3
Replacement Solenoid: 18-5837
SAEJ1171



**18-5901
REMANUFACTURED STARTER**



**18-5913
STARTER**
(Clockwise)
Delco permanent magnet gear reduction 2 bolt starter
12V - 11 Tooth - Offset Bolt Pattern
For: Late model GM - 14" Flywheel
Replaces: 50-812428A3, 50-812604A2,
50-822330A2, 50-864340A2
Replacement Solenoid: 18-6287
SAEJ1171 FOR: 4.3L (1996 & UP); 5.0 & 5.7L (1998 & UP)



**18-5919
STARTER**
Permanent magnet I/O starter, 11 Tooth
Replaces: 50-806963A4, 50-806965A2, 50-806965A4
Replacement Solenoid: 18-6287
Fits: Chevy Engines with 12 3/4" flywheels
Straight across bolt pattern
SN-OF803000AN/OF803114AN 4.3LX/LXH Alpha/Bravo 262 CID
SN-355305AN/22560AN 5.7L Alpha (EFI)/5.7L Bravo (EFI)
SAEJ1171



**18-5910
STARTER**
(Heavy-Duty) (No Core) (Clockwise) Small block V-6 & V-8 GM engine with 14 1/4" flywheel and bottom mount, offset bolt pattern. For standard rotation engines.
Replaces: 50-12177A2, 50-99418A2



**18-5905
REMANUFACTURED STARTER**



**18-5908
STARTER**
(Heavy-Duty) (No Core) (Counter-Clockwise)
Top mount rear entry starter for standard rotation GM & Ford engines.
Replaces: 50-76965A3, 50-808011A1
Replacement Solenoid: 18-5837
SAEJ1171



**18-5902
REMANUFACTURED STARTER**



NEW



**18-6824
STARTER**
Replaces: 50-60594A, A1, T01
Fits: 2.0, 2.4, and 2.5L Racing Engines

NEW



**18-6834
STARTER**
Replaces: GM Engines Universal
Used on Buick, Chevrolet, Oldsmobile, and Pontiac Race Engines

NEW



**18-6835
STARTER**
Replaces: GM Engines Universal
Used on Buick, Chevrolet, Oldsmobile, and Pontiac Race Engines

NEW



**18-6870
STARTER**
Replaces: Mercury 50-805833, T
Fits: D7.3L D-tronic 260 LD, 300 1999 year

NEW



**18-6946
STARTER**
Replaces: 50-8m8021116

NEW



**18-6947
STARTER**
Replaces: Mercruiser 50-805991
Fits: 7.3L (BRAVO & MIE) DIESEL NAV 444 V-8 1994-1996

NEW



**18-6949
STARTER**
Replaces: Mercruiser 50-831001562, 50-831001961
Fits: WO4CTA (150 HP) HINO 234 I/L4, WO4CTI (210 HP) HINO 234 I/L4

NEW



**18-6957
STARTER**
Replaces: Mercruiser 50-801333980, 50-854178, 50-855507



**18-5903
STARTER**
(No Core) (Clockwise) Bottom mount, two bolt pattern for standard rotation Ford engines.
Replaces: 50-69865A1, 50-12872, 50-56886
Replacement Solenoid: 18-5801
*For PMGR style order 18-5923



**18-2434
FLYWHEEL BELL HOUSING**
Replaces: 814309A1
For: GM V-8's Big & Small Blocks Inboard/Ski Models

STARTER BOLTS



Description	Mercuriser #	Part #
Starter Bolt 3/8 - 16 - 4 3/8 Long	10-8053432	18-8402
Starter Bolt 3/8 - 16 - 1 13/16 Long	10-8053433	18-8403
Starter Bolt 3/8 - 16 - 1 11/16 Long	10-8083434	18-8404-1



**18-5717
STARTER
BRUSH SET**
Replaces: 33270



**18-5804
SOLENOID**
Replaces: 13037
Delco



**18-5837
SOLENOID**
Replaces: 89-99253, 89-18080
Delco



**18-5838
SOLENOID**
Replaces: 33261, 89902
Delco



**18-5840
SOLENOID**
Prestolite 15-79,
SAW 4201, SAW4207, SAW4210

BRUSH SET/STARTER SWITCH APPLICATION

Years	Volt.	Starter No.	Brush Set	Starter Switch	Years	Volt.	Starter No.	Brush Set	Starter Switch
1977-82	12	1108755	18-5717	18-5838	1971-78	12	ALL	18-5717	18-5838
1977-82	12	1108756	18-5717	—	1969-78	12	MEO-7003	—	18-5840
1977-82	12	1109484,5,6	18-5717	18-5838					



① **18-5801D** Display Package

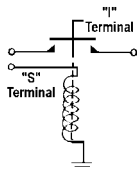

**18-5801
SOLENOID**
Replaces: 89-76416A1



① **18-5802D** Display Package

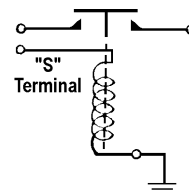

**18-5802
SOLENOID**
Replaces: 65057A1, 65057T1

① Items ending in "D" are Display Packaged - Regular number is Non-Display
APPLICATION BEGINS ON PAGE 605

① 18-5810D 

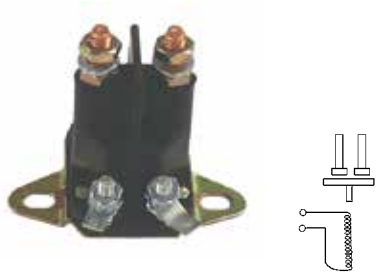

18-5810
SOLENOID



18-5811
STARTER SOLENOID
Replaces: 809463A1
For: PG 260 Series Starters, GM V6 & V8 (1983-Up)

① 18-5815D 



18-5815
SOLENOID
Replaces: 89-68258A4,
89-853654A1, 89-76545

① 18-5816D 

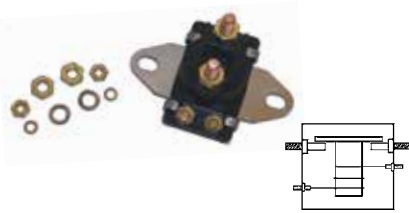

18-5816
SOLENOID
Replaces: 89-96054, T, 89-91975
(Flat Bracket)

① 18-5817D 

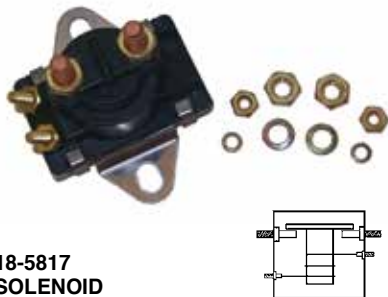

18-5817
SOLENOID
Replaces: 89-96158, T
(Curved Bracket)



18-5820
SOLENOID
Replaces: 89-818999A2,
89-825842A1, 89-850188T1

① 18-5836D 



18-5836
SOLENOID
Replaces: 25661, 25661 1



18-9802
TIMING LIGHT
Self-powered accurate up to 10,000 RPM's



18-6749
TRIM BRACKET
Metal Bracket
Replaces: 862548A1, 42419A1
For: MerCruiser Floor Mount Bracket



18-6750
TRIM BRACKET
Stainless Steel
Replaces: 862548A1, 42419A1
For: MerCruiser Floor Mount Bracket



18-6752
HYDRAULIC TRIM
PUMP ASSEMBLY
Metal Bracket
Replaces: 14336A9, 88183A12
Fits: 1983 and Later without "quick connect"



18-6753
HYDRAULIC TRIM
PUMP ASSEMBLY
Stainless Steel Bracket
Replaces: 14336A9, 88183A12
Fits: 1983 and Later without "quick connect"

① Items ending in "D" are Display Packaged - Regular number is Non-Display



18-6768
COMPLETE POWER TRIM PUMP ASSEMBLY
Steel Bracket
 Replaces: 93247A7
 Replacement pump for Prestolite high pressure/low flow system. Primarily used 1982 and earlier.



18-6799
COMPLETE POWER TRIM PUMP ASSEMBLY
Stainless Steel Bracket
 Mercruiser 93247A7
 Replacement pump for Prestolite high pressure/low flow system. Salt water series. Stainless steel bracket. Primarily used 1982 and earlier.

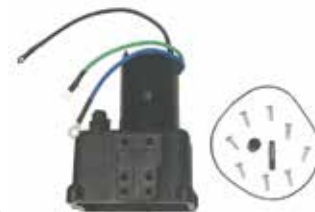

18-6763
TILT/TRIM MOTOR
 Replaces: 92975A6, 79271A4, 67914A2, 92975A32, 93247A7
 To 1984. Fits most Mercruiser Sterndrives (Motor and Reservoir Only)
 For Repair Kit use: **18-6253**



18-6769-1
TILT/TRIM PUMP
Low Pressure - High Flow
 Replaces: 14336A8, 88183A5 From 1984
 Fits most Mercruiser Sterndrives



18-6772
TILT PUMP MOTOR
 Replaces: 17649, 17649T, 891736T
 For late style Alpha I, Generation II, and Bravo drives; early style square motors.
 Mercruiser Sterndrive replacement for Oildyne units



18-6274
TILT/TRIM MOTOR
 Replaces: 14336A20
 Oildyne low pressure/high flow



18-6813
TRIM MOTOR
 Replaces: 14336A6, A8, A9, A15, A20, 88183A5, A8, A12, 865380A13, A25



18-6771
TILT/TRIM RESERVOIR
 Replaces: 18525A1



18-6778
TILT/TRIM RESERVOIR
 Replaces: 883166A2
 For: Tilt Motors with 4 Screw Attachments



18-6823
WIRING HARNESS
 Replaces: Universal
 Converts 3-wire Tilt and Trim motors to 2-Wire design



18-5872
STATOR
 Replaces: 398-6231A10
 For: 3.7L 1983-89



18-6254
COMMUTATOR END PLATE
 Replaces: 392-2940
 For : Use with Prestolite Pumps (Mercury #'s 79271A4 and 88475A5)



18-6253
COMMUTATOR END PLATE
 For use with **18-6763**



18-6256
POWER TRIM SPRING SET
 Replaces: 392-2529
 For : Use with Prestolite Pumps (Mercury #'s 74436A9, 79271A4, 88475A5 and 93247A4)



18-6255
POWER TRIM BRUSH
 Replaces: 392-8989
 For : Use with Prestolite Pumps (Mercury #'s 93247A4)



18-6293
ALTERNATOR
 Replaces: 862031T • SAE J1171
 7SI/70 amp, Hinge Mount,
 Serpentine Pulley 2.44" Diameter



18-6298
ALTERNATOR
 Replaces: 863077T • SAE J1171
 7SI/70 amp, Hinge Mount,
 Serpentine Pulley 1.97" Diameter



18-5983
ALTERNATOR
 Replaces: 862030T • SAE J1171
 7SI/70 amp, Hinge Mount, Single Groove Pulley



18-5956
ALTERNATOR
 (1-Wire) (No Core) (68 AMP)
 Single wire connection fits Mercruiser and many other
 applications. Equipped with fan and drive pulley.
 Replaces: 69729 • SAE J1171



18-5950
ALTERNATOR
 (1-Wire) (No Core) (68 AMP)
 Single wire connection fits Mercruiser and many other ap-
 plications. Equipped with fan and drive pulley.
 Replaces: 69729 • SAE J1171
 (Remanufactured)



18-5957
ALTERNATOR
 (3-Wire) (No Core) (68 AMP)
 Replaces Mando, Motorola and original equipment
 Delco. Uses same electrical connections and
 mounting method. Equipped with fan and drive pulley.
 Replaces: 78477, 78403A2, 92497A3.
 • SAE J1171



18-5951
ALTERNATOR
 (3-Wire) (No Core) (68 AMP)
 Replaces Mando, Motorola and original equipment
 Delco. Uses same electrical connections and
 mounting method. Equipped with fan and drive pulley.
 Replaces: 78477, 78403A2, 92497A3
 (Remanufactured) • SAE J1171



18-5946
ALTERNATOR
 (1-Wire) (No Core) (68 AMP)
 Single wire connection fits Mercruiser and many
 other applications. Equipped with fan and
 serpentine drive pulley. • SAE J1171



18-5945
ALTERNATOR
 (3-Wire) (No Core) (68 AMP) • SAE J1171
 Replaces Mando, Motorola and original equipment
 Delco. Uses same electrical connections and mounting
 method. Equipped with fan and serpentine drive pulley.



18-5960
ALTERNATOR
 Serpentine Pulley • 65 Amp
 Replaces: 807653T • SAE J1171



18-5966
ALTERNATOR
 Single Groove Pulley • 55 Amp
 Replaces: 817119A4, 12449A1 • SAE J1171



18-5967
ALTERNATOR
 Serpentine Pulley • 55 Amp
 Replaces: 807652T • SAE J1171



18-5965
ALTERNATOR
 65 Amp
 Replaces: 817119A1,
 817119A4, 805884T
 SAE J1171



18-6841
ALTERNATOR
 Replaces: Mercruiser 56045,
 59755, 69729
 For: 37-63A Marine Applications



18-6842
ALTERNATOR
 Replaces: Mercruiser 56045,
 59755, 69729
 For: 37-63A Marine Applications



18-6844
ALTERNATOR
 Replaces: Mercruiser 834832,
 T2, 857006A3,
 Denso 101211-3460





NEW

**18-6948
ALTERNATOR**
Replaces: Mercury 882571
Fits: CMD 1.7 MI 120 I/L4, CMD 1.7 MS 120 I/L4, D1.7L DTI



NEW

**18-6960
ALTERNATOR**
Replaces: Mercruiser 821663, -1, A1, Denso 101211-3020, 3021



**18-5953-1
ALTERNATOR CONVERSION KIT**
Includes new 68 AMP alternator, mounting brackets 18-5968, pulley, wiring, hardware and instructions. Converts model 470 aluminum block Mercruiser engines serial number 4625580 & up with stator charging system and water cooled voltage regulator to alternator system. **NOTE: Fuse kit 18-8220 (sold separately) is required on engines with a Delco starter (round solenoid mounted to starter); Prestolite starters with remote solenoid DO NOT require fuse kit. Visually inspect starter prior to ordering conversion kit**

CE
MARINE
UL
LISTED



**18-5949
CONVERSION KIT DRIVE BELT**
Replacement belt for alternator conversion kit used on 470 Series Mercruisers. Included in 18-5953-1 kit.



**18-5968
ALTERNATOR BRACKET**
Replacement bracket for alternator conversion kit used on 470 Series Mercruiser included in 18-5953 kit



**18-8220
FUSE KIT**
Replace: 88-79023A91
For use with 18-5953 alternator conversion kits installed on Mercruiser (Model 470) 3.7 liter aluminum block engines serial number 6902288 & Up.
90 AMP



**18-5740
VOLTAGE REGULATOR**
Replaces: 42785

Model #	Cyl.	Years	Beg. S/N	End. S/N	Slave Solenoid	Reman Starter	New Starter	Reman Alternator	New Alternator
110	GM 4	1963-1966	1538370	2044033	18-5836	18-5900	18-5911	—	—
120	GM 4	1964-1975	1666601	4469865	18-5836	18-5900	18-5911	18-5951	18-5957
120	GM 4	1976-1982	4469866	6229717	18-5815	18-5900	18-5911	18-5951	18-5957
120 / 2.5L	GM 4	1983-1989	6229718	C853255	18-5817	18-5900	18-5911	—	18-5966 ④
140	GM 4	1968-1975	2508261	4460664	18-5836	18-5900	18-5911	18-5951	18-5957
140	GM 4	1976-1981	4460665	6229717	18-5815	18-5900	18-5911	18-5951	18-5957
140/3.0L	GM 4	1982-1989	6229718	C856558	18-5817	18-5900	18-5911	18-5951	18-5957
140/3.0L	GM 4	1999-2001	OL382122	OM326292	18-5817	—	18-6275	—	18-5983 **
140/3.0L/3.0LX	GM 4	1990-92	C856559	D831100	18-5817	18-5900	18-5911	18-5951	18-5957
140/3.0LX	GM 4	1992-97	D831101	OK999999	18-5817	N/A	18-6275	—	18-5966 ④
165/3.7L	Merc 4	1987-1989	B434941	C762299	18-5802	18-5901	18-5907	N/A	N/A
170	Merc 4	1985-1986	6916779	B434940	18-5802	18-5901	18-5907	N/A	N/A
180/3.7LX	Merc 4	1987-1989	B436391	C762299	18-5802	18-5901	18-5907	N/A	N/A
190	Merc 4	1985-1986	6916779	B436390	18-5802	18-5901	18-5907	N/A	N/A
470	Merc 4	1976-1984	4208730	6916778	18-5802	18-5901	18-5907	N/A	N/A
470MIE	Merc 4	1980-1981	5520115	6218036	18-5802	18-5901	18-5907	N/A	N/A
485	Merc 4	1980-1984	5685394	6916778	18-5802	18-5901	18-5907	N/A	N/A
140	GM 6	1963	1538930	1725960	18-5836	18-5900	18-5911	—	—
150	GM 6	1964-66	1666495	2048046	18-5836	18-5900	18-5911	—	—
160	GM 6	1967-69	2048022	2768031	18-5836	18-5900	18-5911	—	—
160	GM 6	1969	2768032	2770031	18-5836	18-5900	18-5911	18-5951	18-5957
165	GM 6	1970-1975	2770032	4471565	18-5836	18-5900	18-5911	18-5951	18-5957
165	GM 6	1976-1981	4471566	5813433	18-5815	18-5900	18-5911	18-5951	18-5957
200	GM 6	1969	2453769	2712072	18-5836	18-5900	18-5911	—	—
175/4.3L	GM V-6	1987-1992	B527955	D714106	18-5816	—	18-5913	—	18-5966 ④
185	GM V-6	1983-1984	6330183	6919655	18-5816	18-5900	18-5911	—	18-5966 ④
185	GM V-6	1985-1987	A331455	B527954	18-5816	N/A	18-5913	—	18-5966 ④
205	GM V-6	1985-1991	A331455	D714369	18-5816	N/A	18-5913	—	18-5966 ④
262 Mag. EFI	GM V-6	1996-1997	F803800	K999999	18-5817	N/A	18-5913	—	18-5960
262 Mag. EFI	GM V-6	1996-1997	F803800	K999999	18-5817	N/A	18-5913	—	18-5960
4.3L/LX/LXH	GM V-6	1992-1997	D714107	K999999	18-5817	—	18-5913	—	18-5967
4.3L/LX/LXH	GM V-6	1996-1997	F803000	K999999	18-5817	—	18-5913	—	18-5967
4.3L/LH	GM V-6	1998-99	L010044	OL618999	18-5817	—	18-5913	—	18-5967
4.3L/LH(Gen +)	GM V-6	2000-02	OL619000	OM320024	18-5817	—	18-5913	—	18-6293 **
4.3EFI	GM V-6	1998-99	L012009	OL618999	18-5817	—	18-5913	—	18-5960
4.3L EFI	GM V-6	2000-01	OL619000	OM299999	18-5817	—	18-5913	—	18-6293 **
4.3L MPI	GM V-6	2002	OM300000	OM320024	18-5817	—	18-5913	—	18-6293 **
190	GM V-8	1963-1964	1564539	1730903	18-5836	18-5900	18-5911	—	—
200	GM V-8	1985-1986	6218462	B525981	18-5816	18-5900	18-5911 ① ③	—	18-5966 ④
200	GM V-8	1985-1986	6218462	B525981	18-5816	18-5905	18-5910 ② ⑥	—	18-5966 ④
200/5.0L	GM V-8	1987-1995	B525982	F600999	18-5816	18-5905	18-5910	—	18-5966 ④
200/5.0L	GM V-8	1987-1995	B525982	F600999	18-5817	18-5905	18-5910	—	18-5966 ④
215 MCM & MIE	Ford V-8	1970-1972	2781153	3563181	18-5836	18-5902	18-5908 ①	18-5951	18-5957

① For 12 3/4" Dia. Flywheel
 ② For 14" Dia. Flywheel
 ③ For permanent magnet models use 18-5919
 ④ 55 AMP up grade to 65 AMP use 18-5965
 ⑤ Black
 ⑥ For permanent magnet models use 18-5913
 ⑦ Bravo drive
 ⑧ Firepower ignition
 ⑨ Ignition module mounted on distributor
 ⑩ Ignition module mounted on elbow
 ⑪ LH rotation
 ⑫ NLA for models prior to S/N 4167000
 ⑬ PG 260 (9-1/4" long)
 ⑭ PG260F1 (8-1/2" long)
 ⑮ RH Rotation
 ⑯ Standard Ignition
 ⑰ Thunderbolt Ignition
 ⑱ Thunderbolt IV
 ⑲ Thunderbolt V
 ⑳ Transmission models
 ** Delco Style

Model #	Cyl.	Years	Beg. S/N	End. S/N	Slave Solenoid	Reman Starter	New Starter	Reman Alternator	New Alternator
215 MCM & MIE	Ford V-8	1970-1972	2781153	3563181	18-5836	18-5901	18-5907 ⑤	18-5951	18-5957
225	Ford V-8	1973-1974	3385721	4166999	18-5802	18-5903	—	18-5951	18-5957
225 MIE	Ford V-8	1973-1974	3385721	4176999	18-5836	18-5902	18-5908 ①	18-5951	18-5957
225 MIE	Ford V-8	1973-1974	3385721	4176999	18-5836	18-5901	18-5907 ⑤	18-5951	18-5957
888	Ford V-8	1971-1977	3108723	4612109	18-5802	18-5903	—	18-5951	18-5957
888	Ford V-8	1971-1977	4612110	& Up	18-5801	18-5903	—	18-5951	18-5957
225	GM V-8	1963-1966	1539620	2278646	18-5836	18-5900	18-5911	—	—
225 MIE	GM V-8	1968	2278647	2694014	18-5836	18-5902	18-5908 ①	—	—
225 MIE	GM V-8	1968	2278647	2694014	18-5836	18-5901	18-5907 ⑤	—	—
225	GM V-8	1967-1969	2278647	2694014	18-5836	—	—	—	—
228/230	GM V-8	1977-1986	4765100	B525981	18-5816	18-5900	18-5911 ① ③	—	18-5966 ④
228/230	GM V-8	1977-1986	4765100	B525981	18-5816	18-5905	18-5910 ② ⑥	—	18-5966 ④
228 MIE	GM V-8	1977-1980	4765100	5907057	18-5815	18-5902	18-5908 ①	18-5951	18-5957
228 MIE	GM V-8	1977-1980	4765100	5907057	18-5815	18-5901	18-5907 ⑤	18-5951	18-5957
230/5.0LX	GM V-8	1987-1995	B525982	F600999	18-5816 ⑩	18-5905	18-5910 ③	—	18-5966 ④
230/5.0LX	GM V-8	1987-1995	B525982	F600999	18-5817 ⑨	18-5905	18-5910 ③	—	18-5966 ④
230/5.0L MIE	GM V-8	1987-1988	5907058	B788151	18-5816	18-5902	18-5908 ①	—	18-5966 ④
230/5.0L MIE	GM V-8	1987-1988	5907058	B788151	18-5816	18-5901	18-5907 ⑤	—	18-5966 ④
5.0L (Gen +)	GM V-8	1998-99	L015751	L618999	18-5817	—	18-5913	—	18-5967
5.0L (Gen +)	GM V-8	2000-2002	L619000	M320024	18-5817	—	18-5913	—	18-6293 **
5.0L EFI	GM V-8	1998-99	L012052	L618999	18-5817	—	18-5913	—	18-5960
5.0L EFI	GM V-8	2000-01	L619000	M299999	18-5817	—	18-5913	—	18-6293 **
5.0L MPI	GM V-8	2002	M300000	M320024	18-5817	—	18-5913	—	18-6293 **
198 MIE	GM V-8	1977	4762210	6218461	18-5815	18-5902	18-5908 ①	18-5951	18-5957
198 MIE	GM V-8	1977	4762210	6218461	18-5815	18-5901	18-5907 ⑤	18-5951	18-5957
898	GM V-8	1977-1982	4762210	6218461	18-5801	18-5900	18-5911	18-5951	18-5957
898	GM V-8	1983-1984	621462	B525981	18-5816	18-5900	18-5911 ① ③	—	18-5966 ④
898	GM V-8	1983-1984	621462	B525981	18-5816	18-5905	18-5910 ② ⑥	—	18-5966 ④
233	Ford V-8	1975-1977	4173000	4902304	18-5801	18-5903	—	18-5951	18-5957
233 MIE	Ford V-8	1975-1976	4173000	4775784	18-5836	18-5902	18-5908 ①	18-5951	18-5957
233 MIE	Ford V-8	1975-1976	4173000	4775784	18-5836	18-5901	18-5907 ⑤	18-5951	18-5957
250 MCM & MIE	GM V-8	1968-1969	2314301	2639854	18-5836	18-5902	18-5908 ①	—	—
250 MCM & MIE	GM V-8	1968-1969	2314301	2639854	18-5836	18-5901	18-5907 ⑤	—	—
250	GM V-8	1977	4768000	4908849	18-5801	18-5900	18-5911	18-5951	18-5957
255	Ford V-8	1973-1974	3258728	4175499	18-5802	18-5903	—	18-5951	18-5957
255 MIE	Ford V-8	1973-1974	3258728	4178299	18-5836	18-5902	18-5908 ①	18-5951	18-5957
255 MIE	Ford V-8	1973-1974	3258728	4178299	18-5836	18-5901	18-5907 ⑤	18-5951	18-5957
255	GM V-8	1975-1976	4175500	4767999	18-5815	18-5900	18-5911	18-5951	18-5957
255 MIE	GM V-8	1975-1980	4175500	5907057	18-5815	18-5902	18-5908 ①	18-5951	18-5957
255 MIE	GM V-8	1975-1980	4175500	5907057	18-5815	18-5901	18-5907 ⑤	18-5951	18-5957
260	GM V-8	1978-1982	4908850	6218461	18-5801	18-5900	18-5911	18-5951	18-5957
260	GM V-8	1982-1986	6218462	B525981	18-5816	18-5900	18-5911 ① ③	—	18-5966 ④
260	GM V-8	1982-1986	6218462	B525981	18-5816	18-5905	18-5910 ② ⑥	—	18-5966 ④
260/5.7L	GM V-8	1987-1995	B525982	F600999	18-5816 ⑩	18-5905	18-5910 ⑥	—	18-5966 ④
260/5.7L	GM V-8	1987-1995	B525982	F600999	18-5817 ⑨	18-5905	18-5910 ⑥	—	18-5966 ④
260/5.7L MIE	GM V-8	1987-1995	5907058	F746099	18-5816	18-5902	18-5908 ①	—	18-5966 ④
260/5.7L MIE	GM V-8	1987-1995	5907058	F746099	18-5816	18-5901	18-5907 ⑤	—	18-5966 ④
5.7L/LX	GM V-8	1996	F601000	K001526	18-5817	—	18-5913	—	18-5966 ④
5.7L/LX	GM V-8	1997 & Up	K001527	& Up	18-5817	—	18-5913	—	18-5967
5.7L	GM V-8	2000-02	L619000	M320024	18-5817	—	18-5913	—	18-6293 **
5.7L/LX EFI	GM V-8	1995-1996	F225560	K001505	18-5816	—	18-5913	—	18-5965
5.7L/LX EFI	GM V-8	1997	K001506	K999999	18-5816	—	18-5913	—	18-5960
5.7L EFI	GM V-8	1998 & Up	L010035	& Up	18-5816	—	18-5913	—	18-5960
5.7L EFI	GM V-8	2000-01	L619000	M299999	18-5816	—	18-5913	—	18-6293 **
5.7L MIE	GM V-8	1994-1996	F622151	K040306	18-5816	18-5902	18-5908 ①	—	18-5966 ④
5.7L MIE	GM V-8	1994-1996	F622151	K040306	18-5816	18-5901	18-5907 ⑤	—	18-5966 ④
5.7L MIE	GM V-8	1997 & Up	K040307	& Up	18-5817	18-5902	18-5908	—	18-5967
5.7L MIE	GM V-8	1998-01	L002003	L677226	18-5817	18-5902	18-5908	—	18-6293 **
5.7L EFI MIE	GM V-8	1997	K040300	K999999	18-5816	18-5902	18-5908	—	18-5960
5.7L Ski	GM V-8	1985-1995	A338533	F775199	18-5816	—	18-5913 ⑤	—	18-5966 ④
5.7L Ski	GM V-8	1985-1995	A338533	F775199	18-5816	18-5901	18-5907 ①	—	18-5966 ④
5.7L Ski	GM V-8	1996	F775200	K040003	18-5817	—	18-5913	—	18-5966 ④
5.7L Ski	GM V-8	1997	K040004	K999999	18-5817	—	18-5913	—	18-5967
5.7L Ski	GM V-8	1998 & Up	L002005	& Up	18-5817	—	18-5913	—	18-5967
5.7L Ski	GM V-8	2000-01	L619000	L678784	18-5817	—	18-5913	—	18-6293 **
350 Mag. Alpha	GM V-8	1986-1995	A635178	F600999	18-5816 ⑩	18-5905	18-5910 ⑥	—	18-5966 ④
350 Mag. Alpha	GM V-8	1987-1996	B525982	K001526	18-5817 ⑨	18-5905	18-5910 ⑥	—	18-5966 ④
350 Mag. Alpha	GM V-8	1997	K001527	K999999	18-5817	—	18-5913	—	18-5967
350 Mag. EFI & MPI	GM V-8	1995-1996	F415189	K001500	18-5816	—	18-5913	—	18-5965
350 Mag. EFI & MPI	GM V-8	1997 & Up	K001501	& Up	18-5816	—	18-5913	—	18-5960
350 Mag MPI	GM V-8	2000-01	L619000	M299999	18-5816	—	18-5913	—	18-6293 **
350 Mag MPI / Horizon	GM V-8	2002	M300000	M320024	18-5817	—	18-5913	—	18-6293 **
350 Mag MPI MIE	GM V-8	1998 & Up	L002008	& Up	18-5816	18-5908	18-5902	—	18-5960
350 Mag MPI MIE / Horizon	GM V-8	1999-01	L304700	L678398	18-5816	18-5908	18-5902	—	18-6293 **
350 Mag Ski	GM V-8	1991-1996	D505450	K040399	18-5816 ⑩	—	18-5913	—	18-5966 ④
350 Mag Ski	GM V-8	1991-1996	D505450	K040399	18-5817 ⑨	—	18-5913	—	18-5966 ④
350 Mag Ski	GM V-8	1997	K040400	K999999	18-5817	—	18-5913	—	18-5967
350 Mag EFI Ski	GM V-8	1994-1997	F215561	K999999	18-5816	—	18-5913	—	18-5965
350 Mag MPI Ski	GM V-8	1995-1996	F350583	F799999	18-5816	—	18-5913	—	18-5965
350 Mag MPI Ski	GM V-8	1998 & Up	L002600	& Up	18-5817	—	18-5913	—	18-5960
350 Mag MPI Ski	GM V-8	1998-02	L002600	M310021	18-5817	—	18-5913	—	18-6293 **
Black Scorpion	GM V-8	1996	F800000	K040000	18-5816	—	18-5913	—	18-5965
Black Scorpion	GM V-8	1997 & Up	K040001	& Up	18-5816	—	18-5913 ⑤	—	18-5960

① For 12 3/4" Dia. Flywheel	⑧ Firepower ignition	⑥ RH Rotation
② For 14" Dia. Flywheel	⑨ Ignition module mounted on distributor	⑦ Standard Ignition
③ For permanent magnet models use 18-5919	⑩ Ignition module mounted on elbow	⑧ Thunderbolt Ignition
④ 55 AMP up grade to 65 AMP use 18-5965	⑪ LH rotation	⑨ Thunderbolt IV
⑤ Black	⑫ NLA for models prior to S/N 4167000	⑩ Thunderbolt V
⑥ For permanent magnet models use 18-5913	⑬ PG 260 (9-1/4" long)	⑪ Transmission models
⑦ Bravo drive	⑭ PG260F1 (8-1/2" long)	** Delco Style

Model #	Cyl.	Years	Beg. S/N	End. S/N	Slave Solenoid	Reman Starter	New Starter	Reman Alternator	New Alternator
Black Scorpion	GM V-8	1997 & Up	K040001	& Up	18-5816	—	18-5913 ④	—	18-5960
Black Scorpion	GM V-8	1997-01	K040001	L678036	18-5816	—	18-5913	—	18-6293 **
270 MCM & MIE	GM V-8	1969-1972	2851074	3385720	18-5836	18-5902	18-5908 ①	18-5951	18-5957
270 MCM & MIE	GM V-8	1969-1972	2851074	3385720	18-5836	18-5901	18-5907 ⑤	18-5951	18-5957
280 TRS	GM V-8	1975-1976	4176250	4770199	18-5815	18-5900	18-5911	18-5951	18-5957
300 TR TEMPEST	GM V-8	1985-1986	6668677	B430367	18-5816	18-5908	18-5902	—	18-5966 ④
300 MR TEMPEST	GM V-8	1985-1986	6668677	B430367	18-5816	—	18-5919 ①	—	18-5966 ④
300 MR TEMPEST	GM V-8	1985-1986	6668677	B430367	18-5816	—	18-5913 ②	—	18-5966 ④
320 EFI	GM V-8	1987-1989	A543604	C622418	18-5816	—	18-5913	—	18-5966 ④
MX 6.2L MPI	GM V-8	2000-2002	L680003	M320024	18-5817	—	18-5913	—	18-6293
MX 6.2L MPI Horizon	GM V-8	2002	M300000	M320024	18-5817	—	18-5913	—	18-6293
MX 6.2L MPI Horizon MIE	GM V-8	2002	M300000	M310099	18-5817	—	18-5603	—	18-6293
MX 6.2L MPI MIE	GM V-8	2002	M300000	M310099	18-5817	—	18-5603	—	18-6293
MX 6.2L Black Scorpion Ski	GM V-8	2001	L670015	L678036	18-5816	—	18-5913	—	18-6293
325 MCM & MIE	GM V-8	1968-1970	2278747	2761141	18-5836	18-5902	18-5908 ①	—	—
325 MCM & MIE	GM V-8	1968-1970	2278747	2761141	18-5836	18-5901	18-5907 ⑤	—	—
325 MCM & MIE	GM V-8	1970-1974	2761142	3780449	18-5836	18-5902	18-5908 ①	18-5951	18-5957
325 MCM & MIE	GM V-8	1970-1974	2761142	3780449	18-5836	18-5901	18-5907 ⑤	18-5951	18-5957
330	GM V-8	1977-1981	4623115	6083144	18-5836 ⑦	—	18-5913	18-5951	18-5957
330	GM V-8	1977-1981	4623115	6083144	18-5815 ⑧	—	18-5913	18-5951	18-5957
330	GM V-8	1982-1987	6083145	B816540	18-5816	18-5902	18-5908	—	18-5966 ④
330 MIE	GM V-8	1977-1980	4623115	5889913	18-5836 ⑦	18-5902	18-5908 ①	18-5951	18-5957
330 MIE	GM V-8	1977-1980	4623115	5889913	18-5815 ⑧	18-5901	18-5907 ⑤	18-5951	18-5957
340/7.4L MIE w/BW	GM V-8	1981-1992	5889914	D715493	18-5816	18-5902	18-5908 ①	—	18-5966 ④
340/7.4L MIE w/BW	GM V-8	1981-1992	5889914	D715493	18-5816	18-5901	18-5907 ⑤	—	18-5966 ④
7.4L	GM V-8	1988-1991	B771113	D603117	18-5816	18-5905	18-5910 ⑥	—	18-5966 ④
7.4L	GM V-8	1988-1996	B771113	F800699	18-5816 ⑩	18-5905	18-5910 ⑥	—	18-5966 ④
7.4L	GM V-8	1992-1997	D603118	K999999	18-5817 ⑨	—	18-5913	—	18-5966 ④
7.4LX EFI & MPI	GM V-8	1996-1997	F602010	K999999	18-5816	—	18-5913	—	18-5965
7.4L MPI	GM V-8	1998 & Up	L010003	& Up	18-5817	—	18-5913	—	18-6293
7.4L MIE	GM V-8	1989-1996	C391564	F820141	18-5816 ⑨	18-5902	18-5908	—	18-5966 ④
7.4L MIE	GM V-8	1992-1997	D715494	K999999	18-5817 ⑨	18-5902	18-5908	—	18-5966 ④
7.4L EFI & MPI MIE	GM V-8	1995-1997	F563052	K999999	18-5816	18-5902	18-5908	—	18-5965
7.4L MPI MIE	GM V-8	1998 & Up	L002006	& Up	18-5817	18-5902	18-5908	—	18-6293
350 MIE	GM V-8	1974-1976	3780450	4623109	18-5836	18-5902	18-5908 ①	18-5951	18-5957
350 MIE	GM V-8	1974-1976	3780450	4623109	18-5836	18-5901	18-5907 ⑤	18-5951	18-5957
370 TRS	GM V-8	1978-1985	4179554	6721527	18-5815	18-5902	18-5908	18-5951	18-5957
370 TRS	GM V-8	1978-1985	4179554	6721527	18-5815	18-5902	18-5908	—	18-5966 ④
370 TRS	GM V-8	1985-1987	6721528	B714586	18-5816	18-5902	18-5908	—	18-5966 ④
390 MCM & MIE	GM V-8	1969-1970	2781129	3042731	18-5836	18-5902	18-5908 ①	18-5951	18-5957
390 MCM & MIE	GM V-8	1969-1970	2781129	3042731	18-5836	18-5901	18-5907 ⑤	18-5951	18-5957
400 TRS	GM V-8	1980-1986	4179554	B457644	18-5815	18-5902	18-5908	18-5951	18-5957
400 TRS	GM V-8	1980-1986	4179554	B457644	18-5815	18-5902	18-5908	—	18-5966 ④
420	GM V-8	1987-1989	A398941	B622418	18-5816	18-5902	18-5908	—	18-5966 ④
425	GM V-8	1990-1992	A398941	D937011	18-5816	18-5902	18-5908	—	18-5966 ④
440 TRS	GM V-8	1983-1986	4179554	B485220	18-5815	18-5902	18-5908	18-5951	18-5957
440 TRS	GM V-8	1983-1986	4179554	B485220	18-5815	18-5902	18-5908	—	18-5966 ④
450	GM V-8	1995-1996	F347100	F347277	18-5820	—	18-5913	—	—
454 Mag.	GM V-8	1986-1994	A631894	F304999	18-5816	—	18-5913	—	18-5966 ④
454 Mag.	GM V-8	1995-1997	F305000	K999999	18-5817	—	18-5913	—	18-5966 ④
454 Mag. MPI	GM V-8	1994-1997	F115700	K999999	18-5816	—	18-5913	—	18-5965
454 Mag. MPI	GM V-8	1998 & Up	L010029	& Up	18-5816	—	18-5913	—	18-6293
454 Mag. MPI MIE	GM V-8	1996-1997	F820100	K999999	18-5816	—	18-5913	—	18-5965
454 Mag. MPI MIE	GM V-8	1998 & Up	L002200	& Up	18-5816	18-5902	18-5908	—	18-6293
454 EFI Ski	GM V-8	1995-1996	F215800	F820099	18-5816	—	18-5913	—	18-5965
460 TRS	GM V-8	1983-1986	4179554	6181046	18-5815	18-5902	18-5908	18-5951	18-5957
460 TRS	GM V-8	1983-1986	4179554	6181046	18-5815	18-5902	18-5908	—	18-5966 ④
465	GM V-8	1990-1994	C849992	F213244	18-5816 ⑨	—	18-5913 ⑦	—	18-5966 ④ ⑤
465	GM V-8	1990-1994	C849992	F213244	—	18-5902	18-5908 ⑩	—	—
500	GM V-8	1994-1997	F213293	& Up	18-5820	—	18-5913 ⑦	—	—
500	GM V-8	1994-1995	F213293	& Up	18-5820	18-5902	18-5908 ⑩	—	—
500 Bulldog	GM V-8	1990-1996	C577254	& Up	18-5820 ⑧	—	18-5913 ⑦	—	—
500 Bulldog	GM V-8	1990-1996	C577254	& Up	18-5816 ⑧	18-5902	18-5908 ⑩	—	18-5966 ④ ⑤
502 Mag. Bravo	GM V-8	1990-1993	C878221	F114528	18-5816	—	18-5913	—	18-5966 ④
502 Mag. MPI	GM V-8	1993-1997	D840650	K999999	18-5816	—	18-5913	—	18-5965
502 Mag. MPI	GM V-8	1998 & Up	L017000	& Up	18-5816	—	18-5913	—	18-6293
525 SC	GM V-8	1991-1993	D456000	D763831	18-5816	—	18-5913 ⑦	—	18-5966 ④ ⑤
525 SC	GM V-8	1991-1993	D456000	D763831	18-5816	18-5902	18-5908 ⑩	—	—
525 SC	GM V-8	1993-1997	D763871	& Up	18-5820	—	18-5913 ⑦	—	18-5966 ④ ⑤
525 SC	GM V-8	1993-1997	D763871	& Up	18-5820	18-5902	18-5908 ⑩	—	—
525 EFI	GM V-8	2003-2010	M900146	& Up	—	—	—	—	18-6298
575	GM V-8	1986-1992	A677429	D763716	18-5816	18-5902	18-5908	—	18-5966 ④
600 SC	GM V-8	1991-1996	D456489	F877642	18-5816 ⑧	18-5902	18-5908	—	18-5966 ④ ⑤
600 SC	GM V-8	1991-1996	D456489	F877642	18-5820 ⑧	18-5902	18-5908	—	—
600 SC	GM V-8	1997	K000227	& Up	18-5820	—	18-5913 ⑩	—	—
600 Sci	GM V-8	2005-2010	M952908	& Up	—	—	—	—	18-6298
800 SC	GM V-8	1993-1996	D763836	& Up	18-5820	18-5902	18-5908 ⑩	—	—
8.2L MIE	GM V-8	1990-1996	C878221	F819619	18-5816 ⑨	18-5902	18-5908	—	18-5966 ④
8.2L MIE	GM V-8	1993-1996	D857200	F819619	18-5817	18-5902	18-5908	—	18-5966 ④
8.2L MPI MIE	GM V-8	1996-1997	F819620	K999999	18-5816	18-5902	18-5908	—	18-5965
8.2L MPI MIE	GM V-8	1998 & Up	L002450	& Up	18-5816	18-5902	18-5908	—	18-6293

① For 12 3/4" Dia. Flywheel
 ② For 14" Dia. Flywheel
 ③ For permanent magnet models use 18-5919
 ④ 55 AMP up grade to 65 AMP use 18-5965
 ⑤ Black
 ⑥ For permanent magnet models use 18-5913
 ⑦ Bravo drive
 ⑧ Firepower ignition
 ⑨ Ignition module mounted on distributor
 ⑩ Ignition module mounted on elbow
 ⑪ LH rotation
 ⑫ NLA for models prior to S/N 4167000
 ⑬ PG 260 (9-1/4" long)
 ⑭ PG260F1 (8-1/2" long)
 ⑮ RH Rotation
 ⑯ Standard ignition
 ⑰ Thunderbolt ignition
 ⑱ Thunderbolt IV
 ⑲ Thunderbolt V
 ⑳ Transmission models
 ** Delco Style



**18-7683
FUEL PRESSURE REGULATOR**
Replaces: 849899
Fits: MCM 500 EFI



**18-7662
FUEL PRESSURE
REGULATOR**
Replaces: 885174
4.3L, 5.0L, 5.7L & 6.2L MPI engines with
555 ECM-regulator mounted on fuel rail



**18-7663
FUEL PRESSURE
REGULATOR**
Replaces: 802630T01
7.4L MPI (L29)



**18-7652
FUEL PRESSURE
REGULATOR**
Replaces: 805227A1



**18-7600
TEMPERATURE SENSOR**
Replaces: 805218T



**18-7700
THROTTLE
POSITION SENSOR**
Replaces: 853678T
Fits: MCM/MIE 4.3L MPI, 5.0L MPI,
MX6.2L MPI w/ECM 555 and 350 Mag
MPI, Black Scorpion Tow Sports, 377
Scorpion Tow Sports, 7.4L MPI(L29) &
MCM 496 Mag & HO and MIE 8.1S & HO



**18-7630
THROTTLE POSITION
SENSOR**
Replaces: 805226A1



**18-7701
IDLE SPEED
CONTROL MOTOR**
Replaces: 862998
Fits: MCM 3.0L MPI, V6 & V8(305, 350
& 496 cid)MPI engines w/ECM555



**18-7697
IAC MOTOR**
Replaces: 803149
Fits: MCM/MIE 350 Mag MPI, Black
Scorpion Tow Sports, 377 Scorpion
MCM & Tow Sports, MX6.2L MPI, 7.4L
MPI(L29) & 575 Sci



**18-7632
IDLE AIR CONTROL MOTOR**
Replaces: 805224A1



**18-7682
MAP SENSOR**
Replaces: 849934
Fits: MCM 575 Sci



**18-7684
MAP SENSOR**
Replaces: 864856A1
Fits: MCM/MIE GM V6 & V8 (350, 377,
454 & 502cid)EFI Engines



**18-7660
MAP SENSOR**
Replaces: 881731
V-6 & V-8 MPI engines with 555 ECM



**18-7668
MAP SENSOR**
Replaces: 854445
525 EFI



**18-7677
KNOCK SENSOR**
Replaces: 806612T
Fits: GM V8(305, 350 & 377 cid) engines



**18-7703
KNOCK SENSOR**
Replaces: 805544T



**18-7646
CAMSHAFT SENSOR**
Replaces: 892615002



**18-7685
TBI INJECTOR**
Replaces: 852956A1
Fits: MCM GM V6 & V8 (305 & 350 cid)
TBI engines



**18-7686
FUEL INJECTOR**
Replaces: 849896
Fits: MCM 500 EFI

Model	Liter	CID	# Cyl	Year Range	Serial # Range	Injector	IAC Valve	TPS	F/P Regulator Rail-Mounted	F/P Regular Cooler Mounted	MAP Sensor
350 MAG MPI SKI	5.7L	350	V-8	2007	A064825 - A089999	N/A	18-7701	18-7700	18-7662	N/A	N/A
5.7L EFI	5.7L	350	V-8	1995-1997	F225560 - K999999	18-7685	18-7632	18-7630	N/A	N/A	18-7684
5.7L EFI (GEN +)	5.7L	350	V-8	1998-2001	L010035 - M299999	18-7685	18-7632	18-7630	N/A	N/A	N/A
5.7L EFI MIE (GEN +)	5.7L	350	V-8	1997	K040300 - K999999	18-7685	18-7632	18-7630	N/A	N/A	18-7684
5.7L MPI HORIZON MIE	5.7L	350	V-8	2008-2010	A090000 - & UP	N/A	18-7701	18-7700	18-7662	N/A	N/A
5.7L MPI HORIZON DTS MIE	5.7L	350	V-8	2008-2010	A090000 - & UP	N/A	N/A	N/A	18-7662	N/A	N/A
5.7L MPI MIE	5.7L	350	V-8	2008-2010	A090000 - & UP	N/A	18-7701	18-7700	18-7662	N/A	N/A
5.7L MPI DTS MIE	5.7L	350	V-8	2008-2010	A090000 - & UP	N/A	N/A	N/A	18-7662	N/A	N/A
5.7L MPI SKI	5.7L	350	V-8	2008-2010	A090000 - & UP	N/A	N/A	18-7700	18-7662	N/A	N/A
5.7LX BRAVO EFI (GEN +)	5.7L	350	V-8	1996-1997	F800300 - K999999	18-7685	18-7632	18-7630	N/A	N/A	18-7684
5.7LX EFI	5.7L	350	V-8	1995-1997	F225560 - K999999	18-7685	18-7632	18-7630	N/A	N/A	18-7684
BLACK SCORPION SKI		350	V-8	1996	F350583 - K040000	N/A	18-7697	18-7700	N.L.A.	N.L.A.	18-7684
BLACK SCORPION SKI		350	V-8	1997	K040001 - L002699	N/A	18-7697	18-7700	N/A	N/A	18-7684
BLACK SCORPION SKI		350	V-8	1998	L002700 - L005600	N/A	18-7697	18-7700	N/A	N/A	N/A
BLACK SCORPION SKI		350	V-8	1998-2002	L005601 - M391599	N/A	18-7697	18-7757	N/A	N/A	N/A
BLACK SCORPION SKI		350	V-8	2003-2010	M391600 - W698432	N/A	18-7701	18-7757	N/A	N/A	N/A
SCORPION 350	5.0L	350	V-8	2008-2010	W698433 & UP	N/A	18-7701	18-7757	N/A	N/A	N/A
377 MAG		377	V-8	2008-2010	A300000 & UP	N/A	18-7701	18-7700	18-7662	N/A	N/A
377 MAG DTS		377	V-8	2008-2010	A300000 & UP	N/A	N/A	N/A	18-7662	N/A	N/A
377 SCORPION MCM		377	V-8	1999-2005	L416146 - M907201	N/A	18-7697	18-7757	N/A	N/A	18-7684
377 SCORPION SKI		377	V-8	1997-1998	K000656 - L600314	N/A	18-7697	18-7700	N/A	N/A	18-7684
MX 6.2L MPI	6.2L	377	V-8	2000-2001	L680003 - M299999	N/A	18-7697	18-7757	N/A	N/A	N/A
MX 6.2L MPI	6.2L	377	V-8	2002-2004	M300000 - W059999	18-7688	18-7701	18-7700	18-7662	N/A	N/A
MX 6.2L MPI	6.2L	377	V-8	2004-2007	W060000 - A064824	18-7688	18-7701	18-7700	18-7662	N/A	N/A
MX 6.2L MPI	6.2L	377	V-8	2007	A064825 - A299999	N/A	18-7701	18-7700	18-7662	N/A	N/A
MX 6.2L MPI DTS.	6.2L	377	V-8	2005-2007	W310000 - A064824	18-7688	N/A	N/A	18-7662	N/A	N/A
MX 6.2L MPI DTS.	6.2L	377	V-8	2007	A064825 - A299999	N/A	N/A	N/A	18-7662	N/A	N/A
MX 6.2L MPI HORIZON	6.2L	377	V-8	2002-2004	M300000 - W059999	18-7688	18-7701	18-7700	18-7662	N/A	N/A
MX 6.2L MPI HORIZON	6.2L	377	V-8	2004-2007	W060000 - A064824	18-7688	18-7701	18-7700	18-7662	N/A	N/A
MX 6.2L MPI HORIZON	6.2L	377	V-8	2007	A064825 - A299999	N/A	18-7701	18-7700	18-7662	N/A	N/A
MX 6.2L MPI HORIZON DTS	6.2L	377	V-8	2005-2007	W310000 - A064824	18-7688	N/A	N/A	18-7662	N/A	N/A
MX 6.2L MPI HORIZON DTS	6.2L	377	V-8	2007	A064825 - A299999	N/A	N/A	N/A	18-7662	N/A	N/A
MX 6.2L MPI HORIZON MIE	6.2L	377	V-8	2002-2004	M300000 - M398394	18-7688	18-7701	18-7700	18-7662	N/A	N/A
MX 6.2L MPI HORIZON MIE	6.2L	377	V-8	2004-2007	M398395 - A064825	18-7688	18-7701	18-7700	18-7662	N/A	N/A
MX 6.2L MPI HORIZON MIE	6.2L	377	V-8	2007-2010	A064825 & UP	N/A	18-7701	18-7700	18-7662	N/A	N/A
MX 6.2L MPI HORIZON MIE DTS	6.2L	377	V-8	2005-2007	W390000 - A064824	18-7688	N/A	N/A	N/A	N/A	N/A
MX 6.2L MPI HORIZON MIE DTS	6.2L	377	V-8	2007-2010	A064825 & UP	N/A	N/A	N/A	18-7662	N/A	N/A
MX 6.2L MPI MIE	6.2L	377	V-8	2002-2004	M300000 - M398394	18-7688	18-7701	18-7700	18-7662	N/A	N/A
MX 6.2L MPI MIE	6.2L	377	V-8	2004-2007	M398395 - A064825	18-7688	18-7701	18-7700	18-7662	N/A	N/A
MX 6.2L MPI MIE	6.2L	377	V-8	2007-2010	A064825 & UP	N/A	18-7701	18-7700	18-7662	N/A	N/A
MX 6.2L MPI MIE DTS	6.2L	377	V-8	2005-2007	W390000 - A064824	18-7688	N/A	N/A	18-7662	N/A	N/A
MX 6.2L MPI MIE DTS	6.2L	377	V-8	2007-2010	A064825 & UP	N/A	N/A	N/A	18-7662	N/A	N/A
MX 6.2L MPI SKI	6.2L	377	V-8	2002-2007	M317000 - W689999	18-7688	18-7701	18-7700	18-7662	N/A	N/A
MX 6.2L BLACK SCORPION SKI	6.2L	377	V-8	2001-2003	L005601 - M391599	N/A	18-7697	18-7757	N/A	N/A	N/A
MX 6.2L BLACK SCORPION SKI	6.2L	377	V-8	2003-2007	M391750 - W698432	N/A	18-7701	18-7757	N/A	N/A	N/A
454 MAG EFI	7.4L	454	V-8	1994-1996	F115700 - F802349	N/A	18-7632	18-7630	18-7652	N/A	18-7684
454 MAG EFI SKI	7.4L	454	V-8	1995-1996	F215800 - F820099	N/A	18-7632	18-7630	18-7652	N/A	18-7684
454 MAG EFI SKI	7.4L	454	V-8	1996-1997	F820099 - K999999	N/A	18-7632	18-7630	18-7652	N/A	18-7684
454 MAG MPI	7.4L	454	V-8	1996-1997	F802350 - K147349	N/A	18-7632	18-7630	18-7652	N/A	18-7684
454 MAG MPI	7.4L	454	V-8	1997-1998	K147350 - L085399	N/A	18-7632	18-7630	18-7652	N/A	18-7684
454 MAG MPI	7.4L	454	V-8	1999-2001	L085400 - M024999	N/A	18-7632	18-7630	N/A	N/A	18-7684
454 MAG MPI HORIZON MIE	7.4L	454	V-8	1998	L002200 - L086049	N/A	18-7632	18-7630	18-7652	N/A	18-7684
454 MAG MPI HORIZON MIE	7.4L	454	V-8	1999-2001	L086050 - L674000	N/A	18-7632	18-7630	N/A	N/A	18-7684
7.4L MPI (L29)	7.4L	454	V-8	1998-2001	L010003 - M024330	N/A	18-7697	18-7700	18-7663	N/A	N/A
7.4L MPI MIE	7.4L	454	V-8	1995-1996	F563052 - K147349	N/A	18-7632	18-7630	18-7652	N/A	18-7684
7.4L MPI MIE	7.4L	454	V-8	1997	K147350 - K999999	N/A	N/A	18-7630	18-7652	N/A	18-7684
7.4L MPI MIE (L29)	7.4L	454	V-8	1998-2001	L010003 - L674613	N/A	N/A	18-7700	18-7663	N/A	N/A
7.4LX TBI	7.4L	454	V-8	1996-1997	F820000 - K999999	N.L.A.	18-7632	18-7630	N/A	N/A	18-7684
7.4LX MPI	7.4L	454	V-8	1996	F602010 - K147349	N/A	18-7632	18-7630	18-7652	N/A	18-7684
7.4LX MPI	7.4L	454	V-8	1997	K147350 - K999999	N/A	18-7632	18-7630	18-7652	N/A	18-7684
496 MAG		496	V-8	2001-2004	M025000 - W059999	N/A	N/A	18-7700	18-7663	N/A	N/A
496 MAG		496	V-8	2004	W060000 - W060573	N/A	N/A	18-7700	18-7663	N/A	N/A
496 MAG		496	V-8	2004-2010	W060574 - & UP	N/A	N/A	18-7700	N/A	N/A	N/A
496 MAG DTS		496	V-8	2001-2004	M025000 - W059999	N/A	N/A	N/A	18-7663	N/A	N/A
496 MAG DTS		496	V-8	2004	W060000 - W060573	N/A	N/A	N/A	18-7663	N/A	N/A
496 MAG HO		496	V-8	2001-2004	M025000 - W059999	N/A	N/A	18-7700	18-7663	N/A	N/A
496 MAG HO		496	V-8	2004	W060000 - W060461	N/A	N/A	18-7700	18-7663	N/A	N/A
496 MAG HO		496	V-8	2004-2010	W060462 - & UP	N/A	N/A	18-7700	N/A	N/A	N/A
496 MAG HO DTS		496	V-8	2001-2004	M025000 - W059999	N/A	N/A	N/A	18-7663	N/A	N/A
496 MAG HO DTS		496	V-8	2004	W060000 - W060461	N/A	N/A	N/A	18-7663	N/A	N/A
496 MAG HO DTS		496	V-8	2004-2010	W060462 - & UP	N/A	N/A	N/A	N/A	N/A	N/A
496 MAG & HO EC		496	V-8	2007-2010	A066166 & UP	N/A	N/A	18-7700	N/A	N/A	N/A
496 MAG & HO DTS EC		496	V-8	2010		N/A	N/A	N/A	N/A	N/A	N/A
8.1L & HO MIE		496	V-8	2001-2004	M026000 - W089999	N/A	N/A	18-7700	18-7663	N/A	N/A
8.1L & HO MIE		496	V-8	2004	W090000 - W389999	N/A	N/A	18-7700	18-7663	N/A	N/A
8.1L & HO MIE		496	V-8	2004-2010	W390000 - & UP	N/A	N/A	18-7700	N/A	N/A	N/A
8.1L & HO MIE DTS		496	V-8	2001-2004	M026000 - W089999	N/A	N/A	N/A	18-7663	N/A	N/A
8.1L & HO MIE DTS		496	V-8	2004	W090000 - W389999	N/A	N/A	N/A	18-7663	N/A	N/A
8.1L & HO MIE EC		496	V-8	2007-2010	W697154 - & UP	N/A	N/A	18-7700	N/A	N/A	N/A
500 EFI	8.2L	502	V-8	1999-2005	L001477 - M907127	18-7686	18-7632	N/A	N/A	N/A	18-7684
502 MAG MPI	8.2L	502	V-8	1993-1996	D840650 - K147349	N/A	18-7632	18-7630	18-7652	N/A	18-7684
502 MAG MPI	8.2L	502	V-8	1997-1998	K147350 - L085432	N/A	18-7632	18-7630	18-7652	N/A	18-7684
502 MAG MPI	8.2L	502	V-8	1999-2001	L085432 - M024999	N/A	18-7632	18-7630	N/A	N/A	18-7684
575 Sci	8.2L	502	V-8	2000-2005	L306696 - M950526	N.L.A.	18-7632	18-7630	N/A	N/A	N/A
575 Sci	8.2L	502	V-8	2000-2005	L306696 - M950526	N.L.A.	18-7632	18-7630	N/A	N/A	N/A
8.2L MAG	8.2L	502	V-8	2010	A350340 & UP	N/A	N/A	18-7700	N/A	N/A	N/A
8.2L MIE	8.2L	502	V-8	2010	A350340 & UP	N/A	N/A	18-7700	N/A	N/A	N/A
8.2L MPI MIE	8.2L	502	V-8	1996	F189620 - K147349	N/A	18-7632	18-7630	18-7652	N/A	18-7684
8.2L MPI MIE	8.2L	502	V-8	1997-1998	K127350 - L086012	N/A	18-7632	18-7630	18-7652	N/A	18-7684
8.2L MPI MIE	8.2L	502	V-8	1999-2001	L086013 - L674200	N/A	18-7632	18-7630	N/A	N/A	18-7684

☒ BRAVO APPS W/SN W060000, ORDER REGULATOR # 892681 ♦ MAPT SENSOR (TEMP & PRESSURE)



**18-7627
INTAKE MANIFOLD**
Small-block GM with vortec cylinder heads



**18-7628
INTAKE MANIFOLD**
Small-block GM with vortec cylinder heads with brass lined water jackets

ALL SIERRA CARBURETORS INCLUDE BASE GASKET

- Precision remanufactured to meet or exceed OEM specifications
- Re-calibrated and re-engineered to maximize fuel efficiency and performance
- All carburetors are flow tested throughout the entire throttle range
- Fuel mixture and idle settings are pre-set to ensure that only minor idle and choke adjustments are necessary during installation
- All bases are resurfaced and throttle shaft bushings replaced



**18-7373N
MERCARB 2V CARBURETOR**
Replaces: Mercruiser 3310-864941A01
2002-2004 4.3L engines (s/n OM615000-OW300012)



**18-7615N
Q-JET CARBURETOR**
Replaces: 1347-816373A4,
1347-804624R1, 1347-804624R02



**18-7639
CARBURETOR**
Replaces: 3310-864943A01
Mercarb-5.7L 2V 1998 and newer 5.7L
(OL010337-OW300754) & 5.7L MIE
(OL002003-OW090899)
(Remanufactured)



**18-7640
CARBURETOR**
Universal Q-jet with electric choke
(Remanufactured)



**18-7603-1
CARBURETOR**
2 Barrel - Rochester
Replaces: 1347-818622,
1376-5659A1, 1347-818622 1,
1347-818622R02
(Remanufactured)



**18-7604-1
CARBURETOR**
4 Barrel - Rochester
Replaces: 3304-9354A2,
1347-804623R02
(Remanufactured)



**18-7605-1
CARBURETOR**
4 Barrel - Rochester
Replaces: 1347-9661A3,
1347-804623A1,
1347-804623R02
(Remanufactured)



**18-7608-1
CARBURETOR**
2 Barrel - Rochester
Replaces: 1347-818620,
1347-818620 1, 1347-818620R02
(Remanufactured)



**18-7609-1
CARBURETOR**
2 Barrel - Rochester
Replaces: 1347-818619,
1347-818619 1, 1347-818619 1R
(Remanufactured)









**18-7610-1
CARBURETOR**
2 Barrel - Rochester
Replaces: 1347-818621, 1347-818621 1,
1347-818621 1R02
(Remanufactured)



**18-7611-2
CARBURETOR**
2 Barrel - Rochester
Replaces: 3310-807312A1,
3310-807312R02
(Remanufactured)

ALL SIERRA CARBURETORS INCLUDE BASE GASKET

 <p>18-7613-1 CARBURETOR 4 Barrel - Carter (Weber) Replaces: 3310-806969A1, 3310-806969R01 (Remanufactured)</p>	 <p>18-7615-1 CARBURETOR 4 Barrel - Rochester Replaces: 1347-816373A4, 1347-804624R1, 1347-804624R02 (Remanufactured)</p>	 <p>18-7616-1 CARBURETOR 4 Barrel - Rochester Replaces: 1347-8288A1, 1347-804626R02 (Remanufactured)</p>
 <p>18-7617-1 CARBURETOR 4 Barrel - Rochester Replaces: 1347-9863A3, 1347-804624R1, 1347-804625R02 (Remanufactured)</p>	 <p>18-7618-1 CARBURETOR 4 Barrel - Rochester Replaces: 1347-8289A1, 1347-804624R1, 1347-804624R02 (Remanufactured)</p>	 <p>18-7619-1 CARBURETOR 4 Barrel - Rochester Replaces: 1347-9142A2, 1347-8460A3 (Remanufactured)</p>

CARBURETOR APPLICATION

Model	CID / # Cyl	Year Range	Beginning Serial #	Ending Serial #	Original Carb Part Number	Carb Code / Model	Carb Repair Kit	Replacement O.E. Carb. Number	Float	Sierra Carb #
90	96/L4	1970-1971	2851424	3225967	1351- 4263A 1	7040082 R2/2GC	18-7746	1347-818619R02	18-7200	18-7609-1
90	96/L4	1972	3225868	3226957	1351- 4263A 1	7036543 R2/2GC	18-7746	1347-818619R02	18-7200	18-7609-1
110	153/L4	1963-1966	1357370	2044033	1336-2076	R2/2GC	—	—	—	18-7609-1
120	153/L4	1972-1973	3377341	3770649	1351-4263A3	7043182 R2/2GC	18-7746	1347-818619R02	18-7200	18-7609-1
120	153/L4	1974-1975	3770650	4469865	1351-5202A1	7044182 R2/2GC	18-7746	1347-818619R02	18-7200	18-7609-1
120	153/L4	1976-1978	4469866	5192048	1351-6065A2	7044182 R2/2GC	18-7746	1347-818619R02	18-7200	18-7609-1
120	153/L4	1979-1982	5192049	6229717	1351-7354A1	17059054 R2/2GC	18-7746	1347-818619R02	18-7200	18-7609-1
120	153/L4	1983	6229718	6663797	1351- 8480A 2	17081060 R2/2GC	18-7746	1347-818621R02	18-7200	18-7610-1
120	153/L4	1984	6663798	6853913	1389- 8490A 2	M2/MERCARB	18-7097	3310-860070A 2	18-7202	—
120	153/L4	1985	6853914	A492055	1389- 9350A 2	M2/MERCARB	18-7097	3310-860070A 2	18-7202	—
120	153/L4	1986	A492056	B531853	1389- 9562A 1	M2/MERCARB	18-7098-1	3310-860070A 2	18-7202	—
2.5L	153/L4	1983-1989	B531854	C853255	3310-806077A 2	M2/MERCARB	18-7098-1	3310-860070A 2	18-7202	—
140	181/L4	1968-1969	2508261	2816416	1351- 3635A 1	7036646 R/2GC	18-7746	—	18-7200	—
140	181/L4	1970	2816417	2911439	1351- 4032A 1	7040080 R/2GC	18-7746	1347-818620R02	18-7200	18-7608-1
140	181/L4	1970-1973	2911440	3771644	1351-4293A1	7040084 R/2GC	18-7746	1347-818620R02	18-7200	18-7608-1
140	181/L4	1974-1978	3771645	5157668	1351-5203A1	7043184 R/2GC	18-7746	1347-818620R02	18-7200	18-7608-1
140	181/L4	1979-1982	5157669	6229717	1351-7355A1	17059052 R/2GC	18-7746	1347-818620R02	18-7200	18-7608-1
140	181/L4	1983	6229718	6671328	1351- 8480A 2	17081060 R/2GC	18-7746	1347-818521R02	18-7200	—
140	181/L4	1984	6671329	6852269	1389- 8490A 2	M2/MERCARB	18-7097	3310-860070A 2	18-7202	—
140	181/L4	1985	6852270	A484072	1389- 9350A 2	M2/MERCARB	18-7097	3310-860070A 2	18-7202	—
140	181/L4	1986	A484073	B450800	1389- 9562A 1	M2/MERCARB	18-7098-1	3310-860070A 2	18-7202	—
140/3.0L	181/L4	1983-1989	6229718	C856556	1351-8480A2	R2/2GC	—	1348-818621 1	—	18-7610-1
3.0L	181/L4	1987-1989	B450801	C856556	3310-806077A 2	M2/MERCARB	18-7098-1	3310-860070A 2	18-7202	—
3.0L	181/L4	1990	C856559	D447414	1389-815396A 2	M2/MERCARB	18-7098-1	3310-860070A 2	18-7202	—
3.0L	181/L4	1991-1993	D447415	D836075	1389-806077A 2	M2/MERCARB	18-7098-1	3310-860070A 2	18-7202	—
3.0L	181/L4	1993-1994	D836076	F603999	1389-806078A 1	M2/MERCARB	18-7098-1	3310-860070A 2	18-7202	—
3.0L	181/L4	1998-2002	L010042	M385672	3310-807504A 1	M2/MERCARB	18-7098-1	3310-8M0045397	18-7202	—
3.0L	181/L4	2003-2004	M385673	W301999	3310-864940A01	M2/MERCARB	18-7098-1	3310-8M0045397	18-7202	—
3.0L	181/L4	1999-2004	L382122	W301999	3310-864940A01	M2/MERCARB	18-7098-1	865959A01	18-7202	⑤
3.0L	181/L4	2004-2010	W302000	& UP	3310-866140A02	M2/MERCARB	18-7098-1	3310-866140A02	18-7202	—
3.0LX	181/L4	1990-1997	C856559	K999999	1389-815397A 2	M2/MERCARB	18-7098-1	3310-8M0045397	18-7202	—
3.0LX	181/L4	1990-1997	C856559	K999999	3310-805924A 2	M2/MERCARB	18-7098-1	3310-8M0045397	18-7202	—
165 (4 CYL)	224/L4	1987	B434941	B774251	1389- 9564A 1	M2/MERCARB	18-7098-1	3310-860071A 2	18-7202	—
170	224/L4	1985-1989	6916779	B434940	1389- 9564A 1	M2/MERCARB	18-7098-1	3310-860071A 2	18-7202	—
180	224/L4	1987	B436391	B775248	1347- 9142A 2	17083522 R4/4ME	18-7077	—	18-7201	—
190 (4 CYL)	224/L4	1985-1986	6916779	B436390	1347- 9142A 2	17083522 R4/4ME	18-7077	—	18-7201	—
3.7L	224/L4	1988-1989	B774252	& UP	1389- 9564A 1	M2/MERCARB	18-7098-1	3310-860071A 2	18-7202	—

- ① Automatic Choke
- ② Black
- ③ Blue
- ④ Electric Choke
- ⑤ Front (Blue)
- ⑥ On-Line
- ⑦ Rear (Blue)
- ⑧ Spacer Mounted
- ⑨ Use if original carb is MERCARB
- ⑩ Use if original carb is Rochester
- ⑪ Use with in-line transmission
- ⑫ Use with V-drive transmission
- ⑬ V-drive
- ⑭ Wedge mounted
- ⑮ TKS Retrofit Kit

CARBURETOR APPLICATION

Model	CID / # Cyl	Year Range	Beginning Serial #	Ending Serial #	Original Carb Part Number	Note	Carb Code / Model	Carb Repair Kit	Replacement O.E. Carb. Number	Float	Note	Sierra Carb #
3.7LX	224L4	1988-1989	B775249	& UP	1347-9142A 2		17083522 R4/4ME	18-7077	—	18-7201		—
470	224L4	1976-1984	4208730	6916778	1376-5990A 1		17057132 R2/2GC	18-7076	3310-860071A 4	18-7202	⑩	—
470	224L4	1983-1984	6218037	6916778	1389-8489A 5		M2/MERCARB	18-7097	3310-860071A 2	18-7202	⑨	—
485	224L4	1980-1982	5685394	6218036	1376-5990A 1		17057132 R2/2GC	18-7076	3310-860071A 4	18-7202		—
488	224L4	1983-1984	6170297	6916778	1347-8460A 3		17081299 R4/4ME	18-7077	—	18-7201		18-7619-1
150	230L6	1964-1966	1830152	2048046	1338-2633		8025188 R2/2GC	18-7746	—	18-7200		—
160	250L6	1967-1968	2048022	2492038	1338-2991		7026088 R2/2GC	18-7746	—	18-7200		—
160	250L6	1969	2492036	277031	1351-3635A 1		7036646 R/2GC	18-7746	—	18-7200		—
165 (6 CYL)	250L6	1970-1972	3774865	3354791	1351-4282A1		7043183 R2/2GC	18-7746	1347-818620R02	18-7200		18-7608-1
165 (6 Cyl)	250L6	1979-1981	5178959	5813433	1351-7356A1		17059050 R2/2GC	18-7746	1347-818620R02	18-7200		18-7608-1
165 (6 Cyl)	L6	1972-1973	3354702	3774864	1351-4871A1		R2/2GC	—	1347-818620 1	—		18-7608-1
180/190 3.7L, L4 Engine	—	1985-1989	6916779	Later	1347-9142A2		R4/4ME	—	1347-8460	—		18-7619-1
200 (6 CYL)	292L6	1969	2453769	2494935	1347-3237A 4		7037082 R4/4MV	18-7077	—	18-7201		—
185 (4bbl)	229V-6	1993-1994	6330183	6919655	3300-8886A 2		17083515 R4/4ME	18-7077	—	18-7201		—
175	262V-6	1987	B527955	B773242	3304-9565A 1		M2/MERCARB	18-7098-1	3310-807764A 1	18-7202		—
185	262V-6	1985-1986	A331455	B527954	3304-9353A 2		M2/MERCARB	18-7097	3310-807764A 1	18-7202		—
205	262V-6	1985-1987	A331455	B775129	3304-9354A2		17084516 R4/4MV	18-7077	—	18-7201		18-7605-1
4.3L	262V-6	1988-1992	B773243	D714106	3304-9565A 1		M2/MERCARB	18-7098-1	3310-807764A 1	18-7202		—
4.3L	262V-6	1992-1993	D714107	F000877	3304-9565A 1		M2/MERCARB	18-7098-1	3310-807764A 1	18-7202		—
4.3L	262V-6	1993-1995	F000878	F601126	3310-806972A 1		M2/MERCARB	18-7098-1	3310-807764A 1	18-7202		—
4.3L	262V-6	1996-2002	F601127	M614999	3310-807764A 1		M2/MERCARB	18-7098-1	3310-807764A 1	18-7202		—
4.3L	262V-6	2002-2004	M615000	W300012	3310-864941A01		M2/MERCARB	18-7098-1	3310-864941A01	18-7202		—
4.3L	262V-6	2000-2004	L619000	W300012	3310-864941A01		M2/MERCARB	18-7098-1	865960A02	18-7202	⑤	—
4.3L	262V-6	2004-2010	W300013	& UP	3310-866141A02		M2/MERCARB	18-7098-1	3310-866141A02	18-7202		—
4.3LH	262V-6	1998-2002	L010044	M614999	3310-807826A 1		9666 WEBER	18-7749	—	—		—
4.3LX	262V-6	1988-1991	B775130	D714369	3304-9354A 2		17084516 R4/4MV	18-7077	1347-804623R02	18-7201		18-7605-1
4.3LX	262V-6	1992-1996	D714370	F802999	3310-818660A 1		9600 WEBER	18-7749	—	—		—
4.3XH	262V-6	1996-1997	F803114	K999999	3310-807826A 1		9666 WEBER	18-7749	—	—		—
215 MCM/MIE (FORD)	302V-8	1970-1972	2781153	3385720	1356-4066		C9FF9510E H4/4160	18-7096	1356-804628R02	18-7206		—
225 MCM/MIE (FORD)	302V-8	1973-1974	3385721	4166999	1356-5155		D2JL9510C H4/4160	18-7096	1356-804628R02	18-7206		—
888	302V-8	1971-1977	3108723	4887829	1376-5659A1		7044185 R2/2GC	18-7075	1376-818622R02	18-7202	⑩	18-7603-1
888	302V-8	1971-1977	3108723	4887829	1356-4642		D1J95108 H2/2300	18-7081	—	—		—
198 MIE	305V-8	1977	4776402	4931099	1376-6491A 1		17057139 R2/2GC	18-7075	3310-861080A 1	18-7202		—
200	305V-8	1985-1986	6899058	A482026	1389-8488A 2		M2/MERCARB	18-7097	3310-861080A 1	18-7202		—
200	305V-8	1985-1987	A482027	B525981	1389-9563A 1		M2/MERCARB	18-7098-1	3310-861080A 1	18-7202		—
200	305V-8	1987	B525982	B774444	1389-9670A 2		M2/MERCARB	18-7098-1	3310-807312A1	18-7202		—
228	305V-8	1977-1978	4765100	5069430	1347-6427A1		17057282 R4/4MV	18-7077	9661A 3	18-7201		18-7605-1
228	305V-8	1978-1981	5069431	6021783	1347-7361A1		17059292 R4/4MV	18-7077	9661A 3	18-7201		18-7605-1
228	305V-8	1982	6021784	6218461	1347-8296A4		17080565 R4/4MV	18-7077	9661A 3	18-7201		18-7605-1
228	305V-8	1982-1984	6218462	6899268	1347-9661A 3		17080565 R4/4MV	18-7077	9661A 3	18-7201		18-7605-1
228 MIE	305V-8	1977-1978	4765100	5069430	1347-6438A1		17057283 R4/4MV	18-7077	9661A 3	18-7201		18-7605-1
228 MIE	305V-8	1978-1982	5069431	6040745	1347-7364A1		17059291 R4/4MV	18-7077	9661A 3	18-7201		18-7605-1
228 TR	305V-8	1977-1978	4765100	5069430	1347-6438A 1		17057283 R4/4MV	18-7077	9661A 3	18-7201		18-7605-1
230	305V-8	1985-1987	6899269	B773739	1347-9661A 3		17080565 R4/4MV	18-7077	9661A 3	18-7201		18-7605-1
230 MIE	305V-8	1982-1987	6040746	B788151	1347-8290A1		17080564 R4/4MV	18-7077	9661A 3	18-7201		18-7605-1
223/230/5.0LX	V-8	1983-1995	6218462	F600999	1347-9661A3		R4/4MV	—	1347-9661A3	—		18-7605-1
5.0L	305V-8	1988-1995	B774445	F600999	1389-9670A 2		M2/MERCARB	18-7098-1	3310-807312A1	18-7202		—
5.0L (GEN +)	305V-8	1998-2002	L015751	M599999	3310-861448A 1		M2/MERCARB	18-7098-1	3310-864942A01	18-7202		—
5.0L (GEN +)	305V-8	2002-2004	M600000	W300009	3310-864942A01		M2/MERCARB	18-7098-1	3310-864942A01	18-7202		—
5.0L (GEN +)	305V-8	2000-2004	L619000	W300009	3310-864942A01		M2/MERCARB	18-7098-1	865961A02	18-7202	⑤	—
5.0L (GEN +)	305V-8	2004-2010	W300010	& UP	3310-866142A03		M2/MERCARB	18-7098-1	3310-866142A04	18-7202		—
5.0LX	305V-8	1988-1995	B773740	F600999	1347-9661A 3		17080565 R4/4MV	18-7077	9661A 3	18-7201		18-7605-1
898/200/5.0L	V-8	1987-95	B525982	F600999	1389-9670A2		M2/MERCARB	—	3310-807312A1	—		18-7611-1
898	305V-8	1977	4762210	6021383	1376-6491A 1		17057139 R2/2GC	18-7075	3310-861080A 1	18-7202		—
898	305V-8	1982	6021384	6218461	1376-8295A 3		17080350 R2/2GC	18-7075	3310-861080A 1	18-7202		—
898	305V-8	1983-1984	6218462	6899057	1389-8488A 2		M2/MERCARB	18-7097	3310-861080A 1	18-7202		—
225 MCM/MIE (GM)	327V-8	1963-1969	1539620	2694014	1347-3237A 3	①	7037082 R4/4MV	—	1347-804624R02	—		18-7615-1
250	350V-8	1977	4768000	4908849	1347-3353	①	7037082 R4/4MV	—	1347-804624R02	—		18-7615-1
250	350V-8	1977	4768000	4908849	1347-3237A 3	①	7037082 R4/4MV	—	1347-804624R02	—		18-7615-1
255	350V-8	1975-1976	4175550	4767999	1347-5732A 1		7044291 R4/4MV	18-7077	1347-804624R02	18-7201		18-7615-1
255 MIE (GM)	350V-8	1975-1978	4175550	4924564	1347-5732A 1		7044291 R4/4MV	18-7077	1347-804624R02	18-7201		18-7615-1
255 MIE (GM)	350V-8	1978	4924565	5195908	1347-7062A1		17057292 R4/4MV	18-7077	1347-804624R02	18-7201		18-7615-1
255 MIE (GM)	350V-8	1979-1980	5195909	5907057	1347-7365A1		17059289 R4/4MV	18-7077	1347-804624R02	18-7201		18-7615-1
260 MIE	V-8	1980-1986	5907058	B522505	1347-8289A1		R4/4MV	—	1347-8289A1	—		18-7618-1
260	350V-8	1978	4908850	5060805	1347-6492A 1		17057298 R4/4MV	18-7077	1347-804624R02	18-7201		18-7615-1
260	350V-8	1976-1982	5060806	6024393	1347-7362A 1		17059288 R4/4MV	18-7077	1347-804624R02	18-7201		18-7615-1
260	350V-8	1982-1987	6024393	B525981	1347-8292A 4		17080561 R4/4MV	18-7077	1347-804624R02	18-7201		18-7615-1
260	350V-8	1987	B525982	B773304	1347-9662A 1		17080561 R4/4MV	18-7077	1347-804624R02	18-7201		18-7615-1
260 MIE	350V-8	1981-1987	5907058	B522505	1347-8289A 1		17080562 R4/4MV	18-7077	1347-804624R02	18-7201		18-7615-1
260 MIE	350V-8	1987	B522506	B788151	1347-9662A 1		17080561 R4/4MV	18-7077	1347-804624R02	18-7201		18-7615-1

- ① Automatic Choke
- ② Black
- ③ Blue
- ④ Electric Choke
- ⑤ Front (Blue)

- ⑥ On-Line
- ⑦ Rear (Blue)
- ⑧ Spacer Mounted
- ⑨ Use if original carb is MERCARB
- ⑩ Use if original carb is Rochester

- ① Use with in-line transmission
- ② Use with V-drive transmission
- ③ V-drive
- ④ Wedge mounted
- ⑤ TKS Retrofit Kit

CARBURETOR APPLICATION

Model	CID / # Cyl	Year Range	Beginning Serial #	Ending Serial #	Original Carb Part Number	Note	Carb Code / Model	Carb Repair Kit	Replacement O.E. Carb. Number	Float	Note	Sierra Carb #
260/5.7MIE	V-8	1987-1993	B522506	F024999	1347-966A4		R4/4MV	—	1347-816373A4	—		18-7615-1
260/5.7L ALPHA	V-8	1987-1993	B525982	F000454	1347-9662A4		R4/4MV	—	1347-816373A4	—		18-7615-1
270 MCM/MIE	350/V-8	1969-1972	2851074	3385720	1347- 4180A 1		7029285 R4/4MV	18-7077	—	18-7201		—
280 TRS	350/V-8	1975	4176250	4176468	1347- 4179A 2		7040283 R4/4MV	18-7077	—	18-7201		—
280 TRS	350/V-8	1975-1976	4176469	4770199	1347- 5981A 1		7044290 R4/4MV	18-7077	—	18-7201		—
300 MR/TRS	350/V-8	1985-1986	6668677	B430367	1347- 7498A 7		17059280 R4/4MV	18-7077	—	18-7201		18-7615-1
350 MAG ALPHA	350/V-8	1986-1991	A635178	D617327	1347- 8289A 1		17080562 R4/4MV	18-7077	1347-804624R02	18-7201		18-7615-1
350 MAG ALPHA	350/V-8	1992-1995	D617328	F600999	3310-806970A 1		9770SA WEBER	18-7749	3310-807262A 1	—		—
350 MAG ALPHA	350/V-8	1996-1997	F601000	K999999	3310-807262A 2		9781 WEBER	18-7748	—	—		—
350 MAG SKI	350/V-8	1991-1996	D505450	K040399	3310-806970A 1	⑥	9770SA WEBER	18-7749	—	—	①	—
350 MAG SKI	350/V-8	1991-1997	D505450	K999999	3310-807262A 2	⑥	9781 WEBER	18-7748	—	—	①	—
350 MAG SKI	350/V-8	1997	K040400	K999999	3310-860371A 1	③	9781SB WEBER	18-7748	—	—	②	—
5.7L (2BBL)	350/V-8	1996-1997	F601000	K999999	3310-807312A1		M2/MERCARB	18-7098-1	3310-807312A1	18-7202		18-7611-2
5.7L (GEN +) (2bbl)	350/V-8	1998-2002	L010037	M599999	3310-861245A 1		M2/MERCARB	18-7098-1	3310-864943A01	18-7202		18-7639
5.7L (GEN +) (2bbl)	350/V-8	2002-2004	M600000	W300754	3310-864943A01		M2/MERCARB	18-7098-1	3310-864943A01	18-7202		18-7639
5.7L (GEN +) (2bbl)	350/V-8	2000-2004	L015751	W300754	3310-864943A01		M2/MERCARB	18-7098-1	865962A02	18-7202	⑤	—
5.7L (Gen II)	V-8	1998-2004	L010037	W300754	3310-864943101		M2/MERCARB	—	3310-864943101	—		18-7639
5.7L (GEN +) (2bbl)	350/V-8	2004-2010	W300755	& UP	3310-866143A03		M2/MERCARB	18-7098-1	3310-866143A03	18-7202		—
5.7L ALPHA	350/V-8	1988-1993	B773305	F000454	1347- 9662A 4		17080561 R4/4MV	18-7077	1347-804624R02	18-7201		18-7615-1
5.7L ALPHA	350/V-8	1993-1994	F000455	F273497	3310-805484A 1		9661 WEBER	18-7749	—	—		—
5.7L ALPHA	350/V-8	1993-1994	F000455	F273497	3310-806761A 1		9665S WEBER	18-7748	—	—		—
5.7L ALPHA	350/V-8	1994-1995	F273498	F600999	3310-806761A 3		9665S WEBER	18-7748	3310-806761A 3	—		—
5.7L BRAVO (W/O HIGH RISE INTAKE)	350/V-8	1988-1991	B773305	D617327	1347- 9662A 4		17080561 R4/4MV	18-7077	1347-804624R02	18-7201		18-7615-1
5.7L BRAVO (W/HIGH RISE INTAKE)	350/V-8	1988-1991	B773305	D617327	1347- 8289A 1		17080562 R4/4MV	18-7077	1347-804624R02	18-7201		18-7615-1
5.7L BRAVO W/O HIGH RISE INTAKE	V-8	1987-1991	OB525982	OD617327	1347-9662A4		R4/4MV	—	1347-816373A4	—		18-7615-1
5.7L BRAVO W/HIGH RISE INTAKE	V-8	1987-1991	OB525982	OD617327	1347-8289A1		R4/4MV	—	1347-8289A1	—		18-7618-1
5.7L BRAVO	350/V-8	1992-1995	D617328	F600999	3310-806970A 1		9770SA WEBER	18-7749	3310-807262A 1	—		—
5.7L MIE	350/V-8	1988-1992	B768152	D715493	1347- 9662A 4		17080561 R4/4MV	18-7077	1347-804624R02	18-7201		18-7615-1
5.7L MIE	350/V-8	1992-1994	D715494	F349999	3310-806761A 2	④	9665S WEBER	18-7748	3310-806761A 2	—		—
5.7L MIE	350/V-8	1995	F349300	F622099	3310-806761A 3		9665S WEBER	18-7748	3310-806761A 3	—		—
5.7L MIE (2bbl)	350/V-8	1998-2002	L002003	M316999	3310-861245A 1		M2/MERCARB	18-7098-1	3310-864943A01	18-7202		18-7639
5.7L MIE (2bbl)	350/V-8	2002-2004	M317000	W090899	3310-864943A01		M2/MERCARB	18-7098-1	3310-864943A01	18-7202		18-7639
5.7L MIE (2bbl)	350/V-8	2000-2004	L390600	W090899	3310-864943A01		M2/MERCARB	18-7098-1	865962A02	18-7202	⑤	—
5.7L MIE (2bbl)	350/V-8	2004-2010	W090900	& UP	3310-866143A03		M2/MERCARB	18-7098-1	3310-866143A03	18-7202		—
5.7L SKI	350/V-8	1985-1987	A338553	B514626	1347- 9415T		17085013 R4/4MV	18-7077	9415T	18-7201		—
5.7L SKI	V-8	1985-1993	A338553	F025099	1347-9415T		R4/4MV	—	1347-9415T	—		18-7615-1
5.7L SKI	350/V-8	1987-1995	F450000	F775199	3310-805484A 1		9661 WEBER	18-7749	3310-806761A 3	—		—
5.7L SKI (2bbl)	350/V-8	1996-1997	F775200	K999999	3310-807312A1		M2/MERCARB	18-7098-1	3310-807312A1	18-7202		18-7611-2
5.7L SKI (GEN +) (2bbl)	350/V-8	1998-2002	L002005	M316999	3310-861245A 1		M2/MERCARB	18-7098-1	3310-864943A01	—		18-7639
5.7L SKI (GEN +) (2bbl)	350/V-8	2002-2004	M317000	W090899	3310-864943A01		M2/MERCARB	18-7098-1	3310-864943A01	—		18-7639
5.7L SKI (GEN +) (2bbl)	350/V-8	2000-2004	L390600	W090899	3310-864943A01		M2/MERCARB	18-7098-1	865962A02	18-7202	⑤	18-7618-1
5.7L SKI (GEN +) (2bbl)	350/V-8	2004-2010	W090900	& UP	3310-866143A03		M2/MERCARB	18-7098-1	3310-866143A03	18-7202		—
5.7LX (4bbl)	350/V-8	1996-1997	F601000	K999999	3310-807262A 2		9761 WEBER	18-7748	—	—		—
233 MCM & MCI (FORD)	351/V-8	1975-1977	4173000	4465029	1376- 5744 1		7044187 R2/2GC	18-7075	1347-818622R02	—		18-7603-1
233 MCM & MCI (FORD)	351/V-8	1975-1977	4465030	4902304	1376- 6152A 1		17056197 R2/2GC	18-7075	1347-818622R02	—		18-7603-1
325 MCM/MIE	427/V-8	1969-1970	2278747	3042730	1347- 3342	①	7027080 R4/4MV	18-7077	—	18-7201		—
325 MCM/MIE	427/V-8	1971-1972	3042731	3780449	1347- 4533A 1	①	7041831 R4/4MV	18-7077	—	18-7201		—
325 MCM/MIE	427/V-8	1969-1972	2278747	3780449	1347- 3689A 1	②	7029280 R4/4MV	18-7077	—	18-7201		—
330 MCM	427/V-8	1977-1978	4623115	5027230	1347-6493A1		17057287 R4/4MV	18-7077	1347-804626R02	18-7201		18-7616-1
330 MCM	427/V-8	1977-1981	5027231	6083144	1347-7363A1		17059290 R4/4MV	18-7077	1347-804626R02	18-7201		18-7616-1
330 MCM	427/V-8	1982-1987	6083145	B816540	1347-8291A3		17080563 R4/4MV	18-7077	1347-804626R02	18-7201		18-7616-1
330 MIE	427/V-8	1977-1978	4623115	5226384	1347-6493A1		17057287 R4/4MV	18-7077	1347-804626R02	18-7201		18-7616-1
330 MIE	427/V-8	1979-1980	5226385	5889913	1347-7366A1		17059287 R4/4MV	18-7077	1347-804626R02	18-7201		18-7616-1
340 MIE	454/V-8	1981-1987	5889914	D788365	1347-8288A1		17080560 R4/4MV	18-7077	1347-804626R02	18-7201		18-7616-1
370	454/V-8	1978-1987	4179554	B714586	1347- 7498A 2		17059280 R4/4MV	18-7077	1347-804625R02	18-7201		—
400	454/V-8	1980-1986	4179554	B457644	1347- 7498A 2		17059280 R4/4MV	18-7077	1347-804625R02	18-7201		—
420	454/V-8	1987-1989	A398941	B622418	13549A 4		H4	18-7751	—	—		—
425	454/V-8	1990-1993	B622419	D937011	13549A 4		H4	18-7751	—	—		—
440	454/V-8	1983-1986	4179554	B485220	1393- 8862A 1		H4	18-7751	—	—		—
450	454/V-8	1995-1996	F347100	F347277	13549A14		H4	18-7751	—	—		—
454 MAG ALPHA	454/V-8	1986-1988	A631894	B785148	1347-8291A3		17080563 R4/4MV	18-7077	1347-804626R02	18-7201		18-7616-1
454 MAG BRAVO	454/V-8	1988-1992	B721206	D808068	1347-7498A2		17059280 R4/4MV	18-7077	1347-804625R02	18-7201		18-7617-1
454 MAG BRAVO	454/V-8	1992-1994	D805069	F304999	3310-806755A 1		9779 WEBER	18-7748	—	—		—
454 MAG BRAVO	454/V-8	1995-1997	F305000	K999999	3310-806755A 2		9779 WEBER	18-7748	—	—		—
7.4L BRAVO I/II	454/V-8	1988-1991	B771113	D603117	1347-8291A3		17080563 R4/4MV	18-7077	1347-804626R02	18-7201		18-7616-1
7.4L BRAVO I/II	454/V-8	1992-1994	D603118	F351999	3310-806969A 2		9780 WEBER	18-7748	—	—		—
7.4L BRAVO I/II	454/V-8	1995-1997	F352000	K999999	3310-806969A1		9780 WEBER	18-7748	3310-806969A 1	—		18-7613-1
7.4L BRAVO III	454/V-8	1993-1996	D838819	F800699	3310-806755A 2		9779 WEBER	18-7748	—	—		—

- ① Automatic Choke
- ② Black
- ③ Blue
- ④ Electric Choke
- ⑤ Front (Blue)

- ⑥ On-Line
- ⑦ Rear (Blue)
- ⑧ Spacer Mounted
- ⑨ Use if original carb is MERCARB
- ⑩ Use if original carb is Rochester

- ⑪ Use with in-line transmission
- ⑫ Use with V-drive transmission
- ⑬ V-drive
- ⑭ Wedge mounted
- ⑮ TKS Retrofit Kit

CARBURETOR APPLICATION

Model	CID / # Cyl	Year Range	Beginning Serial #	Ending Serial #	Original Carb Part Number	Note	Carb Code / Model	Carb Repair Kit	Replacement O.E. Carb. Number	Float	Note	Sierra Carb #
7.4L BRAVO III	454/V-8	1996-1997	F800700	K999999	3310-806969A1		9780 WEBER	18-7748	3310-806969A 1	—		18-7613-1
7.4L MIE	454/V-8	1988-1992	5889914	D715493	1347- 8268A 1		17080560 R4/4MV	18-7077	1347-804626R02	18-7201		18-7616-1
460	482/V-8	1983-1986	4179554	B485220	1393- 8862A 1		H4	18-7751	—	—		—
465	502/V-8	1990-1992	C849992	F213244	—		H4	18-7751	—	—	②	—
465	502/V-8	1990-1992	C849992	F213244	—		H4	18-7751	—	—	③	—
500	502/V-8	1994-1995	F213293	F615766	13549A12		H4	18-7751	—	—	③	—
500	502/V-8	1996-1998	F615767	L001772	13549A 15		H4	18-7751	—	—	③	—
500 (GEN +)	502/V-8	1999	L414639	L601036	13549T21		H4	18-7751	—	—	③	—
502 MAG	502/V-8	1990-1992	C878221	D824588	1347-814623A 2		17089112 R4/4MV	18-7077	—	18-7201		—
502 MAG	502/V-8	1992-1993	D824589	F114528	3310-806971A 1		9782 WEBER	18-7748	—	—		—
8.2L MIE	502/V-8	1990-1992	C878221	D857199	1347-814623A 2		17089113 R4/4MV	18-7077	—	—		—
8.2L MIE	502/V-8	1990-1992	C878221	D857199	3310-817693A 1		9774 WEBER	18-7748	—	—		—
8.2L MIE	502/V-8	1993-1996	D857200	F819619	3310-806971A 1		9782 WEBER	18-7748	—	—		—
500 BULLDOG	540/V-8	1990-1995	C577254	F348987	13549A10		H4	18-7751	—	—	③	—
500 BULLDOG	540/V-8	1995-2001	F615762	M050281	13549A23		H4	18-7751	—	—	③	—

- ① Automatic Choke
- ② Black
- ③ Blue
- ④ Electric Choke
- ⑤ Front (Blue)

- ⑥ On-Line
- ⑦ Rear (Blue)
- ⑧ Spacer Mounted
- ⑨ Use if original carb is MERCarb
- ⑩ Use if original carb is Rochester

- ⑪ Use with in-line transmission
- ⑫ Use with V-drive transmission
- ⑬ V-drive
- ⑭ Wedge mounted
- ⑮ TKS Retrofit Kit

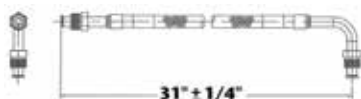

**18-8114
FUEL LINE HOSE**

For fuel pump to carburetor connection. Replaces copper or steel tubing 3/8" X 31" PTFE composite hose with 5/8"-18 male inverted flare straight one end, 5/8"-18 90° one end. SAE J1527 type A1



**18-8115
FUEL LINE HOSE**

For fuel pump to carburetor connection. Replaces copper or steel tubing 3/8" X 25" PTFE composite hose with 5/8"-18 male inverted flare straight one end, 5/8"-18 90° one end. SAE J1527 type A1



**18-7751
CARB KIT**
Replaces: 13220

Fits: GM 420 V8 454 (1987-89), GM 425 V8 454 (1990-93), GM 425 (Gen V) V8 454 (1992-93), 440 TRS GM 454 (1983-86), GM 450 V8 454 (1995-96), 460 TRS V8 482 (1983-86), GM 465 V8 502 (1990-92), GM 465 (Gen V) V8 502 (1992-94), 500 (Gen+) GM 502 V8 (1999), 500 (Gen V) 502 V8 (1994-98), 500 Bulldog 540 V8 (1990-01)



**18-7071
CARB KIT**
Replaces: 1397-3458



**18-7075
CARB KIT**
Replaces: 1397-5830, 1397-7099, 1397-8760, 1397-5831



**18-7070
CARB KIT**
Replaces: 1397-2072, 1397-7542, 1397-2637, 1397-7543, 1397-8872, 1397-3464,



18-7072
CARB KIT
Replaces: 1397-3306, 1397-4329,
1397-5635, 1397-6638, 823426A1



18-7076
CARB KIT
Replaces: 1397-6367, A1



18-7077
CARB KIT
Replaces: 1397-8952, 823426A1



18-7078
CARB KIT
Replaces: 1397-2605



18-7080
CARB KIT
Replaces: 1398-3089



18-7081
CARB KIT
Replaces: 1396-4656
Contains adjustable needles and seats



18-7095
CARB KIT
Replaces: 1397-7539, 1397-7540,
1397-7544, 1397-8535, 1397-9723



18-7096
CARB KIT
Replaces: 1396-5238, 1396-5222
Contains adjustable needles and seats



18-7097
CARB KIT
Replaces: 3302-9437, 3302-804845
MerCarb 2 bbl. bottom fill accelerator pump 1983-1986
MCM 120, 140, 470, 185, 200, 898.



18-7098-1
CARB KIT
Replaces 3302-804844002
MerCarb 2 bbl. side fill accelerator pump
1986 and UP MCM 4-cyl., V6 & V8



18-7728
CARB KIT



18-7749
CARB KIT
Replaces: 809065, 835076, 823728



18-7748
CARB KIT
Replaces: 809064

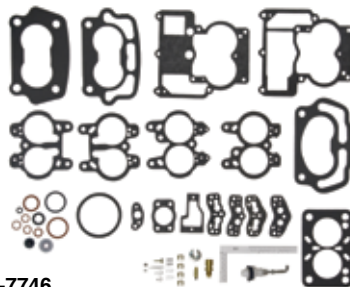

18-7746
CARB KIT
Replaces: 823427A1
Repair Kit for 2 BBL Rochester



18-7200
FLOAT
Replaces: 1397-2060
(Alcohol Resistant)
Plastic



CARBURETOR KIT/FLOAT APPLICATION

Model & Serial #	Mercruiser Carb. #	Mfg. Carb. #	Carb. Code & Model	Carb. Kit ①	Float
MCM 80 ALL	1346-2770	RBS-4394S	C1/RBS	18-7080	—
MCM 90					
3225967 & BELOW	1351-4263A1	7040082	R2/2GC	18-7746	18-7200
3225968 & ABOVE	1351-4263A2	7041369	R2/2GC	18-7746	18-7200
MCM110 ALL	1336-2076	7036543	R2/2GC	18-7070	18-7200
MCM 120/2.5L					
2520424 & BELOW	1336-2076	7036543	R2/2GC	18-7746	18-7200
2520425-3377340	1336-3594A1	7036543	R2/2GC	18-7746	18-7200
3377341-3770649	1351-4263A3	7041369	R2/2GC	18-7746	18-7200
3770650-4469865	1351-5202A1	7043182	R2/2GC	18-7746	18-7200
4469866-5192047	1351-6065A2	7044182	R2/2GC	18-7746	18-7200
5192048-6229717	1351-7354A1	17059054	R2/2GC	18-7746	18-7200
6229718 & ABOVE	1351-8480A2	17081060	R2/2GC	18-7746	18-7200
6229718 & ABOVE	1389-8490A2	N/A	M2/Mercarb	18-7097	18-7202
6229718 & ABOVE	1389-9350A2	N/A	M2/Mercarb	18-7097	18-7202
6229718 & ABOVE	1389-9562A1	N/A	M2/Mercarb	18-7098-1	18-7202
MCM 140 /3.0L/3.0LX(4 cyl.)					
2816416 & BELOW	1351-3635A1	7036646	R2/2GC	18-7746	18-7200
2816417-3332137	1351-4032A1	7040080	R2/2GC	18-7746	18-7200
3332138-3771644	1351-4293A1	7040084	R2/2GC	18-7746	18-7200
3771645-5157668	1351-5203A1	7043184	R2/2GC	18-7746	18-7200
5157669-6229717	1351-7355A1	17059052	R2/2GC	18-7746	18-7200
6229718-C856558	1351-8480A2	17081060	R2/2GC	18-7746	18-7200
6229718-C856558	1389-8490A2	N/A	M2/Mercarb	18-7097	18-7202
6229718-C856558	1389-9350A2	N/A	M2/Mercarb	18-7097	18-7202
6229718-C856558	1389-9562A1	N/A	M2/Mercarb	18-7098-1	18-7202
C856559 & ABOVE	1389-815396A2	N/A	M2/Mercarb	18-7098-1	18-7202
C856559 & ABOVE	1389-815397A2	N/A	M2/Mercarb	18-7098-1	18-7202
MCM 140 (6 cyl)					
ALL (BC)	1338-2161	7025638	R1/BC	18-7071	—

① Does not include metering rods

CARBURETOR KIT/FLOAT APPLICATION (Cont.)

Model & Serial #	Mercruiser Carb. #	Mfg. Carb. #	Carb. Code & Model	Carb. Kit ①	Float
ALL (B)	1338-2166	7025662	R1/B	18-7071	—
MCM 150					
1823489 & BELOW	1338-2428	7024180	R1/BC	18-7071	—
1823489 & BELOW	1338-2431	7024181	R1/B	18-7071	—
1823490-1830151	1338-2608	7025183	R1/BC	18-7071	—
1823490-1830151	1338-2609	7025184	R1/B	18-7071	—
1830152 & ABOVE	1338-2633	7025188	R2/2GC	18-7070	18-7200
MCM 160					
2492035 & BELOW	1338-2991	7026088	R2/2GC	18-7746	18-7200
2492036 & ABOVE	1351-3635A1	7036646	R2/2GC	18-7746	18-7200
MCM 165 (6 cyl)					
3354701 & BELOW	1351-4282A1	7040083	R2/2GC	18-7746	18-7200
3354702-3774864	1351-4871A1	7042183	R2/2GC	18-7746	18-7200
3774865-5178958	1351-5204A1	7043183	R2/2GC	18-7746	18-7200
5178959 & ABOVE	1351-7356A1	17059050	R2/2GC	18-7746	18-7200
MCM 165/170/3.7L (4 cyl)					
6218037-6916778	1389-8489A5	N/A	M2/Mercarb	18-7097	18-7202
6916779 & ABOVE	1389-9564A1	N/A	M2/Mercarb	18-7098-1	18-7202
MCM 175/4.3L/185 (V-6) (229 CID) ALL	3304-9565A1	N/A	M2/Mercarb	18-7098-1	18-7202
A221455-D714106	3300-8886A2	17083515	R4/4MV	18-7095	18-7201
185 (262 CID)					
A221455-B527954	3304-9353A2	N/A	M2/Mercarb	18-7097	18-7202
MCM 205 (262 CID)	3304-9354A2	—	R4/4MV	18-7095	18-7201
A331455-D714369	3304-9565A1	N/A	M2/Mercarb	18-7098-1	18-7202
MCM/MIE 470 ALL	1376-5990A1	17057132	R2/2GC	18-7076	18-7202
MCM 485 ALL	1376-5990A1	17057132	R2/2GC	18-7076	18-7202
MCM 488 ALL	1347-8460A3	17081299	R4/4ME	18-7077	18-7201
MCM 888					
ALL HOLLEY	1356-4642	D1JJ-9510-8	H2/2300	18-7081	18-7206
ALL ROCHESTER	1376-5659A1	7044185	R2/2GC	18-7075	18-7202
MCM 180/190/3.7LX					
(4 cyl)	1347-9142A2	17083522	R4/4MV	18-7095	18-7201
MIE 198/200/5.0L					
6021383 & BELOW	1376-6491A1	17057139	R2/2GV	18-7075	18-7202
6021384 & ABOVE	1376-8295A3	17080350	R2/2GV	18-7075	18-7202
MCM 200 (6 cyl)					
2494935 & BELOW	1347-3237A2	7037082	R4/4MV	18-7072	18-7201
2494936 & ABOVE	1347-3237A4	7037082	R4/4MV	18-7072	18-7201
MCM 898/200/5.0L					
6218462 & ABOVE	1389-8488A2	N/A	M2/Mercarb	18-7097	18-7202
6218462 & ABOVE	1389-9563A1	N/A	M2/Mercarb	18-7098-1	18-7202
6218462 & ABOVE	1389-9670A2	N/A	M2/Mercarb	18-7098-1	18-7202
MCM 205/4.3LX (V-6 262 CID)					
A331455-D714369	3304-9354A2	17084516	R4/4MV	18-7095	18-7201
MCM/MIE 215 ALL	1356-4066	C9FF-9510-E	H4/4160	18-7096	18-7206
MCM/MIE 225 (FORD)					
ALL	1356-5155	D2JL-9510-C	H4/4160	18-7096	18-7206
MCM/MIE 225 (GM)	1337-2103	7025564	R4/4GC	18-7078	—
1536920-2694014	1337-2604	7025756	R4/4GC	18-7078	—
	1347-3353	7037082	R4/4MV	18-7072	18-7201
	1347-3237A3	7037082	R4/4MV	18-7072	18-7201
MCM 228					
5069430 & BELOW	1347-6427A1	17057282	R4/4MV	18-7072	18-7201
MCM 228TR/ MIE 228					
5069430 & BELOW	1347-6438A1	17057283	R4/4MV	18-7072	18-7201
MCM 228/230/5.0L					
5069431-6021783	1347-7361A1	17059292	R4/4MV	18-7095	
6021784-6218461	1347-8296A4	17080565	R4/4MV	18-7095	18-7201
6218462 & ABOVE	1347-9661A3	—	R4/4MV	18-7095	18-7201
MIE 228					
5067431-6040745	1347-7364A1	17059291	R4/4MV	18-7095	18-7201

① Does not include metering rods

CARBURETOR KIT/FLOAT APPLICATION (Cont.)

Model & Serial #	Mercruiser Carb. #	Mfg. Carb. #	Carb. Code & Model	Carb. Kit ①	Float
6040746 & ABOVE	1347-8290A1	17080564	R4/4MV	18-7095	18-7201
MIE 230/5.0L ALL	1347-8290A1	17080564	R4/4MV	18-7095	18-7201
230/5.0LX	1347-9661A3	—	R4/4MV	18-7095	18-7201
MCM/MIE 233					
4465029 & BELOW	1376-5744A1	7044187	R2/2GC	18-7075	18-7202
4465030 & ABOVE	1376-6152A1	17056197	R2/2GC	18-7075	18-7202
MCM/MIE 250 AUTO. CHOKE					
4767999 & BELOW	1347-3353	7037082	R4/4MV	18-7072	18-7201
MCM/MIE 250 (EL. CHOKE)					
4767999 & BELOW	1347-3237A3	7037082	R4/4MV	18-7072	18-7201
MCM 250					
4768000 & ABOVE	1347-6492A1	17057298	R4/4MV	18-7072	18-7201
MCM/MIE 255 (GM)					
4924564 & BELOW	1347-5732A1	7044291	R4/4MV	18-7072	18-7201
4924565-5195908	1347-7062A1	17057295	R4/4MV	18-7072	18-7201
5195909-5907067	1347-7365A1	17059289	R4/4MV	18-7095	18-7201
5907068 & ABOVE	1347-8289A1	17080562	R4/4MV	18-7095	18-7201
MCM/MIE 255 (FORD)					
ALL	1356-5169	D2JL-9510E	H4/4160	18-7096	18-7206
MCM 260/5.7L BRAVO					
5060805 & BELOW	1347-6492A1	17057298	R4/4MV	18-7072	18-7201
5060806-6024393	1347-7362A1	17059288	R4/4MV	18-7095	18-7201
6024394-B525981	1347-8292A4	17080561	R4/4MV	18-7095	18-7201
B525982 & ABOVE	1347-9662A4	—	R4/4MV	18-7095	18-7201
MIE 260/5.7L 350 MAG					
A635178-D617327	1347-8289A1	17080562	R4/4MV	18-7095	18-7201
MIE 5.7 SKI					
A339533-F205099	1347-9415T	17085013	R4/4MV	18-7095	18-7201
MCM/MIE 270 ALL	1347-4180A1	7029285	R4/4MV	18-7072	18-7201
MCM 280					
4176468 & BELOW	1347-4179A2	7040283	R4/4MV	18-7072	18-7201
4176469 & ABOVE	1347-5981A1	7044290	R4/4MV	18-7072	18-7201
MCM 300 MR/TRS (GM)					
6668677 & ABOVE	1347-7498A7	—	R4/4MV	18-7095	18-7201
MCM/MIE 325 AUTO. CHOKE					
3042730 & BELOW	1347-3342	7027080	R4/4MV	18-7072	18-7201
3042731 & ABOVE	1347-4533A1	7041831	R4/4MV	18-7072	18-7201
MCM/MIE 325 EL. CHOKE					
2278747-378099	1347-3689A1	7029280	R4/4MV	18-7072	18-7201
MCM 330/454 MAGNUM (ALPHA ONE)					
5027230 & BELOW	1347-6493A1	17057287	R4/4MV	18-7072	18-7201
5027231-6083144	1347-7363A1	17059290	R4/4MV	18-7095	18-7201
6083145 & ABOVE	1347-8291A3	17080563	R4/4MV	18-7095	18-7201
MIE 330					
5226384 & BELOW	1347-6493A1	17057287	R4/4MV	18-7072	18-7201
5226385 & ABOVE	1347-7366A1	17059287	R4/4MV	18-7095	18-7201
MIE 340/7.4L					
ALL	1347-8288A1	17080560	R4/4MV	18-7095	18-7201
MCM 350 MAGNUM/5.7L BRAVO					
B525992-317327	1347-8289A1	—	R4/4MV	18-7095	18-7201
MIE 350 ALL	1347-5326A2	17065977	R4/4MV	18-7072	18-7201
MCM 370/400 ALL	1347-7498A2	17059280	R4/4MV	18-7095	18-7201
MCM 7.4L (BRAVO ONE)	1347-8291A3	17080563	R4/4MV	18-7095	18-7201
MCM 454 7.4L					
6083145-B816540	—	—	H4/4150, R6647A	18-7728	—
MCM 454 MAGNUM (BRAVO ONE)					
ALL	1347-7498A2	17059280	R4/4MV	18-7095	18-7201
ALL	1347-9863A3	—	R4/4MV	18-7095	18-7201
MCM 502 MAGNUM (BRAVO ONE)					
C878221-D857199	1347-814623A2	—	R4/4MV	18-7095	18-7201
MCM 8.2L	1347-814623A2	—	R4/4MV	18-7095	18-7201

① Does not include metering rods



**18-7228
FLAME ARRESTOR**
Replaces: 85784A1, 805016A1



**18-7229
FLAME ARRESTOR**
Replaces: 85785T, 85785-2

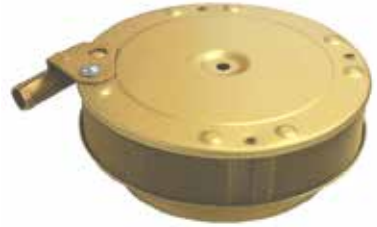

**18-7230
FLAME ARRESTOR**
Replaces: 41639A-1, 41639



**18-7231
FLAME ARRESTOR**
Replaces: 85785A2



**18-7232
FLAME ARRESTOR**
Replaces: 57882, 57882T



**18-7234
FLAME ARRESTOR**
Replaces: 805016A1

**ANODIZED ALUMINUM
FLAME ARRESTOR SPECIFICATIONS**

ENGINE	PART NO.	HEIGHT A	ELEMENT B	THROAT C	VENT TUBES*
4 & 6 cyl.	18-7228	2.156	1.088	3.120	1
4 & 6 cyl.	① 18-7234	2.280	1.550	3.100	0
V-8	18-7229	2.250	1.470	5.050	0
V-8	18-7230	2.250	1.470	5.050	1
V-8	18-7231	2.250	1.470	5.050	2
Hi-Performance	18-7232	2.969	2.190	5.050	2

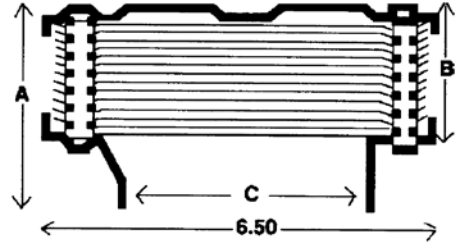

① 7" Outside diameter * Vent tubes accept 5/8 inch ID hose

ALL SIERRA FUEL PUMPS INCLUDE MOUNTING GASKET



**18-8861
FUEL PUMP W/ COOLER**
Replaces: 861156A02
For: GM V-6/ V-8 EFI 0L000000-0M299999

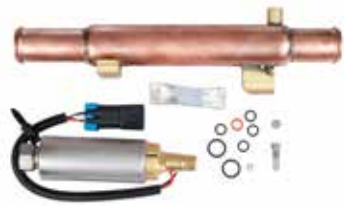

**18-8862
FUEL PUMP W/ COOLER**
Replaces: 861156A03
For: GM V-6/ V-8 EFI 0M300000



**18-8863
FUEL PUMP W/ COOLER**
Replaces: 861156A04
For: GM V-6/ V-8 engines with cool fuel 0K999999 & below



**18-8864
FUEL PUMP W/ REGULATOR**
Replaces: 866169T01
For: Gm V-8 with Gen III Cool Fuel Module-high pressure



**18-8865
FUEL PUMP**
Replaces: 866170A01
For: Gm V-8 with Gen III Cool Fuel Module-low pressure



**18-8867
FUEL PUMP**
Replaces: 861155A6
For: 4.3L V-6



18-8868
FUEL PUMP
Replaces: 861155A3
For: 5.0/ 5.7L V-8



18-8860
FUEL PUMP
Replaces: 861677T
For: GM V-8 (454 & 502) applications



18-7256
FUEL PUMP
Flange I.D. # 6790,M3530
Replaces: 32722
For: GM (4 & 6 Cyl.)153, 230, 250, 292



18-7266
FUEL PUMP
Flange I.D. # 41413, M6696
For: Ford (V-8) 302, 351



18-7267
FUEL PUMP
Flange I.D. # 41414
Replaces: 62092,T
For Ford (V-8) 302



18-7274
FUEL PUMP
Flange I.D. # 41421, M73021
Replaces: 86246
For: GM (V-8) 305, 350, 400, 228 / 250 / 255 / 260 / 280



18-7275
FUEL PUMP
Flange I.D. # 41422
Replaces: 86247,T
For: GM (V-8) 454, 330 / 325 / 350 / 390



18-7278
FUEL PUMP
Flange I.D. # M60032
Replaces: 86234A4, 86234A05
For: GM (4 & 6 Cyl.) 153, 181, 225, 250, 120 / 140 / 160 / 165 / 470 / 485 / 488



18-7282
FUEL PUMP
Flange I.D. # M60337
Replaces: 42725A3
For: GM (V-6) 225, 170 / 180 / 190



18-7283
FUEL PUMP
Flange I.D. # M60600
Replaces: 97401A2, 97401A2A8, 861678A1
For: GM (V-8) 305, 350, 228 / 230 / 260 / 898



18-7284
FUEL PUMP
Flange I.D. # M60315
Replaces: 41141A2,862077A1
For: GM (V-6) 231, 262, 229



18-7288-1
FUEL PUMP
Flange I.D. #60601
Replaces: 812454A1, 862048A1
For: Inline (4 cyl) 120, 140, 3.0L and 224 CID
7.4L / 454 / 420 / 330



18-7326
ELECTRIC FUEL PUMP
Replaces: 805656A2
For: 1992-93, 1996
F.I. & Carbureted 4.3L
with inline electric pump

APPLICATION ON NEXT PAGE

FUEL PUMP APPLICATION

Model	CID / # CYL	Year Range	Beginning Serial Number	Ending Serial Number	Fuel Pump #1	Fuel Pump #2	Pump Filter
120	153/L4	1964-1972	1666601	3377340	18-7278	①	—
120	153/L4	1964-1972	1666601	3377340	18-7256	②	—
120	153/L4	1972-1982	3377341	6229717	18-7278	—	18-7860
120	153/L4	1983-1986	6229718	B531853	18-7278	③	—
120			4469866	& Below	18-7278	—	—
120			4469866	4952700	18-7278	—	—
120			4952701	& Up	18-7278	—	—
120			5192049	6229717	18-7278	—	—
120/2.5L			6229718	& Up	18-7278	—	—
120/2.5L			6229718	& Up	18-7282	—	—
2.5L	153/L4	1987-1989	B531854	BC853255	18-7278	④	—
140 (4 CYL)	181/L4	1968-1982	2508261	6229717	18-7278	—	18-7860
140 (4 CYL)	181/L4	1983-1986	6229718	B450800	18-7278	⑤	—
3.0L	181/L4	1987-1989	B450801	C856558	18-7278	⑥	—
140			4460664	& Below	18-7278	—	—
140			4460665	4918569	18-7278	—	—
140			4918570	& Up	18-7278	—	—
140 (4 Cyl.)			5157669	6229717	18-7278	—	—
140/3.0L			6229717	& Below	18-7278	—	—
140/3.0L			6229718	& Up	18-7282	—	—
3.0L/3.0LX			C856559	& Up	18-7282	—	—
140 (6 Cyl.)			1538930	1725960	18-7256	—	—
150			1666495	2048046	18-7256	—	—
160			2048022	2770031	18-7278	—	—
165			4471566	4884834	18-7278	—	—
165			5178959	& Up	18-7278	—	—
165/3.7L (4 Cyl.)			6916779	& Up	18-7282	—	—
180/3.7-LX (4 Cyl.)			6916779	& Up	18-7282	—	—
175/4.3L (262 CID)			B527955	& Up	18-7284	—	—
185 (229 CID)			6330183	& Up	18-7284	—	—
185 (262 CID)			A331455	& Up	18-7284	—	—
470	224/L4	1976-1984	4208730	6916778	18-7278	—	18-7860
485	224/L4	1980-1982	5685394	6218036	18-7278	—	18-7860
488	224/L4	1983-1984	6170297	6916778	18-7278	⑦	—
140 (6 CYL)	194/L6	1963	1538930	1725960	18-7256	—	—
150	230/L6	1964-1966	1666495	2048046	18-7256	—	—
160	250/L6	1967-1969	2048022	2770031	18-7278	⑧	—
160	250/L6	1967-1969	2048022	2770031	18-7256	⑨	—
165 (6 CYL)	250/L6	1979-1981	2770032	5813433	18-7278	—	18-7860
200 (6 CYL)	250/L6	1969	2453769	2712072	18-7278	—	18-7860
200 GM			6218462	& Up	18-7283	—	—
200/5.0L GM			B525982	& Up	18-7283	—	—
185 (4bbl)	229/V-6	1983-1984	6330183	6919655	18-7284	—	—
175	262/V-6	1987	B527955	B773242	18-7284	—	—
185 (2bbl)	262/V-6	1985-1986	A331455	B527954	18-7284	—	—
205	262/V-6	1985-1987	A331455	B775129	18-7284	—	—
205/4.3L-LX (262 CID)			B527955	& Up	18-7284	—	—
262 MAG EFI (GEN +)	262/V-6	1996-1997	F803800	K999999	18-8867	—	—
4.3L	262/V-6	1988-1992	B773243	D714106	18-7284	—	—
4.3L (GEN II)	262/V-6	1992-1996	D714107	F802999	18-8867	—	—
4.3L (GEN +)	262/V-6	1998-2010	L012009	& Up	18-8868	—	—
4.3L EFI (GEN +)	262/V-6	1998-2001	L012009	M299999	18-8861	⑩	—
4.3L MPI	262/V-6	2002-2010	M300000	& Up	18-8862	⑪	—
4.3LH (GEN+)	262/V-6	1998-2002	L010044	M614999	18-8868	—	—
4.3LX	262/V-6	1988-1992	B775130	D714369	18-7284	—	—
4.3LX (GEN II)	262/V-6	1992-1996	D714107	F802999	18-8867	—	—
4.3LX (GEN +)	262/V-6	1996-1997	F803000	K999999	18-8867	—	—
4.3LXH (GEN +)	262/V-6	1996-1997	F803114	K999999	18-8867	—	—
215 (FORD)	302/V-8	1970-1972	2781153	3563181	18-7267	—	—
215 Ford			3085036	& Below	18-7267	—	—
215 Ford			3258182	& Up	18-7267	—	—
225 Ford	302/V-8	1973-1974	3385721	4166999	18-7267	—	—
228 MCM & MIE	305/V-8	1977-1978	4765100	5170008	18-7274	—	—
228 MCM & MIE	305/V-8	1979-1982	5170009	6218461	18-7274	—	—
228 MCM & MIE	305/V-8	1979-1982	5170009	6218461	18-7283	⑫	—
888 (FORD)	302/V-8	1971-1977	3108723	4887829	18-7267	—	—
228	305/V-8	1982-1984	6218462	6899268	18-7283	—	—
230 MIE	305/V-8	1981-1987	5907058	B788151	18-7283	—	—
230/5.0L-GM (IB)			B525206	& Up	18-7283	—	—
230 GM			6218462	& Up	18-7283	—	—
230/5.0L-LX GM			B525982	& Up	18-7283	—	—
230	305/V-8	1985-1987	6899269	B773739	18-7283	—	—
5.0L	305/V-8	1988-1995	B774445	F600999	18-7283	—	—
5.0L (GEN +)	305/V-8	1998-2010	L015751	& Up	18-8868	—	—
5.0L EFI (GEN +)	305/V-8	1998-2001	L012052	M299999	18-8861	⑬	—
5.0L MIE	305/V-8	1988	B788152	C396832	18-7283	—	—
5.0L MPI ALPHA	305/V-8	2002-2010	M300000	& Up	18-8862	⑭, ⑮	18-8868 ⑯
5.0L MPI BRAVO	305/V-8	2002-2004	M300000	W059999	18-8862	⑰, ⑱	18-8868 ⑲
5.0L MPI BRAVO	305/V-8	2004-2010	W060000	& Up	18-8864	⑲	18-8865 ⑲
5.0LX	305/V-8	1988-1995	B773740	F600999	18-7283	—	—
898	305/V-8	1977-1982	4762210	6218461	18-7274	⑳	—
898	305/V-8	1977-1982	4762210	6218461	18-7283	㉑	—
898	305/V-8	1983-1984	6218462	6899057	18-7283	—	—
233 FORD			4500860	& Up	18-7267	—	—
250	350/V-8	1977	4768000	4908849	18-7274	—	—
255	350/V-8	1975-1976	4175500	4767999	18-7274	—	—
255 MIE (GM)	350/V-8	1975-1980	4175500	5907057	18-7274	—	—
255 FORD			3258728	& Up	18-7267	—	—
255 GM			5195909	& Up	18-7274	—	—
260	350/V-8	1978-1982	4908850	6218461	18-7274	㉒	—
260	350/V-8	1978-1982	4908850	6218461	18-7283	㉓	—
260	350/V-8	1983-1987	6218461	& Up	18-7283	—	—
260 MIE	350/V-8	1981-1987	5907058	B788151	18-7283	—	—

- ① low pressure lift pump
- ② high pressure fuel cool pump
- ③ fuel pump mounted with filter bowl facing up
- ④ fuel pump mounted with filter bowl facing down
- ⑤ AC fuel pump
- ⑥ Carter fuel pump
- ⑦ mechanical fuel pump
- ⑧ use if fuel pump has sight glass
- ⑨ use if fuel pump has sight tube
- ⑩ fuel pump/cooler kit

FUEL PUMP APPLICATION

Model	CID / # CYL	Year Range	Beginning Serial Number	Ending Serial Number	Fuel Pump #1	Fuel Pump #2	Pump Filter
260/5.7 GM			B525982	& Up	18-7283	—	—
260 GM Inboard			5907058	& Up	18-7283	—	—
260/5.7L GM (IB)			5907058	& Up	18-7283	—	—
5.7L-GM			F025000	& Up	18-7283	—	—
280	350/V-8	1975-1976	4176250	4770199	18-7274	—	—
300MR/TRS GM	350/V-8	1985-1986	6668677	B430367	18-7283	—	—
320 EFI	350/V-8	1987-1989	A543604	C622418	N.L.A	—	—
325-GM			2278747	3640670	18-7275	—	—
330 GM			4623115	& Up	18-7275	—	—
330 GM/W.B.W.			6083145	& Up	18-7288-1	—	—
340/7.4L-GM (IB)			5889914	& Up	18-7288-1	—	—
350 MAG ALPHA	350/V-8	1986-1997	A635178	K999999	18-7823	—	—
350 MAG ALPHA EFI (GEN +)	350/V-8	1996	F800300	K001508	18-7283	—	—
350 MAG ALPHA EFI (GEN +)	350/V-8	1997	K001509	K999999	18-8863	Ⓜ	—
350 MAG BRAVO MPI	350/V-8	1995-1996	F415189	K001500	18-7283	—	—
350 MAG BRAVO MPI	350/V-8	1997	K001501	K999999	18-8863	Ⓜ	—
350 MAG EFI SKI	350/V-8	1994-1997	F215561	K999999	18-8863	Ⓜ	—
350 MAG MPI	350/V-8	1998-2001	L010019	M299999	18-8861	Ⓜ	—
350 MAG MPI ALPHA	350/V-8	2002-2010	M300000	& Up	18-8862	Ⓜ	18-8868 Ⓜ
350 MAG MPI BRAVO	350/V-8	2002-2004	M300000	W059999	18-8862	Ⓜ, Ⓜ	18-8868 Ⓜ
350 MAG MPI BRAVO	350/V-8	2004-2010	W060000	& Up	18-8864	Ⓜ	18-8865 Ⓜ
350 MAG MPI HORIZON	350/V-8	2002-2004	M300000	W059999	18-8862	Ⓜ, Ⓜ	18-8868 Ⓜ
350 MAG MPI HORIZON	350/V-8	2004-2007	W060000	A299999	18-8864	Ⓜ	18-8865 Ⓜ
350 MAG MPI HORIZON MIE	350/V-8	1999-2001	L304700	M299999	18-8861	Ⓜ	—
350 MAG MPI HORIZON MIE	350/V-8	2002-2004	M300000	M398371	18-8862	Ⓜ, Ⓜ	18-8868 Ⓜ
350 MAG MPI HORIZON MIE	350/V-8	2004-2007	M398372	A089999	18-8864	Ⓜ	18-8865 Ⓜ
350 MAG MPI MIE	350/V-8	1998-2001	L002008	M299999	18-8861	Ⓜ	—
350 MAG MPI MIE	350/V-8	2002-2004	M300000	M398371	18-8862	Ⓜ, Ⓜ	18-8868 Ⓜ
350 MAG MPI MIE	350/V-8	2004-2007	M398372	A089999	18-8864	Ⓜ	18-8865 Ⓜ
350 MAG MPI MIE	350/V-8	2002-2004	M300000	M398371	18-8862	Ⓜ, Ⓜ	18-8868 Ⓜ
350 MAG MPI MIE	350/V-8	1998-2001	L002008	M299999	18-8861	Ⓜ	—
350 MAG MPI MIE	350/V-8	2002-2004	M300000	M398371	18-8862	Ⓜ, Ⓜ	18-8868 Ⓜ
350 MAG MPI MIE	350/V-8	2004-2007	M398372	A089999	18-8864	Ⓜ	18-8865 Ⓜ
350 MAG MPI SKI	350/V-8	1995-1996	F350583	F799999	18-7283	—	—
350 MAG MPI SKI (GEN +)	350/V-8	1998-2001	L002600	M299999	18-8861	Ⓜ	—
350 MAG MPI SKI (GEN +)	350/V-8	2002-2007	M300000	A089999	18-8862	Ⓜ	18-8868 Ⓜ
350 MAG SKI	350/V-8	1991-1997	D505450	K999999	18-7283	—	—
350 GM			3780450	& Up	18-7275	—	—
(MAG-TOURNEY SKI)			D505450	& Up	18-7283	—	—
370 TRS-GM			6721528	& Up	18-7288-1	—	—
390-GM			2781129 - 2825059	2825059	18-7275	—	—
5.7L	350/V-8	1988-1997	B773305	K999999	18-7283	—	—
5.7L (GEN +)	350/V-8	1998-2010	L010037	& Up	18-8868	—	—
5.7L EFI	350/V-8	1995-1996	F225560	K001505	18-7283	—	—
5.7L EFI	350/V-8	1997-2001	K001506	M299999	18-8861	Ⓜ	—
5.7L MIE	350/V-8	1988-1997	B788152	K999999	18-7283	—	—
5.7L MIE (GEN +)	350/V-8	1998-2010	L002003	& Up	18-8868	—	—
5.7L MPI HORIZON MIE	350/V-8	2008-2010	A090000	& Up	18-8864	Ⓜ	18-8865 Ⓜ
5.7L MPI MIE	350/V-8	2008-2010	A090000	& Up	18-8864	Ⓜ	18-8865 Ⓜ
5.7L MPI SKI	350/V-8	2008-2010	A090000	& Up	18-8862	Ⓜ, Ⓜ	18-8868 Ⓜ
5.7L SKI	350/V-8	1985-1997	A338553	K999999	18-7283	—	—
5.7L SKI (GEN +)	350/V-8	1998-2010	L002005	& Up	18-8868	—	—
5.7LX	350/V-8	1996-1997	F601000	K999999	18-7283	—	—
5.7LX BRAVO EFI (GEN +)	350/V-8	1996	F800300	K001508	18-7283	—	—
5.7LX BRAVO EFI (GEN +)	350/V-8	1997	K001509	K999999	18-8863	Ⓜ	—
5.7LX EFI	350/V-8	1996	F752400	K001505	18-7283	—	—
5.7LX EFI	350/V-8	1997	K001506	K999999	18-8863	Ⓜ	—
5.7 GM (SKI)			B514627	& Up	18-7283	—	—
5.7L BRAVO (GM)350			B525982	& Up	18-7283	—	—
BLACK SCORPION SKI	350/V-8	1997	K040001	K999999	18-8863	Ⓜ, Ⓜ	—
BLACK SCORPION SKI	350/V-8	1998-2001	L000000	L679175	18-8861	Ⓜ, Ⓜ	—
BLACK SCORPION SKI	350/V-8	2001-2007	L679176	W698432	18-8861	Ⓜ, Ⓜ	18-8868 Ⓜ
SCORPION 350	350/V-8	2008-2010	W698433	& Up	18-8861	Ⓜ, Ⓜ	18-8868 Ⓜ
SCORPION 350 EC	350/V-8	2009-2010	W698433	& Up	18-8864	Ⓜ	18-8864 Ⓜ
233 (FORD)	351/V-8	1975-1977	4173000	4902304	18-7267	—	—
255 (FORD)	351/V-8	1973-1974	3258728	4175499	18-7267	—	—
377 MAG	377/V-8	2008-2010	A300000	& Up	18-8864	Ⓜ	18-8865 Ⓜ
377 SCORPION MCM	377/V-8	1999-2005	L416146	M907201	18-8861	Ⓜ	—
377 SCORPION SKI	377/V-8	1997-1998	K00656	L600314	18-8861	Ⓜ	—
MX 6.2L MPI	377/V-8	2000-2001	L680003	M299999	18-8861	Ⓜ	—
MX 6.2L MPI	377/V-8	2002-2004	M300000	W059999	18-8862	Ⓜ, Ⓜ	18-8868 Ⓜ
MX 6.2L MPI	377/V-8	2004-2007	W060000	A299999	18-8864	Ⓜ	18-8865 Ⓜ
MX 6.2L MPI HORIZON	377/V-8	2002-2004	M300000	W059999	18-8862	Ⓜ, Ⓜ	18-8868 Ⓜ
MX 6.2L MPI HORIZON	377/V-8	2004-2007	W060000	A299999	18-8864	Ⓜ	18-8865 Ⓜ
MX 6.2L MPI HORIZON MIE	377/V-8	2002-2004	M300000	M398394	18-8862	Ⓜ, Ⓜ	18-8868 Ⓜ
MX 6.2L MPI HORIZON MIE	377/V-8	2004-2010	M398395	& Up	18-8864	Ⓜ	18-8865 Ⓜ
MX 6.2L MPI MIE	377/V-8	2002-2004	M300000	M398394	18-8862	Ⓜ, Ⓜ	18-8868 Ⓜ
MX 6.2L MPI MIE	377/V-8	2004-2010	M398395	& Up	18-8864	Ⓜ	18-8865 Ⓜ
MX 6.2L MPI SKI	377/V-8	2002-2010	M317000	& Up	18-8862	Ⓜ, Ⓜ	18-8868 Ⓜ
MX 6.2L BLACK SCORPION SKI	377/V-8	2001	L670015	L679175	18-8861	Ⓜ	—
MX 6.2L BLACK SCORPION SKI	377/V-8	2001-2007	L679176	W698432	18-8861	Ⓜ, Ⓜ	18-8868 Ⓜ
SCORPION 377	377/V-8	2008-2010	W698433	& Up	18-8861	Ⓜ, Ⓜ	18-8868 Ⓜ
SCORPION 377 HO EC	377/V-8	2009-2010	A091488	A092170	18-8864	Ⓜ	18-8865 Ⓜ
325	427/V-8	1969-1972	2278747	3780449	18-7275	—	—
330	454/V-8	1977-1981	4623115	6083144	18-7275	—	—
330 WITH B/W	454/V-8	1982-1987	6083145	B816540	18-7288-1	—	—
340 MIE	454/V-8	1981-1987	5889914	B788365	18-7288-1	—	—
350 MIE	454/V-8	1974-1976	3780450	4623109	18-7275	—	—
370 TRS	454/V-8	1978-1987	4179554	B714586	18-7288-1	—	—
400 TRS	454/V-8	1980-1986	4179554	B457644	18-7288-1	—	—
420	454/V-8	1987-1989	A398941	B622418	18-7288-1	—	—
425-GM			A398941	& Up	18-7288-1	—	—
425	454/V-8	1990-1992	B622419	D725499	18-7288-1	—	—
425 (GEN V)	454/V-8	1992-1993	D763855	D937011	18-8860	—	—
440 TRS	454/V-8	1983-1986	4179554	B485220	18-7288-1	—	—

- Ⓜ low pressure lift pump
- Ⓜ high pressure fuel cool pump
- Ⓜ fuel pump mounted with filter bowl facing up
- Ⓜ fuel pump mounted with filter bowl facing down
- Ⓜ AC fuel pump
- Ⓜ Carter fuel pump
- Ⓜ mechanical fuel pump
- Ⓜ use if fuel pump has sight glass
- Ⓜ use if fuel pump has sight tube
- Ⓜ fuel pump/cooler kit

FUEL PUMP APPLICATION

Model	CID / # CYL	Year Range	Beginning Serial Number	Ending Serial Number	Fuel Pump #1	Fuel Pump #2	Pump Filter
450	454/V-8	1995-1996	F347100	F347277	18-8860	—	—
454 MAG ALPHA	454/V-8	1986-1988	A631894	B785148	18-7288-1	—	—
454 MAG BRAVO GM			B840126	& Up	18-7288-1	—	—
454 MAG BRAVO	454/V-8	1988-1992	A631894	B785148	18-7288-1	—	—
454 MAG BRAVO	454/V-8	1992-1997	D805069	K999999	18-8860	—	—
454 MAG EFI	454/V-8	1994-1996	F115700	F802349	18-8860	—	—
454 MAG EFI SKI	454/V-8	1995-1996	F215800	F820099	18-8860	—	—
454 MAG MPI	454/V-8	1996	F802350	K147349	18-8860	—	—
454 MAG MPI	454/V-8	1997	K147350	K999999	18-8861	Ⓜ	—
454 MAG MPI	454/V-8	1998-2001	L010029	M024999	18-8861	Ⓜ	—
454 MAG MPI HORIZON MIE	454/V-8	1998-2001	L002200	L674000	18-8861	Ⓜ	—
454 MAG MPI SKI	454/V-8	1996-1997	F820100	K999999	18-8860	—	—
470			5097479	& Below	18-7278	—	—
470			5097480	& Up	18-7278	—	—
470			5520115	6218036	18-7278	—	—
470			6218037	& Up	18-7278	—	—
485			5685394	& Up	18-7278	—	—
488			6170297	& Up	18-7278	—	—
525SC	454/V-8	1992-1999	D725809	L415623	18-8860	—	—
7.4L BRAVO	454/V-8	1988-1991	B771113	D603117	18-7288-1	—	—
7.4L BRAVO	454/V-8	1992-1997	D603118	K999999	18-8860	—	—
7.4L EFI MIE	454/V-8	1996-1997	F874815	K999999	18-8863	Ⓜ	—
7.4L MIE	454/V-8	1988-1992	B788366	D715493	18-7288-1	—	—
7.4L MIE	454/V-8	1992-1997	D715494	K999999	18-8860	—	—
7.4L MPI	454/V-8	1998-2001	L010003	M024330	18-8861	Ⓜ	—
7.4L MPI MIE	454/V-8	1995-1997	F563052	K147349	18-8860	—	—
7.4L MPI MIE	454/V-8	1997	K147350	K999999	18-8863	Ⓜ	—
7.4L MPI MIE	454/V-8	1997-2001	L002006	L674613	18-8861	Ⓜ	—
7.4LX BRAVO EFI	454/V-8	1996-1997	F820000	K999999	18-8863	Ⓜ	—
7.4LX BRAVO MPI	454/V-8	1996-1997	F602010	K999999	18-8860	—	—
7.4L W/HURTH (IB)			C391564	& Up	18-7288-1	—	—
390	482/V-8	1969-1970	2781129	2825059	18-7275	—	—
496 MAG & HO	496/V-8	2001-2004	M025000	W059999	18-8862	Ⓜ, Ⓜ	18-8868 Ⓜ
496 MAG & HO	496/V-8	2004-2010	W060000	& Up	18-8864	Ⓜ	18-8865 Ⓜ
8.1S MPI MIE & HO	496/V-8	2001-2004	M026000	W089999	18-8862	Ⓜ, Ⓜ	18-8868 Ⓜ
8.1S MPI MIE & HO	496/V-8	2004-2010	W090000	& Up	18-8864	Ⓜ	18-8865 Ⓜ
465	502/V-8	1992-1994	D456155	F213244	18-7275	—	—
500	502/V-8	1994-1998	F213293	L001772	18-7275	—	—
502 MAG BRAVO	502/V-8	1992-1993	D824589	F114528	18-8860	—	—
502 MAG EFI	502/V-8	1993-1995	D840650	F802599	18-8860	—	—
502 MAG MPI	502/V-8	1996	F802600	K147349	18-8860	—	—
502 MAG MPI	502/V-8	1997	K147350	K999999	18-8863	Ⓜ	—
502 MAG MPI	502/V-8	1998-2001	L017000	M024999	18-8861	Ⓜ	—
600SC	502/V-8	1992-2000	D725676	L601186	18-8860	—	—
8.2L MAG & HO	502/V-8	2010	A340340	& Up	18-8864	Ⓜ	18-8865 Ⓜ
8.2L MAG & HO MIE	502/V-8	2010	A350802	& Up	18-8864	Ⓜ	18-8865 Ⓜ
8.2L MIE	502/V-8	1993-1996	D857200	F819619	18-8860	—	—
8.2L MPI MIE	502/V-8	1996-1997	F819620	K147349	18-8860	—	—
8.2L MPI MIE	502/V-8	1997	K147350	K999999	18-8863	Ⓜ	—
8.2L MPI MIE	502/V-8	1998-2001	L002450	L674200	18-8861	Ⓜ	—

- Ⓜ low pressure lift pump
- Ⓜ high pressure fuel cool pump
- Ⓜ fuel pump mounted with filter bowl facing up
- Ⓜ fuel pump mounted with filter bowl facing down
- Ⓜ AC fuel pump
- Ⓜ Carter fuel pump
- Ⓜ mechanical fuel pump
- Ⓜ use if fuel pump has sight glass
- Ⓜ use if fuel pump has sight tube
- Ⓜ fuel pump/cooler kit

FUEL WATER SEPARATORS

Sierra fuel water separators remove over 99.8% of emulsified water from your gasoline. Sierra's 10 micron filters are over 90% efficient at removing particles as small as 10 micron. All filters flow @ 90 GPH to feed even the hungriest motor. Sierra 10 micron filters are recommended to prevent damage to sensitive inboard and outboard fuel injection systems.

**- UNIVERSAL DESIGN -
DIRECT REPLACEMENT FOR MERCURY AND YAMAHA
FUEL WATER SEPARATOR BRACKETS**



Bracket Type	Part #	Replaces	Bracket Type	Part #	Replaces
1/4" Stainless Steel	18-7777		1/4" Aluminum	18-7853-1	Mercury 89876A3
3/8" Stainless Steel	18-7776		3/8" Aluminum	18-7775	

FUEL WATER SEPARATOR KITS



21 MICRON FILTER KITS - FOR CARBURETED ENGINES

Kit Type	Part #	Micron Rating	Contents	Replaces
1/4" Aluminum (Short Filter)	18-7848-1	21	1 - 18-7844 filter & 1 18-7853-1 bracket 2 - 18-4256 1/4" pipe plugs	Mercury - 35-802893A4, Q4, 35-60494A4
1/4" Aluminum Bonus Pack Contains spare filter	18-7848-2	21	2 - 18-7844 filter & 1 18-7853-1 bracket 2 - 18-4256 1/4" pipe plugs	
1/4" Aluminum (Tall Filter)	18-7852-1	21	1 - 18-7845 filter & 1 18-7853-1 bracket 2 - 18-4256 1/4" pipe plugs	
1/4" Aluminum Bonus Pack Contains spare filter	18-7852-2	21	2 - 18-7845 filter & 1 18-7853-1 bracket 2 - 18-4256 1/4" pipe plugs	
3/8" Aluminum (Tall Filter)	18-7775-1	21	1 - 18-7845 filter & 1 18-7775 bracket 2 - 18-4264 3/8" pipe plugs	
1/4" Stainless Steel (Tall Filter)	18-7777-1	21	1 - 18-7845 filter & 1 18-7777 bracket 2 - 18-4256 1/4" pipe plugs	
3/8" Stainless Steel (Tall Filter)	18-7776-1	21	1 - 18-7845 filter & 1 18-7776 bracket 2 - 18-4264 3/8" pipe plugs	



10 MICRON FILTER KITS FOR FUEL INJECTED ENGINES

Kit Type	Part #	Micron Rating	Contents
1/4" Aluminum (Short Filter)	18-7983-1	10	1 - 18-7944 filter & 1 18-7853-1 bracket 2 - 18-4256 1/4" pipe plugs
1/4" Aluminum Bonus Pack Contains spare filter	18-7983-2	10	2 - 18-7944 filter & 1 18-7853-1 bracket 2 - 18-4256 1/4" pipe plugs
1/4" Aluminum (Tall Filter)	18-7982-1	10	1 - 18-7945 filter & 1 18-7853-1 bracket 2 - 18-4256 1/4" pipe plugs
1/4" Aluminum Bonus Pack Contains spare filter	18-7982-2	10	2 - 18-7945 filter & 1 18-7853-1 bracket 2 - 18-4256 1/4" pipe plugs
1/4" Aluminum (High Capacity Filter)	18-7966-1	10	1 - 18-7866 filter & 1 18-7853-1 bracket 2 - 18-4256 1/4" pipe plugs
3/8" Aluminum (Tall Filter)	18-7986-1	10	1 - 18-7945 filter & 1 18-7775 bracket 2 - 18-4264 3/8" pipe plugs
1/4" Stainless Steel (Tall Filter)	18-7984-1	10	1 - 18-7945 filter & 1 18-7777 bracket 2 - 18-4256 1/4" pipe plugs
3/8" Stainless Steel (Tall Filter)	18-7985-1	10	1 - 18-7945 filter & 1 18-7776 bracket 2 - 18-4264 3/8" pipe plugs



10 MICRON FILTER KITS WITH DRAIN BOWLS

Sierra AquaVue™ and metal bowl separator filters allow water to be drained from the filter to extend service life. Use the AquaVue™ bowl for outboard, above deck installations. USCG regulations require the use of the flame resistant metal bowl below deck.

Kit Type	Part #	Micron Rating	Contents
1/4" Aluminum w/ metal drain bowl	18-7951	10	1 - 18-7919 filter & 1 18-7853-1 bracket 1 - 18-7924 metal bowl 2 - 18-4256 1/4" pipe plugs
1/4" Stainless Steel w/ metal drain bowl	18-7938	10	1 - 18-7919 filter & 1 18-7777 bracket 1 - 18-7924 metal bowl 2 - 18-4256 1/4" pipe plugs

COMPACT BRACKET AND SEPARATOR KIT - FOR SMALL OUTBOARDS AND FRESH WATER APPLICATIONS



18-7774
COMPACT ALUMINUM BRACKET

18-7965-1
10 MICRON COMPACT SEPARATOR KIT
Contains:
1 - 18-7774 bracket
1 - 18-7865 filter



REPLACEMENT FILTERS



UNIVERSAL DESIGN - DIRECT REPLACEMENT FOR MERCURY

10 MICRON REPLACEMENT FILTERS			21 MICRON REPLACEMENT FILTERS		
Part #	Description	Replaces	Part #	Description	Replaces
18-7944	Short - 3.875"	Mercury - 35-807172, 35-802893Q	18-7844	Short - 3.875"	Mercury - 35-807172, 35-802893Q
18-7945	Long - 4.35"	Mercury - 35-802893Q			
18-7866	High Capacity - 6"		18-7845	Long - 4.35"	Mercury - 35-802893Q
18-7865	Compact 10 Micron				



10 Micron replacement filters and kits with drain bowls

REPLACEMENT FILTERS			REPLACEMENT BOWLS	
Part #	Description	Replaces	Part #	Description
18-7919	Spin on replacement	35-809097 Racor S3213	18-7924	Metal Collection Bowl
18-7920	Spin on replacement	Mercury 35-809099 Racor S3214	FILTER & BOWL KITS	
18-7947	Spin on replacement	Racor S3240	Part #	Description
18-7948	Spin on replacement Fits - 320RRAC01	35-886638 Racor S3227	18-7929	Filter & Metal Bowl Mercury Style Contains: 18-7919 filter, 18-7924 bowl
18-7949	Spin on replacement Fits - 660RRAC02	Racor S3232	18-7943	Filter & Metal Bowl Contains: 18-7920 filter, 18-7924 bowl
			18-7969	Filter & Metal bowl Contains: 18-7948 filter, 18-7924 bowl



18-7919
FUEL/WATER SEPARATING FILTER
 Replaces: Mercuriser 35-809097 and Racor™ S3213
 For styles with spin on drain bowls.



18-7784
FUEL FILTER
 Replaces:
 Mercuriser 35-11004A1, 35-803897Q1
 For: 2.5L/3.0L(6229718 & later), All MC224 CID (6218037 & later), All GM 262 CID (A331455 & later) with Carter Fuel Pumps



18-7977
"GEN III COOL FUEL SYSTEM" FUEL FILTER
 Replaces: 35-866171A01
 For: 350 Mag MPI Alpha/Bravo, 350 Mag MPI Horizon Alpha/Bravo, 350 Mag MPI Horizon MIE, 350 Mag MPI MIE, 496 MAG, 496 MAG H.O., 5.0 MPI Alpha/Bravo, 8.1L Inboard, 8.1L Inboard H.O., MX 6.2L MPI Alpha/Bravo, MX 6.2L MPI Horizon Alpha/Bravo, MX 6.2L MPI Horizon MIE, MX 6.2L MPI MIE



18-7964
TRANSMISSION FILTER KIT
 Replaces: 35-815419, 8791014241
 For: Mercuriser V-8 Inboard with Hurth Transmission



18-7855
FUEL FILTER
 Replaces: 1397-2150



18-7717
FILTER ELEMENT
 Replaces: 35-93568
 For: Rochester 2 bbl & 4 bbl Carburetors



18-7859
FUEL FILTER
 Replaces: 35-53336, 3302-9033, 35-53336Q
 For: Most GM Inline 4 & 6 cycle, Ford & Gm V-8's up to 400 HP and all Mercuriser 224 CID



18-7721
FUEL FILTER
 Replaces: 35-864572
 All MPI & EFI engines with boost pump, 8.1L & 496cid, for 3/8" ID fuel lines



18-7860
FUEL FILTER
 Replaces: 35-49088A2, 35-49088Q2
 (Used in 18-7278 Fuel Pump)
 For: Inline 4 & 6 cycle engines



18-7869
FUEL FILTER
 Replaces:
 1397-8767, 1397-8545
 For:

Model/HP	Serial #	Model/HP	Serial #
GM 2.5L/3.0L	6229718 & later	330 HP	6083145 & later
GM 5.0L/5.7L	6218462 & later	GM 255	590768 & later
All 205	A331455 & later	5.7L SKI 340,230	ALL
228 HP	6021784 & later	& 260 Inboards	



18-7873
FUEL FILTER
 Replaces: 35-808275
 For: Models D7.3/270 Bravo & MIE Diesel Engines 1994-96



18-79901
VST FILTER
 Replaces: 66L-13915-00-00
 Fits: 454 EFI(GenV) GM 1994-96
 454 EFI (SKI)(Gen V) GM 1995
 454 Mag Bravo MPI (Gen VI) GM 1996-97
 454 Mag MPI (SKI)(Gen VI) GM 1996-97
 502 EFI (Gen V) GM 1993-95
 502 Mag MPI (Gen VI) GM 1996
 7.4L MIE MPI (LH) Gen V GM 1995-96
 7.4L MIE MPI (LH) Gen VI GM 1996-97
 7.4LX Bravo MPI (Gen V) GM 1996
 7.4LX Bravo MPI (Gen VI) GM 1996-97
 8.2L MIE MPI (LH) Gen VI GM 1996-97



18-2641
VAPOR SEPARATOR TANK O-RING
 Replaces: 808500



**18-6457
COMPOSITE PULLEY**
Replaces: 807757T
3" OD Serpentine for 13/16"
width belt,
For Late model GM V6 & V8 engines



**18-3506
CIRCULATING PUMP**
Replaces: 46-879194401
For: V6 MCM SN: 1A063240 (2007)
- CURRENT



**18-3593
WATER PUMP**
Replaces: 884727
Late Model 4 cyl GM engines requiring
hose fitting



**18-3574
CIRCULATING WATER PUMP**
Big block GM engines with composite
timing covers
"Late Model" includes 482 and 502 CID
Replaces: 850454, 8504541



**18-3575
CIRCULATING WATER PUMP
(Bi-Directional)**
Replaces: 65142A1
For: GM Inline (4 & 6 Cyl.)



**18-3577
CIRCULATING
WATER PUMP
(Bi-Directional)**
Replaces: 67859, 17670,
811573,8504541
For: Big block GM engines with stamped
steel timing covers



**18-3573
CIRCULATING
WATER PUMP**
All 8.1L big-block GM engines
Replaces: 883925
For engines with composite timing cover



**18-3583
CIRCULATING WATER
PUMP
(Bi-Directional)**
Replaces: 60658, 8503991,
17437
For: GM V-6 & V-8 engines with stamped
steel timing covers.



**18-3584
CIRCULATING WATER PUMP**
Replaces: Mercruiser 71683A1, 883885
Mercruiser 215 to 255 & 888
For: Ford small block V-8 engines.



**18-3599
CIRCULATING WATER PUMP**
Replaces: Mercruiser 811841,
850399, 8503991
For late model GM V-6 & V-8 engines using a composite
timing cover



**18-3007
18-3007-10^①
IMPELLER**
Replaces: 47-89983, 4789983T
For 60 HP



**18-3016-1
IMPELLER KIT**
with gasket
Replaces: 47-862232A2
For: Late-model Bravo & High Performance. Includes
350 Mag., 4.3L., 496 Mag., 5.0L., 8.1S and MX 6.2L



**18-3017
18-3017-10^①
IMPELLER**
Replaces: 47-89984, 47-89984T4,
47-30221, 47-65960
For all #1, R, MR, Alpha Units thru S/N D494568.
Also for raw water pump on: 190 IB S/N 1564539-1720903
225 IB S/N 1539620-2278646



**18-3056
18-3056-10^①
IMPELLER**
Replaces: 47-43026-2
For Alpha I-Generation 2
S/N D494569 & Above
Mercuriser Vazer



**18-3087
IMPELLER**
Replaces: 47-59362, 47-59362T























**18-3109
WATER TUBE GUIDE**
Replaces: 23-29804, 23-29804T
(used with 18-3116 Housing)



**18-3110
WATER PUMP
HOUSING BUSHING**
Replaces: 26-38970
(Part of 18-3116 Housing)

① Discount shop pack of 10 - Priced per package

 <p>18-3114 INSERT CUP Replaces: 48752, 48752T (Part of 18-3116 Housing)</p>	 <p>18-3117 IMPELLER PLATE Replaces: 32435 For #1 Units thru S/N D494568</p>	 <p>18-3122 IMPELLER PLATE Replaces: 817276, 8172761 For Alpha I - Generation 2 S/N D494569 & Above</p>		
 <p>18-3350 WEAR PLATE Replaces: 94576</p>	 <p>18-3351 WEAR PLATE Replaces: 94916</p>	 <p>18-3293 IMPELLER KEY Replaces: 28-43037</p>		
 <p>18-3151 COUPLING Replaces: 816597</p>	 <p>18-3417 WATER PUMP BASE Replaces: 46-57234A1</p>	 <p>18-3420 WATER PUMP BASE Replaces: 46-44292A3</p>		
 <p>18-3421 WATER PUMP BASE Replaces: 46-48748A1</p>	 <p>18-3116 WATER PUMP HOUSING Replaces: 46-96148A1</p>	 <p>PKG. OF 2 18-2732 18-2732-9① WATER SHUTTER Replaces: 807166A3</p>		
 <p>18-2733 WATER SHUTTER Replaces: 99370A2</p>	 <p>18-2727 EXHAUST WATER SHUTTER Replaces: 60930</p>	 <p>18-3220 WATER TUBE Replaces: 32-54236 For #1 -R/MR/Alpha</p>	 <p>18-3221 WATER TUBE Replaces: 32-860220 For Gen II</p>	
 <p>18-3222 WATER TUBE GUIDE Replaces: 23-816583 For Gen II</p>	<p>PKG. OF 5</p>  <p>18-3226 18-3226-9① IMPELLER PUMP SCREW Replaces: 10-30720 For R units</p>	<p>PKG. OF 5</p>  <p>18-3227 18-3227-9① WATER PUMP DOWEL PIN Replaces: 17-35973 For R/MR, Alpha I</p>	<p>PKG. OF 5</p>  <p>18-3229 18-3229-9① WATER POCKET SCREW Replaces: 10-28668 For MR/Alpha</p>	 <p>18-3197 SCREW Replaces: 10-76156</p>

① Priced per Package

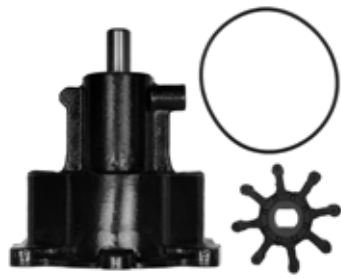

18-3160
SEA WATER PUMP, BRASS
 Replaces: 46-862914A13



18-3600
SEA WATER PUMP
 Replaces: 46-72774A32
 Fits: V8 Engines w/ith V-Belt and 2 piece pump



18-3155
WATER PUMP REPAIR KIT
 Replaces: 47-72774A89
 Fits: Bravo Seawater Pump with 2 piece housing



18-3216
IMPELLER KIT
 Replaces: 47-59362A4
 Fits: 1996-97 7.4L MIE MPI(LH) Gen VI GM 454 V8, 1996-97, 7.4L TBI MIE(LH) Gen VI GM 454 V8, 1996-97 8.2L MIE MPI(LH) Gen VI GM 502 V8.



18-3318
WATER PUMP KIT
 Replaces: 47-59362Q08
 Fits: Plastic 1 and 2 piece sea water pump body



18-3237
IMPELLER REPAIR KIT
 For: Bravo I, II, III (1988 & up) B664190 & up Fits Bravo drives with 1 piece housing

— CONTAINS —

Part #	Desc.	O.E. #	Qty.
18-3087	Impeller	47-59362	1
18-3350	Wear Plate	94576	1
18-7163	O-Ring	25-33465	



18-3214
IMPELLER REPAIR KIT
 Replaces: 47-43026T6, T8, T11
 For Alpha I - Generation II
 S/N D494569 & Above
 Mercruiser Vazer

① **18-3214D**

— CONTAINS —

Part #	Desc.	O.E. #	Qty.
18-2564	Impeller Gasket	22-43033-1, 27-43033-1	1
18-2565	Impeller Gasket	27-43047-1	1
18-2566	Impeller Gasket	27-817277	1
18-2944	Seal Ring	12-19183	1
18-3056	Impeller	47-43026-1, 47-43026-2	1
18-3122	Impeller Plate	817276	4
18-7420	O-Ring	25-21836	1



18-3217
IMPELLER KIT
 For #1 Units thru S/N D494568
 (Similar to #46-96148A5 without base or housing)

① **18-3217D**

— CONTAINS —

Part #	Desc.	O.E. #	Qty.
18-3109	Water Tube	23-29804	1
18-3017	Impeller	47-89984	1
18-2919	Water Pump Base to Gear Housing Gasket	27-42631-1	1
18-3110	Grommet	26-38970	1
18-2945	Gear Housing Drain Screw Gasket	12-19183	2
18-2826	Water Pump Base to Gear Housing Gasket	27-85610-1	1
18-2914	Lower Water Pump to Wear Plate Gasket	27-85608-1	1
18-2915	Upper Water Pump to Wear Plate Gasket	27-85609-1	1
18-2944	Seal Ring	26-45577	1
18-3117	Plate	32435	1
18-7158	O-Ring	25-30613	1
18-7162	O-Ring	25-33145	1
18-7173	O-Ring	25-30224	1
18-7176	O-Ring	25-90011	1
18-2801	Water Pump Gasket	27-32438	1
18-7196	O-Ring	25-38099	1
18-7426	O-Ring	35-30271	1



18-3150
WATER PUMP KIT
 Replaces: 46-807151A14
 For: Bravo

① **18-3309D**

18-3309
WATER PUMP KIT
 For: Bravo

— CONTAINS —

Part #	Desc.	O.E. #	Qty.
18-3350	Wear Plate	94576	1
18-3351	Wear Plate	94916	1
18-3087	Impeller	47-59362	1
18-0386	Body Gasket	27-94914	2
18-0916	Water Pump Gasket	27-805215-1	1



18-3147
WATER PUMP KIT
 Replaces: 817275T4
 For: Gen II-Lower
 s/n D469859 and Up

① Items ending in "D" are Display Packaged - Regular number is Non-Display

- CONTAINS -

Part #	Desc.	O.E. #	Qty.
18-3109	Water Tube	23-29804	1
18-3017	Impeller	47-89984	1
18-3116	Housing	46-96148A1	1
18-2919	Water Pump Base to Gear Housing Gasket	27-42631-1	1
18-3110	Grommet	26-38970	1
18-2945	Gear Housing Drain Screw Gasket	26-20260, 12-19183	2
18-2826	Water Pump Base to Gear Housing Gasket	27-85610-1	1
18-2914	Lower Water Pump to Wear Plate Gasket	27-85608-1	1
18-2915	Upper Water Pump to Wear Plate Gasket	27-85609-1	1
18-2944	Seal Ring	26-45577	1
18-3117	Plate	32435	1
18-7158	O-Ring	25-30613	1
18-7162	O-Ring	25-33145	1
18-7173	O-Ring	25-30224	1
18-7176	O-Ring	25-90011	1
18-2801	Water Pump Gasket	27-32438	1
18-7196	O-Ring	25-38099	1
18-7426	O-Ring	35-30271	1

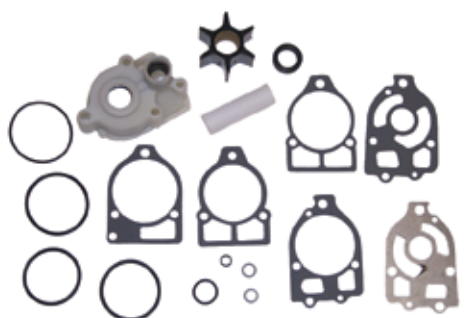

**18-3517
WATER PUMP KIT
Without Base**
Replaces: 46-96148A5, 46-60367A1, 46-96148A8

- CONTAINS -

Part #	Desc.	O.E. #	Qty.
18-3109	Water Tube	23-29804	1
18-3017	Impeller	47-89984	1
18-3116	Housing	46-96148A1	1
18-3420	Water Pump Base	46-44292A3	1
18-2919	Water Pump Base to Gear Housing Gasket	27-42631-1	1
18-3110	Grommet	26-38970	1
18-2945	Gear Housing Drain Screw Gasket	12-19183	2
18-2826	Water Pump Base to Gear Housing Gasket	27-85610-1	1
18-2914	Lower Water Pump to Wear Plate Gasket	27-85608-1	1
18-2915	Upper Water Pump to Wear Plate Gasket	27-85609-1	1
18-2944	Seal Ring	26-45577	1
18-3117	Plate	32435	1
18-7158	O-Ring	25-30613	1
18-7162	O-Ring	25-33145	1
18-7173	O-Ring	25-30224	1
18-7176	O-Ring	25-90011	1
18-2801	Water Pump Gasket	27-32438	1
18-7196	O-Ring	25-38099	1
18-7426	O-Ring	35-30271	1



**18-3320
WATER PUMP KIT**
For: MR/Alpha I Units
S/N 6854393-OD469858

- CONTAINS -

Part #	Desc.	O.E. #	Qty.
18-3109	Water Tube	23-29804	1
18-3017	Impeller	47-89984	1
18-3116	Housing	46-96148A1	1
18-3421	Water Pump Base	46-48748A1	1
18-2919	Water Pump Base to Gear Housing Gasket	27-42631-1	1
18-3110	Grommet	26-38970	1
18-2945	Gear Housing Drain Screw Gasket	12-19183	2
18-2826	Water Pump Base to Gear Housing Gasket	27-85610-1	1
18-2914	Lower Water Pump to Wear Plate Gasket	27-85608-1	1
18-2915	Upper Water Pump to Wear Plate Gasket	27-85609-1	1
18-2944	Seal Ring	26-45577	1
18-3117	Plate	32435	1
18-7158	O-Ring	25-30613	1
18-7162	O-Ring	25-33145	1
18-7173	O-Ring	25-30224	1
18-7176	O-Ring	25-90011	1
18-2801	Water Pump Gasket	27-32438	1
18-7196	O-Ring	25-38099	1
18-7426	O-Ring	35-30271	1



**18-3321
WATER PUMP KIT**
For: #1 Units with flush
S/N 2495186-2763441

- CONTAINS -

Part #	Desc.	O.E. #	Qty.
18-3109	Water Tube	23-29804	1
18-3017	Impeller	47-89984	1
18-3116	Housing	46-96148A1	1
18-2919	Water Pump Base to Gear Housing Gasket	27-42631-1	1
18-3417	Water Pump Base	46-57234A1	1
18-3110	Grommet	26-38970	1
18-2945	Gear Housing Drain Screw Gasket	12-19183	2
18-2826	Water Pump Base to Gear Housing Gasket	27-85610-1	1
18-2914	Lower Water Pump to Wear Plate Gasket	27-85608-1	1
18-2915	Upper Water Pump to Wear Plate Gasket	27-85609-1	1
18-2944	Seal Ring	26-45577	1
18-3117	Plate	32435	1
18-7158	O-Ring	25-30613	1
18-7162	O-Ring	25-33145	1
18-7173	O-Ring	25-30224	1
18-7176	O-Ring	25-90011	1
18-2801	Water Pump Gasket	27-32438	1
18-7196	O-Ring	25-38099	1
18-7426	O-Ring	35-30271	1
18-2919	Water Pump Gasket	27-46231-1	1



**18-3317
WATER PUMP KIT**
For: #1/R Units without flush
S/N 2763442-6854392

COMPLETE WATER PUMP KIT, IMPELLER REPAIR KIT, IMPELLER APPLICATION

Model	Serial Number	Complete Water Pump Kit	Upper Pump Housing	Upper Pump Kit	Water Pump Base	Impeller Repair Kit	Impeller
#1 Units with plastic flush screw in gear housing	2495186 - 2763441	18-3321	18-3116	18-3517	18-3421	18-3217	18-3017
#1 Units w/o flush screw in gear housing	2763442 - 6854392	18-3317 ①	18-3116	18-3517	18-3417 ①	18-3217	18-3017
MR/ALPHA I	6854393 - OD594568	18-3320	18-3116	18-3517	18-3420	18-3217	18-3017
ALPHA I - Generation II & Vazer	OD494569 & ABOVE	18-3147	--	18-3570	--	18-3214	18-3056
BRAVO/Inboards w/ Plastic pump body	3040411 & ABOVE	--	--	18-3150	--	18-3318	18-3087
BRAVO/Inboards w/ Brass pump body	OM100001 & ABOVE	--	--	18-3160	--	18-3016-1	--

① Models which have been retro-fitted with an Alpha style lower unit (no pre-load pin in top of driveshaft) must use Alpha style parts (18-3320 and 18-3420)

GENERATION II WATER PUMP ASSEMBLY

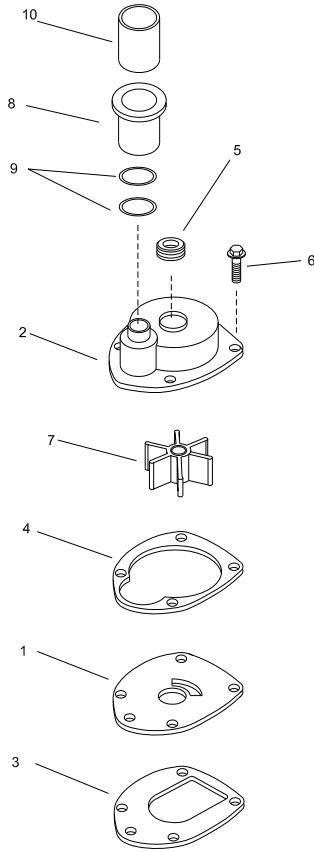

Sequence	Description	Part #	O.E. #	Qty.
1	Face Plate	18-3122	817276	1
2	Housing Assembly	N.S.S.	817275A1	1
3	Gasket, Base	18-2564	27-43033-1	1
4	Gasket, Housing	18-2566	27-817277	1
5	Seal, Face	18-2599	26-816575A2	1
6	Screw, Housing	N/A	10-816928	4
7	Impeller	18-3056	47-43026-2	1
8	Coupling Assembly	18-3151	47-43026T11	1
9	O-Ring	18-7420	25-21836	2
10	Sleeve	18-3222	23-816583	1

MR ALPHA WATER PUMP ASSEMBLY

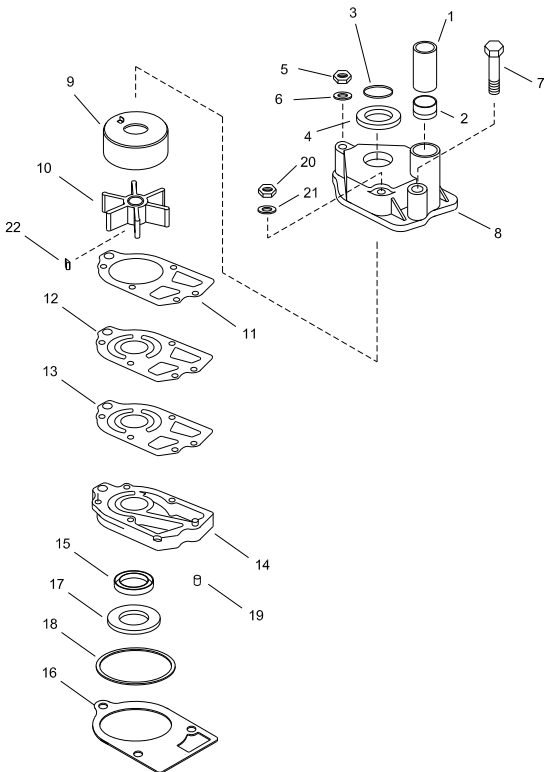

Sequence	Description	Part #	O.E. #	Qty.
1	Guide Sleeve	18-3109	23-29804	1
2	Seal, Sleeve Guide	18-3110	26-38970	1
3	Ring, Upper	18-7158	25-30613	1
4	Ring, Dust	18-7426	25-30271	1
5	Nut, Housing	N/A	11-13436	1
6	Washer, Housing	18-4270	12-36001	3
7	Screw, Housing	N/A	10-96411	1
8	Housing, Water Pump	18-3116	46-96148A1	1
9	Cup, Impeller	18-3114	48752T	1
10	Impeller	18-3017	48752	1
11	Gasket, Impeller	18-2915	47-89984	1
12	Plate, Impeller	18-3117	27-85609-1	1
13	Gasket, Stainless Steel Plate	18-2914	27-85608-1	1
14	Water Pump Base Assembly	18-3420	46-44292A3	1
15	Oil Seal, Water Pump Base	18-2013	26-16977	1
16	Gasket, Water Pump Base	18-2919	27-42631-1	1
17	Oil Seal, Water Pump Base	18-2014	26-89238	1
18	O-Ring, Water Pump Base	18-7176	25-90011	1
19	Pin, Alignment	N/A	17-42836	1
20	Nut, Housing	N/A	11-13438	1
21	Washer, Housing	18-4275	12-29245	2
22	Key, Impeller	N/A	28-56654	1

R WATER PUMP ASSEMBLY

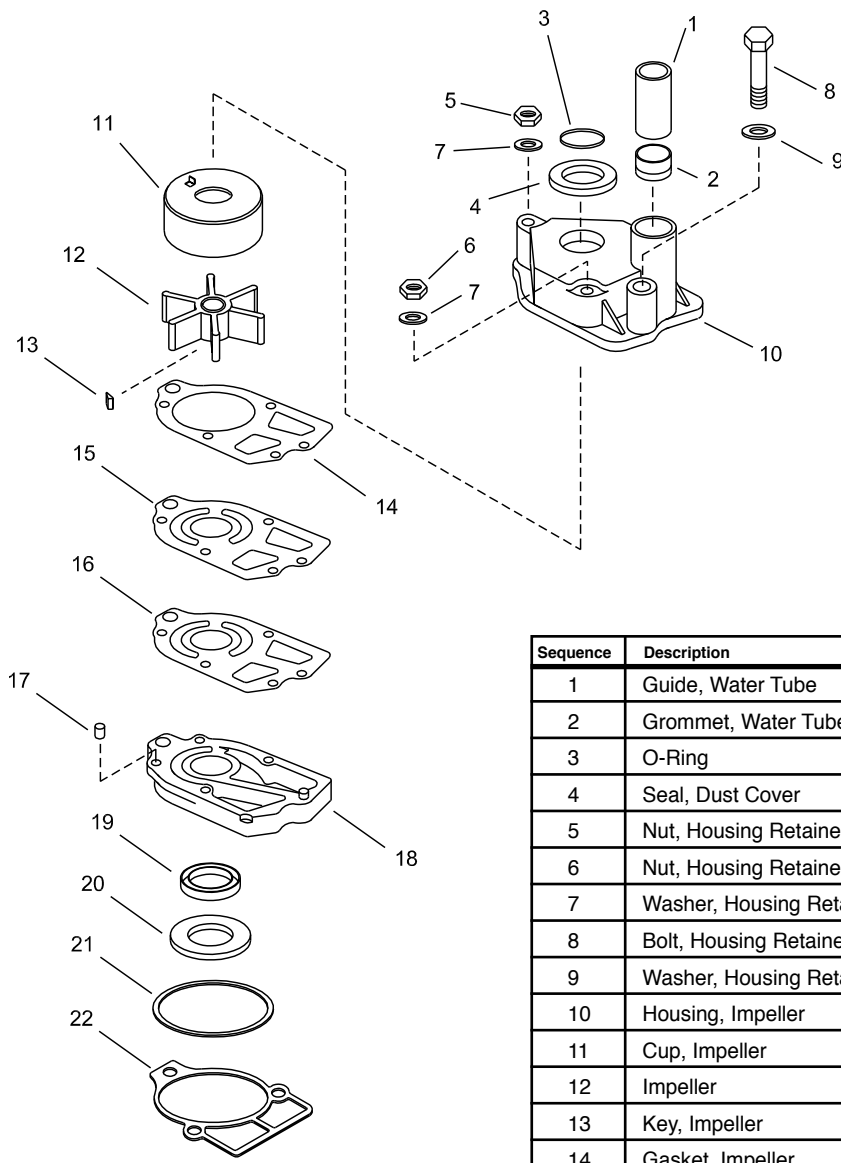

Sequence	Description	Part #	O.E. #	Qty.
1	Guide, Water Tube	18-3109	23-29804	1
2	Grommet, Water Tube Guide	18-3110	26-38970	1
3	O-Ring	18-7158	25-30613	1
4	Seal, Dust Cover	18-7426	25-30271	1
5	Nut, Housing Retainer	18-3723	11-45592	1
6	Nut, Housing Retainer	18-372211-20361, 11-35888		2
7	Washer, Housing Retainer	18-4275	12-29245	3
8	Bolt, Housing Retainer	18-3226	10-30720	1
9	Washer, Housing Retainer	18-4270	12-36001	1
10	Housing, Impeller	18-3116	46-96148A1	1
11	Cup, Impeller	18-3114	48752	1
12	Impeller	18-3017	47-89984	1
13	Key, Impeller	N/A	28-56654	1
14	Gasket, Impeller	18-2915	27-85609-1	1
15	Wear Plate, Impeller	18-3117	32435	1
16	Gasket Wear Plate	18-2914	27-85608-1	1
17	Pin, Alignment	18-3227	17-35973	1
18	Base Assembly	18-3417	46-57234A1	1
19	Oil Seal, Base Assembly	18-2013	26-16977	1
20	Oil Seal, Base Assembly	18-2014	26-89238	1
21	O-Ring, Base Assembly	18-7162	25-33145	1
22	Gasket, Base Assembly	18-2826	27-85610-1	1



**18-3549
THERMOSTAT**
Replaces: 14586
120°



**18-3550
THERMOSTAT**
Replaces: 59078
140°



**18-3551
THERMOSTAT**
Replaces: 59137,
807252T1
142°



**18-3552
THERMOSTAT**
Replaces: 76270, 76270T
160°



**18-3555
THERMOSTAT**
Replaces: 99155A1
160°



**18-3557
THERMOSTAT**
Replaces: 47594
143°



**18-3649
THERMOSTAT**
Replaces: 807252-2
160°



**18-3568
THERMOSTAT KIT**
Replaces: 99155T1

Model	Year	Serial #
5.7MIE	1998-2001	OL002003 & Up
MX6.2LMPI	2000-2001	OL680003 & Up
454 Horizon MIE	1998-2001	OL002200 & Up
502 Mag. MPI	1998-2001	OL017000 & Up



**18-3644
THERMOSTAT KIT**
—CONTAINS—

Part #	Description	O.E.#
18-3649	Thermostat 160°	807252T2
18-2553	Thermostat Cover Gasket	27-47510
18-2917	Thermostat Cover Gasket	27-53045-1



18-3646D [Display Package](#)

**18-3646
THERMOSTAT KIT**
Replaces: 807252Q3

—CONTAINS—

Part #	Description	O.E.#
18-3551	Thermostat	59137
18-2917	Thermostat Housing Gasket	27-53045-1, 27-33918
18-2844	Thermostat Cover Gasket	27-48818-1
18-2553	Thermostat Cover Gasket	27-47510
18-2834	Thermostat Cover Gasket	27-60208



18-3647D [Display Package](#)

**18-3647
THERMOSTAT KIT**
Replaces: 807252Q5

—CONTAINS—

Part #	Description	O.E.#
18-3649	Thermostat	807252-2
18-2844	Thermostat Cover Gasket	27-48818-1
18-2552	Thermostat Cover Gasket	27-33179-2
18-2553	Thermostat Cover Gasket	27-47510
18-7173	O-Ring	25-30224
18-2917	Thermostat Housing Gasket	27-53045-1, 27-33918



18-3648D [Display Package](#)

**18-3648
THERMOSTAT KIT**
160°



18-3650D [Display Package](#)

**18-3650
THERMOSTAT KIT**
—CONTAINS—

Part #	Description	O.E.#
18-2831	Thermostat Gasket	27-47590-1
18-3550	Thermostat	59078



18-3651D [Display Package](#)

**18-3651
THERMOSTAT KIT**
—CONTAINS—

Part #	Description	O.E.#
18-2554	Thermostat Cover Gasket	27-90556
18-2553	Thermostat Cover Gasket	27-47510
18-2834	Thermostat Cover Gasket	27-60208
18-2844	Thermostat Cover Gasket	27-48818-1
18-3551	Thermostat	59137



**18-3652
THERMOSTAT KIT**
—CONTAINS—

Part #	Description	O.E.#
18-2555	Thermostat Cover Gasket	27-89656-1
18-2843	Thermostat Cover Gasket	27-74830
18-3552	Thermostat	76270



**18-3667
THERMOSTAT KIT**
—CONTAINS—

Part #	Description	O.E.#
18-2555	Thermostat Cover Gasket	27-89656-1
18-3555	Thermostat	99155A1



18-3668D [Display Package](#)

**18-3668
THERMOSTAT KIT**
Replaces: 807252T4, 807252Q4

—CONTAINS—

Part #	Description	O.E.#
18-2552	Thermostat Cover Gasket	27-33179-2
18-2553	Thermostat Cover Gasket	27-47510
18-2554	Thermostat Cover Gasket	27-41812
18-3551	Thermostat	59137
18-7173	O-Ring	25-30224
18-2917	Thermostat Housing Gasket	27-53045-1, 27-33918



**18-1977-1
THERMOSTAT HOUSING**
Replaces: 47441A1
Fits 225, GM 260, 228, 898/198,
185R, 898R, 228R, 2GR

THERMOSTAT APPLICATION BEGINS ON NEXT PAGE

① Items ending in "D" are Display Packaged - Regular number is Non-Display



**18-1989
THERMOSTAT HOUSING**
Replaces: 87290A4, 861006A1
Stainless Steel
Use 18-1989K Thermostat Service Kit for replacement parts



**18-1993
THERMOSTAT HOUSING**
Replaces: 78984A01, 861493A3



**18-1994
THERMOSTAT HOUSING**
Replaces: 87290A4
For: Stainless Steel Version use 18-1989



**18-3530-1
THERMOSTAT HOUSING**
Replaces: 860256A4
For: GM V6 and V8 (305 & 350 ci)



**18-3531
THERMOSTAT HOUSING**
Replaces: 861188A1
Fits: MCM/MIE GM V-6 & V-8 305,350,454 & 502 cid engines with closed cooling systems



**18-3532
THERMOSTAT HOUSING AND COVER**
Replaces: 55131A5
Fits: MCM/MIE GM V6 & V8, 305, 350, 454, and 502cid, engines with closed cooling



**18-1910
THERMOSTAT HOUSING KIT**
Replaces: 861493A07
Fits: 3.0L GM 1999-Up, S/N 0L340999-Lower



**18-1989K
THERMOSTAT SERVICE KIT**
Service Kit for 18-1989 Thermostat Housing

THERMOSTAT APPLICATION

Engine / Model	CID / # CYL	Year Range	Beginning Serial #	Ending Serial #	Housing	Thermostat Cover	Thermostat & Gasket Kit	Thermostat	Gaskets Required	Gaskets Required - Design II	Gaskets Required - Design III
ROVER			3140000	UP	—			18-3551	—		
60	68/L4	1965-1968	1887079	2049044				18-3551			
80	80/L4	1966-1969	2049045	2851423				18-3551			
90	96/L4	1970-1972	2851424	3226957				18-3557	18-2831		
100 VASER	98/L4	2007-2010	w995000	& UP					18-1508		
110	153/L4	1963-1966	1537370	2044033		④		18-3551			
110	153/L4	1963-1966	1821720	2044033		⑥		18-3551			
120	153/L4	1964-1972	1666601	3377340		④		18-3551			
120	153/L4	1964-1966	1725593	2046624		⑥		18-3551			
120	153/L4	1967	2046625	2324346		⑥		18-3551			
120	153/L4	1968-1972	2324347	3377340	18-3650	⑥, ③	18-3650	18-3550	18-2831		
120	153/L4	1972-1986	3377341	B531853	18-3650	③	18-3650	18-3550	18-2831		
2.5L	153/L4	1987-1989	B531854	C853255	18-3650	③	18-3650	18-3550	18-2831		
140	181/L4	1968-1986	2508261	B450800	18-3650	③	18-3650	18-3550	18-2831		
140 (6 CYL)			1538930	1725960	—			18-3551			
3.0L	181/L4	1987-1989	B450801	C856558	18-3650	③	18-3650	18-3550	18-2831		
3.0L, FWC	181/L4	1990-2010	C856559	UP		⑥		18-3647	18-3649		
3.0L	181/L4	1990-1994	C856559	F603999	18-3650	⑦, ③		18-3650	18-3550	18-2831	
3.0L	181/L4	2000-2010	L341000	& UP		⑦		18-3647	18-3649	18-2552	
3.0L	181/L4	1998-2000	L010042	L340999	18-3650	⑦, ③		18-3650	18-3550	18-2831	
3.0L MPI	181/L4	2008-2010	A072812	& UP		⑥		18-3647	18-3649	18-2552	
3.0L MPI FWC	181/L4	2008-2010	A072812	& UP		⑥		18-3647	18-3649		
3.0LX, FWC	181/L4	1990-1997	C856559	K999999		⑥		18-3647	18-3649		
3.0LX	181/L4	1990-1997	C856559	K999999	18-1910	⑦, ③	18-3650	18-3550	18-2831		
150			1666495	2048046	—			18-3551			
160			2048022	2770031	—			18-3551			
160			2048022	2233574	—			18-3557			
160			2326069	2770031	—			18-3557	18-2831		
165			2770032	5813433	—		18-3650	18-3550	18-2831		
165	224/L4	1987	B434941	B774251	—		18-3667	18-3555	18-2555		
165			6916779	UP	—		18-3667	18-3555	18-2555		

- ① Design I
- ② Design II
- ③ Design III
- ④ Aluminum Exhaust Manifold
- ⑤ Cast Iron Exhaust Manifold
- ⑥ Closed Cooling
- ⑦ Standard Cooling
- ⑧ With check ball
- ⑨ Without check ball
- ⑩ SN 4167000 & Up
- ⑪ Original thermostat housing listed as NLA. Order update kit 87290A23
- ⑫ Original thermostat housing listed as NLA. Order update kit 90736A24
- ⑬ Complete thermostat housing kit kit
- ⑭ Single and 3-point drain system
- ⑮ 7-point drain system
- ⑯ Mechanical Throttle Body
- ⑰ Digital Throttle Body
- ⑱ Emission Control Engine
- ⑲ Manual drain system
- ⑳ Air Actuated drain system
- Ⓐ Old Design
- ♣ New Design
- ♣ 160 degree
- ♣ For Stainless Steel version use 18-1989

THERMOSTAT APPLICATION (Cont.)

Engine / Model	CID / # CYL	Year Range	Beginning Serial #	Ending Serial #	Housing	Thermostat Cover	Thermostat & Gasket Kit	Thermostat	Gaskets Required	Gaskets Required - Design II	Gaskets Required - Design III
170	224/L4	1985-1986	6916779	B434940	18-3667		18-3667	18-3555	18-2555		
175/4.3L 4.3 LX (262 CID)	③		B527955	UP	—		18-3668	18-3551	18-2553	18-2554	
175/4.3L 4.3 LX (262 CID)	④		B527955	UP	—		18-3668	18-3551	18-2552	18-2553	
175/4.3L 4.3 LX (262 CID)	④		F001220	UP	—		18-3648	18-3649	18-2552	18-2553	
180/3.7L-LX (4 CYL)			6916779	UP	—		18-3667	18-3555	18-2555	18-2553	
180	224/L4	1987	B436391	B775248			18-3667	18-3555	18-2555		
185 (229 CID)			6330183	6919655	18-1994	♥	18-3668	18-3551	18-2553	18-2554	
185 (262 CID)			A331455	B527954	18-1994	♥	18-3668	18-3551	18-2553	18-2554	
190			1564539	1730903	—		18-3667	18-3555	18-2555		
190	224/L4	1985-1986	6916779	B436390			18-3667	18-3555	18-2555		
3.7L	224/L4	1988-1989	B774552	& UP			18-3667	18-3555	18-2555		
3.7 LX	224/L4	1988-1989	B775249	& UP			18-3667	18-3555	18-2555		
470 MCM/MIE	224/L4	1976-1982	4208730	6218036			18-3667	18-3552	18-2552		
470	224/L4	1983-1984	6218037	6916778			18-3667	18-3555	18-2555		
485	224/L4	1980-1982	5685394	6218036			18-3667	18-3552	18-2552		
488	224/L4	1983-1984	6170297	6916778			18-3667	18-3555	18-2555		
140 (6 CYL)	194/L6	1963	1538930	1725960				18-3551			
150	230/L6	1964-1966	1666495	2048046	④			18-3551			
150	230/L6	1964-1966	1727985	2048046	⑤			18-3551			
160	250/L6	1967-1969	2048022	2770031	④			18-3551			
160	250/L6	1967	2048022	2233574	⑤			18-3551			
160	250/L6	1968-1969	2326096	2770031	18-1910	③, ④		18-3557	18-2831		
165 (6 CYL)	250/L6	1970-1981	2770032	5813433	18-1910	③	18-3650	18-3550	18-2831		
200 (6 CYL)	292/L6	1969	2453769	2712072	18-1910	③		18-3557	18-2831		
185 (4bb)	229-V-6	1983-1984	6330183	6919655	18-3678		18-3668	18-3551	18-2554	18-2553	18-2917
175	262/V-6	1987	B527955	B773242	18-1994	①	18-1977-1	18-3668	18-3551	18-2554	18-2917
175	262/V-6	1987	B527955	B773242	②, ③		18-3668	18-3551	18-2553	18-2917	
185 (2bb)	262/V-6	1985-1986	A331455	B527954	18-1994		18-1977-1	18-3668	18-3551	18-2554	18-2917
205	262/V-6	1985-1986	A331455	B527954	18-3668		18-1977-1	18-3668	18-3551	18-2554	18-2917
205	262/V-6	1987	B527955	B775129	18-3668	①	18-1977-1	18-3668	18-3551	18-2554	18-2917
205	262/V-6	1967	B527955	B775129	②, ③		18-3668	18-3551	18-2552	18-2553	18-2917
205/4.3L 4.3 LX (262 CID)	④		B527955	D714369	—	②	18-3668	18-3551	18-2552	18-2553	
205/4.3L 4.3 LX (262 CID)	④		F001220	UP	—		18-3648	18-3649	18-2552	18-2553	
215 FORD			2781153	3040410	—			18-3551			
215 FORD			3040411	UP	—		18-3651	18-3551	18-2834		
215 FORD MCM/MIE			3040411	3385720	—		18-3646	18-3649	18-2834		
225 FORD MCM/MIE			3385721	4176999	—		18-3646	18-3649	18-2834		
262 MAG EFI ALPHA	262/V-6	1996-1997	0F803800	0K999999	18-3647		18-3647	18-3649	18-2917		
262 MAG EFI BRAVO	262/V-6	1996-1997	0F803800	0K999999	18-3647		18-3647	18-3649	18-2917		
4.3L	262/V-6	1988-1993	B773243	F000877	18-1994	①	18-1977-1	18-3668	18-3551	18-2554	18-2917
4.3L	262/V-6	1987-1993	B773243	F000877		②, ③		18-3668	18-3551	18-2552	18-2917
4.3L	262/V-6	1993-1995	F000878	F601126	18-3647	②, ④		18-3668	18-3649	18-2917	18-2552
4.3L	262/V-6	1993-1995	F000878	F601126		⑤		18-3668	18-3551	18-0398	
4.3L FWC	262/V-6	1993-2002	F000878	M614999	18-3531	⑥		18-3568	18-3555	18-0398	
4.3L ALPHA	262/V-6	1996-2002	0F601127	M614999	18-3647	⑦		18-3647	18-3649	18-2917	
4.3L BRAVO	262/V-6	1996-2002	0F601127	M614999	18-3647	⑦		18-3647	18-3649	18-2917	
4.3L FWC	262/V-6	2002-2010	M615000	& UP		⑧		18-3647	18-3649	18-0398	
4.3L	262/V-6	2002-2010	M615000	& UP		⑦	18-3647	18-3649	18-0398		
4.3L EFI FWC	262/V-6	1998-2001	L012009	M299999	18-3531	⑧		18-3568	18-3555	18-0398	
4.3L EFI ALPHA	262/V-6	1998-2001	L012009	M299999		⑦		18-3647	18-3649	18-0398	
4.3L EFI BRAVO	262/V-6	1998-2001	L012009	M299999	18-3530-1	⑦		18-3647	18-3649	18-0398	
4.3L MPI	262/V-6	2002-2010	M300000	& UP		⑦, ④		18-3647	18-3649	18-0398	
4.3L MPI	262/V-6	2002-2010	M300000	& UP		⑦, ⑤		18-3647	18-3649	18-0398	
4.3L MPI EC	262/V-6	2010-2011	A637496	& UP		⑦, ⑧		18-3647	18-3649	18-0398	
4.3L MPI FWC	262/V-6	2002	M300000	M614999		⑧	18-3568	18-3555	18-0398		
4.3L MPI FWC	262/V-6	2002-2010	M615000	& UP		⑧		18-3647	18-3649	18-0398	
4.3LH FWC	262/V-6	1998-2002	L010044	M614999	18-3531	⑧		18-3568	18-3555	18-0398	
4.3LH ALPHA	262/V-6	1998-2002	L010044	M614999		⑦		18-3647	18-3649	18-0398	
4.3LH BRAVO	262/V-6	1998-2002	L010044	M614999	18-3530-1	⑦		18-3647	18-3649	18-0398	
4.3LX	262/V-6	1988-1993	B775130	F001219	18-1994	①	18-1977-1	18-3668	18-3551	18-2554	18-2917
4.3LX	262/V-6	1988-1993	B775130	F001219		②, ③		18-3668	18-3551	18-2552	18-2917
4.3LX	262/V-6	1993-1995	F001220	F601126		②, ④		18-3668	18-3551	18-2552	18-2917
43LX	262/V-6	1993-1995	F001220	F601126		②		18-3668	18-3551	18-0398	
4.3LX FWC	262/V-6	1993-1997	F001220	K999999		⑧		18-3567	18-3555	18-0398	
4.3LX ALPHA	262/V-6	1996-1997	F601127	K999999		⑦	18-3647	18-3649	18-0398		
4.3LX BRAVO	262/V-6	1996-1997	F601127	K999999	18-3530-1	⑦		18-3647	18-3649	18-0398	
4.3LXH FWC	262/V-6	1996-1997	F803114	K999999	18-3531	⑧		18-3568	18-3555	18-0398	
4.3LXH ALPHA	262/V-6	1996-1997	F803114	K999999	18-3530-1	⑦		18-3647	18-3649	18-0398	
4.3LXH BRAVO	262/V-6	1996-1997	F803114	K999999	18-3530-1	⑦		18-3647	18-3649	18-0398	
215 MCM/MIE (FORD)	302/V-8	1970	2781153	3040410				18-3646	18-3551	18-2834	
215 MCM/MIE (FORD)	302/V-8	1971-1972	3040411	3385720				18-3646	18-3551	18-2834	
225 MCM/MIE (FORD)	302/V-8	1973-1974	3385721	4176999				18-3646	18-3551	18-2834	
888 (FORD)	302/V-8	1971-1977	3108723	4887829		⑩		18-3646	18-3551	18-2834	
190	283/V-8	1963-1964	1564539	1730903				18-3551			
198 MIE	305/V-8	1977	4776402	4931099			18-1977-1	18-3646	18-3551	18-2844	18-0398
200	305/V-8	1985-1987	6899058	B774444	18-1994		18-1977-1	18-3668	18-3551	18-2554	18-2917
200 GM			6218462	B525981	18-1994	♥		18-3668	18-3551	18-2553	18-2554
200/5.0L			0B525982	0F600999				18-3647	18-3649	18-2917	
200/5.0L GM	③		B525982	UP	18-1994	♥		18-3668	18-3551	18-2553	18-2554
200/5.0L GM	④		B525982	UP	18-1994	♥		18-3648	18-3649	18-2552	18-2553
228	305/V-8	1977-1982	4765100	6218461			18-1977-1	18-3646	18-3551	18-2844	18-0398
228	305/V-8	1982-1984	6218462	6899268	18-1994		18-1977-1	18-3668	18-3551	18-2554	18-2553
228 MIE	305/V-8	1977-1980	4765100	5907057	18-3651		18-1977-1	18-3646	18-3551	18-2844	18-1993
230	305/V-8	1985-1987	6899269	B773739	18-1994		18-1977-1	18-3668	18-3551	18-2554	18-2553
230 MIE	305/V-8	1981-1987	5907058	B788151	18-1994		18-1977-1	18-3668	18-3551	18-2554	18-2553
230 MIE FWC	305/V-8	1981-1987	5907058	B788151		⑥	18-1977-1	18-3646	18-3551	18-2553	18-2844
230 GM			6218462	B525981	18-1994	♥		18-3668	18-3551	18-2553	18-2554
230 MIE			5907058	0B5225505				18-3646	18-3649	18-2553	18-2844
230 GM IB	⑤		5907058	B522505		⑦		18-3668	18-3551	18-2553	18-2554
230 GM IB	⑥		5907058	B522505		⑦		18-3651	18-3551	18-2553	18-2844
230/5.0L GM IB	③, ⑤		B522506	B525981							

THERMOSTAT APPLICATION (Cont.)

Engine / Model	CID / # CYL	Year Range	Beginning Serial #	Ending Serial #	Housing	Thermostat Cover	Thermostat & Gasket Kit	Thermostat	Gaskets Required	Gaskets Required - Design II	Gaskets Required - Design III
5.0L	305/V-8	1988-1995	B774445	F600999		②, ④	18-3668	18-3551	18-7173	18-2552	
5.0L	305/V-8	1988-1995	B774445	F600999		⑥	18-3647	18-3649	18-0398		18-2917
5.0L (GEN +) FWC	305/V-8	1988-2002	L015751	M599999	18-3531	⑥	18-3568	18-3555	18-1508		18-2917
5.0L (GEN +) FWC	305/V-8	2002-2010	M600000	& UP		⑦			18-0398		18-2917
5.0L (GEN +) ALPHA	305/V-8	1998-2002	L015751	M599999		⑦	18-3647	18-3649	18-0398		
5.0L (GEN +) BRAVO	305/V-8	1998-2002	L015751	M599999	18-3530-1	⑦	18-3647	18-3649	18-0398		
5.0L (GEN +)	305/V-8	2002-2010	M600000	& UP		⑦	18-3647	18-3649	18-0398		
5.0L EFI FWC	305/V-8	1998-2001	L012052	M299999	18-3531	⑥	18-3568	18-3555	18-1508		
5.0L EFI ALPHA	305/V-8	1998-2001	L012052	M299999		⑦	18-3647	18-3649	18-0398		
5.0L EFI BRAVO	305/V-8	1998-2001	L012052	M299999	18-3530-1	⑦	18-3647	18-3649	18-0398		
5.0L MIE FWC	305/V-8	1988	B788152	C396832		③	18-1977-1	18-3646	18-3551	18-2553	18-2844
5.0L MIE	305/V-8	1988	B788152	C396832		②, ③, ④		18-3668	18-3551	18-7173	
5.0L MIE	305/V-8	1988	B788152	C396832	18-1994	①, ②	18-1977-1	18-3668	18-3551	18-2554	18-2553
5.0L MPI FWC	305/V-8	2002	M300000	M599999		⑥		18-3568	18-3555	18-0398	
5.0L MPI FWC	305/V-8	2002-2010	M600000	& UP		⑥			18-0398		18-2917
5.0L MPI FWC DTS	305/V-8	2005-2010	W310000	& UP		⑥, ⑦			18-0398		18-2917
5.0L MPI FWC EC	305/V-8	2008-2010	A300000	& UP		⑥, ⑦, ⑧			18-0398		
5.0L MPI FWC EC DTS	305/V-8	2008-2010	A300000	& UP		⑥, ⑦, ⑧			18-0398		
5.0L MPI	305/V-8	2002-2010	M300000	& UP		⑦, ④	18-3647	18-3649	18-0398		18-2917
5.0L MPI ALPHA	305/V-8	2002	M300000	M599999		⑦, ⑤	18-3647	18-3649	18-0398		
5.0L MPI BRAVO	305/V-8	2002	M300000	M599999	18-3530-1	⑦, ⑤	18-3647	18-3649	18-0398		
5.0L MPI	305/V-8	2002-2010	M600000	& UP		⑦, ⑤	18-3647	18-3649	18-0398		
5.0L MPI EC	305/V-8	2008-2010	A300000	& UP		⑦, ⑧	18-3647	18-3649	18-0398		
5.0L LX	305/V-8	1988-1995	B773740	F600999	18-1994	①	18-1977-1	18-3668	18-3551	18-2554	18-2553
5.0L LX	305/V-8	1988-1995	B773740	F600999		②, ③		18-3668	18-3551	18-7173	18-2552
5.0L X	305/V-8	1988-1995	B773740	F600999		⑤	18-3647	18-3649	18-0398		
898	305/V-8	1977-1982	4762210	6218461			18-1977-1	18-3646	18-3551	18-2844	18-0398
898	305/V-8	1983-1984	6218462	6899057	18-1994		18-1977-1	18-3668	18-3551	18-2554	18-2553
225 (GM)	327/V-8	1967-1969	2399198	2694014			18-1977-1	18-3651	18-3551	18-2553	18-2844
225 (GM)	327/V-8	1963-1967	1539620	2399197	N.L.A.				18-3551		
225 (GM)			2278647	2399197				18-3668	18-3551	18-2552	18-7173
225/225S FORD			3385721	UP				18-3651	18-3551	18-2834	
250 MCM/MIE	327/V-8	1968-1969	2314301	2639854			18-1977-1	18-3651	18-3551	18-2553	18-2844
250	350/V-8	1977	4768000	4908849	18-1993		18-1977-1	18-3651	18-3551	18-2844	
250 (GM)			4768000	4908849				18-3646	18-3551	18-2844	
250 (GM)			4175500	5907057	18-1993			18-3651	18-3649	18-2844	18-2917
255 (GM)	350/V-8	1975-1976	4175500	4767999			18-1977-1	18-3646	18-3551	18-2844	18-0398
255 (GM) MIE	350/V-8	1975-1980	4175500	5907057			18-1977-1	18-3646	18-3551	18-2844	18-0398
255 FORD			3258728	UP				18-3651	18-3551	18-2834	
255 FORD MCM/MIE			3258728	4178299				18-3646	18-3649	18-2834	
260	350/V-8	1978-1982	4908850	6218461			18-1977-1	18-3651	18-3551	18-2844	18-0398
260	350/V-8	1982-1987	6218462	B773304	18-1994		18-1977-1	18-3668	18-3551	18-2554	18-2553
260 MIE FWC	350/V-8	1981-1987	5907058	B788151		⑥	18-1977-1	18-3646	18-3551	18-2553	18-2844
260 MIE	350/V-8	1981-1987	5907058	B788151	18-1994	⑦	18-1977-1	18-3668	18-3551	18-2554	18-2553
260 GM			6218462	B525981	18-1994	⑧		18-3668	18-3551	18-2553	18-2554
260 GM			4908850	6218461				18-3646	18-3649	18-2844	18-2917
260 GM IB	⑤		5907058	B522505		⑦		18-3668	18-3551	18-2553	18-2554
260 GM IB	⑥		5907058	B522505		⑧		18-3651	18-3551	18-2553	18-2844
260 MIE			5907058	0B522505				18-3646	18-3649	18-2553	18-2844
260/5.7L GM IB	③ ⑤		B522506	B525981		⑧, ⑦		18-3668	18-3551	18-2553	18-2554
260/5.7L GM IB	④ ⑤		B522506	B525981		⑧, ⑦		18-3668	18-3551	18-2552	18-7173
260/5.7L GM IB	④ ⑤		B522506	B525981		⑧, ⑦		18-3648	18-3649	18-2552	18-7173
260/5.7L GM IB	⑥		B522506	B525981		⑧		18-3651	18-3551	18-2553	18-2844
260/5.7L GM	③		B525982	F600999	18-1994	⑧		18-3668	18-3551	18-2553	18-2554
260/5.7L GM	④		B525982	F600999				18-3668	18-3551	18-2552	18-7173
260/5.7L GM	④		B525982	F600999				18-3648	18-3649	18-2552	18-7173
260/5.7L GM			0B525982	0F600999				18-3647	18-3649	18-2917	
260/5.7L MIE			0B52506	0F024999				18-3646	18-3649	18-2553	18-2844
270 MCM/MIE	350/V-8	1969-1972	2851074	3385720			18-1977-1	18-3646	18-3551	18-2553	18-2844
270 GM			2851074	3077735				18-3651	18-3551	18-2553	18-2844
280 GM	350/V-8	1975-1976	4176250	4770199			18-1977-1	18-3646	18-3649	18-2844	18-0398
280 GM TRS			4176250	4770199	18-1993			18-3651	18-3551	18-2844	
300	350/V-8	1985-1986	6668677	B430367			18-1977-1	18-3668	18-3551	18-2554	18-2553
320 EFI	350/V-8	1987-1989	A543604	C622418			18-1977-1	18-3646	18-3551	18-2553	18-2844
325 GM MCM/MIE			2278747	3780449				18-3646	18-3649	18-2553	18-2844
325 GM			2278747	2313964				18-3668	18-3551	18-2553	
325 GM			2313965	3042730				18-3651	18-3551	18-2553	18-2844
325 GM			3042731	UP				18-3651	18-3551	18-2844	
330 GM			4623115	UP				18-3651	18-3551	18-2844	
330 GM MCM/MIE			4623115	0B816540				18-3646	18-3649	18-2553	18-2844
330 GM W/BW	⑤		6083145	UP		⑦		18-3668	18-3551	18-2553	18-2554
330 GM W/BW	⑥		6083145	UP		⑧		18-3651	18-3551	18-2553	18-2844
350 MAG ALPHA	350/V-8	1987-1995	B525982	F600999		②, ③		18-3668	18-3551	18-7173	18-2917
350 MAG ALPHA	350/V-8	1986-1995	A635178	B525981		①	18-1977-1	18-3668	18-3551	18-2554	18-2553
350 MAG ALPHA	350/V-8	1987-1995	B525982	F600999		②, ③		18-3668	18-3551	18-7173	18-2552
350 MAG ALPHA	350/V-8	1987-1997	B525982	K999999		⑥		18-3647	18-3649	18-0398	
350 MAG ALPHA EFI (GEN +)	350/V-8	1996-1997	F800300	K999999				18-3647	18-3649	18-0398	
350 MAG BRAVO MPI	350/V-8	1995-1997	F415189	K999999	18-3530-1			18-3647	18-3649	18-0398	
350 MAG EFI SKI	350/V-8	1994-1997	F215561	K999999	18-3530-1			18-3647	18-3649	18-0398	
350 MAG MPI FWC	350/V-8	1998-2001	L010019	M299999	18-3531	⑥		18-3568	18-3555	18-1508	
350 MAG MPI	350/V-8	1998-2001	L010019	M299999	18-3530-1	⑦		18-3647	18-3649	18-0398	
350 MAG MPI FWC	350/V-8	2002	M300000	M599999		⑥		18-3568	18-3555	18-0398	
350 MAG MPI FWC	350/V-8	2002-2010	M600000	& UP		⑥			18-0398		
350 MAG MPI FWC DTS	350/V-8	2005-2010	W310000	& UP		⑥, ⑦			18-0398		
350 MAG MPI FWC EC	350/V-8	2008-2010	A300000	& UP		⑥, ⑦, ⑧			18-0398		
350 MAG MPI FWC EC DTS	350/V-8	2008-2010	A300000	& UP		⑥, ⑦, ⑧	N/A		18-0398		
350 MAG MPI	350/V-8	2002	M300000	M599999		⑦, ④	18-3647	18-3649	18-0398		
350 MAG MPI ALPHA	350/V-8	2002	M300000	M599999		⑦, ⑤	18-3647	18-3649	18-0398		
350 MAG MPI BRAVO	350/V-8	2002	M300000	M599999	18-3530-1	⑦, ⑤	18-3647	18-3649	18-0398		
350 MAG MPI	350/V-8	2002-2010	M600000	& UP		⑦, ⑤	18-3647	18-3649	18-0398		
350 MAG MPI	350/V-8	2002-2010	M600000	& UP		⑦, ④	18-3647	18-3649	18-0398		
350 MAG MPI EC	350/V-8	2008-2010	A300000	& UP		⑦, ⑧	18-3647	18-3649	18-0398		
350 MAG MPI HORIZON	350/V-8	2002	M300000	M599999		⑥	18-3568	18-3555	18-0398		
350 MAG MPI HORIZON	350/V-8	2002-2007	M600000	A299999		⑥			18-0398		
350 MAG MPI HORIZON MIE	350/V-8	1999-2001	L304700	M299999	18-3531	⑥		18-3568	18-3555	18-1508	
350 MAG MPI HORIZON MIE	350/V-8	2002	M300000	M316999		⑥		18-3568	18-3555	18-1508	
350 MAG MPI HORIZON MIE	350/V-8	2002-2007	M317000	A089999		⑥			18-0398		
350 MAG MPI MIE FWC	350/V-8	1998-2001	L002008	M299999	18-3531	⑥		18-3568	18-3555	18-1508	
350 MPI MIE	350/V-8	1998-2001	L002008	M299999	18-3530-1	⑦		18-3647	18-3649	18-0398	
350 MAG MPI MIE FWC	350/V-8	2002	M300000	M316999		⑥		18-3568	18-3555	18-1508	
350 MAG MPI MIE FWC	350/V-8	2002-2007	M317000	A089999		⑥			18-0398		

- ① Design I
- ② Design II
- ③ Design III
- ④ Aluminum Exhaust Manifold

TERMOSTAT APPLICATION (Cont.)

Engine / Model	CID / # CYL	Year Range	Beginning Serial #	Ending Serial #	Housing	Thermostat Cover	Thermostat & Gasket Kit	Thermostat	Gaskets Required	Gaskets Required - Design II	Gaskets Required - Design III
350 MAG MPI MIE	350/V-8	2002-2007	M300000	A089999		⑦	18-3530-1	18-3647	18-3649	18-0398	
350 MAG MPI SKI	350/V-8	1995-2001	F350583	M299999		⑦	18-3530-1	18-3647	18-3649	18-0398	
350 MAG MPI SKI	350/V-8	2002-2007	M300000	A089999		⑦	18-3530-1	18-3647	18-3649	18-0398	
350 MAG SKI	350/V-8	1991-1996	D505450	K040399		②, ③	18-3530-1	18-3668	18-3551	18-7173	18-2552 18-2917
350 MAG SKI	350/V-8	1991-1997	D505450	K999999		②, ③	18-3530-1	18-3647	18-3649	18-0398	
5.7L SKI	350/V-8	1988-1995	B773305	F600999	18-1994	①	18-1977-1	18-3668	18-3551	18-2554	18-2552 18-2917
5.7L SKI	350/V-8	1988-1995	B773305	F600999		②, ③	18-3530-1	18-3668	18-3551	18-7173	18-2552 18-2917
5.7L SKI	350/V-8	1988-1995	B773305	F600999		②, ③	18-3530-1	18-3668	18-3551	18-7173	18-2552 18-2917
5.7L SKI	350/V-8	1988-1996	B773305	K001526		③	18-3530-1	18-3647	18-3649	18-2844	18-0398
5.7L FWC	350/V-8	1997	K001527	K999999	18-3531	②	18-3531	18-3568	18-3555	18-1508	
5.7L ALPHA	350/V-8	1988-1997	B773305	F600999		⑦	18-3530-1	18-3647	18-3649	18-0398	
5.7L BRAVO	350/V-8	1995-1997	F601000	K999999	18-3530-1	⑦	18-3530-1	18-3647	18-3649	18-0398	
5.7L (GEN+) FWC	350/V-8	1998-2002	L010037	M599999	18-3531	②	18-3531	18-3568	18-3555	18-1508	
5.7L (GEN+) ALPHA	350/V-8	1998-2002	L010037	M599999		⑦	18-3530-1	18-3647	18-3649	18-0398	
5.7L (GEN+) BRAVO	350/V-8	1998-2002	L010037	M599999	18-3530-1	⑦	18-3530-1	18-3647	18-3649	18-0398	
5.7L (GEN+) FWC	350/V-8	2002-2010	M600000	& UP		⑦	18-3647	18-3649	18-0398		
5.7L (GEN+) FWC	350/V-8	2002-2010	M600000	& UP		⑦	18-3647	18-3649	18-0398		
5.7L EFI FWC	350/V-8	1995-1996	F225560	K001505		②	18-3530-1	18-3647	18-3649	18-2844	18-0398
5.7L EFI FWC	350/V-8	1997-2001	K001506	M299999	18-3531	②	18-3531	18-3568	18-3555	18-1508	
5.7L EFI ALPHA	350/V-8	1995-2001	F355305	M299999		⑦	18-3530-1	18-3647	18-3649	18-0398	
5.7L EFI BRAVO	350/V-8	1995-2001	F225560	M299999	18-3530-1	⑦	18-3530-1	18-3647	18-3649	18-0398	
5.7L EFI MIE (GEN+) FWC	350/V-8	1997	K040300	K999999	18-3531	②	18-3531	18-3568	18-3555	18-1508	
5.7L EFI MIE (GEN+)	350/V-8	1997	K040300	K999999	18-3530-1	⑦	18-3530-1	18-3647	18-3649	18-0398	
5.7L MIE	350/V-8	1988-1995	B788152	F600999	18-1994	①	18-1977-1	18-3668	18-3551	18-2554	18-2553 18-2917
5.7L MIE	350/V-8	1988-1995	B788152	F622099		②, ③	18-3530-1	18-3668	18-3551	18-7173	18-2917
5.7L MIE	350/V-8	1988-1995	B788152	F622099		②, ③	18-3530-1	18-3668	18-3551	18-7173	18-2917
5.7L MIE FWC	350/V-8	1988-1996	B788152	K04306		②	18-3530-1	18-3647	18-3649	18-2844	
5.7L MIE FWC	350/V-8	1997-2002	K040307	M316999	18-3531	②	18-3531	18-3568	18-3555	18-1508	
5.7L MIE	350/V-8	1996-2002	F622100	M316999		⑦	18-3530-1	18-3647	18-3649	18-0398	
5.7L MIE FWC	350/V-8	2002-2010	M317000	& UP		⑦	18-3530-1	18-3647	18-3649	18-0398	
5.7L MIE	350/V-8	2002-2010	M317000	& UP		⑦	18-3530-1	18-3647	18-3649	18-0398	
5.7L MPI HORIZON MIE	350/V-8	2008-2010	A0900000	& UP		②	18-3530-1	18-3647	18-3649	18-0398	
5.7L MPI MIE FWC	350/V-8	2008-2010	A0900000	& UP		②	18-3530-1	18-3647	18-3649	18-0398	
5.7L MPI MIE FWC DTS	350/V-8	2008-2010	A0900000	& UP		②, ⑦	18-3530-1	18-3647	18-3649	18-0398	
5.7L MPI MIE FWC EC	350/V-8	2008-2010	A0900000	& UP		②, ⑥, ⑦	18-3530-1	18-3647	18-3649	18-0398	
5.7L MPI MIE FWC EC DTS	350/V-8	2008-2010	A0900000	& UP		②, ⑦, ⑧	18-3530-1	18-3647	18-3649	18-0398	
5.7L MPI MIE	350/V-8	2008-2010	A0900000	& UP		②	18-3530-1	18-3647	18-3649	18-0398	
5.7L MPI MIE EC	350/V-8	2008-2010	A0900000	& UP		②, ⑧	18-3530-1	18-3647	18-3649	18-0398	
5.7L MPI SKI	350/V-8	2008-2010	A0900000	& UP		②	18-3530-1	18-3647	18-3649	18-0398	
5.7L MPI SKI EC	350/V-8	2008-2010	A0900000	& UP		②	18-3530-1	18-3647	18-3649	18-0398	
5.7L SKI	350/V-8	1985-1995	A338553	F775199	18-1994	①	18-1977-1	18-3668	18-3551	18-2554	18-0398
5.7L SKI	350/V-8	1987-1995	B514627	F775199		②, ③	18-3530-1	18-3668	18-3551	18-7173	18-0398
5.7L SKI	350/V-8	1987-1995	B514627	F775199		②, ③	18-3530-1	18-3668	18-3551	18-7173	18-0398
5.7L SKI	350/V-8	1996-2002	F775200	M316999	18-3530-1	③	18-3530-1	18-3647	18-3649	18-0398	
5.7L SKI	350/V-8	2002-2010	M317000	& UP		⑦	18-3530-1	18-3647	18-3649	18-0398	
5.7LX ALPHA	350/V-8	1995-1997	F601000	K999999		⑦	18-3530-1	18-3647	18-3649	18-0398	
5.7LX BRAVO	350/V-8	1995-1997	F601000	K999999	18-3530-1	⑦	18-3530-1	18-3647	18-3649	18-0398	
5.7LX RWC	350/V-8	1996	F601000	K001526		②	18-3530-1	18-3647	18-3649	18-2844	18-0398
5.7LX RWC	350/V-8	1997	K001527	K999999	18-3531	②	18-3531	18-3568	18-3555	18-1508	
5.7LX BRAVO EFI (GEN+) FWC	350/V-8	1996	F800300	K001508		②	18-3530-1	18-3647	18-3649	18-2844	18-0398
5.7LX BRAVO EFI (GEN+) FWC	350/V-8	1997	K001509	K999999		②	18-3530-1	18-3568	18-3555	18-0398	
5.7LX BRAVO EFI (GEN+)	350/V-8	1996-1997	F800300	K999999	18-3530-1	②	18-3530-1	18-3647	18-3649	18-0398	
5.7LX EFI FWC	350/V-8	1996	F752400	K001505		②	18-3530-1	18-3647	18-3649	18-2844	18-0398
5.7LX EFI FWC	350/V-8	1997	K001506	K999999	18-3531	②	18-3531	18-3568	18-3555	13-0398	
5.7LX EFI ALPHA	350/V-8	1996-1997	F752400	K999999		⑦	18-3530-1	18-3647	18-3649	18-0398	
5.7LX EFI BRAVO	350/V-8	1996-1997	F752400	K999999	18-3530-1	⑦	18-3530-1	18-3647	18-3649	18-0398	
5.7 GM ALPHA			F225560	0K999999			18-3647	18-3649	18-2917	—	
5.7 GM BRAVO			F225560	0K999999			18-3647	18-3649	18-2917	—	
5.7L/EFI GM ALPHA			L010037	UP			18-3647	18-3649	18-2917	—	
5.7L/EFI GM BRAVO			L010037	UP			18-3647	18-3649	18-2917	—	
5.7L MIE			F025000	0F622099			18-3647	18-3649	18-2844	—	
5.7L MIE			F622100	0K999999			18-3647	18-3649	18-2917	—	
5.7L MIE			F622100	0K999999			18-3647	18-3649	18-2844	—	
5.7L MIE			L002003	UP			18-3647	18-3649	18-2917	—	
BLACK SCORPION SKI	350/V-8	1996-2001	0F800000	M391599	18-3530-1		18-3530-1	18-3647	18-3649	18-0398	
BLACK SCORPION SKI	350/V-8	2003-2006	M391600	W690192		②	18-3530-1	18-3647	18-3649	18-0398	
BLACK SCORPION SKI	350/V-8	2003-2007	W690193	W698432		②	18-3530-1	18-3647	18-3649	18-0398	
BLACK SCORPION SKI	350/V-8	2003-2007	M391600	W698433		②	18-3530-1	18-3647	18-3649	18-0398	
SCORPION 350	350/V-8	2008-2010	W698433	& UP		②	18-3530-1	18-3647	18-3649	18-0398	
SCORPION 350	350/V-8	2008-2010	W698433	& UP		②	18-3530-1	18-3647	18-3649	18-0398	
SCORPION 350 EC	350/V-8	2008-2010	W698433	& UP		②	18-3530-1	18-3647	18-3649	18-0398	
233 MCM (FORD)	351/V-8	1975-1977	4173000	4902304			18-3646	18-3551	18-2834		
233 MCM (FORD)	351/V-8	1975-1977	4173000	4902304			18-3646	18-3551	18-2834		
255 MCM/MIE (FORD)	351/V-8	1973-1974	3258728	4178299			18-3646	18-3551	18-2834		
377 MAG FWC	377/V-8	2008-2010	A300000	& UP		②, ⑥	18-3530-1	18-3647	18-3649	18-0398	
377 MAG FWC DTS	377/V-8	2008-2010	A300000	& UP		②, ⑦	18-3530-1	18-3647	18-3649	18-0398	
377 MAG FWC EC	377/V-8	2008-2010	A300000	& UP		②, ⑧	18-3530-1	18-3647	18-3649	18-0398	
377 MAG FWC EC DTS	377/V-8	2008-2010	A300000	& UP		②, ⑦, ⑧	18-3530-1	18-3647	18-3649	18-0398	
377 MAG	377/V-8	2008-2010	A300000	& UP		②, ④	18-3530-1	18-3647	18-3649	18-0398	
377 MAG	377/V-8	2008-2010	A300000	& UP		②, ⑤	18-3530-1	18-3647	18-3649	18-0398	
377 MAG EC	377/V-8	2008-2010	A300000	& UP		②, ⑧	18-3530-1	18-3647	18-3649	18-0398	
377 SCORPION MCM	377/V-8	1999-2005	L416146	M907201		②	18-1977-1	18-3647	18-3551	18-0398	18-2553
377 SCORPION SKI	377/V-8	1997-1998	K000656	L600314		②	18-3530-1	18-3647	18-3649	18-0398	
MX 6.2L MPI FWC	377/V-8	2000-2001	L680003	M299999	18-3531	②	18-3531	18-3568	18-3555	18-0398	
MX 6.2L MPI	377/V-8	2000-2001</									

THERMOSTAT APPLICATION (Cont.)

Engine / Model	CID / # CYL	Year Range	Beginning Serial #	Ending Serial #	Housing	Thermostat Cover	Thermostat & Gasket Kit	Thermostat	Gaskets Required	Gaskets Required - Design II	Gaskets Required - Design III
MX 6.2L BLACK SCORPION	377V-8	2003-2006	M391600	W690192		⑨	18-3647	18-3649	18-0398		
MX 6.2L BLACK SCORPION	377V-8	2006-2007	W690192	W698432		⑨	18-3647	18-3649	18-0398		
SCORPION 377	377V-8	2008-2010	W698433	& UP		⑨	18-3647	18-3649	18-0398		
SCORPION 377	377V-8	2008-2010	W698433	& UP		⑩	18-3647	18-3649	18-0398		
SCORPION 377 HO EC	377V-8	2008-2010	A091488	A092170		⑥	18-3647	18-3649	18-0398		
325 MCM/MIE	427V-8	1969-1972	2278747	3780449			18-3646	18-3551	18-2553		18-0398
330 (WITH MERC TRANS)	454V-8	1977-1981	4623115	6083144			18-3646	18-3551	18-2844	18-0398	
330 (WITH B/W) FWC	454V-8	1982-1987	6083145	B816540		⑦	18-3646	18-3551	18-2553		18-0398
330 (WITH B/W)	454V-8	1982-1987	6083145	B816540	18-3678	⑦	18-3668	18-3551	18-2554	18-2553	18-0398
330 MIE (WITH MERC TRANS)	454V-8	1977-1980	4623115	5889913			18-3646	18-3551	18-2844	18-0398	
340 MIE FWC	454V-8	1981-1987	5889914	B788365		⑦	18-3646	18-3551	18-2553	18-2844	18-0398
340 MIE	454V-8	1981-1987	5889914	B788365	18-3678	⑦	18-3668	18-3551	18-2554	18-2844	18-0398
340 MIE	454V-8	1981-1987	5889914	B788365		⑦, ⑧	18-3668	18-3551	18-2554	18-2553	18-0398
340/7.4L MIE			5889914	0D715493			18-3646	18-3649	18-2553	18-2844	18-2917
350 MIE	454V-8	1974-1976	3780450	4623109			18-3646	18-3551	18-2844	18-0398	
350 GM (MAGNUM)			A635178	B525981			18-3668	18-3551	18-2553	18-2554	
350 GM (MAGNUM)	③		B525982	UP		⑬	18-3668	18-3551	18-2553	18-2554	
350 GM (MAGNUM)	④		B525982	UP		⑭	18-3668	18-3551	18-2552	18-7173	
350 GM (MAGNUM)	④		B525982	UP	18-3648	⑭	18-3648	18-3649	18-2552	18-7173	
370	454V-8	1978-1985	4179554	6721527			18-3646	18-3551	18-2553	18-2844	18-0398
370	454V-8	1985-1987	6721528	B714586			18-3668	18-3551	18-2554	18-2553	18-0398
370 TRS GM			4179554	6721527			18-3651	18-3551	18-2553	18-2844	
370 TRS GM			6721528	UP			18-3668	18-3551	18-2553	18-2554	
390 GM			2781129	2825059			18-3651	18-3551	18-2553	18-2844	
390 GM MCM/MIE			2781129	3042731			18-3646	18-3649	18-2553	18-2844	18-2917
400	454V-8	1980-1986	4179554	0B457644			18-3646	18-3551	18-2553	18-2554	18-0398
400 TRS GM			4179554	UP			18-3651	18-3551	18-2553	18-2844	
420 GM			A398941	UP	18-3651		18-3651	18-3551	18-2553	18-2844	
420	454V-8	1987-1989	A398941	B622418	18-1994		18-3646	18-3551	18-2553	18-2844	18-0398
425	454V-8	1990-1993	A398941	D937011	18-3678			18-3551	18-2553	18-2844	18-0398
440	454V-8	1983-1986	4179554	B485220			18-3646	18-3551	18-2553	18-2844	18-0398
450	454V-8	1995-1996	F347100	F347277	18-1994			18-3551	18-2553	18-2844	18-0398
525 SC	454V-8	1991-1999	D456000	L415623			18-1977-1	18-3551	18-2553	18-0398	
454 MAG ALPHA	454V-8	1986-1988	A631894	B785148	18-3678	①	18-3668	18-3551	18-2554	18-2553	18-0398
454 MAG ALPHA	454V-8	1986-1988	A631894	B785148		②, ③	18-3668	18-3551	18-7173	18-2552	18-0398
454 MAG BRAVO	454V-8	1988-1992	B721206	D805068	18-3678	①	18-3668	18-3551	18-2554	18-2553	18-0398
454 MAG BRAVO	454V-8	1995-1997	F305000	K999999		②, ③	18-3647	18-3649	18-0398		
454 MAG BRAVO	454V-8	1988-1992	B721206	D805068		②, ③	18-3668	18-3551	18-7173		18-0398
454 MAG BRAVO	454V-8	1992-1994	D805069	F304999		②, ③	18-3668	18-3551	18-7173		18-0398
454 MAG EFI	454V-8	1995-1997	F115700	F802349		⑦	18-3647	18-3649	18-0398		
454 MAG EFI SKI	454V-8	1995-1997	F215800	K999999		⑦	18-3647	18-3649	18-0398		
454 MAG MPI	454V-8	1996-2001	F802350	M024999		⑦	18-3647	18-3649	18-0398		
454 MAG MPI FWC	454V-8	1998-2001	L010029	M024999	18-3531	⑥	18-3568	18-3555	18-0398		
454 MAG MPI HORIZON MIE	454V-8	1998-2001	L002200	L674000	18-3531	⑥	18-3568	18-3555	18-0398		
454 MAG MPI SKI	454V-8	1996-1997	F820100	K999999		⑦	18-3647	18-3649	18-0398		
525 SC	454V-8	1991-1999	D456000	L415623			18-1977-1	18-3551	18-2553	18-0398	
7.4L BRAVO	454V-8	1995-1997	0F352000	0K999999		⑦	18-3647	18-3649	18-0398		
7.4L BRAVO	454V-8	1988-1991	B771113	D603117	18-3678	①	18-3668	18-3551	18-2554	18-2553	18-0398
7.4L BRAVO	454V-8	1988-1991	B771113	D603117		②, ③	18-3668	18-3551	18-7173	18-2552	18-0398
7.4L BRAVO	454V-8	1992-1994	D603118	F351999		②, ③	18-3668	18-3551	18-7173	18-2552	18-0398
7.4L EFI MIE	454V-8	1996-1997	F874815	K999999		⑦	18-3647	18-3649	18-0398		
7.4L EFI MIE FWC	454V-8	1996-1997	F874815	K999999	18-3531	⑥	18-3568	18-3555	18-0398		
7.4L MIE FWC	454V-8	1988-1992	B788366	D715493		⑥	18-3646	18-3551	18-2553	18-2844	18-0398
7.4L MIE	454V-8	1988-1992	B788366	D715493		⑦, ⑧	18-3668	18-3551	18-2554	18-2553	18-0398
7.4L MIE	454V-8	1989-1994	C391564	D715493		⑦	18-3668	18-3551	18-7173	18-2552	18-0398
7.4L MIE FWC	454V-8	1989-1994	C391564	D715493		⑥	18-3646	18-3551	18-2553	18-2844	18-0398
7.4L MIE	454V-8	1989-1994	D715494	F349999		⑦	18-3668	18-3551	18-7173	18-2552	18-0398
7.4L MIE FWC	454V-8	1989-1994	D715494	F820141		⑥	18-3646	18-3649	18-2553	18-2844	18-0398
7.4L MIE	454V-8	1995-1996	F350000	F820141		⑦	18-3647	18-3649	18-0398		
7.4L MIE	454V-8	1996-1997	F820142	K999999		⑦	18-3647	18-3649	18-0398		
7.4L MIE	454V-8	1996-1997	F820142	K999999		⑥	18-3647	18-3649	18-2844	18-0398	
7.4L MPI	454V-8	1998-2001	L010003	M024330		⑦	18-3647	18-3649	18-0398		
7.4L MPI MIE	454V-8	1995-2001	F563052	M025999		⑦	18-3647	18-3649	18-0398		
7.4L MPI MIE FWC	454V-8	1995-2001	F563052	M025999		⑥	18-3568	18-3555	18-0398		
7.4LX BRAVO EFI	454V-8	1996-1997	F820000	K999999		⑦	18-3647	18-3649	18-0398		
7.4L BRAVO MPI	454V-8	1996-1997	F602010	K999999		⑦	18-3647	18-3649	18-0398		
7.4L MIE			0C391564	0D715493			18-3646	18-3649	18-2553	18-2844	18-2917
7.4L MIE			0C391564	0F349999			18-3646	18-3649	18-2553	18-2844	18-2917
390 MCM/MIE	482V-8	1969-1970	2781129	3042731			18-3646	18-3551	18-2553	18-2844	18-0398
460	482V-8	1983-1986	4179554	6181046			18-3668	18-3551	18-2554	18-2553	18-0398
465	502V-8	1990-1994	C849992	F213244	18-3678			18-3551	18-2553	18-2844	18-0398
470			4208730	6218036			18-3652	18-3552	18-2843		
470			6218037	UP			18-3667	18-3555	18-2555		
485			5685394	UP			18-3652	18-3552	18-2555		
488			6170297	UP			18-3667	18-3555	18-2555		
500	502V-8	1994-1998	F213293	L001772	18-1994		18-1977-1	18-3551	18-2553	18-2844	18-0398
500 (GEN +)	502V-8	1999	L414639	L601036	18-1994		18-1977-1	18-3551	18-2553	18-2844	18-0398
500 EFI	502V-8	1999-2005	L001477	M907127			18-1977-1	18-3551	18-2553	18-0398	
502 MAG	502V-8	1990-1993	C878221	F114528		⑤	18-3668	18-3551	18-7173	18-2552	18-0398
502 MAG EFI	502V-8	1993-1995	D840650	F802599		⑦	18-3647	18-3649	18-0398		
502 MAG MPI	502V-8	1996-1997	F802600	K999999		⑦	18-3647	18-3649	18-0398		
502 MAG MPI FWC	502V-8	1998-2001	L017000	M024999	18-3531	⑥	18-3568	18-3555	18-0398		
525 EFI	502V-8	2003-2010	M900146	& UP			N/A		18-1508		
575 GM			0A677429	0D763716			18-3646	18-3649	18-2553	18-2844	18-2914
575			A677429	UP			18-3651	18-3551	18-2553	18-2844	
8.2L MAG	502V-8	2010	A350340	& UP					18-1508		
8.2L MIE EC	502V-8	2010	A350802	& UP					18-1508		
8.2L MIE	502V-8	1990-1992	C878221	D857199		⑦	18-3668	18-3551	18-7173	18-2552	18-0398
8.2L MIE FWC	502V-8	1990-1992	C878221	D857199		⑥	18-3668	18-3551	18-2553		



18-7702
AIR CHARGE
TEMPERATURE SENDER
 Replaces: 805223T
 Fits: Mercruiser V6 & V8(350, 454, 496
 & 502 cid)MPI engines



18-5897
SENDER
 Replaces: 97257A1, 806490T
 For Water Temperature
 3/8" - 18 NPT



18-5898
SENDER
 Replaces: 97258A1
 For Water Temperature
 1/2" -14 NPT



18-5899
OIL PRESSURE SENDER
 Replaces: 90806, 815425T
 For Oil Pressure

TEMPERATURE SENDER/OIL SENDER APPLICATION

Model	Serial #	Oil Pressure	Water Temperature	Model	Serial #	Oil Pressure	Water Temperature
ROVER	3140000F & UP	—	18-5897	270	2851074-3077735	18-5899	18-5897
110	1565944-1566081	18-5899	18-5898	280	4176250 & UP	18-5899	18-5898
110	1602980 & UP	18-5899	18-5898	300 MR/TRS	6668677 & UP	18-5899 ②	18-5897 ②
120	2324346 & BELOW	18-5899	18-5898	320	A543604 & UP	18-5899 ②	18-5897 ②
120	2324347 & UP	18-5899 ① ②	18-5897 ②	325	2278747 & UP	18-5899	18-5897 ⑧ ⑨
140 (4 cyl/3.0)	2508061 - 3462607	18-5899 ②	18-5897 ②	330	4623115 & UP	18-5899	18-5898
140 (4cyl/3.0)	4512156 & UP	18-5899 ②	18-5897 ②	330/W.B.W.	6083145 & UP	18-5899 ②	18-5897 ②
3.0L/3.0LX	C856559 & UP	18-5899 ②	18-5897 ②	340/7.4L	5889914 & UP	18-5899 ②	18-5897 ②
140 (6 cyl)	1566119-1725960	18-5899	18-5898	350	3780450 & UP	18-5899	18-5898
150	1666495-2048046	18-5899	18-5898	350 (Magnum)	A635178- B525981	18-5899 ②	18-5897 ②
160	2048022-2770031	18-5899	18-5897 ④ ⑤	350 (Magnum)	B525982-0505449	—	18-5897 ② ⑥ ⑦
165	2770032 & UP	18-5899	18-5897	350 (Magnum)	D505450 & UP	18-5899 ②	18-5897 ②
165/3.7L/170/180	6916779 & UP	18-5899	—	370 (TRS)	4179554 & UP	18-5899 ②	18-5897 ②
175 (262 CID)	B527955 & UP	18-5899 ②	18-5897 ② ⑥ ⑦	390	2781129-2825059	18-5899	18-5897
4.3L (Generation II)	D714107 & UP	18-5899 ②	18-5897 ②	400	4179554 & UP	18-5899	18-5897
185 (229 CID)	6330183 & UP	18-5899 ②	18-5897 ②	420/425	A398941 & UP	18-5899 ②	18-5897 ②
185 (262 CID)	A331455 & UP	18-5899 ②	18-5897 ②	440	4179554 & UP	18-5899	18-5897
190	1504311-1730903	18-5899	18-5898	454 (Magnum)	A631894 & UP	18-5899 ②	18-5897 ②
190 (4 cyl)	6916779 & UP	18-5899	—	454 (Bravo)	B721206-D805068	18-5899 ②	18-5897 ② ⑥ ⑦
200	2453769-271202	18-5899	18-5897	460	4179554	18-5899	18-5897
200	6218462 & UP	18-5899 ②	18-5897 ②	465	C849992 & UP	18-5899 ②	18-5897 ②
200/5.0	B525982 & UP	—	18-5897 ② ⑥ ⑦	500	C577254 & UP	18-5899 ②	18-5897 ②
205 (262 CID)	A331455 & UP	18-5899 ②	18-5897 ②	502 (Bravo)	C878221 & UP	18-5899 ②	18-5897 ②
205 (4.3L)	B527955 & UP	18-5899 ②	18-5897 ② ⑥ ⑦	502 (Bravo Gen V)	D824589 & UP	—	18-5897
4.3LX (Generation II)	D714370 & UP	18-5899 ②	18-5897 ②	525	D456000 & UP	18-5899 ②	18-5897 ②
215	2781153 & UP	18-5899	18-5897	575	A677429 & UP	18-5899 ②	18-5899 ②
225 (Ford)	3385721 & UP	18-5899	18-5897	888	3108723 & UP	18-5899	18-5897
225 (GM)	1632308-2694014	18-5899	18-5897 ⑧ ⑨	898	4762210-6218461	18-5899	18-5898
228	4765100-6218461	18-5899	18-5898	898	6218462 & UP	18-5899 ②	18-5897 ②
228 & 230	6218462 & UP	18-5899 ②	18-5897 ②	5.7	A338553-B514626	18-5899 ②	18-5897 ②
230 (I.B.)	5907058 & UP	18-5899 ②	18-5897 ②	5.7	B514627-B525981	18-5899 ②	18-5897 ② ⑥ ⑦
230 (5.0)	B522506 & UP	18-5899 ⑩	18-5897 ⑥ ⑦	5.7 (Bravo)	B525982 & UP	—	18-5897 ⑥ ⑦
233 Ford	4173000 & UP	18-5899	18-5898	7.4 (Bravo)	B771113-D803117	18-5899 ②	18-5897 ② ⑥ ⑦
250	9314301-4908849	18-5899	18-5897 ⑧ ⑨	7.4 (Bravo Gen V)	D803118 & UP	—	18-5897 ②
255	3258728 & UP	18-5899	18-5898	7.4L (Hurth)	ALL	18-5899 ②	18-5897 ②
260	4908850-6218461	18-5899	18-5898	454	D805069 & UP	—	18-5897 ②
260	6218462 & UP	18-5899 ②	18-5897 ②	8.2	C878221-D857199	18-5899 ②	18-5897 ②
260/5.7	B522506 & UP	18-5899 ⑩	18-5897 ⑥ ⑦	8.2	D857200 & UP	—	18-5897 ②
260	5907058 & UP	18-5899 ②	18-5897 ②				

① S/N - 3377341-3461707 & 5192049 & UP

② Does not include Dual application

④ 2326096 & UP

⑤ 2233574 & Below use 18-5898

⑥ (3/8 - 18)

⑦ (1/2 -14) Use 18-5898

⑧ Electric Choke

⑨ Auto Choke

⑩ Thru S/N B525981 only

**18-70944
MOLDED HOSE**

Replaces: 32-861590A05

Fits: 4.3L Alpha/Bravo Carb(2002 & Up), 350 Black Scorpion Ski (Gen+) (1997-01), 6.2L Black Scorpion Ski (Gen+) (2001-02), Black Scorpion 350 Mag MPI(2002), Black Scorpion MX 6.2L MPI (2002)



**18-70948
MOLDED HOSE**

Replaces: 32-808033

Fits: 262 Mag EFI Bravo w/Fuel Cool System (1996-97), 4.3L EFI (TBI) (1998-01), 5.0L (Gen+) Bravo (1998-07), 5.0L EFI (Gen+) (1998-01), 350 Mag Alpha (Gen+) (1997), 350 Mag Alpha EFI (Gen+) (1997), 350 Mag Bravo MPI (Gen+) (1997), 350 Mag MPI (Gen+) (1998-01), 5.7L (1997), 5.7L (Gen+) (1998-07), 5.7L EFI (1997), 5.7L EFI (Gen+) 1998-2001, 5.7LX (1997), 5.7LX Bravo EFI (Gen+) (1997), 5.7LX EFI (1997)
For: Cooler to thermostat housing



**18-70949
MOLDED HOSE**

Replaces: 32-807407

Fits: 454 Mag MPI (Gen VI) (1996-01), 7.4LX MPI Bravo (Gen VI) (1996-97), 502 Mag MPI (Gen VI) (1996-01) For: Cooler to thermostat housing



**18-70954
MOLDED HOSE**

Replaces: 32-8600891

Fits: 5.0L (Gen+) Bravo (1998-07), 5.0L EFI (Gen+) Alpha & Bravo (1998-01), 350 Mag Alpha (1997), 350 Mag EFI (Gen+) Alpha (1997), 350 Mag EFI (Gen+) Alpha (1997), 350 Mag MPI (Gen+) Bravo (1997-01), 350 Mag MPI (Gen+) Alpha (1998-01), 5.7L Alpha & Bravo (1997), 5.7L (Gen+) Alpha & Bravo (1998-07), 5.7L EFI Bravo (1997-01), 5.7LX Alpha & Bravo (1997), 5.7LX EFI (Gen+) Alpha & Bravo (1997), 6.2L MPI (2000-01) For: oil cooler to oil cooler



**18-70956
MOLDED HOSE**

Replaces: 32-16012

Fits: MC175/205 (1987), 4.3L (1988-92), 4.3L (Gen II) (1992-95), 4.3LX (Gen II) (1992-95) For: Oil cooler to thermostat housing with all four hose connectors cast into the thermostat housing (No "T" connector) Two hoses to manifold and two hoses to elbow.



**18-70955
MOLDED HOSE**

Replaces: 32-16011

Fits: MC200/230 (1987), 5.0L Alpha (1988-95), 5.0LX Alpha (1988-95), MC260 (1987), 350 Mag Alpha (1987-95), 5.7L Alpha & Bravo (1988-95), 454 Mag Bravo (1988-92), 7.4L (GenV) Bravo (1992-96)
For: Oil cooler to thermostat housing with all four hose connectors cast into the thermostat housing (No "T" connector) Two hoses to manifold and two hoses to elbow.



**18-70952
MOLDED HOSE**

Replaces: 32-887952

Fits: 5.0 L Bravo (1988-95), 5.0LX Bravo (1988-95), 350 Mag MPI Bravo (1995), 350 Mag MPI (Gen+) Bravo (1996), 5.7L Bravo (1988-96), 5.7L EFI 1995, 5.7L EFI Bravo (1996), 5.7LX EFI (Gen+) Bravo (1996) For: Seawater pump to oil cooler



**18-70953
MOLDED HOSE**

Replaces: 32-8080441

Fits: 5.0L EFI (Gen+) Bravo (1998-01), 350 Mag MPI (Gen+) (1998-01), 5.7L Bravo (1997), 5.7L (Gen+) Bravo (1998-07), 5.7L EFI Bravo 1997, 5.7L EFI (Gen+) Bravo (1998-01), 5.7LX Bravo (1997), 5.7LX EFI (Gen+) Bravo (1997), 6.2L MPI (2000-01) For: Seawater pump to oil cooler



**18-70951
MOLDED HOSE**

Replaces: 32-860205

Fits: 262 Mag. EFI Bravo (1996-97), 4.3L (Gen+) Bravo (1998-07), 4.3L TBI (Gen+) Bravo (1998-01), 4.3LH (Gen+) Bravo (1998-02), 4.3LX(H) (Gen+) Bravo (1996-97) For: Seawater pump to oil cooler



**18-70945
MOLDED HOSE**

Replaces: 32-862139

Fits: 4.3L (Gen+) (1998-07), 4.3L EFI (Gen+) (1998-01), 4.3LH (Gen+) (1998-02)
For: Thermostat housing to port manifold with 2 piece exhaust manifold





18-70947
MOLDED HOSE

Replaces: 32-862124
Fits: 4.3L (Gen+) (1998-07) (S/N 0L619000 & UP), 4.3L EFI (Gen+) (2000-01), 4.3LH (Gen+) (2000-02) For: Thermostat housing to starboard manifold with 2 piece exhaust manifold



18-70946
MOLDED HOSE

Replaces: 32-8066362
Fits: 262 Mag EFI (Gen+) (1996-97), 4.3L (Gen+) (1998-07) (S/N 0L01004-0L618999), 4.3L EFI (Gen+) (1998-00), 4.3LH (Gen+) 1998-00, 4.3LX (Gen+) (1996-97), 4.3LXH (Gen+) (1996-97)
For: Thermostat housing to starboard manifold with 2 piece exhaust manifold



18-70950
MOLDED HOSE

Replaces: 32-807661
Fits: 3.0L (1999-07), 262 Mag EFI Alpha (1996-97), 4.3L (Gen+) Alpha (1998-07), 4.3L EFI (TBI Gen+) Alpha (1998-01), 4.3LH (Gen+) Alpha (1998-02), 4.3LX(H) (Gen+) Alpha (1996-97), 5.0L (Gen+) Alpha (1998-07), 5.0L EFI (Gen+) Alpha (1998-01), 350 Mag. Alpha (1997), 350 Mag. EFI (Gen+) Alpha (1997), 350 Mag. MPI (Gen+) Alpha (1998-01), 5.7L Alpha (1997), 5.7L (Gen+) Alpha (1998-07), 5.7L EFI Alpha (1997), 5.7L EFI (Gen+) Alpha (1998-01), 5.7LX Alpha (1997) For: Transom to oil cooler



18-70957
MOLDED HOSE

Replaces: 32-41642A3
Fits: MC185 (1983-86), MC175 (1987), MC205 (1985-87), 4.3L (1988-92), 4.3L (Gen II) & 4.3LX (Gen II) (1992-95) For: Transom to oil cooler



18-70958
MOLDED HOSE

Replaces: 32-96246A4
Fits: MC898 (1983-84), MC200 (1985-87), MC228 (1982-84), MC230 (1985-87), 5.0L & 5.0LX Alpha (1988-95), MC260 (1983-87), 300 Tempest MR (1985-86), MC320 EFI (1987-89), 350 MAG Alpha (1986-96), 5.7L Alpha (1988-96), 5.7LX & 5.7LX EFI Alpha (1996), 454 MAG Alpha (1986-88)
For: Transom to oil cooler



18-70933
MOLDED HOSE

Replaces: 32-861634
Fits: 3.0L I/L 4 (1999 & Up)



18-70934
MOLDED HOSE

Replaces: 32-897181
Fits: 330 (1977-87), 330 MIE (1977-80), 340 MIE W/ BW (1981-87), 370 TRS (1978-87), 400 TRS (1980-86), 420 (1987-89), 425 (1990-92), 425 (Gen V) (1992-93), 440 TRS (1983-86), 450 (Gen V) (1995-96), 454 EFI (Gen V) (1994-96), 454 Mag Alpha (1986-88), 454 Mag Bravo (1988-92), 454 Mag Bravo (Gen V) (1992-97), 454 Mag MPI Bravo (Gen VI) (1996-98), 454 Mag MPI SKI (Gen VI) (1996-97), 460 TRS (1983-86), 465 (1990-92), 465 (Gen V) (1992-94), 500 Gen+ (1999), 500 (Gen V) (1994-96), 500 (Gen VI) (1997-98), 502 EFI (Gen V) (1993-95), 502 Mag Bravo (1990-92), 502 Mag MPI Bravo (Gen VI), 502 Mag Bravo (Gen V) (1992-93), 502 Mag MPI (Gen VI) (1996), 7.4L MIE W/BW (1988-92), 7.4L Bravo (1988-91), 7.4L Bravo (Gen V) (1992-96), 7.4L Bravo (Gen VI) (1996-97), 7.4L MIE (LH) (Gen V) (1992-96), 7.4L MIE (LH) (Gen VI) (1996-97), 7.4L MIE W/Hurth (1989-92), 7.4L MIE MPI (LH) (Gen VI) (1996-97), 7.4L TBI MIE (LH) (Gen VI) (1996-97), 7.4LX Bravo MPI (Gen V) (1996-97), 7.4LX Bravo TBI (Gen VI) (1996-97), 8.2L MIE (Gen V) (1993-96), 8.2L MIE MPI (Gen VI), 8.2



18-70935
MOLDED HOSE

Replaces: 32-806856
Fits: 200 2bbl (1987), 230 4bbl (1987), 260 (1987), 350 Mag SKI (1991-96), 350 Mag Alpha (1987-95), 350 Mag Alpha 4bbl (1996), 350 Mag Alpha EFI (Gen+) (1996), 350 Mag Bravo MPI (1995), 350 Mag Bravo MPI (Gen+) (1996), 350 Mag EFI SKI TBI (1994-96), 350 Mag MPI SKI (1995-96), 4.3L (Gen II) (2bbl) (1993-96), 4.3LX (Gen II) (4bbl) (1993-96), 5.0L 2bbl (1988-95), 5.0LX 4bbl (1988-95), 5.7L (1988-95), 5.7L 2bbl (1996), 5.7L Alpha EFI TBI (1995), 5.7L Bravo EFI TBI (1995), 5.7L Competition SKI (1996), 5.7L EFI (2bbl TBI) (1996), 5.7L MIE (1996), 5.7LX 4bbl (1996), 5.7LX Bravo EFI (Gen+) (1996), 5.7LX EFI 4bbl TBI (1996), Black Scorpion (Gen+) (1996) For: Oil cooler to thermostat housing.



18-70938
MOLDED HOSE

Replaces: 32-8066351
Fits: 262 Mag with VST (1996-97), 4.3L-LX (1993-96) Design III, 5.0L-LX (1988-95) Design III, 350Mag-EFI-MPI (1987-96), 5.7L-LX 88-96 Design III.
For: Thermostat housing to port exhaust manifold



18-70939
MOLDED HOSE

Replaces: 32-8066361
Fits: 4.3L-LX (1993-96) Standard Cooling Design III, 5.0L-LX/5.7L-LX (1988-95) Standard Cooling Design III, 350 Mag (1987-95) Standard Cooling Design III.
For: Thermostat housing to starboard exhaust manifold



**18-70940
MOLDED HOSE**

Replaces: 32-860144
Fits: 262 Mag with Fuel Cool, 4.3L-LX (1996 & Up) with 1 pc. manifold, 5.0L-EFI (1998 & Up), 350 Mag-MPI 97-01, 5.7L-EFI (1996-97), 6.2L MPI(20 01& Up).
For: Thermostat housing to port exhaust manifold



**18-70941
MOLDED HOSE**

Replaces: 32-807697
Fits: 262 Mag with 1 piece exhaust, 4.3L (1998 & Up) with 1 piece exhaust, 4.3LX-EFI (1996-01) with 1 piece exhaust, 5.0L (Gen+) (1998& Up), 5.0L EFI (1998-01), 350Mag EFI-MPI 97-01, 5.7L-LX (1997-98).
For: Thermostat housing to starboard exhaust manifold



**18-70942
MOLDED HOSE**

Replaces: 32-897301
Fits: 7.4L, 454 Mag, 502 Mag. For: Thermostat housing to starboard exhaust manifold



**18-70943
MOLDED HOSE**

Replaces: 32-897491
Fits: 7.4L, 454 Mag, 502 Mag. For: Thermostat housing to port exhaust manifold



**18-3601
GIMBAL HOUSING WATER FEED HOSE**

Replaces: 32-32461
Dia. $\frac{5}{8}$ "
Length 13 $\frac{7}{8}$ "



**18-3602
WATER INTAKE HOSE**

Replaces: 32-4172533
13 $\frac{7}{8}$ " Length - $\frac{3}{4}$ " I.D.
For: MR, Alpha I, Gen II



**18-3603
WATER INTAKE HOSE**

Replaces: 32-43437



**18-70925
MOLDED HOSE**

Replaces: 32-160211
For: 4.3L, 5.0L, & 5.7L
For: Thermostat Cover to Port Manifold



**18-70926
MOLDED HOSE**

Replaces: 32-73796
For: 5.0L & 5.7L
For: Thermostat Cover to Exhaust Elbow



**18-70927
MOLDED HOSE**

Replaces: 32-73795
For: 5.0L & 5.7L Port
For: Thermostat Housing to Port Manifold



18-70928
MOLDED HOSE
 Replaces: 32-71613
 For: 5.0L & 5.7L
 For: Thermostat Housing to Oil Cooler



18-70929
MOLDED HOSE
 Replaces: 32-73794
 For: 5.0L & 5.7L Starboard
 For: Thermostat Housing to Starboard Manifold



18-70930
MOLDED HOSE
 Replaces: 32-52481
 For: GM Inline 4 & 6 cyl.
 For: Water Distribution Block to End Cap



18-70931
MOLDED HOSE
 Replaces: 32-96879
 For: 2.5L & 3.0L
 For: Distribution Block to Water Pump

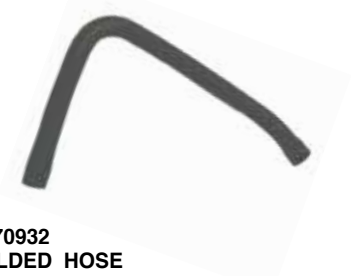

18-70932
MOLDED HOSE
 Replaces: 32-871171
 For: 4.3L, 5.0L, & 5.7L Starboard
 For: Thermostat Cover to Starboard Manifold

SINGLE DIAMETER HOSE



4 3/4"

18-70021
MOLDED HOSE
 3/4" ID



5"

18-70704
MOLDED HOSE
 1 1/4" ID
 For: 3.7L



5"

18-70924
MOLDED HOSE
 1 3/4" ID



12 1/2"

18-71218
MOLDED HOSE
 1" ID
 For: 230 & 260 MIE



12 3/4"

18-71337
MOLDED HOSE
 1 3/4" ID
 For: 4.3L, 5.0L, 5.7L
 Circulating Pump Hose

STRAIGHT HOSE



18-75100
MOLDED HOSE
 Straight 48"
 1" ID



18-75125
MOLDED HOSE
 Straight 48"
 1 1/4" ID

HOSE INTERCHANGE

Part #	Mercruiser Part #	Part #	Mercruiser Part #	Part #	Mercruiser Part #	Part #	Mercruiser Part #
18-70925	32-16021 1	18-70928	32-71613	18-70935	32-806856	18-70704	32-89653
18-3601	32-32461	18-70929	32-73794	18-70941	32-807697	18-70934	32-89718 1
18-71337	32-33189	18-70927	32-73795	18-70940	32-860144	18-70942	32-89730 1
18-3602	32-41725-33	18-70926	32-73796	18-70933	32-861634	18-70943	32-89749 1
18-3603	32-43437	18-70938	32-806635 1	18-71337	32-87108	18-70931	32-96879
18-71218	32-48132	18-70939	32-806636 1	18-70932	32-87117 1		
18-70930	32-52481						

V-BELTS

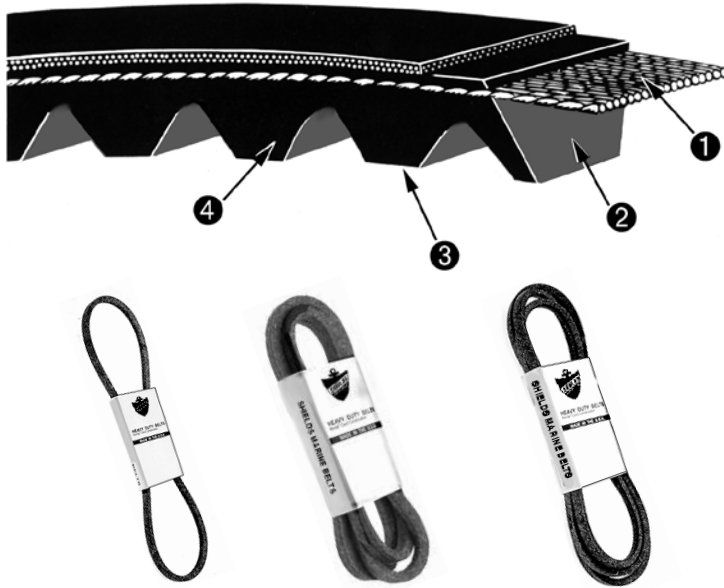

- ① High strength synthetic cords resist shockload failure. Their low stretch properties assure uniform performance over the life of the belt.
- ② The compression section is a special rubber compound that assures smooth and even transfer of load forces to the cords.
- ③ Cogs are molded to precise engineering tolerances to improve flexibility and maintain cord support. Cog geometry provides a large area for air circulation to keep the belt cool and prevent damaging heat build up in the cushion section.
- ④ Rubber edges maintain positive, no-slip contact with pulley grooves for reliable energy transfer.

BELT SIZE LISTING BY NUMBER

Part #	OE #	Effective Length (Inches)	Top Width (Inches)	Part #	OE #	Effective Length (Inches)	Top Width (Inches)
18-15290	57-13457,T	29	29/64	18-15435	57-64416	43 1/2	29/64
18-15300	57-49756	30	29/64	18-15440	57-49213A1,57-45856	44	29/64
18-15325	57-77274A1	32 1/2	29/64	18-15450	-	45	29/64
18-15345	57-74271T	34 1/2	29/64	18-15455	-	45 1/2	29/64
18-15370	57-65607T	37	29/64	18-15460	57-48120A1	46	29/64
18-15380	-	38	29/64	18-15470	57-78200A1	47	29/64
18-15390	57-52692	39	29/64	18-15480	57-48122	48	29/64
18-15400	57-32850,57-69143T	40	29/64	18-15490	57-816295T	52 1/2	29/64
18-15405	57-76269	40 1/2	29/64	18-15495	57-91035A1	49 1/2	29/64
18-15410	57-49043A1,			18-15500	57-96834T,Q	50	29/64
	57-64032A1,57-98043	41	29/64	18-15520	57-33170,Q,57-37619T	52	29/64
18-15415	57-36356	41 1/2	29/64	18-15550	57-13458T	55	29/64
18-15430	57-49211	43	29/64				

V-BELT APPLICATION

HP	Liter	Model	Years	CID	# Cyl	Stroke	Serial #	Type of Belt	Alternator/ Water Pump	Power Steering	Sea Water Pump
		233	1975-77		4		4173000 - 4902304	V-BELT	18-15440	—	—
		233	1975-77		4		4173000 - 4902304	V-BELT	18-15440	18-15290	18-15345 12
		233 MIE	1975-76		4		4173000 - 4775784	V-BELT	18-15440	—	—
	5.0L	5.0L	1988-1995	305	8	4	B774445 - F600999	V-BELT	— 9	18-15520 9	18-15345 12
	5.0L	5.0L	1988-1995	305	8	4	B774445 - F600999	V-BELT	18-15460 11	18-15490 11	18-15290 13
	5.0L	5.0L ALPHA RWC	1998-1999	305	8	4	L012052 - L618999	SERPENTINE	18-15116 1, 14, 21, 22	—	—
	5.0L	5.0L ALPHA FWC	1998-1999	305	8	4	L012052 - L618999	SERPENTINE	18-15114 14, 20, 22	—	—
	5.0L	5.0L ALPHA RWC	1998-1999	305	8	4	L012052 - L618999	SERPENTINE	18-15116 15, 21	—	—
	5.0L	5.0L ALPHA FWC	1998-1999	305	8	4	L012052 - L618999	SERPENTINE	18-15114 15, 20	—	—
	5.0L	5.0L BRAVO RWC	1998-1999	305	8	4	L012052 - L618999	SERPENTINE	18-15115 1, 14, 20, 22	—	—
	5.0L	5.0L BRAVO FWC	1998-1999	305	8	4	L012052 - L618999	SERPENTINE	18-15114 1, 14, 21, 22	—	—
	5.0L	5.0L BRAVO RWC	1998-1999	305	8	4	L012052 - L618999	SERPENTINE	18-15115 15, 21	—	—
	5.0L	5.0L BRAVO FWC	1998-1999	305	8	4	L012052 - L618999	SERPENTINE	18-15114 15, 20	—	—
	5.0L	5.0L MIE	1988	305	8	4	B788152 - C396832	V-BELT	18-15460 11	—	57-13457Q 13
	5.0L	5.0LX	1988	305	8	4	6218462 - F600999	V-BELT	— 9	18-15520 9	57-74271Q 12
	5.0L	5.0LX	1983-1995	305	8	4	6218462 - F600999	V-BELT	18-15460 11	18-15490 11	57-13457Q 13
	5.0L	5.0L	1988-95				B774445-F600999	V-BELT	—	18-15490	—
	5.0L	5.0LX	1988-95	4bbl	4	4	B773740-F600999	V-BELT	—	18-15490	—
	5.0L	898	1977-19884	305	8	4	4762210 - 6218461	V-BELT	18-15460 17	18-15325 17	18-15345
	5.0L	898	1977-1984	305	8	4	4762210 - 6218461	V-BELT	18-15440 17	18-15495	18-15345
	5.0L	898	1983-1984	305	8	4	6218462 - 6899057	V-BELT	— 9	18-15520 9	18-15345 9
	5.0L	898	1983-1984	305	8	4	6218462 - 6899057	V-BELT	18-15460 11	18-15490 11	18-15345
	5.0L	898 / 200 / 5.0L	1985-1995	305	8	4	6218462 - F600999	V-BELT	18-15440 20	18-15495	18-15345
	5.0L	898 / 200 / 5.0L	1985-1995	305	8	4	6218462 - F600999	V-BELT	18-15460 21	18-15520	18-15290
	5.7L	250 MCM / 250 MIE	1968-69	350	8	4	2314301 - 2639854	V-BELT	18-15460	—	—
	5.7L	250	1977	350	8	4	4768000 - 4908489	V-BELT	18-15440	18-15345	18-15345
	5.7L	255 MCM / 255 MIE	1973-74	350	8	4	3258728 - 4175499	V-BELT	18-15440	—	—
	5.7L	255	GM 1975-76	350	8	4	4175500 - 4498700	V-BELT	18-15460	18-15300	18-15345
	5.7L	255	GM 1976	350	8	4	4498701-4499060	V-BELT	18-15460	—	18-15345
	5.7L	255	GM 1976	350	8	4	4499061-4767999	V-BELT	18-15460	—	18-15345
	5.7L	255 MIE	GM 1975-77	350	8	4	4175500 - 4498700	V-BELT	18-15460	—	18-15345
	5.7L	255 MIE	GM 1977-78	350	8	4	4498701 - 4924564	V-BELT	18-15460	—	18-15345
	5.7L	255 MIE	GM 1978-1980	350	8	4	4924565 - 5907057	V-BELT	—	—	18-15345
	5.7L	260 MIE	1978-86	350	8	4	4924565 - B522505	V-BELT	18-15440	—	18-15345
	5.7L	260 / 5.7L MIE / 5.7L Ski	1987-93	350	8	4	B522506 - F024999	V-BELT	18-15440	—	18-15345 12
	5.7L	260 / 5.7L MIE / 5.7L Ski	1987-93	350	8	4	B522506 - F024999	V-BELT	18-15460	—	18-15290 13
	5.7L	260	1978-1982	350	8	4	4908850 - 6218461	V-BELT	18-15440 16	18-15495 17	18-15345
	5.7L	260	1978-1982	350	8	4	4908850 - 6218461	V-BELT	18-15460 17	—	18-15345
	5.7L	260	1987	350	8	4	B525982-B773304	V-BELT	—	18-15490	—
	5.7L	260	1983-1987	350	8	4	6218462 - B773304	V-BELT	18-15460 11	18-15490 11	18-15290 13
	5.7L	260 MIE	1987	350	8	4	B522506 - B788151	V-BELT	18-15460 11	—	18-15290 13
	5.7L	260 / 5.7L	1983-1995	350	8	4	6218462 - F600999	V-BELT	18-15440	18-15495	18-15345 20
	5.7L	260 / 5.7L	1983-1995	350	8	4	6218462 - F600999	V-BELT	18-15460	18-15520	18-15290 21
	5.7L	270 MCM / 270 MIE	1969-1972	350	8	4	2851074 - 3385720	V-BELT	18-15460	—	—
	5.7L	280 TRS	1975	350	8	4	4176250 - 4176468	V-BELT	18-15460	—	—
	5.7L	280 TRS	1975	350	8	4	4176250 - 4176468	V-BELT	18-15460	18-15300	—
	5.7L	280 TRS	1975-76	350	8	4	4176469 - 4499390	V-BELT	18-15460	18-15300	—
	5.7L	280 TRS	1976	350	8	4	4499391 - 4499780	V-BELT	18-15460	—	—
	5.7L	280 TRS	1976	350	8	4	4499781 - 4770199	V-BELT	18-15460	—	18-15325
		320 EFI	1987-89		8	4	A543604 - C622418	V-BELT	18-15440	18-15520	—
		330	1977-81		8	4	4623115-6083144	—	18-15470	—	18-15345
		330	1982-87		8	4	6083144 - B816540	—	18-15470	18-15500	18-15345 12
		330	1982-87		8	4	6083144 - B816540	—	18-15470	18-15550	18-15290 13
	5.7L	350 MAG ALPHA	1986-1995	350	8	4	A635178 - F600999	V-BELT	18-15440 9	18-15520 9	18-15345 20
	5.7L	350 MAG ALPHA	1986-1995	350	8	4	A635178 - F600999	V-BELT	18-15460 11	18-15490 11	18-15290 21
	5.7L	350 MAG ALPHA	1996	350	8	4	F601000 - K001500	V-BELT	18-15460	18-15490	18-15290
	5.7L	350 Mag Alpha	1987-1995	350	8	4	B525982 - F600999	V-BELT	—	18-15490	—
	5.7L	350 Mag Alpha	1996	350	8	4	F601000 - K001526	V-BELT	—	18-15490	—
	5.7L	350 Mag Alpha EFI / 350 Mag ALPHA Gen+	1996	350	8	4	F800300 - K001508	V-BELT	—	18-15490	—
	5.7L	350 Mag Bravo MPI	1995	350	8	4	F415189 - F601999	V-BELT	—	18-15490	—
	5.7L	350 Mag Bravo MPI / 350 Mag Bravo MPI Gen+	1996	350	8	4	F602000 - K001500	V-BELT	—	18-15490	—
	5.7L	350 MAG SKI	1991-96	350	8	4	D505450 - K040005	V-BELT	18-15460	—	18-15290
	5.7L	350 MAG ALPHA RWC	1997-1999	350	8	4	K001501 - L618999	SERPENTINE	18-15116 14, 21, 22	—	—
	5.7L	350 MAG ALPHA FWC	1997-1999	350	8	4	K001501 - L618999	SERPENTINE	18-15114 14, 20, 22	—	—
	5.7L	350 MAG ALPHA RWC	1997-1999	350	8	4	K001501 - L618999	SERPENTINE	18-15116 15, 20	—	—
	5.7L	350 MAG ALPHA FWC	1997-1999	350	8	4	K001501 - L618999	SERPENTINE	18-15114 15, 21	—	—
	5.7L	350 MAG BRAVO RWC	1997-1999	350	8	4	K001501 - L618999	SERPENTINE	18-15115 14, 21, 22	—	—
	5.7L	350 MAG BRAVO FWC	1997-1999	350	8	4	K001501 - L618999	SERPENTINE	18-15114 14, 20, 22	—	—
	5.7L	350 MAG BRAVO RWC	1997-1999	350	8	4	K001501 - L618999	SERPENTINE	18-15115 15, 21	—	—
	5.7L	350 MAG BRAVO FWC	1997-1999	350	8	4	K001501 - L618999	SERPENTINE	18-15114 15, 20	—	—
	5.7L	350 MIE	1974-75	350	8	4	3780450-4501640	—	18-15480	—	—
	5.7L	350 MIE	1976	350	8	4	4501641 - 4623109	—	18-15480	—	18-15345
	5.7L	350 MAG MPI / 350 MAG SKI	1995-1996	350	8	4	F350583 - F799999	V-BELT	18-15460	—	18-15290
	5.7L	350 MAG SKI	1991-1996	350	8	4	D505450 - K040005	V-BELT	18-15460	—	18-15290 12
	5.7L	5.7L	1988-1995	350	8	4	B773305 - F600999	V-BELT	— 9	18-15520 9	18-15345
	5.7L	5.7L	1988-1995	350	8	4	B773305 - F600999	V-BELT	18-15460 11	18-15490 11	18-15290
	5.7L	5.7L	1996	350	8	4	F601000 - K001505	V-BELT	18-15460	18-15490	18-15290
	5.7L	5.7L ALPHA RWC	1997-1999	350	8	4	K001506 - L618999	SERPENTINE	18-15116 14, 21, 22	—	—
	5.7L	5.7L ALPHA FWC	1997-1999	350	8	4	K001506 - L618999	SERPENTINE	18-15114 14, 20, 22	—	—
	5.7L	5.7L ALPHA RWC	1997-1999	350	8	4	K001506 - L618999	SERPENTINE	18-15116 15, 21	—	—
	5.7L	5.7L ALPHA FWC	1997-1999	350	8	4	K001506 - L618999	SERPENTINE	18-15114 15, 20	—	—
	5.7L	5.7L BRAVO RWC	1997-1999	350	8	4	K001506 - L618999	SERPENTINE	18-15114 14, 20, 22	—	—
	5.7L	5.7L BRAVO RWC	1997-1999	350	8	4	K001506 - L618999	SERPENTINE	18-15115 15, 21	—	—
	5.7L	5.7L BRAVO FWC	1997-1999	350	8	4	K001506 - L618999	SERPENTINE	18-15114 15, 20	—	—
	5.7L	5.7L MIE	1988-1993	350	8	4	B522506 - F024999	V-BELT	—	—	18-15345
	5.7L	5.7L MIE	1988-1993	350	8	4	B522506 - F024999	V-BELT	—	—	18-15290
	5.7L	5.7L MIE	1994-1996	350	8	4	F025000 - K040306	V-BELT	18-15460	—	18-15290
	5.7L	5.7L SKI	1985-1987	350	8	4	A338553 - B514626	V-BELT	—	—	18-15290 13
	5.7L	5.7L SKI	1987-1995	350	8	4	B514627 - F775199	V-BELT	—	—	18-15345
	5.7L	5.7L SKI	1987-1995	350	8	4	B514627 - F775199	V-BELT	—	—	18-15290
	5.7L	5.7L SKI	1996	350	8	4	F775200 - K040003	V-BELT	18-15460	—	18-15290
	5.7L	5.7LX	1996	350	8	4	F601000 - K001505	V-BELT	18-15460	18-15490	18-15290
	5.7L	5.7LX BRAVO EFI	1996	350	8	4	F800300 - K001505	V-BELT	18-15460	18-15490	18-15290
	5.7L	5.7LX BRAVO	1996	350	8	4	F601000 - K001505	V-BELT	18-15460	18-15490	18-15290
	5.7L	BLACK SCORPION SKI	1996	350	8	4	F800000 - K040000	V-BELT	18-15460	—	18-15290

- (1) 1/2" wide (13mm) belt
- (2) 3/8" wide (10mm) belt
- (3) 28" wide (711mm) belt
- (4) 30" wide (762mm) belt
- (5) 37" wide (940mm) belt
- (6) 40" wide (1016mm) belt
- (7) 50" wide (1270mm) belt
- (8) 55" wide (1397mm) belt
- (9) Use with 5 1/2" (140mm) dia water pump pulley

- (10) Use with 5 7/8" (149mm) dia water pump pulley
- (11) Use with 7" (178mm) dia water pump pulley
- (12) Use with stamped steel sea water pump pulley
- (13) Use with cast aluminum sea water pump pulley
- (14) Use with plastic 4 3/4" (121mm) dia p/s pump pulley
- (15) Use with metal 5 3/4" (146mm) dia p/s pump pulley
- (16) For engine with high mounted p/s pump</

V-BELT APPLICATION

HP	Liter	Model	Years	CID	# Cyl	Stroke	Serial #	Type of Belt	Alternator/ Water Pump	Power Steering	Sea Water Pump
	5.7L	5.7L MIE / 5.7L Ski	1994-96	350	8	4	F025000 - K040306		18-15460	—	—
	5.7L	5.7L	1988-96	350	8	4	B525982 - F600999		—	18-15490	—
	5.7L	5.7L 2bbl	1996	350	8	4	F601000 - K001526		—	18-15490	—
	5.7L	5.7L EFI 2bbl	1996	350	8	4	F752400 - K001505		—	18-15490	—
	5.7L	5.7L Alpha EFI / 5.7L ALPHA TBI	1995	350	8	4	F355305 - F752389		—	18-15490	—
	5.7L	5.7L Alpha EFI / 5.7L ALPHA TBI	1995	350	8	4	F225560 - F752399		—	18-15490	13
	5.7L	5.7LX EFI / 5.7LX TBI	1996	350	8	4	F752400 - K001505		—	18-15490	12
	5.7L	233	1975-1977	351	8	4	4173000 - 4902304	V-BELT	—	18-15290 30" BELT	18-15345
	6.2L	377 SCORPION MCM	1999-2005	377	8	4	L416146 - M907201	SERPENTINE	—	—	—
	7.4L	325 MCM / 325 MIE	1969-1974	427	8	4	2278747 - 3780449	V-BELT	18-15480	—	—
	7.4L	330	1977-1981	454	8	4	623115 - 6083144	V-BELT	18-15470	—	18-15345
	7.4L	330	1982-1987	454	8	4	6083145 - B816540	V-BELT	18-15470	18-15500 50" BELT	18-15345 12
	7.4L	330	1982-1987	454	8	4	6083145 - B816540	V-BELT	18-15470	18-15500 55" BELT	18-15290 13
	7.4L	330 MIE	1977-1980	454	8	4	4623115 - 5889913	V-BELT	18-15470	—	18-15345
	7.4L	340 MIE	1981-1987	454	8	4	5889914 - B788365	V-BELT	18-15470	—	18-15345 12
	7.4L	340 MIE	1981-1987	454	8	4	5889914 - B788365	V-BELT	18-15470	—	18-15290 13
	7.4L	340	1981-92	454	8	4	5889914 - D715493	V-BELT	18-15470	—	18-15345 12
	7.4L	340	1981-92	454	8	4	5889914 - D715493	V-BELT	18-15470	—	18-15290 13
	7.4L	350 MIE	1974-1975	454	8	4	3780450 - 4501640	V-BELT	18-15480	—	—
	7.4L	350 MIE	1976	454	8	4	4501641 - 4623109	V-BELT	18-15480	—	18-15345
	7.4L	370 TRS	1978-1985	454	8	4	4179554 - 6721527	V-BELT	18-15480	—	—
	7.4L	370 TRS	1985-1987	454	8	4	6721528 - B714586	V-BELT	18-15480	18-15500	18-15345
	7.4L	400 TRS	1980-1986	454	8	4	4179554 - B457644	V-BELT	18-15480	—	—
	7.4L	420	1987-1989	454	8	4	A398941 - B622418	V-BELT	—	18-15500	18-15345
	7.4L	425	1990-1992	454	8	4	B622419 - D725499	V-BELT	—	18-15500	18-15345
	7.4L	425	1992	454	8	4	D725500 - D937011	V-BELT	—	—	18-15400
	7.4L	440 TRS	1983-1986	454	8	4	4179554 - B485220	V-BELT	18-15480	—	—
	7.4L	450	1995-1996	454	8	4	F347100 - F347277	V-BELT	—	—	18-15400
	7.4L	454 MAG ALPHA	1986-1988	454	8	4	A631894 - B785148	V-BELT	18-15470	18-15500 50" BELT	—
	7.4L	454 MAG ALPHA	1986-1988	454	8	4	A631894 - B785148	V-BELT	18-15470	18-15500 55" BELT	—
	7.4L	454 MAG	1988-92	454	8	4	B712106 - D805068	V-BELT	18-15470	—	18-15290
	7.4L	454 MAG	1988-92	454	8	4	B712106 - D805068	V-BELT	18-15480	—	18-15290
	7.4L	454 MAG	1992-97	454	8	4	D805069 - K999999	V-BELT	18-15480	—	18-15400
	7.4L	454 MAG MPI	1994-97	454	8	4	F115700 - K147349	V-BELT	18-15480	—	18-15400
	7.4L	454 MAG MPI	1997	454	8	4	K147350 - K999999	V-BELT	18-15480	—	18-15290
	7.4L	454 MAG Ski	1995-97	454	8	4	F215800 - K999999	V-BELT	18-15480	—	18-15400
	7.4L	454 MAG BRAVO	1988-1992	454	8	4	B712106 - D805068	V-BELT	18-15470	18-15500 9	18-15290
	7.4L	454 MAG BRAVO	1988-1992	454	8	4	B712106 - D805068	V-BELT	18-15480 11	— 11	18-15290
	7.4L	454 MAG BRAVO	1992-1997	454	8	4	D805069 - K999999	V-BELT	18-15480	—	18-15400
	7.4L	454 MAG EFI	1994-1996	464	8	4	F115700 - F802349	V-BELT	18-15480	—	18-15400
	7.4L	454 MAG EFI SKI	1995-1996	454	8	4	F215800 - F820099	V-BELT	18-15480	—	18-15400
	7.4L	454 MAG MPI	1996-1997	454	8	4	F115700 - F147349	V-BELT	18-15480	—	18-15400
	7.4L	454 MAG MPI	1997	454	8	4	K147350 - K999999	V-BELT	18-15480	—	18-15290
	7.4L	525 SC	1991-1999	454	8	4	D456000 - L415623	V-BELT	—	18-15500	18-15400
	7.4L	7.4L BRAVO	1988-1991	454	8	4	B711113 - D603117	V-BELT	18-15470	18-15500 9	18-15290
	7.4L	7.4L BRAVO	1988-1991	454	8	4	B711113 - D603117	V-BELT	18-15480	— 11	18-15290
	7.4L	7.4L BRAVO	1992-1997	454	8	4	D603118 - K999999	V-BELT	18-15480	—	18-15400
	7.4L	7.4L MIE WITH B/W	1988-1992	454	8	4	B788366 - D715493	V-BELT	18-15470	—	18-15290
	7.4L	7.4L MIE WITH B/W	1988-1992	454	8	4	B788366 - D715493	V-BELT	18-15470	—	18-15400
	7.4L	7.4L MIE WITH HURTH	1989-1992	454	8	4	C391564 - D715493	V-BELT	18-15470 10	—	18-15290 12
	7.4L	7.4L MIE WITH HURTH	1989-1992	454	8	4	C391564 - D715493	V-BELT	18-15480 11	—	18-15290 13
	7.4L	7.4L MIE	1992-1997	454	8	4	D715494 - K999999	V-BELT	18-15480	—	18-15400
	7.4L	7.4L MPI	1998-2001	454	8	4	L010003 - M024330	SERPENTINE	18-15114 14, 22	—	—
	7.4L	7.4L MPI	1998-2001	454	8	4	L010003 - M024330	SERPENTINE	18-15114 14	—	—
	7.4L	7.4L MPI / 7.4L MIE	1995-1996	454	8	4	F563052 - F820131	V-BELT	18-15480	—	18-15400
	7.4L	7.4L MPI / 7.4L MIE	1996-1997	454	8	4	F820132 - K999999	V-BELT	18-15480	—	18-15290
	7.4L	7.4LX BRAVO EFI	1996-1997	454	8	4	F820000 - K999999	V-BELT	18-15480	—	18-15290
	7.4L	7.4LX BRAVO MPI	1996-1997	454	8	4	F602010 - K147349	V-BELT	18-15480	—	18-15400
	7.4L	7.4LX BRAVO MPI	1997	454	8	4	K147350 - K999999	V-BELT	18-15480	—	18-15290
	7.4L	7.4LX Bravo MPI	1996-97	454	8	4	F602010 - K147349	V-BELT	18-15480	—	18-15400
	7.4L	7.4L MIE	1992-97	454	8	4	C391564 - K999999	V-BELT	18-15480	—	18-15400
	7.4L	370 TRS	1978-85	8	4	4	4179554 - 6721527	V-BELT	18-15480	—	—
	7.4L	370 TRS	1985-87	8	4	4	6721528 - B714586	V-BELT	18-15480	18-15500	—
		390 MCM / 390 MIE	1969-1970	482	8	4	2781129 - 3042731	V-BELT	18-15480	—	—
		400 TRS	1983-1986	482	8	4	4179554 - 6181046	V-BELT	18-15480	—	—
		420/425	1987-1992	8	4	4	A398941 - D725499	V-BELT	18-15480	18-15500	—
		420 / 425	1992	8	4	4	D725500 - D937011	V-BELT	18-15480	—	18-15400
		440 TRS	1983-1986	8	4	4	4179554 - B485220	V-BELT	18-15480	—	—
		450	1995-1996	8	4	4	F347100 - F347227	V-BELT	18-15480	—	18-15400
		460 TRS	1983-1986	8	4	4	4179554 - 6181046	V-BELT	18-15480	—	—
		465	1990-1992	502	8	4	C849992 - D725646	V-BELT	—	—	18-15290
		8.2L 465	1992-1994	502	8	4	D725647 - F213244	V-BELT	—	—	18-15400
		8.2L 500	1994-1998	502	8	4	F213293 - L001772	V-BELT	—	—	18-15400
		8.2L 500 GEN +	1999	502	8	4	L414639 - L601036	V-BELT	—	—	18-15400
		8.2L 502 MAG BRAVO	1990-1997	502	8	4	C878221 - D824588	V-BELT	18-15480	—	18-15290
		8.2L 502 MAG BRAVO	1990-1997	502	8	4	C824589 - K999999	V-BELT	18-15480	—	18-15400
		8.2L 502 MAG EFI	1994-1995	502	8	4	D840650 - F802599	V-BELT	18-15480	—	18-15400
		8.2L 502 MAG MPI	1996-1997	502	8	4	F802600 - K147349	V-BELT	18-15480	—	18-15400
		8.2L 502 MAG MPI	1997	502	8	4	K147350 - K999999	V-BELT	18-15480	—	18-15290
		8.2L 502 MAG MPI	1998-2001	502	8	4	L017000 - M024999	SERPENTINE	18-15114 14, 22	—	—
		8.2L 502 MAG MPI	1998-2001	502	8	4	L017000 - M024999	SERPENTINE	18-15114 14	—	—
		8.2L 600 SC	1991-1992	502	8	4	D456489 - D456768	V-BELT	—	18-15500	18-15345
		8.2L 600 SC	1992-2000	502	8	4	D725676 - L601186	V-BELT	—	18-15500	18-15400
		8.2L 8.2L MIE	1990-1993	502	8	4	C878221 - D857199	V-BELT	18-15480	—	18-15290
		8.2L 8.2L MIE	1993-1997	502	8	4	D857200 - K999999	V-BELT	18-15480	—	18-15400
		8.2L 8.2L MPI MIE	1996-1997	502	8	4	F819620 - K147349	V-BELT	18-15480	—	18-15400
		8.2L 8.2L MPI MIE	1997	502	8	4	K147350 - K999999	V-BELT	18-15480	—	18-15290
		8.2L 500 BULLDOG	1990-2001	540	8	4	C577254 - M050281	V-BELT	—	3/8" BELT WIDTH	18-15345
		8.2L 500 BULLDOG	1990-2001	540	8	4	C577254 - M050281	V-BELT	—	1/2" BELT WIDTH	18-15345

- (1) 1/2" wide (13mm) belt
- (2) 3/8" wide (10mm) belt
- (3) 28" wide (711mm) belt
- (4) 30" wide (762mm) belt
- (5) 37" wide (940mm) belt
- (6) 40" wide (1016mm) belt
- (7) 50" wide (1270mm) belt
- (8) 55" wide (1397mm) belt
- (9) Use with 5 1/2" (140mm) dia water pump pulley

- (10) Use with 5 7/8" (149mm) dia water pump pulley
- (11) Use with 7" (178mm) dia water pump pulley
- (12) Use with stamped steel sea water pump pulley
- (13) Use with cast aluminum sea water pump pulley
- (14) Use with plastic 4 3/4" (121mm) dia p/s pump pulley
- (15) Use with metal 5 3/4" (146mm) dia p/s pump pulley
- (16) For engine with high mounted p/s pump
- (17) For engines with low mounted p/s pump
- (18) For engine with power steering

- (19) For engines w/o power steering
- (20) For engines with closed cooling
- (21) For engines with standard cooling
- (22) Replacement kit includes 5 3/4" (146mm) pulley and longer serpentine belt
- (23) For engines with high mounted alternator

SERPENTINE BELTS



BELT INTERCHANGE

Part #	OE #	Width	Length	Part #	OE #	Width	Length
18-15100	57-863876 3	13/16	106.25	18-15114	57-861049	13/16	104.25
18-15101	57-863876 4	13/16	76.5	18-15115	57-861757	13/16	97.5
18-15102	57-863876 6	13/16	105	18-15116	57-861758	13/16	86.75
18-15103	57-863876 7, 57-865615007	13/16	96.75	18-15119	57-863876 1	13/16	111.25
18-15104	57-863876 8	13/16	99.5	18-15121	57-865615005	13/16	87.5
18-15105	57-863876 9, 57-865615009	13/16	69.75	18-15122	57-865615010	13/16	86
18-15112	57-8077554	13/16	88	18-15123	57-864639	13/16	85
				18-15125	57-817113	1-3/8	53.5

BELT APPLICATION

Engine	Years	Serial #	Part #	Mercruiser #	Footnote	Engine	Years	Serial #	Part #	Mercruiser #	Footnote
4.3L Alpha	1996-99	OF803000-OL618999	18-15116	57-861758	2, 6	5.7L Bravo	2002-04	OM600000 & up	18-15102	57-863876 6	3, 5, 7
4.3L Alpha	2000-04	OL619000 & up	18-15101	57-863876 4	3, 6, 7	5.7L Bravo	2000-04	OL619000 & up	18-15104	57-863876 8	4, 7
4.3L Alpha	2000-04	OL619000 & up	18-15104	57-863876 8	4, 5, 7	5.7L Ski	1997-02	OK040004-OM316999	18-15112	57-8077554	
4.3L Alpha	2000-04	OL619000 & up	18-15105	57-865615009	4, 6, 7	5.7L Ski	2002-05	OM317000 & up	18-15121	57-865615005	
4.3L Bravo	1996-99	OF803000-OL618999	18-15114	57-861049	2, 5	5.7L MIE	2001-05	OL677227 & up	18-15121	57-865615005	
4.3L Bravo	1996-99	OF803000-OL618999	18-15115	57-861757	2, 6	377 Scorpion MCM	1999-04	OL416146 & up	18-15115	57-861757	
4.3L Bravo	2000-04	OL619000 & up	18-15104	57-863876 8	4, 7	377 Scorpion Ski	1997-98	OK000656 & up	18-15112	57-8077554	
5.0L Bravo	2002-04	OM600000 & up	18-15102	57-863876 6	3, 5, 7	454 Mag MPI	1998-01	OL010029-OM024999	18-15114	57-861049	1
5.0L Alpha	1998-99	OL012052-OL618999	18-15114	57-861049	5	454 Mag MPI	1998-01	OL010029-OM024999	18-15102	57-863876 6	2
5.0L Alpha	1998-99	OL012052-OL618999	18-15116	57-861758	2, 6	454 Mag MPI	1998-01	OL010029-OM024999	18-15103	57-865615007	4
5.0L Alpha	2000-04	OL619000 & up	18-15101	57-863876 4	3, 6, 7	454 Mag MPI Horizon MIE	1998-01	OL002200-OL674000	18-15103	57-865615007	
5.0L Alpha	2002-04	OM600000 & up	18-15102	57-863876 6	3, 5, 7	496 Mag & HO	2000-04	OM025000 & up	18-15119	57-863876 1	
5.0L Alpha	2001-04	OL619000 & up	18-15104	57-863876 8	4, 5, 7	500 EFI	1999-04	OL001477 & up	18-15112	57-8077554	
5.0L Alpha	2000-04	OL619000 & up	18-15105	57-865615009	4, 6, 7	502 Mag MPI	1998-01	OL017000-OM024999	18-15114	57-861049	1
5.0L Bravo	1998-99	OL012052-OL618999	18-15114	57-861049	2, 5	502 Mag MPI	1998-01	OL017000-OM024999	18-15103	57-865615007	4
5.0L Bravo	1998-99	OL012052-OL618999	18-15115	57-861757	2, 6	502 Mag. MPI	1998-01	OL017000-OM024999	18-15102	57-863876 6	2
5.0L Bravo	2000-04	OL619000 & up	18-15104	57-863876 8	4, 7	525 SC	1991-96	OD456000-745215	18-15125	57-817113	
350 Mag, Alpha	1997-04	OK001501-OL618999	18-15114	57-861049	2, 5	575 Sci	2000-05	OL306696 & up	18-15125	57-817113	8
350 Mag, Alpha	1997-04	OK001501-OL618999	18-15116	57-861758	2, 6	575 Sci	2000-05	OL306696 & up	18-15112	57-8077554	9
350 Mag, Alpha	2000-04	OL619000 & up	18-15103	57-865615007	3, 6, 7	600 SC	1991-96	OD456489-OF877462	18-15125	57-817113	
350 Mag, Alpha	2002-04	OM600000 & up	18-15102	57-863876 6	3, 5, 7	600 SC	1998	OK000227 & up	18-15125	57-817113	
350 Mag, Alpha	2000-04	OL619000 & up	18-15104	57-863876 8	4, 5, 7	7.4L MPI	1998-01	OL010003-OM024330	18-15114	57-861049	1
350 Mag, Alpha	2000-04	OL619000 & up	18-15105	57-865615009	4, 6, 7	7.4L MPI	1998-01	OL010003-OM024330	18-15102	57-863876 6	2
350 Mag, Bravo	1997-04	OK001501-OL618999	18-15114	57-861049	2, 5	7.4L MPI	1998-01	OL010003-OM024330	18-15103	57-865615007	4
350 Mag, Bravo	1997-04	OK001501-OL618999	18-15115	57-861757	2, 6	7.4L MPI MIE	1998-01	OL002006-OM025999	18-15103	57-865615007	
350 Mag, Bravo	2002-04	OM600000 & up	18-15102	57-863876 6	3, 5, 7	Black Scorpion Ski	1997-01	OK040001-OM391599	18-15112	57-8077554	
350 Mag, Bravo	2000-04	OL619000 & up	18-15104	57-863876 8	4, 7	Black Scorpion Ski	2003-05	OM391600 & up	18-15121	57-865615005	
350 Mag MPI MIE	2001-05	OL678399-up	18-15121	57-865615005	6	MX 6.2L Bk Scorpion Ski	2001	OL670015-OM391599	18-15112	57-8077554	
350 Mag MPI MIE	2002-05	OM317000 & up	18-15122	57-865615010	5	MX 6.2L MPI	2002-04	OM600000 & up	18-15102	57-863876 6	3, 5
350 Mag MPI Ski	2001-05	OM300000 & up	18-15121	57-865615005		MX 6.2L MPI	2000-04	OL680003 & up	18-15104	57-863876 8	4, 7
350 Mag MPI Horizon MIE	2001-02	OL678399-OM316999	18-15121	57-865615005		MX 6.2L MPI Horizon	2002-04	OM600000 & up	18-15102	57-863876 6	3
350 Mag MPI Horizon MIE	2001-05	OM317000 & up	18-15122	57-865615010		MX 6.2L MPI Horizon	2001-04	OM300000 & up	18-15104	57-863876 8	4
5.7L Alpha	1997-99	OK001501-OL618999	18-15114	57-861049	2, 5	MX 6.2L MPI Horizon MIE	2001	OM300000-OM310099	18-15112	57-8077554	
5.7L Alpha	1997-99	OK001506-OL618999	18-15116	57-861758	2, 6	MX 6.2L MPI Horizon MIE	2001-05	OM310100 & up	18-15121	57-865615005	6
5.7L Alpha	2000-04	OL619000 & up	18-15101	57-863876 4	3, 6, 7	MX 6.2L MPI Horizon MIE	2002-05	OM317000 & up	18-15122	57-865615010	5
5.7L Alpha	2002-04	OM600000 & up	18-15102	57-863876 6	3, 5, 7	MX 6.2L MPI MIE	1999-01	OL670000-OM310099	18-15112	57-8077554	
5.7L Alpha	2000-04	OL619000 & up	18-15104	57-863876 8	4, 5, 7	MX 6.2L MPI MIE	2001-05	OM310100 & up	18-15121	57-865615005	6
5.7L Alpha	2000-05	OL619000 & up	18-15105	57-865615009	4, 6, 7	MX 6.2L MPI MIE	2002-05	OM317000 & up	18-15122	57-865615010	5
5.7L Bravo	1997-99	OK001506-OL618999	18-15114	57-861049	2, 5	MX 6.2L MPI Ski	2002-05	OM317000 & up	18-15121	57-865615005	
5.7L Bravo	1997-99	OK001506-OL618999	18-15115	57-861757	2, 6	8.2L MPI MIE	1998-01	OL002450-OL674200	18-15103	57-865615007	

Footnote

1: Use with plastic 4-3/4" dia. p/s pump pulley
 2: Use with metal 5-3/4" dia. p/s pump pulley
 3: For engines with power steering

4: For engines without power steering
 5: For engines with closed cooling
 6: For engines with standard cooling

7: Engines with high mounted alternators
 8: Blower
 9: Alternator

Fits GM Big Block V8 454 cu. in. Models 330, 340 & 7.4L

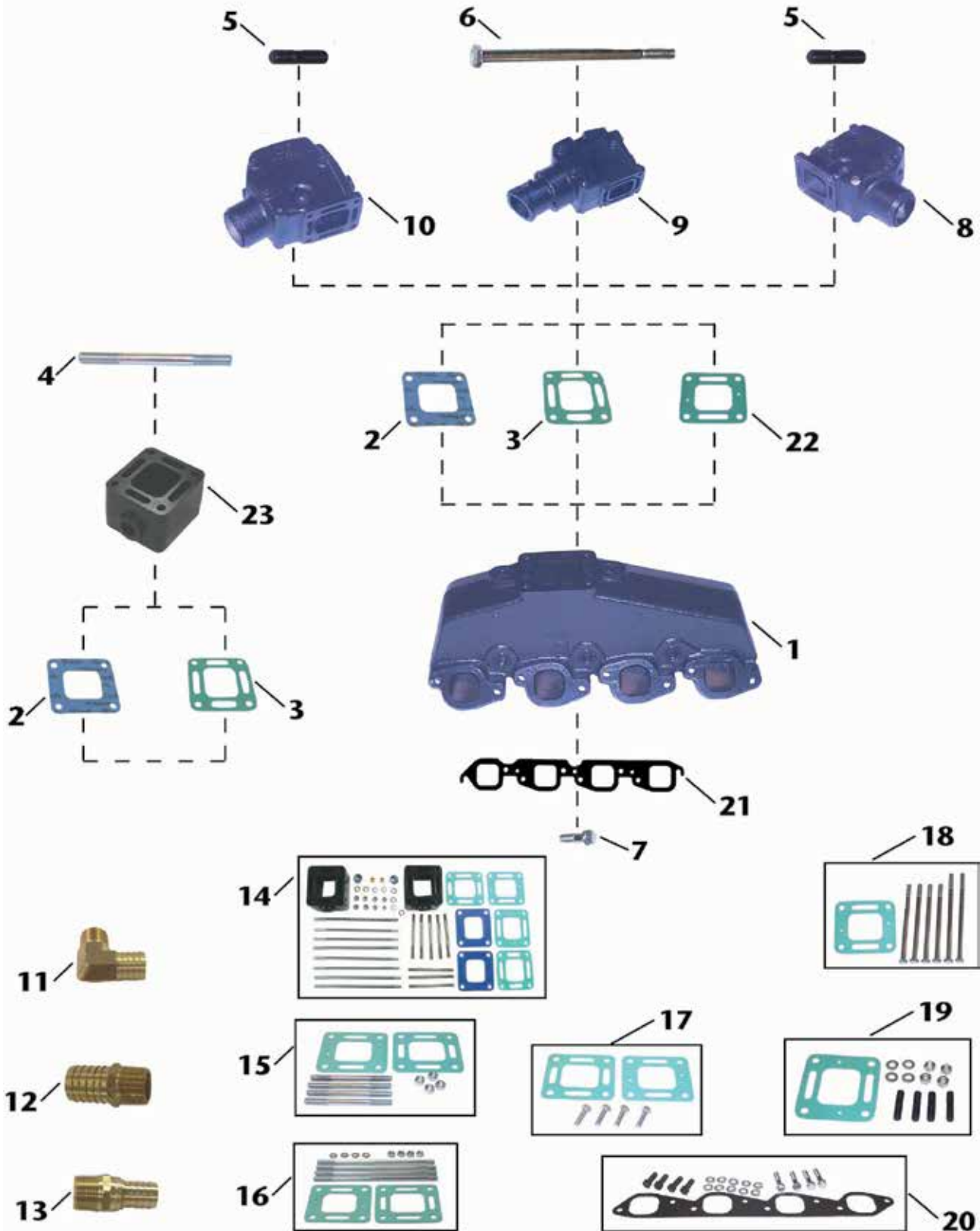

Item No	Description	OE No.	Application
1	18-1957-1 MANIFOLD	807078A6	GM Big Block (V8) 454 cu.in. Models 330, 340 & 7.4L. Use with 18-0418 manifold gasket; Mounting Kit: 18-8532
2	18-0672 (BLOCKED) ELBOW GASKET	27-860231	Fits Manifold: 18-1957-1; Elbows: 18-1970-1, & 18-1976-1, 18-1974: Spacer 18-1908.
3	18-2849 ELBOW GASKET (OPEN)	27-818832	Fits Manifold: 18-1957-1; Elbows: 18-1970-1, & 18-1976-1, 18-1974: Spacer 18-1908.
4	NSS MOUNTING STUD	N/A	Included in 18-8554 mounting kit.
5	NSS MOUNTING STUD	N/A	Included in 18-8529 mounting kit.
6	NSS MOUNTING BOLT	N/A	Included in 18-8505 mounting kit.
7	NSS MOUNTING BOLT	N/A	Included in 18-8532 mounting kit.
8	18-1974-1 MANIFOLD ELBOW	98502A2	Fits Manifold: 18-1957-1. Use Elbow gaskets: 18-2849, 18-0897, or 18-0672; Use mounting kit: 18-8529 (Do not use with spacer)
9	18-1976-1 MANIFOLD ELBOW	44354A3	Fits Manifold: 18-1957-1. Use Elbow gaskets: 18-2849, 18-0897, or 18-0672; Use mounting kit: 18-8505, or if spacer is included use 18-8555
10	18-1970-1 MANIFOLD ELBOW	98504A3	Fits Manifold: 18-1957-1. Use Elbow gaskets: 18-2849, 18-0897, or 18-0672; Use mounting kit: 18-8529, or if spacer is included use 18-8554.
11	18-8216 HOSE FITTING	N/A	3/4" - 14NPT X 1" Hose (Corrosion Resistant Brass Fitting)
12	18-4461 HOSE FITTING	N/A	3/4" - 14NPT X 1" Hose (Corrosion Resistant Brass Fitting)
13	18-8215 HOSE FITTING	N/A	3/4" - 14NPT X 3/4" Hose (Corrosion Resistant Brass Fitting)
14	18-1908K MANIFOLD SPACER KIT	807476A6, 93320A5	3" Riser Kit for Manifold: 18-1957-1. Includes (2) spacers, restrictor, open, & blocked gasket. All necessary mounting hardware is also included.
15	18-8554 MOUNTING KIT	N/A	Use 18-8554 Mounting Kit when 18-1908 Spacer, 18-1970-1 Elbow and 18-1974 Elbow are used together. Included in 18-1908K. Includes (1) 18-2849 & 18-0897 elbow gaskets.
16	18-8555 MOUNTING KIT	N/A	Use with Manifold Spacer: 18-1908 with Riser 18-1976-1. Included in 18-1908K. Includes (1) 18-2849 & 18-0897 elbow gaskets.
17	18-8556 MOUNTING KIT	N/A	Use with Manifold Spacer: 18-1985. Includes (1) 18-2849 & 18-0897 elbow gaskets
18	18-8505 MOUNTING KIT	N/A	Use with Riser: 18-1976-1. Includes 18-0897 elbow gasket.
19	18-8529 MOUNTING KIT	N/A	Use with Risers: 18-1970-1 & 18-1974-1. Includes 18-0897 elbow gasket.
20	18-8532 MOUNTING KIT	N/A	Use with Manifold: 18-1957-1. Includes 18-0418 manifold gasket.
21	18-0418 MANIFOLD GASKET	96653 / 27-46820	Use with Manifold: 18-1957-1. Included in 18-8532 mounting kit.
22	18-0897 (RESTRICTOR) ELBOW GASKET	27-41813	Fits Manifold: 18-1957-1; Manifold Spacers: 18-1985, & 18-1908; Elbows: 18-1970-1, & 18-1976-1, 18-1974
23	18-1908 MANIFOLD SPACER	93322A12	3" Spacer for Manifold: 18-1952-1. Use with mounting kit 18-8556. (Note: To mount elbows to spacer a separate mounting kit is needed)

Fits GM In-Line 6 Cylinder 250 & 292 cu. in. Models 165 & 200

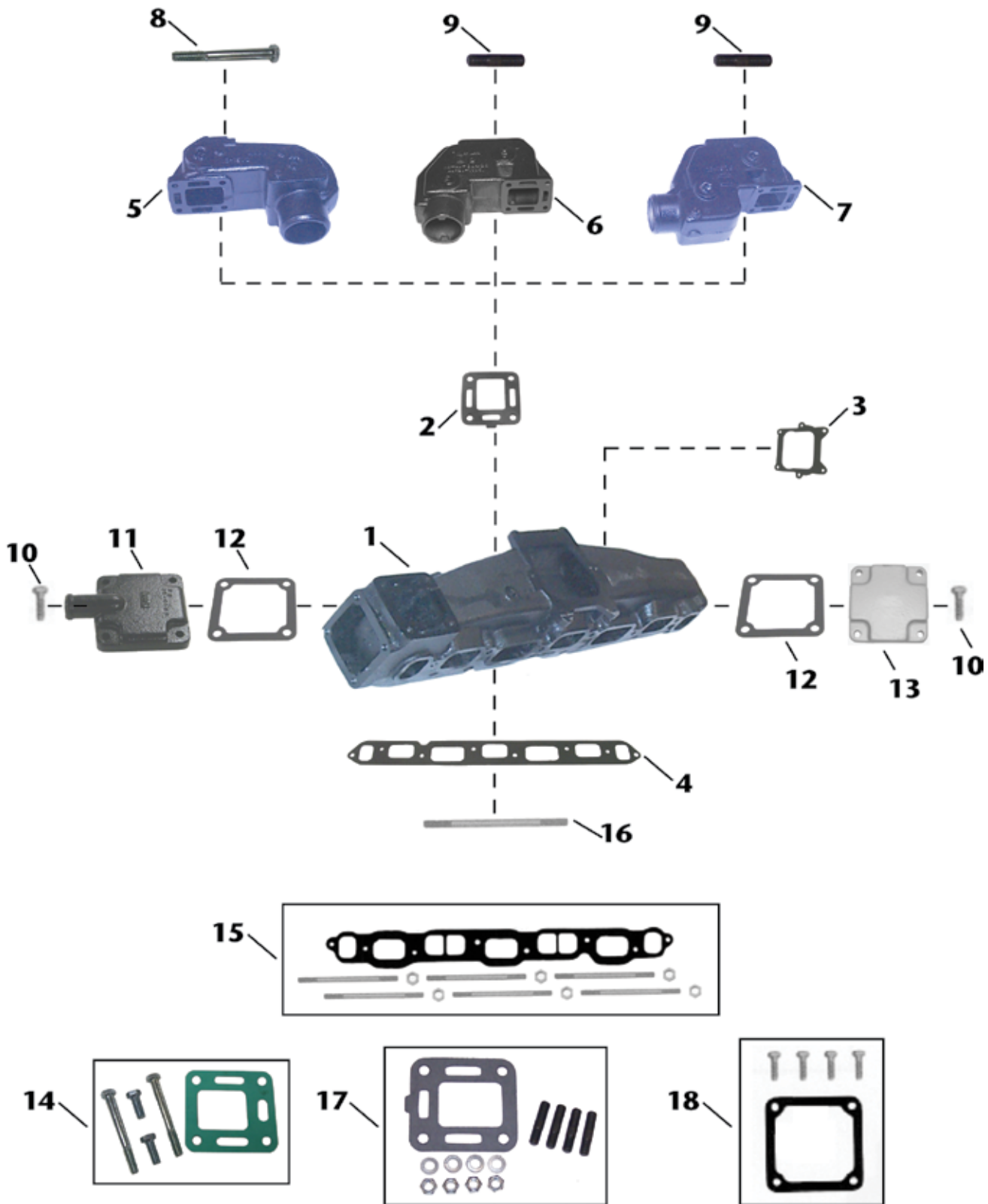

Item No	Description	OE No.	Application
1	18-1960-1 MANIFOLD	58759A10	GM In-Line Six Cylinder 250 & 292 cu.in. Models 165 & 200. Use with 18-2830 manifold gasket; 18-8531 Mounting Kit
2	18-2833 ELBOW GASKET	27-99777-2	Use with Elbows: 18-1971, 18-1978 & 18-1972. Included in 18-4362 mounting kit.
3	18-0353 CARBURETOR GASKET	27-58764	Fits Manifold: 18-1960-1
4	18-2830 MANIFOLD GASKET	27-46401	Fits Manifold: 18-1960-1. Included in 18-8531 mounting kit.
5	18-1972 MANIFOLD ELBOW	76325A2	Use with Manifold: 18-1960-1; Elbow Gasket 18-2833
6	18-1971 MANIFOLD ELBOW	76351A2	Use with Manifold: 18-1960-1; Elbow Gasket 18-2833; Mounting Kit 18-4362.
7	18-1978 MANIFOLD ELBOW	76771A3	Use with Manifold: 18-1960-1; Elbow Gasket 18-2833; Mounting Kit 18-4362.
8	NSS MOUNTING BOLT	N/A	Included in 18-8552 mounting hardware.
9	18-3233 MOUNTING STUD	16-49545	3/8-24, 3/8-16 X 1 3/4. Included in 18-4362 mounting kit.
10	NSS MOUNTING BOLT	N/A	Included in 18-8512 mounting kit.
11	18-4009 FRONT PLATE	60252A2	Fits Manifold: 18-1960-1
12	18-2832 FRONT/END PLATE GASKET	27-48043-1	Fits Port & Starboard Caps of Manifold: 18-1960-1. Included in 18-8512 mounting kit.
13	NSS END PLATE	N/A	Fits Manifold: 18-1960-1
14	18-8552 HARDWARE KIT	N/A	Includes only hardware for 18-1972 elbow.
15	18-8531 MOUNTING KIT	N/A	Use with Manifold: 18-1960-1. Includes 18-2830 manifold gasket.
16	NSS MOUNTING STUD	N/A	Included in 18-8531 mounting kit.
17	18-4362 MOUNTING KIT	N/A	Use with Elbows: 18-1971 & 18-1978. Includes 18-2833 elbow gasket.
18	18-8512 MOUNTING KIT	N/A	Use with Front Plate: 18-4009. Includes 18-2832 gasket.



Fits GM V6 229 & 262 cu. in. Models 185 & 205

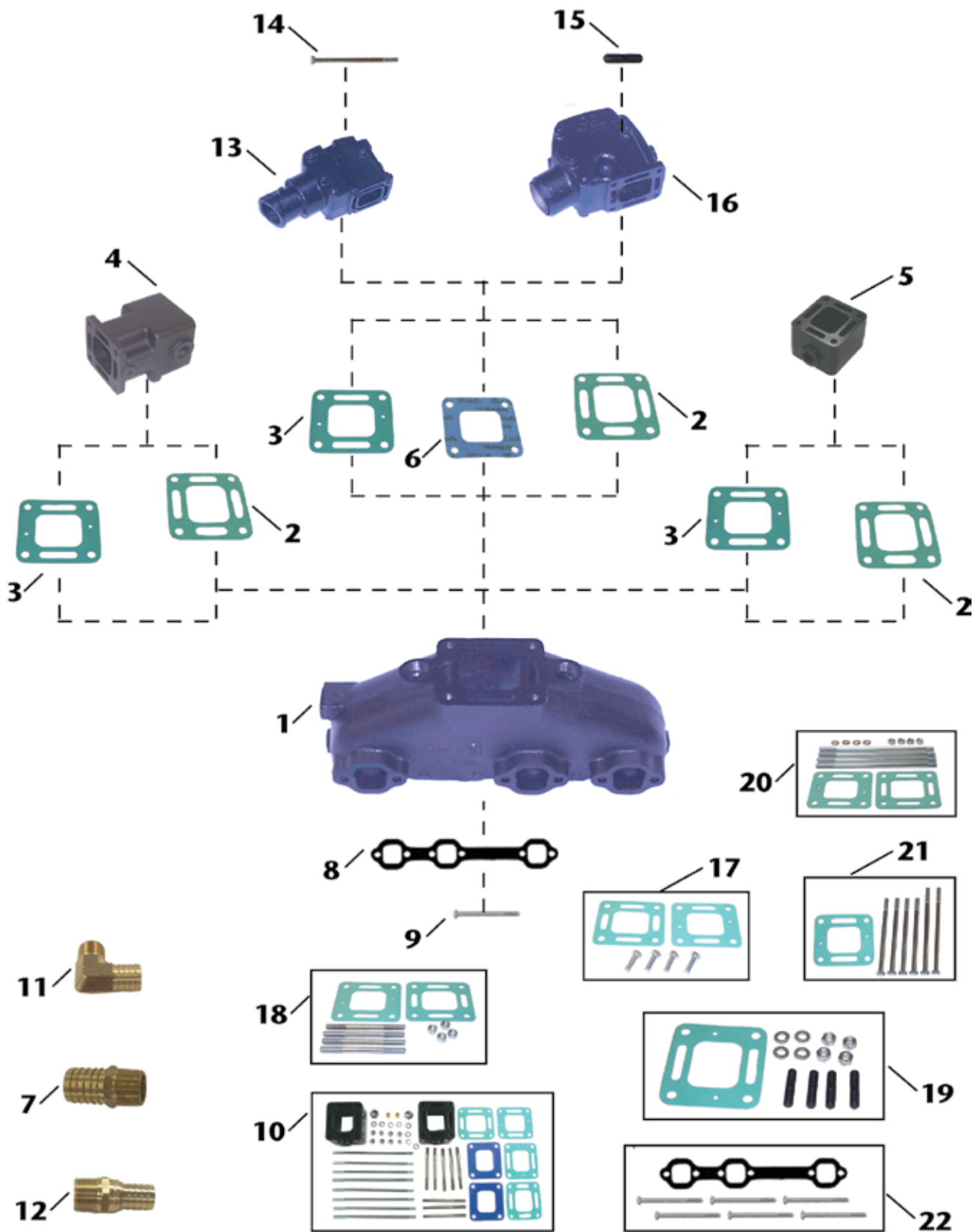

	Item No	Description	OE No.	Application
1	18-1952-1	MANIFOLD	99746A8	GM (V6) 229 & 262 cu.in. Models 185 & 205 (Port & Starboard). Use with Manifold Gasket: 18-2909; Mounting Kit: 18-8533
2	18-2849	ELBOW GASKET (OPEN)	27-818832	Fits Manifold: 18-1952-1; Manifold Spacers: 18-1985, & 18-1908; Elbows: 18-1970-1, & 18-1976-1
3	18-0897	ELBOW GASKET (RESTRICTOR)	27-41813	Fits Manifold: 18-1952-1; Manifold Spacers: 18-1985, & 18-1908; Elbows: 18-1970-1, & 18-1976-1
4	18-1985	MANIFOLD SPACER	93322A12	6" Spacer for Manifold: 18-1952-1. Use with mounting kit 18-8556. (Note: To mount elbows to spacer a separate mounting kit is required)
5	18-1908	MANIFOLD SPACER	933220	3" Spacer for Manifold: 18-1952-1. Use with mounting kit 18-8555 with 18-1976-1, or mounting kit 18-8554 with 18-1970-1.
6	18-0672	ELBOW GASKET (BLOCKED)	27-860231	Fits Manifold: 18-1952-1; Elbows: 18-1970-1, & 18-1976-1
7	18-4461	HOSE FITTING	N/A	3/4" - 14NPT X 1" Hose (Corrosion Resistant Brass Fitting)
8	18-2909	MANIFOLD GASKET	N/A	Gasket for Manifold: 18-1952-1. Included in 18-8533 mounting kit.
9	NSS	MOUNTING BOLT	N/A	Included in 18-8533 mounting kit.
10	18-1908K	MANIFOLD SPACER KIT	807476A6, 93320A5	3" Riser Kit for Manifold: 18-1952-1. Includes (2) spacers, restrictor, open, & blocked gasket. All necessary mounting hardware is also included.
11	18-8216	HOSE FITTING	N/A	3/4" - 14NPT X 1" Hose (Corrosion Resistant Brass Fitting)
12	18-8215	HOSE FITTING	N/A	3/4" - 14NPT X 3/4" Hose (Corrosion Resistant Brass Fitting)
13	18-1976-1	MANIFOLD ELBOW	44354A3, 807914A1	Fits Manifold: 18-1952-1. Use Elbow gaskets: 18-2849. 18-0897, or 18-0672; Use mounting kit: 18-8554
14	NSS	MOUNTING BOLT	N/A	Included in 18-8505 mounting kit.
15	NSS	MOUNTING STUD	N/A	Included in 18-8529 mounting kit.
16	18-1970-1	MANIFOLD ELBOW	98504A3	Fits Manifold: 18-1952-1. Use Elbow gaskets: 18-2849. 18-0897, or 18-0672; Use mounting kit: 18-8529, or if spacer is included use 18-8555.
17	18-8556	MOUNTING KIT	N/A	Use with Manifold Spacer: 18-1985. Includes (1) 18-2849 & 18-0897
18	18-8554	MOUNTING KIT	N/A	Use with Manifold Spacer: 18-1908 with Riser 18-1970-1. Included in 18-1908K. Includes (1) 18-2849 & 18-0897 elbow gaskets.
19	18-8529	MOUNTING KIT	N/A	Use with Riser: 18-1970-1. Includes 18-0897 elbow gaskets.
20	18-8555	MOUNTING KIT	N/A	Use with Manifold Spacer: 18-1908 with Riser 18-1976-1. Included in 18-1908K. Includes (1) 18-2849 & 18-0897 elbow gasket.
21	18-8505	MOUNTING KIT	N/A	Use with Riser: 18-1976-1. Includes 18-0897 elbow gasket.
22	18-8533	MOUNTING KIT	N/A	Use with Manifold: 18-1952-1. Includes 18-2909 manifold gasket.

Fits GM Small Block V8 305-350 cu. in. Models 198, 228 & 898

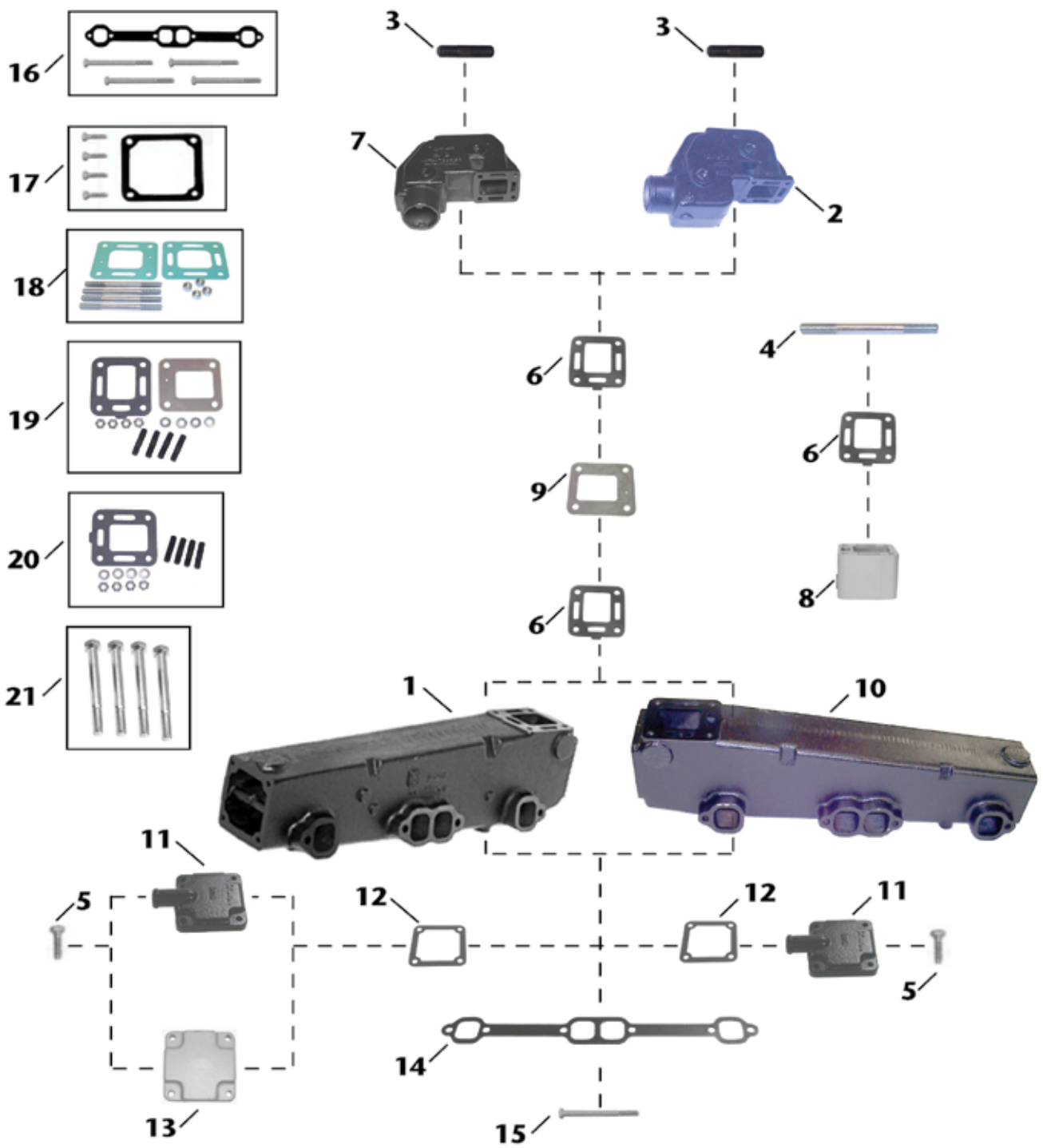

	Item No	Description	OE No.	Application	
	1	18-1951-1	MANIFOLD (STARBOARD)	774235A2	GM Small Block (V8) 305-350 cu.in. Models 198, 228, & 898. (Starboard)
	2	18-1978	MANIFOLD ELBOW	76771A3	Use with Manifolds: 18-1950-1, 18-1951-1; Elbow Gasket 18-2833; Mounting Kit 18-4362.
	3	18-3233	MOUNTING STUD	16-49545	3/8-24, 3/8-16 X 1 3/4. Included in 18-4362 mounting kit.
	4	NSS	MOUNTING STUD	N/A	Included in 18-8554 mounting kit.
	5	NSS	MOUNTING BOLT	N/A	Included in 18-8512 mounting kit.
	6	18-2833	ELBOW GASKET	27-99777-2	Use with Elbows: 18-1971 & 18-1978. Included in 18-4362 mounting kit.
	7	18-1971	MANIFOLD ELBOW	76351A2	Use with Manifolds: 18-1950-1, 18-1951-1; Elbow Gasket 18-2833; Mounting Kit 18-4362.
	8	18-1906	MANIFOLD SPACER	61851	3" Spacer for Manifold: 18-1950-1, 18-1951-1. Use with mounting kit 18-8554 with 18-1971 or 18-1978 Elbows.
	9	18-4008	BLOCK OFF PLATE	60207	Use with Manifolds 18-1950-1, 18-1951-1. Requires (2) 18-2833 elbow gaskets
	10	18-1950-1	MANIFOLD (PORT)	77234A2	GM Small Block (V8) 305-350 cu.in. Models 198, 228, & 898. (Port)
	11	18-4009	END PLATE	60252A2	Use with (Port & Starboard) Manifolds: 18-1950-1 & 18-1951-1; Mounting Kit: 18-8512
	12	18-2832	FRONT/END PLATE GASKET	27-48043-1	Fits Port & Starboard Caps of Manifolds: 18-1950-1, 18-1951-1. Use with Front Plate: 18-4009. Included in 18-8512 mounting kit.
	13	NSS	END PLATE	54870	Fits Manifold: 18-1950-1, 18-1951-1; Mounting Kit: 18-8512.
	14	18-2949	MANIFOLD GASKET	96306	Use with Manifold: 18-1951-1
	15	NSS	MOUNTING BOLT	N/A	Included in 18-8520 mounting kit.
	16	18-8520	MOUNTING KIT	N/A	Use with Manifolds: 18-1950-1, 18-1951-1. Includes 18-2949 manifold gasket.
	17	18-8512	MOUNTING KIT	N/A	Use with Front/End Plates: 18-4009. Includes 18-2832 front end plate gasket
	18	18-8554	MOUNTING KIT	N/A	Use with Manifold Spacer: 18-1908 with Riser 18-1971 or 18-1978 Elbows. Included in 18-1908K. Includes (1) 18-2849 & 18-0897 elbow gaskets.
	19	18-8514	MOUNTING KIT	N/A	Use with Elbows: 18-1971 & 18-1978. Includes 18-2833 gasket & 18-4008 block off plate.
	20	18-4362	MOUNTING KIT	N/A	Use with Elbows: 18-1971 & 18-1978. Includes 18-2833 elbow gasket.
	21	18-8548	HARDWARE KIT	N/A	Includes only hardware for 18-1950-1 & 18-1951-1 manifolds. Included in 18-8520 mounting kit.

Fits Ford Small Block V8 302-351 cu. in. Models 215, 225, 233, 255 & 888

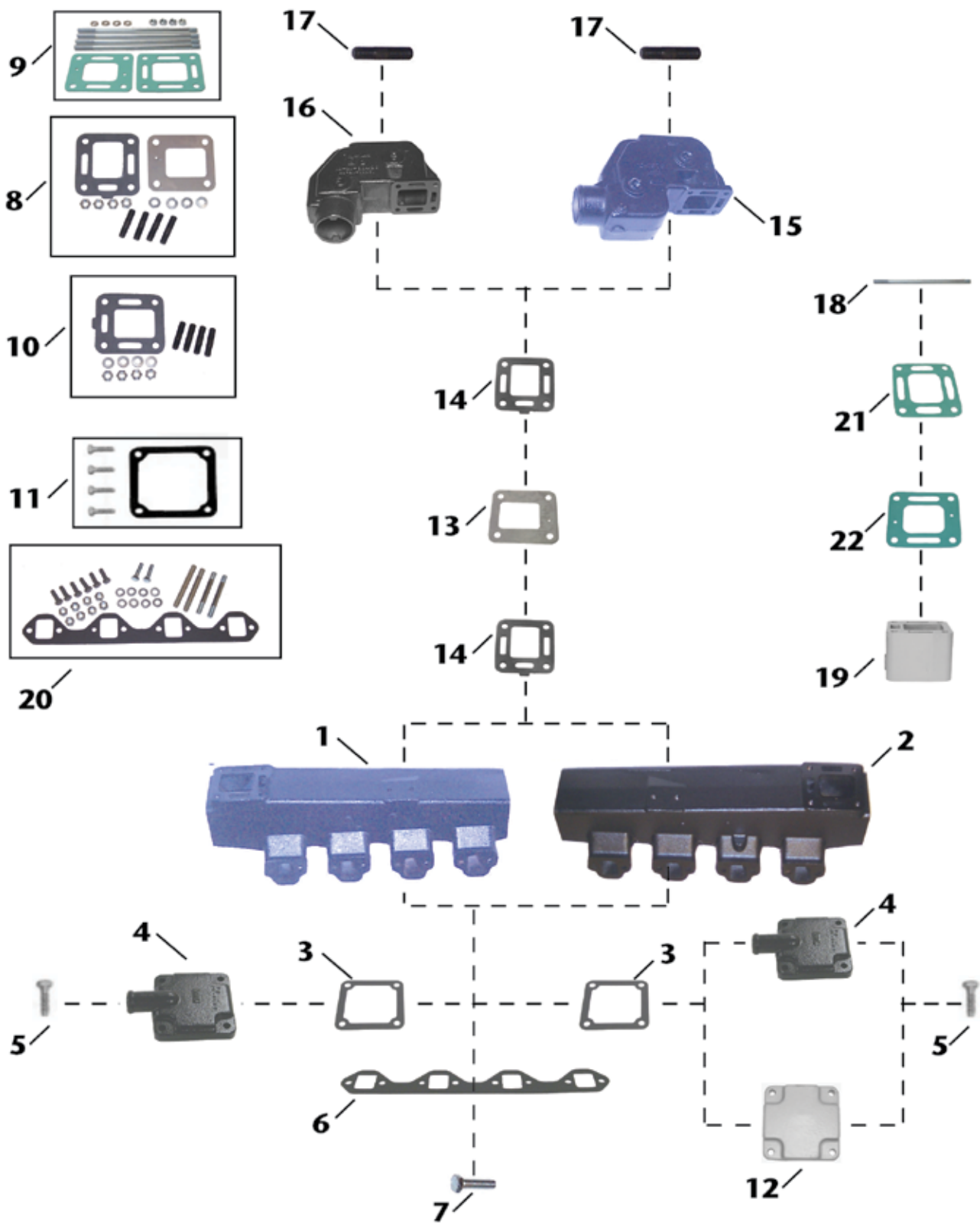

Item No	Description	OE No.	Application	
1	18-1958-1	MANIFOLD (PORT)	65604A4	Ford Small Block (V8) 302-351 cu.in. Models 215, 225, 233, 255, & 888 (Port). Use with Manifold Gasket: 18-0183; Mounting Kit: 18-8509.
2	18-1962-1	MANIFOLD (STARBOARD)	65603A4	Ford Small Block (V8) 302-351 cu.in. Models 215, 225, 233, 255, & 888 (Starboard). Use with Manifold Gasket: 18-0183; Mounting Kit: 18-8509.
3	18-2832	FRONT/END PLATE GASKET	27-48043-1	Fits Port & Starboard Caps of Manifolds: 18-1958-1, 18-1962-1. Use with Front Plate: 18-4009. Included in 18-8512 mounting kit.
4	18-4009	FRONT PLATE	60252A2	Use with (Port & Starboard) Manifolds: 18-1958-1, 18-1962-1; Mounting Kit: 18-8512
5	NSS	MOUNTING BOLT	N/A	Included in 18-8512 mounting kit.
6	18-0183	MANIFOLD GASKET	27-73866	Use with Manifold: 18-1958-1, 18-1962-1. Included in 18-8509 mounting kit.
7	NSS	MOUNTING BOLT	N/A	Included in 18-8509 mounting kit.
8	18-8514	MOUNTING KIT	N/A	Use with Elbows: 18-1971 & 18-1978. Includes 18-2833 gasket & 18-4008 block off plate.
9	18-8554	MOUNTING KIT	N/A	Use with Manifold Spacer: 18-1906 with Riser 18-1971 or 18-1978. Includes (1) 18-2849 & 18-0897 elbow gaskets.
10	18-4362	MOUNTING KIT	N/A	Use with Elbows: 18-1971 & 18-1978. Includes 18-2833 elbow gasket.
11	18-8512	MOUNTING KIT	N/A	Use with Front/End Plates: 18-4009. Includes 18-2832 gasket.
12	NSS	END PLATE	54870	Fits Manifolds: 18-1958-1, 18-1962-1; Mounting Kit: 18-8512.
13	18-4008	BLOCK OFF PLATE	60207	Use with Manifolds 18-1958-1, 18-1962-1. Requires (2) 18-2833 elbow gaskets
14	18-2833	ELBOW GASKET	27-99777-2	Use with Elbows: 18-1971 & 18-1978. Included in 18-4362 mounting kit.
15	18-1978	MANIFOLD ELBOW	76771A3	Use with Manifolds: 18-1958-1, 18-1962-1; Elbow Gasket 18-2833; Mounting Kit 18-4362.
16	18-1971	MANIFOLD ELBOW	76351A2	Use with Manifolds: 18-1958-1, 18-1962-1; Elbow Gasket 18-2833; Mounting Kit 18-4362.
17	18-3233	MOUNTING STUD	16-49545	3/8-24, 3/8-16 X 1 3/4. Included in 18-4362 mounting kit.
18	NSS	MOUNTING STUD	N/A	Included in 18-8554 mounting kit.
19	18-1906	MANIFOLD SPACER	61851	3" Spacer for Manifolds: 18-1950-1, 18-1951-1. Use with mounting kit 18-8554 with 18-1971 or 18-1978 Elbows.
20	18-8509	MOUNTING KIT	N/A	Use with Manifolds: 18-1958-1, 18-1962-1. Includes 18-0183 manifold gasket.
21	18-2849	ELBOW GASKET (OPEN)	27-818832	Fits Manifolds: 18-1958-1, 18-1962-1; Manifold Spacers: 18-1985. Included in 18-8554 mounting kit
22	18-0897	ELBOW GASKET (RESTRICTOR)	27-41813	Fits Manifolds: 18-1958-1, 18-1962-1; Manifold Spacers: 18-1985. Included in 18-8554 mounting kit

Fits GM 4 Cylinder 181 cu. in. Models 120, 140, 2.5L & 3.0L

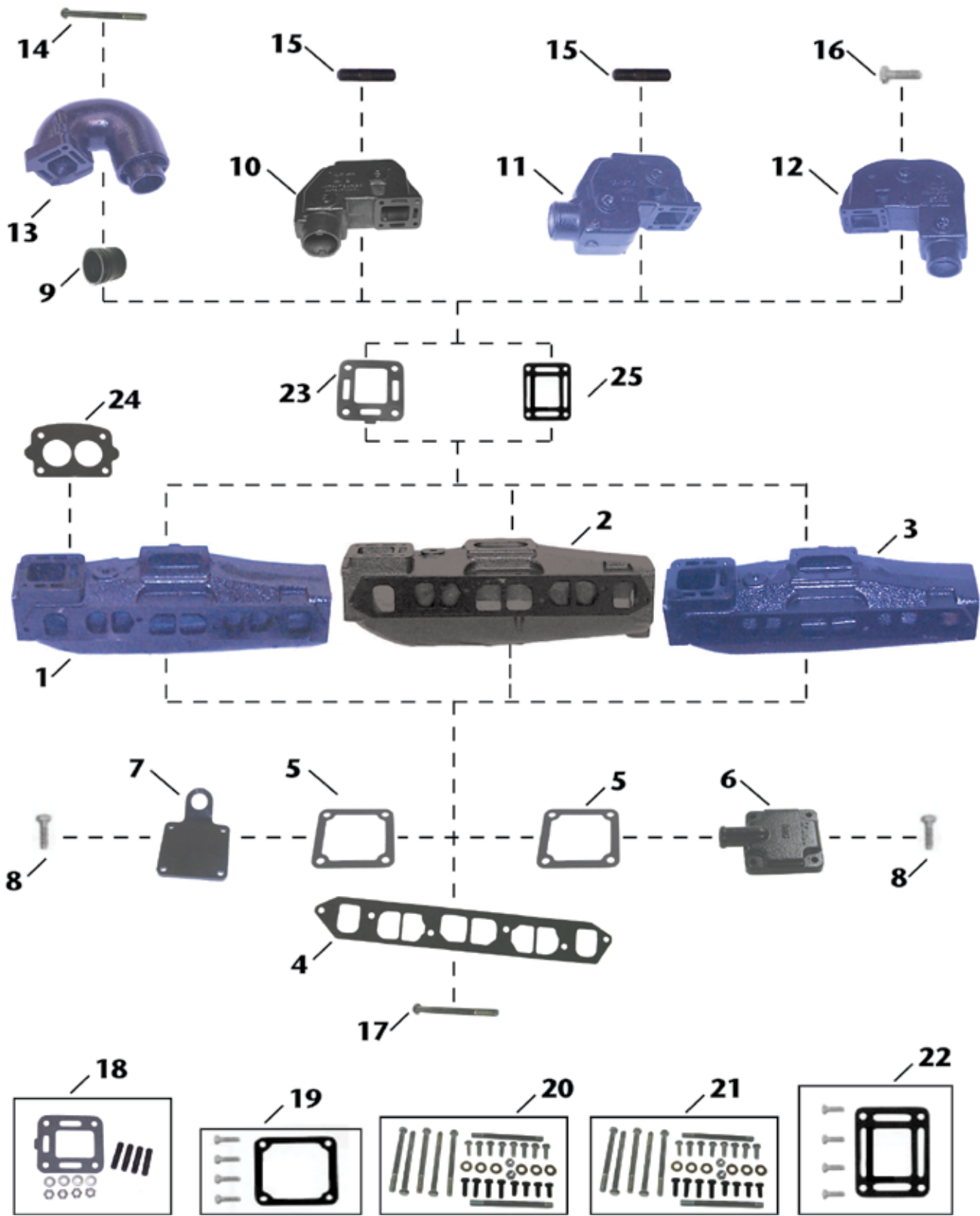

	Item No	Description	OE No.	Application
1	18-1954-1	MANIFOLD	9582A5	Fits 2.5 & 3.0L 181 CID, Model 140 with Rochester carburetor w/ electrical choke (1983-89). Use with Manifold Gasket: 18-1204.
2	18-1955-1	MANIFOLD	96705A1	Fits 3.0L 181 CID, Model 140 with Rochester carburetor w/ mechanical choke (1968-82). Use with Manifold Gasket: 18-1204. Mounting Hardware: 18-8549.
3	18-1956-1	MANIFOLD	99798A18	Fits 3.0L 181 CID, Model 140 & 3.0 with Mercarb carburetor w/ electrical choke (1983-95). Use with Manifold Gasket: 18-1204.
4	18-1204	MANIFOLD GASKET	27-96429	Fits Manifolds: 18-1954-1, 18-1955-1, 18-1956-1
5	18-2832	FRONT/ END CAP GASKET	27-48043-1	Fits Port & Starboard Caps of Manifolds: 18-1954-1, 18-1955-1, 18-1956-1.
6	18-4009	FRONT PLATE	60252A2	Fits Manifolds: 18-1954-1, 18-1955-1, 18-1956-1
7	18-5021	END PLATE	805629	Fits Manifolds: 18-1954-1, 18-1955-1, 18-1956-1
8	NSS	MOUNTING BOLT	N/A	Included in 18-8512 mounting kit.
9	18-2748	EXHAUST BOOT	32-44348T	4" Inside Diameter. Use with 18-1975-1 elbow.
10	18-1971	MANIFOLD ELBOW	76351A2	Use with Manifolds: 18-1954-1, 18-1955-1, 18-1956-1; Elbow Gasket 18-2833; Mounting Kit 18-4362
11	18-1978	MANIFOLD ELBOW	76771A3	Use with Manifolds: 18-1954-1, 18-1955-1, 18-1956-1; Elbow Gasket 18-2833; Mounting Kit 18-4362
12	18-1973	MANIFOLD ELBOW	55538A2	Use with Manifolds: 18-1954-1, 18-1955-1, 18-1956-1; Elbow Gasket 18-2833; Mounting Kit 18-8508
13	18-1975-1	MANIFOLD RISER	12076A2	Use with Manifolds: 18-1954-1, 18-1955-1, 18-1956-1; Elbow Gasket 18-2819; Mounting Hardware 18-8551; Exhaust Boot 18-2748.
14	NSS	MOUNTING BOLT	N/A	Included in 18-8551 mounting hardware.
15	18-3233	MOUNTING STUD	N/A	3/8-24, 3/8-16 X 1 3/4. Included in 18-4362 mounting kit.
16	NSS	MOUNTING BOLT	N/A	Included in 18-8508 mounting kit.
17	NSS	MOUNTING BOLT	N/A	Included in 18-8549 mounting kit.
18	18-4362	MOUNTING KIT	N/A	Use with Elbows: 18-1971 & 18-1978. Includes 18-2833 elbow gasket.
19	18-8512	MOUNTING KIT	N/A	Use with Front Plate: 18-4009 & End Plate (NSS). Includes 18-2832 front/end cap gasket.
20	18-8549	HARDWARE KIT	N/A	Includes only hardware for 18-1955-1 manifold.
21	18-8551	HARDWARE KIT	N/A	Includes only hardware for 18-1975-1 elbow.
22	18-8508	MOUNTING KIT	N/A	Use with Elbow 18-1973. Includes 18-2819 elbow gasket.
23	18-2833	ELBOW GASKET	27-99777-2	Use with Elbows: 18-1971 & 18-1978. Included in 18-4362 mounting kit.
24	18-0356	CARBURETOR GASKET	27-64692	Fits Manifolds: 18-1954-1, 18-1955-1, 18-1956-1
25	18-2819	ELBOW GASKET	27-39915	Use with Elbow: 18-1973. Included in 18-8508 mounting kit.

Fits GM Small Block V8 305 & 350 cu. in. Models 200, 228, 230, 260 & 898

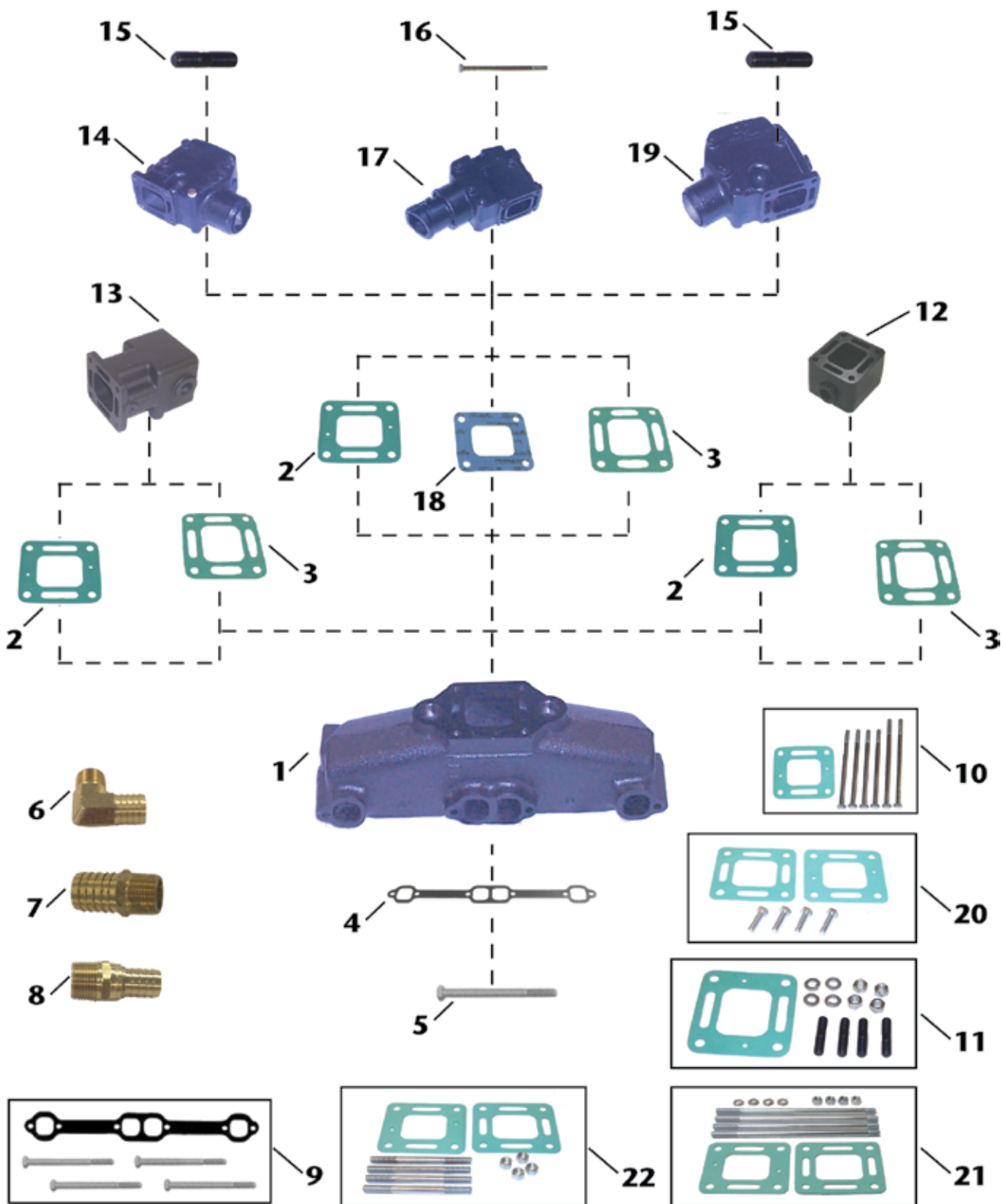

	Item No	Description	OE No.	Application
1	18-1953-2	MANIFOLD	87114A19	GM Small Block (V8) 305-350 cu.in. Models 200, 228, 230, 260, & 898
2	18-0897	ELBOW GASKET (RESTRICTOR)	27-41813	Fits Manifold: 18-1953-2; Manifold Spacers: 18-1985, & 18-1908; Elbows: 18-1970-1, 18-1976-1, 18-1974-1
3	18-2849	ELBOW GASKET (OPEN)	27-818832	Fits Manifold: 18-1953-2; Manifold Spacers: 18-1985, & 18-1908; Elbows: 18-1970-1, 18-1976-1, 18-1974-1
4	18-2949	MANIFOLD GASKET	96306	Use with Manifold: 18-1953-2. Included in 18-8520 mounting kit.
5	NSS	MOUNTING BOLT	N/A	Included in 18-8520 mounting kit.
6	18-8216	HOSE FITTING	N/A	3/4" - 14NPT X 1" Hose (Corrosion Resistant Brass Fitting)
7	18-4461	HOSE FITTING	N/A	3/4" - 14NPT X 1" Hose (Corrosion Resistant Brass Fitting)
8	18-8215	HOSE FITTING	N/A	3/4" - 14NPT X 3/4" Hose (Corrosion Resistant Brass Fitting)
9	18-8520	MOUNTING KIT	N/A	Use with Manifold: 18-1953-2. Includes 18-2949 manifold gasket.
10	18-8505	MOUNTING KIT	N/A	Use with Riser: 18-1976-1. Includes 18-0897 elbow gasket.
11	18-8529	MOUNTING KIT	N/A	Use with Risers: 18-1970-1, 18-1974-1. Includes 18-0897 elbow gaskets.
12	18-1908	MANIFOLD SPACER	933220A12	3" Spacer for Manifold: 18-1953-2. Use with mounting kit 18-8554 with 18-1970-1, or mounting kit 18-8555 with 18-1976-1.
13	18-1985	MANIFOLD SPACER	93322	6" Spacer for Manifold: 18-1953-2. Use with mounting kit 18-8556. (Note to mount elbows to spacer a separate mounting kit is required)
14	18-1974-1	MANIFOLD ELBOW	98502A2	Fits Manifold: 18-1953-2. Use Elbow gasket: 18-2849, 18-0897, or 18-0672; Use mounting kit: 18-8529. (Do not use with spacer)
15	NSS	MOUNTING STUD	N/A	Included in 18-8529 mounting kit.
16	NSS	MOUNTING BOLT	N/A	Included in 18-8505 mounting kit.
17	18-1976-1	MANIFOLD ELBOW	44354A3, 807914A1	Fits Manifold: 18-1953-2. Use Elbow gasket: 18-2849, 18-0897, or 18-0672; Use mounting kit: 18-8505, or if spacer is included use 18-8555.
18	18-0672	ELBOW GASKET (CLOSED)	27-860231	Fits Manifold: 18-1953-2; Manifold Spacers: 18-1985, & 18-1908; Elbows: 18-1970-1, 18-1976-1, 18-1974-1
19	18-1970-1	MANIFOLD ELBOW	98504A3	Fits Manifold: 18-1953-2. Use Elbow gasket: 18-2849, 18-0897, or 18-0672; Use mounting kit: 18-8529, or if spacer is included use 18-8554.
20	18-8556	MOUNTING KIT	N/A	Use with Manifold Spacer: 18-1985. Includes 18-0897 & 18-2849. (Note: To mount elbows to spacer a separate mounting kit is required.)
21	18-8555	MOUNTING KIT	N/A	Use with Riser Kit 18-1908K: Spacer 18-1908: Riser 18-1976-1: Manifold: 18-1952-1
22	18-8554	MOUNTING KIT	N/A	Use with Riser Kit 18-1908K: Spacer 18-1908: Riser 18-1970-1: Manifold: 18-1952-1

SIERRA MANIFOLDS ARE PAINTED, PACKAGED AND LEAK TESTED

**18-1998-1
MANIFOLD**

Port & Starboard
Replaces: Barr FM-1-83
Universal Center Riser Manifold
FITS: Ford 302 and 351 CID engines
Comes with 18-4363 Mounting Package
Use with:
Exhaust Manifold Gasket Set: 18-0603
***For Exploded View - See Pages 560-561**



**18-1997-1
MANIFOLD**

Port & Starboard
Replaces: Barr CHV-1-83 Universal Center Riser Manifold
FITS: GM 283, 305, 307 and 350 CID engines
Use with:
Exhaust Manifold Gasket Set: 18-0604
***For Exploded View - See Pages 558-559**

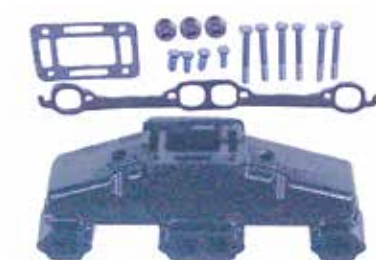

**18-1898
MANIFOLD**

Port & Starboard
Replaces: Barr CHVA-1-84, Marine Power
0991-110
Fits 454 cu. in. GM big block V8 engines
Use with:
Exhaust Manifold Gasket: 18-0418
Riser: 18-1939, 18-1999
***For Exploded View - See Pages 556-557**



**18-1951-1*
MANIFOLD**

Supplied with Mounting Package
Replaces: 77235A2, 77235A8
STARBOARD SIDE
Fits most Mercruiser (GM) small blocks with end riser
Use with:
Exhaust Manifold Gasket: 18-2949
Mounting Kit: 18-8548



**18-1950-1*
MANIFOLD**

Supplied with Mounting Package
Replaces: 77234A2
PORT SIDE
Fits most Mercruiser (GM) small blocks with end riser
Use with:
Exhaust Manifold Gasket: 18-2949
Mounting Kit: 18-8548



**18-1952-1*
MANIFOLD**

Port & Starboard
Replaces: 99746A8, A17
Fits most 4.3L (262 CID) V-6 application
Supplied with Mounting Package
Use with:
Mounting Kit: 18-8533



**18-1953-2
MANIFOLD**

Port & Starboard
Supplied with Mounting Package
Replaces: 87114A19,86024A10
Will fit either side - Fits most Mercruiser(GM) small blocks with center riser.
Supplied with gaskets
Use with:
Mounting Kit: 18-8520



**18-1954-1*
MANIFOLD**

Supplied with Mounting Package
Replaces: 95862A5
Fits most late Model 2.5L 153 CID & 3.0L 181 CID with Rochester Carb
5 BOLT PATTERN (1983-89)
Use with:
Exhaust Manifold Gasket: 18-1204
End Plate: 18-4009



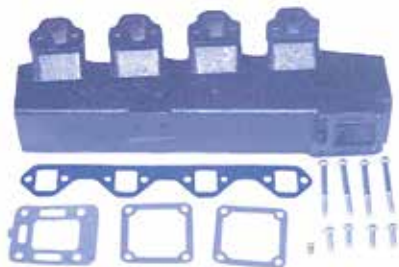

18-1958-1-1*
MANIFOLD
 Replaces: 65604A4, A12 PORT SIDE ONLY
 Fits most Mercuriser (Ford) V-8 small blocks
 Supplied with Mounting Package
 Use with:
 Mounting Kit: 18-8509



18-1955-1*
MANIFOLD
New Style
 Supplied with Mounting Package
 Replaces: 96705A1
 Fits most early Model 3.0L 181 CID with Rochester
 Carb. 5 bolt pattern and 2.5L, 153CID (1968-82)
 Use with:
 Exhaust Manifold Gasket: 18-1203
 End Plate: 18-4009



18-1956-1*
MANIFOLD
 Supplied with Mounting Package
 Replaces: 99798A18, 806867A8
 Fits most late Model 2.5L 153 CID and 3.0L 181 CID
 with MerCarb 5 bolt pattern with electric choke (1983-95)
 Use with:
 Exhaust Manifold Gasket: 18-1204
 End Plate: 18-4009



18-1957-1*
MANIFOLD
 Port & Starboard
 Replaces: 89011A8, 807078A6
 WILL FIT EITHER SIDE
 Fits most Mercuriser (GM) V-8 big blocks with center riser
 Use with:
 Exhaust Manifold Gasket: 18-0418
 Mounting Kit: 18-8532

18-1987-1
MANIFOLD
CONVERSION KIT
 Not for use on engines with high mounted
 power steering pumps

KIT INCLUDES:
 2 Center rise manifolds
 2 Exhaust elbows
 1 Thermostat housing
 1 Thermostat cover
 1 Thermostat
 All hoses, hardware, gaskets plus complete
 instructions to do the job right!



This Manifold Kit is designed to convert all Mercuriser Stern Drive Engines with GM 305 & 350 CID Blocks that have Log Style Exhaust Manifolds and Raw Water Cooling to the Newer More Efficient Center Rise Manifolds



18-1960-1*
MANIFOLD
 Replaces: 58759A10, A14
 Fits most Mercuriser (GM) Inline 6 Cyl. Engines
 Supplied with Mounting Package
 Use with:
 Mounting Kit: 18-8531



18-1962-1-1*
MANIFOLD
 Starboard
 Replaces: 65603A4, 65603A12
 Fits most Mercuriser Engines (Ford) V-8 Small blocks
 Supplied with Mounting Package
 Use with:
 Mounting Kit: 18-8509



**18-1999
ELBOW**
Replaces: Barr 20-0082
Comes with 18-4364 open Mounting Package -
Use with:
Manifold: 18-1997-1 or 18-1998-1
or 18-1898
Riser Gasket: 18-2854 open or
18-0476 blocked
Mounting Kit: 18-4364 open or
18-8535 blocked



**18-1970-1*
ELBOW**
Replaces: 98504A3
Fits V-6 & V-8 applications, 15° (3" O.D. Riser) Comes
with 18-0897 & brass plugs
Use with:
Manifold: 18-1952-1, 18-1953-2, 18-1957-1
Elbow Gasket: 18-0897 restrictor, 18-2849
open, 18-0672 blocked
Mounting Kit: 18-8529



**18-1971*
ELBOW**
Replaces: 76351A2
Fits most early model Mercruiser 140 HP (4 cyl)
applications
Replaces: Barr MC20-60426P
Use with:
Manifold: 18-1960-1, 18-1958-1, 18-1950-1
Elbow Gasket: 18-2833
Mounting Kit: 18-4362



**18-1992-1
EXHAUST ADAPTER**
For 3" I.D. Exhaust Hose
(As used in 18-1987 Exhaust Manifold Conversion Kit)
80°



**18-1972*
ELBOW**
Replaces: 76325A2
Fits most late Model 120, 140 HP Mercruiser applications
Use with:
Manifold: 18-1955-1, 18-1954-1,
18-1956-1, 18-1901
Elbow Gasket: 18-2833
Mounting Kit: 18-8552



**18-1973*
ELBOW**
Replaces: 55538A2
Fits most early Model 120 HP Mercruiser applications



**18-1991
ELBOW ADAPTER**
For use with 3" I.D. Exhaust Hose
Use with:
Manifold Riser: 18-1999
30°



**18-1978
ELBOW**
Replaces: 76771A3, A2
V-8 Inboard Applications Only
Use with:
Manifold: 18-1950-1, 18-1951-1,
18-1958-1, 18-1962-1
Elbow Gasket: 18-2833
Mounting Kit: 18-4362



**18-1905
ELBOW**
Replaces: 90880
Mercruiser 4 Cylinder 224cu. in. 3.7L
(Models: 165, 170, 180, 190).
Use with:
Manifold: Mercruiser 99908
Exhaust Elbow Mounting Gasket: 18-0113
Mounting Kit: 18-8500



**18-1937
ELBOW**
Replaces: 98562A6
Mercruiser 4 Cylinder 224cu. in. 3.7L (Models: 165, 170, 180, 190).
Use with:
Exhaust Elbow Mounting Gasket: 18-0881
Mounting Kit: 18-8530



**18-1974-1*
ELBOW**
Replaces: 98502A2
Fits V-6 & V-8 applications 0° (3" O.D. Riser)
Comes with 18-0897 gasket & brass plugs

* SEE APPLICATION CHART ON PAGE 671-675 FOR SPECIFIC MODELS



**18-1975-1-1*
RISER**

Replaces: 12076A2
Fits late Model Mercruiser 4 cyl. Engines
Use with:
Manifold: 18-1955-1, 18-1954-1, 18-1956-1, 18-1901
Riser Gasket: 18-2833
Mounting Kit: 18-8551
Bellow: 18-2748



**18-1976-1*
ELBOW**

Replaces: 44354A3, 807914A1
Fits most Mercruiser V-6 & V-8 applications 7" (4" O.D. Riser) Comes with 18-0897, 18-4263 & 18-4258
Use with:
Manifold: 18-1952-1, 18-1953-2, 18-1957-1
Riser Gasket: 18-0897 restrictor, 18-2849 open, 18-0672 blocked
Mounting Kit: 18-8505



**18-1939
RISER**

Replaces: Barr 20-0100, Marine Power 0992-593 Barr, Indmar and Marine Power Ford Small Block V8 302-351cu. in. GM Small Block V8 305-350cu. in., GM Big Block V8 454cu in.
Use with:
Manifold: 18-1997-1, 18-1998-1, 18-1898
Riser Gasket: 18-2854 open or 18-0476 blocked
Mounting Kit: 18-4364 open or 18-8535 blocked



**18-1907
RISER**

Replaces: Barr 20-0102, Indmar 53-2009 and 53-2018 Barr, Indmar Ford Small Block V8 302-351cu. in.
Use with:
Manifold: 18-1997-1, 18-1998-1
Riser Gasket: 18-2854 open or 18-0476 blocked
Mounting Kit: 18-4364 open or 18-8535 blocked



**18-1908K
MANIFOLD RISER SPACER KIT**

Replaces: 807476A6, 93320A5
Alpha/Bravo/Gen+/GenIV GM Small Block V-8 305, 350, 4.3L, 454, 5.0, 5.7L, 502, 7.4L, 8.2L, (3" Riser Kit)
Complete with Mounting Hardware. Center Rise 3" PACKAGED AS SET
Use with:
Manifold: 18-1952-1
3"



**18-1906
MANIFOLD SPACER**

Replaces: 61851A1
3" Spacer for 18-1950, 18-1951, 18-1958-1 & 18-1962-1 manifolds



**18-1908
MANIFOLD RISER SPACER - 3"**

Mercruiser GM V6 229 and 262cu.in. (Models: 185 and 205), GM Small Block V8 305-350cu.in. (Models: 200, 228, 230, 260 and 898), GM Big Block V8 454cu.in. (Models: 330, 340 and 7.4L)
Used with:
Manifolds: 18-1952-1, 18-1953-2, 18-1957-1



**18-1985
MANIFOLD SPACER - 6"**

Replaces: 93322
For: 229 and 262 V6, 305-350 Small Block V8, 454 Big Block V8
Used with:
Manifold: 18-1952-1, 18-1957-1, 18-1953-2



**18-1949
MANIFOLD SPACER**

Barr, Indmar and Marine Power Ford Small Block V8 302-351cu.in., GM Small Block V8 305-350cu.in., GM Big Block V8 454cu.in.
Used with:
Manifold: 18-1998-1, 18-1997-1 and 18-1898



**18-1990
MANIFOLD BLOCK OFF PLATE**

Replaces: 73813A1



**18-5021
END PLATE**
Replaces: Mercuriser 805629
Use with:
Manifold: 18-1954-1,
18-1955-1, 18-1956-1



**18-1995
MANIFOLD END PLATE**
Replaces: 47638
GM 4 cyl. 153 cu. in. For model
110/120 where carb. linkage
mounts to the rear of the engine



**18-4008
BLOCK-OFF PLATE**
Replaces: 60207
Use with:
Riser: 18-1971, 18-1978



**18-4009
MANIFOLD END PLATE**
Replaces: 60252A2
Use with:
Manifold: 18-1960-1, 18-1958-1,
18-1950-1, 18-1951-1
End Plate Gasket: 18-2832
Mounting Kit: 18-8512



PIPE PLUGS

Part #	Replaces	Thread Size	Description
18-4257	—	1/4"	Blacksteel Plug
18-4263	22-32802, 22-328022	1/8" - 27 NPT	Pipe Plug
18-4264	22-32803	3/8" - 18 NPT	Pipe Plug
18-4265	22-428611	3/4" - 14 NPT	Pipe Plug
18-8111①	22-36392	1/4 - 18 NPT	Pipe Plug
18-4258	22-33198A1 22-41622	3/4 - 14 NPT	Pipe Plug

56507 Pipe Sealant with Teflon® is recommended for use on plug threads.



RISER BOLTS

Part #	Replaces	Thread Size	Description
18-8410	10-43749	3/8"-16 x 5 3/4"	Use Without Remote Oil Filter
18-8411	10-44387	3/8"-16 x 6 3/4"	Use With Remote Oil Filter



**18-4362
EXHAUST ELBOW MOUNTING KIT**
Replaces: Barr MC20-60426P
Use with:
Elbow: 18-1971



**18-4363
EXHAUST ELBOW MOUNTING KIT**
Replaces: Barr FM-1-83-P
Use with:
Manifold: 18-1998-1



**18-4364 (Open)
EXHAUST ELBOW MOUNTING KIT**
Replaces:
Barr 20-0082-P
Use with:
Riser: 18-1999, 18-1907, 18-1939



**18-8500
EXHAUST ELBOW MOUNTING KIT**
Mercuriser 4 Cylinder 224cu.in. 3.7L
(Models: 165, 170, 180, 190)
Used with:
Elbow/Reservoir: 18-1905



**18-8505
EXHAUST ELBOW MOUNTING KIT**
Mercuriser GM V6 229 and 262cu.in.
(Models 185 and 205), GM Small Block
V8 305-350cu.in. (Models: 200, 228, 230,
260, 898), GM Big Block V8 454cu.in.
(Models: 330, 340 and 7.4L)
Used with:
Riser: 18-1976-1



**18-8508
EXHAUST MANIFOLD MOUNTING KIT**
Mercuriser GM 4 Cylinder 153cu.in.
(Early models 110/120), GM Inline
Cylinder 250cu.in.(Model: 160)
Used with:
Riser: 18-1973

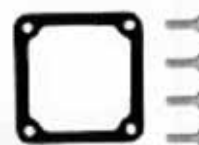

**18-8512
EXHAUST ELBOW
MOUNTING KIT**
Mercuriser GM 4 Cylinder 181cu.in. (Models:
120,140, 2.5L,3.0L), GM Inline 6 Cylinder
250-292cu.in. (Models: 165 and 200), Ford
Small Block V8 302-351cu.in. (Models:
215,225,233, 255,888), GM Small Block V8
305, 350cu.in.(Models: 198,228,898)
Used with:
Front Plate: 18-4009

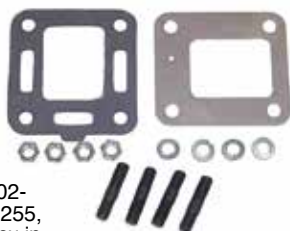

**18-8514
EXHAUST ELBOW
MOUNTING KIT**
Mercuriser Ford Small Block V8 302-
351cu.in. (Models: 215, 225, 233, 255,
888), GM Small Block V8 305-351cu.in.
(Models: 198,228,898)
Used with:
Riser: 18-1971 & 18-1978
(Not for Fresh Water/Closed Cooling
Systems)

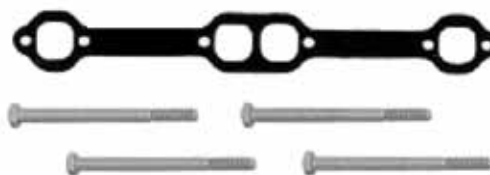

**18-8520
EXHAUST MANIFOLD MOUNTING KIT**
Mercuriser GM Small Block V8 305-350cu.
in. (Models: 198, 200, 228, 230, 260, 898)
Used with:
Manifold: 18-1950-1,18-1951-1, 18-1953-2

① This product is priced per piece. To order priced per package, please add -9 to the part number



**18-8529
EXHAUST ELBOW
MOUNTING KIT**
Mer cruiser GM V6 229 and 262cu.in.
(Models 185 and 205), GM Small
Block V8 305-350cu.in. (Models: 200,
228, 230, 260, 898), GM Big Block V8
454cu.in. (Models: 330, 340 and 7.4L)
Used with:
Riser: 18-1970-1



**18-8530
EXHAUST ELBOW MOUNTING KIT**
Mer cruiser 4 Cylinder 224cu.in. 3.7L
(Models: 165, 170, 180, 190)
Used with:
Elbow/Reservoir: 18-1937



**18-8531
EXHAUST MANIFOLD MOUNTING KIT**
Mer cruiser GM Inline 6 Cylinder 250cu.in.
(Models: 165 and 200)
Used with :
Manifold: 18-1960-1



**18-8532
EXHAUST MANIFOLD MOUNTING KIT**
Mer cruiser GM Big Block V8 454cu.in.
(Models: 330, 340 and 7.4L)
Used with:
Manifold: 18-1957-1



**18-8533
EXHAUST MANIFOLD MOUNTING KIT**
Mer cruiser GM V6 229 and 262cu.in.
(Models 185 and 205)
Used with:
Manifold: 18-1952-1



**18-8535 (Blocked)
EXHAUST ELBOW
MOUNTING KIT**
Barr, Indmar and Marine Power
Ford Small Block V8 302-351cu.in., GM
Small Block V8 305-350cu.in., GM Big Block
V8 454cu.in.
Used with:
Risers: 18-1939, 18-1999, and 18-1907



**18-8536
EXHAUST ELBOW MOUNTING KIT**
Barr, Indmar and Marine Power GM
Small Block V8 305-350cu.in.
Used with:
Manifold: 18-1997-1



**18-8538
EXHAUST MANIFOLD MOUNTING KIT**
Barr and Indmar Ford Small Block V8
302-351cu.in.
Used with:
Manifold: 18-1998-1



**18-8554
EXHAUST ELBOW MOUNTING KIT**
For: 229 and 262 ci V6, 305 and 350
SB V8, 454 Big Block V8.
Used with:
Riser Kit: 18-1908K and 18-1908 Spacer
Riser: 18-1970-1
Manifold: 18-1952-1



**18-8555
EXHAUST ELBOW MOUNTING KIT**
For: 229 and 262 ci V6, 305 and
350 SB V8, 454 Big Block V8.
Used with:
Riser Kit: 18-1908K and 18-1908 Spacer
Riser: 18-1976-1
Manifolds: 18-1952-1



**18-8556
EXHAUST ELBOW MOUNTING KIT**
For: 229 and 262 ci V6, 305 and 350
SB V8, 454 Big Block V8. Used to mount
Spacer 18-1985 to 18-1953-2,
18-1957-1 and 18-1952-1 Manifolds



HARDWARE KITS

Part #	Fits
18-8548	18-1950-1 & 18-1951-1 Manifold
18-8549	18-1955-1 Manifold
18-8551	18-1975-1 Exhaust Elbow















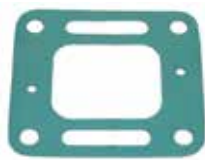
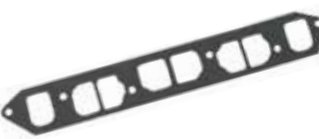

**18-0183
EXHAUST MANIFOLD GASKET**
Replaces: Mercruiser 27-73866
Volvo 3853742, 3852455, OMC 908717
Used with:
Manifold: 18-1962-1, 18-1938, 18-1998-1,
18-1996, 18-1979

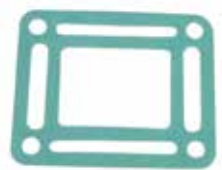

**18-0353
CARB MOUNTING GASKET**
Replaces: 27-58764
Used with:
Manifold: 18-1960-1

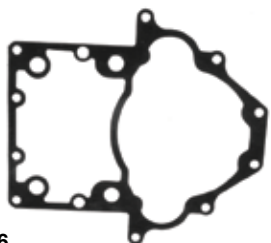

**18-0418
EXHAUST MANIFOLD GASKET**
Replaces: 27-46820
Use with :
Manifolds: 18-1957-1, 18-1982,
18-1929, 18-1933, 18-1898

 <p>18-0476 RISER BLOCK OFF GASKET Barr, Indmar & Marine Power Ford Small Block V8 302-351cu.in. Used with: Risers: 18-1939, 18-1999, 18-1907</p>	<p>PKG OF 2</p>  <p>18-0672 18-0672-9① EXHAUST ELBOW GASKET Replaces: 27-860231,8637251 Used with: Riser: 18-1970-1, 18-1976-1</p>	 <p>18-0872 EXHAUST MANIFOLD GASKET Replaces: Mercuriser 27-33395 GM 5.0L & 5.7L Use with: Manifold: 18-1950-1, 18-1951-1</p>	 <p>18-0881 EXHAUST ELBOW GASKET Replaces: 27-18272 Included in 18-8530 mounting kit Used with: Elbow: 18-1937</p>
<p>PKG. OF 2</p>  <p>18-0885 18-0885-9① EXHAUST ELBOW GASKET Replaces: 27-48042</p>	<p>PKG. OF 2</p>  <p>18-0897 (Restrictor) EXHAUST ELBOW GASKET Replaces: 27-41813 Used with: Riser: 18-1976-1, 18-1970-1</p>	<p>PKG. OF 2</p>  <p>18-1204 18-1204-9① EXHAUST MANIFOLD GASKET Replaces: 27-96429</p>	<p>PKG. OF 2</p>  <p>18-1210 18-1210-9① END CAP GASKET Replaces: 27-39923</p>
<p>PKG OF 2</p>  <p>18-2819 18-2819-9① EXHAUST ELBOW GASKET Replaces: 27-39915</p>	<p>PKG OF 2</p>  <p>18-2830 EXHAUST MANIFOLD GASKET 6 cyl. Replaces: 27-46401</p>	<p>PKG OF 2</p>  <p>18-2832 18-2832-9① MANIFOLD END CAP GASKET Replaces: 27-480431 Use with: Manifolds: 18-1951-1, 18-1950-1, 18-1954-1, 18-1958-1, 18-1955-1, 18-1956-1, 18-1960-1, 18-1962-1 End Plate: 18-4009</p>	
<p>PKG OF 2</p>  <p>18-2833 18-2833-9① EXHAUST ELBOW GASKET Replaces: 27-997772</p>	<p>PKG OF 2</p>  <p>18-2849 (Open) 18-2849-9① EXHAUST ELBOW GASKET Replaces: 27-87105-1, 27-818832, 27-863726 Use with: Elbow: 18-1976-1, 18-1970-1</p>	<p>PKG. OF 2</p>  <p>18-2854 (Open) 18-2854-9① EXHAUST ELBOW GASKET Replaces: Barr 01-0107 Use with : Riser: 18-1999, 18-1939, 18-1907</p>	
 <p>18-2896 EXHAUST MANIFOLD GASKET Replaces: 27-52546 GM 4 cyl. 153 cu. in. For model 110/120 where carb. linkage mounts to the rear of the engine</p>	<p>PKG. OF 2</p>  <p>18-2909 18-2909-9① EXHAUST MANIFOLD GASKET For: GM V-6 Used with: Manifold: 18-1952-1</p>	 <p>18-2912 EXHAUST MANIFOLD GASKET Replaces: 27-53354</p>	

① Priced per Package

PKG. OF 2



18-2949
18-2949-9②
EXHAUST MANIFOLD GASKET
Replaces: Barr CHV-47-000
Use with:
Manifold: 18-1997-1



18-0603
EXHAUST MANIFOLD GASKET SET
For: Ford 302/351 CID Engines
For use with **18-1998-1**

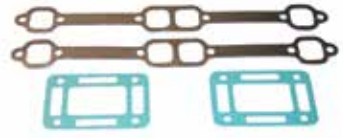

18-0604
EXHAUST MANIFOLD GASKET SET
For: GM 305/350 CID Engines
For use with **18-1997-1**



①**18-4218D** Display Package

18-4218
DRAIN TAP
Replaces: 22-87238, 22-16951A1, 22-16951T1, Q1 1/4" NPT
18-3223-9②
Bulk pack of 12



①**18-4224D** Display Package

18-4224
DRAIN ELBOW ASSEMBLY
Replaces: 22-806926A1



18-4226
DRAIN PLUG
Replaces: 22-806608A1



18-4227
DRAIN ELBOW
Replaces: 22-806926



18-4461
HOSE BARB
Replaces: 22-807155
3/4" - 14 NPT x 1" Hose
Corrosion Resistant Brass Fitting



18-8216
HOSE BARB
Replaces: 22-36305
Fits: Mercruiser- V6 (229 and 262ci), Small Block V8 (305-350ci), Big Block V8 (454ci)

① Items ending in "D" are Display Packaged - Regular number is Non-Display
② Priced per Package

MANIFOLD/MANIFOLD GASKET APPLICATION

Liter	Model	Note	CID	# Cyl	Stroke	Year Range	Serial Number Range	Exh Manifold Port	Exh Manifold Starboard	Exh Elbow	End Cap Front	End Cap Rear	Manifold Gasket	Exh Elbow Gasket
2.5L	120		153	4	4	1966-1982	2046625 - 6229717						27-52546	18-2819
2.5L	120		153	4	4		2324347 - 3377340					18-1995	18-2896	18-2819
2.5L	120		153	4	4		3377341 - 5192408					18-1995	18-2896	18-2819
2.5L	120		153	4	4		5192049 - 6229717					18-1995	18-2896	18-2819
2.5	120		153	4	4	1983-1986	6229718 - B5311853				18-4009		18-1204	18-2833
2.5L	2.5L		153	4	4	1987-1989	B531854 - C853255	18-1956-1			18-4009	18-4009	18-1204	18-2833
3.0L	140		181	4	4	1968-1982	2508261 - 6229717	18-1955-1		18-1971	18-4009	18-1990	18-2912	18-2833
3.0L	140		181	4	4		3332138 - 5157668	18-1955-1				18-4009	18-1203	18-2833
3.0L	140		181	4	4		5157669 - 6229717	18-1955-1				18-4009	18-1203	18-2833
3.0L	140		181	4	4	1983-1986	6229718 - B450800			18-1975-1	18-4009		18-1204	18-2833
3.0L	3.0L		181	4	4	1990-1994	C856559 & UP	18-1956-1		18-1975-1	18-4009		18-1204	18-2833
3.0L	3.0L		181	4	4	1987-1989	B450801 - C856558			18-1975-1	18-4009		18-1204	18-2833
3.0L	3.0L		181	4	4	1998-2003	L010042 - M679999	18-1956-1		18-1975-1	18-1990		18-1204	18-2833
3.0L	3.0L		181	4	4	2003-2010	M680000 & UP	18-1956-1		18-1975-1			18-0680	18-2833
3.0L	3.0LX		181	4	4	1990-1997	C856559 - K999999	18-1956-1		18-1975-1	18-1990		18-0680	18-2833
3.0L	3.0L MPI / 3.0L EC		181	4	4	2008-2010	A072812 & UP						18-0680	
	150			4	4		1666495 - 2048046						18-2830	
	160			4	4		2048022 - 2770031						18-2830	
3.7L	165		224	4	4	1987	B434941 - B774251		ⓐ	18-1937			18-0956	18-0881
3.7L	165		224	4	4	1987	B434941 - B774251		ⓑ				18-0956	
3.7L	165		224	4	4		2770032 & up	18-1960-1				18-4009	18-2830	18-2833
3.7L	170		224	4	4	1985-1986	6916779 - B434940		ⓐ	18-1937			18-0956	18-0881
3.7L	170		224	4	4	1985-1986	6916779 - B434940		ⓑ				18-0956	18-0113
3.7L	180		224	4	4	1987	B436391 - B775248		ⓐ	18-1937			18-0956	18-0881
3.7L	180		224	4	4	1987	B436391 - B775248		ⓑ				18-0956	18-0113
3.7L	190		224	4	4	1985-1986	6916779 - B436390		ⓐ	18-1937			18-0956	18-0881
3.7L	190		224	4	4	1985-1986	6916779 - B436390		ⓑ				18-0956	18-0113
3.7L	3.7L		224	4	4	1988-1989	B774252 & UP		ⓐ	18-1937			18-0956	18-0881
3.7L	3.7L		224	4	4	1988-1989	B774252 & UP		ⓑ				18-0956	
3.7L	3.7LX		224	4	4	1988-1989	B775249 & UP		ⓐ	18-1937			18-0956	18-0881
3.7L	3.7LX		224	4	4	1988-1989	B775249 & UP		ⓑ				18-0956	18-0113
	470		224	4	4	1976-1977	4208730 - 4625579						18-0956	18-2833
	470 MCM / 470 MIE		224	4	4	1977-1982	4625580 - 6218036						18-0956	18-2833
	470		224	4	4	1983-1984	6218037 - 6916778						18-0956	18-0113
	485		224	4	4	1980-1982	5685394 - 6218036						18-0956	
	488		224	4	4	1983-1984	6170297 - 6916778						18-0956	18-0113
	140		194	6	4	1963	1538930 - 1725960						18-2830	
	150		230	6	4	1964-1966	1666495 - 2048046						18-2830	
	160		250	6	4	1967-1969	2048022 - 2770031						18-2830	
	165		250	6	4	1970-1981	2770032 - 5813433	18-1960-1		18-1971	18-4009	18-1990	18-2830	18-2833
	200		292	6	4	1969	2453769 - 2712072	18-1960-1		18-1971		18-1990	18-2830	18-2833
	185	4bb1	229	6	4	1983-1984	6330183 - 6919655	18-1952-1		18-1970-1			18-2909	18-0897
	175		262	6	4	1987	B527955 - B773242	18-1952-1		18-1952-1			18-2909	18-0897

ⓐ For engines with aluminum exhaust manifolds
 ⓑ For engines with cast iron exhaust manifolds
 ⓐ 3" (76mm) O.D. & 0 degree down angle
 ⓑ 3" (76mm) O.D. & 15 degree down angle
 ⓐ 4" (102mm) O.D.
 ⓐ 2 piece exhaust manifold
 ⓑ 1 piece exhaust manifold
 ⓐ Has a rectangular elbow mounting bolt pattern
 ⓑ Has a square elbow mounting bolt pattern

ⓐ In-line applications
 ⓑ V-drive applications
 ⓐ Standard rise
 ⓑ 2" (51mm) rise
 ⓐ 3" (76mm) rise
 ⓑ 6" (152mm) rise
 ⓐ Port
 ⓑ Starboard
 ⓐ Engines with risers or closed cooling may require a different gasket than listed

ⓐ Exhaust manifold with external water rail
 ⓑ Exhaust manifold w/o external water rail
 ⓐ 1 piece exhaust manifold is n/a. Engine must be converted to the 2 piece exhaust system
 ⓐ Engines with easy drain system
 ⓑ Engines with multi-point drain system
 ⓐ Intermediate collector housing

MANIFOLD/MANIFOLD GASKET APPLICATION (Cont.)

Liter	Model	Note	CID	# Cyl	Stroke	Year Range	Serial Number Range	Exh Manifold Port	Exh Manifold Starboard	Exh Elbow	End Cap Front	End Cap Rear	Manifold Gasket	Exh Elbow Gasket
	185	2bbl	262	6	4	1985-1986	A331455 - B527954	18-1952-1	18-1952-1	18-1970-1			18-2909	18-0897
	185	2bbl	262	6	4	1985-1986	A331455 - B527954	18-1952-1	18-1952-1	18-1976-1			18-2909	18-0897
	205		262	6	4	1985-1986	A331455 - B527954	18-1952-1	18-1952-1	18-1970-1			18-2909	18-0897
	205		262	6	4	1985-1986	A331455 - B527954	18-1952-1	18-1952-1	18-1976-1			18-2909	18-0897
	205		262	6	4	1987	B527955 - B775129	18-1952-1	18-1952-1	18-1976-1			18-2909	18-0897
4.3L	262 MAG EFI GEN +		262	6	4	1996-1997	F803800 - K999999	18-1952-1	18-1952-1	18-1976-1			18-2909	18-0897
4.3L	262 MAG EFI GEN +		262	6	4	1996-1997	F803800 - K999999						18-2909	
4.3L	4.3L		262	6	4	1988-1996	B773243 - F802999	18-1952-1	18-1952-1	18-1976-1			18-2909	18-0897
4.3L	4.3L GEN +		262	6	4	1998-2002	L010044 - M614999	18-1952-1	18-1952-1	18-1976-1			18-2909	18-2849
4.3L	4.3L GEN +		262	6	4	1998-2002	L010044 - M614999						18-2909	
4.3L	4.3L GEN +		262	6	4	2002-2004	M615000 - W309999						18-2909	
4.3L	4.3L GEN +		262	6	4	2004-2010	W310000 & UP						18-2909	
4.3L	4.3L EFI GEN +		262	6	4	1998-2002	L012009 - M322780	18-1952-1	18-1952-1	18-1976-1			18-2909	18-2849
4.3L	4.3L EFI GEN +		262	6	4	1998-2002	L01009 - M322780						18-2909	
4.3L	4.3L MPI		262	6	4	2002	M300000 - M614999	18-1952-1	18-1952-1	18-1976-1			18-2909	18-0897
4.3L	4.3L MPI		262	6	4	2002	M300000 - M614999	18-1952-1	18-1952-1	18-1976-1			18-2909	18-2849
4.3L	4.3L MPI		262	6	4	2002-2004	M615000 - W309999						18-2909	
4.3L	4.3L MPI		262	6	4	2004-2010	W310000 & UP						18-2909	
4.3L	4.3L MPI / 4.3L EC		262	6	4	2010-2011	A637496 & UP						18-2909	
4.3L	4.3L MPI / 4.3L EC		262	6	4	2010-2011	A637496 & UP						18-2909	
4.3L	4.3LH GEN +		262	6	4	1998-2002	L010044 - M614999	18-1952-1	18-1952-1	18-1976-1			18-2909	18-2849
4.3L	4.3LH GEN +		262	6	4	1998-2002	L010044 - M614999						18-2909	
4.3L	4.3LH	4 bbl	262	6	4	1988-1996	B775130 - F802999	18-1952-1	18-1952-1	18-1976-1			18-2909	18-0897
4.3L	4.3LH GEN +	2bbl	262	6	4	1996-1997	F803800 - K999999	18-1952-1	18-1952-1	18-1976-1			18-2909	18-0897
4.3L	4.3LH GEN +	2bbl	262	6	4	1996-1997	F803800 - K999999						18-2909	
4.3L	4.3LXH GEN +		262	6	4	1996-1997	F803814 - K999999	18-1952-1	18-1952-1	18-1976-1			18-2909	18-0897
4.3L	4.3LXH GEN +		262	6	4	1996-1997	F803814 - K999999						18-2909	
5.0L	215		302	8	4	1970	2781153 - 3040410	18-1958-1	18-1962-1	18-1971	18-4009	18-1990	18-0183	18-2833
5.0L	215		302	8	4	1971-1972	3040411 - 3385720	18-1958-1	18-1962-1	18-1971	18-4009	18-4009	18-0183	18-2833
5.0L	215 MIE		302	8	4	1970	2781153 - 3040410	18-1958-1	18-1962-1		18-4009	18-1990	18-0183	18-2833
5.0L	215 MIE		302	8	4	1971-1972	3040411 - 3563181	18-1958-1	18-1962-1		18-4009	18-4009	18-0183	18-2833
5.0L	225		302	8	4	1973-1974	3385721 - 4166999	18-1958-1	18-1962-1	18-1971	18-4009	18-4009	18-0183	18-2833
5.0L	225 MIE	FORD	302	8	4	1973-1974	3385721 - 4176999	18-1958-1	18-1962-1		18-4009	18-4009	18-0183	18-2833
5.0L	888		302	8	4	1971-1977	3108723 - 4867829	18-1958-1	18-1962-1	18-1971	18-4009	18-4009	18-0183	18-2833
5.0L	190		283	8	4	1963-1964	1564539 - 1730903						18-0872	
5.0L	198 MIE		305	8	4	1977	4776402 - 4931099				18-4009	18-4009	18-0872	18-0885
5.0L	198 MIE		305	8	4	1977	4776402 - 4931099	18-1950-1	18-1951-1		18-4009	18-4009	18-0872	18-2833
5.0L	200		305	8	4	1985-1987	6899058 - B525981	18-1953-2	18-1953-2	18-1970-1			18-0872	18-0897
5.0L	200		305	8	4	1985-1987	6899058 - B525981	18-1953-2	18-1953-2	18-1976-1			18-0872	18-0897
5.0L	200		305	8	4	1987	B525982 - B774444	18-1953-2	18-1953-2	18-1976-1			18-0872	18-0897
5.0L	228		305	8	4	1977	4765100 - 4888929				18-4009	18-4009	18-0872	18-0885
5.0L	228		305	8	4	1977-1982	4888930 - 6218461	18-1950-1	18-1951-1	18-1971	18-4009	18-4009	18-0872	18-2833
5.0L	228		305	8	4	1983-1984	6218462 - 6899268	18-1953-2	18-1953-2	18-1970-1			18-0872	18-0897
5.0L	228		305	8	4	1983-1984	6218462 - 6899268	18-1953-2	18-1953-2	18-1976-1			18-0872	18-0897
5.0L	228 TR		305	8	4	1977-1978	4888930 - 5170008	18-1950-1	18-1951-1	18-1971	18-4009	18-4009	18-0872	18-2833
5.0L	228 TR		305	8	4	1977-1978	4888930 - 5170008	18-1950-1	18-1951-1	18-1971	18-4009	18-4009	18-0872	18-2833
5.0L	228 MIE		305	8	4	1977	4765100 - 4888929				18-4009	18-4009	18-0872	18-0885
5.0L	228 MIE		305	8	4	1977-1980	4888930 - 5907057	18-1950-1	18-1951-1		18-4009	18-4009	18-0872	18-2833
5.0L	230		305	8	4	1985-1987	6899269 - B525981	18-1953-2	18-1953-2	18-1970-1			18-0872	18-0897
5.0L	230		305	8	4	1985-1987	6899269 - B525981	18-1953-2	18-1953-2	18-1976-1			18-0872	18-0897
5.0L	230		305	8	4	1987	B525982 - B773739	18-1953-2	18-1953-2	18-1976-1			18-0872	18-0897
5.0L	230 MIE		305	8	4	1981-1987	5907058 - B788151	18-1953-2	18-1953-2	18-1974-1			18-0872	18-0897
5.0L	230 MIE		305	8	4	1981-1987	5907058 - B788151	18-1953-2	18-1953-2	18-1970-1			18-0872	18-0897
5.0L	230 MIE		305	8	4	1981-1987	5907058 - B788151	18-1953-2	18-1953-2	18-1976-1			18-0872	18-0897
5.0L	5.0L		305	8	4	1988-1995	B774445 - F600999	18-1953-2	18-1953-2	18-1976-1			18-0872	18-0897
5.0L	5.0L GEN +		305	8	4	1988-2002	L015751 - M599999	18-1953-2	18-1953-2	18-1976-1			18-0872	
5.0L	5.0L GEN +		305	8	4	1988-2002	M600000 - W309999						18-0872	
5.0L	5.0L GEN +		305	8	4	2004-2010	W310000 & UP						18-0872	
5.0L	5.0L EFI GEN +		305	8	4	1998-2001	L012052 - M299999	18-1953-2	18-1953-2	18-1976-1			18-0872	18-2849
5.0L	5.0L MIE		305	8	4	1988	B788152 - C396832	18-1953-2	18-1953-2	18-1976-1			18-0872	18-0897
5.0L	5.0L MPI		305	8	4	2002	M300000 - M599999	18-1953-2	18-1953-2	18-1976-1			18-0872	18-0897
5.0L	5.0L MPI		305	8	4	2002-2004	M600000 - W309999						18-0872	
5.0L	5.0L MPI		305	8	4	2004-2010	W310000 & UP						18-0872	
5.0L	5.0LX		305	8	4	1988-1995	B773740 - F600900	18-1953-2	18-1953-2	18-1976-1			18-0872	18-0897
5.0L	898		305	8	4	1977-1982	4762210 - 6218461				18-4009	18-4009	18-0872	18-0885
5.0L	898		305	8	4	1977-1982	4762210 - 6218461	18-1950-1	18-1951-1		18-4009	18-4009	18-0872	18-2833
5.0L	898		305	8	4	1983-1984	6218462 - 6899057	18-1953-2	18-1953-2	18-1970-1			18-0872	18-0897
5.0L	898		305	8	4	1983-1984	6218462 - 6899057	18-1953-2	18-1953-2	18-1976-1			18-0872	18-0897
	225	GM	327	8	4	1963-1968	1539620 - 2399397						18-0872	
	225	GM	327	8	4	1968-1969	2399398 - 2694014				18-4009	18-1990	18-0872	18-0885
	225 MIE	GM	327	8	4	1968	2278647 - 2399307						18-0872	
	225 MIE	GM	327	8	4	1968-1969	2399398 - 2694014				18-4009	18-1990	18-0872	18-0885
	250		327	8	4	1968-1969	2314301 - 2639854				18-4009	18-1990	18-0872	18-0885
	250 MIE		327	8	4	1968-1969	2314301 - 2639854				18-4009	18-1990	18-0872	18-0885
5.7L	250		350	8	4	1977	4768000 - 4908849				18-4009	18-4009	18-0872	18-0885
5.7L	250		350	8	4	1977	4768000 - 4908849	18-1950-1	18-1951-1	18-1971	18-4009	18-4009	18-0872	18-2833
5.7L	255	GM	350	8	4	1975-1976	4175500 - 4499060				18-4009	18-1990	18-0872	18-0885
5.7L	255	GM	350	8	4	1976	4499061 - 4767999	18-1950-1	18-1951-1	18-1971	18-4009	18-4009	18-0872	18-2833
5.7L	255 MIE	GM	350	8	4	1975-1976	4175500 - 4499060				18-4009	18-1990	18-0872	18-0885
5.7L	255 MIE	GM	350	8	4	1976-1980	4499061 - 5907057	18-1950-1	18-1951-1		18-4009	18-4009	18-0872	18-2833
5.7L	260		350	8	4	1978-1982	4908850 - 6218461	18-1950-1	18-1951-1	18-1971	18-4009	18-4009	18-0872	18-2833
5.7L	260		350	8	4	1983-1987	6218462 - B773304	18-1953-2	18-1953-2	18-1970-1			18-0872	18-0897
5.7L	260		350	8	4	1983-1987	6218462 - B773304	18-1953-2	18-1953-2	18-1976-1			18-0872	18-0897
5.7L	2													

MANIFOLD/MANIFOLD GASKET APPLICATION (Cont.)

Liter	Model	Note	CID	# Cyl	Stroke	Year Range	Serial Number Range	Exh Manifold Port	Exh Manifold Starboard	Exh Elbow	End Cap Front	End Cap Rear	Manifold Gasket	Exh Elbow Gasket
5.7L	350 MAG BRAVO / 350 MAG MPI		350	8	4	1995	F415189 - F601999	18-1953-2	18-1953-2	18-1976-1			18-0872	18-0897
5.7L	350 MAG BRAVO GEN + / 350 MAG MPI GEN +		350	8	4	1996-1997	F602000 - K999999	18-1953-2	18-1953-2	18-1976-1			18-0872	18-0897
5.7L	350 MAG EFI / 350 MAG SKI		350	8	4	1994-1996	F215561 - F820706	18-1953-2	18-1953-2	18-1976-1			18-0872	18-0897
5.7L	350 MAG EFI GEN + / 350 MAG SKI GEN +		350	8	4	1996-1997	F820707 - K999999	18-1953-2	18-1953-2	18-1976-1			18-0872	18-0897
5.7L	350 MAG MPI		350	8	4	1998-2001	L010019 - M299999	18-1953-2	18-1953-2	18-1976-1			18-0872	18-2849
5.7L	350 MAG MPI		350	8	4	2002	M300000 - M599999	18-1953-2	18-1953-2	18-1976-1			18-0872	18-0897
5.7L	350 MAG MPI		350	8	4	2002-2004	M600000 - W309999						18-0872	
5.7L	350 MAG MPI		350	8	4	2004-2010	W310000 & UP						18-0872	
5.7L	350 MAG MPI / 350 MAG HORIZON		350	8	4	2002	M300000 - M599999	18-1953-2	18-1953-2	18-1976-1			18-0872	18-2849
5.7L	350 MAG MPI / 350 MAG HORIZON		350	8	4	2002-2004	M600000 - W309999						18-0872	
5.7L	350 MAG MPI / 350 MAG HORIZON		350	8	4	2004-2007	W310000 - A299999						18-0872	
5.7L	350 MAG MPI / 350 MAG HORIZON / 350 MAG MIE		350	8	4	1999-2001	L304700 - M299999	18-1953-2	18-1953-2	18-1976-1			18-0872	18-2849
5.7L	350 MAG MPI / 350 MAG HORIZON / 350 MAG MIE		350	8	4	2002	M300000 - M316999	18-1953-2	18-1953-2	18-1976-1			18-0872	18-2849
5.7L	350 MAG MPI / 350 MAG HORIZON / 350 MAG MIE		350	8	4	2002-2007	M317000 - A089999						18-0872	
5.7L	350 MAG MPI / 350 MAG MIE		350	8	4	1998-2001	L002008 - M299999	18-1953-2	18-1953-2	18-1976-1			18-0872	18-2849
5.7L	350 MAG MPI / 350 MAG MIE		350	8	4	2002	M300000 - M316999	18-1953-2	18-1953-2	18-1976-1			18-0872	18-0897
5.7L	350 MAG MPI / 350 MAG MIE		350	8	4	2002-2007	M317000 - A089999						18-0872	
5.7L	350 MAG MPI / 350 MAG SKI		350	8	4	1995-1996	F350583 - F799999	18-1953-2	18-1953-2	18-1976-1			18-0872	
5.7L	350 MAG MPI GEN + / 350 MAG SKI GEN +		350	8	4	1998-2001	L002600 - M299999	18-1953-2	18-1953-2	18-1976-1			18-0872	18-2849
5.7L	350 MAG MPI GEN + / 350 MAG SKI GEN +		350	8	4	2002	M300000 - M316999	18-1953-2	18-1953-2	18-1976-1			18-0872	18-0897
5.7L	350 MAG MPI GEN + / 350 MAG SKI GEN +		350	8	4	2002-2007	M317000 - A089999						18-0872	18-0897
5.7L	350 MAG MPI GEN + / 350 MAG SKI GEN +		350	8	4	2002-2007	M317000 - A089999						18-0872	
5.7L	350 MAG SKI		350	8	4	1991-1997	D505450 - K999999	18-1953-2	18-1953-2	18-1976-1			18-0872	18-0897
5.7L	5.7L		350	8	4	1988-1997	B773305 - K999999	18-1953-2	18-1953-2	18-1976-1			18-0872	18-0897
5.7L	5.7L GEN +		350	8	4	1998-2002	L010037 - M599999	18-1953-2	18-1953-2	18-1976-1			18-0872	18-2849
5.7L	5.7L GEN +		350	8	4	2002-2004	M600000 - W309999						18-0872	
5.7L	5.7L GEN +		350	8	4	2004-2010	W310000 & UP						18-0872	
5.7L	5.7L EFI		350	8	4	1995-1997	F225560 - K999999	18-1953-2	18-1953-2	18-1976-1			18-0872	18-0897
5.7L	5.7L EFI GEN +		350	8	4	1998-2001	L010035 - M299999	18-1953-2	18-1953-2	18-1976-1			18-0872	18-2849
5.7L	5.7L EFI / 5.7L MIE		350	8	4	1997	K040300 - K999999	18-1953-2	18-1953-2	18-1976-1			18-0872	18-0897
5.7L	5.7L MIE		350	8	4	1988-1997	B788152 - K999999	18-1953-2	18-1953-2	18-1976-1			18-0872	18-0897
5.7L	5.7L MIE GEN +		350	8	4	1998-2002	L002003 - M316999	18-1953-2	18-1953-2	18-1976-1			18-0872	18-2849
5.7L	5.7L MIE GEN +		350	8	4	2002-2010	M317000 & UP						18-0872	
5.7L	5.7L MPI / 5.7L MIE		350	8	4	2008-2010	A090000 & UP						18-0872	
5.7L	5.7L MPI / 5.7L SKI		350	8	4	2008-2010	A090000 & UP						18-0872	
5.7L	5.7L MPI / 5.7L SKI		350	8	4	2008-2010	A090000 & UP						18-0872	
5.7L	5.7L SKI		350	8	4	1985-1995	A338553 - F775199	18-1953-2	18-1953-2	18-1970-1			18-0872	18-0897
5.7L	5.7L SKI		350	8	4	1985-1995	A338553 - F775199	18-1953-2	18-1953-2	18-1976-1			18-0872	18-0897
5.7L	5.7L SKI		350	8	4	1996-1997	F775200 - K999999	18-1953-2	18-1953-2	18-1976-1			18-0872	18-0897
5.7L	5.7L SKI		350	8	4	1998-2002	L002005 - M316999	18-1953-2	18-1953-2	18-1976-1			18-0872	18-2849
5.7L	5.7L SKI		350	8	4	2002-2010	M317000 & UP						18-0872	
5.7L	5.7LX		350	8	4	1996-1997	F601000 - K999999	18-1953-2	18-1953-2	18-1976-1			18-0872	18-0897
5.7L	5.7LX BRAVO EFI		350	8	4	1996-1997	F800300 - K999999	18-1953-2	18-1953-2	18-1976-1			18-0872	18-0897
5.7L	5.7LX EFI		350	8	4	1996-1997	F752400 - K999999	18-1953-2	18-1953-2	18-1976-1			18-0872	18-0897
5.7L	BLACK SCORPION SKI		350	8	4	1996-1997	F800000 - K999999	18-1953-2	18-1953-2	18-1976-1			18-0872	18-0897
5.7L	BLACK SCORPION SKI		350	8	4	2003-2007	M391600 - W698432						18-0872	
5.7L	BLACK SCORPION SKI		350	8	4	2003-2007	M391600 - W698432						18-0872	
5.7L	SCORPION 350		350	8	4	2008-2010	W698433 & UP						18-0872	
5.7L	SCORPION 350		350	8	4	2008-2010	W698433 & UP						18-0872	
6.2L	233		351	8	4	1975-1977	4173000 - 4902304	18-1958-1	18-1962-1	18-1971	18-4009	18-4009	18-0183	18-2833
6.2L	233 MIE		351	8	4	1975-1977	4173000 - 4902304	18-1958-1	18-1962-1	N.L.A.	18-4009	18-4009	18-0183	18-2833
6.2L	233 MIE		351	8	4	1975-1977	4173000 - 4902304	18-1958-1	18-1962-1	N.L.A.	18-1990	18-4009	18-0183	18-2833
6.2L	255	FORD	351	8	4	1973-1974	3258728 - 4175499	18-1958-1	18-1962-1	18-1971	18-4009	18-4009	18-0183	18-2833
6.2L	255 MIE	FORD	351	8	4	1973-1974	3258728 - 4175499	18-1958-1	18-1962-1	18-1971	18-4009	18-4009	18-0183	18-2833
6.2L	225 MIE	FORD	351	8	4	1973-1974	3258728 - 4175499	18-1958-1	18-1962-1	18-1971	18-1990	18-4009	18-0183	18-2833
6.2L	377 MAG		377	8	4	2008-2010	A300000 & UP						18-0872	
6.2L	377 SCORPION MCM		377	8	4	1999-2005	L416146 - M907201	18-1953-2	18-1953-2	18-1976-1			18-0872	18-2849
6.2L	377 SCORPION SKI		377	8	4	1997-1998	K000656 - L600314	18-1953-2	18-1953-2	18-1976-1			18-0872	18-0897
6.2L	MX 6.2L MPI		377	8	4	2000-2001	L680003 - M299999	18-1953-2	18-1953-2	18-1976-1			18-0872	18-2849
6.2L	MX 6.2L MPI		377	8	4	2002	M300000 - M599999	18-1953-2	18-1953-2	18-1976-1			18-0872	18-0897
6.2L	MX 6.2L MPI		377	8	4	2002-2004	M600000 - W309999						18-0872	
6.2L	MX 6.2L MPI		377	8	4	2004-2007	W310000 - A299999						18-0872	
6.2L	MX 6.2L MPI / MX 6.2L HORIZON		377	8	4	2002	M300000 - M599999	18-1953-2	18-1953-2	18-1976-1			18-0872	18-2849
6.2L	MX 6.2L MPI / MX 6.2L HORIZON		377	8	4	2002-2004	M600000 - W309999						18-0872	
6.2L	MX 6.2L MPI / MX 6.2L HORIZON		377	8	4	2004-2007	W310000 - A299999						18-0872	
6.2L	MX 6.2L MPI / MX 6.2L HORIZON / MX 6.2L MIE		377	8	4	2002	M300000 - M316999	18-1953-2	18-1953-2	18-1976-1			18-0872	18-2849
6.2L	MX 6.2L MPI / MX 6.2L HORIZON / MX 6.2L MIE		377	8	4	2002-2007	M317000 - A089999						18-0872	
6.2L	MX 6.2L MPI / MX 6.2L MIE		377	8	4	1999-2001	L670000 - M299999	18-1953-2	18-1953-2	18-1976-1			18-0872	18-2849
6.2L	MX 6.2L MPI / MX 6.2L MIE		377	8	4	2002	M300000 - M316999	18-1953-2	18-1953-2	18-1976-1			18-0872	18-0897
6.2L	MX 6.2L MPI / MX 6.2L MIE		377	8	4	2002-2010	M317000 & UP						18-0872	

● For engines with aluminum exhaust manifolds
 ● For engines with cast iron exhaust manifolds
 ● 3" (76mm) O.D. & 0 degree down angle
 ● 3" (76mm) O.D. & 15 degree down angle
 ● 4" (102mm) O.D.
 ● 2 piece exhaust manifold
 ● 1 piece exhaust manifold
 ● Has a rectangular elbow mounting bolt pattern
 ● Has a square elbow mounting bolt pattern
 ● In-line applications
 ● V-drive applications
 ● Standard rise
 ● 2" (51mm) rise
 ● 3" (76mm) rise
 ● 6" (152mm) rise
 ● Port
 ● Starboard
 ● Engines with risers or closed cooling may require a different gasket than listed
 ● Exhaust manifold with external water rail
 ● Exhaust manifold w/o external water rail
 ● 1 piece exhaust manifold is n.l.a. Engine must be converted to the 2 piece exhaust system
 ● Engines with easy drain system
 ● Engines with multi-point system
 ▼ Intermediate collector housing

MANIFOLD/MANIFOLD GASKET APPLICATION (Cont.)

Liter	Model	Note	CID	# Cyl	Stroke	Year Range	Serial Number Range	Exh Manifold Port	Exh Manifold Starboard	Exh Elbow	End Cap Front	End Cap Rear	Manifold Gasket	Exh Elbow Gasket
6.2L	MX 6.2L MPI / MX 6.2L SKI		377	8	4	2002-2007	M317000 - A089999							18-0872
6.2L	MX 6.2L MPI / MX 6.2L SKI		377	8	4	2002-2007	M317000 - A089999							18-0872
6.2L	MX 6.2L BLACK SCORPION SKI		377	8	4	2001-2003	L670015 - M391599	18-1953-2	18-1953-2	18-1976-1				18-0872 18-2849
6.2L	MX 6.2L BLACK SCORPION SKI		377	8	4	2003-2007	M391600 - W698432							18-0872
6.2L	MX 6.2L BLACK SCORPION SKI		377	8	4	2003-2007	M391600 - W698432							18-0872
6.2L	SCORPION 377		377	8	4	2008-2010	W698433 & UP							18-0872
6.2L	SCORPION 377		377	8	4	2008-2010	W698433 & UP							18-0872
7.4L	325		427	8	4	1968	2278747 - 2313964							18-0418
7.4L	325		427	8	4	1968-1974	2313965 - 3780449				18-4009	18-1990		18-0418 18-0885
7.4L	325 MIE		427	8	4	1968	2278747 - 2313964							18-0418
7.4L	325 MIE		427	8	4	1968-1974	2313965 - 3780449				18-4009	18-1990		18-0418 18-0885
7.4L	330		454	8	4	1977-1981	4623115 - 6083144				18-4009	18-4009		18-0418 18-0885
7.4L	330		454	8	4	1982-1987	6083145 - B816540	18-1957-1	18-1957-1	18-1970-1				18-0418 18-0897
7.4L	330		454	8	4	1982-1987	6083145 - B816540	18-1957-1	18-1957-1	18-1976-1				18-0418 18-0897
7.4L	330 MIE		454	8	4	1977-1981	4623115 - 6083144				18-4009	18-4009		18-0418 18-0885
7.4L	340 MIE W/BW		454	8	4	1981-1987	5889914 - B788365	18-1957-1	18-1957-1	18-1974-1				18-0418 18-0897
7.4L	340 MIE W/BW		454	8	4	1981-1987	5889914 - B788365	18-1957-1	18-1957-1	18-1970-1				18-0418 18-0897
7.4L	340 MIE W/BW		454	8	4	1981-1987	5889914 - B788365	18-1957-1	18-1957-1	18-1976-1				18-0418 18-0897
7.4L	350 MIE		454	8	4	1974-1975	3780450 - 4501640				18-4009	18-1990		18-0418 18-0885
7.4L	350 MIE		454	8	4	1976	4501641 - 4623109				18-4009	18-4009		18-0418 18-0885
7.4L	370 TRS		454	8	4	1978-1985	4179554 - 6721527				18-4009	18-1990		18-0418 18-0885
7.4L	370 TRS		454	8	4	1985-1987	6721528 - B714586	18-1957-1	18-1957-1	18-1976-1				18-0418 18-2849
7.4L	400 TRS		454	8	4	1980-1986	4179554 - B457644				18-4009	18-1990		18-0418 18-0885
7.4L	420		454	8	4	1987-1989	A398941 - B622418							18-0418
7.4L	425		454	8	4	1990-1992	G398941 - D937011							18-0418
7.4L	440 TRS		454	8	4	1983-1986	4179554 - B485220							18-0418
7.4L	450		454	8	4	1995-1996	F347100 - F347277							18-0418
7.4L	450		454	8	4	1995-1996	F347100 - F347277							18-0418
7.4L	450		454	8	4	1995-1996	F347100 - F347277							18-0418
7.4L	454 MAG ALPHA		454	8	4	1986-1988	A631894 - B785148	18-1957-1	18-1957-1	18-1976-1				18-0418 18-0897
7.4L	454 MAG BRAVO		454	8	4	1988-1997	B721206 - K999999	18-1957-1	18-1957-1	18-1976-1				18-0418 18-0897
7.4L	454 MAG EFI		454	8	4	1994-1996	F115700 - F802349	18-1957-1	18-1957-1	18-1976-1				18-0418 18-0897
7.4L	454 MAG EFI / 454 MAG SKI		454	8	4	1995-1996	F215800 - F820099	18-1957-1	18-1957-1	18-1976-1				18-0418 18-0897
7.4L	454 MAG MPI		454	8	4	1996-1997	F802350 - K999999	18-1957-1	18-1957-1	18-1976-1				18-0418 18-0897
7.4L	454 MAG MPI		454	8	4	1998-2001	L010029 - M0224999	18-1957-1	18-1957-1	18-1976-1				18-0418 18-2849
7.4L	454 MAG MPI / 454 MAG HORIZON / 454 MAG MIE		454	8	4	1999-2001	L086050 - L674000	18-1957-1	18-1957-1	18-1976-1				18-0418 18-2849
7.4L	454 MAG MPI / 454 MAG SKI		454	8	4	1996-1997	F820100 - K999999	18-1957-1	18-1957-1	18-1976-1				18-0418 18-0897
7.4L	525 SC W/BRAVO		454	8	4	1991-1996	D456000 - F877734							18-0418
7.4L	525 SC W/BRAVO		454	8	4	1991-1996	D456000 - F877734							18-0418
7.4L	525 SC W/BRAVO		454	8	4	1991-1996	D456000 - F877734							18-0418
7.4L	525 SC W/SSM		454	8	4	1991-1996	D456000 - F877734							18-0418
7.4L	525 SC W/SSM		454	8	4	1991-1996	D456000 - F877734							18-0418
7.4L	525 SC W/SSM		454	8	4	1991-1996	D456000 - F877734							18-0418
7.4L	7.4L BRAVO		454	8	4	1988-1997	B771113 - K999999	18-1957-1	18-1957-1	18-1976-1				18-0418 18-0897
7.4L	7.4L EFI / 7.4L MIE		454	8	4	1996-1997	F874815 - K999999	18-1957-1	18-1957-1	18-1976-1				18-0418 18-0897
7.4L	7.4L MIE W/BW		454	8	4	1988-1992	B788366 - D715493	18-1957-1	18-1957-1	18-1974-1				18-0418 18-0897
7.4L	7.4L MIE W/BW		454	8	4	1988-1992	B788366 - D715493	18-1957-1	18-1957-1	18-1970-1				18-0418 18-0897
7.4L	7.4L MIE W/BW		454	8	4	1988-1992	B788366 - D715493	18-1957-1	18-1957-1	18-1976-1				18-0418 18-0897
7.4L	7.4L MIE W/HURTH		454	8	4	1989-1992	C391564 - D715493	18-1957-1	18-1957-1	18-1976-1				18-0418 18-0897
7.4L	7.4L MIE		454	8	4	1992-1997	D715494 - K999999	18-1957-1	18-1957-1	18-1976-1				18-0418 18-0897
7.4L	7.4L MPI		454	8	4	1998-2001	L010003 - M024330	18-1957-1	18-1957-1	18-1976-1				18-0418 18-2849
7.4L	7.4L MPI / 7.4L MIE		454	8	4	1995-1997	F563052 - K999999	18-1957-1	18-1957-1	18-1976-1				18-0418 18-0897
7.4L	7.4L MPI / 7.4L MIE		454	8	4	1998-2001	L002006 - L674613	18-1957-1	18-1957-1	18-1976-1				18-0418 18-2849
7.4L	7.4LX BRAVO EFI		454	8	4	1996-1997	F820000 - K999999	18-1957-1	18-1957-1	18-1976-1				18-0418 18-0897
7.4L	7.4LX BRAVO MPI		454	8	4	1996-1997	F602010 - K999999	18-1957-1	18-1957-1	18-1976-1				18-0418 18-0897
	390 MCM / 390 MIE		482	8	4	1969-1970	2781129 - 3042731				18-1990	18-1990		18-0418 18-0885
	496 MAG / 496 HO		496	8	4	2001-2003	M025000 - M687143							18-0418
	496 MAG / 496 HO		496	8	4	2001-2010	M0225000 & UP							18-0418
	8.1S / 8.1 HO / 8.1 MIE		496	8	4	2001-2003	M026000 - M319190							18-0418
	8.1S / 8.1 HO / 8.1 MIE		496	8	4	2001-2010	M026000 & UP							18-0418
8.2L	465		502	8	4	1990-1994	C849992 - F213244							18-0418
8.2L	465		502	8	4	1990-1994	C849992 - F213244							18-0418
8.2L	465		502	8	4	1990-1994	C849992 - F213244							18-0418
8.2L	500 BRAVO		502	8	4	1994-1998	F213293 - L001772							18-0418
8.2L	500 BRAVO		502	8	4	1994-1998	F213293 - L001772							18-0418
8.2L	500 BRAVO		502	8	4	1994-1998	F213293 - L001772							18-0418
8.2L	500 GEN +		502	8	4	1999	L414639 - L601036							18-0418
8.2L	500 GEN +		502	8	4	1999	L414639 - L601036							18-0418
8.2L	500 GEN +		502	8	4	1999	L414639 - L601036							18-0418
8.2L	502 MAG BRAVO		502	8	4	1990-1993	C878221 - F114528	18-1957-1	18-1957-1	18-1976-1				18-0418 18-0897
8.2L	502 MAG EFI		502	8	4	1993-1995	D840650 - F802599	18-1957-1	18-1957-1	18-1976-1				18-0418 18-0897
8.2L	502 MAG MPI		502	8	4	1996-1997	F802600 - K999999	18-1957-1	18-1957-1	18-1976-1				18-0418 18-0897
8.2L	502 MAG MPI		502	8	4	1998-2001	L017000 - M024999	18-1957-1	18-1957-1	18-1976-1				18-0418 18-2849
8.2L	600 SC		502	8	4	1991-1996	D456489 - F877642							18-0418
8.2L	600 SC		502	8	4	1991-1996	D456489 - F877642							18-0418
8.2L	8.2L MIE		502	8	4	1990-1996	C878221 - F819619	18-1957-1	18-1957-1	18-1976-1				18-0418 18-0897
8.2L	8.2L MIE / 8.2L MPI		502	8	4	1996-1997	F819620 - K999999	18-1957-1	18-1957-1	18-1976-1				18-0418 18-0897
8.2L	8.2L MIE / 8.2L MPI		502	8	4	1998-2001	L002450 - L674200	18-1957-1	18-1957-1	18-1976-1				18-0418 18-2849
	500 BULLDOG W/BRAVO		540	8	4	1990-1998	C577254 - L001607							18-0418
	500 BULLDOG W/BRAVO		540	8	4	1990-1998	C577254 - L001607							18-0418
	500 BULLDOG W/BRAVO		540	8	4	1990-1998	C577254 - L001607							18-0418
	500 BULLDOG W/BRAVO		540	8	4	1999-2001	L414620 - M050281							18-0418
	500 BULLDOG W/BRAVO		540	8	4	1999-2001	L414620 - M050281							18-0418
	500 BULLDOG W/BRAVO		540	8	4	1999-2001	L414620 - M050281							18-0418
	500 BULLDOG W/SSM		540	8	4	1990-2001	C577254 - M050261							18-0418
	500 BULLDOG W/SSM		540	8	4	1990-2001	C577254 - M050261							18-0418
	500 BULLDOG W/SSM		540	8	4	1990-2001	C577254 - M050261							18-0418

- For engines with aluminum exhaust manifolds
- For engines with cast iron exhaust manifolds
- 3" (76mm) O.D. & 0 degree down angle
- 3" (76mm) O.D. & 15 degree down angle
- 4" (102mm) O.D.
- 2 piece exhaust manifold
- 1 piece exhaust manifold
- Has a rectangular elbow mounting bolt pattern
- Has a square elbow mounting bolt pattern

Features...

- Manufactured to meet or exceed OEM specifications.
- High Efficiency Filter
- Field-tested and approved.
- Anti-drainback valves where required.



OIL FILTERS

- ① Do not use on V-6 engines equipped with remote oil filter kit
- Display Packaged

SEE PAGES 152-154 FOR ADDITIONAL INFORMATION

Part #	O.E. #	Application
18-7824-1*	54111, 14957, 32716, 35-802885Q, 35-866340K01, 35-866340Q03	GM Engines ① (Short Filter)
18-7871	35-805809, T	D7.3L Diesel
18-7875*	60565, 35-802886Q	Ford Engines (Long Filter)
18-7876*	52731, 35-16595T, T1, Q, 32-802885Q, 14957	GM Engines (Long Filter)
18-7878-1*	803470, Q	60 & 80 HP Engines (Renault) (Short Filter)
18-7879*	41815, 35-802884Q, 35-883702Q, K	GM V-6 Engines

OIL PANS AND GASKET



18-1232
OIL PAN GASKET
Replaces: 27-811566



Part No.	OE	OE No.	Application
18-0612	MerCruiser	809910	1 piece rear main seal; GM Small Block V8 (Right Handed Dipstick)
18-0613	MerCruiser	93476	2 piece rear main seal; GM Small Block V8 (Right Handed Dipstick)
18-0614	MerCruiser	845668T	1 piece rear main seal; GM Big Block V8 (Right Handed Dipstick)
18-0615	MerCruiser	93477T	2 piece rear main seal; GM Big Block V8 (Right Handed Dipstick)
18-0616	MerCruiser	14244T	1 piece rear main seal; GM V6 (Right Handed Dipstick)

CYLINDER HEAD ASSEMBLIES

All cylinder heads are new castings and complete assemblies with new- stainless steel valves, hardened steel exhaust seats, valve springs, valve locks, and retainers.
All GM cylinder heads utilize high performance screw-in rocker arm studs in place of factory press in rocker arm studs.



18-4484
CYLINDER HEAD ASSEMBLY
Fits: 5.7L V-8 GM (1969-86) with 12 intake manifold mounting bolts, perimeter mount valve cover



18-4485
CYLINDER HEAD ASSEMBLY
Replaces: 938-883490 1
Fits: 5.7L V-8 GM (1987-95) with press in rocker arm studs with 12 intake manifold mounting bolts- (4 inside intake manifold bolts at 23 degrees), center mount valve covers



18-4486
CYLINDER HEAD ASSEMBLY
Replaces: 938-883297 1, 938-803860T
Fits: 5.7L V-8 GM Vortec (1996-Up) with press in rocker arm studs with 8 intake manifold mounting bolts, composite valve cover



18-4489
CYLINDER HEAD ASSEMBLY
Replaces: 936-5544, 936-810840
Fits: 2.5L/3.0L GM (1968-95) (non MerCruiser LX models) (1968-95)



18-4491
CYLINDER HEAD ASSEMBLY
Replaces: 938-827178 1
Replaces 4.3L Vortec V-6 (1996-Up) with screw in rocker arm studs (non-adjustable valve train), 8 intake manifold mounting bolts, center mount valve cover. NOTE: not for use with engines using factory roller rocker arms.



18-4495
CYLINDER HEAD ASSEMBLY
Replaces: 949-4057, 949-5798
Fits: (1980& Up) 5.0L Ford with D-shape 58 cc combustion chamber



18-4501
CYLINDER HEAD
Fits: 5.0L Vortec



18-4502
CYLINDER HEAD
High Performance
Aluminum cylinder head sold in pairs only. This utilizes a 185cc intake runner/62cc exhaust runner and 2.02/1.60 stainless valves placed in a 72cc combustion chamber.
Fits: 5.7, 6.2L GM small block V-8



**18-4492
ROCKER ARM ASSEMBLY**
Replaces: 35329
Fits: MCM/MIE Gm V6 & V8(283, 305 & 350 cid) engines



**18-7508
POWER STEERING PUMP**
Replaces: 16792A39



**18-8227
POWER STEERING PUMP PULLEY**
Replaces: 73873A1
For: Sterndrives with v-belt



**18-8297
POWER STEERING PUMP PULLEY**
Replaces: 861578
For: Sterndrives with serpentine belt



**18-1400
HYDRAULIC LIFTER**
Replaces: 17340
GM 4.3L/V-6 Late/5.0L/5.7L



**18-1401
HYDRAULIC LIFTER**
Replaces: 56153
Ford 302/351
Ford 5.0L & 5.8L



**18-1402
HYDRAULIC LIFTER**
Replaces: 72638
GM 2.5L/120
For: Mercruiser 140 (S/N 2508261-6229717),
140/3.0L (S/N 6229718-up), 3.0L/3.0LX (S/N C856559-up)

**ALL PISTONS
ARE SUPPLIED COMPLETE WITH PISTON RINGS AND WRIST PIN.**



RINGS

STD	REPLACES MERCURUISER
18-3928	39-74381A1
18-3937	39-17464
18-3940	39-67127
18-3942	39-67132
18-3944	39-75609
.020	
18-3939	39-66217
.030	
18-3938	39-17465

PISTONS

STD	REPLACES MERCURUISER
18-4180	736-2343
18-4161	733-3819 733-803850T
18-4109	778-9441A3 759-80661A7
18-4173	735-6370 735-9686 735-808674 735-850097
.020	
18-4160	733-3818
.030	
18-4134	778-9441A5 759-80661A8
18-4164	735-6371 735-9687 735-850098
18-4178	735-9715

PISTON/ RING APPLICATION

Liter	Model	Note	CID	# Cyl	Stroke	Year	Serial Number	PISTONS			RINGS			Qty. Eng.
								Std.	0.02	0.03	Note	Std.	0.02	
1.6L	100 VASER		98	4	4	2007-2010	W995000 & UP	-	-	-	-	-	-	
2.5L	120		153	4	4	1964-1986	1666601 - B531853	18-4180	-	-	-	-	-	
2.5L	153		153	4	4	1987-1989	B531854 - C853255	18-4180	-	-	-	-	-	
3.0L	140		181	4	4	1968-1986	2508261 - B450800	18-4161	18-4160	18-4191	18-3937	18-3939	18-3938	4
3.0L	140				4		3332138 - 5157668	18-4161	18-4160	18-4191	18-3937	18-3939	18-3938	4
3.0L	140				4		5157669 - 6229717	18-4161	18-4160	18-4191	18-3937	18-3939	18-3938	4
3.0L	140 / 3.0L				4		6229718 - C856558	18-4161	18-4160	18-4191	18-3937	18-3939	18-3938	4
3.0L	3.0L		181	4	4	1987-1989	B450801 - C856558	18-4161	18-4160	-	-	-	-	
3.0L	3.0L		181	4	4	1990-1994	C856559 - F603999	-	-	-	18-3937	18-3939	18-3938	6
3.0L	3.0L		181	4	4	1998-2010	L010042 & UP	-	-	-	-	-	-	
3.0L	3.0L MPI		181	4	4	2008-2010	A072812 & UP	-	-	-	-	-	-	
3.0L	3.0LX		181	4	4	1990-1997	C856559 - K999999	-	-	-	-	-	-	
3.7L	165 / 3.7L		224	4	4	1987-1989	B434941 - C762299	-	-	(11)	18-4134	-	-	
3.7L	170		224	4	4	1985-1986	6916779 - B434940	18-4109	18-4118	-	18-4134	18-3928	18-3929	4
3.7L	180 / 3.7LX		224	4	4	1987-1989	B436391 - C762299	18-4109	-	(11)	18-4134	-	-	
3.7L	190 / 3.7L		224	4	4	1985-1986	6916779 - B436390	18-4109	-	(11)	18-4134	-	-	
3.7L	470		224	4	4	1976-1984	4208730 - 6916779	18-4109	18-4118	-	18-4134	18-3928	18-3929	4
3.7L	485		224	4	4	1980-1982	5685394 - 6218036	18-4109	-	(11)	18-4134	-	-	
3.7L	488		224	4	4	1983-1984	6170297 - 6916778	18-4109	-	(11)	18-4134	-	-	
	150				4		1666495 - 2048046	18-4180	18-4183	-	-	18-3942	-	6
4.1L	160		250	6	4	1987-1989	2048022 - 2770031	-	-	-	18-3942	-	-	
4.1L	165		250	6	4	1970-1981	2770032 - 5813433	-	-	-	18-3942	-	-	
4.3L	175 / 4.3L				4		B527955 - & Up	18-4173	18-4188	18-4164	18-3937	18-3939	18-3938	6
3.8L	185	2bbi			4	1983-1984	6330183 - 6919655	-	-	-	18-3944	-	-	
4.3L	175 / 4.3L		262	6	4	1987-1992	B527955 - D714106	-	-	-	-	-	-	
4.3L	185	2bbi	262	6	4	1985-1986	A331455 - B527954	-	-	18-4164	18-3937	18-3939	-	
4.3L	205 / 4.3LX		262	6	4	1985-1986	A331455 - B527954	-	-	18-4164	18-3937	18-3939	18-3938	
4.3L	262 MAG EFI GEN +		262	6	4	1987-1991	B527955 - D714369	18-4173	-	-	-	-	-	
4.3L	262 MAG EFI GEN +		262	6	4	1996-1997	F803800 - K999999	-	-	-	-	-	-	
4.3L	4.3L GEN II		262	6	4	1992-1996	D714107 - F802999	18-4173	18-4188	-	-	-	18-3938	6
4.3L	4.3L GEN +		262	6	4	1998-2010	L010044 & UP	-	-	-	-	-	-	
4.3L	4.3L EFI GEN +		262	6	4	1998-2001	L012009 - M299999	-	-	-	-	-	-	
4.3L	4.3L MPI		262	6	4	2002-2010	M322761 & UP	-	-	-	-	-	-	
4.3L	4.3LH GEN +		262	6	4	1998-2002	L010044 - M614999	-	-	-	-	-	-	
4.3L	4.3LX GEN II		262	6	4	1992-1996	D7141370 - F802999	-	-	18-4164	18-3937	18-3939	18-3938	6
4.3L	4.3LX GEN +		262	6	4	1996-1997	F803000 - K999999	-	-	-	-	-	-	
4.3L	4.3LXH GEN +		262	6	4	1996-1997	F803114 - K999999	-	-	-	-	-	-	
4.9L	215	FORD	302	8	4	1970-1972	2781153 - 3395720	-	-	-	18-3937	18-3939	18-3938	8
4.9L	215	FORD			4	1973-1974	3385721 - 4166999	-	-	-	18-3937	18-3939	18-3938	8
	225	GM			4		1536920 - & Up	-	-	-	18-3937	18-3939	18-3938	8
4.6L	190	GM	283	8	4	1963-1964	1564539 - 1730903	18-4180	18-4183	-	18-3942	-	-	6
5.0L	198 MIE		305	8	4	1977	4776402 - 4931099	-	-	-	-	-	-	
5.0L	200		305	8	4	1985-1987	6899058 - B525981	-	-	-	-	-	-	
5.0L	200 / 5.0L	GM	305	8	4	1987	B525982 - B774444	-	-	18-4178	18-3944	-	-	8
	200	GM			4		6218462 - & Up	-	-	-	18-3944	-	-	8
5.0L	228	GM	305	8	4	1977-1984	4765100 - 6899268	-	-	-	18-3944	-	-	8
5.0L	228 MIE		305	8	4	1977-1980	5170009 - 5907057	-	-	-	-	-	-	
5.0L	230		305	8	4	1985-1987	6899269 - B525981	-	-	-	-	-	-	
5.0L	230		305	8	4	1987-1995	B525982 - B773739	-	-	18-4178	18-3944	-	-	8
5.0L	230 MIE	GM	305	8	4	1981-1987	5907058 - B522505	-	-	-	18-3944	-	-	8
5.0L	230 MIE		305	8	4	1987	B522506 - B788151	-	18-4530	18-4178	18-3944	-	-	8
5.0L	230 GM				4		6218462 - & Up	-	-	-	18-3944	-	-	8
5.0L	5.0L		305	8	4	1988-1995	B774445 - F600999	-	-	-	-	-	-	
5.0L	5.0L GEN +		305	8	4	1998-2010	L015751 & UP	-	-	-	-	-	-	
5.0L	5.0L EFI GEN +		305	8	4	1998-2001	L012052 - M299999	-	-	-	-	-	-	
5.0L	5.0L MIE		305	8	4	1988	B788152 - C396832	-	-	-	-	-	-	
5.0L	5.0L MPI		305	8	4	2002-2010	M300000 & UP	-	-	-	-	-	-	
5.0L	5.0LX		305	8	4	1988-1995	B773740 - F600999	-	-	-	-	-	-	
5.0L	898 / 198	GM	305	8	4	1977-1984	4762210 - 6899057	-	-	-	18-3944	-	-	8
5.4L	225 MCM / 225 MIE	GM	327	8	4	1963-1969	1539620 - 2694014	-	-	-	-	-	-	
5.4L	250 MCM - 250 MIE	GM	327	8	4	1968-1969	2314301 - 2639854	-	-	-	18-3937	18-3939	18-3938	8
5.7L	250	GM	350	8	4	1977	4768000 - 4908849	18-4173	18-4188	18-4164	18-3937	18-3939	18-3938	8
5.7L	255	GM	350	8	4	1975-1976	4175500 - 4767999	18-4173	18-4188	18-4164	18-3937	18-3939	18-3938	8
5.7L	255 MIE	GM	350	8	4	1975-1980	4175500 - 5907057	18-4173	-	-	-	-	-	8
5.7L	260	GM	350	8	4	1978-1987	4908850 - B773304	18-4173	18-4188	18-4164	18-3937	18-3939	18-3938	8
5.7L	260 MIE	GM	350	8	4	1981-1987	5907058 - B788151	18-4173	18-4188	18-4164	18-3937	18-3939	18-3938	8
5.7L	260 / 5.7L	GM	350	8	4		B525982 - & Up	18-4173	18-4188	18-4164	18-3937	18-3939	18-3938	8
5.7L	270 MCM / 270 MIE		350	8	4	1969-1972	2851074 - 3077735	-	-	-	18-3937	18-3939	18-3938	8
5.7L	280		350	8	4	1975-1976	4176250 - 4770199	-	-	-	-	-	-	8
5.7L	300		350	8	4	1985-1988	6668677 - B430367	-	-	-	18-3937	18-3939	18-3938	8
5.7L	320 EFI		350	8	4	1987-1989	A543604 - C622418	-	-	-	18-3937	18-3939	18-3938	8
5.7L	320 GM EFI BRAVO				4		B157603 - & Up	-	-	-	18-3937	18-3939	18-3938	8
	325	GM			4		2278747 - & Up	-	-	-	18-3940	18-3950	18-3941	8
	330	GM			4		4623115 - & Up	-	18-4189	-	18-3940	18-3950	18-3941	8
	330 W/B.W.	GM			4		6083145 - & Up	-	18-4189	-	18-3940	18-3950	18-3941	8
5.7L	350 MAG ALPHA		350	8	4	1986-1997	A635178 - K999999	18-4173	18-4188	18-4164	18-3937	18-3939	18-3938	8
5.7L	350 MAG ALPHA EFI GEN +		350	8	4	1996-1997	F800300 - K999999	-	-	-	-	-	-	8
5.7L	350 MAG BRAVO MPI		350	8	4	1995	F415189 - F601999	18-4173	-	18-4164	-	-	-	8
5.7L	350 MAG BRAVO MPI GEN +		350	8	4	1996-1997	F602000 - K999999	-	-	-	-	-	-	8
5.7L	350 MAG SKI		350	8	4	1994-1996	F215561 - F820706	18-4173	-	18-4164	F215561 - F820706	-	-	8

- (1) Cast Aluminum (Use with GM Engine Code 1XW)
- (2) Cast aluminum (Use with GM Engine Code 4XW)
- (3) Forged Aluminum (Use with GM Engine Code 3UB)
- (4) Cast Aluminum (Use with GM Engine Code 4XX)
- (5) Cast Aluminum (Use with GM Engine Code 2XY)
- (6) Cast Aluminum (Use with GM Engine Code 4XY)

- (7) Flat Head
 - (8) Forged Aluminum, Recessed Head
 - (9) Starboard
 - (10) Port
 - (11) .010 (25mm)Oversize
- N.L.A. No longer available from O.E. source

PISTON/ RING APPLICATION

Liter	Model	Note	CID	# Cyl	Stroke	Year	Serial Number	PISTONS			RINGS			Qty. Eng.	
								Std.	Note	0.02	0.03	Note	Std.		0.02
5.7L	350 MAG EFI SKI GEN +		350	8	4	1996-1997	F820707 - K999999	-	-	-	-	-	-	8	
5.7L	350 MAG MPI GEN +		350	8	4	1998-2010	L010019 & UP	-	-	-	-	-	-	8	
5.7L	350 MAG MPI / 350 MAG HORIZON		350	8	4	2002-2007	M300000 - A299999	-	-	-	-	-	-	8	
5.7L	350 MAG MPI / 350 MAG HORIZON / 350 MAG MIE		350	8	4	1998-2007	L304700 - A89999	-	-	-	-	-	-	8	
5.7L	350 MAG / 350 MAG MIE / 350 MAG MPI GEN +		350	8	4	1998-2007	L002008 - A089999	-	-	-	-	-	-	8	
5.7L	350 MAG MPI SKI		350	8	4	1995-1996	F350583 - F799999	18-4173	-	-	18-4164	-	-	-	8
5.7L	350 MAG MPI SKI GEN +		350	8	4	1998-2007	L002600 - A089999	-	-	-	-	-	-	-	8
5.7L	350 MAG SKI		350	8	4	1991-1997	D505450 - K999999	18-4173	18-4188	18-4164	18-3937	18-3939	18-3938	8	
5.7L	350	GM	350	8	4		3780450 - & Up	-	-	-	18-3940	18-3950	18-3941	8	
5.7L	350 MAG	GM	350	8	4		B525982 - & Up	18-4173	18-4188	18-4164	18-3937	18-3939	18-3938	8	
5.7L	5.7L		350	8	4	1988-1995	B773305 - F600999	18-4173	-	18-4164	-	-	-	8	
5.7L	5.7L	2bb1	350	8	4	1996-1997	F601000 - K999999	18-4173	-	-	-	-	-	8	
5.7L	5.7L GEN +		350	8	4	1998-2010	L010037 & UP	-	-	-	-	-	-	8	
5.7L	5.7L EFI		350	8	4	1995-1997	F225560 - K999999	18-4173	-	18-4164	-	-	-	8	
5.7L	5.7L EFI GEN +		350	8	4	1998-2001	L010035 - M299999	-	-	-	-	-	-	8	
5.7L	5.7L EFI MIE GEN +		350	8	4	1997	K040300 - K999999	-	-	-	-	-	-	8	
5.7L	5.7L MIE		350	8	4	1988-1997	B788152 - K999999	18-4173	-	18-4164	-	-	-	8	
5.7L	5.7L MIE GEN +		350	8	4	1998-2010	L002003 & UP	-	-	-	-	-	-	8	
5.7L	5.7L MPI / 5.7L HORIZON / 5.7L MIE		350	8	4	2008-2010	A090000 & UP	-	-	-	-	-	-	8	
5.7L	5.7L MPI / 5.7L MIE		350	8	4	2008-2010	A090000 & UP	-	-	-	-	-	-	8	
5.7L	5.7L MPI / 5.7L SKI		350	8	4	2008-2010	A090000 & UP	-	-	-	-	-	-	8	
5.7L	5.7L SKI		350	8	4	1985-1997	A338553 - K999999	18-4173	-	18-4164	-	-	-	8	
5.7L	5.7L SKI GEN +		350	8	4	1998-2010	L002005 & UP	-	-	-	-	-	-	8	
5.7L	5.7LX		350	8	4	1996-1997	F601000 - K999999	18-4173	-	18-4164	-	-	-	8	
5.7L	5.7LX BRAVO EFI GEN +		350	8	4	1996-1997	F800300 - K999999	-	-	-	-	-	-	8	
5.7L	5.7LX EFI		350	8	4	1996-1997	F752400 - K999999	18-4173	-	18-4164	-	-	-	8	
5.7L	BLACK SCORPION SKI GEN +		350	8	4	1998-2007	F800000 - W6988432	-	-	-	-	-	-	8	
5.7L	SCORPION 350		350	8	4	2008-2010	W698432 & UP	-	-	-	-	-	-	8	
5.8L	233	FORD	351	8	4	1975-1977	4173000 - 4902304	-	-	-	-	-	-	8	
5.8L	255	FORD	351	8	4	1973-1974	3258728 - 4175499	-	-	-	-	-	-	8	
6.2L	377 MAG		377	8	4	2008-2009	A000000 - A345479	-	-	-	-	-	-	8	
6.2L	377 MAG		377	8	4	2009	A345480 - A345492	-	-	-	-	-	-	8	
6.2L	377 MAG		377	8	4	2009	A345493 - A345765	-	-	-	-	-	-	8	
6.2L	377 MAG		377	8	4	2009	A345766 - A345767	-	-	-	-	-	-	8	
6.2L	377 MAG		377	8	4	2009	A345768 - A346789	-	-	-	-	-	-	8	
6.2L	377 MAG		377	8	4	2009-2010	A346790 & UP	-	-	-	-	-	-	8	
6.2L	377 SCORPION STERNDRIIVE		377	8	4	2000-2010	L416146 & UP	-	-	-	-	-	-	8	
6.2L	377 SCORPION SKI		377	8	4	1997-1998	K000666 - L600314	-	-	-	-	-	-	8	
6.2L	MX 6.2L MPI		377	8	4	2000-2007	L680003 - A299999	-	-	-	-	-	-	8	
6.2L	MX 6.2L MPI / MX 6.2L MIE		377	8	4	2002-2009	M300000 - A091825	-	-	-	-	-	-	8	
6.2L	MX 6.2L MPI / MX 6.2L MIE		377	8	4	2009-2010	A091826 & UP	-	-	-	-	-	-	8	
6.2L	MX 6.2L MPI / MX 6.2L SKI		377	8	4	2002-2007	M317000 - W689999	-	-	-	-	-	-	8	
6.2L	MX 6.2L BLACK SCORPION SKI		377	8	4	2001-2007	L670015 - W698432	-	-	-	-	-	-	8	
6.2L	SCORPION 377		377	8	4	2008-2009	W698826 & UP	-	-	-	-	-	-	8	
6.2L	SCORPION 377 HO / SCORPION 377 EC		377	8	4	2009-2010	A091488 - A092170	-	-	-	-	-	-	8	
7.4L	325 MCM / 325 MIE		454	8	4	1969-1972	2278747 - 3780449	-	-	-	-	-	-	8	
7.4L	330		454	8	4	1977-1987	4623115 - B816540	-	-	-	-	-	-	8	
7.4L	330 MIE		454	8	4	1977-1980	4623115 - 5779913	-	-	-	-	-	-	8	
7.4L	340 MIE		454	8	4	1981-1987	5889914 - B788365	-	18-4189	-	18-3940	18-3950	18-3941	8	
7.4L	350 MIE		454	8	4	1974-1976	3780450 - 4623109	-	-	-	-	-	-	8	
7.4L	370 TRS		454	8	4	1978-1987	4179554 - B714586	-	-	-	18-3940	18-3950	18-3941	8	
7.4L	390	GM	454	8	4		2781129 - 2825059	-	-	-	18-3940	18-3950	18-3941	8	
7.4L	400 TRS		454	8	4	1980-1986	4179554 - B457644	-	-	-	18-3940	18-3950	18-3941	8	
7.4L	420		454	8	4	1987-1989	A398941 - B6222418	-	-	-	18-3940	18-3950	18-3941	8	
7.4L	425		454	8	4	1990-1992	B622419 - D725499	-	-	-	18-3940	18-3950	18-3941	8	
7.4L	425 GEN V		454	8	4	1992-1993	D725500 - D937011	-	-	-	-	-	-	8	
7.4L	440 TRS		454	8	4	1983-1986	4179554 - B485220	-	-	-	18-3940	18-3950	18-3941	8	
7.4L	450 GEN V		454	8	4	1995-1996	F347100 - F347277	-	-	-	-	-	-	8	
7.4L	454 MAG ALPHA		454	8	4	1986-1988	A631894 - B785148	-	18-4189	-	18-3940	18-3950	18-3941	8	
7.4L	454 MAG BRAVO		454	8	4	1988-1992	D721206 - D805068	-	-	-	-	-	-	8	
7.4L	454 MAG BRAVO GEN V		454	8	4	1992-1996	D805069 - F801699	-	-	-	-	-	-	8	
7.4L	454 MAG BRAVO GEN VI		454	8	4	1996-1997	F801700 - K999999	-	-	-	-	-	-	8	
7.4L	454 MAG EFI GEN V		454	8	4	1994-1996	F115700 - F802349	-	-	-	-	-	-	8	
7.4L	454 MAG EFI SKI GEN V		454	8	4	1995-1996	F215800 - F820099	-	-	-	-	-	-	8	
7.4L	454 MAG MPI GEN VI		454	8	4	1996-2001	F802350 - M0224999	-	-	-	-	-	-	8	
7.4L	454 MAG MPI / 454 MAG HORIZON / 454 MAG MIE		454	8	4	1998-2001	L002200 - L674000	-	-	-	-	-	-	8	
7.4L	454 MAG MPI SKI GEN VI		454	8	4	1996-1997	F820100 - K999999	-	-	-	-	-	-	8	
7.4L	454 MAG BRAVO		454	8	4		B840126 - & Up	-	-	-	18-3940	18-3950	18-3941	8	
470			454	8	4		4208730 - & Up	18-4109	18-4118	18-4134	18-3928	18-3929	-	4	
485			454	8	4		5685394 - & Up	18-4109	18-4118	18-4134	18-3928	18-3929	-	4	
488			454	8	4		6170297 - & Up	18-4109	18-4118	18-4134	18-3928	18-3929	-	4	
525 SC			454	8	4	1991-1992	D456000 - D725808	-	-	-	-	-	-	8	
7.4L	525 SC GEN V		454	8	4	1992-1996	D763746 - F348963	-	-	-	-	-	-	8	
7.4L	525 SC GEN V		454	8	4	1996-1999	F615814 - L415623	-	-	-	-	-	-	8	

- (1) Cast Aluminum (Use with GM Engine Code 1XW)
- (2) Cast aluminum (Use with GM Engine Code 4XW)
- (3) Forged Aluminum (Use with GM Engine Code 3UB)
- (4) Cast Aluminum (Use with GM Engine Code 4XX)
- (5) Cast Aluminum (Use with GM Engine Code 2XY)
- (6) Cast Aluminum (Use with GM Engine Code 4XY)

- (7) Flat Head
 - (8) Forged Aluminum, Recessed Head
 - (9) Starboard
 - (10) Port
 - (11) .010 (25mm)Oversize
- N.L.A. No longer available from O.E. source

PISTON/ RING APPLICATION

Liter	Model	Note	CID	# Cyl	Stroke	Year	Serial Number	PISTONS			RINGS			Qty. Eng.	
								Std.	Note	0.02	0.03	Note	Std.		0.02
7.4L	7.4L BRAVO		454	8	4	1988-1991	B771113 - D603117	-	-	-	-	-	-	8	
7.4L	7.4L BRAVO I GEN V / 7.4L BRAVO II GEN V		454	8	4	1992-1995	D603118 - F800699	-	1	-	-	-	-	8	
7.4L	7.4L BRAVO I GEN V / 7.4L BRAVO II GEN V		454	8	4	1992-1996	D603118 - F800699	-	2	-	-	-	-	8	
7.4L	7.4L BRAVO III GEN V		454	8	4	1992-1995	D603118 - F800699	-	3	-	-	-	-	8	
7.4L	7.4L BRAVO III GEN V		454	8	4	1992-1996	D603118 - F800699	-	4	-	-	-	-	8	
7.4L	7.4L BRAVO GEN VI		454	8	4	1996-1997	F800700 - K999999	-	-	-	-	-	-	8	
7.4L	7.4L EFI GEN VI / 7.4L MIE GEN VI / 7.4L GEN VI MIE		454	8	4	1996-1997	F874815 - K999999	-	-	-	-	-	-	8	
7.4L	7.4L MIE W/HURTH		454	8	4	1988-1992	B788366 - D715493	-	-	-	-	-	-	8	
7.4L	7.4L W/HURTH		454	8	4		C391564 - & Up	-	-	18-4189	-	18-3940	18-3950	18-3941	8
7.4L	7.4L MIE GEN V		454	8	4	1992-1995	D715494 - F820141	-	5	-	-	-	-	8	
7.4L	7.4L MIE GEN V		454	8	4	1992-1996	D715494 - F820141	-	5	-	-	-	-	8	
7.4L	7.4L MIE GEN VI		454	8	4	1996-1997	F820142 - K999999	-	-	-	-	-	-	8	
7.4L	7.4L MPI GEN VI		454	8	4	1998-2001	L010003 - M024330	-	-	-	-	-	-	8	
7.4L	7.4L MPI GEN V / 7.4L MIE GEN V		454	8	4	1995-1996	F563052 - F820103	-	-	-	-	-	-	8	
7.4L	7.4L MPI GEN VI / 7.4L MIE GEN VI / 7.4LH GEN VI		454	8	4	1996-1997	F820104 - K999999	-	-	-	-	-	-	8	
7.4L	7.4L MPI L-29 GEN VI / 7.4L MIE L-29 GEN VI		454	8	4	1998-2001	L002006 - M025999	-	-	-	-	-	-	8	
7.4L	7.4LX BRAVO GEN VI / 7.4L BRAVO EFI		454	8	4	1996-1997	F802000 - K999999	-	-	-	-	-	-	8	
7.4L	7.4LX BRAVO GEN V / 7.4L MPI GEN V		454	8	4	1996	F802010 - F801999	-	-	-	-	-	-	8	
7.4L	7.4LX BRAVO GEN VI / 7.4L MPI GEN VI		454	8	4	1996-1997	F802000 - K999999	-	-	-	-	-	-	8	
7.9L	390		482	8	4	1969-1970	2781129 - 2825059	-	-	-	-	-	-	8	
7.9L	460 TRS		482	8	4	1983-1986	4179554 - 6181046	-	-	-	-	-	-	8	
8.1L	496		482	8	4	2001-2010	M025000 & UP	-	9	-	-	-	-	8	
8.1L	496		496	8	4	2001-2010	M025000 & UP	-	10	-	-	-	-	8	
8.2L	465		502	8	4	1990-1992	C849992 - D725646	-	-	-	-	-	-	8	
8.2L	465 GEN V		502	8	4	1992-1994	D725647 - F213244	-	-	-	-	-	-	8	
8.2L	500 GEN V		502	8	4	1994-1996	F213293 - F745159	-	-	-	-	-	-	8	
8.2L	500 GEN VI		502	8	4	1997-1999	K745195 - L601036	-	-	-	-	-	-	8	
8.2L	500 EFI		502	8	4	1999-2005	L001477 - M907127	-	-	-	-	-	-	8	
8.2L	502 MAG BRAVO		502	8	4	1990-1992	C878221 - D824588	-	-	-	-	-	-	8	
8.2L	502 MAG BRAVO GEN V		502	8	4	1992-1993	D824589 - F114528	-	-	-	-	-	-	8	
8.2L	502 MAG EFI		502	8	4	1993-1996	D640650 - F802599	-	-	-	-	-	-	8	
8.2L	502 MAG MPI GEN VI		502	8	4	1996-2001	F802600 - M024999	-	-	-	-	-	-	8	
8.2L	525 EFI		502	8	4	2003-2010	M900146 & UP	-	-	-	-	-	-	8	
8.2L	575 Sci		502	8	4	2001-2005	L306696 - M950526	-	-	-	-	-	-	8	
8.2L	600 SC		502	8	4	1991-1992	D456489 - D456768	-	-	-	-	-	-	8	
8.2L	600 SC GEN V		502	8	4	1992-1996	D725676 - F877642	-	-	-	-	-	-	8	
8.2L	600 SC GEN VI		502	8	4	1997-2000	K000227 - L601186	-	-	-	-	-	-	8	
8.2L	8.2L MAG EC		502	8	4	2010	A350340 & UP	-	-	-	-	-	-	8	
8.2L	8.2L MIE / 8.2L EC		502	8	4	2010	A350802 & UP	-	-	-	-	-	-	8	
8.2L	8.2L MIE W/HURTH		502	8	4	1990-1992	C878221 - D857199	-	-	-	-	-	-	8	
8.2L	8.2L MIE GEN V		502	8	4	1993-1995	D857200 - F819619	-	-	-	-	-	-	8	
8.2L	8.2L MPI GEN VI / 8.2L MIE GEN VI / 8.2LH GEN VI		502	8	4	1996-2001	F819620 - L674200	-	-	-	-	-	-	8	
8.9L	500 BULLDOG		540	8	4	1990-2001	C577254 - M050281	-	-	-	-	-	-	8	
8.9L	575		540	8	4	1986-1992	A677429 - D763716	-	7	-	-	18-3937	18-3939	18-3938	8

- (1) Cast Aluminum (Use with GM Engine Code 1XW)
- (2) Cast aluminum (Use with GM Engine Code 4XW)
- (3) Forged Aluminum (Use with GM Engine Code 3UB)
- (4) Cast Aluminum (Use with GM Engine Code 4XX)
- (5) Cast Aluminum (Use with GM Engine Code 2XY)
- (6) Cast Aluminum (Use with GM Engine Code 4XY)
- (7) Flat Head
- (8) Forged Aluminum, Recessed Head
- (9) Starboard
- (10) Port
- (11) .010 (25mm) Oversize

N.L.A. No longer available from O.E. source

N.L.A. No longer available from O.E. source

 <p>ROD BEARINGS</p> <table border="1" style="width: 100%; border-collapse: collapse;"> <thead> <tr> <th>Part #</th> <th>Size</th> <th>Replaces Mercuriser:</th> </tr> </thead> <tbody> <tr><td>18-1148</td><td>Std.</td><td>68704A1</td></tr> <tr><td>18-1308</td><td>Std.</td><td>23-85701</td></tr> <tr><td>18-1309</td><td>.010</td><td>23-85704</td></tr> <tr><td>18-1327</td><td>Std.</td><td>23-11992</td></tr> <tr><td>18-1329</td><td>Std.</td><td>23-85677</td></tr> <tr><td>18-1333</td><td>.010</td><td>23-85691</td></tr> <tr><td>18-1334</td><td>Std.</td><td>23-85726</td></tr> <tr><td>18-1337</td><td>.010</td><td>23-811858</td></tr> <tr><td>18-1341</td><td>.020</td><td>23-85705</td></tr> </tbody> </table>	Part #	Size	Replaces Mercuriser:	18-1148	Std.	68704A1	18-1308	Std.	23-85701	18-1309	.010	23-85704	18-1327	Std.	23-11992	18-1329	Std.	23-85677	18-1333	.010	23-85691	18-1334	Std.	23-85726	18-1337	.010	23-811858	18-1341	.020	23-85705	 <p>MAIN BEARINGS</p> <table border="1" style="width: 100%; border-collapse: collapse;"> <thead> <tr> <th>Part #</th> <th>Per Eng.</th> <th>Size</th> <th>Replaces Mercuriser:</th> <th>Part #</th> <th>Per Eng.</th> <th>Size</th> <th>Replaces Mercuriser:</th> </tr> </thead> <tbody> <tr> <td>18-1300</td> <td>①</td> <td>Std.</td> <td>23-818465</td> <td>18-1316</td> <td>①</td> <td>.010</td> <td>23-818471</td> </tr> <tr> <td>18-1311</td> <td>①</td> <td>Std.</td> <td>23-801793</td> <td>18-1317</td> <td>①</td> <td>Std.</td> <td>23-818469</td> </tr> <tr> <td>18-1315</td> <td>①</td> <td>Std.</td> <td>23-818473</td> <td></td> <td></td> <td></td> <td></td> </tr> </tbody> </table>	Part #	Per Eng.	Size	Replaces Mercuriser:	Part #	Per Eng.	Size	Replaces Mercuriser:	18-1300	①	Std.	23-818465	18-1316	①	.010	23-818471	18-1311	①	Std.	23-801793	18-1317	①	Std.	23-818469	18-1315	①	Std.	23-818473					 <p>CAM BEARINGS</p> <table border="1" style="width: 100%; border-collapse: collapse;"> <thead> <tr> <th>Part #</th> <th>Per Eng.</th> <th>Replaces Mercuriser:</th> </tr> </thead> <tbody> <tr> <td>18-1339</td> <td>1 ①</td> <td>23-43293</td> </tr> </tbody> </table>	Part #	Per Eng.	Replaces Mercuriser:	18-1339	1 ①	23-43293
Part #	Size	Replaces Mercuriser:																																																																				
18-1148	Std.	68704A1																																																																				
18-1308	Std.	23-85701																																																																				
18-1309	.010	23-85704																																																																				
18-1327	Std.	23-11992																																																																				
18-1329	Std.	23-85677																																																																				
18-1333	.010	23-85691																																																																				
18-1334	Std.	23-85726																																																																				
18-1337	.010	23-811858																																																																				
18-1341	.020	23-85705																																																																				
Part #	Per Eng.	Size	Replaces Mercuriser:	Part #	Per Eng.	Size	Replaces Mercuriser:																																																															
18-1300	①	Std.	23-818465	18-1316	①	.010	23-818471																																																															
18-1311	①	Std.	23-801793	18-1317	①	Std.	23-818469																																																															
18-1315	①	Std.	23-818473																																																																			
Part #	Per Eng.	Replaces Mercuriser:																																																																				
18-1339	1 ①	23-43293																																																																				
<p>① Complete engine set</p>																																																																						

HP	Liter	Model	Note	CID	# Cyl	Stroke	Year	Serial Number	ROD BEARING			MAIN BEARING			CAM BEARING
									Std.	0.01	0.02	Std.	0.01	0.02	
100		100 VASER		98	4	4	2007-2010	W995000 & UP	-	-	-	-	-	-	-
120		120		153	4	4	1964-1986	1666601 - B531853	18-1329	-	-	-	-	-	-
120	2.5L	120/2.5L		153	4	4	1987-1989	B531854 - C853255	18-1329	18-1330	-	18-1317	18-1316	-	18-1339
140		140		181	4	4	1968-1986	2508261 - B450800	18-1308	18-1309	18-1341	18-1317	18-1316	-	18-1331
140		140		181	4	4		3462608 - 5157668	18-1308	18-1309	18-1341	18-1317	18-1316	-	18-1339
140		140		181	4	4		5157669 - 6229717	18-1308	18-1309	18-1341	18-1317	18-1316	-	18-1339
140	3.0L	140 / 3.0L		181	4	4		6229718 & Up	18-1308	18-1309	18-1341	18-1317	18-1316	-	18-1339
	3.0L	3.0L		181	4	4	1987-1989	B450801 - C856558	18-1308	-	-	-	-	-	-
	3.0L	3.0L		181	4	4	1990-1994	C856559 - F603999	18-1308	18-1309	18-1341	18-1317	18-1316	-	18-1339
	3.0L	3.0L		181	4	4	1998-1999	L010042 - L605541	18-1308	-	-	-	-	-	-
	3.0L	3.0L		181	4	4	2000-2010	L605542 & UP	-	-	-	-	-	-	-
	3.0L	3.0L MPI		181	4	4	2008-2010	A07282 & UP	-	-	-	-	-	-	-
	3.0L	3.0LX		181	4	4	1990-1997	C856559 - K999999	18-1308	-	18-1341	-	-	-	-
		165		224	4	4	1987	B434941 - B774251	-	-	-	-	-	-	-
		170		224	4	4	1985-1986	6916779 - B434940	-	-	-	-	-	-	-
		180		224	4	4	1987	B436391 - B775248	-	-	-	-	-	-	-
		190		224	4	4	1985-1986	6916779 - B436390	-	-	-	-	-	-	-
	3.7L	3.7L		224	4	4	1988-1989	B774252 - C762299	-	-	-	-	-	-	-
	3.7L	3.7LX		224	4	4	1988-1989	B775249 - C762299	-	-	-	-	-	-	-
		470		224	4	4	1976-1984	4208730 - 6916778	-	-	-	-	-	-	-
		485		224	4	4	1980-1982	5685394 - 6218036	-	-	-	-	-	-	-
		488		224	4	4	1983-1984	6170297 - 6916778	-	-	-	-	-	-	-
		140		6	4			1538930 - 1725960	18-1329	18-1330	-	-	-	-	-
		150			4			1666495 - 2048046	18-1329	18-1330	-	-	-	-	-
		160		250	6	4	1967-1969	2048022 - 2770031	18-1329	18-1330	-	-	18-1320	-	-
		165		250	6	4	1970-1981	2770032 - 5813433	18-1329	18-1330	-	-	18-1320	-	-
	4.3L	175 / 4.3L		262	6	4		B527955 & Up	18-1327	18-1337	18-1338	18-1311	-	-	-
		185	4bbl	229	6	4	1983-1984	6330183 - 6919655	-	-	-	-	-	-	-
		175		262	6	4	1987	B527955 - B773242	-	-	-	-	-	-	-
		185	2bbl	262	6	4	1985-1986	A331455 - B527954	-	-	-	-	-	-	-
		205		262	6	4	1985-1986	A331455 - B527954	-	-	-	18-1300	-	-	-
	4.3L	262 MAG / 262 EFI / 262 GEN +		262	6	4	1996-1997	F803800 - K999999	-	-	-	-	-	-	-
	4.3L	4.3L GEN II		262	6	4	1992-1996	D714107 - F802999	18-1327	18-1337	18-1338	18-1311	-	-	-
	4.3L	4.3L GEN +		262	6	4	1998-2010	L010044 & UP	-	-	-	-	-	-	-
	4.3L	4.3L EFI / 4.3L GEN +		262	6	4	1998-2001	L012009 - M299999	-	-	-	-	-	-	-
	4.3L	4.3L MPI		262	6	4	2002-2010	M3000000 & UP	-	-	-	-	-	-	-
	4.3L	4.3LH GEN +		262	6	4	1998-2002	L010044 - M614999	-	-	-	-	-	-	-
	4.3L	4.3LX		262	6	4	1988-1991	B775130 - D714369	-	-	-	-	-	-	-
	4.3L	4.3LX GEN II		262	6	4	1992-1996	D714370 - F802999	-	-	-	-	-	-	-
	4.3L	4.3LX GEN +		262	6	4	1996-1997	F803000 - K999999	-	-	-	-	-	-	-
	4.3L	4.3LXH GEN +		262	6	4	1996-1997	F803114 - K999999	-	-	-	-	-	-	-
		185		262	6	4		A331455 & Up	18-1327	18-1337	18-1338	18-1311	-	-	-
		205		262	6	4		A331455 & Up	18-1327	18-1337	18-1338	18-1311	-	-	-
	4.3L	205 / 4.3L / 4.3LX LX		262	6	4		B527955 & Up	18-1327	18-1337	18-1338	18-1311	-	-	-
		4.3LX GEN II		262	6	4		D714370 & Up	18-1327	18-1337	18-1338	18-1311	-	-	-
		190	GM	283	8	4	1963-1964	1564539 - 1730903	18-1329	18-1330	-	-	-	-	-
		200						2453769 - 2712072	18-1308	18-1309	18-1341	18-1317	18-1316	-	-
		200	GM			4		6218462 & Up	18-1308	18-1309	18-1341	18-1300	-	-	-
	5.0L	500			8	4		B525982 & Up	18-1308	18-1309	18-1341	18-1300	-	-	-
	5.0L	215	FORD	302	8	4		2781153 - 3395720	18-1336	-	-	-	-	-	-
	5.0L	225	FORD	302	8	4	1973-1974	3385721 - 4166999	18-1329	18-1330	-	-	-	-	-
	5.0L	225 S	FORD	302	8	4	1973-1974	3385721 - 4166999	-	-	-	-	-	-	-
	5.0L	225	GM		8	4		1536920 - 2278646	18-1329	18-1330	-	-	-	-	-
	5.0L	225	GM		8	4		2278647 - 2399397	18-1329	18-1330	-	18-1317	18-1316	-	-
	5.0L	225	GM		8	4		2399398 & Up	18-1308	18-1309	18-1341	18-1300	-	-	-
	5.0L	225	GM		8	4		4765100 & Up	18-1308	18-1309	18-1341	18-1300	-	-	-
	5.0L	888		302	8	4	1971-1977	3108723 - 4887829	-	-	-	-	-	-	-
		190		283	8	4	1963-1964	1564539 - 1730903	18-1329	-	-	-	-	-	-
	5.0L	198 MIE		305	8	4	1977	4776402 - 4931099	18-1308	-	-	-	-	-	-
	5.0L	200		305	8	4	1985-1987	6899058 - B774444	18-1308	-	-	-	-	-	-
	5.0L	228		305	8	4	1977-1984	4765100 - 6899268	18-1308	-	-	-	-	-	-
	5.0L	228 MIE		305	8	4	1977-1980	4765100 - 5907057	18-1308	-	-	-	-	-	-
	5.0L	230		305	8	4	1985-1987	6899269 - B773739	18-1308	-	-	-	-	-	-
	5.0L	230	GM	305	8	4	1981-1987	5907058 - B788151	18-1308	18-1309	18-1341	18-1300	-	-	-
	5.0L	5.0L		305	8	4	1988-1995	B774445 - F600999	18-1308	-	-	-	-	-	-
	5.0L	5.0L GEN +		305	8	4	1998-2010	L015751 & UP	18-1308	-	-	-	-	-	-
	5.0L	5.0L EFI GEN +		305	8	4	1998-2001	L012052 - M299999	18-1308	-	-	-	-	-	-
	5.0L	5.0L MIE		305	8	4	1988	B788152 - C396832	18-1308	-	-	-	-	-	-
	5.0L	5.0L MPI		305	8	4	2002-2010	M3000000 & UP	18-1308	-	-	-	-	-	-
	5.0L	5.0LX		305	8	4	1988-1995	B773740 - F600999	18-1308	-	-	-	-	-	-
	5.0L	230 / 5.0L	GM	305	8	4		B522506 & Up	18-1308	18-1309	18-1341	18-1300	-	-	-
		230	GM		8	4		6218462 & Up	18-1308	18-1309	18-1341	18-1300	-	-	-
	5.0L	230 / 5.0L / 5.0LX	GM	305	8	4		B525982 & Up	18-1308	18-1309	18-1341	18-1300	-	-	-
	5.0L	898		305	8	4	1977-1984	4762210 - 6899057	18-1308	-	-	-	-	-	-
		225	GM	327	8	4	1963-1967	1539620 - 2399397	18-1329	-	-	-	-	-	-
		225	GM	327	8	4	1968-1969	2399398 - 2694014	18-1308	-	-	-	-	-	-

HP	Liter	Model	Note	CID	# Cyl	Stroke	Year	Serial Number	ROD BEARING			MAIN BEARING			CAM BEARING
									Std.	0.01	0.02	Std.	0.01	0.02	
		250		327	8	4	1968-1969	2314301 - 2639854	18-1308	18-1309	18-1341	18-1300	-	-	-
5.7L		250		350	8	4	1977	4768000 - 4908849	18-1308	18-1309	18-1341	18-1300	-	-	-
5.7L		255	GM	350	8	4	1975-1976	4175500 - 4767999	18-1308	18-1309	18-1341	18-1300	-	-	-
5.7L		255 MIE		350	8	4	1975-1980	4175500 - 5907057	18-1308	-	-	-	-	-	-
5.7L		260	GM	350	8	4	1978-1987	4908850 - B773304	18-1308	18-1309	18-1341	18-1300	-	-	-
5.7L		260 MIE		350	8	4	1981-1987	5907058 - B788151	18-1308	18-1309	18-1341	-	-	-	-
5.7L		260 / 5.7L	GM	350	8	4		B525982 & Up	18-1308	18-1309	18-1341	18-1300	-	-	-
5.7L		260 / 5.7L	GM	350	8	4		B522506 & Up	18-1308	18-1309	18-1341	18-1300	-	-	-
5.7L		270	GM	350	8	4	1969-1972	2851074 - 3077735	18-1308	18-1309	18-1341	18-1300	-	-	-
5.7L		280	GM	350	8	4	1975-1976	4176250 - 4770199	18-1308	18-1309	18-1341	18-1300	-	-	-
5.7L		300	GM	350	8	4	1985-1986	6668677 - B430367	18-1308	18-1309	18-1341	18-1300	-	-	-
5.7L		320 EFI	GM	350	8	4	1987-1989	A543604 - C622418	18-1308	18-1309	18-1341	18-1300	-	-	-
5.7L		320 EFI BRAVO	GM	350	8	4		B157603 & Up	18-1308	18-1309	18-1341	18-1300	-	-	-
		325 GM		8	4			2278747 & Up	18-1334	18-1333	18-1332	18-1315	-	-	-
		330 GM		8	4			4623115 & Up	18-1334	18-1333	18-1332	18-1315	-	-	-
		330 W.B.W.	GM	8	4			6083045 & Up	18-1334	18-1333	18-1332	18-1315	-	-	-
7.4L		340 / 7.4L	GM	8	4			5889914 & Up	18-1334	18-1333	18-1332	18-1315	-	-	-
5.7L		350 MAG ALPHA		350	8	4	1986-1997	A635178 - K999999	18-1308	18-1309	18-1341	18-1300	-	-	-
5.7L		350	GM	350	8	4		3780450 & Up	18-1334	18-1333	18-1332	18-1315	-	-	-
5.7L		350 MAG / 350 ALPHA / 350 EFI / 350 GEN +		350	8	4	1996-1997	F800300 - K999999	18-1308	-	-	-	-	-	-
5.7L		350 MAG / 350 BRAVO / 350 MPI		350	8	4	1995	F415189 - F601999	18-1308	-	-	-	-	-	-
5.7L		350 MAG / 350 BRAVO / 350MPI / 350 GEN +		350	8	4	1996-1997	F602000 - K999999	18-1308	-	-	-	-	-	-
5.7L		350 MAG SKI		350	8	4	1994-1996	F215561 - F820706	18-1308	-	-	-	-	-	-
5.7L		350 MAG EFI SKI GEN +		350	8	4	1996-1997	F820707 - K999999	18-1308	-	-	-	-	-	-
5.7L		350 MAG MPI GEN +		350	8	4	1988-2010	L010019 & UP	18-1308	-	-	-	-	-	-
5.7L		350 MAG MPI / 350 MAG MIE GEN +		350	8	4	1998-2007	L002008 - A089999	18-1308	-	-	-	-	-	-
5.7L		350MG / 350 MPI / 350 SKI		350	8	4	1995-1996	F350583 - F799999	18-1308	-	-	-	-	-	-
5.7L		350 MAG / 350 MPI / 350 SKI / 350 GEN +		350	8	4	1998-2007	L002600 - A089999	18-1308	-	-	-	-	-	-
5.7L		350 MAG SKI		350	8	4	1991-1997	D505450 - K999999	18-1308	-	-	-	-	-	-
5.7L		5.7L		350	8	4	1988-1997	4908850 - F600999	18-1308	-	-	-	-	-	-
5.7L		5.7L GEN +		350	8	4	1998-2010	L010037 & UP	18-1308	-	-	-	-	-	-
5.7L		5.7L EFI		350	8	4	1995-1997	F225560 - K999999	18-1308	-	-	-	-	-	-
5.7L		5.7L EFI GEN +		350	8	4	1998-2001	L010035 - M2999999	18-1308	-	-	-	-	-	-
5.7L		5.7L EFI MIE GEN +		350	8	8	1997	K040300 - K999999	18-1308	-	-	-	-	-	-
5.7L		5.7L MIE		350	8	4	1988-1997	B788152 - K999999	18-1308	-	-	-	-	-	-
5.7L		5.7L MIE GEN +		350	8	4	1998-2010	L002003 & UP	18-1308	-	-	-	-	-	-
5.7L		5.7L MPI / 5.7L MIE		350	8	4	2008-2010	A090000 & UP	18-1308	-	-	-	-	-	-
5.7L		5.7L MPI SKI		350	8	4	2008-2010	A090000 & UP	18-1308	-	-	-	-	-	-
5.7L		5.7L SKI		350	8	4	1985-1987	A338553 - K999999	18-1308	-	-	-	-	-	-
5.7L		5.7L SKI GEN +		350	8	4	1998-2010	L002005 & UP	18-1308	-	-	-	-	-	-
5.7L		5.7LX		350	8	4	1996-1997	F601000 - F600999	18-1308	-	-	-	-	-	-
5.7L		5.7LX / 5.7LX BRAVO / 5.7LX EFI / 5.7LX GEN +		350	8	4	1996-1997	F800300 - K999999	18-1308	-	-	-	-	-	-
5.7L		5.7L EFI		350	8	4	1996-1997	F752400 - K999999	18-1308	-	-	-	-	-	-
5.7L		BLACK SCORPION SKI GEN +		350	8	4	1996-2006	F800000 - W689999	18-1308	-	-	-	-	-	-
5.7L		BLACK SCORPION SKI GEN +		350	8	4	2003-2007	W690000 - W698432	-	①	①	-	-	-	-
5.7L		SCORPION 350		350	8	4	2008-2010	W698433 & UP	-	①	①	-	-	-	-
		233		351	8	4	1975-1974	4173000 - 4902304	-	-	-	-	-	-	-
		255	FORD	351	8	4	1973-1974	3258728 - 4175499	-	-	-	-	-	-	-
		TOURNEY SKI		8	4			D505450 & Up	18-1308	18-1309	18-1341	18-1300	-	-	-
		370 TRS	GM	8	4			6721528 & Up	18-1334	18-1333	18-1332	18-1315	-	-	-
		377 MAG		377	8	4	2008-2010	A3000000 & UP	-	①	①	-	-	-	-
		377 SCORPION MCM		377	8	4	1999-2005	L416145 - M907201	-	①	①	-	-	-	-
		377 SCORPION SKI GEN +		377	8	4	1997-1998	K000656 - L600314	-	①	①	-	-	-	-
6.2L		MX 6.2L MPI		377	8	4	2000-2007	L680003 - A299999	-	①	①	-	-	-	-
6.2L		MX 6.2L MPI / MX 6.2L HORIZON		377	8	4	2002-2007	M3000000 - A299999	-	①	①	-	-	-	-
6.2L		MX 6.2L MPI / MX 6.2L HORIZON / MX 6.2L MIE		377	8	4	2002-2010	M3000000 & UP	-	①	①	-	-	-	-
6.2L		MX 6.2L MPI / MX 6.2L MIE		377	8	4	2002-2010	M3000000 & UP	-	①	①	-	-	-	-
6.2L		MX 6.2L BLACK SCORPION SKI		377	8	4	2002-2007	M3000000 - W698432	-	①	①	-	-	-	-
6.2L		SCORPION 377		377	8	4	2008-2010	W698433 & UP	-	①	①	-	-	-	-
7.4L		325		454	8	4	1969-1972	2278747 - 3780449	-	-	-	-	-	-	-
7.4L		330		454	8	4	1977-1987	4623115 - B816540	-	-	-	-	-	-	-
7.4L		330 MIE		454	8	4	1977-1980	4623115 - 5889913	-	-	-	-	-	-	-
7.4L		340 MIE W/B-W		454	8	4	1981-1987	5889914 - B788365	-	-	-	-	-	-	-
7.4L		350 MIE		454	8	4	1974-1976	3780450 - 4623109	-	-	-	-	-	-	-
7.4L		370 TRS		454	8	4	1978-1987	4179554 - B714586	-	-	-	-	-	-	-
		390	GM	8	4			2781129 - 2825059	18-1334	18-1333	18-1332	18-1315	-	-	-
7.4L		400 TRS		454	8	4	1980-1986	4179554 - B457644	-	-	-	-	-	-	-
7.4L		420	GM	454	8	4	1987-1989	A398941 - B622418	18-1334	18-1333	18-1332	18-1315	-	-	-
7.4L		425	GM	454	8	4	1990-1992	B622419 - D725499	-	-	-	18-1315	-	-	-
7.4L		425 GEN V		454	8	4	1992-1993	D725500 - D937011	-	-	-	-	-	-	-
7.4L		440 TRS		454	8	4	1983-1986	4179554 - B485220	-	-	-	-	-	-	-
7.4L		450 GEN V		454	8	4	1995-1996	F347100 - F347277	-	-	-	-	-	-	-
7.4L		454 MAG ALPHA	GM	454	8	4	1986-1988	A631894 - B785148	18-1334	18-1333	18-1332	18-1315	-	-	-
7.4L		454 MAG BRAVO		454	8	4	1988-1992	B721206 - D805068	-	-	-	-	-	-	-
7.4L		454 MAG BRAVO	GM	454	8	4		B840126 & UP	18-1334	18-1333	18-1332	18-1315	-	-	-

① 8 PAIR BEARING SET

HP	Liter	Model	Note	CID	# Cyl	Stroke	Year	Serial Number	ROD BEARING			MAIN BEARING			CAM BEARING
									Std.	.01	.02	Std.	.01	.02	
7.4L	454	MAG BRAVO GEN V		454	8	4	1992-1996	D805069 - M801699	18-1334	18-1333	18-1332	18-1315	-	-	-
7.4L	454	MAG BRAVO GEN VI		454	8	4	1996-1997	F801700 - K999999	-	-	-	-	-	-	-
7.4L	454	MAG EFI GEN V		454	8	4	1994-1996	F115700 - F802349	-	-	-	-	-	-	-
7.4L	454	MAG EFI SKI GEN V		454	8	4	1995-1996	F215800 - F820099	-	-	-	-	-	-	-
7.4L	454	MAG MPI GEN VI		454	8	4	1996-2001	F802350 - M024999	-	-	-	-	-	-	-
7.4L	454	MAG MPI / 454 MAG HORIZON / 454 MAG MIE		454	8	4	1998-2001	L002200 - L674000	-	-	-	-	-	-	-
7.4L	454	MAG MPI / 454 MAG SKI GEN VI		454	8	4	1996-1997	F820100 - K999999	-	-	-	-	-	-	-
7.4L	454	EFI		454	8	4		F115700 & UP	18-1334	18-1333	18-1332	18-1315	-	-	-
	502	MAG	GM		8	4		C878221 & Up	18-1334	18-1333	18-1332	18-1315	-	-	-
	502	MAG BRAVO GEN V			8	4		D824589 & Up	18-1334	18-1333	18-1332	18-1315	-	-	-
	502	MAG BRAVO GEN V			8	4		D840650 & Up	18-1334	18-1333	18-1332	18-1315	-	-	-
	502	EFI			8	4		3108723 & Up	18-1336	-	-	-	-	-	-
	525	SC		454	8	4	1991-1992	D456000 - D725808	-	-	-	-	-	-	-
	525	SC GEN V		454	8	4	1992-1996	D763746 - F745215	-	-	-	-	-	-	-
	525	SC GEN V		454	8	4	1996-1999	F745260 - L415623	-	-	-	-	-	-	-
7.4L	7.4L	BRAVO		454	8	4	1988-1991	B771113 - D603117	-	-	-	-	-	-	-
7.4L	7.4L	BRAVO GEN V		454	8	4	1992-1996	D603118 - F800699	-	-	-	-	-	-	-
7.4L	7.4L	BRAVO GEN VI		454	8	4	1996-1997	F800700 - K299999	-	-	-	-	-	-	-
7.4L	7.4L	EFI / 7.4L MIE GEN VI		454	8	4	1996-1997	F874815 - K999999	-	-	-	-	-	-	-
7.4L	7.4L	MIE		454	8	4	1988-1992	B788366 - D715493	-	-	-	-	-	-	-
7.4L	7.4L	MIE GEN V		454	8	4	1992-1996	D715494 - F820141	-	-	-	-	-	-	-
7.4L	7.4L	LH / 7.4L MIE GEN VI		454	8	4	1996-1997	F820142 - K999999	-	-	-	-	-	-	-
7.4L	7.4L	MPI GEN V		454	8	4	1998-2001	L010003 - M024330	-	-	-	-	-	-	-
7.4L	7.4L	MPI GEN V / 7.4L MIE GEN V		454	8	4	1995-1996	F563052 - F820103	-	-	-	-	-	-	-
7.4L	7.4L	MPI GEN VI / 7.4L MIE GEN VI		454	8	4	1996-1997	F820104 - K999999	-	-	-	-	-	-	-
7.4L	7.4L	MPI GEN VI L29 / 7.4L MIE GEN VI L29		454	8	4	1998-2001	L002006 - M025999	-	-	-	-	-	-	-
7.4L	7.4L	X BRAVO TBI GEN VI		454	8	4	1988-2001	F802000 - K999999	-	-	-	-	-	-	-
7.4L	7.4L	X BRAVO MPI GEN V		454	8	4	1996	F602010 - F801999	-	-	-	-	-	-	-
7.4L	7.4L	X BRAVO MPI GEN VI		454	8	4	1996-1997	F802000 - K999999	-	-	-	-	-	-	-
7.4L	7.4L	BRAVO	GM					D603118 & Up	18-1334	18-1333	18-1332	18-1315	-	-	-
7.4L	7.4L	BRAVO GEN V						C391564 & Up	18-1334	18-1333	18-1332	18-1315	-	-	-
7.4L	7.4L	WHURTH						D715494 & Up	18-1334	18-1333	18-1332	18-1315	-	-	-
7.4L	7.4L	HR GEN V						C878221 & Up	18-1334	18-1333	18-1332	18-1315	-	-	-
	390			482	8	4	1969-1970	2781129 - 2825059	-	-	-	-	-	-	-
	460	TRS		482	8	4	1983-1986	4179554 - 6181046	-	①	①	-	-	-	-
	496	MAG / 496 HO		496	8	4	2001-2010	M025000 & UP	-	-	-	-	-	-	-
	8.1S	MPI / 8.1S MIE / 8.1S HO		496	8	4	2001-2010	M025000 & UP	-	-	-	-	-	-	-
8.2L	465			502	8	4	1990-1992	C849992 - D725646	-	-	-	-	-	-	-
8.2L	465	GEN V		502	8	4	1992-1994	D725647 - F213244	-	-	-	-	-	-	-
8.2L	500	GEN V		502	8	4	1994-1996	F213293 - F745159	-	-	-	-	-	-	-
8.2L	500	GEN VI		502	8	4	1997-1999	K745195 - L601036	-	-	-	-	-	-	-
8.2L	500	EFI		502	8	4	1999-2000	L001477 - L306499	-	-	-	-	-	-	-
8.2L	500	EFI		502	8	4	2000-2005	L306500 - M907127	-	-	-	-	-	-	-
8.2L	502	MAG BRAVO		502	8	4	1990-1992	C878221 - D824588	-	-	-	-	-	-	-
8.2L	502	MAG BRAVO GEN V		502	8	4	1992-1993	D824589 - F114528	-	-	-	-	-	-	-
8.2L	502	MAG EFI		502	8	4	1993-1996	D840650 - F802599	-	-	-	-	-	-	-
8.2L	502	MAG MPI GEN VI		502	8	4	1996-2001	F802600 - M024999	-	-	-	-	-	-	-
8.2L	525	EFI		502	8	4	2003-2007	M900146 - M958499	-	-	-	-	-	-	-
8.2L	525	EFI		502	8	4	2007-2010	M958500 & UP	-	-	-	-	-	-	-
8.2L	575	SCi		502	8	4	20071-2005	L306696 - M950526	-	-	-	-	-	-	-
8.2L	600	SC		502	8	4	1991-1992	D456489 - D456768	-	-	-	-	-	-	-
8.2L	600	SC GEN V		502	8	4	1992-1996	D725676 - F877642	-	-	-	-	-	-	-
8.2L	600	SC GEN VI		502	8	4	1997-2000	K000227 - L601186	-	-	-	-	-	-	-
8.2L	8.2L	MAG		502	8	4	2010	A350340 & UP	-	-	-	-	-	-	-
8.2L	8.2L	MIE		502	8	4	2010	A350802 & UP	-	-	-	-	-	-	-
8.2L	8.2L	MIE WHURTH		502	8	4	1990-1992	C878221 - D857199	-	-	-	-	-	-	-
8.2L	8.2L	WHURTH (IB)		502	8	4		D857200 & Up	18-1334	18-1333	18-1332	18-1315	-	-	-
8.2L	8.2L	MIE GEN V		502	8	4		D857200 - F819619	-	-	-	-	-	-	-
8.2L	8.2L	MPI GEN VI / 8.2L MIE GEN VI / 8.2LH GEN VI		502	8	4	1996-2001	F819620 - L674200	-	-	-	-	-	-	-
	500	BULLDOG		540	8	4	1990-1996	C577254 - F745405	-	①	①	-	-	-	-
	500	BULLDOG		540	8	4	1997-2001	K000248 - M050281	-	①	①	-	-	-	-
	575			540	8	4	1986-1992	A677429 - D763716	-	①	①	-	-	-	-
	800	SC GEN V		540	8	4	1993-1998	D763836 & UP	-	①	-	-	-	-	-
	888		FORD		8	4		4762210 & Up	18-1308	18-1309	18-1341	18-1300	-	-	-
	898 / 198		GM					A338553 & Up	18-1308	18-1309	18-1341	18-1300	-	-	-

① 8 PAIR BEARING SET

MERCURISER 3.7L BEARING APPLICATION

Model	Serial Number	ROD BEARINGS			MAIN BEARINGS			MAIN (THRUST BEARINGS)		
		Std.	.010	.020	Std.	.010	.020	Std.	.010	.020
165V3.7 (4cyl)	6916779 & Up	18-1148	-	-	—	18-1131	-	18-1149	-	-
170 (4cyl)	6916779 & Up	18-1148	-	-	—	18-1131	-	18-1149	-	-
180V3.7L (4cyl)	6916779 & Up	18-1148	-	-	—	18-1131	-	18-1149	-	-
190 (4cyl)	6916779 & Up	18-1148	-	-	—	18-1131	-	18-1149	-	-
470	4208730 & Up	18-1148	-	-	—	18-1131	-	18-1149	-	-
485	5685394 & Up	18-1148	-	-	—	18-1131	-	18-1149	-	-
488	6170297 & Up	18-1148	-	-	—	18-1131	-	18-1149	-	-

 <p>18-0518 VALVE STEM SEAL Replaces: 26-34217</p>	 <p>18-4023 VALVE STEM SEAL Replaces: 26-75413 For: 165, 170, 180, 190 4 cyl. (224 CID) SN 6916779 & later</p>	 <p>18-4022 VALVE STEM SEAL Replaces: 26-75988 For: 330 (SN 4623115 & later), 340 (IB) (SN 5889914 & later), 454 Mag (SN A631894 & later)</p>	<p>PKG. OF 8</p>  <p>18-4024 18-4024-9^② VALVE STEM SEAL Replaces: 26-97664</p>
 <p>One Piece Rear Main Seals</p> <p>18-1234 Replaces: 26-811554 For: 7.4L, GL, GI, GSI: 8.2L, GL</p> <p>18-0519 Replaces: 26-14240 4.3L/3.0L/5.0L 5.7L</p> <p>18-0864 Replaces: 26-90925</p>	 <p>Two Piece Rear Main Seals</p> <p>18-0528 Replaces: 26-56868</p> <p>18-1211 Replaces: 26-58203</p>	 <p>Timing Cover Seals</p> <p>18-1213 Replaces: 26-79223, 26-97335, 26-59341</p> <p>18-1233 Replaces: 26-8219471</p> <p>18-0578 Replaces: 26-67388</p>	

MERCURUISER SEAL APPLICATION

Model	Serial No.	Rear Main Crankshaft Seal	Timing Cover Seal
120/2.5L	1666601 & UP	—	18-1213
120/2.5L	2786857 & UP	18-1211	18-1213
140/3.0L & LX	2508261 & UP	—	18-1213
140/3.0L & LX	6229718 & UP	18-1211	18-1213
150/160/165/200 (I/L-6)	1666495 & UP	—	18-1213
150/160/165/200 (I/L-6)	2770032 & UP	18-1211	18-1213
175/185/205/262/4.3L (V-6)	6330183 & UP	18-1211	18-1213
200/228/225/230/250/255/260/270			
280/300/320/5.0L/5.7L/898(V-8)	2453769 & UP	18-1211 ^①	18-1213
215	2781153 & UP	18-0528	—
224I/L4	ALL	18-0864	18-0578
225 FORD	3885721 & UP	18-0528	—
5.0L/5.7L, 4.3L, 3.0L Std. Rotation	"All" one piece seal	18-0519	18-1213
340 (7.4L)	4623115 & UP	—	18-1233
370 TRS	5889914 & UP	—	18-1233
400 TRS	4179554 & UP	—	18-1233
420	A398941 & UP	—	18-1233
440 TRS	4179554 & UP	—	18-1233
454 MAGNUM	A631894 & UP	—	18-1233
460 TRS	4179554 & UP	—	18-1233
7.4L/8.2L/454/502 Std. Rotation	"All" one piece seal	18-1234	18-1233
7.4 BRAVO	B771113 & UP	—	18-1233
888 (188)	3108723 & UP	18-0528	—

① Lrg. Journal Crankshaft GM Engines

② Priced per Package



MANIFOLD & EXHAUST MANIFOLD GASKET SETS



18-0403
INTAKE GASKET KIT
 Replaces: 27-805722A1
 For: MCM 370, 400, 325, 454, 502 Mag, 7.4L Bravo II & MIE 8.2L1978-1997



18-0404
INTAKE GASKET KIT
 Replaces: 27-805403A1
 For: MCM/MIE 454 Mag MPI, 7.4L/LX MPI & 8.2L MPI 1993-UP



18-0603
EXHAUST MANIFOLD GASKET SET
 For: Ford 302/351 CID Engines
 For use with 18-1998-1

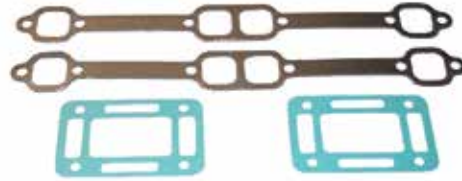

18-0604
EXHAUST MANIFOLD GASKET SET
 For: GM 305/350 CID Engines
 For use with 18-1997-1



18-4347-1
EXHAUST MANIFOLD GASKET SET
 For: GM 175, 185, 205 (229 & 262 CID)



18-4348
EXHAUST MANIFOLD GASKET SET
 For: GM 454, 525 (7.4L & 8.2L)

— CONTAINS —

— CONTAINS —

Part #	Description	O.E. #	Qty.
18-0897	Exhaust Elbow Mounting Gasket	27-41813-1	2
18-2909	Exhaust Manifold to Cyl. Head Gasket	27-99757	2

Part #	Description	O.E. #	Qty.
18-0418	Manifold to Cylinder Head Gasket	27-46820	2
18-0897	Exhaust Elbow Mounting Gasket	27-41813-1	2



18-4408
INTAKE MANIFOLD GASKET SET
 Replaces: 27-11977
 For: GM 262 CID Engines 175, 185 and 205 HP



18-4349
EXHAUST MANIFOLD GASKET SET
 For: GM 200, 228, 230, 260, 898 (5.0 & 5.7L)

— CONTAINS —

Part #	Description	O.E. #	Qty.
18-0872	Exhaust Manifold Gasket	27-33395	2
18-0897	Exhaust Elbow Mounting Gasket	27-41813-1	2

Part #	Description	O.E. #	Qty.
18-0872	Exhaust Manifold Gasket	27-33395	2
18-0897	Exhaust Elbow Mounting Gasket	27-41813-1	2

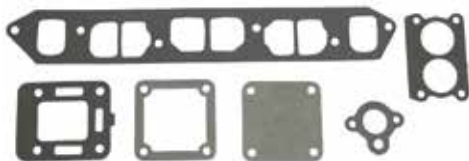

18-4367
EXHAUST MANIFOLD GASKET SET
 Replaces: 27-99777A1
 For: GM 153 & 181 (2.5 & 3.0L) CID Eng's; 120 & 140 HP S/N 6229718 & UP
 (With Siamese Port Cylinder Heads)

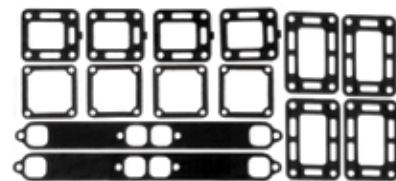

18-4394
EXHAUST MANIFOLD GASKET SET
 Replaces: 27-33395A2
 For: GM 350 (5.7L) CID Eng; 250 HP S/N 4768000-4908849 255 HP S/N 5195909 & UP

— CONTAINS —

Part #	Description	O.E. #	Qty.
18-2832	Manifold End Cap Gasket	27-48043	4
18-2833	Exhaust Elbow Gasket	27-99777-2	4
18-0872	Exhaust Manifold Gasket	27-33395	2
18-0885	Exhaust Elbow Gasket	27-48042	4

Part #	Description	O.E. #	Qty.
18-2832	Manifold End Cap Gasket	27-48043	4
18-2833	Exhaust Elbow Gasket	27-99777-2	4
18-0872	Exhaust Manifold Gasket	27-33395	2
18-0885	Exhaust Elbow Gasket	27-48042	4

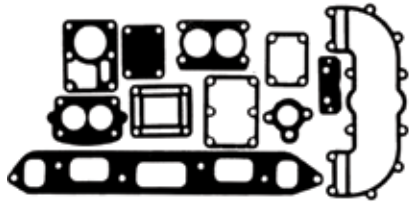

18-4395
EXHAUST MANIFOLD GASKET SET
 Replaces: 27-35898A-4
 For: GM 153 (2.5L) CID Eng;
 120 HP S/N 2046625-6229717

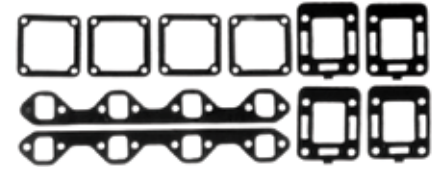

18-4399
EXHAUST MANIFOLD GASKET SET
 Replaces: 27-54566A1
 For: Ford 302/351 (5.0L & 5.8L) CID Eng; All 888 (188 HP)
 & 233 HP, 255 HP S/N 3258728-4175498
 — CONTAINS —

Part #	Description	O.E. #	Qty.
18-0183	Exhaust Mounting Gasket	27-46820	2
18-2832	Manifold End Cap Gasket	27-48043-1	4
18-2833	Exhaust Elbow to Gasket	27-99777-2	4



18-4397
EXHAUST MANIFOLD GASKET SET
 Replaces: 27-46820A1
 For: GM 454 (7.4L) CID Eng; All 325, 350, 400 HP Jet Drives 330 HP S/N 6083144 & BELOW
 — CONTAINS —

Part #	Description	O.E. #	Qty.
18-0418	Exhaust Mounting Gasket	27-46820	2
18-0885	Exhaust Elbow Mounting Gasket	27-48042	4
18-2832	Manifold End Cap Gasket	27-48043-1	4

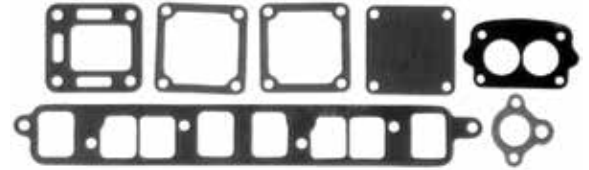

18-4398
EXHAUST MANIFOLD GASKET SET
 Replaces: 27-53354A1
 For: GM 181 (3.0L) CID Eng; 140 HP S/N 3332137-6229717
 (Without Siamese Port Cylinder)

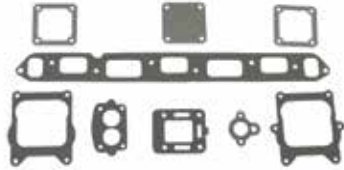

18-4396
EXHAUST MANIFOLD GASKET SET
 Replaces: 27-46401A1
 For: 250 (4.1L) CID Eng; 165 HP S/N 2770032 & UP
 — CONTAINS —

Part #	Description	O.E. #	Qty.
18-2830	Intake Exhaust Gasket	27-46401	1
18-2831	Thermostat Gasket	27-47590-1	1
18-2832	Manifold End Cap Gasket	27-48083-1	2
18-2833	Exhaust Elbow Gasket	27-99777-2	1
18-0353	Carb. Mounting Gasket	27-58764	1
18-0356	Carb. Mounting Gasket	27-64692	1
18-0928	Exhaust End Cap Gasket	27-73814	1



18-4376
TIMING CHAIN GASKET SET
 Replaces: 27-34895A2
 For: GM 305 & 350 CID Eng. 200, 225,
 228, 230, 250, 255, 260, 270, 280 HP 898
 (198 HP) & 5.7L (SKI)
 — CONTAINS —

Part #	Description	O.E. #	Qty.
18-0976	Seal Retainer Cover Gasket	27-14250	1
18-0889	Fuel Pump Mounting Gasket	27-34213	1
18-0891	Water Pump Mounting Gasket	27-34897	2
18-0876	Fuel Pump Mounting Gasket	27-34898	1
18-0893	Water Pump Back. Plate Gasket	27-35380	1
18-0185	Oil Filter & Adapter Seal	27-91892	1
18-0331	Vent Adapter Screw Gasket	27-35593	1

CYLINDER HEAD AND INTAKE MANIFOLD GASKET SETS



18-4383
 For: GM 153 (2.5L) CID Eng;
 S/N 2324347 & UP Includes 18-3880 Head Gasket

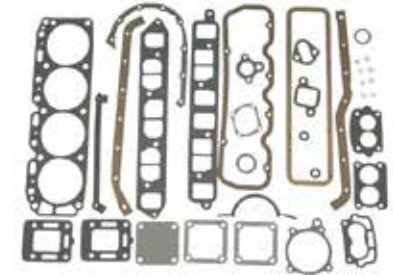

18-4384
 For: GM 181 (3.0L) CID Eng;
 S/N 2508261-6229717 (Except 3.0LX)

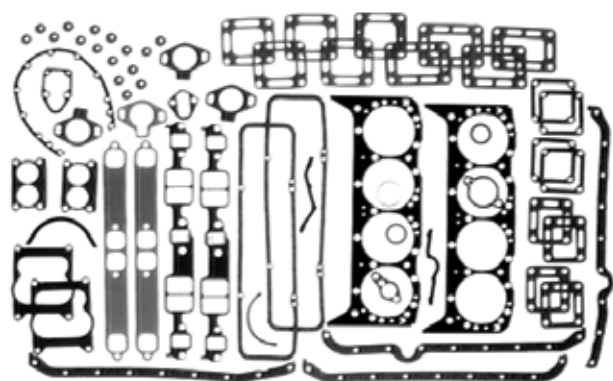

18-4386
 For: GM 305 & 350 (5.0L & 5.7L) CID Eng; With Heads (1987 & Earlier)

— CONTAINS —

Part #	Description	O.E. #	Qty.
18-0976	Timing Chain Cover Gasket	27-14250	1
18-0868	Intake Manifold Gasket	27-17145	1
18-0872	Exhaust Manifold Gasket	27-33395	2
18-0897	Exhaust Elbow Mounting Gasket	27-41813	2
18-0885	Exhaust Elbow Mounting Gasket	27-48042	4
18-2917	Lower Thermostat Housing Gasket	27-53045-1	1
18-0153	Port Dip Gasket	27-85817A1	1
18-2848	Quadrajel Base Gasket	27-58457-2	2
18-2849	Exhaust Elbow To Manifold Gasket	27-87105-1, 27-818832	4
18-3876	Head Gasket	27-75611	2
18-2554	Thermostat Gasket	27-41812	1
18-2832	Manifold End Cap Gasket	27-48043-1	4
18-2553	Thermostat Gasket	27-47510	1
18-2833	Exhaust Elbow To Manifold Gasket	27-99777-2	4
18-2844	Thermostat Cover Gasket	27-48818-1	1
18-0889	Fuel Pump Housing Gasket	27-34213	1
18-0891	Water Pump Mounting Gasket	27-34897	1
18-0905	Oil Pan Drain Plug Gasket	27-49955	1
18-0876	Water Pump Mounting Gasket	27-34898	1
18-0994	Carb. Mounting Gasket	27-70143-1	2
18-0518	Seal	26-34217	16
18-2845	Valve Cover Gasket	121-122	2

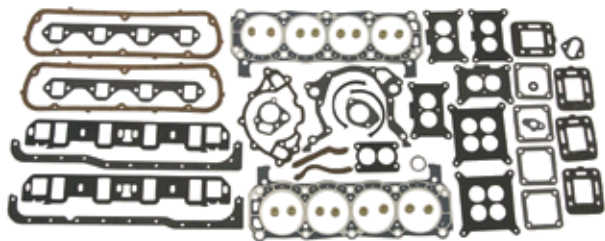

18-4385
 For: Ford 302 (5.0L) CID Eng; 215, 225 & 888 (188 HP)
 Includes 18-3883 Head Gasket

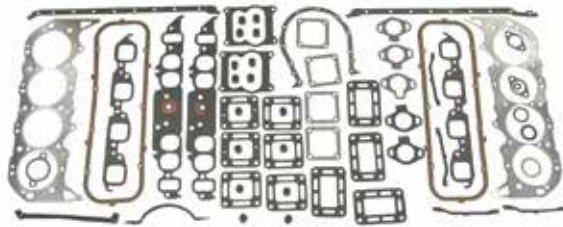

18-4387
 Replaces: 27-801853
 For: GM 454 (7.4L) CID Eng; Production Models
 Oval Port
 Includes 18-3877 Head Gasket



18-0465
INTAKE MANIFOLD GASKET SET
 Replaces: 27-65184
 For: GM 454 CID Engines, 325, 330, 340, 350 HP
 and 454 Magnums, 7.4L

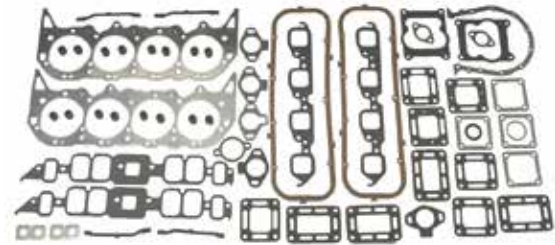

18-4365
EXHAUST MANIFOLD GASKET SET
 Replaces: 27-801855
 For: GM 454 (7.4L) CID Eng; Production Models
 Rectangular Port
 Includes 18-3877 Head Gasket



18-4388
INTAKE MANIFOLD GASKET SET
 Replaces: 27-11977A88, A92
 For: GM 262 CID Eng; 175, 185 & 205 HP, 4.3L
 Includes 18-3879 Head Gasket

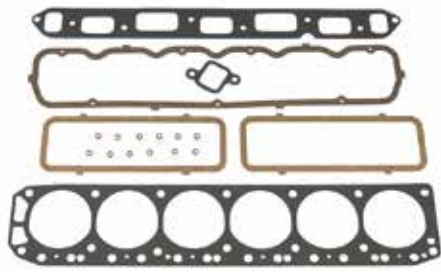

18-4389
INTAKE MANIFOLD GASKET SET
 Replaces: 27-47453A1
 For: All GM 165 HP (S/N 270032 & UP) & Inline 6 cyl.
 250 CID

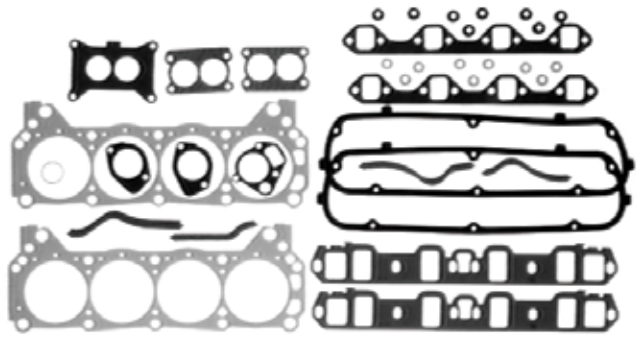

18-4391
INTAKE MANIFOLD GASKET SET
 Replaces: 27-64763A2
 For: Ford 351 CID Eng; 233 HP S/N 4173000-4500860, 5.8L
 Includes 18-3883 Head Gasket

18-4392
INTAKE MANIFOLD GASKET SET
 Replaces: 27-75611A2
 For: GM 305 & 350 CID Eng. 898 (198 HP) 200, 228,
 230/260 (Inboard) 230, 250, 255, 260, 280 & 5.7L Ski

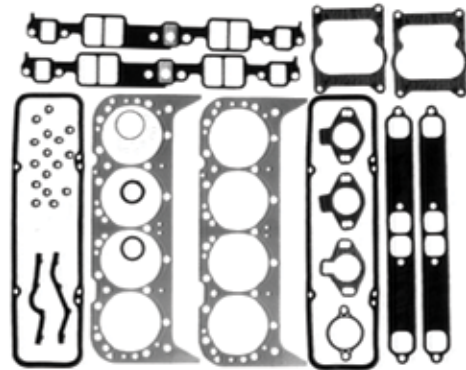

— CONTAINS —

Part #	Description	O.E. #	Qty.
18-0868	Intake Manifold Gasket	27-17145	1
18-0872	Exhaust Manifold Gasket	27-33395	2
18-2848	Quadrajel Base Gasket	27-52457-2	2
18-3876	Head Gasket	27-75611	2
18-2553	Thermostat Gasket	27-47510	1
18-2844	Thermostat Cover Gasket	27-48818-1	1
18-2554	Thermostat Gasket	27-41812	2
18-2917	Lower Thermostat Housing Gasket	27-53045-1	1
18-2845	Valve Cover Gasket	27-11999	2
18-0518	Seal	26-34217	16

OVERHAUL GASKET SETS

(Sets do not include Front and Rear Crankshaft Seals)



18-4381

Replaces: 27-43186A1

For: 224 (3.7L) CID Eng; 165, 170, 180, 190 HP
S/N 6916779 & UP

— CONTAINS —

Part #	Description	O.E. #	Qty.
18-0175	O-Ring	25-26543	4
18-0860	O-Ring	25-62700	1
18-0864	Seal	26-90925	1
18-0881	Exhaust Elbow Mounting Gasket	27-18272	1
18-0992	Exhaust Manifold Mounting Gasket	27-68715	1
18-0994	Carburetor Mounting Gasket	27-70143-1	1
18-0158	Intake Manifold Gasket	27-70905	1
18-0111	Exhaust Elbow Mounting Gasket	27-89657	2
18-0160	Lower Exhaust to Intake Manifold Gasket	27-94136	1
18-0113	Exhaust Elbow Mounting Gasket	27-97542	1
18-2843	Thermostat Cover Gasket	27-74830	1
18-2848	QuadraJet Base Gasket	27-52457-2	1
18-3878	Head Gasket	27-13709T	1
18-7121	O-Ring	25-35027	1
18-0874	Distributor Gasket	27-34486	1
18-0185	Seal	27-91892	1
18-2555	Thermostat Gasket	27-89656-1	1
18-0889	Fuel Pump Mounting Gasket	27-34213	1
18-4366	Oil Pan Gasket Set	27-72479A5	1
18-0387	Flywheel Cover Gasket	27-94976	1
18-0172	Oil Seal	26-97530	2

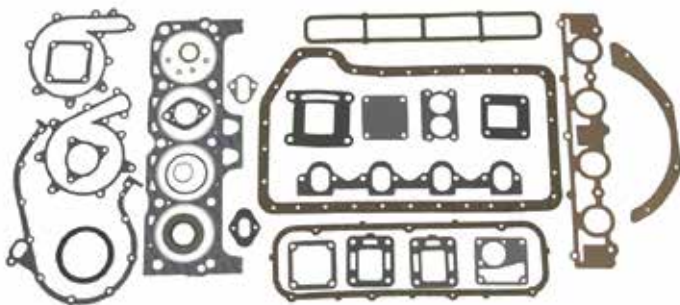

18-4382

Replaces: 27-74830A3

For: 224 (3.7L) CID Eng; 470 S/N 4208730 & UP

— CONTAINS —

Part #	Description	O.E. #	Qty.
18-0864	Seal	26-90925	1
18-0992	Exhaust Manifold Mounting Gasket	27-68715	1
18-0158	Intake Manifold Gasket	27-70905	1
18-0950	Impeller Cover Gasket	27-88046	1
18-0954	Exhaust Mounting Gasket	27-92720	1
18-0113	Exhaust Elbow Mounting Gasket	27-97542	1
18-2832	Manifold End Cap Gasket	27-48043-1	2
18-2833	Exhaust Elbow To Manifold Gasket	27-99777-2	2
18-2843	Thermostat Cover Gasket	27-74830	1
18-3878	Head Gasket	27-13709T	1
18-0175	O-Ring	25-26543	4
18-0889	Fuel Pump Mounting Gasket	27-34213	1
18-7121	O-Ring	25-35029	1
18-0874	Distributor Gasket	27-34486-3	1
18-0928	Manifold End Cap Gasket	27-73814	1
18-0994	Carb. Mounting Gasket	27-70143-1	1
18-2555	Thermostat Cover Gasket	27-89656-1	1
18-4366	Oil Pan Gasket Set	27-72479A5	1
18-0387	Flywheel Cover Gasket	27-94976	1

MISCELLANEOUS GASKET SETS



18-0153

OIL PAN GASKET SET

Replaces: 27-85817A1

For: Mercruiser GM 350 CID (5.7L)



18-0340

OIL PAN GASKET SET

Replaces: 27-49949

For: Mercruiser 160/165 (6 cyl.)



18-1239

OIL PAN GASKET

Replaces: 27-810846T

For: Mercruiser 3.0L GM 181



18-0348

OIL PAN GASKET SET

Replaces: 27-52550

For: Mercruiser GM 454/502 CID Eng; (7.4L and 8.2L)



18-1237

OIL PAN GASKET

Replaces: 27-138651



18-0466

OIL PAN GASKET SET

Replaces: 27-14901A1

For: Mercruiser GM 153/181 (2.5L & 3.0L)



18-1238

INTAKE GASKET SET

Replaces: 24-824326

For: Mercruiser 4.3L/LX models, pre SN F802999



18-1231

INTAKE GASKET

Replaces: 27-818188-1

For: Rectangular port high performance big block Chevy



18-0405

OIL PAN GASKET

Replaces:

27-14247-1, 27-883964

For: Mercruiser GM 262 CID Eng. (4.3L)



18-0407
OIL PAN GASKET SET
 Replaces: 27-64798
 For: Mercruiser: 215, 225, 888



18-0410
INTAKE MANIFOLD GASKET SET
 Replaces: 27-75648
 For: Ford 5.0L/302, 5.8L/351 CID Engine; (233HP)
 S/N 3108723 & UP



18-0411
OIL PAN GASKET SET
 Replaces: 27-90458A1
 For: Mercruiser GM 350 CID (5.7L)
 Starboard Dipstick



18-0611
OIL PAN GASKET SET
 Replaces: 27-75483
 For: Mercruiser Ford 351 CID Eng.



18-0868
INTAKE MANIFOLD GASKET SET
 Replaces: 27-17145
 For: Mercruiser 305, 350



18-4366
OIL PAN GASKET SET
 Replaces: 27-72479A5
 For: Mercruiser 224 CID (3.7L)

18-4375
TIMING CHAIN GASKET SET
 Replaces: 27-34213A2
 For: Mercruiser GM 153 & 181 CID Eng's; 110, 120, 130, 140, 150, 160 & 165 HP; 2.5L & 3.0L



— CONTAINS —

Part #	Description	O.E. #	Qty.
18-0889	Fuel Pump Mounting Gasket	27-34213	1
18-0887	Timing Cover Gasket	27-49953	1
18-0948	Distributor Gasket	27-87707	1
18-0327	Water Pump Gasket	27-33956	1



18-4377
TIMING CHAIN GASKET SET
 Replaces: 27-42457A1
 For: GM 262 CID Eng; 175, 185 & 205 HP

18-4378
TIMING CHAIN GASKET SET
 Replaces: 27-54529A1
 For: GM 454 CID Eng. 325, 330, 340 & 350 Inboards & 300TRS



— CONTAINS —

Part #	Description	O.E. #	Qty.
18-0889	Fuel Pump Mounting Gasket	27-34213	1
18-0903	Water Pump Gasket	27-49110	2
18-0980	Timing Chain Gasket	27-54529	1





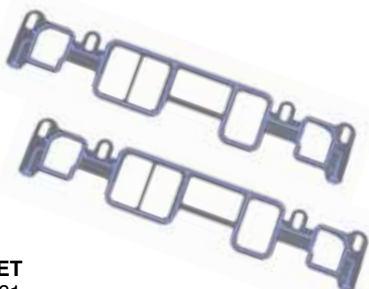



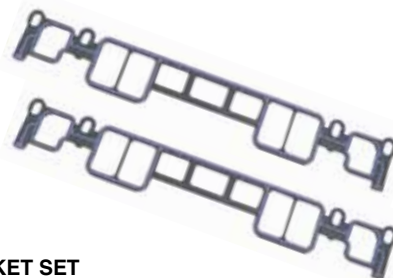



18-4380
TIMING CHAIN GASKET SET
 Replaces: 27-68714A6
 For: Mercruiser 224 CID Eng.
 165, 170, 180, 190, 470, 485 & 488 HP



18-0487
INTAKE GASKET SET
 Replaces: 27-8243261
 Fits: MCM 262 Mag & 4.3L/LX/LH/LXH Gen II (1996-up)



18-0488
INTAKE GASKET SET
 Replaces: 27-807473A1
 Fits: MCM 350 Mag, 5.0L & 5.7L/LX Gen II (1996-up)

 <p>18-2946 HEAD GASKET Replaces: 27-52364, 27-81084 For: GM 181 (3.0L) CID Eng.</p>	 <p>18-3874 HEAD GASKET Replaces: 27-811546 For: (8.2L) 502 CID</p>	 <p>18-3876 HEAD GASKET Replaces: 27-75611 For: GM 305 (5.0L)/350 (5.7L) CID Eng.</p>	
 <p>18-3877 HEAD GASKET Replaces: 27-13687 For: GM 454 (7.4L) CID Eng.</p>	 <p>18-3878 HEAD GASKET Replaces: 27-13709T For: Mercruiser 224 (3.7L) CID Eng. Model 470</p>	 <p>18-3879 HEAD GASKET Replaces: 27-11986, 27-816460 For: GM 262 (4.3L) CID Eng.</p>	
 <p>18-3880 HEAD GASKET Replaces: 27-34273, 27-810841 For: GM 153 (2.5L), (3.0L) CID Eng.</p>	 <p>18-3881 HEAD GASKET Replaces: 27-47453 For: GM 250 (4.1L) CID (6 cyl) Eng.</p>	 <p>18-3883 HEAD GASKET Replaces: 27-75647 For: Ford 302 (5.0L) 351 (5.8L) CID Eng.</p>	
 <p>18-3887 HEAD GASKET Replaces: 27-850470 For: (7.4L) 454 CID GEN V and IV (1992-up)</p>	 <p>18-0353 CARB MOUNTING GASKET Replaces: 27-58764</p>	 <p>18-0354 CARB MOUNTING GASKET Replaces: 27-60715</p>	 <p>18-0685 VALVE COVER GASKET Replaces: 27-73666 224 CID (3.7L)</p>
 <p>18-0356 CARB MOUNTING GASKET (For Rochester) Replaces: 27-64692</p>	 <p>18-0357 CARB MOUNTING GASKET Replaces: 27-65577</p>	<p>PKG. OF 2</p>  <p>18-0876 18-0876-9① FUEL PUMP GASKET For GM 4.3L, 5.0L & 5.7L Replaces: 27-34898</p>	<p>PKG. OF 2</p>  <p>18-0889 18-0889-9① FUEL PUMP GASKET For GM 4.3L, 5.0L & 5.7L Replaces: 27-34213</p>

SEE PAGES 166-167 FOR OUR COMPLETE LINE OF GASKET SEALANTS

① Priced per Package



18-0360
CARB MOUNTING GASKET
 Replaces: 27-70142



18-0462
CARB MOUNTING GASKET
 Replaces: 27-48399

Model	Year	S/N
250	1968-69	2314301-2639854
270	1969-72	2851074-3385720
325	1969-70	2278747-3042730
390	1969-70	2781129-3042731



18-0463
CARB MOUNTING GASKET
 (For Weber)
 Replaces: 27-814210



18-0467
CARB MOUNTING GASKET
 (For Weber)
 Replaces: 27-41610

PKG OF 2



18-0994
18-0994-9^①
CARB MOUNTING GASKET
 Replaces: 27-70143-1

PKG OF 2



18-2848
18-2848-9^①
CARB BASE GASKET
 Replaces: 27-524572

PKG. OF 2



18-0874
18-0874-9^①
DISTRIBUTOR GASKET
 For GM V6 & V8
 Replaces: 27-344863
 For: 2.6L (1989), 3.5L (1989), 4.3L (1987-93), 5.0L (1987-88), 5.7L (1987-92), 7.4L (1988-93), 8.2L (1992-93)

PKG OF 2



18-0948
18-0948-9^①
DISTRIBUTOR GASKET
 Replaces: 27-87707
 4 Cyl.



18-0349
THERMOSTAT GASKET
 Replaces: 27-54506
 For: Ford V-8

PKG. OF 2



18-2552
18-2552-9^①
THERMOSTAT GASKET
 Replaces: 27-331792

PKG. OF 2



18-0667
18-0667-9^①
CONNECTOR COVER GASKET
 Replaces: 27-995061

PKG. OF 2



18-2553
18-2553-9^①
THERMOSTAT GASKET
 Replaces: 27-47510
 GM V-6, V-8

PKG. OF 2



18-2554
18-2554-9^①
THERMOSTAT GASKET
 Replaces: 27-41812,
 27-90556
 V-6 & V-8

PKG. OF 2



18-2555
18-2555-9^①
THERMOSTAT GASKET
 Replaces: 27-896561
 4 Cyl.

PKG OF 2



18-2831
18-2831-9^①
THERMOSTAT GASKET
 Replaces: 27-475901
 4 & 6 Cyl.

PKG OF 2



18-2834
18-2834-9^①
THERMOSTAT GASKET
 Replaces: 27-60208
 Ford V-8

PKG OF 2



18-2843
18-2843-9^①
THERMOSTAT GASKET
 Replaces: 27-74830
 470

PKG OF 2



18-2844
18-2844-9^①
THERMOSTAT GASKET
 Replaces: 27-488181
 V-8

PKG OF 2



18-2917
18-2917-9^①
THERMOSTAT GASKET
 Replaces: 27-530451









PKG OF 2



18-0398
18-0398-9^①
THERMOSTAT GASKET
 Replaces: 27-530451

SEE PAGES 166-167 FOR OUR COMPLETE LINE OF GASKET SEALANTS

^① Priced per Package

 <p>18-0111 EXHAUST ELBOW GASKET Replaces: 27-89657</p>	 <p>18-0113 EXHAUST ELBOW GASKET Replaces: 27-97542, 27-856705</p>	<p>PKG OF 2</p>  <p>18-0672 18-0672-9① EXHAUST ELBOW GASKET Replaces: 27-860231, 8637251</p>	 <p>18-0365 HEAT EXCHANGER END GASKET Replaces: 27-75450 224 CID</p>
 <p>18-0389 HEAT EXCHANGER END GASKET Replaces: 27-99960</p>	 <p>18-0881 EXHAUST ELBOW GASKET Replaces: 27-18272</p>	<p>PKG. OF 2</p>  <p>18-0885 18-0885-9① EXHAUST ELBOW GASKET Replaces: 27-48042</p>	 <p>18-0897 EXHAUST ELBOW GASKET Replaces: 27-41813</p>
<p>PKG. OF 2</p>  <p>18-0928 18-0928-9① MANIFOLD END CAP GASKET Replaces: 27-73814</p>	 <p>18-0954 EXHAUST ELBOW GASKET Replaces: 27-92720</p>	<p>PKG OF 2</p>  <p>18-2819 18-2819-9① EXHAUST ELBOW GASKET Replaces: 27-39915</p>	<p>PKG OF 2</p>  <p>18-2832 18-2832-9① MANIFOLD END CAP GASKET Replaces: 27-480431</p>
<p>PKG OF 2</p>  <p>18-2833 18-2833-9① EXHAUST ELBOW GASKET Replaces: 27-997772</p>	<p>PKG OF 2</p>  <p>18-2849 18-2849-9① EXHAUST ELBOW GASKET Replaces: 27-87105-1, 27-818832, 27-863726</p>	 <p>18-0158 INTAKE MANIFOLD GASKET Replaces: 27-70905 For: 3.7L</p>	 <p>18-0183 EXHAUST MANIFOLD GASKET Replaces: 27-73866</p>
 <p>18-0418 EXHAUST MANIFOLD GASKET Replaces: 27-46820</p>	<p>PKG. OF 2</p>  <p>18-2830 EXHAUST MANIFOLD GASKET Inline 6 cyl. Replaces: 27-46401</p>	 <p>18-0680 EXHAUST MANIFOLD GASKET Replaces: 27-815528</p>	 <p>18-2896 EXHAUST MANIFOLD GASKET Replaces: 27-52546</p>

SEE PAGES 166-167 FOR OUR COMPLETE LINE OF GASKET SEALANTS

① Priced per Package

PKG. OF 2



18-2909
18-2909-9①
EXHAUST MANIFOLD GASKET
 Replaces: 27-99757



18-0872
EXHAUST MANIFOLD GASKET
 Replaces: 27-33395
 GM 5.0L & 5.7L



18-2912
EXHAUST MANIFOLD GASKET
 Replaces: 27-53354



18-0956
EXHAUST MANIFOLD GASKET
 Replaces: 27-68715

PKG. OF 2



18-1204
18-1204-9①
EXHAUST MANIFOLD GASKET
 Replaces: 27-96429



18-0664
VALVE COVER GASKET
 Replaces: 27-17467
 For: GM 305/350, 5.0 & 5.7L



18-2845
VALVE COVER GASKET
 Replaces: 27-11999
 V-8 GM 305/350 CID, 5.0 & 5.7L



18-25001
VALVE COVER GASKET
 Replaces: 27-14765
 Fits: GM 454, 7.4L



18-25002
VALVE COVER GASKET
 Replaces: 27-811588
 Fits: GM 454, 502, (1992-UP)
 Recessed Grooved Valve Cover



18-0311
VALVE COVER GASKET
 Replaces: 27-11988
 For: 4.3 Litre
 262 CID



18-0346
VALVE COVER GASKET
 Replaces: 27-49936
 For: GM 250 CID (4.1L), 160/165/200 (6 cyl.)



18-0347
VALVE COVER GASKET
 Replaces: 27-52145
 For: GM 153 & 181 CID (2.5L & 3.0L)

PKG. OF 2



18-0352
VALVE COVER GASKET
 Replaces: 27-56173
 For: Ford 302/351 CID (5.0L & 5.8L)

18-0464
18-0464-9①
VALVE COVER GASKET
 Replaces: 27-49121
 For: GM 454/502 CID (7.4L & 8.2L)



Model	Year	S/N
330	1977-81	4623115-6083144
7.4 Bravo	1988-91	B771113-D603117
454 Mag	1986-92	A631894-D805068
370 TRS	1978-87	4179554-B714586
400 TRS	1980-86	4179554-B457644
400 TRS	1983-86	4179554-B485220
460 TRS	1983-86	4179554-6181046
502 Mag Bravo	1990-92	C878221-D824588



18-0468
TIMING COVER GASKET
 Replaces: 27-811572
 GM 4.3L, 5.0L & 5.7L

PKG. OF 2



18-0887
18-0887-9①
TIMING COVER GASKET
 Replaces: 27-49953
 4 & 6 Cyl.

PKG. OF 2



18-0976
18-0976-9①
TIMING CHAIN COVER GASKET
 Replaces: 27-14250



18-0980
TIMING COVER GASKET
 Replaces: 27-54529
 GM 7.4L





















PKG. OF 2



18-0328
18-0328-9①
PUSH ROD/LIFTER COVER GASKET
 Replaces: 27-34208
 153 & 181 CID, 120/140 (4 Cyl.)













SEE PAGES 166-167 FOR OUR COMPLETE LINE OF GASKET SEALANTS

① Priced per Package

 <p>18-0329 PUSH ROD/LIFTER COVER GASKET Replaces: 27-34209 For: 140/150/160/165 (6 cyl.)</p>	 <p>18-2815 PUSH ROD COVER GASKET Replaces: 27-814703 For: 3.0L</p>	<p>PKG. OF 2</p>  <p>18-1210 18-1210-9① END CAP GASKET Replaces: 27-39923</p>	<p>PKG. OF 2</p>  <p>18-0185 18-0185-9① REMOTE OIL SEAL Replaces: 27-91892</p>
 <p>18-1240 OUTDRIVE SEAL For Bravo Replaces: 12708</p>	<p>PKG OF 5</p>  <p>18-2516 18-2516-9① BRAVO OUTDRIVE SEAL Replaces: 16755</p>	<p>PKG. OF 2</p>  <p>18-2556 18-2556-9① DRIVE SHAFT HOUSING TO BELL HOUSING GASKET Replaces: 27-35996, A1</p>	 <p>18-2743 OUTDRIVE HOUSING GASKET Replaces: 27-94996-2, Q2</p>
<p>PKG OF 5</p>  <p>18-2820 18-2820-9① OUTDRIVE GASKET Replaces: 27-64818, Q4</p>	<p>PKG OF 5</p>  <p>18-2840 18-2840-9① BELL HOUSING GASKET Replaces: 27-35982</p>	<p>PKG OF 2</p>  <p>18-2847 18-2847-9① OUTDRIVE GASKET Replaces: 27-54014 For: E, H, TR, TRS</p>	 <p>18-0386 WATER PUMP BODY GASKET Replaces: 27-94914</p>
<p>PKG. OF 2</p>  <p>18-0894 18-0894-9① WATER POCKET COVER GASKET Replaces: 27-55810, 27-55810 -1</p>	 <p>18-0916 WATER PUMP GASKET Replaces: 27-8052151</p>	<p>PKG. OF 2</p>  <p>18-0903 WATER PUMP GASKET Replaces: 27-49110 454 CID</p>	 <p>18-0147 WATER PUMP GASKET For Ford V-8 Replaces: 27-56880</p>
 <p>18-0327 WATER PUMP GASKET Replaces: 27-33956 4 & 6 Cyl.</p>	<p>PKG. OF 2</p>  <p>18-0891 18-0891-9① WATER PUMP MOUNTING GASKET Replaces: 27-34897 For: GM 4.3L, 5.0L & 5.8L</p>	<p>PKG. OF 2</p>  <p>18-0893 18-0893-9① WATER PUMP BACK-IN PLATE GASKET Replaces: 27-35380 GM 4.3L, 5.0L & 5.7L</p>	<p>PKG OF 2</p>  <p>18-2564 18-2564-9① IMPELLER GASKET Alpha I - Generation 2 Replaces: 27-430331</p>

SEE PAGES 166-167 FOR OUR COMPLETE LINE OF GASKET SEALANTS

① Priced per Package

 <p>18-0950 IMPELLER HOUSING GASKET Replaces: 27-88046 224 CID</p>	<p>PKG OF 2</p>  <p>18-2565 18-2565-9① IMPELLER GASKET Alpha I - Generation 2 Replaces: 27-430472</p>	<p>PKG OF 2</p>  <p>18-2566 18-2566-9① IMPELLER GASKET Alpha I - Generation 2 Replaces: 27-817277</p>	<p>PKG OF 2</p>  <p>18-2823 18-2823-9① LOWER WATER PUMP GASKET Replaces: 27-32769, 27-19553</p>
<p>PKG OF 2</p>  <p>18-2824 18-2824-9① UPPER WATER PUMP GASKET Replaces: 27-32770, 27-19551</p>	<p>PKG OF 2</p>  <p>18-2825 18-2825-9① WATER PUMP BASE GASKET Replaces: 27-32771</p>	<p>PKG OF 2</p>  <p>18-2826 18-2826-9① WATER PUMP BASE GASKET Replaces: 27-85610-1, 27-85670-4</p>	<p>PKG OF 2</p>  <p>18-2914 18-2914-9① WATER PUMP GASKET Replaces: 27-856081</p>
<p>PKG OF 2</p>  <p>18-2915 18-2915-9① WATER PUMP GASKET Replaces: 27-856091, 27-858524</p>	<p>PKG OF 2</p>  <p>18-2919 18-2919-9① WATER PUMP GASKET Replaces: 27-426311</p>	<p>PKG OF 2</p>  <p>18-0342 POWER TRIM HOSE CONNECTOR PLATE GASKET Replaces: 27-476441</p>	<p>PKG OF 2</p>  <p>18-0388 POWER TRIM HOSE CONNECTOR GASKET Replaces: 27-988231</p>
<p>PKG. OF 2</p>  <p>18-0322 18-0322-9① REAR SEAL GASKET Replaces: 27-14247, 27-881715 GM 5.0L & 5.7L</p>	<p>PKG OF 2</p>  <p>18-3289 DOUBLE LIP SEAL Replaces: 26-864319 For: Gen II Upper Housing</p>	<p>PKG OF 2</p>  <p>18-2094 OIL SEAL Replaces: 26-88416 Fits: 120/140(1978-82), 165 (1978-81), 260 (1978-82), 470 (1978-82), 485 (1980-82), 898/228 (1978-82), Alpha I/Gen II (1991 & Up), Blackhawk (1994-95), Bravo I/II/III (1988-98), R/MR/Alpha One Sterndrive and Transom (1983-90)</p>	<p>PKG OF 2</p>  <p>18-2944 18-2944-9① SEAL RING GASKET (Quad Ring) Replaces: 26-45577</p>
<p>PKG OF 2</p>  <p>18-2945 18-2945-9① 18-29451-9① (PKG OF 50) DRAIN SCREW GASKET Replaces: 12-20260, 12-19183, 12-191832 Used in most lower units and sea water pumps</p>	<p>PKG OF 5</p>  <p>18-2948 18-2948-9① RUBBER WASHER Replaces: 12-49221-1, 12-49221</p>	<p>PKG OF 2</p>  <p>18-2349 SHIFT SHAFT SLEEVE Replaces: 23-67370 For: Ratios 1.47, 1.62, 1.81 & 1.94. For: Gen II (1998 & up), (0L100040 & up) 1/4" Thick</p>	<p>PKG. OF 2</p>  <p>18-0905 OIL PAN DRAIN PLUG GASKET Replaces: 27-49955</p>

SEE PAGES 166-167 FOR OUR COMPLETE LINE OF GASKET SEALANTS

① Priced per Package

<p>PKG. OF 2</p>  <p>18-4267 18-4267-9① SHIFT SHAFT WASHER Replaces: 12-29395</p>	<p>PKG. OF 3</p>  <p>18-0681 18-0681-9① WASHER Replaces: 12-32834</p>	<p>PKG. OF 5</p>  <p>18-0203 18-0203-9① BELL HOUSING WASHER Replaces: 12-35935 All Mercruiser Stern drives 1963-1998</p>	<p>PKG. OF 5</p>  <p>18-2316 18-2316-9① SHIFT SHAFT WASHER Replaces: 12-77674 Used over 18-2349 sleeve For: Ratios 1.47, 1.62, 1.81 & 1.94. For: Gen II (1998 & up), (0L100040 & up) 1/8" Thick</p>																		
 <p>18-0318 WASHER Replaces: 12-815472</p>	<p>PKG OF 2</p>  <p>18-4270 18-4270-9① WASHER Replaces: 12-36001</p>	<p>PKG OF 5</p>  <p>18-2340 18-2340-9① SHIFT SHAFT WASHER Replaces: 12-31266 For: #1R/MR (1/16" Thick)</p>	<p>PKG OF 2</p>  <p>18-2343 18-2343-9① PINION NUT WASHER Replaces: 12-92721 For: MR/Alpha/Gen II</p>																		
 <p style="text-align: center;">SCREWS</p> <table border="1" data-bbox="771 1050 1201 1253"> <thead> <tr> <th>Part #</th> <th>Description</th> <th>O.E. #</th> </tr> </thead> <tbody> <tr> <td>18-2361</td> <td>(PKG. OF 2)</td> <td></td> </tr> <tr> <td>18-2361-9①</td> <td>Lower Unit Mounting Screw</td> <td>10-30206</td> </tr> <tr> <td>18-3197</td> <td>Water Pick-Up Insert Screw</td> <td>10-76156</td> </tr> <tr> <td>18-3230</td> <td>Gear Housing To Drive Shaft Housing Screw</td> <td>10-816601</td> </tr> <tr> <td>18-3231</td> <td>Upper Drive Shaft Top Cover Screw</td> <td>10-98794</td> </tr> </tbody> </table>			Part #	Description	O.E. #	18-2361	(PKG. OF 2)		18-2361-9①	Lower Unit Mounting Screw	10-30206	18-3197	Water Pick-Up Insert Screw	10-76156	18-3230	Gear Housing To Drive Shaft Housing Screw	10-816601	18-3231	Upper Drive Shaft Top Cover Screw	10-98794	<p>PKG OF 5</p>  <p>18-3721 18-3721-9① NUT Replaces: 11-13439-1, 11-859116 For: MR/Alpha</p>
Part #	Description	O.E. #																			
18-2361	(PKG. OF 2)																				
18-2361-9①	Lower Unit Mounting Screw	10-30206																			
18-3197	Water Pick-Up Insert Screw	10-76156																			
18-3230	Gear Housing To Drive Shaft Housing Screw	10-816601																			
18-3231	Upper Drive Shaft Top Cover Screw	10-98794																			
 <p>18-3236 HOUSING ALIGNMENT BUSHING Replaces: 23-32632 For: #1R/MR/Alpha</p>	 <p>18-4272 WELCH PLUG Replaces: 19-32652</p>	 <p>18-4273 WELCH PLUG Replaces: 19-42682</p>	 <p>18-2140 ENGINE MOUNT BOLT KIT For: Mercruiser I</p>																		
 <p>18-2141 ENGINE MOUNT BOLT KIT Replaces: 10-97934A1 For: R/MR/Alpha I/ Gen II/Bravo</p>	 <p>18-3728 LOCK NUT Replaces: 11-99298, 11-863332</p>	 <p>18-3729 MOTOR MOUNT BOLT Replaces: 10-97934</p>	 <p>18-2193 REAR ENGINE MOUNT Replaces: 99297A1 For 120/140 HP S/N 6229717 & UP; All 224 CID Blocks; All 898, 200, 228, 230, 260, 300 & 320 HP; All 350-454 Magnums</p>																		

① Priced per Package

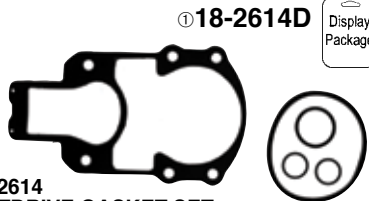

18-2614
OUTDRIVE GASKET SET
 1967-1982
 Replaces: 27-64818A1, 27-64818T4, 27-64818Q4

—CONTAINS—

Part #	Description	O.E. #	Qty.
18-2820	Drive Shaft Housing to Bell Housing Gasket	27-64818	1
18-2840	Bell Housing Gasket	27-35982	1
18-7153	O-Ring	25-25439	2
18-7170	O-Ring	25-33504	1

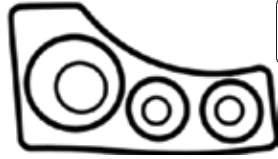

18-2615
OUTDRIVE GASKET SET
 (Bravo Unit)
 Replaces: 16755A1, 16755Q1, 16755T1
 For: All Bravo

—CONTAINS—

Part #	Description	O.E. #	Qty.
18-2516	Seal	16755	1
18-7198	O-Ring	25-45710	1
18-7153	O-Ring	25-25439	2
18-7168	O-Ring	25-48171	2
18-7105	O-Ring	25-62705	1
18-7117	O-Ring	25-35027	1

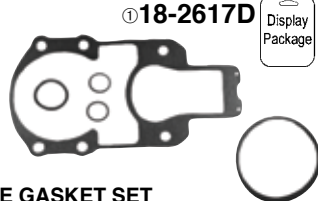

18-2617
OUTDRIVE GASKET SET
 Old Style
 Replaces: 27-35996A1
 For: IA/IB/IC and EZ Shift (1964-1966)

—CONTAINS—

Part #	Description	O.E. #
18-2556	Drive Shaft Housing to Bell Housing Gasket	27-35996
18-2840	Bell Housing Gasket	27-35982
18-7153	O-Ring	25-25439
18-7170	O-Ring	25-33504

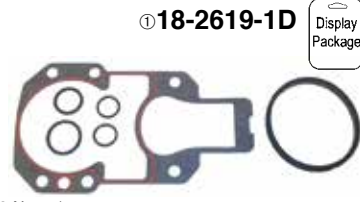

18-2619-1
OUTDRIVE GASKET SET
 Replaces: 27-64818A3, 27-94996Q2, 27-94996T2
 For: R, MR, Alpha I, Alpha Gen II (1983-Newer)

—CONTAINS—

Part #	Description	O.E. #
18-2743	Drive Shaft Housing to Bell Housing Gasket	27-94996-2
18-2840	Bell Housing Gasket	27-35982
18-7153	O-Ring	25-25439
18-7170	O-Ring	25-33504
18-7117	O-Ring	25-35027



18-2620
OUTDRIVE GASKET SET
 Replaces: 27-54014A1, Q1
 For: E, H, TR, TRS

—CONTAINS—

Part #	Description	O.E. No.
18-7175	O-Ring	25-62817
18-2847	Drive Shaft Housing to Bell Housing Gasket	27-54014

① Items ending in "D" are Display Packaged - Regular number is Non-Display

Stern Drive Model	Beginning Serial No.	Ending Serial No.	Bell Housing Gasket	Bell Housing O-Ring	Bell Housing Rubber Gasket	U-Joint O-Ring (2 Required)	Gasket Set
I	1534570	1684187	—	18-7170	—	18-7153	—
IA	1684188	2062140	18-2556	18-7170	18-2840	18-7153	18-2617
IB	1684633	2062140	18-2556	18-7170	18-2840	18-7153	18-2617
IC	1685240	2065189	18-2556	18-7170	18-2840	18-7153	18-2617
II TR	3377316	4794899	18-2847	18-7175	—	—	18-2620
120	2062141	6225576	18-2820	18-7170	18-2840	18-7153	18-2614
120	6225577	UP	18-2743	18-7170	18-2840	18-7153	18-2619-1
120	6225577	UP	18-2743 ③	18-7170	18-2840	18-7153	18-2619-1
140	2062141	6225576	18-2820	18-7170	18-2840	18-7153	18-2614
140	6225577	UP	18-2743	18-7170	18-2840	18-7153	18-2619-1
140	6225577	UP	18-2743 ③	18-7170	18-2840	18-7153	18-2619-1
160	2065190	2763441	18-2820	18-7170	18-2840	18-7153	18-2614
165	2763442	UP	18-2820	18-7170	18-2840	18-7153	18-2614
170	6225577	UP	18-2743	18-7170	18-2840	18-7153	18-2619-1
170	6225577	UP	18-2743 ③	18-7170	18-2840	18-7153	18-2619-1
185	6225577	UP	18-2743	18-7170	18-2840	18-7153	18-2619-1
185	6225577	UP	18-2743 ③	18-7170	18-2840	18-7153	18-2619-1
190	6225577	UP	18-2743	18-7170	18-2840	18-7153	18-2619-1
190	6225577	UP	18-2743 ③	18-7170	18-2840	18-7153	18-2619-1
200	6225577	UP	18-2743	18-7170	18-2840	18-7153	18-2619-1
200	6225577	UP	18-2743 ③	18-7170	18-2840	18-7153	18-2619-1
215 E/H	2782203	2915034	18-2847	18-7175	—	18-7153 ①	18-2620
225	3856268	4200499	18-2820	18-7170	18-2840	18-7153	18-2614
228	4782330	6225576	18-2820	18-7170	18-2840	18-7153	18-2614
228	6225577	UP	18-2743	18-7170	18-2840	18-7153	18-2619-1
228	6225577	UP	18-2743 ③	18-7170	18-2840	18-7153	18-2619-1
230	6225577	UP	18-2743	18-7170	18-2840	18-7153	18-2619-1
230	6225577	UP	18-2743 ③	18-7170	18-2840	18-7153	18-2619-1
233	4200500	UP	18-2820	18-7170	18-2840	18-7153	18-2614
250	4791300	4898729	18-2820	18-7170	18-2840	18-7153	18-2614
255 TRS	3377316	4203749	18-2847	18-7175	—	—	18-2620
260	4898730	6225576	18-2820	18-7170	18-2840	18-7153	18-2614
260	6225577	UP	18-2743	18-7170	18-2840	18-7153	18-2619-1
260	6225577	UP	18-2743 ③	18-7170	18-2840	18-7153	18-2619-1
280 TRS	4203750	4895399	18-2847	18-7175	—	—	18-2620
470	4208730	6225576	18-2820	18-7170	18-2840	18-7153	18-2614
470	6225577	UP	18-2743	18-7170	18-2840	18-7153	18-2619-1
470	6225577	UP	18-2743 ③	18-7170	18-2840	18-7153	18-2619-1
485	4893835	UP	18-2820	18-7170	18-2840	18-7153	18-2614
488	6225577	UP	18-2743	18-7170	18-2840	18-7153	18-2619-1
488	6225577	UP	18-2743 ③	18-7170	18-2840	18-7153	18-2619-1
888	3106717	UP	18-2820	18-7170	18-2840	18-7153	18-2614
898	4782330	6225576	18-2820	18-7170	18-2840	18-7153	18-2614
898	6225577	UP	18-2743	18-7170	18-2840	18-7153	18-2619-1
898	6225577	UP	18-2743 ③	18-7170	18-2840	18-7153	18-2619-1
R/MR/Alpha One	6225577	UP	18-2743	18-7170	18-2840	18-7153	18-2619-1
R/MR/Alpha One	6225577	up	18-2743 ③	18-7170	18-2840	18-7153	18-2619-1
Bravo (I/II)	B664190	UP	18-2516	—	—	18-7153	18-2615
TR-TRS	4794900	UP	18-2847	18-7175	18-2847	18-7153 ②	18-2620

① Hydraulic Shift Only

② Borg Warner Transmission Only

③ For housing with oil reservoir check valve

ENGINE

DIAGNOSTICS = **STATS**

SIERRA TOUCH AND TEST SYSTEM

NEW NEW NEW NEW NEW NEW NEW NEW NEW NEW

00110011110011001100110 10101 01100



001100111100110011001

1010101 01100

00110011110011001100110 10101 011

011000 0011 011 011 011 011 00

0101 0011 0111 00

IN+ENSIVE CARE FOR MULTIPLE ENGINES

STATS is a portable tool that provides full diagnostic, service and repair capability on the most popular makes and models of watercraft including, outboard, sterndrive, & inboard engines worldwide. Also includes PWCs.



SEASTAR SOLUTIONS®

www.sierrastats.com

Explore

formerly known as Teleflex Marine

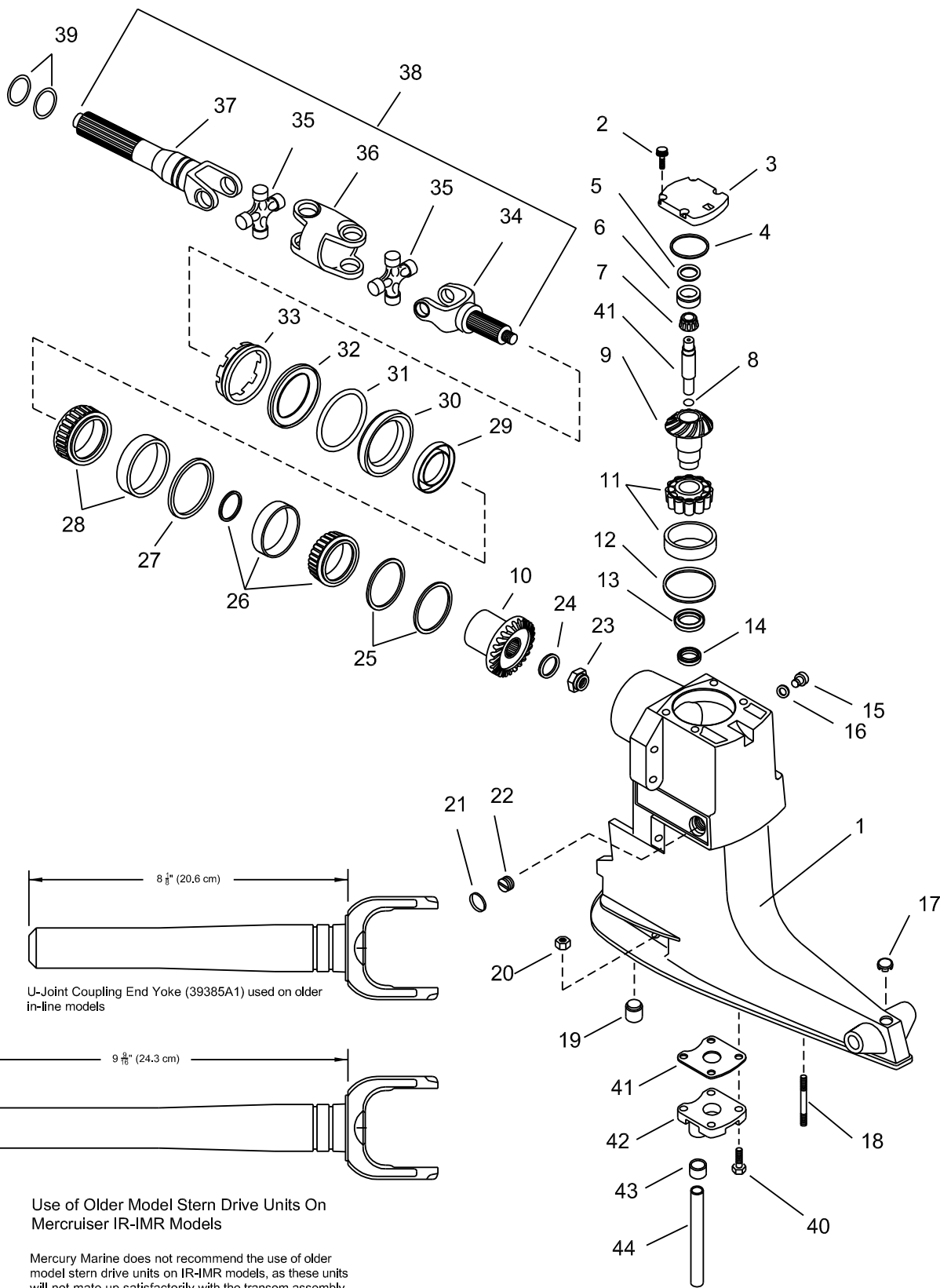

U-Joint Coupling End Yoke (39385A1) used on older in-line models

Use of Older Model Stern Drive Units On Mercuriser IR-IMR Models

Mercury Marine does not recommend the use of older model stern drive units on IR-IMR models, as these units will not mate up satisfactorily with the transom assembly. In addition, the older model in-line stern drive units are equipped with U-Joint coupling end yoke (39385A1). This yoke is shorter than yoke (59830A1) used on the IR-IMR stern drive units, and therefore, will not fully engage the engine coupler splines. **Use of an older In-Line model stern drive unit on a IR-IMR model will result in a spline failure to coupling and/or yoke.**

Figure #	Description	Part #	O.E.M. #	Qty.
1	Upper Gear Housing	N/A	1547-9412A18	1
2	Screw, Top Cover	18-3231	10-98794	4
3	Top Cover	18-2381	94998A2	1
4	O-Ring, Top Cover	18-7161	25-32546	1
5	Shim, Bearing Cup to Top Cover	18-2283	15-45691A1	1
6	Tapered Roller Bearing	18-1165	31-61100A1	1
7	Upper Drive Shaft	18-2179	45-55796	1
8	O-Ring, Upper Drive Shaft	18-7445	25-55801	1
9./10.	Upper Unit Gear Set			
	1.5:1	18-2201	43-18410A2, 46-18411A2	1
	Rebuild Kit	18-2256	43-803116T1	1
	1.65:1	18-2203	43-45814A5	1
	Rebuild Kit	18-2257	43-803112T1	1
	1.84:1	18-2204	43-75325A3	1
	Rebuild Kit	18-2258	43-803114T1	1
	1.98:1	18-2205	43-55778A3	1
	Rebuild Kit	18-2259	43-803101T1	1
11	Tapered Roller Bearing	18-1161	31-35990A1	1
12	Shim Kit, Bearing Cup to Drive Shaft Housing	18-2293	15-36178A1	1
13	Oil Seal, Upper Drive Shaft Housing	18-2049	26-32511	1
14	Oil Seal, Lower Drive Shaft Housing	18-2056	26-96503	1
15	Vent Screw	18-2244	10-79953A2	1
16	Gasket, Gear Housing Drain Screw	18-2945	12-19183, 12-20260	1
17	Plug, Trim Tab Hole	18-3232	19-47579	1
18	Stud, Drive Shaft Housing	N/A	16-56295	2
19	Bushing, Drive Shaft Housing	18-3236	23-32632	1
20	Nut, Gear Housing Stud	18-2362	11-13439-1	3
21	Welch Plug, Drive Shaft Housing			
	(7/8" OD)	18-4272	19-32652	1
	(1 1/4" OD)	18-4273	19-42682	1
22	Pipe Plug, Water Pocket	18-4265	22-428611	1
23	Nut, Drive Gear to U-Joint	18-3713	11-22339	1
24	Washer, Drive Gear to U-Joint Nut	18-3712	12-45810	1
25	Shim Kit Drive Gear	18-2292	15-35980A1	1
26	Bearing Kit	18-1160	31-35988A2, A12	1
27	Spacer (comes with kit)	18-1160	31-35988A2, A13	1
28	Roller Bearing (comes with kit)	18-1160	31-35988A2, A13	1
29	Oil Seal	18-2003	26-64893	1
30	Carrier Assembly Oil Seal	18-0577	66081A2	1
31	O-Ring	18-7169	25-70937	1
32	Ring, Roller Bearing Retainer	18-4296	35983	1
33	Retaining Nut Drive Shaft Housing	18-3752	816811-1	1
34	Yoke Assembly	18-2125	46020T	1
35	Heavy Duty U-Joint	18-2104	75832A2	1
36	Center Socket	18-2128	39383T	1
37	U-Joint Shaft Coupler	18-2146	59830A1	1
38	Drive Shaft	18-9218	59830A5	1
39	O-Ring	18-7153	25-25439	2
40	Screw, Water Pocket Cover to Drive Shaft Housing	18-3229	10-28668	4
41	Gasket, Water Pocket Cover	18-0894	27-55810	1
42	Water Pocket Cover (Sold as Assembly includes 40-44)	18-3219	42724A3	1
43	Bushing, Water Pump Housing	18-3110	26-38970	1
44	Water Tube	18-3220	32-54236	1

AR As required

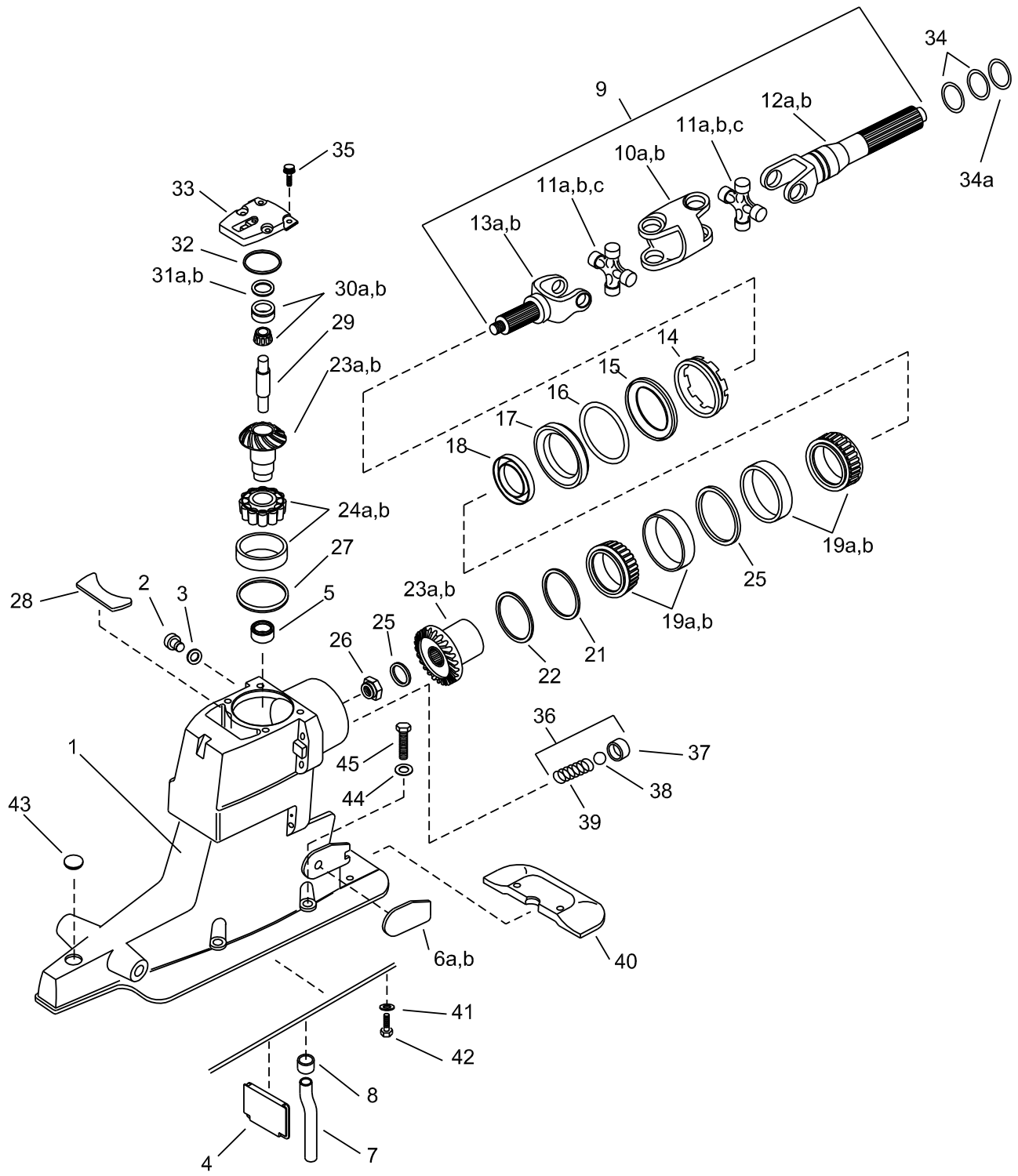

SEE PAGES 708-710 FOR COMPLETE REPLACEMENT HOUSINGS

Figure #	Description	Part #	O.E.M. #	Qty.	Figure #	Description	Part #	O.E.M. #	Qty.
1	Drive Shaft Housing (OL100009 & UP)	18-2411	1547-861063A 4	1		Complete Service Kit	18-2364	43-803119T 1	1
						1.84:1/ 1.81:1 Gear Set (tooth count... 17/19)	18-2204	43-75325A3	1
2	Screw	18-2244	10-79953A2	1					
3	Washer	18-2945	12-19183, 12-20260	1		Std. Rebuild Kit	18-2258	43-803114T 1	1
						Complete Service Kit	18-2365	43-803120 T 1	1
4	Filler Wall	N/A	815932	1					
5	Oil Seal	18-2056	26-66302	AR		1.98:1/ 1.94:1 Gear Set (tooth count... 20/24)	18-2205	43-55778A3	1
6a	Wear Pad (Port)	NSS	814386	1		Std. Rebuild Kit	18-2259	43-803101T 1	1
6b	Wear Pad (Stbd)	NSS	814387	1		Complete Service Kit	18-2363	43-803118T 1	1
7	Water Tube	18-3221	32-860220	1	23a	Upper Unit Gear Set (OL100009 & UP)			
8	Seal	NSS	26-88397	1					
9	Yoke Assembly (OK999999 & Below)	18-9218	814819A2	1		1.47:1 Gear Set (tooth count... 20/22)	18-6351	43-853641A2	1
						Complete Service Kit	18-6351K	43-803103T 1	1
	Yoke Assembly (OL100009 & UP)	18-6402	864281A2	1					
10a	Socket, Center (old design)	18-2097	39383T	1		1.62:1 & 2.0:1 Gear Set (tooth count... 24/24)	18-6350	43-853640A2	1
10b	Socket, Center GKN Series	NSS	865503T	1					
11	Cross and Bearing					Complete Service Kit	18-6350K	43-803104T 1	1
11a	D469859 - F679999 (old design)	18-2174	75832A2	2		1.81:1 Gear Set (tooth count... 17/19)	18-6353	43-853643A2	1
11b	F680000- OK999999 (old design- permalube)	18-2097	805536A2	2		Complete Service Kit	18-6353K	43-803105T 1	1
11c	OL100009 & UP (GKN Series)	18-6406	865493A01	2		1.94 & 2.4:1 Gear Set (tooth count... 20/24)	18-6352	43-853642A2	1
12a	Yoke, Coupling End (OK999999 & Below)	18-2146	59830A1	1		Complete Service Kit	18-6352K	43-803106T 1	1
12b	Yoke, Coupling End (OL100009 & UP)	18-6405	865491A01	1	24	Roller Bearing (All but 1.47:1 ratio)	18-1161	43-803106T 1	1
					24a	Roller Bearing (1.47:1 Ratio only)	18-1142	31-32573A 1	1
13a	Yoke, Gear End (OK999999 & Below)	18-2125	46020T	1	25	Washer	18-3712	12-45810	1
					26	Nut	18-3713	11-22339	1
13b	Yoke, Gear End (OL100009 & UP)	18-6403	865492T	1	27	Shim Kit	18-2293	15-36178A1	1
14	Retaining Nut	18-3752	816811-1	1	28	Plug	NSS	861738	1
15	Ring	18-4296	35983	1	29	Drive Shaft, Upper (F680000 & Up)	18-2324	45-55796-1	1
16	O-Ring	18-7169	25-70937	1	30	Bearing Assembly			
17	Carrier Assembly (Set)	18-0577	66081A2	1	30a	F680000 & UP (small bearing)	18-1179	31-32575A1	1
18	Oil Seal	18-2003	26-68493	1	30b	D494569 - F679999 (large bearing)	18-1165	31-61100A1	1
19	Roller Bearing Kit (D469859 - K999999)	18-1160	31-35988A2, A12	1	31	Shim Kit			
					31a	D494569 -F679999	18-2283	15-45691A1	1
19a	Roller Bearing Kit (OL100009 & UP)	18-1182	31-30894A 15	1	31b	F680000 & UP	18-2282	15-32563A1	1
					32	O-Ring	18-7161	25-32546	1
20	Cup Spacer (Included with 18-1160)	18-1160	31-35988A2, A12	AR	33	Cover Assembly, Top (F680000 & Up)	18-2382	828692A1	1
20a	Cup Spacer (Included with 18-1182)	NSS	23-853649A 1	AR	34	O-Ring	18-7153	25-25439	2
					34a	O-Ring	18-7117	25-35027	1
21	Shim Kit	18-2292	15-35980A1	1	35	Screw	18-3231	10-98794	4
22	Shim Spacer	18-2296	15-71013	1	36	Check Valve Kit, Oil Passage	18-2715 KIT	24-17997A1	1
23	Upper Unit Gear Set (OD469859-OK999999)				37	Oil Seal (Included in Kit)	NSS	—	1
					38	Ball (Included in Kit)	NSS	—	1
	1.5:1/ 1.47:1 Gear Set (tooth count... 20/22)	18-2201	43-18410A2, 43-18411A2	1	39	Spring	NSS	—	1
	Std.Rebuild Kit	18-2256	43-803116T 1	1	40	Anode Plate	18-6080	821629A1	1
	Complete Service Kit	18-2358	43-803102T 1	1	41	Lockwasher	N/A	13-78968	2
	1.65:1/ 1.62:1 Gear Set (tooth count... 24/24)	18-2203	43-45814A5	1	42	Screw	18-3229	10-28668	2
	Std. Rebuild Kit	18-2257	43-803112T 1	1	43	Plug	N/A	19-824928	1
					44	Washer	18-4858-9	12-45176	4
					45	Bolt	18-3230	10-816601	4

AR As required

NSS Not Sold Separate

N/A Not Available

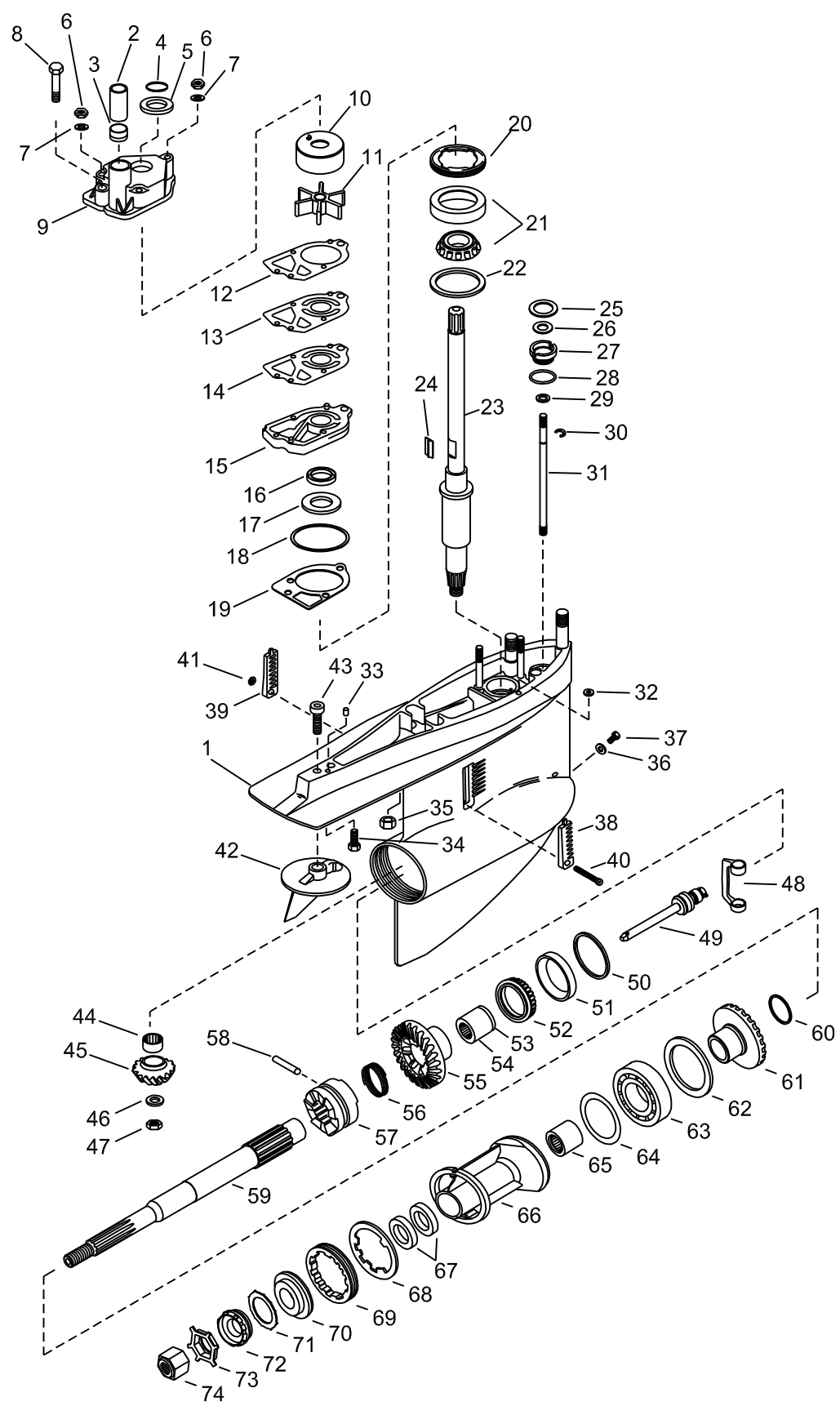
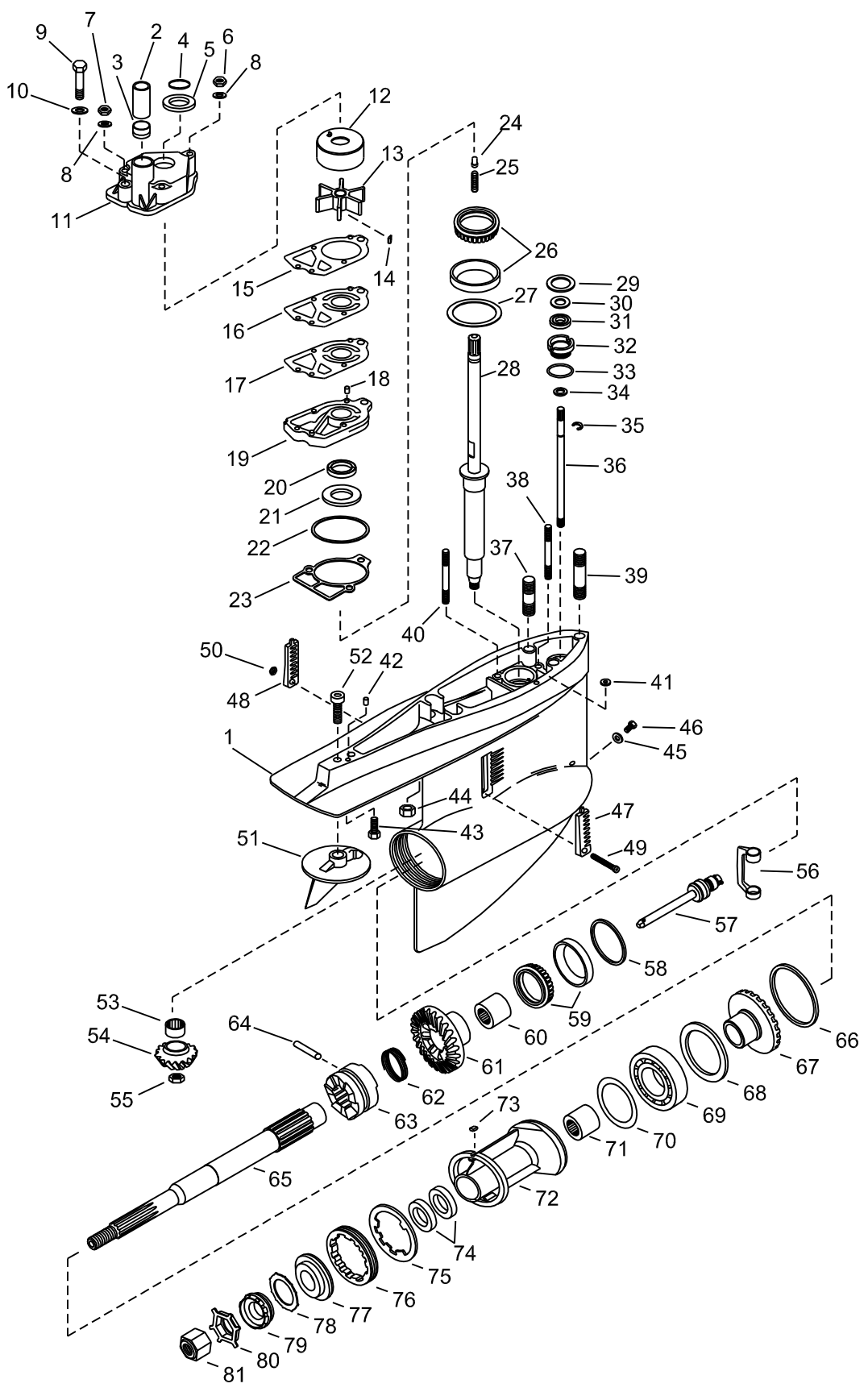

Figure #	Description	Part #	O.E.M. #	Qty.	Figure #	Description	Part #	O.E.M. #	Qty.
1	Gear Housing	18-2401	1623-8951A37	1	44	Pinion Bearing	18-1117	31-42647A1	1
2	Water Tube Guide	18-3109	23-29804	1	45	Lower Alpha Gear Set (pinion gear)	18-2206	43-17064A2, 43-17064A3, 43-42934	1
3	Bushing/Water Pump Housing	18-3110	26-38970	1					
4	O-Ring, Upper Drive Shaft	18-7158	25-30613	1					
5	Slinger	18-7426	25-30271	1	46	Anti-Galling Washer Pinion Gear	18-2343	22-92721	1
6	Stainless Steel Locknuts (5/16-24)	N/A	11-13436	1	47	Pinion Nut	18-3719	11-35921	1
	Stainless Steel Locknuts (1/4-28)	N/A	11-13438	2	48	Shift Crank	18-2130	76865	1
7	Washer	18-4270	12-36001	3	49	Shift Spool Assembly	18-2286	818349A1	1
8	Screw, Water Pump Body to Water Pump Base	N/A	10-96411	1	50	Shim Kit, Forward Gear	18-2285	15-47397A1	1
					51	Tapered Roller Bearing Set	18-1159	31-35928A1	1
9	Upper Pump Housing	18-3116	46-96148A1	1	52	Inner Bearing, Forward Gear	18-1157	31-30895	1
10	Insert Cup	18-3114	48752	1	53	Retaining Clip, Inner Bearing	N/A	—	1
11	Impeller	18-3017	47-89984	1	54		18-1157	31-30895	1
12	Gasket, Upper Water Pump to Wear Plate	18-2915	27-85609-1	1	55	Lower Alpha Gear Set (Forward Gear/Pinion)	18-2206	43-17064A2, 43-17064A3, 43-42934	1
13	Impeller Plate	18-3117	32435	1					
14	Gasket, Wear Plate to Water Pump Base	18-2914	27-85608-1	1					
15	Water Pump Base	18-3420	46-44292A3	1	56	Spring, Retainer - Cross Pin	18-2348	24-30893	1
					57	Sliding Clutch	18-2202	52-66063	1
16	Oil Seal (upper)	18-2013	26-16977	1	58	Cross Pin, Clutch to Actuating Shaft	18-2357	24-30893	1
17	Oil Seal (lower)	18-2014	26-89238	1					
18	O-Ring, Water Pump	18-7176	25-90011	1	59	Propeller Shaft	18-2166	44-66060, 44-6606-3	1
19	Gasket, Water Pump Base to Gear Housing	18-2919	27-42631-1	1	60	Spacer, Reverse Gear	N/A	23-824108	1
20	Retainer, Drive Shaft Bearing	18-2346	824519	1	61	Lower Alpha Gear Set (Reverse Gea-NSS)	18-2206	43-17064A2, 43-17064A3, 43-42934	1
21	Tapered Roller Bearing Drive Shaft	18-1143	31-36387A1	1					
22	Shim Kit, Lower Drive Shaft Bearing	18-2294	15-42637A1	1	62	Thrust Ring, Bearing Carrier	18-2342	68100-1	1
23	Drive Shaft	18-2180	45-42634	1	63	Ball Bearing	18-1155	30-88957A1	1
24	Drive Key Water Pump Impeller	N/A	28-56654	1	64	O-Ring, Bearing Carrier	18-7159	25-31534	1
25	Shift Shaft Washer	18-4267	12-29395	1	65	Needle Roller Bearing	18-1158	31-30956	1
26	Washer Rubber Shift Shaft Bushing	18-2340	12-31266	1	66	Bearing Carrier	18-2191	73020A-14	1
27	Shift Bushing	18-2154	23-30617A2	1	67	Oil Seals, Bearing Carrier	18-2002	26-76868	2
28	O-Ring, Shift Shaft Bushing	18-7153	25-25439	1	68	Tab Washer	18-2298	14-18323	1
29	Washer, Lower Shift Shaft	NSS	12-27880	1	69	Spanner Nut	18-3751	79448	1
30	Retaining Clip, Shift Shaft	NSS	53-29641	1	70	Thrust Washer	18-4220	13171, 77987	1
31	Stainless Steel Shift Shaft	18-2150	77481-1	1	71	Continuity Washer	N/A	13-423511	1
32	Oil Passage Seal	18-2944	26-45577	1	72	Brass Castle Washer	18-3714	12-31211A2	1
33	Dowel Pin, Gear Housing to Drive Shaft Housing	18-3226	10-30720	2	73	Tab Washer	18-3200	14-31210, 14-816629	1
34	Screw, Gear Housing to Drive Shaft Housing	18-2361	10-30206	1					
35	Nut, Gear Housing to Drive Shaft Housing	18-2362	11-13439-1	2					
36	Gasket, Gear Housing Drain Screw	18-2945	12-19183, 12-20260	1					
37	Plug, Oil Fill/Drain	18-2244	10-79953A2	1					
38	Insert, Water Pick (Stbd)	18-3199	93423-1	1					
39	Insert, Water Pick (Port)	118-3198	93424-1	1					
40	Screw, Insert to Gear Housing	18-3197	10-76156	1					
41	Nut, Insert Screw	18-2344	11-45812	1					
42	Trim Tab	18-6011	31640A1	1					
43	Screw, Trim Tab Gear Housing	18-6245	10-32470	1					

N/A Not Available

NSS Not Sold Separate



SEE PAGES 708-710 FOR COMPLETE REPLACEMENT HOUSINGS

Figure #	Description	Part #	O.E.M. #	Qty.	Figure #	Description	Part #	O.E.M. #	Qty.
1	Lower Gear Housing	18-2402	1623-5356A4	1	43	Screw, Gear Housing to Drive Shaft Housing	18-2361	10-30206	1
2	Water Tube Guide	18-3109	23-29804	1	44	Nut Gear Housing to Drive Shaft Housing	N/A	11-82671015	2
3	Bush Water Pump Housing	18-3110	26-38970	1	45	Gasket, Gear Housing Drain Screw	18-2945	12-19183, 12-20260	1
4	O-Ring, Upper - Drive Shaft	18-7158	25-30613	1	46	Plug, Oil Fill/Drain	18-2244	10-79953A2	1
5	Slinger	18-7426	25-30271	1	47	Insert, Water Pick (Stbd)	N/A	66885	1
6	Stainless Steel Locknuts (5/16-24)	18-3723	11-45592	1	48	Insert, Water Pick (Port)	N/A	66884	1
7	Stainless Steel Locknuts (1/4-28)	18-3722	11-20361, 11-35888	2	49	Screw Insert to Gear Housing	18-3197	10-76156	1
8	Washer	18-4275	12-29245	3	50	Nut, Insert Screw	18-2344	11-45812	1
9	Screw	18-3226	10-30720	1	51	Trim Tab	18-6011	31640A1	1
10	Washer, Water Pump Body	18-4270	12-36001	1	52	Screw, Trim Tab to Gear Housing	18-6245	10-32470	1
11	Upper Pump Housing	18-3116	46-96148A1	1	53	Needle Roller Bearing	18-1150	31-92366A1	1
12	Insert Cup	18-3114	48752	1	54	Lower Unit Gear Set (pinion gear)	18-2200	23-96084A4	1
13	Impeller	18-3017	47-89984	1	55	Pinion Nut	18-3719	11-35921	1
14	Drive Key	N/A	28-56654	1	56	Shift Crank	18-2130	76865	1
15	Gasket, Upper Water Pump to Wear Plate (upper)	18-2915	27-85609-1	1	57	Shift Spool Assembly	19755A2	18-2286	1
16	Impeller Plate	18-3117	32435	1	58	Shim Kit, Forward Gear Bearing	18-2285	15-47397A1	1
17	Gasket, Upper Water Pump to Wear Plate (lower)	18-2914	27-85608-1	1	59	Tapered Roller Bearing	18-1159	31-35928A1	1
18	Dowel Pin	18-3227	17-35973	2	60	Needle Roller Bearing	18-1157	31-30895	1
19	Water Pump Base	18-3417	46-57234A1	1	61	Lower Unit Gear Set (Forward)	18-2200	23-96084A4	1
20	Oil Seal (upper)	18-2026	26-16977	1	62	Spring, Retainer, Cross Pin	18-2348	24-30893	1
21	Oil Seal (lower)	18-2014	26-89238	1	63	Sliding Clutch	18-2202	52-66063	1
22	O-Ring (2.175 ID) & (2.1091 ID)	18-7176, 18-7196	25-90011	1	64	Cross Pin, Clutch to Clutch Actuating Shaft	18-2348	17-30632	1
23	Gasket, Water Pump Base to Gear Housing	18-2826	27-85610-1	1	65	Propeller Shaft	18-2166	44-66060, 44-66060-3	1
24	Pin, Driveshaft	N/A	17-30545	1	66	Shim Kit, Thrust Ring to Gear Housing	18-2284	15-31535A1	1
25	Spring	N/A	24-34576	1	67	Lower Unit Gear Set (reverse)	18-2200	43-96084A4	1
26	Tapered Roller Bearing	18-1164	31-53079A1	1	68	Thrust Ring, Bearing Carrier	18-3759	35915	1
27	Shim Kit, Drive Shaft Bearing	18-2295	15-57007A	1	69	Ball Bearing	18-1155	30-88957A1	1
28	Drive Shaft	18-2167	45-41939A1	1	70	O-Ring	18-7159	25-31534	1
29	Shift Shaft Washer	18-4267	12-29395	1	71	Needle Roller Bearing	18-1158	31-30956	1
30	Washer, Rubber Shift Shaft Bushing	18-2340	12-31266	1	72	Bearing Carrier Assembly	18-2191	73020A14	1
31	Oil Seal	26-89236	18-2009	1	73	Key, Locating - Bearing Carrier	N/A	28-30281	1
32	Shift Bushing	18-2154	23-30617A2	1	74	Oil Seals	18-2002	26-76868	2
33	O-Ring	18-7153	25-25439	1	75	Tab Washer	18-2299	14-79447	1
34	Washer, Lower Shift Shaft Bushing	N/A	12-27880	1	76	Spanner Nut	18-3751	79448	1
35	Retaining Clip, Shift Shaft	18-4295	53-29641	1	77	Thrust Washer	18-4220	13171, 77987	1
36	Stainless Steel Shift Shaft	18-2150	77481-1	1	78	Continuity Washer	NSS	13-423511	1
37	Stud, Gear Housing to Drive Shaft Housing (1-31/32")	N/A	16-56298	2	79	Brass Castle Washer	18-3714	12-31211A2	1
38	Stud, Water Pump to Gear Housing (3 - 3/8")	N/A	16-562972	1	80	Tab Washer	18-3200	14-31210, 14-816629	1
39	Stud, Gear Housing to Drive Shaft Housing (3 - 3/16")	N/A	16-46911	1	81	Prop Nut	18-3700	11-52707	1
40	Stud, Water Pump to Gear Housing (3 - 1/4")	N/A	16-69501	2					
41	Oil Passage Seal	18-2944	26-45577	1					
42	Dowel Pin, Gear Housing to Drive Shaft Housing	N/A	17-35973	2					

AR As required

NSS Not Sold Separate

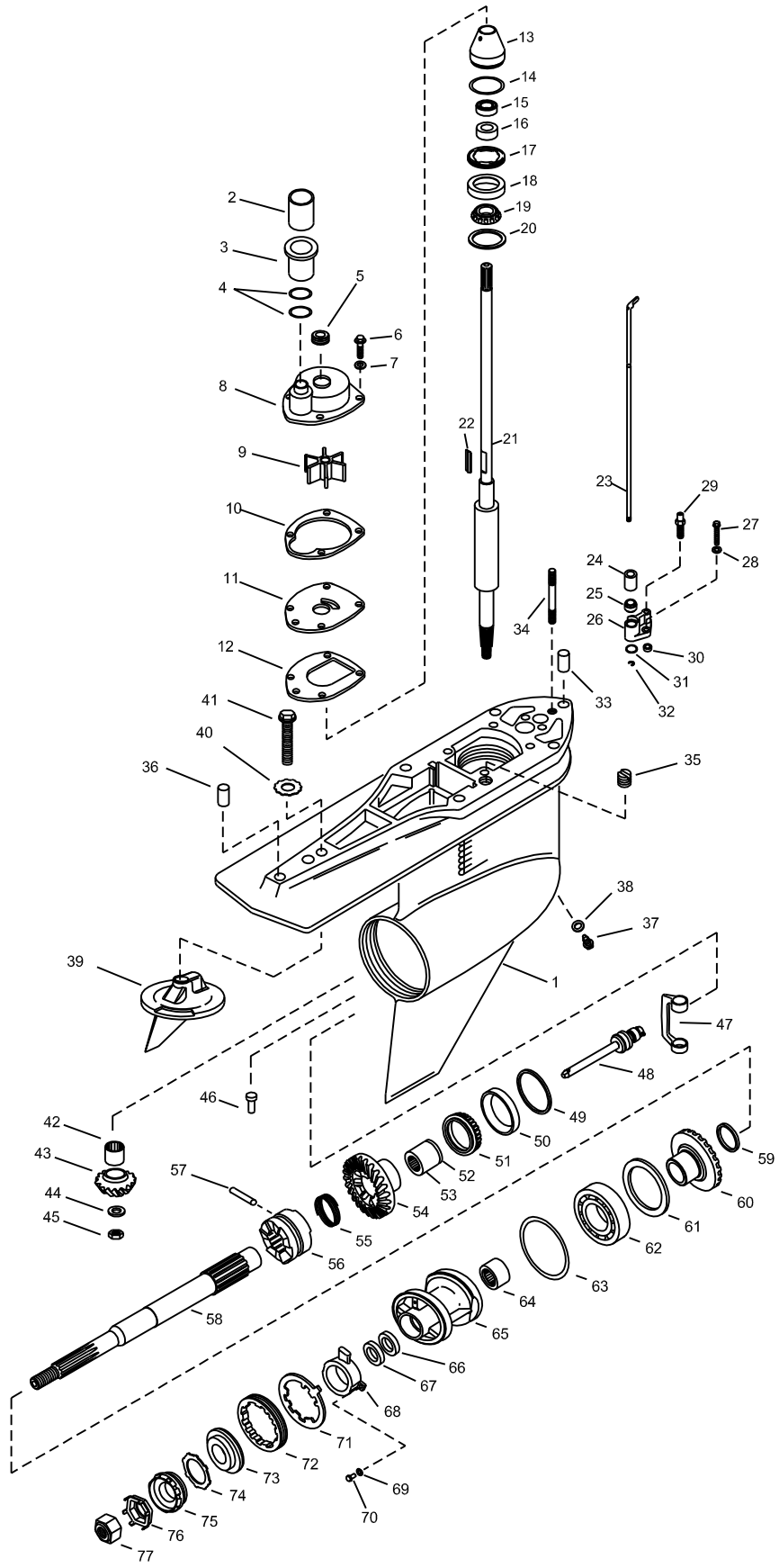

SEE PAGES 708-710 FOR COMPLETE REPLACEMENT HOUSINGS

Figure #	Description	Part #	O.E.M. #	Qty.	Figure #	Description	Part #	O.E.M. #	Qty.
1	Gear Housing	18-2415	1623-815822A36	1	48	Shift Spool Assembly	18-2286	818349A1	1
2	Sleeve	—	23-816573	1	49	Shim Kit	18-2285	15-47397A1	1
3	Coupling	18-3151	816597A1	1	50 & 51	Forward Gear, Outer Bearing	18-1159	31-35928A1	1
4	O-Rings	18-7420	25-21836	2	52	Retaining Clip, Inner Bearing	NSS	—	1
5	Face Seal	18-2599	26-816575A2	1	53	Forward Gear, Inner Bearing	18-1157	31-30895	1
6	Screw, 10-32 X 5/8	NSS	10-806290	4	54	Forward Gear	18-2206	43-828072A2	1
7	Star Washer	NSS	13-69432	4	55	Cross Pin Spring	18-2348	24-30893	1
8	Water Pump Body	18-3147	817275A1	1	56	Sliding Clutch	18-2202	52-824112	1
9	Impeller	18-3056	47-43026-2	1	57	Cross Pin	18-2357	17-30632	1
10	Gasket	18-2563	27-817277	1	58	Propeller Shaft	18-2166	44-824110	1
11	Face Plate	18-3122	817276	1	59	Spacer	—	23-824108	1
12	Gasket	18-2564	27-43033-1	1	60	Reverse Gear	18-2206	43-828072A2	1
13	Seal Carrier	18-2354	821759A2	1	61	Thrust Ring	18-2342	681001	1
14	O-Ring	18-7176	25-90011	1	62	Ball Bearing	18-1155	30-88957A1	1
15	Seal	18-2013	26-16977	1	63	O-Ring	18-7159	25-31534	1
16	Seal	18-2014	26-89238	1	64	Roller Bearing	18-1158	31-30956	1
17	Cover Nut	18-2346	824519	1	65	Bearing Carrier	18-2376	818763A10	1
18 & 19	Bearing, Upper Driveshaft (1.50-1.65 Ratio)	18-1143	31-36387A1	1	66	Seal	18-2002	26-14077	1
					67	Seal	18-2076	26-12224	1
	Bearing, Upper Driveshaft (1.47-1.62 Ratio)	18-1193	31-33138A1	1	68	Carrier Anode	18-6093	806105A1	1
					69	Lockwasher, Anode Mounting	—	13-69432	2
20	Shim Kit	18-2294	15-42637A1	1	70	Bolt, Anode Mounting	—	10-806290	2
21	Drive Shaft (1:47 & 1:62)	18-2331	45-853648	1	71	Tab Washer	18-2298	14-18323	1
					72	Cover Nut	18-3751	79448	1
	Drive Shaft (1:50 & 1:65)	18-2261	45-816919	1	73	Thrust Hub	18-4220	13171	1
					74	Continuity Washer	NSS	13-42351-1	1
22	Impeller Drive Key	18-3293	28-43037	1	75	Splined Washer	18-3714	12-31211A2	1
23	Shift Shaft	18-2320	815919A1	1	76	Tab Washer	18-3200	14-31210	1
24	Sleeve	18-2349	23-67370	1	77	Propeller Nut	18-3700	11-52707	1
25	Seal	18-2009	26-89236	1		Seal Kit (Not Pictured)	18-2646-1	26-816575A3	1
26	Shift Rod Bushing Assembly	18-2353	23-815921A21	1					
27	Screw, 10-32 X 5/8	NSS	10-806290	2					
28	Star Washer	NSS	13-69432	2					
29	Speedometer Pickup Fitting	—	NSS	1					
30	O-Ring	18-7440-1	25-36318	1					
31	O-Ring	18-7440-1	25-36318	1					
32	Retaining Ring	18-4295	53-29641	1					
33	Dowel Pin	—	17-43044	1					
34	Stud, Mounting	—	16-57984	1					
35	Seal	18-2944	26-45577	1					
36	Dowel Pin	—	17-43044	1					
37	Plug	18-2375	22-67892A1	1					
38	Gasket	18-2945	12-19183	1					
39	Trim Tab	18-6016	76214A5	1					
40	Washer, Anode Mounting	—	13-806210	1					
41	Bolt, Anode Mounting	—	10-806327	1					
42	Pinion Bearing	18-1117	31-42647A1	1					
43	Pinion Gear	18-2206	43-828072A2	1					
44	Washer	18-2343	12-92721	1					
45	Nut	18-3719	11-35921	1					
46	Pin	—	17-37972-1	1					
47	Shift Crank	18-2130	76865	1					

NSS Not Sold Separate



18-2292 SHIM KIT
 Drive Gear
 Replaces: 15-35980A1
 Contains (1) each
 .002, .003, .005, .006, .010, .025
 For: Mercuriser Vazer



18-2293 SHIM KIT
 Upper Bearing
 Replaces: 15-36178A1
 Contains (1) each .002, .003, .015
 (2) each .010
 For: Mercuriser Vazer



18-2294 SHIM KIT
 Lower Drive Shaft Bearing
 Replaces: 15-8M0063267, 15-42637A1
 Contains (1) each
 .002, .003, .005, .010, .020
 For: Mercuriser Vazer



18-2295 SHIM KIT
 Lower Drive Shaft Bearing
 Replaces: 15-57007A1
 Contains (1) each
 .002, .003, .005, .010, .020
 For: Mercuriser Vazer

SHIMS

Part #	Size	O.E. #
* 18-2282	Kit	15-32563A1 For: Mercuriser Vazer
* 18-2283	Kit	15-45691A1
* 18-2284	Kit	15-31535A1
* 18-2285	Kit	15-47397A1
18-2296	.055	15-71013



- * **18-2282** (1) each .002, .003, .005, .010, .025
- * **18-2283** (1) each .002, .003, .005, .010
- * **18-2284** (1) each .002, .003, .005, .010, .020
- * **18-2285** (1) each .002, .003, .005, .010, .020

SHIM KIT APPLICATION

HP	Serial Number	Bearing to Top Cover Kit	Bearing Cup to Drive Shaft Housing	Drive Gear	Drive Gear Spacer	Drive Shaft Bearing to Gear Housing	Reverse Gear	Forward Gear Kit
120/140	2062141 thru 2791956	18-2282 ②	18-2293	18-2292	18-2296	18-2295	18-2284 ⑤	18-2285
120/140	2791957 thru 4893634	18-2283 ④	18-2293	18-2292	18-2296	18-2295	18-2284 ⑤	18-2285
120/140	4893635 thru 6225576	18-2283	18-2293	18-2292	18-2296	18-2295	—	18-2285
160	2065190 thru 2763441	18-2282 ②	18-2293	18-2292	18-2296	18-2295	18-2284 ⑤	18-2285
165	2763442 thru 4890459	18-2283 ④	18-2293	18-2292	18-2296	18-2295	18-2284 ⑤	18-2285
165	4890460 & UP	18-2283	18-2293	18-2292	18-2296	18-2295	—	18-2285
888	3106717 & UP	18-2283 ③	18-2293	18-2292	18-2296	18-2295	18-2284 ⑤	18-2285
898/228	4782330 thru 4898729	18-2283	18-2293	18-2292	18-2296	18-2295	18-2284 ⑤	18-2285
898/228	4898730 thru 6225576	18-2283	18-2293	18-2292	18-2296	18-2295	—	18-2285
225-S	3856268 thru 4200499	18-2283	18-2293	18-2292	18-2296	18-2295	18-2284 ⑤	18-2285
233	4200500 & UP	18-2283	18-2293	18-2292	18-2296	18-2295	18-2284 ⑤	18-2285
250	4791300 thru 4898729	18-2283	18-2293	18-2292	18-2296	18-2295	18-2284 ⑤	18-2285
260	4898730 thru 6225576	18-2283	18-2293	18-2292	18-2296	18-2295	—	18-2285
470	4208730 thru 4893934	18-2283	18-2293	18-2292	18-2296	18-2295	18-2284 ⑤	18-2285
470	4893835 thru 6225576	18-2283	18-2293	18-2292	18-2296	18-2295	—	18-2285
485	4893835 & UP	18-2283	18-2293	18-2292	18-2296	18-2295	—	18-2285
R/MR/Alpha One	6225577 & UP (R)	18-2283	18-2293	18-2292	18-2296	18-2295	—	18-2285
R/MR/Alpha One	6225577 & UP (MR)	18-2283	18-2293	18-2292	18-2296	18-2294	① ⑥	18-2285
Alpha Gen II	D494569 thru F679999	18-2283	18-2293	18-2292	18-2296	18-2294	① ⑥	18-2285
Alpha Gen II	F680000 & UP	18-2282		18-2293	18-2292	18-2296	18-2294① ⑥	—

- ① For .208" Shim use Part Number 18-0208
- ① For .210" Shim use Part Number 18-0210
- ① For .212" Shim use Part Number 18-0212
- ① For .214" Shim use Part Number 18-0214
- ① For .218" Shim use Part Number 18-0218

- ① For .220" Shim use Part Number 18-0220
- ① For .222" Shim use Part Number 18-0222
- ① For .224" Shim use Part Number 18-0224
- ① For .226" Shim use Part Number 18-0226

- ② S/N #2187468 & Below use 18-2293
- ③ S/N #4433200 & UP Only
- ④ S/N #4530702 & UP Only
- ⑤ Kit
- ⑥ For Counter Rotation Only



18-2400 COMPLETE LOWER GEAR CASE
 Replaces: 1623-815822A53
 For: Ratios 1.47, 1.62, 1.81 & 1.94
 Fits: Gen II (1998 & up) 0L100040 & up



18-2411 DRIVE SHAFT HOUSING ASSEMBLY
 Replaces: 1547-861063A4
 For: Gen II Upper (1998-up), 0L100040-up, 1.47:1 Ratio/Gen II Upper (1998-up) 0L100040-up, 1.62/2.00:1 Ratio's/Gen II Upper (1998-up), 0L100040-up, 1.81:1 Ratio/Gen II Upper (1998-up), 0L100040-up, 1.94/2.40:1 Ratios
 Used with: 18-2416, 18-2417, 18-2418, 18-2419 Complete Upper Gear Cases



18-2415
GEAR HOUSING ASSEMBLY
 Replaces: 1623-815822A36
 For: Ratios 1.47, 1.62
 Gen II (1998 & up), (0L100040 & up)
 Used with: 18-2400 Complete Lower Gear Case



18-2416
COMPLETE UPPER GEAR CASE
 Replaces: 1547-861063A12
 For: Alpha Gen II (1991 & UP) for gear ratios 1.47:1, 1.50:1.
 Used with 18-2411 Drive Shaft Housing Assembly



18-2417
COMPLETE UPPER GEAR CASE
 Replaces: 1547-861063A10
 For: Alpha Gen II (1991 & UP) for gear ratios 1.62:1, 1.65:1, 2.0:1.
 Used with: 18-2411 Drive Shaft Housing Assembly



18-2418
COMPLETE UPPER GEAR CASE
 Replaces: 1547-861063A8
 For: Gen II (1991 & UP) for gear ratios 1.81:1, 1.84:1.
 Used with: 18-2411 Drive Shaft Housing Assembly



18-2419
COMPLETE UPPER GEAR CASE
 Replaces: 1547-861063A6
 For: Alpha Gen II (1991 & UP) for gear ratios 1.98:1 and 2.40:1
 Used with: 18-2411 Drive Shaft Housing Assembly



18-2450
COMPLETE UPPER GEAR CASE
 Replaces: 1547-9412A20
 1.5:1/1.47:1



18-2451
COMPLETE UPPER GEAR CASE
 Replaces: 1547-9412A21
 1.65:1/1.62:1



18-2452
COMPLETE UPPER GEAR CASE
 Replaces: 1547-9412A22
 1.84:1/1.81:1



18-2453
COMPLETE UPPER GEAR CASE
 Replaces: 1547-9412A23
 1.98:1/1.94:1



18-2443
COMPLETE LOWER GEAR CASE
 Replaces: 1623-8951A43
 For: R/MR/ALPHA

**18-2401
LOWER GEAR HOUSING**

Replaces: 1623-8951A27,
1623-8951A37
For: MR/ALPHA Style
Bore size 3.2635-3.2650. Includes tapered roller bearing for non-tractor 14/28 or 17/28 gears. When installing new gears use 18-2206-1 gear kit which includes tapered roller bearing 18-1156 for tractor 13/21 gears.



**18-2358
UPPER UNIT
GEAR REPAIR KIT**

Replaces: 43-803102T1
For: 20-22 Teeth: 1.50:1 (1.47:1)
Gen II applications serial number range up to OK999999 only



**18-2363
UPPER UNIT
GEAR REPAIR KIT**

Replaces: 43-803118T1
For: 20-24 Teeth: 1.98:1 (1.94/2.40:1)
Gen II applications serial number range up to OK999999 only



**18-2364
UPPER UNIT
GEAR REPAIR KIT**

Replaces: 43-803119T1
For: 24-24 Teeth: 1.65:1 (1.62:1)
Gen II applications serial number range up to OK999999 only



**18-2365
UPPER UNIT
GEAR REPAIR KIT**

Replaces: 43-803120T1
For: 17-19 Teeth: 1.84:1 (1.81:1)
Gen II applications serial number range up to OK999999 only



**18-6350K
UPPER UNIT
GEAR REPAIR KIT**

Replaces: 43-803104T1
For: Gen II (1998 & Up)(S/N OL100040 & Up)
1.62:1 and 2.00:1 Ratio



**18-6351K
UPPER UNIT
GEAR REPAIR KIT**

Replaces: 43-803103T1
For: Gen II (1998 & Up)(S/N OL100040 & Up)
1.47:1 Ratio



**18-6352K
UPPER UNIT
GEAR REPAIR KIT**

Replaces: 43-803106T1
For: Gen II (1998 & Up)(S/N OL100040 & Up)
1.94:1 and 2.40:1 Ratio



**18-6353K
UPPER UNIT
GEAR REPAIR KIT**

Replaces: 43-803105T1
For: Gen II (1998 & Up)(S/N OL100040 & Up)
1.81:1 Ratio



**18-2201
UPPER UNIT GEAR SET**

Replaces: 43-18410A2,
43-18411A2
Includes: (1) 18-1142
Mercuriser #31-32573A1
(1.5:1 Ratio)
(Drive Gear = 22 teeth Driven Gear = 20 teeth)
For most V-8 Drives and Gen II (S/N K999999 & BELOW)



Stern Drive Model	Beg. S/N	End. S/N	Stern Drive Model	Beg. S/N	End. S/N
225	3856268	4200499	888	3106717	& UP
260	4898730	6225576	V8R/MR/AlphaOne	6225577	& UP
898/228	4782330	6225576			



18-2203
UPPER UNIT GEAR SET
 Replaces: 43-45814A5
 (1.65:1 Ratio) (Drive Gear = 24 teeth
 Driven Gear = 24 teeth)
 For: 6 Cyl. Inline S/N K999999 & BELOW



18-2204
UPPER UNIT GEAR SET
 Replaces: 43-75325A3
 (1.84:1 Ratio)
 (Drive Gear = 17 teeth Driven Gear = 19 teeth)
 For: V-6 and 470/485 (4 Cyl. etc.) and Gen II
 (S/N K999999 & BELOW)



18-2205
UPPER UNIT GEAR SET
 Replaces: 43-55778A3
 (1.98:1 Ratio)
 (Drive Gear = 20 teeth Driven Gear = 24 teeth)
 For: 120/140 (S/N 2791957 & UP) and Gen II
 (S/N K999999 & BELOW)



18-6350
UPPER UNIT GEAR SET
 Replaces: 43-853640A2
 For: Gen II Upper (1998-up), 0L100040-up,
 1.62/2.00:1 Ratios (24-24 Teeth)
 Used with: 18-2417 Complete Upper Gear Case



18-6351
UPPER UNIT GEAR SET
 Replaces: 43-853641A2
 For: Alpha I (Gen II) (1998-up), 0L100040-up,
 1.47:1 Ratio (20-22 Teeth)
 Used with: 18-2416 Complete Upper Gear Case



18-6352
UPPER UNIT GEAR SET
 Replaces: 43-853642A2
 For: Alpha I (Gen II) (1998-up), 0L100040-up,
 1.94:1, 2.40:1 Ratios (20-24 Teeth)
 For: Mercruiser Vazer
 Used with: 18-2411 Drive Shaft Housing Assembly,
 18-2419 Complete Upper Gear Case



18-6353
UPPER GEAR KIT
 Replaces: 43-853643A2
 1.81 Ratio Upper Gear Set, 17-19 Teeth
 For: Alpha I Gen II 1998-up/0L00040-up
 For: Mercruiser Vazer

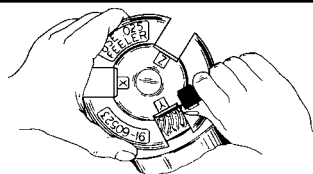

FIG. #1

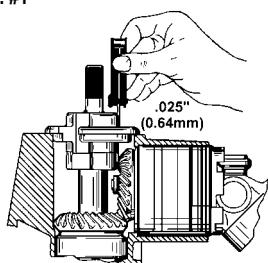

FIG. #2

FIGURES #1 - #2

Provides two separate views of the upper gear housing driven gear being properly shimmed using the Sierra installation tools.

FIGURES #3 - #4

Provides the same views of the drive gear being shimmed in the same application.

NOTE:

This installation **cannot** be performed correctly without the Sierra 18-9856 shim tool. Improper installation **will** result in gear failure. The .025 referenced in **FIG #2** & **FIG #4** is achieved when .026 will not fit the clearance but .025 will.

A service manual should always be consulted for step-by-step instructions.

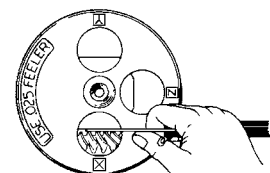

FIG. #3

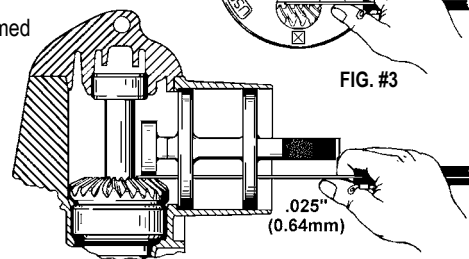

FIG. #4



18-2256
UPPER GEAR KIT
 Replaces: 43-803116T1
 Most V-8 Drives (1.5:1 Ratio)

— CONTAINS —

Part #	Description	O.E. #	Qty.
18-2201	Upper Unit Gear Set	43-18410A2	1
18-2648	Seal Kit	26-32511A2	1
18-2619-1	Outdrive Gasket Set	27-94996A1	1
18-2820	Drive Shaft Housing to Bell Housing Gasket	27-64818	1
18-2743	Drive Shaft Housing to Bell Housing Gasket	27-94996-2	1
18-1160	Bearing	31-35988A2	1
18-1165	Bearing	31-61100A1	1
18-1142	Bearing	31-35990A1	1

— CONTAINS —

Part #	Description	O.E. #	Qty.
18-2203	Gear Set	43-45814A5	1
18-2648	Seal Kit	26-32511A2	1
18-2619-1	Outdrive Gasket Set	27-94996A1	1
18-2820	Drive Shaft Housing to Bell Housing Gasket	27-64818	1
18-1160	Bearing	31-35988A2	1
18-1161	Bearing	31-35990A1	1
18-1165	Bearing	31-61100A1	1
18-2743	Drive Shaft Housing to Bell Housing Gasket	27-94996-2	1

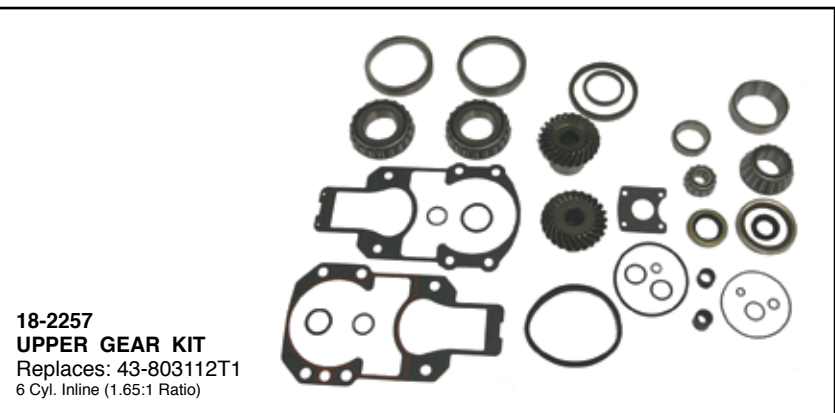

— CONTAINS —

Part #	Description	O.E. #	Qty.
18-2204	Gear Set	43-75325A3	1
18-2648	Seal Kit	26-32511A2	1
18-2619-1	Outdrive Gasket Set	27-94996A1	1
18-2820	Drive Shaft Housing to Bell Housing Gasket	27-64818	1
18-1160	Bearing	31-35988A2	1
18-1161	Bearing	31-35990A1	1
18-2743	Drive Shaft Housing to Bell Housing Gasket	27-94996-2	1
18-1165	Bearing	31-61100A1	1

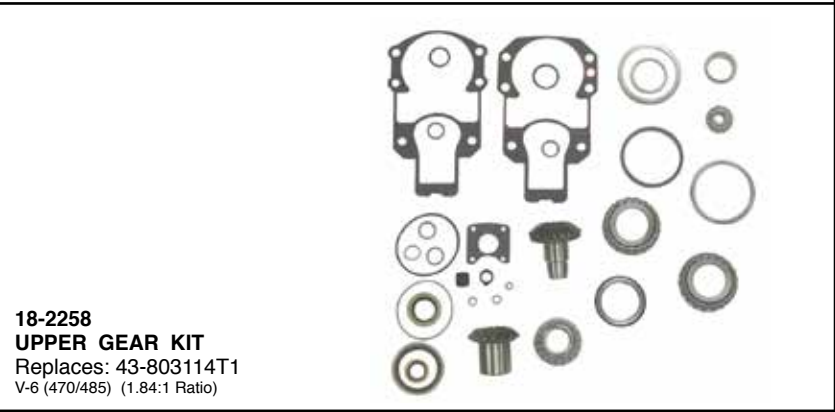

— CONTAINS —

Part #	Description	O.E. #	Qty.
18-2205	Gear Set	43-55778A3	1
18-2648	Seal Kit	26-32511A2	1
18-2619-1	Outdrive Gasket Set	27-94996A1	1
18-2820	Drive Shaft Housing to Bell Housing Gasket	27-64818	1
18-1160	Bearing	31-35988A2	1
18-1161	Bearing	31-35990A1	1
18-1165	Bearing	31-61100A1	1
18-2743	Drive Shaft Housing to Bell Housing Gasket	27-94996-2	1

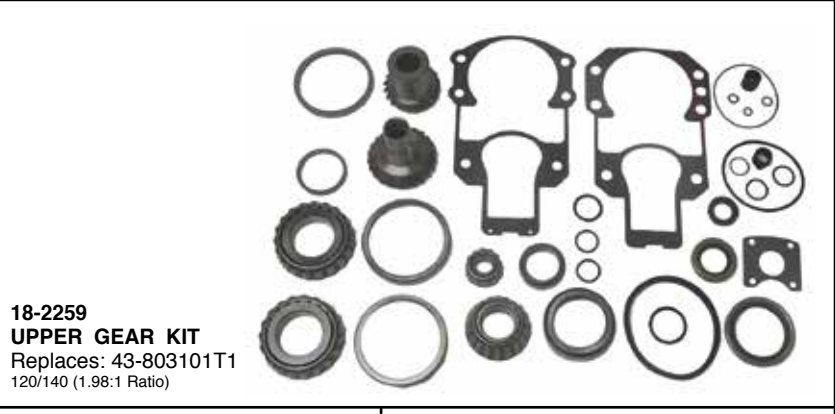



**18-6401
YOKE ASSEMBLY**
Replaces: 12784A10, 864244A2
For Bravo I, II, III (OB664190 - up)
(1998-05)



**18-6402
YOKE ASSEMBLY**
Replaces: 864281A2
For: Alpha I (Gen II) (1998 & up) (OL100040 & up) GKN Style
For: Mercruiser Vazer



**18-9218
YOKE ASSEMBLY**
Replaces: 814819A2
For all #1, R/MR/ALPHA Gen II
OK999999 & Below (1971-97)



**18-2128
CENTER SOCKET**
Replaces: 39383T, 343831
(Rockwell)
Fits IA/IB/IC & EZ, MC-I, R, MR, Alpha One, Gen II
(OL949778 & below), Bravo (OM111207 & below),
MC II & TS



**18-1711
U-JOINT**
Replaces: 862132T
For: Bravo One, Two, & Three (All Ratios), Bravo One X/
Two X, Three X (All Ratios), Bravo One XR/XZ(All Ratios),
Bravo One XR Sportmaster (All Ratios) & Integrated Transom



**18-2097
U-JOINT**
Permalube
Replaces: 805536A2
For: Generation II F680000 & UP



**18-2104
U-JOINT**
Heavy Duty
Replaces: 75832A2, 75832T
Includes both straight and 90° grease fitting.
(Rockwell)
Fits all #1 and ALPHA I Units S/N 1684188-B418818.
Also TR/TRS and II SSM.



**18-2174
U-JOINT**
Heavy Duty
Replaces: 75832A3, 758321, 75832T1
Includes both straight and 90° grease fitting.
(Rockwell)
Fits ALPHA I Units S/N B418819 & above.
Also fits ALPHA I SS & BRAVO



**18-6406
U-JOINT ASSEMBLY**
Replaces: 865496A01, 865493A01
GKN new style with external clips.
Fits: Alpha I Gen II OL949779 & UP,
Bravo OM111208 & UP
For: Mercruiser Vazer



**18-8311
GIMBAL HOUSING REBUILD KIT**
Fits: Alpha One



**18-8312
GIMBAL HOUSING REBUILD KIT**
Fits: Gen II



**18-8313
GIMBAL HOUSING REBUILD KIT**
Fits: Bravo



**18-21001
GIMBAL BEARING**
Replaces: 30-879194A02
Fits: MC-1, R, MR and Alpha(1974-97),
Gen II(1991-97), Bravo I/II/III (1988-95)



**18-21006
GIMBAL BEARING**
Replaces: 30-879194A01
Fits: Gen II (1998-10), Bravo I/II/III & X/XR/XZ (1996-10)



**18-21005
GIMBAL BEARING**
Replaces: 30-862540A3
Fits: All Bravos, Alpha One Gen II (1998-up)



**18-21005K
SEAL & GIMBAL BEARING KIT**
Fits: Gen II (1998-Up) and all Bravo



**18-2101
GIMBAL BEARING**
Replaces: 30-36418
(Link-Belt)



**18-2100
HEAVY DUTY GIMBAL BEARING**
Replaces: 30-60794A4
(Link Belt)
Fits: Mercruiser- 120HP / 140HP
(2791957-6225576) (With Gimbal Trim Sender), 165HP (2763442 & Up),
225S (3856268-4200499), 228HP (4782330 & Up), 233HP (4200500 & Up),
250HP (4791300 & Up)



**18-2100K
SEAL & GIMBAL
BEARING KIT**
Fits: 1, R, MR and Alpha (1974-97)



**18-1705
HINGE PIN**
Replaces: 77123
(with grease port) For gimbal housing
Fits: Alpha, Alpha Gen II
S/N 0M815638 & Lower



**18-1706
HINGE PIN**
Replaces: 10-86801
For gimbal housing
Fits: Alpha Gen II S/N 0M85639 & UP
Bravo All Models with trim sender



**18-2381
UPPER DRIVE UNIT CAP**
Replaces: 94998A2, 94998A4
S/N 6225577 & Later Alpha I, except Gen II



**18-2382
UPPER DRIVE UNIT CAP**
Replaces: 828692A1
For: Gen II S/N F680000 & UP

GIMBAL BEARING APPLICATION

Model	Year Range	Beginning Serial No.	Ending Serial No.	Gimbal Bearing	Model	Year Range	Beginning Serial No.	Ending Serial No.	Gimbal Bearing
60	1965-1972	1830753	3225967		898 / 228	1977-1982	4782330	6225576	18-21001
80	1965-1972	1830753	3225967		250 / 260	1977-1982	1791300	6225576	18-21001
90	1965-1972	1830753	3225967		R / MR / ALPHA I	1983-1990	6225577	& UP	18-21001
I	1963	1534570	1684187		ALPHA I SS	1986-1989	A545004	& UP	18-21001
IA	1964	1684186	1777798	18-2101	ALPHA I GEN II	1991-1997	D469859	K999999	18-21001
IB	1964	1684188	1777798	18-2101	ALPHA I GEN II	1998-2010	L100040	& UP	18-21001
IC	1964	1684188	1777798	18-2101	VASER	2007-2010	W995000	& UP	
EZ-SHIFT	1964	1684188	1777798	18-2101	BRAVO I	1988-1995	B664190	F729999	18-21001
120 / 140	1967-1973	2062141	3780849	18-2101	BRAVO II	1988-1995	B664190	F729999	18-21001
120 / 140	1974-1982	3780850	6225576	18-21001	BRAVO III	1988-1995	B664190	F729999	18-21001
470 / 485	1976-1982	4208730	6225575	18-21001	BRAVO I	1996-2010	F730000	& UP	18-21006
160 / 165	1967-1973	2065190	3780849	18-2101	BRAVO II	1996-2010	F730000	& UP	18-21006
165	1974-1981	3780850	& UP	18-21001	BRAVO III	1996-2010	F730000	& UP	18-21006
888	1971-1973	3106717	3784374	18-2101	X / XR / XZ	1996-2010	F730000	& UP	18-21006
888	1974-1977	3784375	& UP	18-21001	BLACK HAWK	1994-1995	F186717	& UP	18-21001
225 / 233	1974	3856268	& UP	18-21001					



**18-2179
DRIVE SHAFT**
Replaces: 45-55796



**18-2324
DRIVE SHAFT**
Replaces: 45-557961
For: Gen II (S/N F680000 & UP),
Mercruiser Vazer



**18-3713
LOCK NUT**
Replaces: 11-22339
5/8" - 18



**18-3712
CARRIER NUT WASHER**
Replaces: 12-45810



**18-3752
RETAINING NUT**
Replaces: 816811-1,
8168112



**18-4296
SPACER RING**
Replaces: 35983
(Upper Housing)



**18-0577
CARRIER OIL
SEAL ASSEMBLY**
Replaces: 66081A2



**18-3219
WATER TUBE &
COVER ASSEMBLY**
Replaces: 42724A3
For: Merc I and Alpha I drives
Models: I, 1A, 1B, 1C, 1CEZ, 120, 140,
160, 165, 888, 898, 228, 225-S, 233, 250,
260, 470, 485, R, MR, Alpha
18-3229 BOLT Replaces: 10-28668



**18-2322
SHIFT SHAFT**
Replaces: 621041
For: I and Alpha I



**18-2169
SHIFT ARM**
Replaces: 45589A3



**18-3749
UPPER SHIFT SHAFT**
Replaces: 816685
For: Alpha Gen II (1991-98)



**18-2599
FACE SEAL & TOOL**
Replaces: 26-816575A2
For: ALPHA I GENERATION II



**18-2622
BELL HOUSING BUSHING KIT**
Replaces: 23-805041A2



**18-3760
BELL HOUSING BUSHING KIT**
Replaces: 23-806036A1
For: GEN II Serial # F680000 & UP



**18-2161
SHIFT ARM**
Replaces: 45518A2



**18-2170
SHIFT ARM SCREW**
Replaces: 10-45590



**18-2162
SHIFT CABLE SLIDE
& SCREW**
Replaces: 33981T



**18-2162E
SHIFT CABLE SLIDE
& SCREW**
For Extreme Cables Only

PKG. OF 5



**18-2163
18-2163-9①
SHIFT SLIDE SCREW**
Replaces: 10-31700

PKG. OF 5



**18-2163E-9①
SHIFT SLIDE SCREW**
For Extreme Cables Only



**18-2715
CHECK VALVE KIT**
Replaces: 24-17997A1
For: Alpha I Generation II and
Bravo I, II, and III Drives



**18-2724
TRANSOM SEAL**
Replaces: 3713
For: Alpha Gen II, All Bravo

① Priced per Package

— CONTAINS —

Part #	Description	O.E. #	Qty.
18-2619-1	Outdrive Gasket Set	27-64818A3 27-94996A1,Q2	1
18-2100	Gimbal Bearing	30-60794A4	1
18-2161	Shift Arm	45518A2	1
18-2751	U-Joint Bellows	60932A4	1
18-2750	Exhaust Bellows	32734A3, 18654A1	1
18-2753-1	Shift Cable Bellows	74639	1
18-3601	Water Intake Hose	32-32461	1
18-3602	Water Intake Hose	32-41725-33	1
18-7310	Hose Clamp	—	2
18-7314	Stainless Steel Hose Clamp	—	1
18-7315	Stainless Steel Hose Clamp	—	1



**18-2601-1
TRANSOM SEAL KIT**
Replaces: 30-803097T1
R, MR, ALPHA 1 (1983-90) S/N 6225577 & UP
ALPHA 1 SS (1986-89) S/N OA 545004 & UP

— CONTAINS —

Part #	Description	O.E. #	Qty.
18-2100	Gimbal Bearing	30-60794A4	1
18-2751	U-Joint Bellows	60932A4	1
18-2760	Exhaust Tube	78458A1	1
18-3601	Water Intake Hose	32-32461	1
18-3602	Water Intake Hose	32-41725-33	1
18-2743	Drive Shaft Housing to Bell Housing Gasket	27-94996-2	1
18-2840	Bell Housing Gasket	27-35982	1
18-7153	O-Ring	25-25439	1
18-7117	O-Ring	25-35027	1
18-7310	Hose Clamp	—	2
18-7170	O-Ring	25-33504	1
18-7312	Hose Clamp	—	1
18-2753-1	Shift Cable Bellows	74639	1
18-7321	Bellows Clamp	54-38863	1



**18-8205
TRANSOM SEAL KIT**
Replaces: 30-803098T1
For: 1, R, MR, Alpha 1 with exhaust tube

— CONTAINS —

Part #	Description	O.E. #	Qty.
18-3602	Water Intake Hose	32-41725-33	1
18-7310	Hose Clamp	—	2
18-7312	Hose Clamp	—	1
18-2753-1	Shift Cable Bellows	74639	1
18-7321	Bellows Clamp	54-38863	1
18-2100	Gimbal Bearing	30-60794A4	1
18-2743	Drive Shaft Housing to Bell Housing Gasket	27-94996-2	1
18-2840	Bell Housing Gasket	27-35982	1
18-7153	O-Ring	25-25439	1
18-7170	O-Ring	25-33504	1
18-7117	O-Ring	25-35027	1
18-2750	Exhaust Bellows	18654A1, 32734A3	1
18-2747	Drive Bellows	816431A1	1



**18-8206-1
TRANSOM SEAL KIT**
Replaces: 30-803099T1
For: Alpha 1 Gen II

— CONTAINS —

Part #	Description	O.E. #	Qty.
18-2753-1	Shift Cable Bellow	74639	1
18-2100	Gimbal Bearing	30-60794A4	1
18-2756	U-Joint Bellows	86840A3	1
18-2750	Exhaust Bellows	32734A3	1
18-2760	Exhaust Tube	78458A1	1
18-3603	Water Hose	32-43437	1
18-2615	Outdrive Mounting Kit	16755A1	1



**18-8212
TRANSOM SEAL KIT**
Replaces: 30-803100T1
For: All Bravos 1982 & up



**18-8213
TRANSOM SEAL KIT**
Replaces:
Mercury 30-803097T1
For: R, MR, Alpha 1 (1983-90)
S/N 6225577-0D469858; Alpha
1 SS (1986-89) S/N OA545004
& Up



**18-8217
TRANSOM SEAL KIT**
Replaces:
Mercury 30-803098T1
For: R, MR, Alpha 1 (1983-90)
w/exhaust tube S/N 6225577-
0D469858; Alpha 1 SS (1986-89)
w/exhaust tube S/N OA545004
& Up



**18-8218
TRANSOM SEAL KIT**
Replaces:
Mercury 30-803099T1
For: Alpha 1 Gen II (1991 &
Up) S/N 0D469859 & Up



**18-8219
TRANSOM SEAL KIT**
Replaces:
Mercury 30-803100T1
For: Bravo I/II/III (1988 &
Up) S/N 0B664190 & Up;
Blackhawk (1994-95) S/N
0F186717 & Up

 <p>18-2747 U-JOINT BELLOWS Alpha 1, Gen II Replaces: 816431A1</p>	 <p>18-2750 EXHAUST BELLOWS All #1 Units, Gen II, TRS, & Bravo I, II, III Replaces: 32734A3, 18654A1 (Includes 18-7314 Clamp)</p>	 <p>18-2751 U-JOINT BELLOWS All #1 units with ridge (S/N 3469428 & UP) Replaces: 60932A4 (Includes 18-7316 Clamp)</p>
--	---	--

 <p>18-2752 U-JOINT BELLOWS All #1 units without ridge (S/N 3443920 & BELOW) Replaces: 36223A2 (Includes 18-7316 Clamp)</p>	<p>① 18-2753-2D</p>  <p>18-2753-2 SHIFT CABLE BELLOWS All #1, #2 units, Alpha, Bravo I, II, III Replaces: 74639, 74639A2 (Includes 18-7321 Clamp)</p>	 <p>18-2756 U-JOINT BELLOWS Replaces: 86840A3, 86840A05 Fits all Bravo and Blackhawk models</p>	 <p>18-1710 BELLOW FLANGE RING Replaces: 862209 Fits: All Bravo</p>
--	---	---	--

 <p>18-1728 BELLOW FLANGE RING Replaces: 816607 Fits: Alpha One (GenII) (1991 and Up)</p>	 <p>18-2746 EXHAUST BOOT Replaces: 32-14358T (4" Lower Tube)</p>	 <p>18-2748 EXHAUST BOOT Replaces: 32-44348T (4" Upper Tube)</p>	 <p>18-2759 EXHAUST TUBE Replaces: 53114A1</p>
--	--	---	--

 <p>18-2760 EXHAUST TUBE Replaces: 78458A1 (Includes 18-7314 Clamp) For: #1, Bravo I, II, III</p>	 <p>18-2761 EXHAUST TUBE 3" I.D. Replaces: 32-90949T</p>	 <p>18-2762 EXHAUST TUBE Replaces: 70981A3</p>	 <p>18-2770 EXHAUST TUBE Replaces: 32-807458T</p>
--	---	--	--

① Items ending in "D" are Display Packaged - Regular number is Non-Display

BELLOWS APPLICATION

Model	Years	Serial #	Exhaust Bellows	Shift Cable Bellows	U-Joint Bellows
I/1A/1B/1C & EZ	1963-1966	1534570-2065186	18-2750	18-2753-2	18-2752
120/140/160/165	1967-1972	2062141-3443920	18-2750	18-2753-2	18-2752
120/140/160/165	1972-1982	3469428-6225576	18-2750	18-2753-2	18-2751
888	1971-1972	3106717-3472477	18-2750	18-2753-2	18-2752
888	1973-1977	3472478 & Up	18-2750	18-2753-2	18-2751
225/233	1974-1977	3856268 & Up	18-2750	18-2753-2	18-2751
898/228/250/260	1977-1982	4782330-6225576	18-2750	18-2753-2	18-2751
R/MR/Alpha One	1983-1990	6225577 & Up	18-2750	18-2753-2	18-2751
R/MR/Alpha One	1983-1990	6225577 & Up	18-2760 ②	18-2753-2	18-2751
Alpha One Gen II	1991 & Newer	0D469859 & Up	18-2750	18-2753-2	18-2747
Bravo I/II/III	1988 & Newer	0B664190 & Up	18-2750	18-2753-2	18-2756
Bravo I/II/III	1988 & Newer	0B664190 & Up	18-2760 ②	18-2753-2	18-2756
Blackhawk	1994-1995	0F18677 & Up	18-2750	18-2753-2	18-2756
Blackhawk	1994-1995	0F18677 & Up	18-2760 ②	18-2753-2	18-2756
II	1962-1969	1474909-2671321	—	18-2753-2	—
215H	1970	2782203-2909034	—	—	18-2752
215E	1970-1972	2909035-2915034	—	18-2753-2	18-2752
TR/TRS	1973-1993	3377316 & Up	—	—	18-2751

② Tube



PKG. OF 5

**18-9031
BELLOWS ADHESIVE**
Replaces: 92-86166
2 Fluid oz.



**18-7321
18-7321-9②
BELLOWS CLAMP**
Replaces: 54-38863



INNER SHIFT CABLE
18-2159
Replaces: 66069A2
Use in 18-2157, 18-2158 and their Mercruiser equivalent as replacement wire and tube
Stranded Core 73"
18-2189
Replaces: 38399A2
Use with 18-2248
Inner Core Wire 59"



**18-2160
SHIFT CABLE
SUPPORT TUBE**
Replaces: 32-38377
Replaces tube on 18-2157, 18-2158 & 18-2159



**18-2248
SHIFT CABLE
ASSEMBLY**
Replaces: 73723A1
Mercruiser #1 Drives S/N 1562900-6225576 for forward installation into bell housing. Has new style armored strand construction. (No support tube) 54" conduit with hardware package.



18-2157
Replaces:
41951A1, 19543A4
Mercruiser 1 drives S/N 6225577 & UP For AFT installation into bell housing. Has old style stranded core wire with soldered tip (Uses Support Tube).
18-2158
Mercruiser #1 Drives S/N 1562900-6225576 for forward installation into bell housing. Has old style stranded core wire with soldered tip. (Uses support tube) 63" conduit



SHIFT CABLE ASSEMBLY

**18-2190
SHIFT CABLE**
Replaces: 19543A4, A10
Mercruiser 1 drives S/N 6225577 & UP
For AFT installation into bell housing. For use in applications using core wire with armored strand construction (No Support Tube). 63" Conduit with hardware package.



**18-2190E
SHIFT CABLE**
Replaces: 19543A4, 19543A10
S/N 6225577 & UP. For AFT installation into bell housing. For use in applications using core wire with armored strand construction (No Support Tube). 63" Conduit with hardware package. Lower Shift Cable- Alpha One (Gen II) (1991-97)
Requires 18-9806E (Xtreme Shift Cable Tool) to complete installation



XTREME

**18-2145
SHIFT CABLE**
Replaces: 815471A3, A6



**18-2145E
SHIFT CABLE**
Replaces: 815471, A3, A6
Bravo One, Two, & Three (All Ratios), Bravo One X/Two X, Three X (All Ratios), Bravo One XR/XZ (All Ratios), Bravo One XR Sportmaster (All Ratios) & Integrated Transom



XTREME

**18-9806E
SHIFT CABLE TOOL**
Installs and removes shift cables on MC-I, R-MR, Alpha I, Alpha I Gen II drive units. Use with 18-2190 and 18-2190E cables.



**18-2149
SHIFT CABLE GUIDE**
Replaces: 43433
For: Alpha & Bravo cables



PKG OF 25



18-2303
18-2303-9^①
ANCHOR
SCREW SET
 Replaces: 10-20518
 For: #1R, MR, Alpha, Alpha I,
 Gen II & Bravo



18-3754
CABLE ANCHOR
 Replaces: 43436
 For: #1R, MR, Alpha, Alpha I, Gen II
 & Bravo



18-2600
LOWER SHIFT CABLE KIT
 — CONTAINS —

Part #	Description	O.E. #	Qty.
18-2619-1	Outdrive Gasket Set	27-94996A1	1
18-2753-1	Shift Cable Bellows	74639	1
18-2248	Shift Cable Assembly	73723A1	1
18-2162	Shift Slide & Screw	33981T	1
18-2149	Shift Cable End Kit	43433	1
18-2163	Shift Slide Screw	10-31700	1
18-2743	Drive Shaft Housing to Bell Housing Gasket	27-94996-2	1
18-2820	Drive Shaft Housing to Bell Housing Gasket	27-64818	1
18-2843	Drive Shaft Housing to Bell Housing Gasket	27-94996	1



18-2603
LOWER SHIFT
CABLE KIT
 Replaces: 19543T-1
ALPHA I GENERATION II
 — CONTAINS —

Part #	Description	O.E. #	Qty.
18-2619-1	Outdrive Gasket Set	27-94996A1	1
18-2753-1	Shift Cable Bellows	74639	1
18-2190	Shift Cable Assembly	19543A4	1
18-2743	Drive Shaft Housing to Bell Housing Gasket	27-94996-2	1



18-2603E
LOWER SHIFT
CABLE KIT (EXTREME)
 Replaces: 19543T1
 For: Alpha I Gen II
 Requires 18-9806E (Xtreme Shift Cable Tool) to complete installation



18-2604
LOWER SHIFT CABLE KIT
 Replaces: 815471T1
BRAVO
 — CONTAINS —

Part #	Description	O.E. #	Qty.
18-2145	Bravo Shift Cable	815471A3	1
18-2149	Shift Cable End Kit	43433	1
18-2753-1	Shift Cable Bellows	74639	1
18-2615	Outdrive Gasket Set	—	1



18-2604E
LOWER SHIFT CABLE KIT
(EXTREME)
 Replaces: 815471T1
 For: Bravo

STAINLESS STEEL CLAMPS		
Part #	Diameter Size	Std. #
18-7307	5/16" to 7/8"	006
18-7308	9/16" to 1 1/16"	010
18-7309	9/16" to 1 1/4"	012
18-7310	1 1/16" to 1 1/2"	016
18-7311	3/4" to 1 3/4"	020
18-7312	1 1/16" to 2"	024
18-7313	1 9/16" to 2 1/2"	032
18-7314 ^②	2 9/16" to 3 1/2"	048
18-7315	2 1/2" to 4 1/2"	064
18-7316 ^③	3" to 5"	072
18-7317	5" to 7"	104

GRADE 316
STAINLESS STEEL WORM GEAR HOSE CLAMPS



All components are manufactured from Marine Grade 316 stainless steel. These clamps are designed to fit many applications from 5/16" to 7" diameter hoses.



18-2175
ENGINE
COUPLER
 Replaces: 18643A7
 Flex plate style for late model, small crankshaft bolt pattern, style engines



18-2195
ENGINE
COUPLER
 Replaces: 12632A7
 Flex plate style for GM 4 Cyl engines with late style, small crankshaft bolt pattern

^① For use with 3" Bellows ^② O.E. #54-32533 ^③ O.E. #s 54-31765, 54-815504372

18-2323 ENGINE COUPLER

Replaces: 18643A5
(Same as 18-2175 without yoke)



18-2321 ENGINE COUPLER

Replaces: 12632A6
(Same as 18-2195 without yoke)



18-2412 ENGINE COUPLER

Replaces: 18311A17, 861523A9
For: Bravo



18-2413 ENGINE COUPLER

Replaces: 69354A2
For: 470, 485 (224 cu. in.)
S/N 4208730-6218036 (1976-1982)



18-2414 ENGINE COUPLER

Replaces: 97432A2
For: 165, 170, 470, 3.7L S/N 6170297 & UP (1983-1989)
180, 190, 488, 3.7LX S/N 6170297 & UP (1983-1989)



18-2171 ENGINE COUPLER

Replaces: 76850A2
For all GM engines except MR/ALPHA/BRAVO with "Triangular", 3-Bolt coupler



18-2172 ENGINE COUPLER

Replaces: 14505A2
Used when replacing V6 or V8 2 piece rear main seal with 3-1/2" crankshaft bolt pattern to a newer 1 piece rear main seal engine with 3" bolt pattern



18-2173 ENGINE COUPLER

Replaces: 59826A3
For Ford engines



ENGINE COUPLER APPLICATION

HP	Liter	Model	CID	# Cyl	Stroke	Years	Serial #	Part #	HP	Liter	Model	CID	# Cyl	Stroke	Years	Serial #	Part #
110		110	153	4		1963-1966	1537370 - 2044033	18-2171			190	283	V-8	4	1963-1964	1564539 - 1730903	18-2171
120		120	153	4		1964-1982	1537370 - 6229717	18-2171	5.0L		200	305	V-8	4	1985-1986	6899058 - B525981	18-2171 ①
120		120	153	4	4	1964-1982	1666601 - 6229717	18-2171	5.0L		200	305	V-8	4	1985-1986	6899058 - B525981	18-2175 ②
120		120	153	4	4	1983-1986	6229718 - B531853	18-2171 ③	5.0L		200	305	V-8	4	1985-1987	6899058 - B774444	18-2175
120		120	153	4	4	1983-1986	6229718 - B531853	18-2195 ④	5.0L		228	305	V-8	4	1977-1982	4765100 - 6218461	18-2171
	2.5L	2.5L	153	4	4	1987-1989	B531854 - C853255	18-2171 ⑤	5.0L		228	305	V-8	4	1977-1984	6218462 - 6899268	18-2171
	2.5L	2.5L	153	4	4	1987-1989	B531854 - C853256	18-2195 ⑥	5.0L		230	305	V-8	4	1985-1987	6899269 - B773739	18-2171 ⑦
140		140	181	4	4	1968-1982	2508261 - 6229717	18-2171	5.0L		230	305	V-8	4	1985-1987	6899269 - B773739	18-2175 ⑧
140		140	181	4	4	1983-1986	6229718 - B450800	18-2171 ⑨	5.0L		5.0L ALPHA	305	V-8	4	1988-1993	B774445 - F000000	18-2175
140		140	181	4	4	1983-1986	6229718 - B450800	18-2195 ⑩	5.0L		5.0L ALPHA	305	V-8	4	1994-1995	F000001 - F600999	18-2323
140		140 INLINE 6		6	4	1963	1538930 - 1725960	18-2171	5.0L		5.0L GEN+ ALPHA	305	V-8	4	1998-2010	L015751 & UP	18-2323
	3.0L	3.0L	181	4	4	1987-1989	B450801 - C856558	18-2171 ⑪	5.0L		5.0L GEN + BRAVO	305	V-8	4	1998-2010	L015751 & UP	18-2412 ⑫
	3.0L	3.0L	181	4	4	1987-1989	B450801 - C856558	18-2195 ⑬	5.0L		5.0L EFI ALPHA	305	V-8	4	1998-2010	L012052 - M299999	18-2323
	3.0L	3.0L	181	4	4	1990-1994	C856559 - F603999	18-2195	5.0L		5.0L EFI BRAVO	305	V-8	4	1998-2010	L015751 - M299999	18-2412
	3.0L	3.0L MPI	181	4	4	1998-2010	L097000 & UP	18-2323	5.0L		5.0L 5.0LX ALPHA	305	V-8	4	1988-1993	B773740-F000000	18-2175 ⑭
	3.0L	3.0L MPI	181	4	4	2008-2010	A072812 & UP	18-2323	5.0L		5.0LX ALPHA	305	V-8	4	1994-2007	F000001 & UP	18-2323
	3.0L	3.0LX	181	4	4	1990-1993	C856559 - F000000	18-2195	5.0L		5.0L MPI BRAVO	305	V-8	4	1998-2007	L015751 & UP	18-2412
	3.0L	3.0LX	181	4	4	1994-1998	F000001 - L096999	18-2321	5.0L		5.0L MPI ALPHA	305	V-8	4	2002-2010	M300000 & UP	18-2323
150		150		4		1964-1966	1666495 - 2048046	18-2171	5.0L		5.0L MPI BRAVO	305	V-8	4	2002-2010	M300000 & UP	18-2412 ⑮
160		160		4		1967-1969	2048022 - 2770031	18-2171	5.0L		5.0LX ALPHA	305	V-8	4	1988-1993	B773740 - F000000	18-2175 ⑯
165		165	224	4	4	1987	B434941 - B774251	18-2414	5.0L		5.0LX ALPHA	305	V-8	4	1994-1995	F000001 - F600999	18-2323
165		165 INLINE 6		6	4	1970-1981	2770032 - 5813433	18-2171	5.0L		898	305	V-8	4	1977-1985	4762210 - 6899057	18-2171
170		170		4		1985-1986	6916779 - B434940	18-2414			225 (GM)	327	V-8	4	1963-1969	1539820 - 2694014	18-2171
180		180		4		1987	B436391 - B775248	18-2414			250	327	V-8	4	1977	4768000 - 4908849	18-2171
190		190		4		1985-1987	6916779 - B775248	18-2414			260	350	V-8	4	1978-1982	4908850 - 6218461	18-2171
	3.7L	3.7L		4		1988-1989	B774252 & UP	18-2414	5.7L		260	350	V-8	4	1982-1986	6218462 - B525981	18-2171 ⑰
	3.7L	3.7LX		4		1983-1989	B775249 & UP	18-2414	5.7L		260	350	V-8	4	1982-1987	6218462 - B773304	18-2175 ⑱
		470		4		1976-1982	4208730 - 6218036	18-2413	5.7L		260	350	V-8	4	1987	B525982 - B773304	18-2175
		485		4		1983-1984	6218037 - 6916779	18-2414	5.7L		300 TEMPEST ALPHA	350	V-8	4	1985-1986	6668677 - B430367	18-2171 ⑲
		488		4		1980-1982	5685394 - 6218036	18-2413	5.7L		300 TEMPEST ALPHA	350	V-8	4	1986	A434310 - B430367	18-2175 ⑳
		140		6		1963	1538930 - 1664117	18-2171	5.7L		320 EFI	350	V-8	4	1987-1989	A543604 - C622418	18-2175
		150		6		1964-1966	1664118 - 2048046	18-2171	5.7L		350 MAG ALPHA	350	V-8	4	1986-1993	A635178 - F000000	18-2175
		160		6		1967-1969	2048022 - 2770031	18-2171	5.7L		350 MAG ALPHA	350	V-8	4	1993-1997	F000001 - K999999	18-2323
		165		6		1970-1981	2770032 - 5813433	18-2171	5.7L		350 MAG ALPHA EFI GEN +	350	V-8	4	1996-1997	F800300 - K999999	18-2323
		175		4		1987	B527955 - B773242	18-2175	5.7L		350 MAG MPI ALPHA	350	V-8	4	1998-2010	L010019 & UP	18-2323
185		185 (4bbl)	229	6	4	1983-1984	6330183 - 6919655	18-2171	5.7L		350 MAG MPI BRAVO	350	V-8	4	1998-2010	L010019 & UP	18-2412 ㉑
175		175	262	V-6	4	1987	B527955 - B773242	18-2175	5.7L		350 MAG MPI HORIZON ALPHA	350	V-8	4	2002-2007	M300000 - A299999	18-2323
185		185 (2bbl)	262	6	4	1985-1986	A331455 - B527954	18-2171 ㉒	5.7L		350 MAG MPI HORIZON ALPHA	350	V-8	4	1993-2007	F000001 & UP	18-2323
185		185 (2bbl)	262	6	4	1985-1986	A331455 - B527954	18-2175 ㉓	5.7L		HORIZON BRAVO	350	V-8	4	1999-2007	M300000 & UP	18-2412
205		205	262	6	4	1985-1986	A331455 - B527954	21-2171	5.7L		5.7L ALPHA	350	V-8	4	1988-1993	B773305-F000000	18-2175
205		205	262	6	4	1985-1986	A331455 - B527954	18-2175 ㉔	5.7L		5.7L ALPHA	350	V-8	4	1993-2010	F000001 & UP	18-2323
205		205	262	6	4	1987	B527955 - B775129	18-2175	5.7L		5.7L BRAVO	350	V-8	4	1988-2010	B773305 & UP	18-2412 ㉕
		262 MAG EFI GEN+	262	V-6	4	1996-1997	F803800 - K999999	18-2323	5.7L		5.7L EFI ALPHA	350	V-8	4	1995-2001	F225560 - M299999	18-2323
	4.3L	4.3L	262	V-6	4	1988-1993	B527955 - F000877	18-2175	5.7L		5.7L EFI BRAVO	350	V-8	4	1998-2001	L010035 - M299999	18-2412 ㉖
	4.3L	4.3L	262	V-6	4	1993-2010	F000878 & UP	18-2323	5.7L		5.7LX EFI ALPHA	350	V-8	4	1996-1997	F752400 - K999999	18-2323
	4.3L	4.3L MPI	262	V-6	4	1998-2001	L012009 - M299999	18-2323	5.7L		5.7LX EFI ALPHA	350	V-8	4	1993-2007	F000001 & UP	18-2323
	4.3L	4.3L MPI	262	V-6	4	2002-2010	M300000 & UP	18-2323	5.7L		5.7LX EFI BRAVO	350	V-8	4	1998-2007	L010035 & UP	18-2412 ㉗
	4.3L	4.3LX	262	V-6	4	1988-1993	B775130 - F001219	18-2175	5.7L		233	351	V-8	4	1975-1977	4173000 - 4902304	18-2173
	4.3L	4.3LX (4bbl)	262	V-6	4	1993-1995	F001220 - F802999	18-2323	6.2L		377 MAG	377	V-8	4	2008-2010	A300000 & UP	18-2412 ㉘
	4.3L	4.3LX GEN + (2bbl)	262	V-6	4	1996-1997	F803000 - K999999	18-2323	6.2L		MX 6.2L MPI	377	V-8	4	2000-2007	L680003 - A299999	18-2412 ㉙
	4.3L	4.3LX GEN +	262	V-6	4	1996-1997	F803000 - K999999	18-2323	6.2L		MX 6.2L MPI HORIZON	377	V-8	4	2002-2007	M300000 - A299999	18-2412 ㉚
	5.0L	225 (FORD)	302	V-8	4	1973-1974	3385721 - 4166999	18-2173 ㉛	7.4L		454 MAG ALPHA	454	V-8	4	1986-1988	A631894 - B785148	18-2175 ㉜
	5.0L	888	302	V-8	4	1971-1977	3108723 - 4887829	18-2173									

- ① Use with Borg Warner transmission
- ② Low speed / work application
- ③ Coupler mounts to flywheel
- ④ Use with Hurth transmission
- ⑤ Hydraulic shift only
- ⑥ I drive only
- ⑦ Round shape coupler
- ⑧ Standard Bravo applications
- ⑨ Coupler mounts to crankshaft
- ⑩ Triangular shape coupler
- ⑪ Use with Borg Warner 71/72 series in-line transmission
- ⑫ Use with Borg Warner 5000 or Hurth 630 transmission



18-4442
ENGINE ALIGNMENT TOOL
 Replaces: 91-57797A3
 For use with all #1 units



18-9803
SPANNER NUT WRENCH
 Replaces: 91-36235



18-9200
SPLINE GREASE
 14 oz.
 Replaces: 92-816391A4
 Specialty grease used in the assembly of engine yokes and couplers



18-2200
LOWER UNIT GEAR SET
 Replaces: 43-96084A4
 888 S/N 3106717 & UP #1 Units S/N 3469428 & UP Except, MR/ALPHA Units (which have no pre-load pin in the top of the drive shaft).



18-2410
FORWARD GEAR SET
 Replaces: 43-96084A7
 For: "R" drive

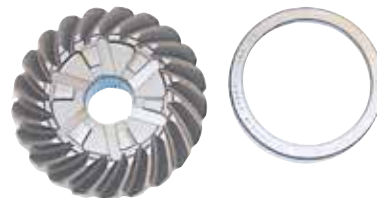

18-2360
PINION & FORWARD GEAR SET
 Replaces: 43-828072A3
 13-21 Teeth



18-2206-1
LOWER UNIT GEAR SET
 Replaces: 43-878087A2 + 43-828073A1, 43-828072A2
 For: All MR/ALPHA/Gen II (Except Gen II 2.00-2.40 ratios)



18-2409
REVERSE GEAR
 Replaces: 43-92320T
 For: "R" drive (28 teeth)



18-2406
FORWARD GEAR SET
 Replaces: 43-878087A2
 For: MR/Alpha/Gen II lower S/N D469859 & UP



18-2408
REVERSE GEAR
 Replaces: 43-828073A1
 For: Alpha I/Gen II lower S/N D469859 & UP

18-2404
GEAR REPAIR KIT
 Replaces: 43-803079T1
 For: "R" drive



— CONTAINS —

Part #	Description	O.E. #	Qty.
18-2200	Lower Unit Gear Set	43-96084A4	1
18-2202	Sliding Clutch	52-66063	1
18-1157	Needle Roller Bearing	31-30895	1
18-1155	Ball Bearing	30-88957A1	1
18-1159	Tapered Roller Bearing	31-35928A1	1
18-2285	Shim	15-47397A1	1
18-3719	Pinion Nut	11-35921	1
18-2299	Tab Washer	14-79447	1

18-2405
GEAR REPAIR KIT
 Replaces: 43-803091T1
 For: MR/Alpha I



— CONTAINS —

Part #	Description	O.E. #	Qty.
18-2652	Lower Gear Housing Seal Kit	26-33144A2	1
18-3719	Pinion Nut	11-35921	1
18-2343	Washer	12-982721	1
18-2298	Tab Washer	14-18323	1
18-2299	Tab Washer	14-79447	1
18-2206-1	Gear Set	43-42934	1
18-2285	Shim	15-47397A1	1
18-1155	Ball Bearing	30-88957A1	1
18-1158	Needle Roller Bearing	31-30956	1
18-1117	Pinion Bearing	31-42647A1	1
18-1143	Alpha Bearing	31-36387A1	1
18-2294	Shim Kit	15-42637A-1	1
18-2202	Sliding Clutch	52-66063	1



18-2368
LOWER GEARCASE KIT
 Replaces: 43-803071T1
 ALPHA/GEN II 1996-97



18-2369
LOWER GEARCASE KIT
 Replaces: 43-803069T1
 ALPHA/GENII 1991-95



18-2407
GEAR SET
 Replaces:
 43-878087A4
 For: MR/Alpha/Gen II
 lower gear housings

— CONTAINS —

Part #	Description	O.E. #	Qty.
18-2206-1	Gear Set	43-42934	1
18-1155	Ball Bearing	30-88957A1	1
18-1117	Pinion Bearing	31-42647A1	1
18-1158	Needle Roller Bearing	31-30956	1
18-1143	Alpha Bearing	31-36387A1	1
18-2294	Shim Kit	15-42637A-1	1
18-2285	Shim	15-47397	1
18-3719	Pinion Nut	11-35921	1
18-2343	Washer	12-982721	1



18-2202
SLIDING CLUTCH
 Replaces:
 52-66063,
 52-853594T
 888 S/N 3784375 & UP
 #1 Units S/N 3469428 & UP



18-2357
CROSS PIN
 Replaces:
 17-30632

PKG. OF 2

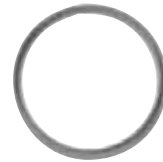

18-2348
18-2348-9^①
CLUTCH CROSS PIN SPRING
 Replaces: 24-30893
 1/MC-1/R/MR/Alpha
 Mercruiser/Gen II lower
 S/N D469859-F679999
 Mercruiser Vazer



18-2166
PROP SHAFT
 Replaces: 44-66060, 44-66060-3, 44-824110, 44-860308
 For all #1 & MR/ALPHA Units S/N 2791957 & above.
 Also for 165 (6 cyl.) S/N 2763442 & above.

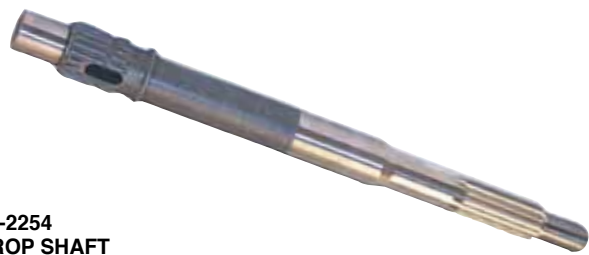

18-2254
PROP SHAFT
 Replaces: 44-850308
 For: Alpha One Gen II S/N 0L100040 & up/Vazer



**18-2167
DRIVE SHAFT**
Replaces: 45-41939A1
For all #1 units S/N 2791957 & above except MR/ALPHA Units or units which have been retro-fitted with MR/ALPHA lower units. Also for 165 (6 cyl.) S/N 2763442 & above.



**18-2180
DRIVE SHAFT**
Replaces: 45-42634
For all MR/ALPHA Units & older units which have been retro-fitted with MR/ALPHA lower units.



**18-2331
DRIVE SHAFT**
Replaces: 45-853648
For: Ratios 1.47, 1.62, 1.81 & 1.94.
Fits: Gen II (1998 & up), (OL100040 & up)
For use with: 18-2400 Complete Lower Gear Case



**18-2261
DRIVE SHAFT**
Replaces: 45-816919
All Alpha I Generation II Drives (with new style 18-3056 Impeller)
Serial #D494569 & above.



**18-2346
RETAINER NUT**
Replaces: 824519
For: MR Alpha & Gen II



**18-3719
PINION NUT**
Replaces: 11-35921



**18-2359
DRIVE SHAFT NUT SET**
Replaces: 12-92721 & 11-35921
Contains:
18-3719 Pinion Nut
18-2343 Pinion Nut Washer



18-2286
Replaces: 19755A2

18-2196
Replaces: 19755A4

SHIFT SPOOL ASSEMBLIES

SHIFT SPOOL ASSEMBLY APPLICATION		
Model	Serial #	Part #
1A (EZ-Shift)	1776349 & UP	18-2196
1B (EZ-Shift)	1775193 & UP	18-2196
1C (EZ-Shift)	1777799 & UP	18-2196
120/140	2062141-3780849	18-2196
120/140	3780850 & UP	18-2286
160	2065190-2763441	18-2196
165	2763442-3780849	18-2196
165	3780850 & UP	18-2286
888	3106717-3784374	18-2196
888	3784375 & UP	18-2286
898/228	4782330 & UP	18-2286
225-S	3856268-4200499	18-2286
233	4200500 & UP	18-2286
470/485	4208730 & UP	18-2286
R/MR/Alpha One	6225377 & UP	18-2286
Alpha One (Gen II)	D494569 & UP	18-2286



**18-3759
THRUST BEARING RING**
Replaces: 35915



**18-2342
THRUST RING**
Replaces: 681001
For: MR/ ALPHA



**18-2191
CARRIER BEARING**
Replaces: 73020A14
For: #1R/MR/Alpha I
For: Housings with casting #73020C

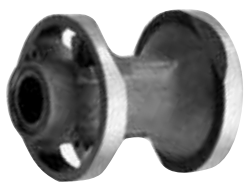

18-2376
CARRIER BEARING
 Replaces: 818763A10
 For: Alpha Gen II & MR Units
 For: Housings with casting #73020C1, Mercruiser Vazer



18-2150
SHIFT SHAFT
 Replaces: 774811
 Stainless Steel



18-2353
SHIFT ROD BUSHING ASSEMBLY
 Replaces: 23-815921A21



18-2154
SHIFT SHAFT HOUSING BUSHING
 Replaces: 23-30617A2
 Mercruiser & Alpha 1 (S/N 1684188 & UP)



18-3198
WATER PICK-UP
 Port
 Replaces: 934241
 For: MR Alpha



18-3199
WATER PICK-UP
 Starboard
 Replaces: 934231
 For: MR Alpha



18-2320
SHIFT SHAFT
 Replaces: 815919A1
 For: Gen II



18-2130
SHIFT CRANK
 Replaces: 76865
 For All #1 Units R/MR/Alpha,
 Mercruiser Vazer

PKG. OF 2



18-4295
18-4295-9^①
E-CLIP
 Replaces: 53-29641
 For: Gen II



18-2299
TAB WASHER
 Replaces: 14-79447



18-2298
TAB WASHER
 Replaces: 14-18323



18-3751
SPANNER NUT
 Replaces: 79448
 For: Mercruiser Vazer



18-2354
CARRIER SEAL
 Replaces: 821759A4

PKG. OF 2



18-2707
18-2707-9^①
COLLAR KEEPER
 Replaces: 97351
 For: Bravo



18-1117
PINION BEARING
 Replaces: 31-42647A1



18-1356
PINION BEARING
 Replaces: 31-54928



18-1142
UPPER PINION BEARING
 Replaces: 31-32573A1

Model	Year	Model	Year
215 E/H	1970-72	II, TR	1973-76
225TRS, 280 TRS	1973-76	TR, TRS	1977-93

^① Priced per Package



**18-1193
TAPERED
ROLLER BEARING**
Replaces: 31-33138A1
Fits: Gen II (1998-Up), Mercruiser Vazer



**18-1143
TAPERED
ROLLER BEARING**
Replaces: 31-36387A1



**18-1156
FORWARD
GEAR BEARING**
Replaces: 31-30894A1
For: Mercruiser Vazer



**18-1161
TAPERED
ROLLER BEARING**
Replaces: 31-35990A1
For: Mercruiser Vazer



**18-1162
TAPERED
ROLLER BEARING**
Replaces: 31-38356A1



**18-1164
TAPERED
ROLLER BEARING**
Replaces: 31-53079A1



**18-1165
TAPERED
ROLLER BEARING**
Replaces: 31-61100A1



**18-1173
TAPERED
ROLLER BEARING**
Replaces: 31-828437A2



**18-1179
TAPERED
ROLLER BEARING**
Replaces: 31-32575A1, T1
For: Gen II F680000 & UP,
Mercruiser Vazer



**18-1127
TAPERED
ROLLER BEARING**
Replaces: 31-54038A1
For: Bravo II - Lower (S/N B664190 & UP)



**18-1182
ROLLER BEARING KIT**
Replaces: 31-30894A5
For: Alpha I (Gen II) (1998 & up)
(OL100040 & up), Mercruiser Vazer



**18-1197
TAPERED FORWARD
GEAR BEARING**
Replaces: 31-828439A2
For: Alpha I (Gen II) (1996-97)
(OF680000-OK999999)



**18-1129
UPPER DRIVE
SHAFT BEARING**
Replaces: 31-86748A1
For: Bravo I, II, III - Lower
(S/N B664190 & UP)



**18-1150
NEEDLE ROLLER BEARING**
Replaces: 31-92366A1



**18-1157
FORWARD GEAR
INNER BEARING**
Replaces: 31-30895,
31-30895T
For: Mercruiser Vazer



**18-1158
CARRIER BEARING**
Replaces: 31-30956,T
For: Mercruiser Vazer



**18-1153
BALL BEARING**
Replaces:
30-63326, 30-63326T



18-1155
BALL BEARING
 Replaces: 30-88957A1, T



18-1160
DRIVE BEARING KIT
 Replaces: 31-35988A2, 31-35988A12

MERCURISER STERNDRIVE UPPER GEAR HOUSING BEARINGS

Sterndrive Model	Drive Ratio	Years	Serial Number	Drive Gear (Yoke)	Driven Gear	Upper Cap
IA,IB,IC & EZ Shift	All	1964-66	1684188 - 2065186	18-1160	18-1161	18-1179
120/140	1.98	1967	2062141 - 2187468	18-1160	18-1161	18-1161
120/140	1.98	1967-71	2187469 - 3134193	18-1160	18-1161	18-1179
120/140	1.98	1971-82	3134194 - 6225576	18-1160	18-1161	18-1165
470/485	1.84	1976-82	4208730 - 6225576	18-1160	18-1161	18-1165
160	1.68	1967	2065190 - 2182197	18-1160	18-1161	18-1161
160	1.68	1967-71	2182198 - 3134193	18-1160	18-1161	18-1179
165	1.65	1971-81	3213658 - UP	18-1160	18-1161	18-1165
888	1.5	1971-73	3106717 - 3134193	18-1160	18-1161	—
888	1.5	1973-77	3134194 - UP	18-1160	18-1161	18-1165
225-S	1.5	1974	3856268 - 4200499	18-1160	18-1161	18-1165
898/228	1.65	1977-82	4782330 - 6225576	18-1160	18-1161	18-1165
233	1.32	1975-77	4200500 - UP	—	—	18-1165
250	1.32	1977	4791300 - 4898729	—	—	18-1165
255-TRS	All	1973-74	3377316 - 4203749	18-1162 ③	18-1162	—
260	1.5	1978-82	4898730 - 6225576	18-1160	18-1161	18-1165
280-TRS	All	1975-76	4203750 - 4895399	18-1162 ③	18-1162	—
R/MR/Alpha One	1.98/1.84/ 1.65/1.50	1984-90	6225577 - UP	18-1160	18-1161 ① ④	18-1165
R/MR/Alpha One	1.5	1984-90	6225577 - UP	18-1160	18-1142	18-1165
R/MR/Alpha One	1.32	1984-90	6225577 - UP	—	—	18-1165
R/MR/Alpha One	1.5 Heavy Duty	1984-90	6225577 - UP	—	18-1142	18-1165
Alpha One SS	1.32	1986-89	A545004 - UP	—	—	18-1165
Alpha One SS	1.5	1986-89	A545004 - UP	—	18-1142	18-1165
Alpha One Gen II	2.40/1.98/ 1.84/1.65	1991-95	D469859 - F679999	18-1160	18-1161 ④	18-1165
Alpha One Gen II	1.5	1991-95	D469859 - F679999	18-1160	18-1142	18-1165
Alpha One Gen II	2.40/1.94/ 1.81/1.62	1996-97	F680000 - K999999	18-1160	18-1161 ④	18-1179
Alpha One Gen II	1.47	1996-97	F680000 - K999999	18-1160	18-1142	18-1179
Alpha One Gen II	2.40/2.00/ 1.94/1.81/ 1.62	1998 & Up	L100040 - UP	—	18-1161	18-1179
Alpha One Gen II	1.47	1998 & Up	L100040 - UP	—	18-1142	18-1179
II-TR	—	1973-76	3377316 - 4794899	18-1162 ②	18-1162	—
SSM II	—	1982-97	ALL	18-1162 ③	18-1162	—
TR/TRS	—	1977-93	4794900 - UP	18-1162 ③	18-1162	—
Bravo I, II, III	All	—	B664190 & UP	—	—	18-1129

① Timken Cone # 89449 / Cup 89410
 ② Straight Shoulder Gear Only

③ Bearing for U-Joint Yoke
 ④ Use 18-1142 for 1.5:1 Upper Gear Ratio

MERCUISER STERNDRIVE LOWER GEAR HOUSING BEARINGS

Sterndrive Model	Years	Beg. S/N - End. S/N	Prop Bearing Carrier	Lower Drive Shaft (Pinion)	Upper Drive Shaft	Inside Forward Gear (Needle)	Outside Forward Gear	Reverse Gear
60	1965-66	1830753 - 2063740	—	—	—	—	18-1162	—
80/90	1966-72	2063741 - 3225967	18-1158	—	—	18-1157	18-1156	—
I	1963	1534570 - 1536617	18-1158	—	18-1153	18-1157	18-1156	—
I	1963	1536618 - 1684187	18-1158	—	—	18-1157	18-1156	—
IA,IB,IC & EZ Shift	1964-66	1684188 - 2065189	18-1158	—	—	18-1157	18-1159	18-1155
120/140	1967-69	2062141 - 2791956	18-1158	—	18-1164 ④	18-1157	18-1159	18-1155
120/140	1970-77	2791957 - 4893634	18-1158	—	18-1164	18-1157	18-1159	18-1155
120/140	1978-82	4893635 - 6225576	18-1158	18-1150	18-1164	18-1157	18-1159	18-1155
470	1976-77	4208730 - 4893934	18-1158	—	18-1164	18-1157	18-1159	18-1155
470/485	1978-82	4893835 - 6225576	18-1158	18-1150	18-1164	18-1157	18-1159	18-1155
160	1967-69	2065190 - 2763441	18-1158	—	18-1164 ④	18-1157	18-1159	18-1155
165	1970-77	2763442 - 4890459	18-1158	—	18-1164	18-1157	18-1159	18-1155
165	1978-81	4890460 - UP	18-1158	18-1150	18-1164	18-1157	18-1159	18-1155
888	1971-77	3106717 - UP	18-1158	—	18-1164	18-1157	18-1159	18-1155
225/233	1974-77	3856268 - UP	18-1158	—	18-1164	18-1157	18-1159	18-1155
898/228	1977	4782330 - 4898729	18-1158	—	18-1164	18-1157	18-1159	18-1155
898/228	1978-82	4898730 - 6225576	18-1158	18-1150	18-1164	18-1157	18-1159	18-1155
250	1977	4791300 - 4898729	18-1158	—	18-1164	18-1157	18-1159	18-1155
255-TRS	1973-74	3377316 - 4203749	18-1158	—	—	—	18-1159	N/A
260	1978-82	4898730 - 6225576	18-1158	18-1150	18-1164	18-1157	18-1159	18-1155
280-TRS	1975-76	4203750 - 4895399	18-1158	—	—	—	18-1159	N/A
R	1983	6225577 - UP	18-1158	18-1150	18-1164	18-1157	18-1159	18-1155
MR / Alpha One	1984-90	6225577 - UP	18-1158	18-1117	18-1143	—	18-1159 ⑤	18-1155
MR / Alpha One	1984-90	6225577 - UP	18-1158	18-1117	18-1143	18-1157 ②	18-1159 ⑤	18-1155
MR / Alpha One (CR)	1984-90	6225577 - UP	18-1158	18-1117	18-1143	—	—	—
Alpha One SS	1986-89	A545004 - UP	18-1158	18-1117	18-1143	18-1157	18-1159	18-1155
Alpha One Gen II	1991-95	D469859 - F679999	18-1158	18-1117	18-1143	18-1157	18-1159 ⑤	18-1155
Alpha One Gen II (CR)	1991-95	D469859 - F679999	18-1158	18-1117	18-1143	—	—	—
Alpha One Gen II	1996-97	F680000 - K999999	18-1158	18-1117	18-1143	18-1157	18-1156	18-1155
Alpha One Gen II (CR)	1996-97	F680000 - K999999	18-1158	18-1117	18-1143	—	—	—
Alpha One Gen II	1998-newer	L100040 - UP	18-1158	18-1117	18-1143	18-1157	18-1156 ③	18-1155
Alpha One Gen II (CR)	1998-newer	L100040 - UP	18-1158	18-1117	18-1143	—	—	—
II	1962-67	1474909 - 2275488	—	—	—	N/A	18-1156 ③	N/A
II ③	1968-69	2398798 - 2671321	—	—	—	—	18-1162	18-1156
II-TR	1973-76	3377316 - 4794899	—	—	18-1161 ①	—	—	N/A
TR	1973-93	4794900 - UP	—	—	18-1161 ①	—	—	N/A
TRS	1973-93	4794900 - UP	18-1158	—	—	—	18-1159	N/A

① 18-1161 Top Bearing / 18-1163 Bottom Bearing

② Torrington#B1616
③ Prop Shaft Drive Gear

④ #15520 Stamped on Cup
⑤ Use 18-1173 for 2.40:1 ratio only (new style lower gears) our **18-2206-1**



18-2349
SHIFT SHAFT SLEEVE
Replaces: 23-67370



18-2244
18-22441-9^①
(PKG. OF 50 WITHOUT GASKET)
DRAIN PLUG
Replaces: 10-79953A2
For: #1/R/MR/Alpha/Alpha I Gen II
Both Upper And Lower Units



18-2375
18-23751-9^①
(PKG. OF 50 WITHOUT GASKET)
DRAIN PLUG MAGNET
Replaces: 10-14834A1, 22-67892A1
(Magnet)
For: Alpha MR/Gen II lower units
Not to be used on #1/R lower units



18-2165
CONTROL BOX CAM
Replaces: 59369



18-4220
THRUST WASHER
Replaces: 13171, 77987
V-6, Outboards &
Mercruiser Sterndrives



18-3784
THRUST WASHER
Replaces: 805100
Fits: Bravo III (Front)



18-3701
PROP NUT KIT
Replaces: 11-52707A1
—CONTAINS—

② **18-3701D**



Part #	O.E. #	Description
18-3200	14-31210, 14-816629	Tab Washer
18-3700	11-52707	Prop Nut



18-3755
PROP NUT KIT
Fits: Bravo III (Front)



18-3756
PROP NUT KIT
Fits: Bravo III (Rear)

PKG. OF 10



18-3200
18-3200-9^①
TAB WASHER
Replaces: 14-31210, 14-816629



18-3787
TAB WASHER
Replaces: 805101T
Fits: Bravo III (Rear)



18-3788-9^①
TAB WASHER
Replaces: 14-34817
Fits: Bravo II

PKG. OF 10



18-3783
PROP NUT
Replaces: 11-859131
Fits: Bravo III (Front)



18-3785
PROP NUT
Replaces: 11-826711 27
Fits: Bravo II



18-3786
PROP NUT
Replaces: 11-862907
Fits: Bravo III (Rear)

① Priced per Package

② Items ending in "D" are Display Packaged - Regular number is Non-Display



**18-3700
PROP NUT**
Replaces: 11-52707



**18-3714
BRASS CASTLE WASHER**
Replaces: 12-31211A2
Fits: Alpha/Bravo I (without Flo-Torq II Hub)
NOTE: Fits above product with rubber hub propellers (non-Flo-Torq II)

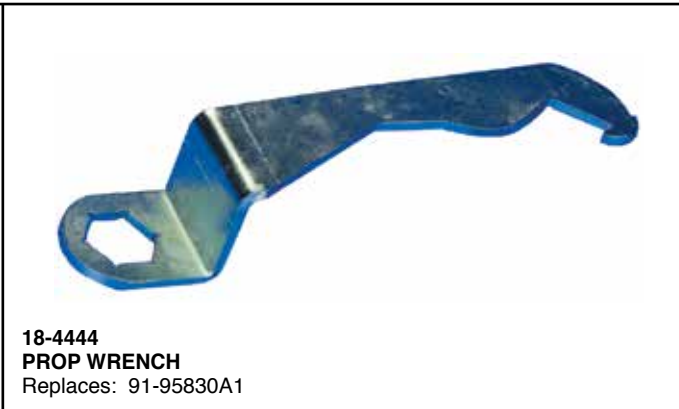

**18-4444
PROP WRENCH**
Replaces: 91-95830A1

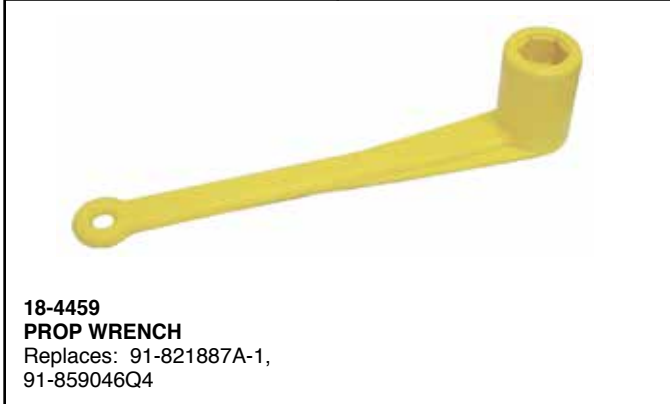

**18-4459
PROP WRENCH**
Replaces: 91-821887A-1,
91-859046Q4

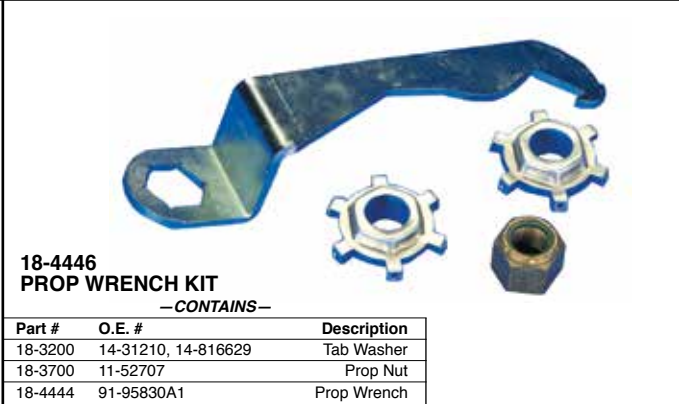

**18-4446
PROP WRENCH KIT**

—CONTAINS—

Part #	O.E. #	Description
18-3200	14-31210, 14-816629	Tab Washer
18-3700	11-52707	Prop Nut
18-4444	91-95830A1	Prop Wrench

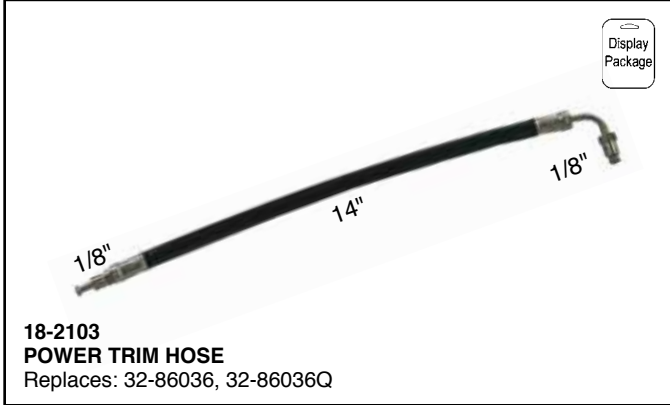

**18-2103
POWER TRIM HOSE**
Replaces: 32-86036, 32-86036Q

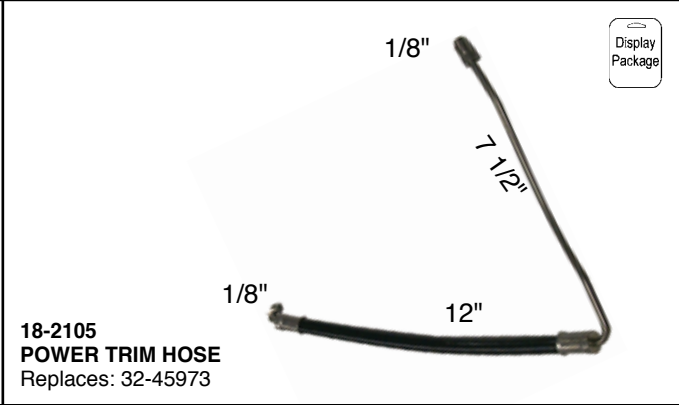

**18-2105
POWER TRIM HOSE**
Replaces: 32-45973

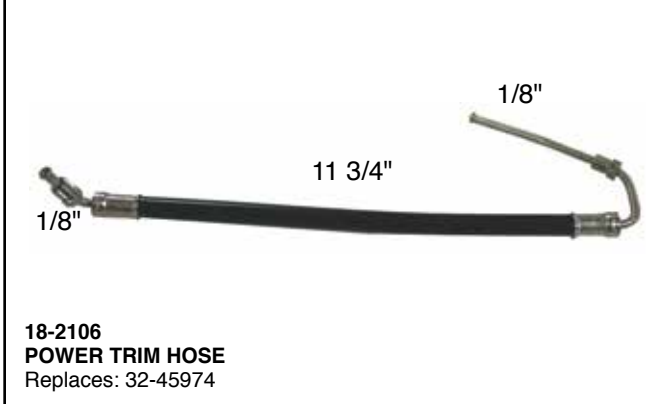

**18-2106
POWER TRIM HOSE**
Replaces: 32-45974



**18-2107
POWER TRIM HOSE**
Replaces: 32-55816



**18-2108
POWER TRIM HOSE**
Replaces: 32-59841



**18-2109
POWER TRIM HOSE**
Replaces: 32-59842

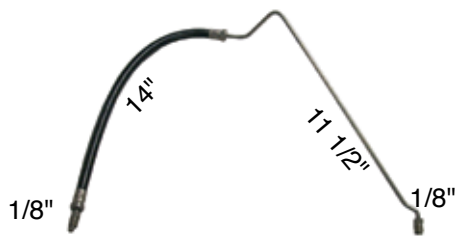

POWER TRIM HOSE
Starboard
Connector to bottom of trim cylinder MCM 120-260 & BRAVO

Part #	O.E. #	Description
18-2114	32-99902-1, 32-864960	Trim Cyl. Casting #14034-1
18-2136*	32-99902, 32-864589	Trim Cyl. Casting #98704, 98704-1

* Approximately 11 1/4" long

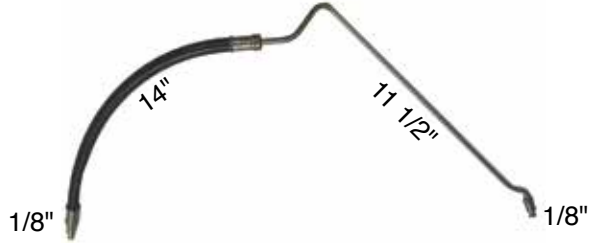

POWER TRIM HOSE
Starboard
Connector to bottom of trim cylinder MCM 120-260 & BRAVO

Part #	O.E. #	Description
18-2115	32-99903-1, 32-864959	Trim Cyl. Casting #14035-1
18-2137*	32-99903, 32-864588	Trim Cyl. Casting #98703, 98703-1

* Approximately 11 1/4" long



18-2112
POWER TRIM HOSE
Replaces: 32-87234

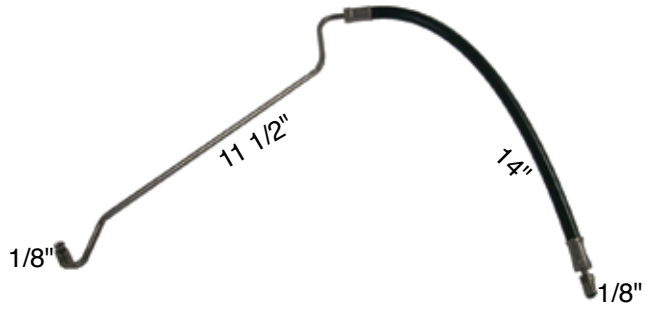

18-2113
POWER TRIM HOSE
Replaces: 32-87235



18-2435
POWER TRIM HOSE
Replaces: 32-861127, 32-95858
Fits R/MR/Alpha/Alpha Gen II/Bravo I, II, III/Bravo X, XR, XZ
Serial number 0W099999 and below without quick connect fittings.
OEM hose color is black.



18-2436
POWER TRIM HOSE
Replaces: 32-861128, 32-95859
Fits R/MR/Alpha/Alpha Gen II/Bravo I, II, III/Bravo X, XR, XZ
Serial number 0W099999 and below without quick connect fittings.
OEM hose color is gray.



18-2116
POWER TRIM HOSE
Replaces: 32-99904



18-2126
POWER TRIM HOSE
Replaces: 32-52951A1

POWER TRIM HOSE APPLICATION

Stern Drive Model	Years	Serial No.	Trim Cylinder to Connector (port down)	Trim Cylinder to Connector (port up)	Trim Cylinder to Connector (stbd down)	Trim Cylinder to Connector (stbd up)	Pump to Hydraulic Connector	Pump to Hydraulic Connector	Connector to Reverse Lock Valve	Hydraulic Pump & Reverse Lock Valve
120, 140	1967-69	2062141 - 2791956	—	18-2106	—	18-2105	—	N/A	—	18-2126
120, 140	1970-73	2791957 - 3780849	18-2103	18-2103	18-2103	18-2103	18-2107	N/A	—	18-2126
120, 140	1974-82	4893635 - 6225576	18-2103	18-2103	18-2103	18-2103	18-2107	N/A	18-2109	18-2126
470/485	1976-82	4208730 - 6225576	18-2103	18-2103	18-2103	18-2103	18-2107	N/A	18-2109	18-2126
160	1967-69	2065190 - 2763441	—	18-2106	—	18-2105	—	N/A	—	18-2126
165	1970-73	2763442 - 3780849	18-2103	18-2103	18-2103	18-2103	18-2107	N/A	—	18-2126
165	1974-81	3780850 & UP	18-2103	18-2103	18-2103	18-2103	18-2107	N/A	18-2109	18-2126
888	1974 & UP	3106717 & UP	18-2103	18-2103	18-2103	18-2103	18-2108	N/A	18-2109	—
225/233	1974-77	3856268 & UP	18-2103	18-2103	18-2103	18-2103	18-2108	N/A	18-2109	—
228/898/250/260	1977-82	4782330 - 6225576	18-2103	18-2103	18-2103	18-2103	18-2108	N/A	18-2109	—
R/MR/Alpha/SS	1983-90	6225577 & UP	18-2137 ③	18-2116	18-2136 ③	18-2116	18-2436⑤	18-2435⑤	N/A	N/A
R/MR/Alpha/SS	1983-90	6225577 & UP	18-2115 ④	18-2116	18-2114 ④	18-2116	18-2436⑤	18-2435⑤	N/A	N/A
Alpha One GEN II	1991-97	D469859 & UP	18-2115	18-2116	18-2114	18-2116	18-2436⑤	18-2435⑤	N/A	N/A
Alpha One GEN II ⑥	1998 & UP	0L100040 & UP	18-2115	18-2116	18-2114	18-2435	18-2436⑤	18-2435⑤	N/A	N/A
Bravo I,II & III ⑥	1988 & UP	B664190 & UP	18-2137	18-2116	18-2136	18-2116	18-2436⑤	18-2435⑤	N/A	N/A
Blackhawk	1994-95	F186717 & UP	18-2137	18-2116	18-2136	18-2116	18-2436⑤	18-2435⑤	N/A	N/A
II (1.78)	1968-69	2398798 - 2671321	18-2103	18-2103	18-2103	18-2103	—	N/A	—	18-2126
III	1968-72	2373127 - 3002613	18-2103	18-2103	18-2103	18-2103	—	N/A	—	—
215E/H	1970-72	2909035 - 2915034	18-2103	18-2103	18-2103	18-2103	—	N/A	—	—
TR/TRS	1973-93	3377316 & Up	18-2103 ②	18-2103	18-2103 ②	18-2103	—	N/A	—	—
TR/TRS	1973-93	3377316 & Up	18-2103 ②	18-2103	18-2103 ②	18-2103	—	N/A	—	—
TR/TRS	1973-93	3377316 & Up	— ①	18-2103	— ①	18-2103	—	N/A	—	—

- ① 90° hose end
- ② External trim lines
- ③ Internal cylinder lines
- ④ Oildyne pump
- ⑤ 18-2436 OEM hose color is gray, 18-2435 OEM hose color is black
- ⑥ Serial number 0W099999 and below without quick connect fittings.

- ★ High quality EPDM rubber cups
- ★ Metal hose connector complete with rubber washer
- ★ Use with a standard garden hose
- ★ Corrosion resistant dicromate finish
- ★ Installs in seconds
- ★ No tools required



18-9010
MOTOR FLUSHER
 Heavy Duty
 Replaces: 73971A2, 44357A2, Q2

Flushes cooling system of salts and sediments and allows engine to idle for tuning and engine adjustment in your own driveway. Simply slip attachment over the engine's side water intakes. Coated spring steel arms clamp suction cup securely over the engine's side water intakes.

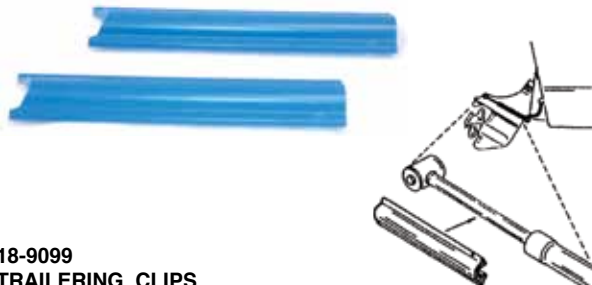

18-9099
TRAILERING CLIPS
 Replaces: 817019A1, 817019Q2
 For all ALPHA I, ALPHA Generation II, Bravo I, II, III, and Blackhawk

STAINLESS STEEL LOCKNUTS

Part #	O.E. #	Thread Size
18-3720 ③	11-34932	3/8" - 24
18-3721 ① ③	11-34933	7/16" - 20
18-3722 ② ③	11-35888, 11-20361	1/4" - 28
18-3723 ③	11-45592	5/16" - 24

① PKG OF 6 ② PKG OF 5

18-2372
TRIM CYLINDER END CAP
 Replaces: 88035
 1.850 Cap Diameter
 For: R/MR/Alpha

18-2373
TRIM CYLINDER END CAP
 Replaces: 806191T
 1.890 Cap Diameter
 For: R/MR/Alpha/ Gen II/Bravo

PKG. OF 2

18-2465-9④
PIVOT PIN END CAP
 Replaces: 19-14842
 For: R/MR/Alpha One (1983-90)
 Serial No. 6225577 and up
 I/II/III (1988-02) Serial No. 6225577

18-2466-9④
PIVOT PIN END CAP
 Replaces: 19-815951
 For: Alpha One Gen II (1991-02)
 Serial No. OD469859 and up

18-2461
TRIM CYLINDER ANCHOR PIN KIT
 Replaces: 17-44166T1
 For: Bravo I/II/III (1988-02)
 Serial No. 6225577 and up

18-2462
TRIM CYLINDER ANCHOR PIN KIT
 Replaces: 17-14873A1
 For: R/MR/Alpha One (1983-90)
 Serial No. 6225577 and up (Front)

③ This product is priced per piece. To order priced per package, please add -9 to the part number.
 ④ Priced per package



18-2463
TRIM CYLINDER ANCHOR PIN KIT
 Replaces: 17-14872A1
 For: R/MR/Alpha One (1983-90)
 Serial No. 6225577 and up (Rear)



18-2464
FRONT AND REAR ANCHOR PIN KIT
 Replaces: 17-815953T1, 56-864641A24
 For: All Alpha One Gen II



18-7633
TRIM SENDER/LIMIT KIT
 Replaces: 805320A03
 Fits: MC-I, R, MR, Alpha, Alpha Gen II, Bravo drives



18-2142
POWER TRIM CYLINDER
 Replaces: 45706A14
 Fits All Stern Drive Models with internal lines: 120, 140, 160, 165, 888, 898, 228, 225-S, 233, 250, 260,470 & 485



18-2148
POWER TRIM CYLINDER HOUSING
 Replaces: 77442A1
 Fits All Stern Drive Models: 120, 140, 160, 165, 888, 898, 228, 225-S, 233, 250, 260,470 & 485



18-2420
POWER TRIM CYLINDER
 Replaces: 14034A3
 For: R/MR/ALPHA (Starboard)



18-2421
POWER TRIM CYLINDER
 Replaces: 14035A3
 For: R/MR/ALPHA (Port)



18-2422
POWER TRIM CYLINDER
 Replaces: 815935A7
 For: GEN II (Port) (S/N F680000 - UP)



18-2423
POWER TRIM CYLINDER
 Replaces: 81595A7
 For: GEN II (Starboard)
 (S/N F680000 - UP)



18-2424
POWER TRIM CYLINDER
 Replaces: 98703A26
 For: BRAVO (Port)



18-2425
POWER TRIM CYLINDER
 Replaces: 98704A17, 98704A26
 For: BRAVO (Starboard)



18-2426
POWER TRIM CYLINDER
 Replaces: 98703A3
 For: R/MR/ALPHA (Port)



18-2427
POWER TRIM CYLINDER
 Replaces: 98704A3
 For: R/MR/ALPHA (Starboard)



18-2649
POWER TRIM SEAL KIT
 Replaces: 25-87400A2



18-2291
TRIM CYLINDER REPAIR KIT
 Replaces: 25-60342A2
 Fits All Stern Drive Models: 120, 140, 160, 165, 888, 898, 228, 225-S, 233, 250, 260,470 & 485



18-2428
TRIM CYLINDER REPAIR KIT
 Replaces: 87399A2
 For: R/MR/ALPHA I, BRAVO



18-2429
TRIM CYLINDER REPAIR KIT
 Replaces: 87399A3
 For: ALPHA I GEN II

POWER TRIM CYLINDER APPLICATION

Model	Year	Serial Number	Trim Cylinder Port	Trim Cylinder Starboard	Housing Port	Housing Starboard	Trim Cylinder Seal Kit
120/ 140 4cyl, 160 6 cyl	1967- 69	2062141- 2791956	18-2142	18-2142	—	—	—
All #1 Drives ①	1970- 82	2791957- 6225576	18-2142	18-2142	18-2148	18-2148	18-2291
R/ MR/ ALPHA I	1983-90	6225577 & UP	18-2426 ②	18-2427 ②	—	—	18-2649
ALPHA I SS	1986- 89	0A545004 & UP	18-2426 ②	18-2427 ②	—	—	18-2649
R/ MR/ ALPHA I	1983-90	6225577 & UP	18-2421 ③	18-2420 ③	—	—	18-2649
ALPHA I SS	1986- 89	0A545004 & UP	18-2421 ③	18-2420 ③	—	—	18-2649
ALPHA I GEN II	1991-2001	0D469859 & UP	18-2422	18-2423	—	—	18-2649
BRAVO I/ II/ III	1988 & UP	0B664190 & UP	18-2424	18-2425	—	—	18-2649
BLACKHAWK	1994-95	0F186717 & UP	18-2424	18-2425	—	—	18-2649

① Excludes the TR, TRS, 215E, H and early II & III drives ② With 15 9/16" long trim cylinder tube ③ With 16 3/16" long trim cylinder tube

<p>PKG. OF 5</p>  <p>18-4252 18-4252-9⑦ CONTINUITY SPRING Replaces: 24-46312 Grounds the trim cylinder to the pivot pin shaft.</p>	 <p>18-2151 7 1/2" (Front) Replaces: 17-45738</p> <p>18-2152 10 1/2"(Rear) Replaces: 17-45735</p> <p>PIVOT PIN Used on 120, 120-260, 140,165, 225S, 233, 250, 470, 888, 898/228 Use 18-2701 Bushing</p>	 <p>18-2393 TRIM CYLINDER PIVOT PIN For: Trim cylinder rear R/MR/Alpha Use: 18-2702-1 Bushing</p>	 <p>18-2394 TRIM CYLINDER PIVOT PIN For: Trim cylinder front R/MR/Alpha Use: 18-2702-1 Bushing</p>
--	---	---	---

 <p>18-2395 TRIM CYLINDER PIVOT PIN Replaces: 17-815953 For: Trim cylinder front & rear Gen II</p>	 <p>18-2396 TRIM CYLINDER PIVOT PIN Replaces: 17-44166 For: Rear Bravo</p>	 <p>18-2397 TRIM CYLINDER PIVOT PIN Replaces: 17-44167A1 For: Front Bravo</p>
--	---	---

 <p>POWER TRIM BUSHING 18-2701⑤ 18-2701-04⑥ 18-2701-9④ Replaces: 23-89574 Fits 120/260 Drive Units (S/N 6225276 & Down)</p>	 <p>POWER TRIM BUSHING 18-2702-1⑤ 18-2702-04⑥ 18-2702-1-9④ Replaces: 23-99291, 23-99291T Fits 120/260 Drive Units (S/N 6225277 & UP)</p>	<p>PKG. OF 8</p>  <p>18-4288 18-4288-9⑦ POWER TRIM BUSHING Replaces: 23-807073 For: Bravo</p>	<p>PKG OF 2</p>  <p>18-2345 18-2345-9⑦ TRIM CYLINDER ANCHOR PIN E-RING Replaces: 53-815949 For: Gen II</p>
---	--	--	--

<p>PKG. OF 2</p>  <p>18-4289 18-4289-9⑦ RETAINING RING Replaces: 53-805272 For: Bravo</p>	<p>PKG. OF 4</p>  <p>18-2336 18-2336-9⑦ TRIM BUSHING Replaces: 23-90203 For: TR & TRS(1977-93),Alpha One SS (1986-1989) , SSM(1982-1995)</p>	<p>PKG. OF 8</p>  <p>18-2341-1 18-2341-1-9⑦ POWER TRIM BUSHING Replaces: 23-815950, 23-8159501 For: Gen II</p>	<p>PKG OF 5</p>  <p>18-3232 18-3232-9⑦ PLUG Replaces: 19-47579 For: MR Alpha</p>
---	--	---	--

④ Standard package of 8 priced per piece
⑤ Standard package of 8 priced per package ⑥ Priced per Package of 4
⑦ Priced per Package

Zinc is for saltwater only applications.
 Magnesium is for fresh water only applications.
 Aluminum is for brackish water or salt water environments.

18-6154A
18-6154M
18-6154Z
ANODE KIT
 Bravo III (2004 and Newer)

18-6158M
18-6158Z
18-6158A
ANODE KIT
 Replaces:
 888755Q01 (18-6158M),
 888756Q01 (18-6158A)
 Mercruiser Alpha I Gen II (1991 & UP)

18-6159A
18-6159M
18-6159Z
ANODE KIT
 Replaces:
 888758Q01 (18-6159A),
 888757Q01 (18-6159M)
 Mercruiser Bravo I - All Years

18-6160A
18-6160M
18-6160Z
ANODE KIT
 Replaces:
 888761Q01 (18-6160A),
 888760Q01 (18-6160M)
 Bravo II (1989 & Up), Bravo III (1989-03)

① **18-6117A**
 ② **18-6117M**
 ③ **18-6117Z**
ANODE
 Replaces:
 Mercruiser 806188A1, A2
 For: Bravo One bearing carrier

② **18-6241**
 ③ **18-6011**
 ① **18-6011A**
ANODE
 Replaces: 31640, A1, Q4, T6
 For use on R/MR/Alpha One, Sterndrive & Transom Assembly (1983-90) & prior drives, Alpha One, Gen II (1991 & up)

③ **18-6012**
ANODE
 Replaces: 34127A1, T2
 For use on R/MR/Alpha One (Sterndrive & Transom Assembly 1983-90) & prior drives

③ **18-6013**
ANODE
 Replaces: 34762A1
 For use on Alpha One SS (Sterndrive & Transom Assembly 1983-89) & prior drives

③ **18-6014**
 ① **18-6014A**
ANODE
 Replaces:
 46399A1, 822777A1, Q1
 For use on Alpha One SS (1982-89)

PKG OF 2

⑥③ **18-6015-9**
 ③⑤ **18-60151-9**
 ⑥① **18-6015A-9**
 ⑥② **18-6242-9**
ANODE
 Replaces: 55989A3, Q9, T9
 Bravo I, II, III (1988-95)

③ **18-6016**
 ③④ **18-60161**
 ③⑤ **18-60161-9**
 ① **18-6016A**
 ② **18-6244**
ANODE
 Replaces: 76214, T3, Q5
 200, 225, 250HP, V-155-V-200, & All Bravos, Alpha One, Gen II (1991 & up)

③ **18-6066**
 ① **18-6066A**
 ② **18-6243**
ANODE
 Replaces: 43994A2, 821631Q1
 For use on R/MR/Alpha One (Sterndrive & Transom Assembly 1983-90)

① Aluminum ② Magnesium ③ Zinc
 ④ Standard package of 10 priced per piece ⑤ Standard package of 10 priced per package
 ⑥ Standard package of 2 priced per package

Zinc is for saltwater only applications.
Magnesium is for fresh water only applications.
Aluminum is for brackish water or salt water environments.



② 18-6114
③ 18-6067
① 18-6067A
ANODE
Replaces: 806189, A1, Q1, T1
For: Alpha One, Gen II (1991 & up)



③ 18-6068
ANODE
Replaces: 826134, Q
Alpha One (Gen II)



② 18-6099
③ 18-6080
① 18-6080A
ANODE
Replaces: 821629, A1, Q1
For: Alpha One (Gen II) (1991 & UP)



② 18-6089
③ 18-6092
① 18-6092A
ANODE
Replaces: 806190, A1, Q1, T1
All Bravos



② 18-6079
③ 18-6093
① 18-6093A
ANODE
Replaces: 806105, A1, Q1, T1
For: Alpha One (Gen II) (1991 & UP)



① 18-6150A
② 18-6150M
③ 18-6150Z
ANODE KIT
Replaces: 888756Q02
For: MR & Alpha One Drives



② 18-6240
③ 18-6094
① 18-6094A
ANODE
Replaces: 821630, A1, Q1, T1
All Bravos

— CONTAINS —

Part #	Description	O.E. #	Qty.
18-2599	Face Seal and Tool	26-818575A2	1
18-2564	Water Pump Base To Face Plate Gasket	27-43033-1	1
18-2566	Face Plate to Water Pump Cover Gasket	27-817277	1
18-2945	Sealing Washer	12-19183	1
18-2944	Seal	26-45577	1
18-2002	Oil Seal	26-76868	1
18-2013	Oil Seal	26-16977	1
18-2014	Oil Seal	26-89238	1
18-2054	Oil Seal	26-81646-1	1
18-2076	Oil Seal	26-12224	1
18-2077	Oil Seal	26-14077	1
18-7159	O-Ring	25-31534	1
18-7168	O-Ring	25-48171	2
18-7176	O-Ring	25-90011	1
18-7420	O-Ring	25-21836	2
18-7440-1	O-Ring	25-36318	2
18-2056	Oil Seal	26-66302	2
18-7413	O-Ring	25-62702	1

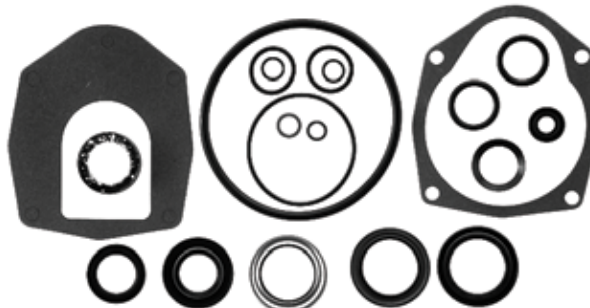

18-2646-1
LOWER UNIT SEAL KIT
Replaces: 26-816575A3
For: Alpha Gen II

— CONTAINS —

Part #	Description	O.E. #	Qty.
18-2516	Bravo Outdrive Seal	16755	1
18-1240	Outdrive Seal	12708	1
18-2945	Gear Housing Drain Screw Gasket	12-19183	1
18-7198	O-Ring	25-45710	1
18-7102	O-Ring	25-62706	1
18-7105	O-Ring	25-62705	1
18-7449	O-Ring	25-97387	1
18-7153	O-Ring	25-25439	2
18-7167	O-Ring	25-97386	1
18-2010	Oil Seal	26-12709	1
18-2715	Spring Kit	24-17997A1	1
18-7117	O-Ring	25-35027	1
18-7169	O-Ring	25-70937	1



18-2643
UPPER UNIT SEAL KIT
Replaces: 26-16709A2
BRAVO - BLACKHAWK

① Aluminum ③ Zinc ④ Standard package of 10 priced per piece
SEAL KIT APPLICATION BEGINS ON PAGE 737

— CONTAINS —

Part #	Desc.	O.E. #	Qty.
18-2944	Seal Gasket	26-45577	1
18-2945	Drain Screw Gasket	12-19183	3
18-7188	Drain Screw O-Ring	26-805726	1
18-7169	O-Ring	25-70937	1
18-7161	O-Ring	25-32546	1
18-7420	O-Ring	25-25439	2
18-7103	O-Ring	25-29845	2
18-7117	O-Ring	25-35027	1
18-2056	Oil Seal	26-66302	2
18-2003	Oil Seal	26-823894	1
NSS	Water Tube Seal	26-88397	1
18-3289	Double Lip Seal	26-864319	1
18-2715	Spring Kit	24-17997A1	1



18-2644
UPPER UNIT SEAL KIT
 Replaces: 26-88397A1
 ALPHA I GENERATION II

— CONTAINS —

Part #	Description	O.E. #	Qty.
18-2944	Seal Gasket	26-45577	1
18-2945	Gear Housing Drain Screw Gasket	12-19183	1
18-7163	O-Ring	25-33465	1
18-7159	O-Ring	25-31534	1
18-2002	Oil Seal	26-76868	2
18-0563	Seal	26-36556	1

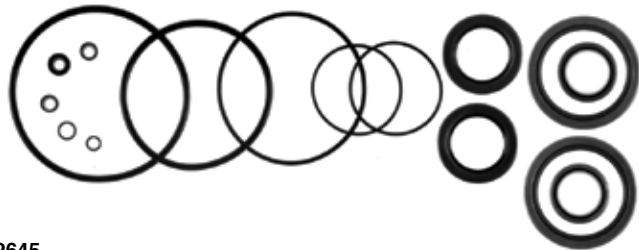

18-2645
LOWER UNIT SEAL KIT
 Replaces: 26-76868A2
 Bravo I and II MODELS ONLY

— CONTAINS —

Part #	Description	O.E. #	Qty.
18-2945	Gear Hsg. Drain Screw Gasket	12-19183	2
18-0894	Water Pocket Cover Gasket	27-55810	1
18-2003	Oil Seal	26-68493	1
18-2049	Oil Seal	26-32511	1
18-2056	Oil Seal	26-96503	1
18-2944	Seal Ring Gasket	26-45577	1
18-3110	Bushing	26-38970	1
18-7153	O-Ring	25-25439	2
18-7161	O-Ring	25-32546	1
18-7169	O-Ring	25-70937	1
18-7445	O-Ring	25-55801	1



18-2648
UPPER UNIT SEAL KIT
 Replaces: 26-32511A1
 S/N 1684188 & UP
 For #1 Units (Including ALPHA) (Also fits 888 Stern drive)
 S/N 3106717 & UP

— CONTAINS —

Part #	Description	O.E. #	Qty.
18-2919	Water Pump to Gear Hsg. Gasket	27-42631-1	1
18-3110	Grommet	26-38970	1
18-2002	Oil Seal	26-76868	1
18-2013	Oil Seal	26-16977	2
18-2014	Oil Seal	26-89238	1
18-2826	Water Pump Base to Gear Hsg. Gasket	27-85610-1	1
18-2914	Lower Water Pump to Wear Plate Gasket	27-85608-1	1
18-2915	Upper Water Pump to Wear Plate Gasket	27-85609-1	1
18-2944	Seal Ring Gasket	26-45577	1
18-2948	Gear Housing Plastic Flush Screw Gasket	12-49221-1	1
18-7158	O-Ring	25-30613	1
18-7159	O-Ring	25-31534	1
18-7162	O-Ring	25-33145	1
18-7176	O-Ring	25-90011	1
—	O-Ring	25-38099	1
18-2154	Bushing, Shift Shaft	23-30617A2	1
18-2076	Line Cutter Oil Seal	26-12224	1
18-7426	O-Ring	25-30271	1
18-2945	Gear Housing Drain Screw Gasket	12-20260, 12-19183	2

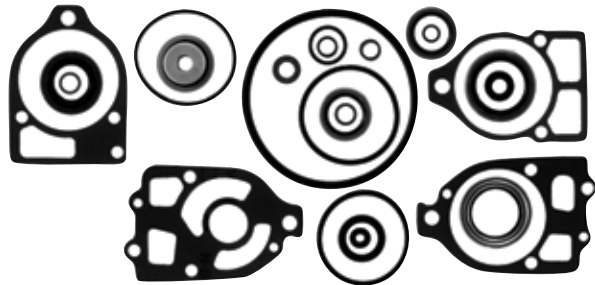

18-2652
LOWER UNIT SEAL KIT
 Replaces: 26-33144A2
 S/N 1684188 & UP
 For #1 Units (Including ALPHA)

— CONTAINS —

Part #	Description	O.E. #	Qty.
18-2652	Lower Gear Housing Seal Kit	26-33144A2	1
18-1155	Ball Bearing	30-88957A1	1
18-1117	Pinion Bearing	31-42647A1	1
18-1143	Tapered Roller Bearing	31-36387A1	1
18-3719	Pinion Nut	11-35921	1
18-2299	Tab Washer	14-79447	1
18-2298	Tab Washer	14-18323	1
18-1158	Needle Roller Bearing	31-30956	1
18-1159	Tapered Roller Bearing	31-35928A1	1
18-2285	Shim Kit	15-47397A1	1
18-1157	Needle Roller Bearing	31-30895	1
18-2343	Washer	12-982721	1
18-2294	Shim Kit	2470	1



18-8208
SEAL & BEARING KIT
 Replaces: 31-803090T1
 For: MR/Alpha Drive

SEAL KIT APPLICATION BEGINS ON NEXT PAGE



18-8370
COMPLETE LOWER GEAR CASE REBUILD KIT
 Includes Water Pump and Complete Seal Kit
 For Mercuriser R/MR/ALPHA 1

-- CONTAINS --			
Part #	Description	O.E. #	Qty.
18-2340	Shift Shft Rubber Washer	12-31266	1
18-2076	Oil Seal	26-12224	1
18-7159	O-Ring	25-31534	1
18-2002	Oil Seal	26-76868	1
18-3109	Water Tube	23-29804	1
18-2154	Shift Bushing	23-30617A2	1
18-3116	Housing	46-96148A1	1
18-3017	Impeller	47-89984	1
18-2914	Water Pump Gasket	27-85608-1	1
18-7158	O-Ring	25-30613	1
18-7176	O-Ring	25-90011	1
18-2944	Seal Ring Gasket	26-45577	1
18-7173	O-Ring	25-30224	1
18-2826	Water Pump Base to Gear Housing Gasket	27-85610-1	1
18-2915	Water Pump Gasket	27-85609-1	1
18-3117	Plate	32435	1
18-7162	O-Ring	25-33145	1
18-2919	Water Pump Gasket	27-42631-1	1
18-2801	Water Pump Gasket	27-32438	1
18-7426	O-Ring	35-30271	1
18-2945	Drain Gasket	26-20260, 12-19183	2
18-3110	Grommet	26-38970	1
18-2013	Seal	26-16977	1
18-2014	Seal	26-89238	1

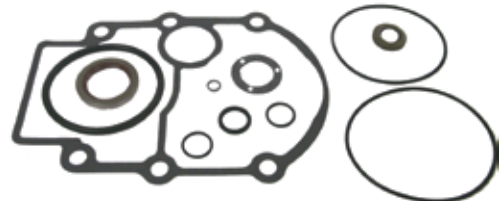

18-8371
UPPER GEARCASE SEAL KIT
 For: TR & TRS Drives

Stern Drive Model	Years	S/N	Bearing Carrier O-Ring	Bearing Carrier Seals	Upper Unit Seal Kit	Lower Unit Seal & Brg. Kit	Lower Unit Seal Kit	U-Joint Carrier Seal
60/80/90	1965-72	1830753 - 3225967	18-7160	18-2011/18-2015	N/A	N/A	N/A	N/A
I	1963	1534570 - 1684187	18-7157	18-2002	18-2648	N/A	18-2652	18-0577
IA, IB, IC & EZ Shift	1964-66	1684188 - 2065189	18-7157	18-2002	18-2648	N/A	18-2652	18-0577
120/140	1967-69	2062141 - 6225576	18-7157	18-2002	18-2648	N/A	18-2652	18-0577
470/485	1976-82	4208730 - 6225576	18-7157	18-2002	18-2648	N/A	18-2652	18-0577
160/165	1967-77	2065190 - UP	18-7157	18-2002	18-2648	N/A	18-2652	18-0577
888	1971-77	3106717 - UP	18-7157	18-2002	18-2648	N/A	18-2652	18-0577
225/233	1974-77	3856268 - UP	18-7157	18-2002	18-2648	N/A	18-2652	18-0577
898/228/250/260	1977-82	4782330 - 4898729	18-7157	18-2002	18-2648	N/A	18-2652	18-0577
R	1983	6225577 - UP	18-7157	18-2002	18-2648	18-8207	18-2652	18-0577
MR / Alpha One	1984-90	6225577 - UP	18-7157	18-2002	18-2648	18-8208	18-2652	18-0577
MR / Alpha One	1984-90	6225577 - UP	18-7157	18-2077/18-2076	18-2648	18-8208	18-2652	18-0577
MR / Alpha One (CR)	1984-90	6225577 - UP	18-7157	18-2077/18-2076	18-2648	—	18-2652	18-0577
Alpha One SS	1986-89	A545004 - UP	18-7157	18-2002	18-2648	—	18-2652	18-0577
Alpha One SS	1986-89	A545004 - UP	18-7157	18-2077/18-2076	18-2648	—	18-2652	18-0577
Alpha One Gen II	1991-95	D469859 - F679999	18-7157	18-2077/18-2076	18-2644	—	18-2646-1	18-0577
Alpha One Gen II (CR)	1991-95	D469859 - F679999	18-7157	18-2077/18-2076	18-2644	—	18-2646-1	18-0577
Alpha One Gen II	1996-97	F680000 - K999999	18-7157	18-2077/18-2076	18-2644	—	18-2646-1	18-0577
Alpha One Gen II (CR)	1996-newer	F680000 - UP	18-7157	18-2077/18-2076	18-2644	—	18-2646-1	18-0577
Alpha One Gen II	1998-newer	L100040 - UP	18-7157	18-2077/18-2076	18-2644	—	18-2646-1	18-0577
Bravo I	1988-newer	B664190 - UP	18-7157	18-2002	18-2643	—	18-2645	—
Bravo II	1988-newer	B664190 - UP	18-7453	18-0536	18-2643	—	18-2645	—
Bravo III	1988-newer	B664190 - UP	18-7447	—	18-2643	—	18-2645	—
Blackhawk	1994-95	F186717 - UP	18-7451	—	18-2643	—	N/A	—
II	1962-69	1474909 - 2671321	18-7157	—	N/A	—	N/A	—
III	1968-72	2373127 - 3002613	—	—	N/A	—	N/A	—
215E/H	1970-72	2909035 - 2915034	18-7453	18-0536	N/A	—	N/A	—
TR	1973-93	3377316 - UP	18-7453	—	18-8371	—	N/A	—
TRS	1973-93	3377316 - UP	18-7157	18-2002	18-8371	—	N/A	—

① Line Cutter Seal

<p>② 18-4456D </p>  <p>18-4456 EXHAUST PROTECTOR VALVE Replaces: 34765A1, 34765A2 INCLUDES STAINLESS STEEL CLAMP 3"</p>	<p>② 18-4457D </p>  <p>18-4457 EXHAUST PROTECTOR VALVE Replaces: 12644A1 INCLUDES STAINLESS STEEL CLAMP 4"</p>	<p>② 18-4458D </p>  <p>18-4458 EXHAUST PROTECTOR VALVE (Fits both 5" & 6" Exhaust) INCLUDES STAINLESS STEEL CLAMP</p>
---	---	--

② Items ending in "D" are Display Packaged - Regular number is Non-Display

OIL SEALS



OIL SEALS

Part #	O.E. #	Shaft Size (inches)	Dimensions		Part #	O.E. #	Shaft Size (inches)	Dimensions	
			O.D.	Width (inches)				O.D.	Width (inches)
18-0172	26-97530	0.845	1.500	0.315	18-2007	26-94038	1.000	1.500	0.312
18-0515	26-30530	0.540	1.004	0.303	18-2008	26-56788	0.875	1.250	0.375
18-0516	26-30913	0.500	0.839	0.187	18-2009	26-89236	0.375	0.750	0.250
18-0517	26-32911	1.100	1.260	0.127	18-2009	26-892361	0.375	0.750	0.250
18-0519	26-14240	3.792	4.536	0.482	18-2010	26-96063	0.437	0.875	0.250
18-0522	26-43036	1.045	1.474	0.187	18-2011	26-90562	0.750	1.250	0.312
18-0523	26-43993	1.640	2.132	0.282	18-2013	26-16977	0.875	1.250	0.188
18-0525	26-45587	0.390	0.628	0.124	18-2014	26-89238	0.875	1.500	0.312
18-0526	26-48443	0.750	1.379	0.256	18-2015	26-23517	0.750	1.250	0.250
18-0527	26-56397	0.750	1.127	0.343	18-2016	26-41953	1.187	1.875	0.250
18-0529	26-62818	1.640	2.256	0.319	18-2017	26-32121	0.750	1.000	0.125
18-0531	26-72785	0.790	1.880	0.248	18-2019	26-27163	0.688	1.124	0.250
18-0537	26-85107	1.020	1.507	0.251	18-2019	26-26805	0.688	1.124	0.250
18-0578	26-67388	1.800	3.100	0.500	18-2026	26-16977	0.875	1.250	0.188
18-2002	26-76868	1.188	1.692	0.250	18-2048	26-24590	0.400	0.566	0.094
18-2003	26-68493	2.250	3.000	0.437	18-2049	26-32511	1.250	2.005	0.388
18-2004	26-20070	0.625	1.000	0.250	18-2050	26-55682	1.000	1.253	0.125
18-2006	26-33467	0.625	1.125	0.312	18-2051	26-69188	0.875	1.253	0.278
					18-2052	26-69189	0.875	1.314	0.322
					18-2053	26-70081	1.185	1.754	0.360
					18-2054	26-816464	0.375	0.750	0.243
					18-2055	26-79831	0.750	1.127	0.149
					18-2056	26-96503	0.885	1.381	0.251
					18-2056	26-965031	0.885	1.381	0.251
					18-2076	26-12224	1.188	1.690	0.360
					18-2077	26-14077	1.188	1.689	0.247

① Line Cutter Seal

DRIVESHAFT HOUSING

Stern Drive Model	Beg. S/N	End. S/N	Oil Seal	Desc.	Qty.	Stern Drive Model	Beg. S/N	End. S/N	Oil Seal	Desc.	Qty.
R/MR/Alpha I	6225577	UP	18-2003	BC	1	250	4791300	4898729	18-2003	BC	1
Alpha I SS		ALL	18-2003	BC	1	250	4791300	4898729	18-2056	LDS	1
Alpha I SS		ALL	18-2056	LDS	1	260	4898730	6225576	18-2049	GC	1
Alpha I SS		ALL	18-2049	GC	1	260	4898730	6225576	18-2056	LDS	1
IA,IB,IC	1684188	2065189	18-2003	BC	1	260	4898730	6225576	18-2003	BC	1
I,IA,IB,IC	1534570	2065189	18-2049	GC	1	470	4208730	6225576	18-2056	LDS	1
IA,IB,IC	1749276	2065189	18-2056	LDS	1	470	4208730	6225576	18-2003	BC	1
II	1474909	2671321	18-2003	BC	1	470	4208730	6225576	18-2049	GC	1
120/140	2062141	6225576	18-2003	BC	1	485	4893835	UP	18-2003	BC	1
120/140	2062141	6225576	18-2056	LDS	1	485	4893835	UP	18-2049	GC	1
120/140	2062141	6225576	18-2049	GC	1	485	4893835	UP	18-2056	LDS	1
160/165	2065190	UP	18-2003	BC	1	888	3106717	UP	18-2056	LDS	1
160/165	2065190	UP	18-2049	GC	1	888	3106717	UP	18-2049	GC	1
160/165	2065190	UP	18-2056	LDS	1	888	3106717	UP	18-2003	BC	1
225-S	3856268	4200499	18-2056	LDS	1	898/228	4782330	6225576	18-2049	GC	1
225-S	3856268	4200499	18-2049	GC	1	898/228	4782330	6225576	18-2003	BC	1
225-S	3856268	4200499	18-2003	BC	1	898/228	4782330	6225576	18-2056	LDS	1
233	4200500	UP	18-2049	GC	1						
233	4200500	UP	18-2003	BC	1						
233	4200500	UP	18-2056	LDS	1						
250	4791300	4898729	18-2049	GC	1						

BC Bearing Carrier Seal
GC Gear Chamber Seal
LDS Lower Driveshaft Seal

GEAR HOUSING

Stern Drive Model	Beg. S/N	End. S/N	Oil Seal	Desc.	Qty.	Stern Drive Model	Beg. S/N	End. S/N	Oil Seal	Desc.	Qty.
MR/Alpha I	6225577	UP	18-2002	PS	2	IA,IB,IC	1684188	2065189	18-2013	WPB	1
R/MR/Alpha I	6225577	UP	18-2009	SSB	1	IA,IB,IC	1684188	2065189	18-2013	WP	1
R/MR/Alpha I	6225577	UP	18-2014	WPB,L	1	IA,IB,IC	1684188	2065189	18-2009	SSB	1
MR/Alpha I	6225577	UP	18-2013	WPB,U	1	TRS	4794900	UP	18-2002	PS	2
R	6225577	UP	18-2013	WPB,U	1	60	1830753	2063740	18-2009	SSB	1
Alpha I SS	ALL		18-2014	WPB,L	1	60	1830753	2063740	18-2011	WPB,L	1
Alpha I SS	ALL		18-2009	SSB	1	60	1830753	2063740	18-2055	WPB,U	1
Alpha I SS	ALL		18-2013	WPB,U	1	60	1830753	2063740	18-2015	PS,O	1
Alpha I SS	ALL		18-2002	PS	2	60	1830753	2063740	18-2011	PS,I	1
BRAVO I	B664190	UP	18-2002	PS	2	80	2063741	2898029	18-2002	PS	2
I	1534570	1536617	18-2009	WPB	1	80	2063741	2898029	18-2009	SSB	1
I	1534570	1684187	18-2009	SSB	1	80	2063741	2898029	18-2055	WPB,U	1
I	1534570	1684187	18-2002	PS	2	80	2063741	2898029	18-2011	WPB,L	1
I	1534570	1684187	18-2013	WP	1	90	2898020	3225967	18-2009	SSB	1
I	1536618	1684187	18-2014	WPB	1	90	2898020	3225967	18-2002	PS	2
I	1563354	1684187	18-2013	WPB	1	90	2898020	3225967	18-2011	WPB,L	1
IA,IB,IC	1684188	2065189	18-2014	WPB	1	90	2898020	3225967	18-2055	WPB,U	1
IA,IB,IC	1684188	2065189	18-2002	PS	2	120/140	2062141	6225576	18-2013	WPB,U	1

GEAR HOUSING (Cont.)											
Stern Drive Model	Beg. S/N	End. S/N	Oil Seal	Desc.	Qty.	Stern Drive Model	Beg. S/N	End. S/N	Oil Seal	Desc.	Qty.
120/140	2062141	4893634	18-2013	WP	1	470	4208730	6225576	18-2009	SSB	1
120/140	2062141	6225576	18-2014	WPB,L	1	470	4208730	6225576	18-2014	WPB,L	1
120/140	2062141	6225576	18-2009	SSB	1	470	4208730	6225576	18-2002	PS	2
120/140	2062141	6225576	18-2002	PS	2	470	4208730	6225576	18-2013	WPB,U	1
160/165	2065190	UP	18-2009	SSB	1	485	4893835	UP	18-2002	PS	2
160/165	2065190	UP	18-2014	WPB,L	1	485	4893835	UP	18-2009	SSB	1
160/165	2065190	UP	18-2002	PS	2	485	4893835	UP	18-2013	WPB,U	1
160/165	2065190	4890459	18-2013	WP	1	485	4893835	UP	18-2014	WPB,L	1
160/165	2065190	UP	18-2013	WPB,U	1	888	3106717	UP	18-2014	WPB,L	1
225-S	3856268	4200499	18-2013	WPB,U	1	888	3106717	UP	18-2009	SSB	1
225-S	3856268	4200499	18-2014	WPB,L	1	888	3106717	UP	18-2013	WP	1
225-S	3856268	4200499	18-2002	PS	2	888	3106717	UP	18-2013	WPB,U	1
225-S	3856268	4200499	18-2009	SSB	1	888	3106717	UP	18-2002	PS	2
233	4200500	UP	18-2009	SSB	1	898/228	4782330	6225576	18-2014	WPB,L	1
233	4200500	UP	18-2013	WPB,U	1	898/228	4782330	6225576	18-2013	WPB,U	1
233	4200500	UP	18-2002	PS	2	898/228	4782330	6225576	18-2009	SSB	1
233	4200500	UP	18-2014	WPB,L	1	898/228	4782330	6225576	18-2002	PS	2
250	4791300	4898729	18-2013	WPB,U	1						
250	4791300	4898729	18-2014	WPB,L	1						
250	4791300	4898729	18-2002	PS	2						
250	4791300	4898729	18-2009	SSB	1						
255-TRS	3377316	4203749	18-2002	PS	2						
260	4898730	6225576	18-2009	SSB	1						
260	4898730	6225576	18-2002	PS	2						
260	4898730	6225576	18-2013	WPB,U	1						
260	4898730	6225576	18-2014	WPB,L	1						
280-TRS	4203750	4895399	18-2002	PS	2						

- PS Prop Shaft Seal
- PS,I Prop Shaft, Inner Seal
- PS,O Prop Shaft, Outer Seal
- SSB Shift Shaft Bushing Seal
- WPB Water Pump Base Seal
- WPB,L Water Pump Base, Lower Seal
- WPB,U Water Pump Base, Upper Seal
- WP Water Pump Body Seal

O-RINGS

Part #	O.E. #	Dimensions		Part #	O.E. #	Dimensions	
		I. D.	Width (inches)			I. D.	Width (inches)
				18-7161	25-32546	3.250	.070
				18-7162	25-33145	2.025	.135
				18-7163	25-33465	2.415	.100
				18-7164	25-33466	1.375	.100
				18-7165	25-45253	.500	.065
				18-7165	25-32509	.500	.065
				18-7166	25-45254	.615	.065
				18-7167	25-97386	3.609	.139
				18-7168	25-48171	.370	.065
				18-7169	25-70937	3.500	.135
				18-7170	25-33504	1.365	.135
				18-7171	25-30529	1.920	.100
				18-7172	25-31305	3.250	.135
				18-7173	25-30224	1.875	.135
				18-7174	25-45711	.620	.100
				18-7175	25-62817	3.750	.270
				18-7176	25-90011	2.160	.100
				18-7177	25-53421	2.625	.065
				18-7180	25-26802	.445	.090
				18-7188	25-805726	.361	.0635
				18-7198	25-45710	1.430	.100
				18-7411	25-35480	1.250	.100
				18-7413	25-62702	.301	.070
				18-7414	25-64067	1.989	.070
				18-7415	25-64966	3.739	.070
				18-7419	25-69202	2.675	.103
				18-7420	25-25439	.862	.139
				18-7421	25-20415	.150	.065
				18-7426	25-30271	.740	.310
				18-7440-1	25-36318	.799	.103
				18-7445	25-55801	.801	.070
				18-7449	25-97387	4.487	.103
				18-7459	25-20826	2.234	.139
				18-7464	25-39695	4.234	.139
				18-7467	25-54030	2.987	.103
				18-7474	25-94288	1.239	.070
				18-7961	25-97386	3.650	.135

① PKG. OF 1 ② PKG. OF 5 ③ PKG. OF 2 ④ PKG. OF 3

DRIVESHAFT HOUSING											
Stern Drive Model	Beg. S/N	End. S/N	Oil Seal	Desc.	Qty.	Stern Drive Model	Beg. S/N	End. S/N	Oil Seal	Desc.	Qty.
R/MR/Alpha I	6225577	UP	18-7153	UJ	2	233	4200500	UP	18-7169	BC	1
R/MR/Alpha I	6225577	UP	18-7169	BC	1	250	4791300	4898729	18-7153	UJ	2
R/MR/Alpha I	6225577	UP	18-7161	TC	1	250	4791300	4898729	18-7169	BC	1
Alpha I SS	ALL		18-7161	TC	1	250	4791300	4898729	18-7161	TC	1
Alpha I SS	ALL		18-7169	BC	1	255-TRS	3377316	4203749	18-7175	DSH	1
Alpha I SS	ALL		18-7153	UJ	2	260	4898730	6225576	18-7169	DG	1
BRAVO (I/II)	B664190	UP	18-7198	DSH	1	260	4898730	6225576	18-7161	TC	1
BRAVO (I/II)	B664190	UP	18-7153	UJ	2	260	4898730	6225576	18-7170	BH	1
I	1534570	1684187	18-7127	DG	1	260	4898730	6225576	18-7153	UJ	2
I,IA,IB,IC	1534570	1777798	18-7165	USSL	1	280-TRS	4203750	4895399	18-7175	DSH	1
I,IA,IB,IC	1535212	2065189	18-7170	BH	2	470	4208730	6225576	18-7169	BC	1
IA,IB,IC	1684188	2065189	18-7153	UJ	2	470	4208730	6225576	18-7161	TC	1
IA,IB,IC	1684188	2065189	18-7169	BC	1	470	4208730	6225576	18-7153	UJ	2
II	2398798	2671321	18-7153	UJ	2	470	4893835	6225576	18-7170	BH	1
II SSM	ALL		18-7175	DSH	1	485	4893835	UP	18-7161	TC	1
II SSM	ALL		18-7153	UJ	2	485	4893835	UP	18-7170	BH	1
II TR	3377316	4794899	18-7175	DSH	1	485	4893835	UP	18-7153	UJ	2
III/III SSM	ALL		18-7115	FC	1	485	4893835	UP	18-7169	DG	1
IV SSM ①	ALL		18-7115	FC	1	888	3106717	UP	18-7161	TC	1
I/IA/IB/IC	1534570	2065189	18-7161	TC	1	888	3106717	UP	18-7169	BC	1
TR/TRS ③	4794900	UP	18-7153	UJ	2	888	3106717	UP	18-7153	UJ	2
TR/TRS	4794900	UP	18-7175	DSH	1	898/228	4782330	6225576	18-7169	BC	1
120/140	2062141	6225576	18-7161	TC	1	898/228	4782330	6225576	18-7161	TC	1
120/140	2062141	6225576	18-7170	BH	1	898/228	4782330	6225576	18-7153	UJ	2
120/140	2062141	6225576	18-7169	DG	1	898/228	4898730	6225576	18-7170	BH	1
120/140	2062141	6225576	18-7153	UJ	2						
160/165	2065190	UP	18-7170	BH	1	①	1 ST Design				
160/165	2065190	UP	18-7169	DG	1	②	5/8" ID				
160/165	2065190	UP	18-7153	UJ	2	③	With Borg Warner Transmission				
160/165	2065190	UP	18-7161	TC	1	BC	Bearing Carrier Seal				
215H	2782203	2909034	18-7153	UJ	2	BH	Bell Housing Seal				
215H	2782203	2909034	18-7146	PC	1	CC	Crankshaft Cover Seal				
215E ②	2909035	2915034	18-7174	FC	1	DG	Drive Gear Seal				
215E	2909035	2915034	18-7146	CC	1	DSH	Driveshaft Housing Seal				
225-S	3856268	4200499	18-7153	UJ	2	FC	Front Cover Seal				
225-S	3856268	4200499	18-7169	BC	1	PC	Plug Cover Seal				
225-S	3856268	4200499	18-7161	TC	1	TC	Top Cover Seal				
233	4200500	UP	18-7161	TC	1	USSL	Upper Shift Shaft Lever Seal				
233	4200500	UP	18-7153	UJ	2	UJ	U-Joint Yoke Seal				

GEAR HOUSING											
Stern Drive Model	Beg. S/N	End. S/N	Oil Seal	Desc.	Qty.	Stern Drive Model	Beg. S/N	End. S/N	Oil Seal	Desc.	Qty.
R/MR/Alpha I	6225577	UP	18-7162	WPB	1	90	2898020	3225967	18-7155	WOAL	1
MR/Alpha I	6225577	UP	18-7176	WPB	1 ②	120/140	2062141	6225576	18-7153	SSB	1
R/MR/Alpha I	6225577	UP	18-7158	UDS	1	120/140	2062141	6225576	18-7158	UDS	1
R/MR/Alpha I	6225577	UP	18-7159	PBH	1	120/140	2062141	6225576	18-7159	PBH	1
R/MR/Alpha I	6225577	UP	18-7153	SSB	1	120/140	2062141	6225576	18-7162	WPB	1
Alpha I SS	ALL		18-7159	PBH	1	120/140	4893635	6225576	18-7114	GH	1 ③
Alpha I SS	ALL		18-7158	UDS	1	160/165	2065190	UP	18-7162	WPB	1
Alpha I SS	ALL		18-7153	SSB	1	160/165	2065190	UP	18-7153	SSB	1
Alpha I SS	ALL		18-7176	WPB	1 ②	160/165	2065190	UP	18-7158	UDS	1
BRAVO I	B664190	UP	18-7159	PBH	1	160/165	2065190	UP	18-7159	PBH	1
BRAVO I/II	B664190	UP	18-7163	GH	1	165	4890460	UP	18-7114	GH	1 ③
I	1534570	1684187	18-7157	PBH	1	225-S	3856268	4200499	18-7153	SSB	1
I	1534570	1536617	18-7153	WPB	1	225-S	3856268	4200499	18-7162	WPB	1
I	1534570	1684187	18-7153	SSB	1	225-S	3856268	4200499	18-7158	UDS	1
I,IA,IB,IC	1534570	2065189	18-7158	UDS	1	225-S	3856268	4200499	18-7159	PBH	1
I,IA,IB,IC	1536618	2065189	18-7162	WPB	1	233	4200500	UP	18-7162	WPB	1
IA,IB,IC	1684188	2065189	18-7159	PBH	1	233	4200500	UP	18-7158	UDS	1
IA,IB,IC	1684188	1777798	18-7153	WPB	1	233	4200500	UP	18-7159	PBH	1
IA,IB,IC	1684188	2065189	18-7153	SSB	1	233	4200500	UP	18-7153	SSB	1
II	1474909	2671321	18-7159	PBH	1	250	4791300	4898729	18-7159	PBH	1
III	ALL		18-7151	BRL	1	250	4791300	4898729	18-7158	UDS	1
III	ALL		18-7174	BRS	1	250	4791300	4898729	18-7162	WPB	1
TRS	4794900	UP	18-7159	PBH	1	250	4791300	4898729	18-7153	SSB	1
60	1830753	2063740	18-7153	SSB	1	255-TRS	3377316	4203749	18-7159	PBH	1
60	1830753	2063740	18-7160	PBH	1	260	4898730	6225576	18-7162	WPB	1
60	1830753	2063740	18-7155	WOAL	1	260	4898730	6225576	18-7159	PBH	1
60	1830753	2063740	18-7114	WOAS	1	260	4898730	6225576	18-7153	SSB	1
80	2063741	2898029	18-7157	PBH	1	260	4898730	6225576	18-7158	UDS	1
80	2063741	2898029	18-7155	WOAL	1	260	4898730	6225576	18-7114	GH	1 ③
80	2063741	2898029	18-7114	WOAS	1	280-TRS	4203750	4895399	18-7159	PBH	1
80	2063741	2898029	18-7153	SSB	1	470	4208730	6225576	18-7159	PBH	1
90	2898020	3225967	18-7114	WOAS	1	470	4208730	6225576	18-7162	WPB	1
90	2898020	3225967	18-7157	PBH	1	470	4208730	6225576	18-7158	UDS	1
90	2898020	3225967	18-7153	SSB	1	470	4208730	6225576	18-7153	SSB	1

⑤ This product is priced per piece. To order priced per package, please add -9 to the part number.

GEAR HOUSING (Cont.)											
Stern Drive Model	Beg. S/N	End. S/N	Oil Seal	Desc.	Qty.	Stern Drive Model	Beg. S/N	End. S/N	Oil Seal	Desc.	Qty.
470	4893835	6225576	18-7114	GH	1 ③	③	V-8 Engines Only				
485	4893835	UP	18-7158	UDS	1	BRL	Bearing Retainer Large Seal				
485	4893835	UP	18-7162	WPB	1	BRS	Bearing Retainer Small Seal				
485	4893835	UP	18-7153	SSB	1	GH	Gear Housing Seal				
485	4893835	UP	18-7114	GH	1 ③	PGH	Prop Bearing Housing Seal				
485	4893835	UP	18-7159	PBH	1	SSB	Shift Shaft Bushing				
888	3106717	UP	18-7162	WPB	1	UDS	Upper Driveshaft Seal				
888	3106717	UP	18-7158	UDS	1	WOAL	Water & Oil Adapter Large Seal				
888	3106717	UP	18-7153	SSB	1	WOAS	Water & Oil Adapter Small Seal				
888	3106717	UP	18-7159	PBH	1	WPB	Water Pump Base Seal				
898/228	4782330	6225576	18-7158	UDS	1						
898/228	4782330	6225576	18-7153	SSB	1						
898/228	4782330	6225576	18-7159	PBH	1						
898/228	4782330	6225576	18-7162	WPB	1						
898/228	4898730	6225576	18-7114	GH	1 ③						
①	2.019 ID										
②	2.17 ID										

GIMBAL HOUSING

Stern Drive Model	Beg. S/N	End. S/N	Oil Seal	Desc.	Qty.	Stern Drive Model	Beg. S/N	End. S/N	Oil Seal	Desc.	Qty.
R/MR/Alpha I	6225577	UP	18-7170	BH	1	260	4898730	6225576	18-7152	EE	1
BRAVO (I/II)	B664190	UP	18-7168	V	2 ①	470	4208730	6225576	18-7152	EE	1
I	1534570	1641940	18-7165	GHB	2	470	4208730	4893934	18-7170	BH	1
II	1474909	1475005	18-7151	SL	1	485	4893835	UP	18-7152	EE	1
II	1602186	2671321	18-7162	GHAS	1	888	3106717	UP	18-7170	BH	1
II	1732380	2671321	18-7172	GHAL	1	888	3106717	UP	18-7114	GH	1
III/III SSM/IV		ALL	18-7159	BH	1	888	3106717	UP	18-7152	EE	1
60	1830753	2063740	18-7172	BH	1	898/228	4782330	4898729	18-7170	BH	1
80	2063741	2898029	18-7172	BH	1	898/228	4782330	4898729	18-7114	GH	1
90	2898020	3225967	18-7172	BH	1	898/228	4782330	6225576	18-7152	EE	1
120/140	2062141	6225576	18-7152	EE	1						
160/165	2065190	UP	18-7152	EE	1	①	With Oil Reservoir				
225-S	3856268	4200499	18-7170	BH	1	BH	Bell Housing Seal				
225-S	3856268	4200499	18-7152	EE	1	EE	Exhaust Elbow Seal				
225-S	3856268	4200499	18-7114	GH	1	GH	Gimbal Housing Seal				
233	4200500	UP	18-7152	EE	1	GHAL	Gimbal Housing Adapter Large Seal				
233	4200500	UP	18-7114	GH	1	GHAS	Gimbal Housing Adapter Small Seal				
233	4200500	UP	18-7170	BH	1	GHB	Gimbal Housing Bolt Seal				
250	4791300	4898729	18-7152	EE	1	SL	Steering Lever Seal				
250	4791300	4898729	18-7114	GH	1	V	Valve Seal				
250	4791300	4898729	18-7170	BH	1						

HYDRAULIC PUMP ASSY

Stern Drive Model	Beg. S/N	End. S/N	Oil Seal	Desc.	Qty.	Stern Drive Model	Beg. S/N	End. S/N	Oil Seal	Desc.	Qty.
R/MR/Alpha I	6225577	UP	18-7168	CV	4	233	4200500	UP	18-7168	CV	4
BRAVO (I/II)	B664190	UP	18-7134	ORC	1	255-TRS	3377316	4203749	18-7168	CV	4
BRAVO (I/II)	B664190	UP	18-7158	ORS	1	260	4898730	6225576	18-7168	CV	4
II	2398798	2671321	18-7168	CV	4	280-TRS	4203750	4895399	18-7168	CV	4
II TR	3377316	4794899	18-7168	CV	4	470	4208730	6225576	18-7168	CV	4
III/III SSM/IV		ALL	18-7168	CV	4	485	4893835	UP	18-7168	CV	4
TR/TRS	4794900	UP	18-7168	CV	4	888	3106717	UP	18-7168	CV	4
90	2898020	3225967	18-7168	CV	4	898/228	4898730	6225576	18-7168	CV	4
120/140	2062141	6225576	18-7168	CV	4						
160/165	2065190	UP	18-7168	CV	4	CV	Control Valve				
215H/E	2782203	2915034	18-7168	CV	4	ORC	Oil Reservoir Connector				
225-S	3856268	4200499	18-7168	CV	4	ORS	Oil Reservoir Switch				

REVERSE LOCK VALVE

Stern Drive Model	Beg. S/N	End. S/N	Oil Seal	Desc.	Qty.	Stern Drive Model	Beg. S/N	End. S/N	Oil Seal	Desc.	Qty.
R/MR/Alpha I	6225577	UP	18-7174	VC	1	260	4898730	6225576	18-7174	VC	1
R/MR/Alpha I	6225577	UP	18-7198	V	1	470	4208730	6225576	18-7198	V	1
II	2398798	2671321	18-7198	V	1	470	4208730	6225576	18-7174	VC	1
II	2398798	2671321	18-7174	VC	1	485	4893835	UP	18-7174	VC	1
120/140	2062141	6225576	18-7198	V	1	485	4893835	UP	18-7198	V	1
120/140	2062141	6225576	18-7174	VC	1	898/228	4782330	6225576	18-7174	VC	1
160/165	2065190	UP	18-7198	V	1	898/228	4782330	6225576	18-7198	V	1
160/165	2065190	UP	18-7174	VC	1						
250	4791300	4898729	18-7198	V	1						
250	4791300	4898729	18-7174	VC	1	V	Valve Seal				
260	4898730	6225576	18-7198	V	1	VC	Valve Cover Seal				



Display Package

**18-5001
TUNE-UP KIT**
Replaces: 172525

—CONTAINS—

Part #	O.E. #	Description
18-5157	580290	Contact Set
18-5200	580256	Condenser



Display Package

**18-5250
TUNE-UP KIT**
Replaces: 172527

—CONTAINS—

Part #	O.E. #	Description
18-5311	380538	Contact Set
18-5345	380537	Condenser
18-5418	384735	Rotor

Delco 4 & 6 cyl.



Display Package

**18-5251
TUNE-UP KIT**
Replaces: 173619

—CONTAINS—

Part #	O.E. #	Description
18-5314	382135	Contact Set
18-5338	382136	Condenser
18-5404-1	982211	Rotor

Mallory 8 cyl. Tall Cap



**18-5252
TUNE-UP KIT**

—CONTAINS—

Part #	O.E. #	Description
18-5310	380543	Contact Set
18-5344	382125	Condenser
—	381711	Rotor

Delco 8 cyl.



**18-5256
TUNE-UP KIT**
Replaces: 172531

—CONTAINS—

Part #	O.E. #	Description
18-5314	382135	Contact Set
18-5338	382136	Condenser
18-5411	982342	Rotor

Mallory 8 cyl. Flat Cap



① 18-5258D Display Package

**18-5258
TUNE-UP KIT**
Replaces: 173690, 987925

—CONTAINS—

Part #	O.E. #	Description
18-5303	980893	Contact Set
18-5347	980894	Condenser
18-5407	980892	Rotor

Prestolite 8 cyl.



Display Package

**18-5260
TUNE-UP KIT**
Replaces: 173829, 987926

—CONTAINS—

Part #	O.E. #	Description
18-5303	980893	Contact Set
18-5347	980894	Condenser
18-5403	982880	Rotor





**18-5266
TUNE UP KIT**
Fits: Flame Thrower Distributors 18-5481, 18-5482, 18-5483, 18-5477, 18-5478 and 18-5479



Display Package

**18-5268
TUNE-UP KIT**

—CONTAINS—

Part #	O.E. #	Description
18-5311	380538	Contact Set
18-5345	380537	Condenser
18-5418	384735	Rotor
18-5385	380541	Distributor Cap

Delco In-Line 4 - Single Point



Display Package

**18-5269
TUNE-UP KIT**

—CONTAINS—

Part #	O.E. #	Description
18-5311	380538	Contact Set
18-5345	380537	Condenser
18-5418	384735	Rotor
18-5386	980152	Distributor Cap

Delco In-Line 6 - Single Point



Display Package

**18-5270
TUNE-UP KIT**

—CONTAINS—

Part #	O.E. #	Description
18-5310	380543	Contact Set
18-5344	382125	Condenser
—	381711	Rotor
18-5384	383587	Distributor Cap

Delco V-8 - Single Point



Display Package

**18-5271
TUNE-UP KIT**



—CONTAINS—

Part #	O.E. #	Description
18-5314	382135	Contact Set
18-5338	382136	Condenser
18-5404-1	982211	Rotor
18-5376	982209	Distributor Cap

Mallory V-8 - Single Point - Top Terminal

APPLICATION BEGINS ON PAGE 750

① Items ending in "D" are Display Packaged - Regular number is Non-Display

























 <p>18-5272 TUNE-UP KIT —CONTAINS—</p> <table border="1"> <thead> <tr> <th>Part #</th> <th>O.E. #</th> <th>Description</th> </tr> </thead> <tbody> <tr> <td>18-5314</td> <td>382135</td> <td>Contact Set</td> </tr> <tr> <td>18-5338</td> <td>382136</td> <td>Condenser</td> </tr> <tr> <td>18-5411</td> <td>982342</td> <td>Rotor</td> </tr> <tr> <td>18-5375</td> <td>382133</td> <td>Distributor Cap</td> </tr> </tbody> </table> <p>Mallory Flat V-8 - Single Point - Side Terminal</p>	Part #	O.E. #	Description	18-5314	382135	Contact Set	18-5338	382136	Condenser	18-5411	982342	Rotor	18-5375	382133	Distributor Cap	 <p>18-5275 TUNE-UP KIT —CONTAINS—</p> <table border="1"> <thead> <tr> <th>Part #</th> <th>O.E. #</th> <th>Description</th> </tr> </thead> <tbody> <tr> <td>18-5303</td> <td>980893, 987136, 987894</td> <td>Contact Set</td> </tr> <tr> <td>18-5347</td> <td>980894, 987895</td> <td>Condenser</td> </tr> <tr> <td>18-5403</td> <td>982880</td> <td>Rotor</td> </tr> <tr> <td>18-5352</td> <td>984401</td> <td>Distributor Cap</td> </tr> </tbody> </table> <p>Prestolite V-8 - Single Point - Screw Cap</p>	Part #	O.E. #	Description	18-5303	980893, 987136, 987894	Contact Set	18-5347	980894, 987895	Condenser	18-5403	982880	Rotor	18-5352	984401	Distributor Cap	 <p>18-5276 TUNE-UP KIT —CONTAINS—</p> <table border="1"> <thead> <tr> <th>Part #</th> <th>O.E. #</th> <th>Description</th> </tr> </thead> <tbody> <tr> <td>18-5303</td> <td>980893, 987136, 987894</td> <td>Contact Set</td> </tr> <tr> <td>18-5347</td> <td>980894, 987895</td> <td>Condenser</td> </tr> <tr> <td>18-5403</td> <td>982880</td> <td>Rotor</td> </tr> <tr> <td>18-5353</td> <td>984398</td> <td>Distributor Cap</td> </tr> </tbody> </table> <p>Prestolite V-6 - Single Point - Screw Cap</p>	Part #	O.E. #	Description	18-5303	980893, 987136, 987894	Contact Set	18-5347	980894, 987895	Condenser	18-5403	982880	Rotor	18-5353	984398	Distributor Cap	 <p>18-5277 TUNE-UP KIT —CONTAINS—</p> <table border="1"> <thead> <tr> <th>Par t#</th> <th>O.E. #</th> <th>Description</th> </tr> </thead> <tbody> <tr> <td>18-5303</td> <td>980893, 987136, 987894</td> <td>Contact Set</td> </tr> <tr> <td>18-5347</td> <td>980894, 987895</td> <td>Condenser</td> </tr> <tr> <td>18-5407</td> <td>980892</td> <td>Rotor</td> </tr> <tr> <td>18-5369</td> <td>982336</td> <td>Distributor Cap</td> </tr> </tbody> </table> <p>Prestolite V-8 - Single Point - Clip Cap</p>	Par t#	O.E. #	Description	18-5303	980893, 987136, 987894	Contact Set	18-5347	980894, 987895	Condenser	18-5407	980892	Rotor	18-5369	982336	Distributor Cap
Part #	O.E. #	Description																																																													
18-5314	382135	Contact Set																																																													
18-5338	382136	Condenser																																																													
18-5411	982342	Rotor																																																													
18-5375	382133	Distributor Cap																																																													
Part #	O.E. #	Description																																																													
18-5303	980893, 987136, 987894	Contact Set																																																													
18-5347	980894, 987895	Condenser																																																													
18-5403	982880	Rotor																																																													
18-5352	984401	Distributor Cap																																																													
Part #	O.E. #	Description																																																													
18-5303	980893, 987136, 987894	Contact Set																																																													
18-5347	980894, 987895	Condenser																																																													
18-5403	982880	Rotor																																																													
18-5353	984398	Distributor Cap																																																													
Par t#	O.E. #	Description																																																													
18-5303	980893, 987136, 987894	Contact Set																																																													
18-5347	980894, 987895	Condenser																																																													
18-5407	980892	Rotor																																																													
18-5369	982336	Distributor Cap																																																													

 <p>18-5278 TUNE-UP KIT For: Delco EST V-6</p>	 <p>18-5279 TUNE-UP KIT For: Prestolite Electronic V-8</p> <table border="1"> <thead> <tr> <th>Part #</th> <th>Description</th> <th>O.E.#</th> <th>Qty.</th> </tr> </thead> <tbody> <tr> <td>18-5352</td> <td>Distributor Cap</td> <td>392-9766</td> <td>1</td> </tr> <tr> <td>18-5403</td> <td>Rotor</td> <td>392-9089</td> <td>1</td> </tr> </tbody> </table>	Part #	Description	O.E.#	Qty.	18-5352	Distributor Cap	392-9766	1	18-5403	Rotor	392-9089	1	 <p>18-5280 TUNE-UP KIT For: Delco EST In-Line 4</p> <table border="1"> <thead> <tr> <th>Part #</th> <th>Description</th> <th>O.E.#</th> <th>Qty.</th> </tr> </thead> <tbody> <tr> <td>18-5361</td> <td>Distributor Cap</td> <td>986643</td> <td>1</td> </tr> <tr> <td>18-5406</td> <td>Rotor, Delco</td> <td>986651</td> <td>1</td> </tr> </tbody> </table>	Part #	Description	O.E.#	Qty.	18-5361	Distributor Cap	986643	1	18-5406	Rotor, Delco	986651	1	 <p>18-5283 TUNE-UP KIT For: Mallory Single Point In-Line 4</p>
Part #	Description	O.E.#	Qty.																								
18-5352	Distributor Cap	392-9766	1																								
18-5403	Rotor	392-9089	1																								
Part #	Description	O.E.#	Qty.																								
18-5361	Distributor Cap	986643	1																								
18-5406	Rotor, Delco	986651	1																								

 <p>18-5157 CONTACT SET Replaces: 580290</p>	 <p>18-5303 CONTACT SET Replaces: 980893, 987136, 987894</p>	 <p>18-5310 CONTACT SET Replaces: 380543</p>	 <p>18-5311 CONTACT SET Replaces: 380538</p>	 <p>18-5314 CONTACT SET Replaces: 382135</p>
---	---	---	---	---

 <p>18-5200 CONDENSER Replaces: 580256</p>	 <p>18-5338 CONDENSER Replaces: 382136</p>	 <p>18-5344 CONDENSER Replaces: 382125</p>	 <p>18-5345 CONDENSER Replaces: 380537</p>	 <p>18-5347 CONDENSER Replaces: 980894, 987895</p>
--	--	--	--	--

 <p>18-5403 ROTOR Replaces: 982880</p>	 <p>18-5404-1 ROTOR Replaces: 982211</p>	 <p>18-5405 ROTOR Replaces: 3854549 V-8 Fits new GM style "Module in Cap"</p>	 <p>18-5406 ROTOR Replaces: 986651 Use with 18-5361 Distributor Cap</p>	 <p>18-5407 ROTOR Replaces: 980892</p>
--	--	---	---	--

 <p>18-5408 ROTOR Replaces: 3854311 V-6 Fits new GM style "Module in Cap"</p>	 <p>18-5411 ROTOR Replaces: 982342</p>	 <p>18-5413 ROTOR Replaces: 987986</p>	 <p>18-5418 ROTOR Replaces: 384735</p>	 <p>18-5419 ROTOR Replaces: 380542</p>
 <p>18-5301 TUNE-UP KIT Replaces: Fits: male cap v-8 flamethrower distributors</p>	 <p>18-5302 TUNE-UP KIT Replaces: Fits: male cap v-8 flamethrower distributors</p>	 <p>18-5474 DISTRIBUTOR CAP Red Distributor Cap with Male Terminals Petronix Dsistributors</p>	 <p>18-5473 DISTRIBUTOR CAP Black Distributor Cap w/ Male Terminals Petronix Dsistributors</p>	 <p>18-5248 DISTRIBUTOR CAP OMC 3854217 Fits: OMC 5.0L(1994-96), 5.8L(1994-96)</p>
 <p>18-5352 DISTRIBUTOR CAP Replaces: 984401 Prestolite</p>	 <p>18-5353 DISTRIBUTOR CAP Replaces: 984398 Prestolite</p>	 <p>18-5354 DISTRIBUTOR CAP Replaces: 3854548 V-8 Fits new GM style "module in cap"</p>	 <p>18-5361 DISTRIBUTOR CAP Replaces: 986643</p>	 <p>18-5362 DISTRIBUTOR CAP Replaces: 3854331 V-6 Fits new GM style "Module in Cap"</p>
 <p>18-5369 DISTRIBUTOR CAP Replaces: 982336 w/Gasket 18-5399</p>	 <p>18-5375 DISTRIBUTOR CAP Replaces: 382133</p>	 <p>18-5376 DISTRIBUTOR CAP Replaces: 982209</p>	 <p>18-5384 DISTRIBUTOR CAP Replaces: 383587</p>	 <p>18-5385 DISTRIBUTOR CAP Replaces: 380541</p>
 <p>18-5386 DISTRIBUTOR CAP Replaces: 980152</p>	 <p>18-5397 DISTRIBUTOR CAP</p>	 <p>18-5107-1 IGNITION MODULE Replaces: 3854003 4/6/8 cyl</p>	 <p>18-5464 IGNITION MODULE Fits: Sierra 18-5481, 18-5482 and 18-5483 Billet HI-PERFORMANCE ELECTRONIC DISTRIBUTORS (except HEI/EST)</p>	 <p>18-5108 SENSOR (Pick-Up Coil) Replaces: 3854001, 986642 4, V-6 and V-8 cyl.</p>



FEATURES

- ★ Oil filled for better cooling and long life
- ★ Low resistance and improved turn ratios produces the higher voltage needed to run larger spark plug gaps for added power and better fuel economy
- ★ More windings maximize energy and reliability over the full RPM range
- ★ Fits existing brackets for easy installation

 <p>18-5466 HI-PERFORMANCE IGNITION COIL 1.5 ohm (oil filled), black - 8 cylinder: Flame-Thrower 40,000 volt coil. ★ Designed for use with the original Ignitor Electronic Conversion Kits ★ Can be used with other inductive ignition systems</p>	 <p>18-5469 HI-PERFORMANCE IGNITION COIL 3.0 ohm (oil filled), black - 4 & 6 cylinder: Flame-Thrower 40,000 volt coil. ★ Designed for use with the original Ignitor Electronic Conversion Kits ★ Can be used with other inductive ignition systems</p>	 <p>18-5472 HI-PERFORMANCE IGNITION COIL 0.6 ohm (oil filled), black - 4, 6, & 8 cylinder:Flame-Thrower 45,000 volt coil. ★ Super low 0.6 ohm resistance coil designed for use with the Ignitor II Hi Performance Electronic Conversion Kits ★ Compatible with capacitive discharge systems</p>
--	---	---

Part #	Description	Recommended Coil	Resistance Ohms	Part #	Description	Recommended Coil	Resistance Ohms
18-5293-1	Electronic Conversion Kit	18-5469	3.0	18-5288	Hi Performance Electronic Conversion Kit	18-5472	0.6
18-5294	Electronic Conversion Kit	18-5469	3.0	18-5289	Hi Performance Electronic Conversion Kit	18-5472	0.6
18-5295	Electronic Conversion Kit	18-5469	3.0	18-5290	Hi Performance Electronic Conversion Kit	18-5472	0.6
18-5296-2	Electronic Conversion Kit	18-5466	1.5	18-5481	Flame-Thrower Distributor	18-5472	0.6
18-5298	Electronic Conversion Kit	18-5466	1.5	18-5482	Flame-Thrower Distributor	18-5472	0.6
18-5299	Electronic Conversion Kit	18-5466	1.5	18-5483	Flame-Thrower Distributor	18-5472	0.6
18-5286	Hi Performance Electronic Conversion Kit	18-5472	0.6				



**18-5433
IGNITION COIL**
Replaces: 915735
Uses External Resistor
For: 3.0L (1991 & up), 5.7 EFI (1996 & up) and 7.4L EFI (1995 & up)

Display Package



**18-5437
IGNITION COIL**
Replaces: 383444, 378231
Metal Encased - 12 Volt
Uses External Resistor (For All Applications)
For: 1990 & prior stern drives with breaker point ignition



**18-5443
IGNITION COIL**
Replaces: 3854002
4 cyl./V-8
For: 3.0L (1991 & up), 5.7 EFI (1996 & up) & 7.4 EFI (1995 & up)



**18-5888
SHIFT ASSIST MODULE & HARNESS**
Replaces: 987738
For: V-8 Sterndrives
Fits: 5.0, 5.7 GM (1986-90) 7.5 460 Ford (1987-91)



**18-5889
SHIFT ASSIST MODULE & HARNESS**
Replaces: 987739
For: V-8 Sterndrives
Fits: 5.0, 5.8 Ford (1986-90)



**18-5890
SHIFT ASSIST MODULE & HARNESS**
Replaces: 987740
Fits: 2.3, 3.0, 4.3 (1986-90) & 2.5 (1986)

APPLICATION BEGINS ON PAGE 750



FEATURES

- ★ Senses current levels in the coil and adjusts the dwell to maintain peak energy throughout the entire RPM range.
- ★ Develops, on average, 4 times more available energy between 3000 and 5000 RPM's and twice as much plug voltage as point-type systems.
- ★ Ignition energy is sustained and coil life is increased when peak current level is reached just prior to spark.
- ★ More stable timing.
- ★ Use with 18-5472 "Flame Thrower II" Coil for optimum performance



18-5285
HI-PERFORMANCE
ELECTRONIC CONVERSION KIT
Fits: 4 Cylinder Delco Distributors



18-5286
HI-PERFORMANCE
ELECTRONIC CONVERSION KIT
Fits: 6 Cylinder Delco Distributors



18-5287-1
HI-PERFORMANCE
ELECTRONIC CONVERSION KIT
Fits: Fits: 6 Cylinder Prestolite Distributors



18-5288
HI-PERFORMANCE
ELECTRONIC CONVERSION KIT
Fits: Most Prestolite V-8 Distributors with snap down cap



18-5289
HI-PERFORMANCE
ELECTRONIC CONVERSION KIT
Fits: Most Prestolite V-8 Distributors with screw down cap



18-5290
HI-PERFORMANCE
ELECTRONIC CONVERSION KIT
Fits: Most Mallory YL or YD 8 cylinder Distributors with clockwise and counter clockwise rotation



FEATURES

- ★ Replaces points & condensers for true solid state ignition.
- ★ Uses standard coil, cap and rotor.
- ★ Easy to install, one-piece, 2-wire hook-up.
- ★ Accurate to within 1/4° timing accuracy 0 to 6000 RPM range.

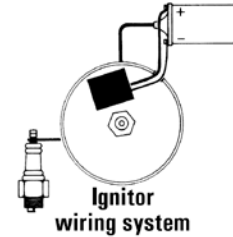
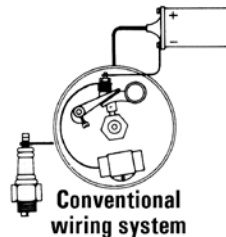

Not compatible with shift assist modules



18-5293-1
ELECTRONIC CONVERSION KIT
For: All Chevrolet V-6 Prestolite with screw down caps



18-5294
ELECTRONIC CONVERSION KIT
Fits: 6 Cyl. Delco distributors



18-5295
ELECTRONIC CONVERSION KIT
Fits: Most 4 Cyl. Prestolite distributors (except IBM 7026)
For: Onan, Universal, Waukesha, Wisconsin

Not compatible with shift assist modules

APPLICATION BEGINS ON PAGE 750

① 18-5296-2D Display Package



**18-5296-2
ELECTRONIC
CONVERSION KIT**
Fits: Most Mallory YL & YD 8 cyl.
Distributors with clockwise and counter
clockwise rotation

① 18-5297D Display Package



**18-5297
ELECTRONIC
CONVERSION KIT**
For 4 Cyl. GM

① 18-5298 Display Package



**18-5298
ELECTRONIC
CONVERSION KIT**
(with snap down cap)
For: Most Prestolite V-8 Distributors

① 18-5299D Display Package





**18-5299
ELECTRONIC
CONVERSION KIT**
(with screw down cap)
For: Most Prestolite V-8 Distributors
Use with 18-5403 style rotor

Not compatible with shift assist modules



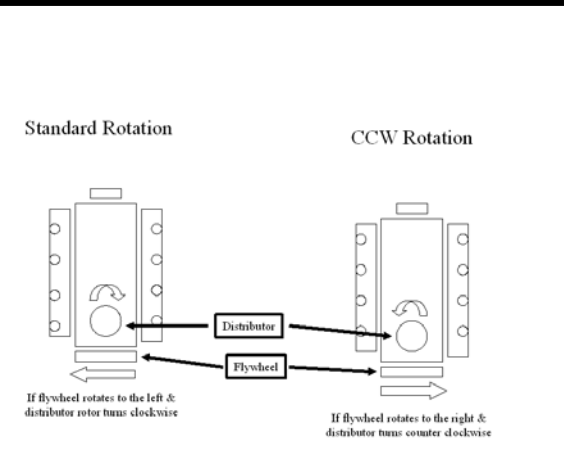

FEATURES

- ★ *Distributors feature the Ignitor II ignition module with adaptive dwell control adjusts the spark timing over the entire RPM range to maximize performance*
- ★ *Upper roller bearing and oil impregnated bronze sintered bottom bushing are installed and aligned bored for accuracy for maximum durability*
- ★ *Machined heat treated gear with tight tolerances insures durability and consistent timing to maximize horsepower and performance. Complete with high dielectric strength cap and rotor for years of performance*

**18-5481
HI-PERFORMANCE
ELECTRONIC
DISTRIBUTOR**
Fits: Ford V-8 351 Windsor
Replacement cap/rotor kit: 18-5266

**18-5482
HI-PERFORMANCE
ELECTRONIC
DISTRIBUTOR**
Fits: Ford V-8 351 Cleveland, 351M, 400,
429 and 460 engines
Replacement cap/rotor kit: 18-5266



**18-5483
HI-PERFORMANCE
ELECTRONIC
DISTRIBUTOR**
Fits: Chevrolet Marine Small and Big Block
engines (Standard Deck Height)
Replacement cap/rotor kit: 18-5266



**18-5477
ELECTRONIC DISTRIBUTOR**
Fits: Ford 302 V-8 engines



**18-5478
ELECTRONIC DISTRIBUTOR**
Chrysler LA series V-8 engines

APPLICATION BEGINS ON PAGE 750

① Items ending in "D" are Display Packaged - Regular number is Non-Display



18-5479
ELECTRONIC DISTRIBUTOR
 GM V-8 engines-reverse rotation



18-5476
DISTRIBUTOR
 Fits: GM V-6 engines with Delco EST ignition HEI



18-5486
ELECTRONIC DISTRIBUTOR
 Replaces: Mallory YLM673AV
 Conventional Rotation
 For Chevrolet L4, 153 & 181 CID

—CONTAINS—

Part #	Description
18-5397	Distributor Cap
18-5488	Module
18-5404-1	Rotor



18-5487
ELECTRONIC DISTRIBUTOR
 Replaces: Mallory YLM676AV
 Conventional Rotation
 For Chevrolet L6, 194, 230, 250, 292 CID

—CONTAINS—

Part #	Description
18-5488	Module
18-5404-1	Rotor



18-5489
ELECTRONIC DISTRIBUTOR
 Replaces: Mallory YLM554CV
 Conventional Rotation
 For Ford V8 351W CID

—CONTAINS—

Part #	Description
18-5376	Distributor Cap
18-5488	Module
18-5404-1	Rotor



18-5494-1
ELECTRONIC DISTRIBUTOR
 Replaces: Mallory YLM624AV
 Conventional Rotation
 For Chevrolet all V8 includes 482, 502, 540 CID
 (Except 348,409 & Tall Deck Big Block)

—CONTAINS—

Part #	Description
18-5376	Distributor Cap
18-5488	Module
18-5404-1	Rotor



18-5495-1
ELECTRONIC DISTRIBUTOR
 Replaces: Mallory YLM512CV
 Conventional Rotation
 For Ford V8 302 CID

—CONTAINS—

Part #	Description
18-5376	Distributor Cap
18-5488	Module
18-5404-1	Rotor



18-5496-1
ELECTRONIC DISTRIBUTOR
 Replaces: Mallory YLM567CV
 Conventional Rotation
 For Ford V8 351C — 460 CID

—CONTAINS—

Part #	Description
18-5376	Distributor Cap
18-5488	Module
18-5404-1	Rotor



**18-5498-1
ELECTRONIC
DISTRIBUTOR**

Replaces:
Mallory YLM624BV
Reverse Rotation
For Chevrolet all V8 includes 482, 502, 540 CID
(Except 348,409 & Tall Deck Big Block)

—CONTAINS—

Part #	Description
18-5376	Distributor Cap
18-5488	Module
18-5404-1	Rotor



**18-5484-1
ELECTRONIC
DISTRIBUTOR**

Replaces: Mallory YLE624AV
Late HEI
Left Hand Rotation

V8 262-454 & 502 except 348/409 and tall block engines
• Designed as a plug-in replacement for GM-style fuel injection system distributors

—CONTAINS—

Part #	Description
18-5354	Distributor Cap
18-5405	Rotor



**18-5485
ELECTRONIC
DISTRIBUTOR**

Replaces: Mallory YLE624BV
Late HEI
Right Hand Rotation

V8 262-454 & 502 except 348/409 and tall block engines
• Designed as a plug-in replacement for GM-style fuel injection system distributors

—CONTAINS—

Part #	Description
18-5354	Distributor Cap
18-5405	Rotor



**18-5309
DISTRIBUTOR**

Contact Controlled
Replaces: 980902; Mallory YL512CV
For most Ford 302 CID V-8 Eng.
Uses: 18-5251 TUNE-UP KIT And 18-5376 CAP



**18-5312
DISTRIBUTOR**

Contact Controlled
Replaces: 981080; Mallory YL554CV
For most Ford 351 CID V-8 Eng.
Uses: 18-5251 TUNE-UP KIT And 18-5376 CAP



**18-5313
DISTRIBUTOR**

Contact Controlled
Replaces: 985560; Mallory YL624MW
For most GM V-8 Engs. (small & large blocks)
Uses: 18-5251 TUNE-UP KIT And 18-5376 CAP



**18-5315
DISTRIBUTOR**

Contact Controlled
Replaces: Mallory YL673AV
For most GM 4 Cyl. Engines (120 & 140 HP)
Uses: 18-5251 TUNE-UP KIT And 18-5397 CAP



**18-5480
COMPLETE
IGNITION
CONVERSION KIT**

Fits: GM SB & BB with Standard Deck Height

—CONTAINS—

Part #	Description
18-5472	Coil
18-8803-2	Wire Set
18-5483	Distributor

Model	Year	Cyl.	Distributor	Contact Set	Condenser	Dist. Cap	Rotor	Tune-Up Kit	Distributor	Electronic Conv. Kit
2.3L	1987-90	4	Mallory ①	18-5314	18-5338	18-5397	18-5404-1	18-5283 ②	—	—
2.3L	1990	4	Prestolite	18-5303	18-5347	—	18-5403	18-5260	—	—
2.5L	1981-86	4	982351 ④	18-5311	18-5345	18-5385	18-5418	18-5250 18-5268 ②	18-5486 ⑧⑩ 18-5315 ⑩	18-5297 ①
3.0L	1982-90	4	982351 ④⑦	18-5311	18-5345	18-5385	18-5418	18-5250 18-5268 ②	18-5486 ⑧⑩ 18-5315 ⑩	18-5297 ①
3.0L	1990-UP	4	—	—	—	18-5361	18-5406	—	—	—
3.8L	1981-86	6	982846, 983203 ②⑥	18-5303	18-5347 ③	18-5353	18-5403	18-5262 18-5276 ②	—	—
4.3L	1985-90	6	— ②⑥	18-5303	18-5347 ③	18-5353	18-5403	18-5262 18-5276 ②	—	—
4.3L	1991-92	6	986855 ②	N/A	N/A	18-5353	18-5403	N/A	—	N/A
5.0L (GM)	1981-88	8	983453 ①	18-5314	18-5338	18-5376	18-5404-1	18-5251 18-5271 ②	18-5494-1 ⑧⑩ 18-5498-1 ⑨⑩ 18-5313 ⑩	18-5296-2①
5.0L (GM)	1983-88	8	IBM-7013C ②⑥	18-5303	18-5347 ③	18-5352	18-5403	18-5262 18-5275 ②	18-5494-1 ⑧⑩ 18-5498-1 ⑨⑩ 18-5313 ⑩	18-5299 ①
5.0L (GM)	1979-82	8	— ②⑤	18-5303	18-5347 ③	18-5369	18-5407	18-5258 18-5277 ②	18-5494-1 ⑧⑩ 18-5498-1 ⑨⑩ 18-5313 ⑩	18-5298
5.0L (Ford)	1989-90	8	— ②⑥	18-5303	18-5347 ③	18-5352	18-5403	18-5262 18-5275 ②	18-5309 ⑩ 18-5495-1 ⑧	—
5.0L	1991-92	8	— ②⑥	N/A	N/A	18-5352	18-5403	N/A	18-5309 ⑩	18-5299
5.0L (Ford)	1993	8	Ford	N/A	N/A	—	18-5413	N/A	—	—
5.7L	1982-90	8	983453 ①	18-5314	18-5338	18-5376	18-5404-1	18-5251 18-5271 ②	18-5494-1 ⑧⑩ 18-5498-1 ⑨⑩ 18-5313 ⑩	18-5296-2①
5.7L	1982-90	8	IBM-7013C ②⑥	18-5303	18-5347 ③	18-5352	18-5403	18-5262 18-5275 ②	18-5494-1 ⑧⑩ 18-5498-1 ⑨⑩ 18-5313 ⑩	18-5299 ①
5.7L	1991-92	8	— ②⑥	N/A	N/A	18-5352	18-5403	N/A	18-5494-1 ⑧ 18-5498-1 ⑨ 18-5313 ⑩	N/A
5.8L (Ford)	1989-90	8	— ②⑥	18-5303	18-5347 ③	18-5352	18-5403	18-5262 18-5275 ②	18-5489 ⑧ 18-5312 ⑩	18-5299
5.8L (Ford)	1991-92	8	— ②⑥	N/A	N/A	18-5352	18-5403	N/A	18-5496-1 ⑧ 18-5312 ⑩	18-5299
5.8L (Ford)	1993	8	Ford	N/A	N/A	—	18-5413	N/A	—	—
7.5L	1987	8	— ②⑤	18-5303	18-5347 ③	18-5369	18-5407	18-5258 18-5277 ②	18-5496-1 ⑧ 18-5312 ⑩	18-5298
7.5L	1987-89	8	— ②⑥	18-5303	18-5347 ③	18-5352	18-5403	18-5262 18-5275 ②	18-5496-1 ⑧ 18-5312 ⑩	18-5299
88	1962-68	4	—	18-5157	18-5200	—	—	18-5001	—	—
90	1962-68	4	—	18-5157	18-5200	—	—	18-5001	—	—
100	1972-73	4	384720, 979856, 980500, 982351 ④	18-5311	18-5345	18-5385	18-5418	18-5250 18-5268 ②	18-5486 ① 18-5315 ⑩	18-5297
110	1964	4	— ④	18-5311	18-5345	18-5385	18-5418	18-5250 18-5268 ②	18-5486 ① 18-5315 ⑩	18-5297
120	1965-86	4	383581, 384258 ④	18-5311	18-5345	18-5385	18-5418	18-5250 18-5268 ②	18-5486 ① 18-5315 ⑩	18-5297 ①
140	1973-89	4	980500, 982351 ④	18-5311	18-5345	18-5385	18-5418	18-5250 18-5268 ②	18-5486 ① 18-5315 ⑩	18-5297 ①
150	1964-66	6	1110309, 22 ④	18-5310	18-5345	—	18-5419	—	—	—
155	1967-72	6	1110376 ④	18-5310	18-5344	—	18-5419	—	—	—
165	1972-76	6	980156 ④	18-5311	18-5345	18-5386	18-5418	18-5250 18-5269 ②	18-5487 ① 18-5495-1 ⑧	—
170	1974	8	— ②⑤	18-5303	18-5347 ③	18-5369	18-5407	18-5258 18-5277 ②	18-5495-1 ⑧ 18-5309 ⑩	18-5298
175	1975-77	8	980902 ②⑤	18-5303	18-5347 ③	18-5369	18-5407	18-5258 18-5277 ②	18-5495-1 ⑧ 18-5309 ⑩	18-5298
185	1967-68	8	381775 ①	18-5314	18-5338	18-5375	18-5411	18-5256 18-5272 ②	18-5495-1 ⑧ 18-5309 ⑩	—
185	1978-80	8	981659 ①	18-5314	18-5338 ③	18-5376	18-5404-1	18-5251 18-5271 ②	18-5495-1 ⑧ 18-5309 ⑩	18-5296-2
185	1978-80	8	982320 ②⑤	18-5303	18-5347	18-5369	18-5407	18-5258 18-5277 ②	18-5495-1 ⑧ 18-5309 ⑩	18-5298
190	1974-77	8	980902 ②⑤	18-5303	18-5347 ③	18-5369	18-5407	18-5258 18-5277 ②	18-5495-1 ⑧ 18-5309 ⑩	18-5298
200	1966	8	— ④	18-5310	18-5345	18-5384	—	18-5270 ②	18-5494-1 ⑧ 18-5498-1 ⑨ 18-5313 ⑩	—
200	1967-68	8	1111050, 058 053, 382127 ④	18-5310	18-5344	18-5384	—	18-5252 18-5270 ②	18-5494-1 ⑧ 18-5498-1 ⑨ 18-5313 ⑩	—
200	1979-88	8	981659 ①	18-5314	18-5338	18-5376	18-5404-1	18-5251 18-5271 ②	18-5494-1 ⑧ 18-5498-1 ⑨ 18-5313 ⑩	18-5296-2
200	1979-82	8	982320 ②⑤	18-5303	18-5347 ③	18-5369	18-5407	18-5258 18-5277 ②	18-5494-1 ⑧ 18-5498-1 ⑨ 18-5313 ⑩	18-5298
210	1968-72	8	381775 ①	18-5314	18-5338	18-5375	18-5411	18-5256 18-5272 ②	18-5494-1 ⑧ 18-5498-1 ⑨	—
215	1971	8	— ①	18-5314	18-5338	18-5375	18-5411	18-5256 18-5272 ②	18-5494 ⑧ 18-5498 ⑨ 18-5313 ⑩	—
								18-5251	18-5494-1 ⑧	

N/A Not applicable

① Mallory
 ② Prestolite
 ③ For wire lead type, use 18-5345
 ④ Delco

⑤ Models w/distributor cap hold down spring clip
 ⑥ Models w/distributor cap hold down screw
 ⑦ '90 Models point ignition only
 ⑧ Electronic distributor (standard rotation)

⑨ Electronic distributor (counter rotation)
 ⑩ Contact controlled distributor

① Does not include models with shift assist module
 ② With distributor cap

Model	Year	Cyl.	Distributor	Contact Set	Condenser	Dist. Cap	Rotor	Tune-Up Kit	Distributor	Electronic Conv. Kit
225	1978	8	981659, 982320 ①	18-5314	18-5338	18-5376	18-5404-1	18-5271 ②	18-5498-1 ⑧ 18-5313 ⑩	18-5296-2
225	1972-76	8	381775 ①	18-5314	18-5338	18-5375	18-5411	18-5256 18-5272 ②	18-5494-1 ⑧ 18-5498-1 ⑨ 18-5313 ⑩	18-5296-2
230	1979-88	8	981659 ①	18-5314	18-5338	18-5376	18-5404-1	18-5251 18-5271 ②	18-5494-1 ⑧ 18-5498-1 ⑨ 18-5313 ⑩	18-5296-2
230	1979-82	8	982320 ② ⑤	18-5303	18-5347 ③	18-5369	18-5407	18-5258 18-5277 ②	18-5494-1 ⑧ 18-5498-1 ⑨ 18-5313 ⑩	18-5298
230 I.B.	1975-76	8	381775 ①	18-5314	18-5338	18-5375	18-5411	18-5256 18-5272 ②	18-5494-1 ⑧ 18-5498-1 ⑨ 18-5313 ⑩	—
235	1971	8	— ①	18-5314	18-5338	18-5375	18-5411	18-5256 18-5272 ②	18-5494-1 ⑧ 18-5498-1 ⑨ 18-5313 ⑩	—
235	1975-77	8	981080 ② ⑤	18-5303	18-5347 ③	18-5369	18-5407	18-5258 18-5277 ②	18-5494-1 ⑧ 18-5498-1 ⑨ 18-5313 ⑩	18-5296-2
240	1978	8	981080 ② ⑤	18-5303	18-5347 ③	18-5369	18-5407	18-5258 18-5277 ②	18-5494-1 ⑧ 18-5498-1 ⑨ 18-5313 ⑩	18-5296-2
245	1972-75	8	381775 ①	18-5314	18-5338	18-5375	18-5411	18-5256 18-5272 ②	18-5494-1 ⑧ 18-5498-1 ⑨ 18-5313 ⑩	—
250 I.B.	1970-74	8	— ①	18-5314	18-5338	18-5375	18-5411	18-5256 18-5272 ②	18-5494-1 ⑧ 18-5498-1 ⑨ 18-5313 ⑩	—
250	1979	8	981080 ② ⑤	18-5303	18-5347 ③	18-5369	18-5407	18-5258 18-5277 ②	18-5494-1 ⑧ 18-5498-1 ⑨ 18-5313 ⑩	18-5298
260 I.B.	1975-76	8	384193 ①	18-5314	18-5338	18-5375	18-5411	18-5256 18-5272 ②	18-5494-1 ⑧ 18-5498-1 ⑨ 18-5313 ⑩	—
260	1979-82	8	981659 ①	18-5314	18-5338	18-5376	18-5404-1	18-5251 18-5271 ②	18-5494-1 ⑧ 18-5498-1 ⑨ 18-5313 ⑩	18-5296-2
260	1979-82	8	982320 ② ⑤	18-5303	18-5347 ③	18-5369	18-5407	18-5258 18-5277 ②	18-5494-1 ⑧ 18-5498-1 ⑨ 18-5313 ⑩	18-5298
262 CID	1989	6	— ② ⑥	18-5303	18-5347 ③	18-5353	18-5403	18-5262 18-5276 ②	—	—
290 Jet	1974-75	8	— ①	18-5314	18-5338	18-5375	18-5411	18-5256 18-5272 ②	18-5494-1 ⑧ 18-5498-1 ⑨ 18-5313 ⑩	—
305 I.B.	1977-79	8	980680 ①	18-5314	18-5338	18-5375	18-5411	18-5256 18-5272 ②	18-5494-1 ⑧ 18-5498-1 ⑨ 18-5313 ⑩	—
305 I.B.	1980-82	8	981659, 982320 ①	18-5314	18-5338	18-5376	18-5404-1	18-5251 18-5271 ②	18-5494-1 ⑧ 18-5498-1 ⑨ 18-5313 ⑩	18-5296-2
350 I.B.	1977-79	8	981659 ①	18-5314	18-5338	18-5375	18-5411	18-5256 18-5272 ②	18-5494-1 ⑧ 18-5498-1 ⑨ 18-5313 ⑩	—
350 I.B.	1980-82	8	982320 ①	18-5314	18-5338	18-5376	18-5404-1	18-5251 18-5271 ②	18-5494-1 ⑧ 18-5498-1 ⑨ 18-5313 ⑩	18-5296-2
350 CID	1988-89	8	— ⑥	18-5314	18-5338	18-5376	18-5404-1	18-5251 18-5271 ②	—	—
350 CID	1988-89	8	— ② ⑤	18-5303	18-5347 ③	18-5352	18-5403	18-5275 ②	18-5313 ⑩ — 18-5313 ⑩	—
454 I.B.	1977-79	8	— ①	18-5314	18-5338	18-5375	18-5411	18-5256 18-5272 ②	18-5494-1 ⑧ 18-5498-1 ⑨ 18-5313 ⑩	—
454 I.B.	1980-82	8	981659, 982320 ①	18-5314	18-5338	18-5376	18-5404-1	18-5251 18-5271 ②	18-5494-1 ⑧ 18-5498-1 ⑨ 18-5313 ⑩	18-5296-2
460 CID	1988-89	8	— ② ⑥	18-5303	18-5347 ③	18-5352	18-5403	18-5262 18-5275 ②	—	—

N/A Not applicable

- ① Mallory
- ② Prestolite
- ③ For wire lead type, use 18-5345
- ④ Delco

- ⑤ Models w/distributor cap hold down spring clip
- ⑥ Models w/distributor cap hold down screw
- ⑦ '90 Models point ignition only
- ⑧ Electronic distributor (standard rotation)

- ⑨ Electronic distributor (counter rotation)
- ⑩ Contact controlled distributor
- Ⓜ Does not include models with shift assist module
- Ⓝ With distributor cap



MP28890
IGNITION LANAYARD
Replaces: 176288
Fits: 1996 - Up



MP28880*
LANAYARD
Replaces: 432230
Fits: 1995-Older



18-5225
SPARK PLUG WIRE KIT
Replaces: Mercury 84-99215A26, 84-813706A26
Kit Includes 25 ft. Roll of 7 MM Hypalon Ignition Wire
With a Metallic Core and a Large Assortment of Three
Different End Fittings.



18-5226
IGNITION WIRE
 Metallic Core
 100' Spool
 7mm Hypalon

PKG. OF 10



18-5224
18-5224-90
SPARK PLUG WIRE TERMINAL
 Replaces: Mercury 20121
 OMC 510364

PKG. OF 10



18-5750
18-5750-90
UNIVERSAL SPARK PLUG BOOT
 Supplied complete w/Terminal Connector
 Replaces: OMC 581027, 580339



18-5752
UNIVERSAL SPARK PLUG BOOT
 8mm

PREMIUM MARINE SPARK PLUG WIRE LEADS

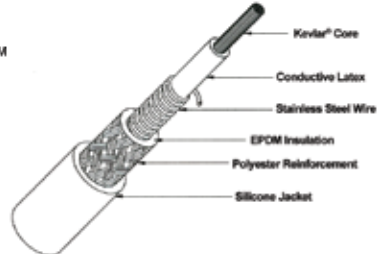

OE style boots provide a sealed barrier against heat, dirt and moisture.

Premium Marine Wire Leads
 Magnetic Suppression Core
 Manufactured for your specific application

- ★ Kevlar® core for maximum durability and long life.
- ★ Durable stainless steel wound conductor for maximum horsepower and engine performance.
- ★ Premium silicone jacketing and boots for the ultimate in high temperature protection.
- ★ Superior RFI suppression for the most sensitive electronic system.
- ★ Corrosion resistant stainless steel spark plug and distributor terminals for maximum conductivity.

Model	Ignition Type	Cyl.	O.E.M. #	Part #
2.3L	Conventional	4	503747	18-8807-1
100/ 110/ 120/ 2.5L/ 140/ 3.0L/ 140 Jet	Conventional	4	503748	18-8800-1
3.0L/ HO	EST Electronic	4	503749	18-8814-1
3.0L/ HO	EST Electronic	4	503749	18-8811-1
3.0L/ HO	EST Electronic	4	503749	18-8841-1
4.3L	EST Electronic	6	503751	18-8810-1
3.8L/ 4.3L	Conventional	6	503750	18-8801-1
370 (King Cobra)/ 454/ 7.4L/ 502/ 8.2L	Conventional	8	503752, 503755	18-8803-2
175/ 185/ 190/ 200/ 5.0L - 5.7L (GM)	Conventional	8	503752, 503755 ①	18-8803-2, 18-8823-1 ①
225/ 230/ 235/ 240/ 250/ 260	Conventional	8	503752, 503755 ①	18-8803-2, 18-8823-1 ①
5.0L - 5.8L EFI (Ford)	EST Electronic	8	503754	18-8820-1
5.0L - 5.8L (Ford)	Conventional	8	503753	18-8842-1
460 (King Cobra)	Conventional	8	N/A	18-8825-1
8.1L / 496	Distributorless	8		18-8838-1
7.4L / 8.2L V8	DDS	8	503756	18-8843-1

① Models with Mallory side terminal caps

Engine	Cyl.	Year	Kit	Engine	Cyl.	Year	Kit
2.3L	4	1987-90	18-8807-1	185	8	1978-80	18-8802-1
2.5L	4	1982-86	18-8800-1	190	8	1975-77	18-8805-1
3.0L ⑧	4	1982-90	18-8800-1	200	8	1979-81	18-8802-1
3.0L/3.0L H.O.	4	1991-92	18-8814-1	225	8	1978	18-8802-1
3.0L/3.0L H.O. ⑩	4	1990-94	18-8841-1	225	8	1976	18-8802-1
2.5/3.0L 110-140hp ⑩	4	1964-90	18-8811-1	230	8	1979-81	18-8802-1
3.8L	V6	1981-86	18-8801-1	230 IB LH	8	1976	18-8802-1
4.3L ⑨	V6	1985-90	18-8801-1	230 IB LH	8	1976	18-8802-1
4.3L ⑩	V6	1994	18-8810-1	235	8	1975-77	18-8805-1
5.0L	8	1982-88	18-8802-1	240	8	1978	18-8805-1
5.0L	8	1989-90	18-8806-1	250	8	1979	18-8805-1
5.7L	8	1982-89	18-8802-1	260	8	1979-81	18-8802-1
5.7L King Cobra	8	1988	18-8802-1	260 IB LH	8	1976	18-8802-1
5.8L	8	1989-90	18-8842-1	260 IB LH	8	1976	18-8802-1
7.4L ②	8	1991	18-8843-1	262 King Cobra	V6	1989	18-8801-1
7.4L/8.2L	8	1992-94	18-8843-1	305 CID IB LH ⑥	8	1979-82	18-8802-1
7.5L	8	1987	18-8803-2	305 CID IB RH ⑤	8	1977-82	18-8802-1
7.5L King Cobra	8	1987	18-8803-2	305 CID IB RH ⑦	8	1979-82	18-8802-1
80	4	1968-69	18-8800-1	305 CID IB LH ⑤	8	1977-82	18-8802-1
100	4	1972-73	18-8800-1	350 CID IB RH ⑤	8	1977-82	18-8802-1
110	4	1964	18-8800-1	350 CID IB RH ⑦	8	1979-82	18-8802-1
120 ①	4	1965-74	18-8800-1	350 King Cobra	8	1989	18-8802-1
120 ②	4	1974-81	18-8800-1	370 King Cobra	8	1988	18-8803-2
140 ①	4	1973-74	18-8800-1	454 CID IB	8	1979-82	18-8802-1
140 ②	4	1974-81	18-8800-1	460 King Cobra	8	1988-89	18-8803-2
140 Jet	4	1973	18-8800-1	8.1L / 496 ①	8	2000 & up	18-8838-1
175	8	1975-77	18-8805-1				

③ Priced per Package



Display Package

SPARK PLUG WIRE SETS
 8mm

- ① 1974:FF and R only
- ② 1974:Model R1 only
- ③ 1975:Model A1 only
- ④ Model M only
- ⑤ Models w/o closed cooling
- ⑥ V-Drive model w/ closed cooling
- ⑦ Direct Drive Model w/ closed cooling
- ⑧ 1990 Models 302BMRPWS and 302BPRPWS
- ⑨ 1990 (2 BBL) carb
- ⑩ Delco Digital & EST Ignition
- ① Distributorless Ignition
- ② F suffix models only



18-5923
STARTER, PMGR, FORD
 PMGR Replacement for 18-5903;
 302CID, 351CID Ford Engines



18-5927
STARTER, PMGR, FORD
 PMGR Replacement for 18-5917, 2.3L
 Ford Starter.



18-6834
STARTER
 Replaces: GM Engines Universal
 Used on Buick, Chevrolet, Oldsmobile, and Pontiac Race
 Engines



18-6835
STARTER
 Replaces: GM Engines Universal
 Used on Buick, Chevrolet, Oldsmobile, and Pontiac Race
 Engines



18-6270
PERMANENT MAGNET I/O STARTER
 Replaces: 988013,
 984536
 • Permanent Magnet
 • Heavy Duty
 • 12 Volt
 • 2 Bolt Mount
 • 1 Threaded Hole
 • CW Rotation
 • SAE J1171
 For: 460 Ford, OMC King Cobra



18-5919
STARTER
 Permanent magnet I/O starter
 For: Late model GM - 12 3/4" flywheel
 Replaces: 988217
 Replacement Solenoid: 18-6287
 SAEJ1171
 1.7 KW



18-5920
STARTER
 Permanent Magnet
 For: 5.0 & 5.8 litre Ford engines.
 Replaces: 987811, 3854190
 Replacement Solenoid: 18-6291

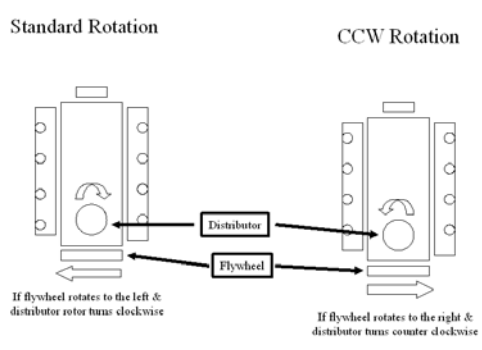

18-6276
STARTER
 Replaces: 984536, 988013
 • 12 Volt
 • CW Rotation
 • Threaded Top Hole in Housing
 • 460 Ford, OMC King Cobra



18-5911
STARTER

(Heavy-Duty) (No Core)
 For GM engines, bottom mount straight across bolt pattern.
 Standard rotation clockwise. 100-245 HP — 1970-1978 (GM)
 Replaces: 981078, 982121, 983444, 983790, 985966
 Replacement Solenoid: 18-5837
 SAEJ1171



18-5900
REMANUFACTURED
STARTER



18-5907
STARTER

(Heavy-Duty) (No Core)
 Top mount rear entry starter for opposite rotation
 GM and Ford engines clockwise.
 Replaces: 981289, 982202
 Replacement Solenoid: 18-5837
 SAEJ1171



18-5901
REMANUFACTURED
STARTER





**18-5908
STARTER**

(Heavy-Duty) (No Core)
Top mount rear entry starter for standard rotation GM and Ford engines. Counter-clockwise.
 Replaces: 981288, 982195, 984982, 986007
 Replacement Solenoid: 18-5837
SAEJ1171



**18-5902
REMANUFACTURED
STARTER**



**18-5910
STARTER**

(Heavy-Duty) (No Core)
Small block GM V-6 & V-8 Engine with 14 1/4" flywheel and bottom mount, offset bolt pattern. For standard rotation engines. Clockwise. 1986-1992 - V-6, V-8 (GM) and 1990-1993 OMC King Cobra
 Replaces: 984456, 986505
 Replacement Solenoid: 18-5837
SAEJ1171



**18-5905
REMANUFACTURED
STARTER**



**18-5917
STARTER**
 Replaces: 984628
3 bolt mount - Late style 4" diameter case. Standard rotation engines For: Late model Ford V-8. Replacement Solenoid: 18-5801



**18-5903
STARTER**
(No Core) (Clockwise)
Bottom mount, two bolt pattern for standard rotation. Ford engines. Clockwise
 Replaces: 980803, 981821
 Replacement Solenoid: 18-5801



**18-5913
STARTER**
(Clockwise)
Delco permanent magnet gear reduction 2 bolt starter 12V - 11 Tooth - Offset bolt pattern. Fits: Chevy Engines with 14" flywheels. 1.7 KW
 Replaces: 3854751 SAEJ1171
 Replacement Solenoid: 18-6287



OMC STERNDRIVE/OMC COBRA STARTERS

Engine	Year	Starter #	Engine	Year	Starter #	Engine	Year	Starter #
3.0L	1982-92	18-5900	170	1974	18-5903	245	1972-75	18-5900
5.0L	1982-86	18-5900 ④	175	1975-77	18-5903	245 JET	1972-74	18-5900
5.0L	1986-88	18-5905 ⑤	185	1967-68,	18-5900	250	1979	18-5903
2.5L	1982-86	18-5900		1978-80		260	1975-76	18-5902 ①
3.8L	1981-86	18-5900	190	1974-77	18-5903	260	1975-76	18-5901 ②
4.3L	1985-86	18-5900	200	1966-68,	18-5900	260	1979-81	18-5900
4.3L	1986-92	18-5905		1979-81		262 CID	1989	18-5905
5.7L	1982-86	18-5900	210	1968-72	18-5900 ①	290	1975	18-5902 ③
5.7L	1986-92	18-5905	215	1971	18-5900	305 CID	1977-80,82	18-5902 ①
100	1972-73	18-5900	225	1972-76,	18-5900 ①	305 CID	1977-80,82	18-5901 ②
110	1964	18-5900		1978		350 CID	1977-80,82	18-5902 ①
120	1965-81	18-5900	230	1975-76	18-5902 ①	350 CID	1977-80,82	18-5901 ②
140	1973-81	18-5900	230	1975-76	18-5901 ②	350 CID	1988-91	18-5905
140 JET	1973	18-5900	230	1979-81	18-5900	370 CID	1988	18-5902
150	1964-66	18-5900	235	1971	18-5900	454 CID	1977-80,82	18-5902 ①
155	1967-72	18-5900	235	1975-77	18-5903	454 CID	1977-80,82	18-5901 ②
165	1972-76	18-5900	240	1978	18-5903	454 CID	1990-92	18-5905
						502 CID	1992	18-5905

① Standard rotation engines.

② Opposite (Reverse) rotation engines.

③ Engines with model number suffix "R2" or "R3"

④ '86 Model engines with model number suffix "WB"

⑤ '86 Model engines with model number suffix "XS"



**18-5717
STARTER BRUSH SET**
Replaces:
Delco 1984462





**18-5811
STARTER SOLENOID**
Replaces: 3850216
For: PG 260 series starters, GM V6 & V8 (1983-Up)

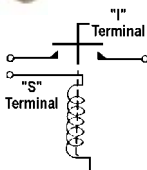

**18-5801
SOLENOID**
Replaces: 985064
Grounded Base

① 18-5801D Display Package

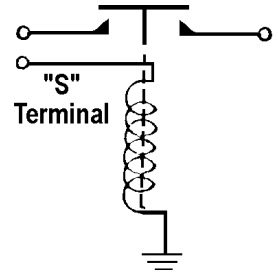
**18-5803
SOLENOID**
Replaces: 979774

**18-5807
SOLENOID**
Replaces: 378444
Prestolite SAW4206

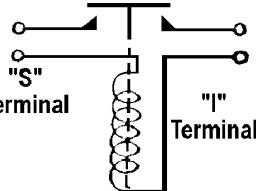

**18-6291
SOLENOID**
Replaces: 3854194 and Volvo Penta 3854194-2
Fits: Ford Gear Reduction Starters on Late Model 5.0L, 5.8L, OMC and Volvo Penta

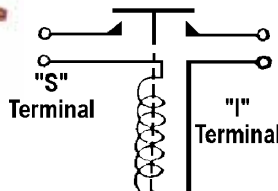

**18-5814
SOLENOID**
Replaces: 172869, 581528
12 Volt, Isolated Base

**18-5808
SOLENOID**
Replaces: 395419, 582708

③ 18-5808D Display Package

**18-5812
SOLENOID**
Replaces: 985063

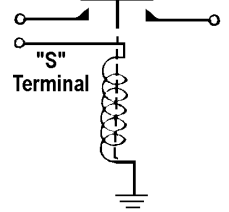
③ 18-5812D Display Package



**18-5837
SOLENOID**
Replaces: 985799, 986620
Delco 1114531



**18-5838
SOLENOID**
Replaces:
Delco 1114356, 1114458

BATTERY CABLES
Gauge cable with soldered lug terminals on each end to accept a 3/8" stud

Part No.	Size	Color	Gauge	Part No.	Size	Color	Gauge
BC88523	2'	red	4	BC88563	6'	red	2
BC88533	2'	black	4	BC88573	6'	black	2
BC88543	4'	red	2	BC88583	8'	red	1
BC88553	4'	black	2	BC88593	8'	black	1

① Items ending in "D" are Display Packaged - Regular number is Non-Display

STRINGER SOLENOID APPLICATION

HP	Year	Starter Brush	Starter Mounted Solenoid	Starter Solenoid	Tilt Solenoid	Trim Solenoid
80	1969	—	N/A	18-5808	N/A	18-5808
88	1964	—	N/A	18-5807	N/A	18-5807
90	1965-71	—	N/A	18-5808	N/A	18-5808
100	1972-73	18-5717	18-5838	18-5803	N/A	18-5803
110	1964	18-5717	18-5838	18-5807	N/A	18-5807
120	1965-71	18-5717	18-5838	18-5808	N/A	18-5808
120	1972-77	18-5717	18-5838	18-5803	18-5803	18-5803
120	1978-81	18-5717	18-5838	—	—	—
140	1973-77	18-5717	18-5838	18-5803	18-5803	18-5803
140	1978-81	18-5717	18-5838	—	—	—
145	① 1973	—	18-5838	18-5803	N/A	N/A
150	1964	18-5717	18-5838	18-5807	N/A	18-5807
150	1965-66	18-5717	18-5838	18-5808	N/A	18-5808
155	1967-72	18-5717	18-5838	18-5808	N/A	18-5808
165	1972-76	18-5717	18-5838	18-5803	18-5803	18-5803
170	1974	—	N/A	18-5801	N/A	18-5803
175	1975-78	—	N/A	18-5801	N/A	18-5803
185	1967-68	18-5717	18-5838	18-5808	N/A	18-5808
185	1978-80	18-5717	18-5838	—	—	—
190	1974-78	—	N/A	18-5801	N/A	18-5803
200	1966-78	18-5717	18-5838	18-5808	N/A	18-5808
200	1979-81	—	18-5838	—	—	—
210	1968-70	18-5717	18-5838	18-5808	N/A	18-5808
210	② 1970-72	18-5717	18-5838	18-5808	N/A	N/A
215	1971	18-5717	18-5838	18-5808	N/A	18-5808
225	1972	18-5717	18-5838	18-5808	N/A	18-5808
225	1973	18-5717	18-5838	18-5803	N/A	18-5808
225	1974-76	18-5717	18-5838	18-5803	N/A	18-5803
225	1978	18-5717	18-5838	—	—	—
225	② 1973-74	18-5717	18-5838	18-5808	N/A	N/A
230	② 1975-76	18-5717	18-5838	18-5803	N/A	N/A
230	1979-81	18-5717	18-5838	—	—	—
235	1971	18-5717	18-5838	18-5808	N/A	18-5808
235	1975-78	—	N/A	18-5801	N/A	18-5803
245	1972	18-5717	18-5838	18-5808	N/A	18-5808
245	1973	18-5717	18-5838	18-5803	N/A	18-5808
245	1974-75	18-5717	18-5838	18-5803	N/A	18-5803
245	① 1972-75	18-5717	18-5838	18-5808	N/A	N/A
250	② 1970-74	—	18-5838	18-5808	N/A	N/A
260	② 1975-76	18-5717	18-5838	18-5803	N/A	N/A
260	1979-81	18-5717	18-5838	—	—	—
290	① 1974-75	18-5717	18-5838	18-5808	N/A	N/A
305	② 1977-82	18-5717	18-5838	—	N/A	N/A
350	② 1977-82	18-5717	18-5838	—	N/A	N/A
454	② 1977-82	18-5717	18-5838	—	N/A	N/A
2.5	1982	18-5717	18-5838	—	—	—
2.5	1983-86	18-5717	18-5837	—	—	—
3	1982	18-5717	18-5838	—	—	—
3	1983-86	18-5717	18-5837	—	—	—
3.8	1981-82	18-5717	18-5838	—	N/A	—
3.8	1983-86	18-5717	18-5837	—	N/A	—
4.3	1985-86	18-5717	18-5837	—	N/A	—
5	1982	18-5717	18-5838	—	—	—
5	1983-86	18-5717	18-5837	—	—	—
5.7	1982	18-5717	18-5838	—	—	—
5.7	1983-86	18-5717	18-5837	—	—	—

① Jet Drive ② Inboard

OMC COBRA SOLENOID APPLICATION

HP	Year	Starter Brush	Starter Mounted Solenoid	Starter Solenoid	Trim Solenoid
262	1989	N/A	18-5837	18-5812	N/A
350	1988	N/A	18-5837	18-5812	18-5812
350	1989	N/A	18-5837	18-5812	N/A
350	1990-91	N/A	18-5837	18-5801	N/A
351	1992	—	—	18-5801	N/A
370	1988	N/A	—	18-5812	18-5812
370	1989	N/A	—	18-5812	N/A
454	1990	—	—	18-5801	N/A
454	1991-92	N/A	18-5837	18-5801	N/A
460	1989-90	N/A	—	18-5801	N/A
502	1992	N/A	18-5837	18-5801	N/A
2.3	1987-88	N/A	—	18-5801	18-5812
2.3	1989-90	N/A	—	18-5801	N/A
2.5	1986	18-5717	18-5837	18-5812	18-5812
3	1986-88	18-5717	18-5837	18-5812	18-5812
3	1989-90	18-5717	18-5837	18-5812	N/A
3	1991-92	18-5717	18-5837	18-5801	N/A
4.3	1986-88	18-5717	18-5837	18-5812	18-5812
4.3	③ 1989-90	18-5717	18-5837	18-5812	N/A
4.3	④ 1990-92	18-5717	18-5837	18-5801	N/A
5	1986-88	18-5717	18-5837	18-5812	18-5812
5	1989-92	18-5717	—	18-5801	N/A
5.7	1986-88	18-5717	18-5837	18-5812	18-5812
5.7	1989	18-5717	18-5837	18-5812	N/A
5.7	1990-92	18-5717	18-5837	18-5801	N/A
5.8	1989-92	N/A	—	18-5801	N/A
7.5	1987	18-5717	—	18-5801	18-5812

③ 1990 Models with 2 barrel carbs ④ 1990 Models with 4 barrel carbs.

18-5711
VOLTAGE REGULATOR
 Replaces: 383440
 Prestolite: VSH-6201 AFY
 12 Volt



Years	Model	Alternator or Generator
1964-66	110, 150 HP	ALK-6222, A, AYS
1967-81	80, 90, 120, 140, 155, 165, 175 185, 190, 200, 210, 225, 230, 235, 250, 260 HP & 305, 350, 454 CID	ALK-6222, A, AY, Y, AYS ANK-65201S, Y ALK-6210, A

18-6261
ALTERNATOR
 Replaces: 987774, 3857561,
 3854182, 3854809, 3856600, 3860171
 Fits: 3.0L, 4.3L, 5.7L, 7.4L (1995-98), 5.0L, 5.8L, 8.2L
 (1993-98)
 For: Delco



18-6260
ALTERNATOR
 OMC Cobra 12 Volt, 51 Amp, Internal
 Regulator, Negative Ground, Single
 Groove Pulley For : Prestolite/Motorola



18-6841
ALTERNATOR
 Replaces: 983836, 988247
 For: 37-63A Marine Applications



18-6842
ALTERNATOR
 Replaces: 983424, 836, 247
 For: 37-63A Marine Applications



18-5957
ALTERNATOR



18-5951
ALTERNATOR
 Remanufactured



Replaces: 982364, 983424, 983836, 985466, 986008
 (3-Wire) (No Core) (68 AMP)

Replaces Mando, Motorola and original equipment Delco. Uses same electrical
 connections and mounting method. Equipped with fan and drive pulley. SAEJ1171



18-2192
ELECTRIC SHIFT CABLE
 Replaces: 379628

ELECTRIC SHIFT CABLE APPLICATION

Year	HP
1964	110 ②, 150
1965	120 ①, 150
1966	120 ①, 150, 200
1967	120 ①, 155, 185, 200
1968	120, 155, 185, 200, 210
1969-70	120, 155, 210
1971	120, 155, 215, 235
1972-73	100, 120, 155, 165, 225, 245
1974	120, 140, 165, 170, 190, 225, 245
1975	120, 140, 165, 175, 190, 225, 235, 245
1976	120, 140, 165, 175, 190, 225, 235
1977	120, 140, 175, 190, 235

① Heavy Duty ② SU12M, SUE 12M

③ **18-5705D**

18-5705
POWER
TRIM RELAY

Replaces: 582472,
 584416, 586224
 5 Terminal



Single Pull - Double Throw - 12 Volt
 Open Contact: 40 Amps Resistive
 30 Amps Conductive
 Closed Contact: 20 Amps Resistive
 15 Amps Conductive



18-6257
TILT/TRIM MOTOR
 Replaces: 983195, 982957
 1982-85 Models with hydraulic engine lifts for
 pump assembly



18-6754
TILT MOTOR
 Replaces: 382138
 Prestolite ETK 4102, ETK 4001, ETK 4101
 (All Models 1963-77)



18-6755
TILT MOTOR
 Replaces: 982706, 982058
 Prestolite EVD 4001, EVD 4002
 (All Models Except 2.5L, 3.0L - 1978-85)



**18-6764
TILT/TRIM MOTOR**
Replaces: 982073, 983318, 982069
For: OMC Stringer and Cobra "Select Trim" 3-Wire Connection 1979-85 Stern Drive (2.5L & 3.0L)

PKG. OF 5



**18-6779
TRIM MOTOR**
Replaces: 986280, 3853945
For: 1990 & 1994 King Cobra Trim System

NEW



**18-6814
TRIM MOTOR**
Replaces: 984356
OMC Cobra

NEW



**18-6816
TRIM MOTOR**
Replaces: 172588, 173944
Fits: 40, 50, 70, and 75HP with short shaft

NEW



**18-6823
WIRING HARNESS**
Replaces: Universal
Converts 3-wire Tilt and Trim motors to 2-Wire design



**18-6950
18-6950-9[Ⓢ]
POWER TILT FUSE
(50 amp)**
Replaces: 982019



**18-9802
TIMING LIGHT**
Self-powered accurate up to 10,000 RPM's



**18-7601
AIR CHARGE TEMPERATURE SENSOR**
Replaces: 3854158
8 cyl
5.0L, 5.8 L, EFI (1994-96)



**18-7684
MAP SENSOR**
Replace: 3850396
For: 4.3L TBI(1996-98), 5.0L TBI(1998), 5.7L TBI(1996-98), 7.4L(1995-98), 8.2L(1998)



**18-7677
KNOCK SENSOR**
Replace: 3850357



**18-7679
KNOCK SENSOR**
Replace: 3854905



**18-7703
KNOCK SENSOR**
Replace: 3854512



**18-7689
FUEL INJECTOR**
Replace: 3855182



**18-7650
FUEL PRESSURE REGULATOR**
Replaces: 987995
8 cyl
5.0L, 5.8 L, EFI (1993)



**18-7627
INTAKE MANIFOLD**
Small-block GM with vortec cylinder heads



**18-7628
INTAKE MANIFOLD**
Small-block GM with vortec cylinder heads with brass lined water jackets

Ⓢ Priced per Package

ALL SIERRA CARBURETORS INCLUDE BASE GASKET

- Precision remanufactured to meet or exceed OEM specifications
- Re-calibrated and re-engineered to maximize fuel efficiency and performance
- All carburetors are flow tested throughout the entire throttle range
- Fuel mixture and idle settings are pre-set to ensure that only minor idle and choke adjustments are necessary during installation
- All bases are resurfaced and throttle shaft bushings replaced



**18-7635
CARBURETOR
(REMANUFACTURED)**
300 CFM Holley 2V



**18-7636
CARBURETOR
(REMANUFACTURED)**
500 CFM Holley 2V



**18-7637
CARBURETOR
(REMANUFACTURED)**
600 CFM Holley 4V



**18-7638
CARBURETOR
(REMANUFACTURED)**
600 CFM Holley 4V-side inlet



**18-7640
CARBURETOR
(REMANUFACTURED)**
Universal Q-jet with electric choke



**18-7605-1
CARBURETOR**
4 Barrel Rochester
Replaces: 382821, 383766, 384194
Remanufactured



**18-7608-1
CARBURETOR**
2 Barrel Rochester
Replaces: 381668, 980528, 982219, 982217
Remanufactured



**18-7609-1
CARBURETOR**
2 Barrel Rochester
Replaces: 382733, 980530,
982217, 984180, 381494, 772831
Remanufactured



**18-7615-1
CARBURETOR**
4 Barrel Rochester
Replaces: 981705, 982223,
983855, 981359, 981564,
985822, 981803, 981428
Remanufactured



**18-7615N
Q-JET CARBURETOR**
Replaces: 1347-816373A4,
1347-804624R1,
1347-804624R02

OMC STERN DRIVE CARBURETOR APPLICATION

Model	Year	OMC Carburetor #	MFG Carburetor #	Carb Code & Model	Part #
80	1968-69	382733, 772831	7028085, 17059053, 17086064, 17087311	R2, 2GC	18-7609-1
90	1970-71	382733, 772831	7028085, 17059053, 17086064, 17087311	R2, 2GC	18-7609-1
120 (400 Series)	1972-86	381668, 980528, 982219	7044186, 17059056	R2, 2GC	18-7608-1
140 (400 Series)	1973-85	979821, 980530, 982217, 984180	17086107	R2, 2GC	18-7608-1
155	1967-72	772831	7026180	R2, 2GC	18-7609-1
165	1972-76	979821, 980530	17086107	R2, 2GC	18-7609-1
185	1989	984180	17086064	R2, 2GC	18-7609-1
200	1966-68	381494	7025187	R2, 2GC	18-7609-1
210	1968-72	382821, 383766	7028282, 7028280	R4, 4MV	18-7605-1
215, 225, 230	1971-76	382821	7028280	R4, 4MV	18-7605-1
230 (800 Series)	1979-89	981705, 982223	17057290, 17059285, 17059286, 17086117	R4, 4MV	18-7615-1
245	1972-75	384194	7040284	R4, 4MV	18-7605-1
250	1970-74	384194	7040284	R4, 4MV	18-7605-1
260 (800 Series)	1975-76	384194	7040284	R4, 4MV	18-7605-1
260 (800 Series)	1979-89	982223	17057290, 17059285, 17059286, 17086117	R4, 4MV	18-7615-1
2.5L, 3.0L	1982-86	982219, 982217	17059056, 17059053	R2, 2GC	18-7608-1
3.0L	1987-90	984180	17086064	R2, 2GC	18-7608-1
3.8L (4V)	1979-85	983855	17082515, 17085010	R4, 4MV	18-7615-1
4.3L (4V)	1979-89	983855	17082515, 17085010	R4, 4MV	18-7615-1
5.0L (GM)(4V)	1979-89	982223	17057290, 17059285, 17059286, 17086117	R4, 4MV	18-7615-1
5.7L (4V)	1979-89	982223	17057290, 17059285, 17059286, 17086117	R4, 4MV	18-7615-1
305, 350 CI, I/B	1977-83	981359, 982215, 981564, 982223	17057290, 17059285, 17059286, 17086117	R4, 4MV	18-7615-1
350 (4V)	1988-89	985822	17057290, 17059285, 17059286, 17086117	R4, 4MV	18-7615-1
454 CI, I/B	1977-78	981803, 981428	17057290, 17059285, 17059286, 17086117	R4, 4MV	18-7615-1



**18-7017
CARB KIT**
Replaces: 985052
235 (5.8L Ford) 1989 7.5L/460 C.I. 1987-89
(Contains Non-adjustable needles and seats)



**18-7018
CARB KIT**
Replaces: 981790, 982352
350 C.I. Inboard 1977-78



**18-7070
CARB KIT**
Replaces: 383615, 982384



**18-7071
CARB KIT**
Replaces: 380186



**18-7072
CARB KIT**
Replaces: 979659, 384743



**18-7080
CARB KIT**
Replaces: 979719



**18-7081
CARB KIT**
Replaces: 982537, 982538,
(Contains adjustable needles and seats)



**18-7086
CARB KIT**
Replaces: 984487



**18-7095
CARB KIT**
Replaces: 983864, 383918



**18-7096
CARB KIT**
Replaces: 982539, 85R-4541
(Contains adjustable needles and seats)



**18-7235
CARB KIT**
Replaces: 986783



**18-7236
CARB KIT**
Replaces: 986782



**18-7237
CARB KIT**
Replaces: 986784, 986799



**18-7238
CARB KIT**
Replaces: 986796



**18-7239
CARB KIT**
Replaces: 986800



**18-7241
CARB KIT**
Replaces: 986804



**18-7242
CARB KIT**
Replaces: 987313



**18-7243
CARB KIT**
Replaces: 987315



**18-7244
CARB KIT**
Replaces: 987317



**18-7245
CARB KIT**
Replaces: 987319



**18-7246
CARB KIT**
Replaces: 987438, 987440, 987485



**18-7727
CARB KIT**



**18-7729
CARB KIT**



**18-7730
CARB KIT**



**18-7200
FLOAT
(Alcohol Resistant)**
Replaces: 381389
Brass



**18-7201
FLOAT
(Alcohol Resistant)**
Replaces: 383087, 983871
Brass



**18-7206
NITROPHYL FLOAT**
Nitrophyl

CARBURETOR KIT/FLOAT APPLICATION

Model	Years	Mfg. Code	Carb. Model	Carb. Kit	Float
80	1968-69	R2	2GC	18-7070	18-7200
90	1970-71	R2	2GC	18-7070	18-7200
100	1972-73	C1	RBS	18-7080	—
110	1964	R1	BC	18-7071	—
120	1965-71 (Dual Carb)	C1	RBS	18-7080	—
120	1972-85	R2	2GC	18-7070	18-7200
140	1973-85	R2	2GC	18-7070	18-7200
150	1964-65	R1	BC	18-7071	—
150	1965-66	C1	RBC	18-7080	—
155	1967-72	R2	2GC	18-7070	—
165	1972-76	R2	2GC	18-7070	18-7200
170	1974	H2	2300	18-7081	18-7206
175	1975-77	H2	2300	18-7081	18-7206
185	1978-81	R2	2GE	18-7086	18-7200
185	1989	H2	2300	18-7081	18-7206
190	1974-77	H2	2300	18-7081	18-7206
200	1966-68	R2	2GC,V	18-7070	—
200	1979-85	R2	2GE	18-7086	18-7200
200	1989	H2	2300	18-7081	18-7206
210	1968-72	R4	4MV	18-7072	18-7201
215	1971	R4	4MV	18-7072	18-7201
225	1972-76	R4	4MV	18-7072	18-7201
230	1975-76	R4	4MV	18-7072	18-7201
230	1979-89	R4	4MV	18-7095	18-7201
235	1975-77	H4	4160	18-7096	18-7206
235	1989	H4	4160	18-7017	—
240	1978	H4	4160	18-7017	—
245	1972-75	R4	4MV	18-7072	18-7201
250	1970-74	R4	4MV	18-7072	18-7201
250	1979	H4	4160	18-7017	—
260	1975-76	R4	4MV	18-7072	18-7201
260	1979-89	R4	4MV	18-7095	18-7201
290 JET	1974-75	R4	4MV	18-7072	18-7201
2.3L	1987-89	R2	2GE	18-7086	18-7200
2.5L	1982-85	R2	2GC	18-7070	18-7200
2.5L	1986-90	R2	2GE	18-7086	18-7200
2.5L	1986	R2	2GC	18-7070	18-7200
3.0L ⑥	1982-90	R2	2GC	18-7070	18-7200
3.0L/3.0L H.O.	1991-92	H-2	2300	18-7246	N/A
3.8L	1979-85	R2	2GE	18-7086	18-7200
4.3L	1986-89	R2	2GE	18-7086	18-7200
4.3L	1979-89	R4	4MV	18-7095	18-7201
4.3,4.3 H.O. ②	1990-92	H2	2300	18-7238	N/A
4.3,4.3 H.O. ③	1990-92	H4	4160	18-7237	N/A
4.3/262 ②	1989	R2	2GE	18-7086	18-7200
5.0L (GM)	1979-85	R2	2GE	18-7086	18-7200
5.0L (GM)	1979-89	R4	4MV	18-7095	18-7201
5.0L (FORD)	1989	H2	2300	18-7081	18-7206
5.0,5.0 H.O. ③	1989-90	H4	4160	18-7237	N/A
5.0,5.0 H.O. ②	1989-90	H2	2300	18-7236	N/A
5.0,5.0 H.O. ③	1991	H4	4160	18-7245	N/A
5.0,5.0 H.O. ②	1991	H4	4175	18-7244	N/A
5.0,5.0 H.O. ①	1992	H4	4150	18-7242	N/A
5.7L	1979-89	R4	4MV	18-7095	18-7201
5.7	1990-92	H4	4175	18-7239	N/A
5.7 LE ⑨	1991-92	H4	4175	18-7243	N/A
5.7 LE ④	1990	H4	4175	18-7239	N/A
5.8L	1989	H4	4160	18-7017	—
7.5L	1987-88	H4	4160	18-7017	—
305 C.I./B	1977-79	R2	2GE	18-7086	18-7200
305 C.I./B	1977-78	R4	4MV	18-7018	18-7201
305 C.I./B	1979-83	R4	4MV	18-7095	18-7201
350 C.I./B	1977-78	R4	4MV	18-7018	18-7201

② For 2V Carburetors

③ For 4V Carburetors

④ For Engine Model 574APEPWS

⑥ For 1990 PWC Suffix Only

⑨ For Engine Model 574APERGD

① For Engine Model 744DPEAMH, 744DPPAMH

② For Engine Model 744CPEAMH, 824BPEAM

CARBURETOR KIT/FLOAT APPLICATION (Cont.)

Model	Years	Mfg. Code	Carb. Model	Carb. Kit	Float
350 C.I./B	1979-83	R4	4MV	18-7095	18-7201
350 ④ ③	1988-89	R4	4MV	18-7095	18-7201
350 ②	1988	R2	2GE	18-7086	18-7200
351 CID/5.8L H.O.	—	H4	4010, R50483A, R84046A (F1JL-9510-EA)	18-7727	—
351 CID/5.8L	—	H4	4160, R9393A, R9394A, R50399A, R50399-1A	18-7729	—
351 CID/5.8L	—	H4	4160C, R80434A	18-7730	—
454 C.I./B	1977-78	R4	4MV	18-7072	18-7201
454,454 H.O. ①	1991-92	H4	4150	18-7242	N/A
454,454 H.O. ②	1990-92	H4	4150	18-7241	N/A
460 C.I.	1987-88	H4	4160	18-7017	—
460	1989-90	H4	4160	18-7235	N/A

- ② For 2V Carburetors
- ③ For 4V Carburetors
- ④ For Engine Model 574APEPWS
- ⑥ For 1990 PWC Suffix Only
- ⑨ For Engine Model 574APERGD
- ① For Engine Model 744DPEAMH, 744DPPAMH
- ② For Engine Model 744CPEAMH, 824BPEAM

18-8114 FUEL LINE HOSE
For fuel pump to carburetor connection. Replaces copper or steel tubing 3/8" X 31" PTFE composite hose with 5/8"-18 male inverted flare straight one end, 5/8"-18 90° one end. SAE J1527 type A1

18-8115 FUEL LINE HOSE
For fuel pump to carburetor connection. Replaces copper or steel tubing 3/8" X 25" PTFE composite hose with 5/8"-18 male inverted flare straight one end, 5/8"-18 90° one end. SAE J1527 type A1

18-7229 FLAME ARRESTOR
Replaces: 986865, 981566

ALL SIERRA FUEL PUMPS INCLUDE MOUNTING GASKET

18-7256 FUEL PUMP
Flange I.D. # 6790
For: GM (4 & 6 cyl.)153, 230, 250, 292

18-7258 FUEL PUMP
Replaces: 380986
Flange I.D. # 40001, M3643
For: GM (V-6) 225, PB-V215

18-7265 FUEL PUMP
Flange I.D. # 41412, M73018
For: GM (V-8) 305, 350, 400

18-7267 FUEL PUMP
Replaces: 982063
Flange I.D. # 40778, M73016
For Ford (V-8) 302

18-7268 FUEL PUMP
Replaces: 981650
Flange I.D. #41415
For: GM (V-8) 305, 307, 350, 400
Dual diaphragm sight glass required.

APPLICATION BEGINS ON NEXT PAGE

**18-7278
FUEL PUMP**

Replaces: 985602, 985603, 982240
Flange I.D. #M60032
 For: GM (4 & 6 cyl.) 153, 181, 250, 224, 225



**18-7289
FUEL PUMP**

Replaces: 982997
Flange I.D. # 60201
 For: GM (V-6) 262/4.36



**18-7326
ELECTRIC FUEL PUMP**
 Replaces: 3858261, 3857986,
 3850809, 3854620



**18-7330
ELECTRIC FUEL PUMP**
 Replaces: 3857650, 3855958, 3854280,
 987620, 988037



**18-7331
ELECTRIC FUEL PUMP**
 Replaces: 3850810

FUEL PUMP APPLICATION

Model	Years	Pump #	Model	Years	Pump #
2.5	1982-85	18-7278	175	1975-77	—
5	1982-88	18-7268	185	1978-80	18-7268
5.7	1982-92	18-7268	190	1974-77	—
100	1972-73	18-7278	200	1979-81	18-7268
110	1964	18-7278	225	1978	18-7268
120	1965-80	18-7278	230	1979-81	18-7268
140	1973-81	18-7278	235	1975-77	—
140 Jet Drive	1973	18-7278	240	1978	—
150	1964	18-7258	245 Jet Drive	1973	18-7278
150 Model HU-13EM	1965	18-7258	250	1979	—
150 Except HU-13EM	1965	18-7258	260	1979-81	18-7268
165	1972-76	18-7278	305 CID IB	1979-82	18-7268
170	1974	—	350 CID IB	1979-82	18-7268
			350	1988-91	18-7268

ELECTRIC FUEL PUMP APPLICATION

Year	Engine	Application	OE #	#'s Superseded from	Part #
1992-94	262/4.3L	Low Pressure	3858261	3850809,3850810,3857985	18-7326
1997-98	350/5.7L, 454/7.4L, & 502/8.2L	Engines w/MPI - High Pressure	3857650		18-7330
1996	454/7.4L & 502/8.2L	Engines w/MPI - High Pressure	3857650		18-7330
1993-94	4.3L thru 5.8L	Low pressure electric fuel pump	3858261	3850809	18-7326
1992-1994	454/7.4L & 502/8.2L	GM Mark V Eng. - Low Pressure	3858714	3850810, 3857985	18-7331

- UNIVERSAL DESIGN -

FUEL WATER SEPARATOR BRACKETS



Bracket Type	Part #	Bracket Type	Part #
1/4" Stainless Steel	18-7777	1/4" Aluminum	18-7853-1
3/8" Stainless Steel	18-7776	3/8" Aluminum	18-7775

FUEL WATER SEPARATOR KITS



21 MICRON FILTER KITS - FOR CARBURETED ENGINES

Kit Type	Part #	Micron Rating	Contents
1/4" Aluminum (Short Filter)	18-7848-1	21	1 - 18-7844 filter & 1 18-7853-1 bracket 2 - 18-4256 1/4" pipe plugs
1/4" Aluminum Bonus Pack Contains spare filter	18-7848-2	21	2 - 18-7844 filter & 1 18-7853-1 bracket 2 - 18-4256 1/4" pipe plugs
1/4" Aluminum (Tall Filter)	18-7852-1	21	1 - 18-7845 filter & 1 18-7853-1 bracket 2 - 18-4256 1/4" pipe plugs
1/4" Aluminum Bonus Pack Contains spare filter	18-7852-2	21	2 - 18-7845 filter & 1 18-7853-1 bracket 2 - 18-4256 1/4" pipe plugs
3/8" Aluminum (Tall Filter)	18-7775-1	21	1 - 18-7845 filter & 1 18-7775 bracket 2 - 18-4264 3/8" pipe plugs
1/4" Stainless Steel (Tall Filter)	18-7777-1	21	1 - 18-7845 filter & 1 18-7777 bracket 2 - 18-4256 1/4" pipe plugs
3/8" Stainless Steel (Tall Filter)	18-7776-1	21	1 - 18-7845 filter & 1 18-7776 bracket 2 - 18-4264 3/8" pipe plugs



10 MICRON FILTER KITS FOR FUEL INJECTED ENGINES

Kit Type	Part #	Micron Rating	Contents
1/4" Aluminum (Short Filter)	18-7983-1	10	1 - 18-7944 filter & 1 18-7853-1 bracket 2 - 18-4256 1/4" pipe plugs
1/4" Aluminum Bonus Pack Contains spare filter	18-7983-2	10	2 - 18-7944 filter & 1 18-7853-1 bracket 2 - 18-4256 1/4" pipe plugs
1/4" Aluminum (Tall Filter)	18-7982-1	10	1 - 18-7945 filter & 1 18-7853-1 bracket 2 - 18-4256 1/4" pipe plugs
1/4" Aluminum Bonus Pack Contains spare filter	18-7982-2	10	2 - 18-7945 filter & 1 18-7853-1 bracket 2 - 18-4256 1/4" pipe plugs
1/4" Aluminum (High Capacity Filter)	18-7966-1	10	1 - 18-7866 filter & 1 18-7853-1 bracket 2 - 18-4256 1/4" pipe plugs
3/8" Aluminum (Tall Filter)	18-7986-1	10	1 - 18-7945 filter & 1 18-7775 bracket 2 - 18-4264 3/8" pipe plugs
1/4" Stainless Steel (Tall Filter)	18-7984-1	10	1 - 18-7945 filter & 1 18-7777 bracket 2 - 18-4256 1/4" pipe plugs
3/8" Stainless Steel (Tall Filter)	18-7985-1	10	1 - 18-7945 filter & 1 18-7776 bracket 2 - 18-4264 3/8" pipe plugs



10 MICRON FILTER KITS WITH DRAIN BOWLS

Sierra AquaVue™ and metal bowl separator filters allow water to be drained from the filter to extend service life. Use the AquaVue™ bowl for outboard, above deck installations. USCG regulations require the use of the flame resistant metal bowl below deck.

Kit Type	Part #	Micron Rating	Contents
1/4" Aluminum w/ metal drain bowl	18-7951	10	1 - 18-7919 filter & 1 18-7853-1 bracket 1 - 18-7924 metal bowl 2 - 18-4256 1/4" pipe plugs
1/4" Stainless Steel w/ metal drain bowl	18-7938	10	1 - 18-7919 filter & 1 18-7777 bracket 1 - 18-7924 metal bowl 2 - 18-4256 1/4" pipe plugs

COMPACT BRACKET AND SEPARATOR KIT - FOR SMALL OUTBOARDS AND FRESH WATER APPLICATIONS

18-7774
COMPACT ALUMINUM BRACKET



18-7965-1
10 MICRON COMPACT SEPARATOR KIT
Contains:
1 - 18-7774 bracket
1 - 18-7865 filter



REPLACEMENT FILTERS



UNIVERSAL DESIGN

10 MICRON REPLACEMENT FILTERS			21 MICRON REPLACEMENT FILTERS		
Part #	Description		Part #	Description	
18-7944	Short - 3.875"		18-7844	Short - 3.875"	
18-7945	Long - 4.35"		18-7845	Long - 4.35"	
18-7866	High Capacity - 6"				
18-7865	Compact 10 Micron				

REPLACEMENT FILTERS FOR OMC

10 MICRON REPLACEMENT FILTERS			21 MICRON REPLACEMENT FILTERS		
Part #	Description	Replaces	Part #	Description	Replaces
18-7946	OMC thread	OMC 502905	18-7846	OMC thread	OMC 502905
18-7989	Cobra EFI	OMC 502906	18-7789	Cobra EFI	OMC 502906



10 MICRON REPLACEMENT FILTERS AND KITS WITH DRAIN BOWLS

REPLACEMENT FILTERS			FILTER & BOWL KITS		
Part #	Description	Replaces	Part #	Description	
18-7919	Spin on replacement	Racor S3213	18-7929	Filter & Metal Bowl Contains: 18-7919 filter, 18-7924 bowl	
18-7920	Spin on replacement	OMC 771839 Racor S3214	18-7941	Filter & AquaVue™ Bowl OMC style Contains: 18-7920 filter, 18-7922 bowl	
18-7947	Spin on replacement Fits - 120RRAC01	Racor S3240	18-7943	Filter & Metal Bowl OMC style Contains: 18-7920 filter, 18-7924 bowl	
18-7948	Spin on replacement Fits - 320RRAC01	Racor S3227	REPLACEMENT ELEMENTS		
18-7949	Spin on replacement Fits - 660RRAC02	Racor S3232	Part #	Description	Replaces
REPLACEMENT BOWLS			18-7930	1977-83 Fuel system with add on filter kit	OMC 173326
Part #	Description				
18-7924	Metal Collection Bowl				



18-7792
FUEL FILTER
Replaces: 910641, 3855104
Fits: OMC 3.0L (1996-98), 3.8L/170 (1981)



18-7854
FUEL FILTER
Replaces: 984491, 311684
Rochester 17078904



18-7855
FUEL FILTER
Replaces: 983870, 910139
Rochester 17068453



**18-7717
FILTER ELEMENT**
For: Rochester 2 bbl & 4 bbl Carburetors



**18-7859
FUEL FILTER**
Replaces: 908034
For: Most GM Inline 4 & 6 cycle:
Ford and GM V-8's up to 400 HP



**18-7860
FUEL FILTER**
Replaces:
381690, 312456
with AC Fuel Pumps
For: Inline 4 & 6 cycle engines



**18-7861
REPLACEMENT
CANISTER AND FILTER**
Replaces: 981911



**18-7862
FUEL FILTER ELEMENT**
For Fuel Filter
(Includes Gasket)
Replaces: 982230



**18-7964
TRANSMISSION FILTER KIT**



**18-8072
FUEL ELBOW**
3/8" Hose Barb with
3/8" NPT Thread
Replaces: 174177
90

Display Package



**HOSE BARB
NPT Thread**
18-8074 3/8" with 1/4"
Replaces: 173312
18-8055 5/16" with 1/4"
Replaces: 173311

Display Package

PKG OF 10

SNAPPER CLAMPS

Part #	Clamp O.E. #	Clamp Range	Size
18-8020 ①	322652	.538 - .608	8
18-8021 ①	911616	.597 - .665	10
18-8034 ①	329654	.670 - .780	12
18-8200 ①	322653	.360 - .406	2
18-8201 ①	124249	.410 - .468	4
18-8202 ①	322654	.475 - .536	6
18-8203 ①	329653	.750 - .875	14
18-8204 ①	324825	.875 - .975	19

ALL SIERRA WATER PUMPS ARE BI-DIRECTIONAL



**18-3574
CIRCULATING WATER PUMP**
Big block GM engines with composite timing covers "Late Model" includes 482 and 502 CID
Replaces: 3855991



**18-3575
CIRCULATING WATER PUMP**
Replaces: 984360, 986779, 380640, 3854017



**18-3577
CIRCULATING WATER PUMP**
Replaces: GM 6269358, OMC 987447, 983296, 986074, 3854118



**18-3578
CIRCULATING WATER PUMP**
Replaces: 984876



**18-3583
CIRCULATING WATER PUMP**
Replaces: 985429, 980477, 382218, 3853850



**18-3584
CIRCULATING WATER PUMP**
Replaces: 982517, 3853796, 982515

① This product is priced per piece. To order priced per package, please add -9 to the part number.

WATER CIRCULATING PUMP APPLICATION

Model	Year	Part #	Model	Year	Part #	Model	Year	Part #
2.3	1987-90	18-3578	165	1972-76	18-3575	245	1972-75	18-3583
2.5	1982-86	18-3575	175	1977	18-3584	245		
3	1982-92	18-3575	185	1967-80	18-3583	Jet Drive	1972-75	18-3583
3.8	1981-86	18-3583	190	1977	18-3584	250		
4.3	1985-92	18-3583	200	1979-81	18-3583	Inboard	1970-74	18-3583
5	1982-88	18-3583	210	1968-70	18-3583	250	1979	18-3575
5	1989-92	18-3575	210			260		
5.7	1982-92	18-3583	Inboard	1970-72	18-3583	Inboard	1975-76	18-3583
5.8	1989-92	18-3575	215	1971	18-3583	260	1979-81	18-3583
100	1972	18-3575	225	1972-78	18-3583	262	1989	18-3583
100	1973	18-3583	225			290		
120	1965-69	18-3575	Inboard	1973-74	18-3583	Jet Drive	1974-75	18-3583
120	1972	18-3575	230			305 CID IB	1977-82	18-3583
120	1973-74	18-3583	Inboard	1975-76	18-3583	350 CID IB	1977-82	18-3583
120	1975-81	18-3575	230	1979-81	18-3583	350	1988-92	18-3583
140			235	1971	18-3583	351	1992	18-3584
Jet Drive	1973	18-3575	235	1977	18-3584	454 CID IB	1977-80	18-3577
140	1973-81	18-3575	240	1978	18-3584	454 CID IB	1982	18-3583



**18-3005
IMPELLER**
Replaces: 377992



**18-3058
IMPELLER**
Replaces: 983895



**18-3086
IMPELLER**
Replaces: 379475, 777130

IMPELLER APPLICATION

Model	Years	Impeller	Model	Years	Impeller
2.3	1987-90	18-3058 ③	175	1975-77	18-3086
2.5	1986	18-3058	185	1967-68, 1978-84	18-3086
3	1986-92	18-3058 ③	190	1974-77	18-3086
4.3	1986-92	18-3058	200	1966-68, 1979-84	18-3086
5	1986-92	18-3058	210	1968-72	18-3086
5.7	1986-92	18-3058 ④	215	1971	18-3086
5.8	1989-92	18-3058	225	1972-76, 1978	18-3086
7.5	1987	18-3058	230	1975-76, 1979-81	18-3086
80	1968-69	18-3005	235	1971, 1975-77	18-3086
88	1964	18-3005	240	1978	18-3086
90	1965-68, 1970-71	18-3005	245	1972-75	18-3086
100	1972-73	18-3086	250	1970-74, 1979	18-3086
110	1964	18-3005 ①	260	1975-76, 1979-84	18-3086
110	1964	18-3086 ②	262	1989	18-3058
120	1965-67	18-3005 ①	305	1977-78	18-3086
120	1965-67	18-3086 ②	350	1977-78	18-3086
120	1968-84	18-3086	350	1988-91	18-3058
140	1973-84	18-3086	370	1988	18-3058
150	1964-66	18-3086	454	1977	18-3086
155	1967-72	18-3086	454	1990-91	18-3058
165	1972-76	18-3086	460	1988-90	18-3058
170	1974	18-3086			

- ① Standard pump
- ② Heavy duty pump

- ③ Except models originally equipped with short impeller or retrofitted with short impeller kit
- ④ Except 1992 5.7 L.E. models



**18-3108
IMPELLER KEY**
Replaces: 308928
Fits: Sterndrive models (1968-85)
For: Stringer Drive Impellers 18-3005 & 18-3086



**18-3111
WATER PUMP
SHAFT SEAL**
Replaces: 907774
I/O 1972-86
EXCEPT COBRA



**18-4833
WATER PASSAGE
HOUSING
(LOWER UNIT)**
Replaces: 915720
Fits: OMC Cobra (1986-93) without cone clutch



**18-4837
WATER PASSAGE COVER**
Replaces: 911734
Fits: OMC Cobra (1986-93) without cone clutch



**18-3119
WATER PUMP HOUSING**
Replaces: 983298



**18-3206
WATER PUMP HOUSING**
Replaces: 984744
For: OMC Cobra



**18-3145
PUMP LINER**
Replaces: 911844



**18-3121
IMPELLER PLATE**
Replaces: 911703
COBRA



**18-3141
IMPELLER PLATE**
Replaces: 313176
110-260 HP I/O 1968-86
EXCEPT COBRA



**18-3502
WATER PUMP VENT HOSE**
Replaces: 912614
Fits: OMC Cobra (1986-93) without cone clutch

① **18-3212-1D** Display Package



**18-3212-1
IMPELLER
REPAIR KIT**
Replaces: 984461

— CONTAINS —

Part #	Description	O.E.M. #	Qty.
18-2541	O-Ring	911704	1
18-2916	Water Pump Housing Gasket	911702	1
18-3058	Impeller	983895	1
18-3121	Impeller Plate	911703	1
18-3145	Pump Liner	911844	1



**18-3286
IMPELLER
REPAIR KIT**
1964-86
EXCEPT COBRA

— CONTAINS —

Part #	Description	O.E.M. #	Qty.
18-7135	O-Ring	310584	1
18-3141	Plate	313176	1
18-7129	O-Ring	314491	1
18-3111	Rubber Seal	907774	1
18-3086	Impeller	379475	1
18-7158	O-Ring	310585, 310967	1



**18-3386
WATER PUMP KIT**
Replaces: 983218
1964-86
EXCEPT COBRA

— CONTAINS —

Part #	Description	O.E.M. #	Qty.
18-7135	O-Ring	310584	1
18-3141	Plate	313176	1
18-7129	O-Ring	314491	1
18-3086	Impeller	379475	1
18-3111	Rubber Seal	907774	1
18-3119	Impeller Housing	983298	1
18-7158	O-Ring	310585, 310967	1



**18-3348
COMPLETE WATER PUMP KIT**
Replaces: 984461
For: All OMC Cobra Drives-2.3 (1987-90), 2.5 (1986), 3.0(1986-93), 4.3(1986-93), 4.6(1989), 5.0(1986-93), 5.7(1986-93), 5.8 (1989-93), 7.5(1987-89)



**18-3349
WATER PUMP HOUSING KIT**
For: All OMC Cobra Drives-2.3 (1987-90), 2.5 (1986), 3.0(1986-93), 4.3(1986-93), 4.6(1989), 5.0(1986-93), 5.7(1986-93), 5.8 (1989-93), 7.5(1987-89)



**18-5897
SENDER**
Replaces: 980613
3/8" — 18 NPT
For: Mercruiser Vazer



**18-5898
SENDER**
Replaces: 171960
1/2" — 14 NPT



**18-5899
OIL PRESSURE
SENDER**
Replaces: 982650



**18-3554
THERMOSTAT**
Replaces: 383307
160°



**18-3558
THERMOSTAT**
Replaces: 982554, 3853799
160°

① **18-3653D** Display Package



**18-3653
THERMOSTAT KIT**
— CONTAINS —

Part #	O.E. #	Desc.
18-3554	383307	Thermostat
18-2858	314809	Manifold Gasket
18-2917	3701777 (GM)	Thermostat Gasket
18-2947	310913	Thermostat Gasket

APPLICATION FOR THERMOSTATS/KITS ON NEXT PAGE

① Items ending in "D" are Display Packaged - Regular number is Non-Display



① 18-3670D



**18-3670
THERMOSTAT KIT**

Fits: 2.5L & 3.0L (1982-88)

— CONTAINS —

Part #	O.E.#	Desc.
18-3558	982554	Thermostat
18-2858	314809	Thermostat Housing Cover Gasket
18-0929	313416	Thermostat Gasket



① 18-3676D



**18-3676
THERMOSTAT KIT**

140°

For: 7.4L (1994-98), 8.2L (1998)

— CONTAINS —

Part #	O.E.#	Desc.
18-7170	3852071	O-Ring
18-2917	3852111	Thermostat Gasket
—	3853983	Thermostat



① 18-3677D



**18-3677
THERMOSTAT KIT**
160°

— CONTAINS —

Part #	O.E.#	Desc.
18-7170	3852071	O-Ring
18-2917	3852111	Thermostat Gasket
—	3856961	Thermostat

HP	Year	HP	Year
4.3L	1994-97	5.8L	1994-97
4.3 HO	1991-97	5.8 (EFI)	1993-97
5.0 L	1994-97		

THERMOSTAT AND THERMOSTAT KIT APPLICATION

Model	Years	Thermostat	Thermostat Kit	Model	Years	Thermostat	Thermostat Kit
90	1970	18-3554	18-3653	250	1970-73	18-3554	18-3653
100	1972-73	18-3554	18-3653	250	1979	18-3554	18-3653
120	1969-80	18-3554	18-3653 ①	260	1979-81	18-3554	18-3653
120	1980-81	18-3558	18-3670 ②	262	1989	18-3554	—
140	1973-80	18-3554	18-3653 ①	305	1977-82	18-3554	18-3653
140	1980-81	18-3558	18-3670 ②	350	1977-82	18-3554	18-3653
155	1969-72	18-3554	18-3653	350	1989	18-3554	—
165	1972-76	18-3554	18-3653	351	1992	18-3554	—
170	1974	18-3554	18-3653	454	1977-82	18-3554	18-3653
175	1975-77	18-3554	18-3653	460	1989	18-3554	—
185	1978-80	18-3554	18-3653	2.5L	1982-88	18-3558	18-3670
190	1974-77	18-3554	18-3653	3.0L	1982-88	18-3558	18-3670
200	1979-81	18-3554	18-3653	3.8L	1981-85	18-3554	18-3653
210	1969-72	18-3554	18-3653	4.3L	1985-86	18-3554	18-3653
215	1971	18-3554	18-3653	4.3L	1989-92	18-3554	—
225	1971	18-3554	18-3653	5.0L	1982-88	18-3554	18-3653
230	1979-81	18-3554	18-3653	5.0L	1989-92	18-3554	—
235	1971	18-3554	18-3653	5.7L	1982-88	18-3554	18-3653
235	1975-77	18-3554	18-3653	5.7L	1989	18-3554	—
240	1978	18-3554	18-3653	5.8L	1989-92	18-3554	—
245	1972-75	18-3554	18-3653	7.5L	1988	18-3554	18-3653

① 1980 Models with "C" suffix only

② 1980 Models with "C1" suffix only

SINGLE DIAMETER HOSE

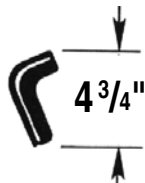

**18-70021
MOLDED HOSE**
3/4" ID



**18-70704
MOLDED HOSE**
1 1/4" ID

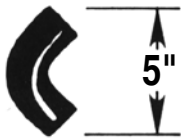

**18-70924
MOLDED HOSE**
1 3/4" ID

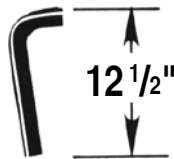

**18-71218
MOLDED HOSE**
1" ID

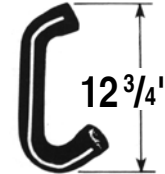

**18-71337
MOLDED HOSE**
1 3/4" ID

STRAIGHT HOSE



**18-75100
MOLDED HOSE**
Straight 48"
1" ID



**18-75125
MOLDED HOSE**
Straight 48"
1 1/4" ID

① Items ending in "D" are Display Packaged - Regular number is Non-Display

V-BELTS

- 1** High strength synthetic cords resist shockload failure. Their low stretch properties assure uniform performance over the life of the belt.
- 2** The compression section is a special rubber compound that assures smooth and even transfer of load forces to the cords.
- 3** Cogs are molded to precise engineering tolerances to improve flexibility and maintain cord support. Cog geometry provides a large area for air circulation to keep the belt cool and prevent damaging heat build up in the cushion section.
- 4** Rubber edges maintain positive, no-slip contact with pulley grooves for reliable energy transfer.

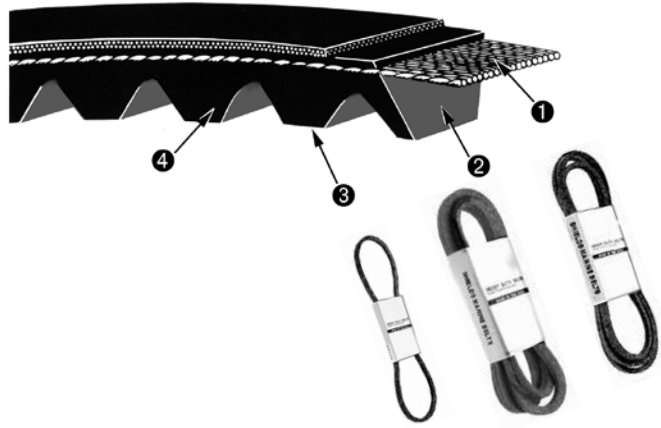

BELT SIZE LISTING BY NUMBER

Part #	Effective Length (Inches)	Top Width (Inches)	Part #	Effective Length (Inches)	Top Width (Inches)	Part #	Effective Length (Inches)	Top Width (Inches)
18-15290	29	29/64	18-15405	40 1/2	29/64	18-15460	46	29/64
18-15300	30	29/64	18-15410	41	29/64	18-15470	47	29/64
18-15325	32 1/2	29/64	18-15415	41 1/2	29/64	18-15480	48	29/64
18-15345	34 1/2	29/64	18-15430	43	29/64	18-15495	49 1/2	29/64
18-15370	37	29/64	18-15435	43 1/2	29/64	18-15500	50	29/64
18-15380	38	29/64	18-15440	44	29/64	18-15520	52	29/64
18-15390	39	29/64	18-15450	45	29/64	18-15550	55	29/64
18-15400	40	29/64	18-15455	45 1/2	29/64			

V-BELT INTERCHANGE

OMC #	Part #	Part #	OMC #
310953	18-15460	18-15380	910414
311046	18-15440	18-15400	311606
311606	18-15400	18-15415	910343
908929	18-15455	18-15435	912509
909818	18-15500	18-15440	311046
909971	18-15460	18-15450	914787
910343	18-15415	18-15455	908929
910414	18-15380	18-15460	310953
912418	18-15500	18-15460	909971
912509	18-15435	18-15500	909818
912714	18-15520	18-15500	912418
914787	18-15450	18-15520	912714

HOSE INTERCHANGE

OMC #	Part #	Sierra #	Part #
312781	18-71337	18-71337	312781
910305	18-75100	18-75100	910305
912424	18-75100	18-75100	912424
912793	18-75125	18-75100	913488
913488	18-75100	18-75125	912793

V-BELT APPLICATION

Model	Year	Water Alternator	Pump	Power Steering	Model	Year	Water Alternator	Pump	Power Steering
100	1972-73	18-15400	18-15400	—	262 KING COBRA	1989	—	*18-15380	18-15455
110	ALL	18-15440	18-15440	—	305	1977-84	18-15440	18-15440/ *18-15455 or *18-15500	—
120	1965-81	18-15400	18-15400	—	350	1977-84	18-15440	18-15440/ *18-15455 or *18-15500	—
140	1982-87	18-15400	18-15400	—	350 KING COBRA	1988-90	18-15455	18-15455	—
165	1972-76	18-15400	18-15400	—	350 KING COBRA	1988-90	18-15470	*18-15380	18-15455
170	1974	18-15400	18-15400	—	454	1977-82	18-15455	18-15455/ *18-15500	—
175	1975-77	18-15400	18-15400	—	454 KING COBRA	—	—	18-15470	18-15380
185 W/O PS	1978-84	18-15440	18-15440	—	460 KING COBRA	1988	18-15460	18-15460	18-15520
185 W/ PS	1978-84	18-15460	18-15460	18-15460	888	—	18-15435	18-15435	—
190	1974-77	18-15400	18-15400	—	2.3L	1987-90	18-15435	18-15435	18-15435
200 W/O PS	1979-81	18-15440	18-15440	—	2.5L W/O PS	1982-87	18-15415	18-15415	—
200 W/ PS	1979-81	18-15460	18-15460	18-15460	2.5L W/ PS	1982-87	18-15400	18-15400	18-15460
210	1970-71	18-15440	18-15440	—	3.8L W/O PS	1982-90	18-15400	18-15400	—
215	1971	18-15440	18-15440	—	3.8L W/ PS	1982-90	—	*18-15380	18-15455
225	1972-84	18-15440	18-15440	—	5.0L W/O PS	1982-90	18-15455	18-15455	—
230,260	1975	18-15440	18-15440/ *18-15455	—	5.0L W/ PS	1982-90	—	*18-15380	18-15455
230,260	1979-81	18-15440	18-15440	—	7.5L	1987	18-15460	18-15460	18-15520
230,260	1979-81	18-15460	18-15460	18-15460					
235	1971	18-15440	18-15440	—					
235	1975-77	18-15400	18-15400	—					
240	1978-84	18-15400	18-15400	—					
250	1979	18-15400	18-15400	—					
262 KING COBRA	1989	18-15400	18-15400	—					

* W/ SEA WATER PUMP

Fits GM 181 CID 3.0L, 4 Cylinder

Fits Most 141 Models

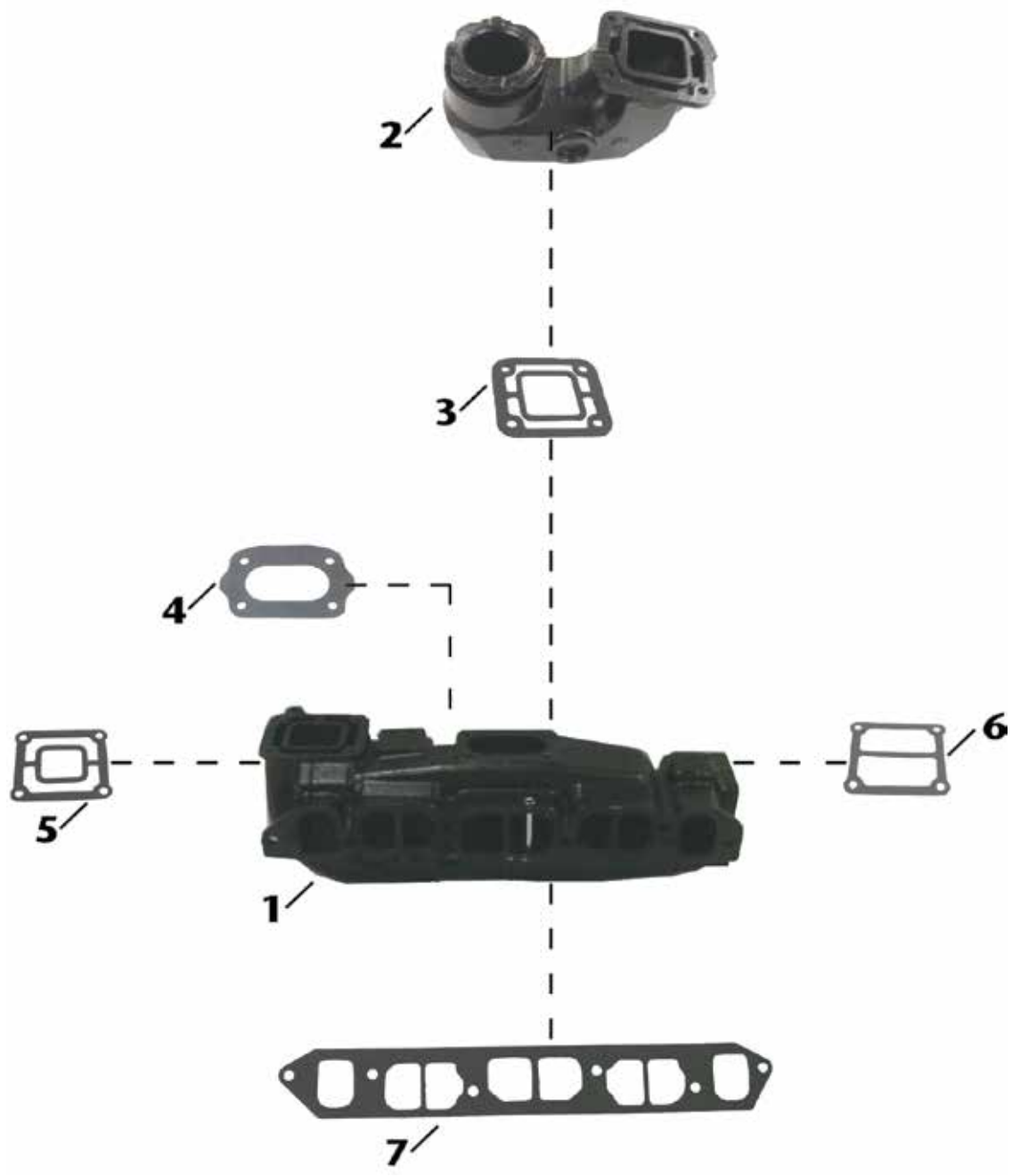

Item No	Description	OE No.	Application
1	18-1901 MANIFOLD	982490, 980083, 984054	GM 181 cu.in. 3.0L , 4 Cylinder. Fits most 140 models.
2	18-1922 MANIFOLD ELBOW	987784	Use with Manifold: 18-1901; Elbow Gasket: 18-2875
3	18-2875 ELBOW GASKET	385049	Use with Elbow: 18-2875
4	18-0937 CARBURETOR GASKET	315055	Use with Manifold: 18-1901
5	18-2861 END PLATE GASKET	311121	Use with Manifold: 18-1901
6	18-0114 END PLATE GASKET	907761	Use with Manifold: 18-1901
7	18-1204 MANIFOLD GASKET	912164	Use with Manifold: 18-1901

Fits GM Small Block V8 305-350 cu. in. 1979-1989

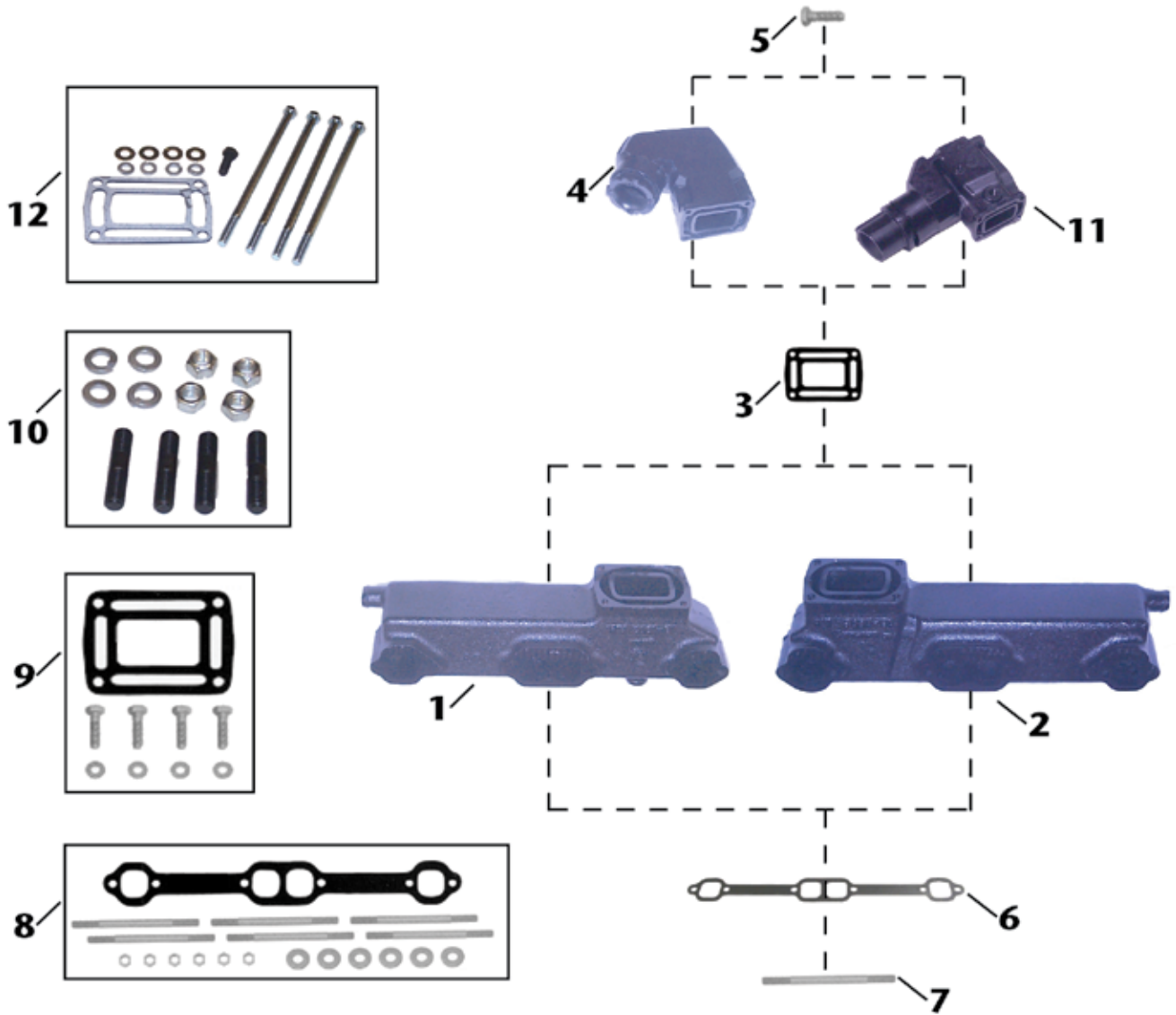

Item No	Description	OE No.	Application	
1	18-1902	MANIFOLD (STARBOARD)	912441	GM Small Block (V8) 305-350 cu.in. (1979-1989)(Starboard) Use with Manifold Gasket: 18-2949. Mounting Kit: 18-8502
2	18-1903	MANIFOLD (PORT)	912442	GM Small Block (V8) 305-350 cu.in. (1979-1989)(Port). Use with Manifold Gasket: 18-2949. Mounting Kit: 18-8502
3	—	ELBOW GASKET	909786	Use with Elbow: 18-1921; Mounting Kit: 18-8534.
4	18-1921	MANIFOLD ELBOW	909863	Use with Manifold: 18-1902, 18-1903. Mounting Kit: 18-8534.
5	NSS	MOUNTING BOLT	N/A	Included in 18-8534 mounting kit.
6	18-2949	MANIFOLD GASKET	96306	Use with Manifold: 18-1902, 18-1903. Included in 18-8502 mounting kit.
7	NSS	MOUNTING STUD	N/A	Included in 18-8502 mounting kit.
8	18-8502	MOUNTING KIT	N/A	Use with Manifold: 18-1902, 18-1903. Includes 18-2949 manifold gasket.
9	18-8534	MOUNTING KIT	N/A	Use with Elbow: 18-1921.
10	18-8553	HARDWARE KIT	N/A	Hardware only for Elbow 18-1921.
11	18-1909-1	MANIFOLD ELBOW	N/A	Use with Elbow Gasket: 18-0943-1
12	18-8507	MOUNTING KIT	N/A	Use with Manifold Elbow: 18-1909-1

Fits GM Small Block V8 305-350 cu. in.

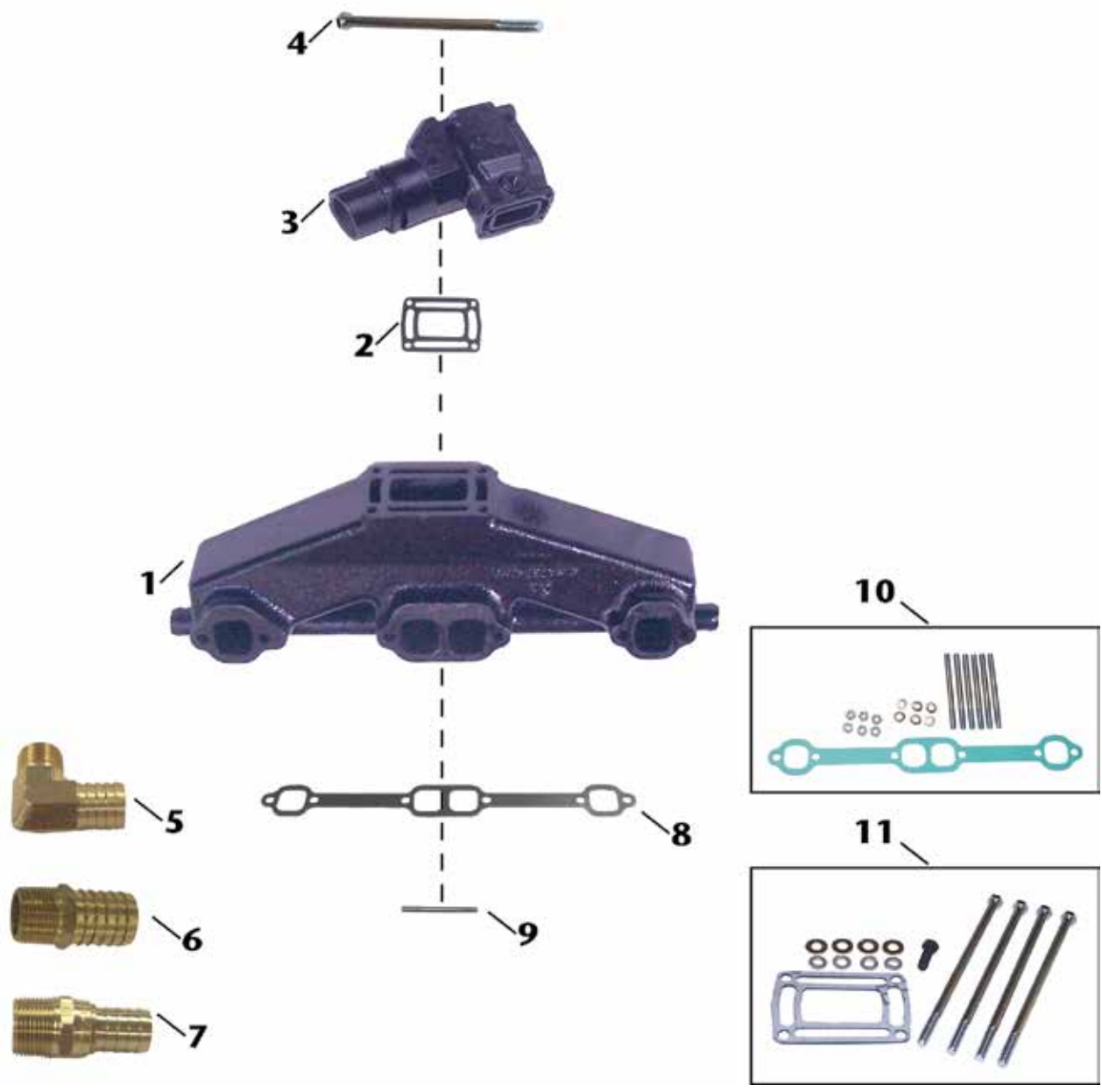

Item No	Description	OE No.	Application
1	18-1986-1 MANIFOLD	3857723	GM Small Block (V8) 305-350 cu.in. Use with Manifold Gasket: 18-2949; Mounting Kit: 18-8502.
2	— ELBOW GASKET	909786	Use with Elbow: 18-1909-1. Included in 18-8507 mounting kit.
3	18-1909-1 MANIFOLD ELBOW	913784, 3855270, 3850459, 3857944	Use with Manifold: 18-1986-1; Mounting Kit: 18-8507.
4	NSS MOUNTING BOLT	N/A	Included in 18-8507 mounting kit.
5	18-8216 HOSE FITTING	N/A	3/4" - 14NPT X 1" Hose (Corrosion Resistant Brass Fitting)
6	18-4461 HOSE FITTING	N/A	3/4" - 14NPT X 1" Hose (Corrosion Resistant Brass Fitting)
7	18-8215 HOSE FITTING	N/A	3/4" - 14NPT X 3/4" Hose (Corrosion Resistant Brass Fitting)
8	18-2949 MANIFOLD GASKET	96306	Use with Manifold: 18-1986-1. Included in 18-8502
9	NSS MOUNTING STUD	N/A	Included in 18-8502 mounting kit.
10	18-8502 MOUNTING KIT	N/A	Use with Manifold 18-1986-1. Includes 18-2949 manifold gasket.
11	18-8507 MOUNTING KIT	N/A	Use with Elbow: 18-1909-1. Includes 18-0943-1 elbow gasket.

SIERRA MANIFOLDS ARE PAINTED, PACKAGED AND LEAK TESTED



**18-1901
MANIFOLD**
Replaces: 984054
Fits 181 CID model 140
and 3.0L (1973 - 1989)
Use with:
Exhaust Elbow Gasket: 18-1204
***For Exploded View - See PAGE 772**



**18-1898
MANIFOLD**
Port & Starboard
Replaces: Barr CHVA-1-84, Marine Power 0991-110
Fits 454 cu.in. GM big block V8 engines
Use with:
Exhaust Manifold Gasket: 18-0418
***For Exploded View - See Pages 556-557**

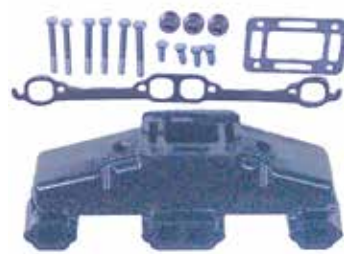

**18-1997-1
EXHAUST MANIFOLD**
Port & Starboard
Replaces Barr CHV-1-83 Universal Center Riser Manifold
FITS: GM 283, 305, 307 and 350 CID engines
Use with:
Exhaust Manifold Gasket Set: 18-0604
***For Exploded View - See Pages 558-559**

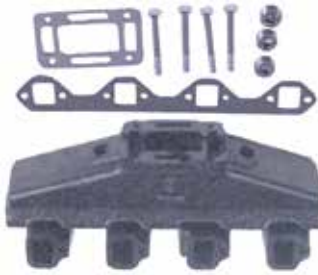

**18-1998-1
EXHAUST MANIFOLD**
Port & Starboard
Replaces: Barr FM-1-83
Universal Center Riser Manifold
FITS: Ford 302 and 351 CID engines
Use with:
Exhaust Manifold Gasket Set: 18-0603
***For Exploded View - See Pages 560-561**



**18-1986-1
MANIFOLD**
Port & Starboard
Replaces: 3852374, 3857723
For: GM Small Block V8 305-350 ci
Use with:
Exhaust Manifold Gasket: 18-2949
Mounting Kit: 18-8502



**18-1902
MANIFOLD**
Replaces: 912441
V-8 - STARBOARD SIDE
Fits most GM V-8 small blocks with end riser
Use with:
Mounting Kit: 18-8502



**18-1903
MANIFOLD**
Replaces: 912442 V-8 - PORT SIDE
Fits most GM V-8 small blocks with end riser
Use with:
Mounting Kit: 18-8502



**18-1904
MANIFOLD**
Port & Starboard
Replaces: 980959 V-8 - EITHER SIDE
Fits most Ford V-8 302 & 351W with end riser
Use with:
Exhaust Manifold Gasket: 18-0183 or 18-2896
(See Application Chart)



**18-1876
RISER**

Replaces: 980617
Use with:
Manifold: 18-1904
Riser Gasket: 18-2850
Fits: 170 (1974), 175 (1975-76),
190 (1974-76), 235 (1975-76)



**18-1991
30° EXHAUST ELBOW ADAPTER**

For use with 3" I.D.
Exhaust Hose
Use with:
Manifold Riser: 18-1999



**18-1992-1
80° EXHAUST ELBOW**

For 3" I.D. Exhaust Hose
(As used in 18-1987 Exhaust
Manifold Conversion Kit)



**18-1921
ELBOW MANIFOLD**

Replaces: 909863
V-8
Fits most GM V-8 small blocks
Use with:
Manifold: 18-1902, 18-1903
Elbow Gasket: 18-0943-1
Mounting Kit: 18-8534



**18-1922
ELBOW MANIFOLD**

Replaces: 987784
4 CYL.
Fits most 140 HP 3.0L (181 CID)
Use with:
Manifold: 18-1901
Elbow Gasket: 18-2875



**18-1909-1
RISER**

Replaces:
OMC 913784, 3855270, 3850456, 3857944,
VOLVO 3855270-9, 3857944-7, 3863061
OMC Riser, 4" outlet 7°: Fits many GM & Ford center rise
manifolds.
Use with:
Manifold: 18-1986-1
Riser Gasket: 18-0943-1
Mounting Kit: 18-8507



**18-1939
RISER**

Replaces: Barr 20-0100, Marine Power 0992-593 Barr, Indmar
and Marine Power Ford Small Block V8 302-351cu.in., GM Small
Block V8 305-350cu.in., GM Big Block V8 454cu.in.
Use with:
Manifold: 18-1997-1, 18-1998-1
Riser Gasket: 18-2854 open or 18-0476 blocked
Mounting Kit: 18-4364 open or 18-8535 blocked



**18-1907
RISER**

Replaces: Barr 20-0102, Indmar 53-2009,
53-2018, Barr and Indmar Ford Small Block
V8 302-351cu.in.
Use with:
Manifold: 18-1997-1, 18-1998-1
Riser Gasket: 18-2854 open or
18-0476 blocked
Mounting Kit: 18-4364 open or 18-8535
blocked



**18-1999
EXHAUST
MANIFOLD
RISER**

Replaces: Barr 20-0082
Use with :
Manifold: 18-1997-1 or 18-1998-1
Riser Gasket: 18-2854 open
Comes with 18-4364 open
If blocked mounting kit is required use 18-8535
Replaces: Barr 20-0082-P



**18-4009
MANIFOLD END PLATE**

Replaces: 910384



PIPE PLUGS

Part #	Thread Size
18-4256	1/4"
18-4257	1/4"
18-4258	3/4"
18-4263	1/8" - 27 NPT
18-4264	3/8" - 18 NPT

56507 Pipe Sealant with Teflon®
is recommended for use on plug threads.



**18-4461
HOSE BARB**

3/4" - 14 NPT X 1" Hose
Corrosion Resistant Brass Fitting



**18-8216
HOSE BARB**

Fits: OMC- In-Line 6 Cylinders

① **18-4218D**

Display
Package











**18-4218
BRASS DRAIN COCK**

Replaces: 379957
1/4"
18-3223-9 Bulk Pack of 12

 <p>18-4363 MOUNTING PACKAGE Replaces: Barr FM-1-83-P Use with: Manifold: 18-1998-1</p>	 <p>18-4364 (Open) MOUNTING PACKAGE Replaces: Barr 20-0082-P Use with: Riser: 18-1999, 18-1939, 18-1907</p>	 <p>18-8502 MOUNTING KIT OMC GM Small Block V8 305-350cu.in. (1979-89) OMC/Volvo GM Small Block 305-350cu.in. Used with: Manifolds: 18-1931-1, 18-1902 & 18-1903</p>
 <p>18-8507 MOUNTING KIT OMC/Volvo GM Small Block V8 305-350cu.in. Used with: Riser: 18-1909-1</p>	 <p>18-8534 MOUNTING KIT OMC GM Small Block V8 305-350cu.in. (1979-1989) and multiple application Ford and GM Risers Used with: Riser: 18-1921</p>	 <p>18-8535 (Blocked) MOUNTING KIT Barr, Indmar and Marine Power Ford Small Block V8 302-351cu.in., GM Small Block V8 305-350cu.in., GM Big Block V8 454cu.in. Used with: Risers: 18-1939, 18-1999, and 18-1907</p>
 <p>18-8536 MOUNTING KIT Barr, Indmar and Marine Power GM Small Block V8 305-350cu.in. Used with: Manifold: 18-1997-1</p>	 <p>18-8538 MOUNTING KIT Barr and Indmar Ford Small Block V8 302-351cu.in. Used with: Manifold: 18-1998-1, 18-1904</p>	 <p>18-8553 MOUNTING KIT Used with: Exhaust Elbow: 18-1921</p>
 <p>18-2779 EXHAUST HOSE Replaces: 3852696</p>	 <p>18-2781 EXHAUST HOSE Replaces: 3852742</p>	 <p>18-0114 MANIFOLD END GASKET Replaces: 907761</p>
 <p>18-0183 EXHAUST MANIFOLD GASKET Replaces: 908717, 916262, 3852455, 3853742 Use with: Manifold: 18-1958, 18-1962, 18-1904, 18-1998-1, 18-1996, 18-1979</p>	 <p>18-0476 (Blocked) RISER GASKET Replaces: Barr 01-0105 Indmar & Marine Power Ford Small Block V8 302-351cu.in. Used with: Risers: 18-1939, 18-1999 and 18-1907</p>	 <p>18-0943-1 18-0943-1-9① EXHAUST ELBOW GASKET Replaces: 909786, 3850496 Used with: Riser: 18-1909-1</p>

① Priced per Package

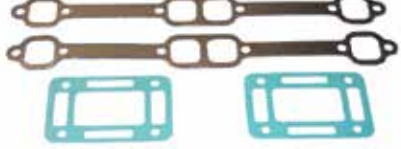
<p>PKG OF 2</p>  <p>18-2850 18-2850-9^① EXHAUST ELBOW GASKET Replaces: 908935</p>	<p>PKG OF 2</p>  <p>18-2854 18-2854-9^① EXHAUST RISER GASKET Replaces: Barr 01-0107 Use with: Mounting Kit: 18-8535 Risers: 18-1999, 18-1939, 18-1907</p>	<p>PKG OF 2</p>  <p>18-2861 18-2861-9^① EXHAUST ELBOW GASKET Replaces: 311121</p>
<p>PKG OF 2</p>  <p>18-2875 18-2875-9^① EXHAUST ELBOW GASKET Replaces: 3850495, 908013 Used with: Elbow: 18-1922</p>	 <p>18-2896 MANIFOLD GASKET Replaces: 311068 For GM 4 cyl. 153 cu.in. Early models 110/120 where the carb. linkage mounts to the rear of the engine Use with: Manifold: 18-1904</p>	
<p>PKG OF 2</p>  <p>18-2902 18-2902-9^① MANIFOLD GASKET Replaces: 909314 Use with: Manifold: 18-1997-1, 18-1986-1, 18-1902, 18-1903</p>	<p>PKG OF 2</p>  <p>18-2949 18-2949-9^① MANIFOLD GASKET Replaces: Barr CHV-47-000 Use with: Manifold: 18-1997-1</p>	
 <p>18-0603 EXHAUST MANIFOLD GASKET SET For: Ford 302/351 CID Eng. Use with: Manifold: 18-1998-1</p>	 <p>18-0604 EXHAUST MANIFOLD GASKET SET For: GM 305/350 CID Eng. Use with: Manifold: 18-1997-1</p>	

① Priced per Package

MANIFOLD/MANIFOLD GASKET APPLICATION

Year	Horsepower	Exhaust Manifold	Exhaust Elbow	Manifold Mount Kit	Elbow Mount Kit	Manifold Gasket	Elbow Gasket
1997-98	5.0/5.7L	18-1986-1	18-1909-1	18-8502	18-8507	18-2902	18-0943-1
1994-97	5.8L (Ford)	—	—	—	—	18-0183	18-0943-1
1994-97	7.4L (GM)	—	—	—	—	18-0418	18-0943-1
1991-93	3.0 Liter	—	18-1922	—	—	—	18-2875
1992-93	4.3/4.3 HO	—	18-1909-1	—	18-8507	—	18-0943-1
1993	5.0/5.0 HO/5.8 Liter	—	18-1909-1	—	18-8507	18-0183	18-0943-1
1993	5.0 & 5.8 EFI	—	18-1909-1	—	18-8507	18-0183 ②	18-0943-1
1993	5.0 & 5.8 EFI	—	18-1909-1	—	18-8507	—	18-0943-1
1993	5.8L (Ford)	—	18-1909-1	—	18-8507	18-0183	18-0943-1
1993	7.4L (GM), 8.2L (GM)	—	18-1909-1	—	18-8507	18-0418	18-0943-1
1993	351 King, 454/454 HO/502	—	—	—	—	—	18-0943-1
1992	5.0/5.0 HO/5.8 Liter	—	18-1909-1	—	18-8507	18-0183	18-0943-1
1992	5.8L (Ford)	—	—	—	—	18-0183	18-0943-1
1992	7.4L (GM), 8.2L (GM)	—	—	—	—	18-0418	18-0943-1
1992	351 King Cobra	—	—	—	—	18-0183	18-0943-1
1992	454/454 HO/502	—	—	—	—	—	18-0943-1
1991	4.3/4.3 HO	—	—	—	—	—	18-0943-1
1991	5.8L (Ford), 5.0/5.0HO/5.8 Liter	—	18-1909-1	—	18-8507	18-0183	18-0943-1

② 5.0L only

APPLICATION CONTINUED ON NEXT PAGE

MANIFOLD/MANIFOLD GASKET APPLICATION

Year	Horsepower	Exhaust Manifold	Exhaust Elbow	Manifold Mount Kit	Elbow Mount Kit	Manifold Gasket	Elbow Gasket
1991	454/454 HO	—	18-1909-1	—	18-8507	—	18-0943-1
1991	7.4L (GM)	—	18-1909-1	—	18-8507	18-0418	18-0943-1
1990-91	8.2L (GM)	—	18-1909-1	—	18-8507	—	—
1982-83,1985-90	3.0 Liter	18-1901	18-1922	—	—	—	18-2875
1990	4.3 Liter	—	18-1909-1	—	18-8507	—	—
1990	5.0/5.0 HO/5.8 Liter	—	18-1921	—	—	18-0183	18-0943-1
1990	5.0/5.7L	18-1986-1	18-1909-1	18-8502	18-8507	18-2902	18-0943-1
1990	7.4L (GM)	—	—	—	—	18-0418	18-0943-1
1990	7.5L (Ford)	—	—	—	—	18-0992	18-0943-1
1990	454 King Cobra	—	—	—	—	—	18-0943-1
1987-90	460 King Cobra	—	—	—	—	—	18-0943-1
1989	5.0/5.0 HO/5.8 Liter	—	18-1921	—	18-8534	18-0183	18-0943-1
1989	5.7/350 King Cobra	—	—	—	—	18-2902	18-0943-1
1988	5.0/5.7/350 King Cobra	18-1902 #	18-1921	18-8502	18-8534	18-2902	18-0943-1
1988	5.0/5.7/350 King Cobra	18-1903 *	18-1921	18-8502	18-8534	18-2902	18-0943-1
1988	370 King Cobra	—	—	—	—	—	18-0943-1
1982-87	5.0/5.7 Liter	18-1902 #	18-1921 ①	18-8502	18-8534	18-2902	18-0943-1
1982-87	5.0/5.7 Liter	18-1903 *	18-1921	18-8502	18-8534	18-2902	18-0943-1
1982-86	2.5 Liter	18-1901	18-1922	—	—	18-2896	18-2875
1984	3.0 Liter	18-1901	18-1921	—	18-8534	—	18-2875
1978-81	400 Series, 120 HP	—	—	—	—	18-2896	18-2861
1978-81	400 Series, 140 HP	—	18-1922	—	—	—	18-2875
1981	800 Series, 200,230,260 HP	18-1902 #	18-1921	18-8502	18-8534	18-2902	18-0943-1
1981	800 Series, 200,230,260 HP	18-1903 *	18-1921	18-8502	18-8534	18-2902	18-0943-1
1980	800 Series, 185-260 HP	18-1902 #	18-1921	18-8502	18-8534	18-2902	18-0943-1
1980	800 Series, 185-260 HP	18-1903 *	18-1921	18-8502	18-8534	18-2902	18-0943-1
1979	800 Series,185-230 HP	18-1902 #	18-1921	18-8502	18-8534	18-2902	18-0943-1
1979	800 Series,185-230 HP	18-1903 *	18-1921	18-8502	18-8534	18-2902	18-0943-1
1979	800 Series, 260 HP	18-1902 #	18-1921	18-8502	18-8534	18-2902	18-0943-1
1979	800 Series, 260 HP	18-1903 *	18-1921	18-8502	18-8534	18-2902	18-0943-1
1978	800 Series, 185-225 HP	18-1902 #	18-1921	18-8502	18-8534	18-2902	18-0943-1
1978	800 Series, 185-225 HP	18-1903 *	18-1921	18-8502	18-8534	18-2902	18-0943-1
1978	800 Series, 240 HP	—	18-1921	—	18-8534	—	—
1977	120 HP	—	—	—	—	18-2896	18-0943-1
1977	140 HP	—	18-1922	—	—	—	18-2861
1977	175 THRU 235 HP	—	18-1921	—	18-8534	18-0183	18-2875
1976	120 HP	18-1904	—	—	—	18-0183	18-0943-1
1974-76	140 HP	18-1904	18-1922	—	—	—	18-2861
1976	165 HP	18-1904	18-1922	—	—	18-2830	18-2875
1976	175 THRU 235 HP	18-1904	—	—	—	18-0183	18-2875
1974-75	120 HP	18-1904	—	—	—	18-2896	18-2850
1974-75	165 HP	18-1904	18-1922	—	—	—	18-2875
1975	175 THRU 235 HP	18-1904	—	—	—	18-0183	18-2875
1974	170 & 190 HP	18-1904	—	—	—	18-0183	18-2875
1974	175 THRU 235 HP	18-1904	—	—	—	18-0183	18-2850
1973	100,120,140 HP	—	—	—	—	18-2896	18-2861
1973	165 HP	—	18-1922	—	—	18-2896	18-2861
1972-73	225 & 245 HP	—	—	—	—	—	18-2883
1972	100,120 HP	—	—	—	—	18-2896	18-2861
1972	155 HP	—	—	—	—	N/A	18-2883
1972	165 HP S MODEL, C MODEL	—	—	—	—	—	18-2875
1971	215 & 235 HP	—	—	—	—	—	18-2859
1965-71	120 HP	—	—	—	—	—	18-2861
1967-71	155 HP	—	—	—	—	N/A	18-2859
1968-70	210 HP	—	—	—	—	—	18-2859
1967-68	185 HP	—	—	—	—	—	18-2859
1966-68	200 HP	—	—	—	—	N/A	18-2859
1964-66	150 HP	—	—	—	—	N/A	18-2859
1964	110 HP	—	—	—	—	N/A	18-2859

Starboard

* Port

① High rise applications only for 1985

② 5.0L only

OIL FILTERS



Part #	Fits:	O.E.M. #
18-7824-1	GM Engines (Short Filter)	173232, 502902
18-7875	Ford Engines (Long Filter)	173231, 502900
18-7876	GM Engines (Long Filter)	173233, 502901
18-7878-1	M-100, M200 (Short Filter)	502904
18-7879	GM V-6 Engines	173834, 502903



SEE PAGES 152-154 FOR ADDITIONAL INFORMATION

CYLINDER HEAD ASSEMBLIES



18-4484
CYLINDER HEAD ASSEMBLY

Replaces: 985080
Fits: 5.7L V-8 GM (1969-86) with 12 intake manifold mounting bolts, perimeter mount valve cover



18-4485
CYLINDER HEAD ASSEMBLY

Fits: 5.7L V-8 GM (1987-95) with press in rocker arm studs with 12 intake manifold mounting bolts- (4 inside intake manifold bolts at 23 degrees), center mount valve covers



18-4486
CYLINDER HEAD ASSEMBLY

Fits: 5.7L V-8 GM Vortec (1996-Up) with press in rocker arm studs with 8 intake manifold mounting bolts, composite valve cover



18-4489
CYLINDER HEAD ASSEMBLY

Fits: 2.5L/3.0L GM (1968-95)



18-4491
CYLINDER HEAD ASSEMBLY

Replaces 4.3L Vortec V-6 (1996-Up) with screw in rocker arm studs (non-adjustable valve train), 8 intake manifold mounting bolts, center mount valve cover. NOTE: not for use with engines using factory roller rocker arms.



18-4495
CYLINDER HEAD ASSEMBLY

Replaces: 986086,988163,3854339
Fits: (1986& Up) 5.0L Ford with D-shape 58 cc combustion chamber



18-4501
CYLINDER HEAD

Fits: 5.0L Vortec



18-4502
CYLINDER HEAD
High Performance

Aluminum cylinder head sold in pairs only. This utilizes a 185cc intake runner/62cc exhaust runner and 2.02/1.60 stainless valves placed in a 72cc combustion chamber.
Fits: 5.7, 6.2L GM small block V-8



18-1400
HYDRAULIC LIFTER
 Replaces: 3856127
 GM 4.3L/V-6 Late/5.0L/5.7L



18-1401
HYDRAULIC LIFTER
 Replaces: 3853847, 985316
 Ford 5.0L & 5.8L



18-1402
HYDRAULIC LIFTER
 Replaces: 3854033, 502036
 GM 2.5L/120
 For: OMC & Volvo 3.0L/181 CID

ALL PISTONS ARE SUPPLIED COMPLETE WITH PISTON RINGS AND WRIST PIN.



RINGS (Cont.)

STD	REPLACES OMC / VOLVO
18-3944	370409
.020	
18-3939	3854252
18-3939	914556
.030	
18-3938	*14089026
18-3938	328516
18-3938	914557

RINGS

STD	REPLACES OMC / VOLVO
18-3937	*14089025
18-3937	328506
18-3937	3853960
18-3937	914555
18-3937	3853268
18-3937	985083, 986336
18-3940	328536

PISTONS

18-4161	3853340
	914816
18-4173	*14077948
18-4173	3911020
.020	
18-4160	3853477, 915236
.030	
18-4164	*14077949
	3911023

* OMC References GM Number

PISTON/ RING APPLICATION

Model	PISTONS			RINGS			Qty. Per Eng.
	Std.	.020	.030	Std.	.020	.030	
OMC							
GM							
2.5L/153 CID	18-4180	18-4183	-	18-3942	-	-	4
3.0L/181 CID	18-4161	18-4160	18-4191	18-3937	18-3939	18-3938	4
1-6/250 CID	-	-	-	18-3942	-	-	6
4.3L/V-6	18-4173	18-4188	18-4164	18-3937	18-3939	18-3938	6
5.0L/305 CID	-	-	18-4178	18-3944	-	-	8
5.7L/350 CID	18-4173	18-4188	18-4164	18-3937	18-3939	18-3938	8
7.4L/454 CID	18-4171	18-4189	18-4172	18-3940	18-3950	18-3941	8
FORD							
5.0L/302 CID	-	-	-	18-3937	18-3939	18-3938	8





ROD BEARINGS

Part #	Size
18-1308	Std.
18-1309	.010
18-1327	Std.
18-1329	Std.
18-1333	.010
18-1334	Std.
18-1337	.010
18-1341	.020

Rod bearings sold individually,
1 per rod



MAIN BEARINGS

Part #	Per Eng.	Size	Part #	Per Eng.	Size
18-1300	①	Std.	18-1316	①	.010
18-1311	①	Std.	18-1317	①	Std.
18-1315	①	Std.			

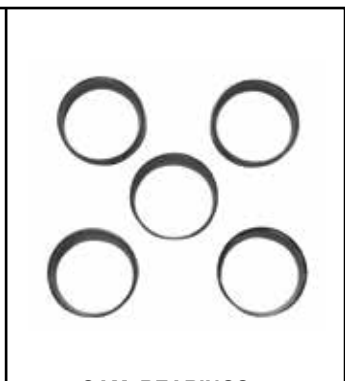

CAM BEARINGS

Part #	Per Eng.
18-1339	1 ①

① Complete engine set

BEARING APPLICATION

Model	ROD BEARING			MAIN BEARING			CAM BEARING
	Std.	.010	.020	Std.	.010	.020	

OMC							
GM							
2.5L/153 CID	18-1329	18-1330	-	18-1317	18-1316	-	18-1339
3.0L/181 CID	18-1308	18-1309	18-1341	18-1317	18-1316	-	18-1339
I-6/230 CID	18-1329	18-1330	-	-	-	-	-
I-6/250 CID	18-1308	18-1309	18-1341	-	-	-	-
4.3L/V-6	18-1327	18-1337	-	18-1311	-	-	-
5.0L/305 CID	18-1308	18-1309	18-1341	18-1300	-	-	-
5.7L/350 CID	18-1308	18-1309	18-1341	18-1300	-	-	-
7.4L/454 CID	18-1334	18-1333	18-1332	18-1315	-	-	-
FORD							
5.0L/302 CID	-	-	-	-	-	-	-



One Piece Rear Main Seals

18-1234
Replaces: 3853528

18-0519
Replaces: 3852657, 912957



Two Piece Rear Main Seals

18-0528
Replaces: 913745

18-1211
Replaces: 473424



Timing Cover Seals

18-1213
Replaces: 3853341, 912989, 914817

18-1230
Replaces: 3853827















18-1233
Replaces: 3860095

OMC SEAL APPLICATION

Engine Model	2 Piece Rear Main Crankshaft Seal Conv. Rotation (LH)	Timing Cover Seal
GM		
2.5L/153 CID	18-1211 ②	18-1213
3.0L/181 CID	18-1211 ②	18-1213
I-6/230CID	18-1211 ②	18-1213
I-6/250CID	18-1211 ②	18-1213
4.3L/V-6	18-1211 ②	18-1213
5.0L/305 CID	18-1211 ①	18-1213
5.7L/350 CID	18-1211 ①	18-1213
7.4L/454 CID	③	18-1233
FORD		
5.0L/302 CID	18-0528	
5.8L/351 CID	-	18-1230

① Large Journal Crankshaft GM Engines ② For One Piece Seal (LH) Models Use 18-0519 ③ For One Piece Seal (LH) Models Use 18-1234

MISCELLANEOUS GASKETS/GASKET SETS

 <p>18-0465 INTAKE MANIFOLD GASKET SET Replaces: 352670 For: GM 454 CID Engines, 325, 330, 340, 350 HP and 454 Magnums, 7.4L</p>	 <p>18-0153 OIL PAN GASKET SET Replaces: 393159, 458625, 357159 For: OMC 5.7L</p>	 <p>18-0340 OIL PAN GASKET SET Replaces: 508713</p>
 <p>18-1239 OIL PAN GASKET Replaces: 914820 For: OMC 3.0L</p>	 <p>18-0348 OIL PAN GASKET SET Replaces: 3931593, 508871</p>	 <p>18-1237 OIL PAN GASKET Replaces: 3856138</p>
 <p>18-0466 OIL PAN GASKET SET Replaces: 393061, 3923440, 3921473</p>	 <p>18-1238 INTAKE GASKET SET Replaces: 3850379, 912979 For: OMC 4.3L 1993-96</p>	 <p>18-1231 INTAKE GASKET Replaces: 3854095</p>
 <p>18-0405 OIL PAN GASKET Replaces: 3852655, 912955 For: OMC 4.3L</p>	 <p>18-0407 OIL PAN GASKET SET Replaces: 508872</p>	 <p>18-0410 INTAKE MANIFOLD GASKET SET Replaces: 988162, 3854406, 986103, 3853912, 986104, 3853913 For: OMC 5.0L & 5.8L (1989-96)</p>
 <p>18-0411 OIL PAN GASKET SET Replaces: 458625, 357159, 508876</p>	 <p>18-1232 OIL PAN GASKET Replaces: 3853510</p>	 <p>18-0868 INTAKE MANIFOLD GASKET SET Replaces: 985630, 3854269 For: OMC 5.7L 1994, 1996-97</p>

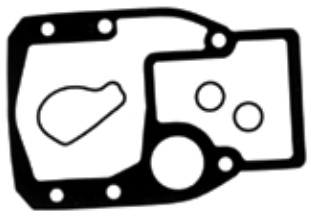

Display Package

**18-2613
OUTDRIVE GASKET SET**
Replaces: 508105

— CONTAINS —

Part #	Description	O.E. #	Qty.
18-2918	Outdrive Gasket	911836	1
18-2996	Outdrive Seal	911823	1
18-7153	O-Ring	911851	2

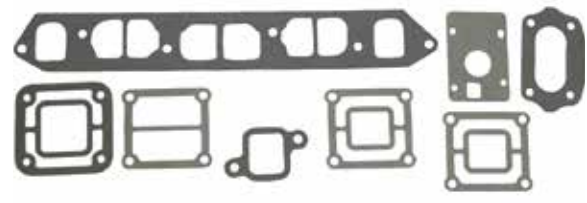

**18-4369
EXHAUST MANIFOLD
GASKET SET**
For: 2.5L (1985-86) and
3.0L (1985-88)



**18-2699
OUTDRIVE GASKET**
For: SX Drives
Use 18-3721 Mounting Nuts

— CONTAINS —

Part #	Description	O.E. #	Qty.
18-7153	O-Ring	911851	2
18-2996	Outdrive Seal	911823	1



**18-4370
EXHAUST MANIFOLD
GASKET SET**
For: 100, 120 HP and 2.5L (1965-85)

— CONTAINS —

Part #	Description	O.E. #	Qty.
18-0114	Manifold End Cap Gasket	907761	1
18-2896	Exhaust Manifold Mounting Gasket	311068	1
18-0104	Exhaust Elbow Gasket	907764	1
18-0164	Thermostat Housing Gasket	311069	1
18-0937	Carb. Mtg. Gasket	315055	1
18-2861	Manifold End Cap Gasket	311121	3
18-2875	Elbow To Manifold Gasket	908013	1
18-2858	Thermostat Cover Housing Gasket	314809	1



**18-4408
INTAKE MANIFOLD GASKET SET**
Replaces: 912978
For: GM 4.3L

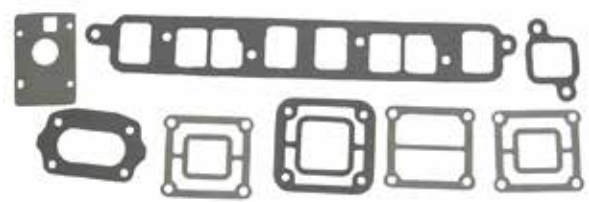

**18-4371
EXHAUST MANIFOLD GASKET SET**
For: 140 HP and 3.0L (1973-84)

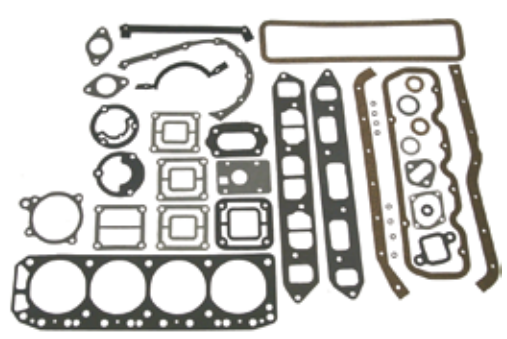

**18-4373
OVERHAUL GASKET SET**
For: 110, 120 HP and 2.5L (1965-86)

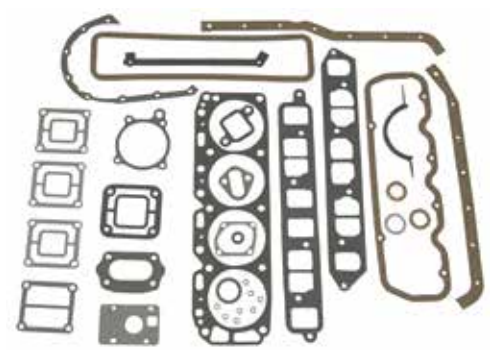



















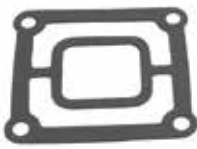

**18-4374
OVERHAUL GASKET SET**
For: 140 HP and 3.0L (1973-88)















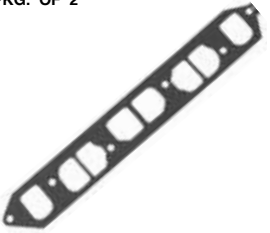





 <p>18-2946 HEAD GASKET Replaces: 3853336, 908611 For: GM 181 (3.0L) CID Eng.</p>	 <p>18-3874 HEAD GASKET Replaces: 3853511 For: (8.2L) 502 CID</p>	 <p>18-3876 HEAD GASKET Replaces: 3853380, 914971 For: GM 305 (5.0L)/350 (5.7L) CID Eng.</p>	 <p>18-3877 HEAD GASKET Replaces: 914849 For: GM 454 (7.4L) CID Eng.</p>
 <p>18-3878 HEAD GASKET Replaces: 912766 For: Mercruiser 224 (3.7L) CID Eng. Model 470</p>	 <p>18-3879 HEAD GASKET Replaces: 3854299, 912227, 914930 For: GM 262 (4.3L) CID Eng.</p>	 <p>18-3880 HEAD GASKET Replaces: 311210 For: GM 153 (2.5L), (3.0L) CID Eng.</p>	 <p>18-3881 HEAD GASKET Replaces: 908237 For: GM 250 (4.1L) CID (6 cyl) Eng.</p>
 <p>18-3883 HEAD GASKET Replaces: 3853732 For: Ford 302 (5.0L) 351 (5.8L) CID Eng.</p>	 <p>18-3887 HEAD GASKET Replaces: 915325 For: (7.4L) 454 CID GEN V</p>	 <p>18-0434 CARB MOUNTING GASKET Replaces: 909758</p>	<p>PKG OF 2</p>  <p>18-5399 18-5399-9① DISTRIBUTOR CAP GASKET Replaces: 910169</p>
<p>PKG. OF 2</p>  <p>18-0874 18-0874-9① DISTRIBUTOR GASKET For GM V6 & V8 Replaces: 3852109, 312780 For: 2.6L (1989), 3.5L (1989), 4.3L (1987-93), 5.0L (1987-88), 5.7L (1987-92), 7.4L (1988-93), 8.2L (1992-93)</p>	<p>PKG. OF 2</p>  <p>18-0937 18-0937-9① CARB MOUNTING GASKET Replaces: 315055</p>	 <p>18-0435 CARB MOUNTING GASKET Replaces: 908765</p>	<p>PKG. OF 2</p>  <p>18-0876 18-0876-9① FUEL PUMP GASKET For GM 4.3L, 5.0L & 5.7L Replaces: 3852113, 312800</p>
<p>PKG. OF 2</p>  <p>18-0164 18-0164-9① THERMOSTAT GASKET 4 & 6 Cyl. Replaces: 311069 GM 3789161</p>	<p>PKG. OF 2</p>  <p>18-0929 18-0929-9① THERMOSTAT GASKET Replaces: 313416</p>	<p>PKG. OF 2</p>  <p>18-2858 18-2858-9① THERMOSTAT GASKET Replaces: 314809</p>	<p>PKG. OF 2</p>  <p>18-2917 18-2917-9① THERMOSTAT GASKET Replaces: 312797, 3701777 (GM)</p>

SEE PAGES 166-167 FOR OUR COMPLETE LINE OF GASKET SEALANTS

① Priced per Package

<p>PKG. OF 2</p>  <p>18-2947 18-2947-9① THERMOSTAT GASKET Replaces: 310913</p>	<p>PKG. OF 2</p>  <p>18-0104 18-0104-9① EXHAUST ELBOW GASKET Replaces: 907764</p>	<p>PKG. OF 2</p>  <p>18-0114 MANIFOLD END GASKET Replaces: 907761 For GM 4 Cyl.</p>	<p>PKG. OF 2</p>  <p>18-4431 18-4431-9① EXHAUST ELBOW GASKET Replaces: 913783</p>
 <p>18-0430 EXHAUST ELBOW GASKET Replaces: 912477</p>	<p>PKG. OF 2</p>  <p>18-0673 18-0673-9① EXHAUST ELBOW GASKET Replaces: 910113</p>	<p>PKG. OF 2</p>  <p>18-0943-1 18-0943-1-9① EXHAUST ELBOW GASKET Replaces: 909786, 3850496</p>	<p>PKG. OF 2</p>  <p>18-2850 18-2850-9① MANIFOLD END CAP GASKET Replaces: 908935</p>
<p>PKG. OF 2</p>  <p>18-2859 18-2859-9① MANIFOLD END CAP GASKET Replaces: 311131</p>	<p>PKG. OF 2</p>  <p>18-2860 18-2860-9① MANIFOLD END CAP GASKET Replaces: 311130</p>	<p>PKG. OF 2</p>  <p>18-2861 18-2861-9① MANIFOLD END CAP GASKET Replaces: 311121</p>	<p>PKG. OF 2</p>  <p>18-2875 18-2875-9① EXHAUST ELBOW GASKET Replaces: 908013, 3850495</p>
<p>PKG. OF 2</p>  <p>18-2883-1 18-2883-1-9① MANIFOLD END CAP GASKET Replaces: 907775</p>	 <p>18-2541 RUBBER SEAL Replaces: 911704</p>	 <p>18-0401 EXHAUST MANIFOLD GASKET Replaces: 913393 For Ford 140 CID (2.3L)</p>	 <p>18-0431 INTAKE MANIFOLD GASKET Replaces: 912471 For Ford 140 CID (2.3L)</p>
 <p>18-0956 EXHAUST MANIFOLD GASKET Replaces: 912405 460 CID</p>	 <p>18-2912 EXHAUST MANIFOLD GASKET Replaces: 908079</p>	<p>PKG. OF 2</p>  <p>18-2830 EXHAUST MANIFOLD GASKET Inline 6 cyl. Replaces: 907932</p>	 <p>18-2896 EXHAUST MANIFOLD GASKET Replaces: 311068</p>

① Priced per Package

<p>PKG. OF 2</p>  <p>18-2909 18-2909-9① EXHAUST MANIFOLD GASKET Replaces: 915025 GM V-6</p>	 <p>18-0183 EXHAUST MANIFOLD GASKET Replaces: 3853742, 3852455, 908717, 916262 For: OMC 5.0L & 5.8L (1993-96)</p>	 <p>18-0680 EXHAUST MANIFOLD GASKET Replaces: 3853256, 914578</p>	 <p>18-0418 EXHAUST MANIFOLD GASKET Replaces: 909613</p>
<p>PKG. OF 2</p>  <p>18-1204 18-1204-9① EXHAUST MANIFOLD GASKET Replaces: 912164</p>	 <p>18-0892 DEFLECTOR HOSE Replaces: 322411</p>	 <p>18-0664 VALVE COVER GASKET Replaces: 913270, 3852687 For: GM 305/350, 5.0 & 5.7L</p>	 <p>18-2845 VALVE COVER GASKET Replaces: 912965 For GM 305/350 CID (5.0L and 5.7L)</p>
 <p>18-0311 VALVE COVER GASKET Replaces: 3854942 For: 4.3 Litre 262 CID</p>	 <p>18-0346 VALVE COVER GASKET Replaces: 3930912 For: GM 250 CID (4.1L), 160/165/200 (6 cyl.)</p>	 <p>18-0347 VALVE COVER GASKET Replaces: 3852693, 912981, 913277 For: GM 153 & 181 CID (2.5L & 3.0L)</p>	<p>PKG. OF 2</p>  <p>18-0464 18-0464-9① VALVE COVER GASKET Replaces: 912768 For: GM 454/502 CID (7.4L & 8.2L)</p>
 <p>18-0352 VALVE COVER GASKET Replaces: 913758 For: Ford 302/351 CID (5.0L & 5.8L)</p>	 <p>18-0548 ADAPTER TO INTERMEDIATE HOUSING GASKET Replaces: 909515</p>	<p>PKG. OF 2</p>  <p>18-0947 18-0947-9① PIVOT CAP COVER GASKET Replaces: 909529</p>	<p>PKG. OF 2</p>  <p>18-0440 18-0440-9① WATER PASSAGE GASKET Replaces: 915719</p>
 <p>18-0911 WATER PUMP GASKET Replaces: 911698</p>	<p>PKG. OF 2</p>  <p>18-0903 WATER PUMP GASKET Replaces: 3853361 454 CID</p>	 <p>18-0147 WATER PUMP GASKET For Ford V-8 Replaces: 3852824</p>	 <p>18-0327 WATER PUMP GASKET Replaces: 3853342 4 & 6 Cyl.</p>

① Priced per Package

<p>PKG. OF 2</p>  <p>18-2916 18-2916-9① WATER PUMP HOUSING GASKET Replaces: 911702</p>	 <p>18-0939 18-0939-9① UPPER GEARCASE DIPSTICK GASKET Replaces: 315189</p>	 <p>18-0468 TIMING COVER GASKET Replaces: 3853512, 912954, 3852654, 915326 For: OMC 2.6L, 3.5L (1989), 4.3L (1987-93), 5.0L (1987-88), 5.7L (1987-92, 1994, 1996)</p>	<p>PKG. OF 2</p>  <p>18-0891 18-0891-9① WATER PUMP MOUNTING GASKET Replaces: 3852477, 909835 For: GM 4.3L, 5.0L & 5.8L</p>
<p>PKG. OF 2</p>  <p>18-0893 18-0893-9① WATER PUMP BACK-IN PLATE GASKET Replaces: 3850595 GM 4.3L, 5.0L & 5.7L</p>	<p>PKG. OF 2</p>  <p>18-0322 18-0322-9① REAR SEAL GASKET Replaces: 3852656 GM 5.0L & 5.7L</p>	 <p>18-0329 PUSH ROD/LIFTER COVER GASKET</p>	<p>PKG. OF 2</p>  <p>18-0887 18-0887-9① TIMING COVER GASKET Replaces: 3852691, 912988, 913275 4 & 6 Cyl.</p>
 <p>18-0980 TIMING COVER GASKET Replaces: 3935449 GM 7.4L</p>	<p>PKG. OF 2</p>  <p>18-0880 18-0880-9① SHIFT COVER GASKET Replaces: 911878</p>	<p>PKG. OF 2</p>  <p>18-0166 18-0166-9① GROMMET Replaces: 911705</p>	 <p>18-2815 PUSH ROD COVER GASKET Replaces: 3852692, 913276 For: 3.0L</p>
 <p>18-0190 WIPER GASKET Replaces: 912157</p>	<p>PKG. OF 2</p>  <p>18-2851 18-2851-9① SWIVEL BEARING GASKET Replaces: 313368</p>	<p>PKG. OF 2</p>  <p>18-2863 18-2863-9① TILT CLUTCH COVER GASKET Replaces: 308799</p>	<p>PKG. OF 2</p>  <p>18-2911 18-2911-9① SWIVEL BEARING HOUSING GASKET Replaces: 910236</p>

① Priced per Package

<p>PKG. OF 5</p>  <p>18-2918 18-2918-9① OUTDRIVE GASKET Replaces: 911836, 915840</p>	<p>PKG. OF 5</p>  <p>18-2996 18-2996-9① OUTDRIVE SEAL Replaces: 911823, 3852560</p>	<p>PKG. OF 2</p>  <p>18-0923 18-0923-9① RUBBER SEAL Replaces: 313244</p>	<p>PKG. OF 2</p>  <p>18-0188 18-0188-9① WASHER Replaces: 909748</p>
 <p>18-2387 18-23871-9① (PKG. OF 50) LOWER UNIT DRAIN SCREW Replaces: 307551 Fits: OMC V-6, V-4(1979 & Up), 60-75hp 3 cylinder, 20-35hp (1985-97)</p>	 <p>18-1236 DRAIN SCREW Replaces: 309243 For Cobra Drives & V-6 40-50HP (1989-97)</p>	 <p>18-2378 18-23781-9① (PKG. OF 50 without washer) MAGNETIC DRAIN SCREW Replaces: 318544 Fits: Cobra 2.3, 3.0, 3.8 & 5.8L (1986-92), V-6, V-4(1979 & Up), 60-75hp 3 cyl, 40/50hp (1989-98)</p>	<p>PKG. OF 5</p>  <p>18-4253-9① 18-42531-9① (PKG. OF 50) DRAIN SCREW O-RING Replaces: 336982 Used w/ 18-1236 Drain Screw</p>
<p>PKG. OF 2</p>  <p>18-2945 18-2945-9① DRAIN SCREW GASKET Replaces: 307552</p>	 <p>18-8369 OIL INDICATOR WITH WASHER Replaces: 914488 Fits: OMC Cobra (1986-93) without cone clutch</p>	<p>PKG. OF 5</p>  <p>18-4248 18-4248-9① 18-42481-9① (PKG. OF 50) DRAIN/FILL PLUG WASHER (Plastic) Replaces: 311598</p>	<p>PKG. OF 5</p>  <p>18-4250 18-4250-9① WASHER Replaces: 911820</p>
 <p>18-0549 PLUG OFF CAP Replaces: 909829 I.D. 1" For V-8 Model Stern Drives and Inboards (1977 to present)</p>	 <p>18-0550 PLUG OFF CAP Replaces: 909830 I.D. 1 1/4" For V-8 Model Stern Drives and Inboards 1977 to present</p>	 <p>18-0518 VALVE STEM SEAL Replaces: 3854956, 914323, 3853132 For: most inline 4 and 6 cyl. GM (Early) and 305-350 CID GM</p>	<p>PKG. OF 8</p>  <p>18-4024 18-4024-9① VALVE STEM SEAL Replaces: 3853226, 914445 For: Chevy 4.3L/5.0L/5.7L</p>

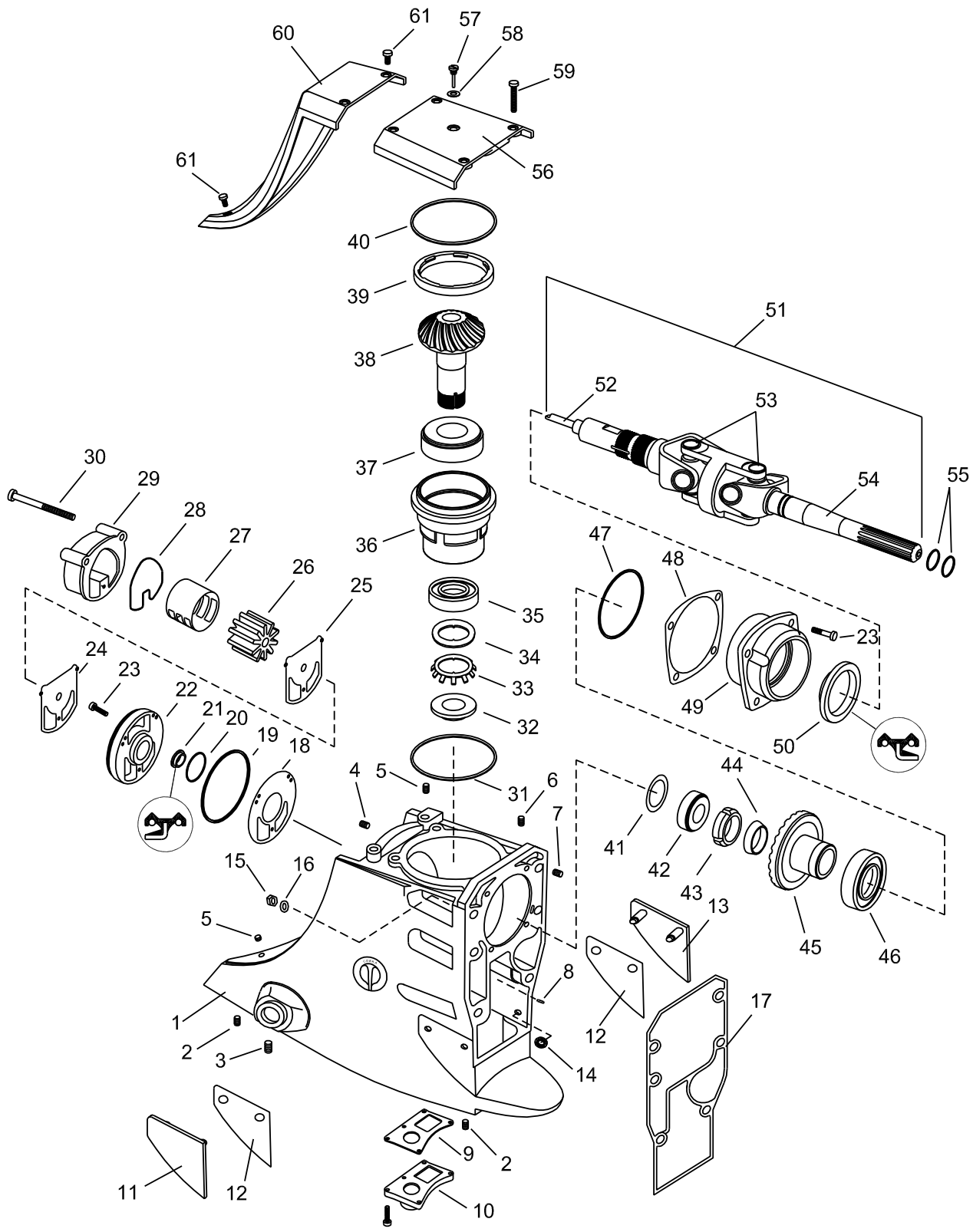

Figure #	Description	Part #	O.E.M. #	Qty.	Figure #	Description	Part #	O.E.M. #	Qty.
1	Upper Gear Housing, Basic w/ Inserts	~	984518	1	32	Pinion Nut	18-3769	911753	1
					33	Nut Retainer	18-3610	911752	1
2	Gearcase Insert	NSS	910935	5	34	Pinion Washer	NSS	911697	1
3	Gearcase Insert	NSS	911779, 3852541	5	35	Pinion Bearing, Lower	18-1170	983892	1
					36	Bearing Carrier, Pinion	18-4828	911750	1
4	Gearcase Insert	NSS	910901	5	37	Pinion Bearing, Upper	18-1161	983891	1
5	Gearcase Insert	NSS	911858, 3852567	3	38	Gear Set, 21:16 (includes 38 & 45)	18-1600	983825	AR
					38	Gear Set, 21:18 (includes 38 & 45)	18-1601	983826	AR
6	Gearcase Insert	NSS	910901	4	38	Gear Set, 21:19 (includes 38 & 45)	18-1602	984012	AR
7	Gearcase Insert	NSS	910901	4					
8	Shift Rod Guide	NSS	912137	1	39	Retainer Ring, Pinion Housing	18-3768	911751	1
9	Gasket, Water Passage Cover	18-0884	911733	1	40	O-Ring, Gear Housing Cover	18-7107	313175	1
10	Water Passage Cover	18-4837	911734	1					
11	Thrust Plate, Starboard	NSS	911838, 3852562	1	41	Shim, Gear Position, 0.003"	18-02062	911662	AR
					41	Shim, Gear Position, 0.005"	18-02063	911663	AR
12	Shim, Thrust Plate, 0.015"	18-1713	911839, 3852563	AR	41	Shim, Gear Position, 0.007"	18-02064	911664	AR
					41	Shim, Gear Position, 0.010"	18-02065	911665	AR
13	Thrust Plate, Port	NSS	911837, 3852561	1	41	Shim, Gear Position, 0.012"	18-02066	911666	AR
					41	Shim, Gear Position, 0.015"	18-02067	911667	AR
14	Retainer Ring, Thrust Plate	NSS	910953	4	42	Bearing, U-Joint Shaft	18-1171	983878	1
15	Nut	18-3730	912920, 3852648	6	43	Nut, Gear to U-Joint	18-3770	911937	1
					44	Centering Cone	18-4835	912029	1
16	Washer	NSS	911833	6	45	Gear Set, 21:16 (includes 38 & 45)	18-1600	983825	AR
17	Gasket, Outdrive Mounting	18-2918	911836, 915840	1					
18	Gasket, Adapter to Gear Housing	18-0911	911698	1	45	Gear Set, 21:18 (includes 38 & 45)	18-1601	983826	AR
19	O-Ring, Adapter, Large	18-7407	911700	1					
20	O-Ring, Adapter, Small	18-7403	909316	1	45	Gear Set, 21:19 (includes 38 & 45)	18-1602	984012	AR
21	Water Pump Shaft Seal	18-2068	911701, 915702, 916058, 3853655	1					
22	Adapter, Water Pump to Gear Housing	18-4836	911699	1	46	Bearing, Bearing Carrier	18-1172	983877	1
					47	O-Ring, Bearing Carrier	18-7169	911686	1
23	Screw	18-1598	908668, 341013	6	48	Shim, Bearing Carrier, 0.003", Green	18-0227	911678	AR
					48	Shim, Bearing Carrier, 0.004", Tan	18-0229	911679	AR
24	Gasket, Plate to Adapter	18-2916	911702	1	48	Shim, Bearing Carrier, 0.005", Blue	18-02060	911680	AR
					48	Shim, Bearing Carrier, 0.010", Brown	18-02061	911681	AR
25	Plate, Water Pump	18-3121	911703	1	49	Gear Bearing Carrier	18-4838	911683	1
26	Impeller	18-3058	983895, 777128	1	50	Seal, Bearing Carrier	18-2067	911685	1
27	Liner, Water Pump Cover	18-3145	911844	1	51	U-Joint & Water Pump Shaft Assy	18-2338	983880	1
28	Seal, Water Pump Housing	18-2541	911704	1					
29	Impeller Housing	18-3206	984744	1	52	Stub & Water Pump Shaft	18-6399	984264	1
30	Screw	NSS	912238	3	53	U-Joint Assy	18-2104	912214	2
31	Shim, Bearing Carrier 0.001	18-0209	911669, 911670, 611671, 911672, 911673, 911674, 911675, 911676, 911677	AR	54	Yoke Shaft	18-2146	912212	1
					55	O-Ring, U-Joint Shaft	18-7153	911851, 3852565	2
					56	Gear Housing Cover	18-4838	911845, 986363	1
					57	Oil Indicator	18-8369	914488	1
					58	O-Ring, Oil Indicator	18-7116	303067	1
					59	Screw, Gear Housing Cover	18-1599	123018	4
					60	Cover, Water Pump Access	18-4750	983967	1
31	Shim, Bearing Carrier 0.003	18-0211	911669, 911670, 611671, 911672, 911673, 911674, 911675, 911676, 911677	AR	61	Screw, Water Pump Access Cover	18-4749-9	911859, 3852568	3
						Water Pump Repair Kit w/housing	18-3348	984461, 984744	1

AR As required

NSS Not Sold Separate



SCREWS

Part No.	OE No.	Application
18-1280	317763	115-235 HP (1980-87) Cobra Drives (w/O-Ring)
18-1598	341013	Fits: OMC Cobra (1986-93) without cone clutch
18-1599	123018	Fits: OMC Cobra (1986-93) without cone clutch
18-3135	306643	Cobra Drives
18-4749-9 ①	3852568	For Cover Assembly: (3 Pack) Fits: 2.3L (1987-90), 2.5L (1986), 2.6L (1989), 3.0L (1986-93), 4.3L (1986-93), 5.0L (1986-94), 5.7L (1986-92), 5.8L (1989-93), 7.4L (1988)

① PKG of 3, priced per package

GEAR HOUSINGS

Part No.	OE No.	Description	Application
18-4804	984770, 986381	Upper Gear Housing Complete, 21: 16 Ratio	5.7L(1986-93), 5.8L(1986-89,1991-93)
18-4805	984771, 986382	Upper Gear Housing Complete, 21: 18 Ratio	2.5L (1986-89),3.0L(1986-93),5.0L(1989-93)
18-4806	984765, 986380	Upper Gear Housing Complete, 21: 19 Ratio	4.3L, 3.0L high altitude OMC Cobra (1986-93)



SHIMS

Part No.	O.E. No.	Size	Part No.	O.E. No.	Size
18-0207 ①	911668	0.010	18-02064 ①	911664	0.007
18-0209 ①	911669, 911670, 911671, 911672, 911673, 911674, 911675, 911676, 911677	0.001	18-02065 ①	911665	0.010
18-0211 ①	911669, 911670, 911671, 911672, 911673, 911674, 911675, 911676, 911678	0.003	18-02066 ①	911666	0.012
			18-02067 ①	911667	0.015
			18-2229	323362	0.003
			18-2230	323361	0.004
18-2231	314745	0.005			
18-0227 ① ②	911678	0.003	① Fits: OMC Cobra (1986-93) without cone clutch		
18-0229 ① ③	911679	0.004	② Green		
18-1713 ①	3852563	0.015	③ Tan		
18-1718 ⑥	-	Kit	④ Blue		
18-02060 ① ④	911680	0.005	⑤ Brown		
18-02061 ① ⑤	911681	0.010	⑥ Kit includes 1 each of 18-2229, 18-2230 & 18-2231		
18-02062 ①	911662	0.003	NOTE: For shim sizes larger than .010" use shim 18-0207 and appropriate combination of .001" shim (18-0209), and .003" shim (18-0211) to reach desired shim thickness.		
18-02063 ①	911663	0.005			



18-9876 SHIM GAUGE TOOL
Replaces: 349957



18-4442 ENGINE ALIGNMENT TOOL
Used to verify engine alignment on Cobra models.

MARINE GRADE 316 STAINLESS STEEL WORM GEAR HOSE CLAMPS



All components are manufactured from Marine Grade 316 stainless steel. These clamps are designed to fit many applications from 5/16" to 7" diameter hoses.

STAINLESS STEEL CLAMPS

Part #	Diameter Size	Std. #	Part #	Diameter Size	Std. #
18-7307	5/16" to 7/16"	006	18-7313	1 3/16" to 2 1/2"	032
18-7308	9/16" to 1 1/16"	010	18-7314	2 9/16" to 3 1/2"	048
18-7309	5/8" to 1 1/4"	012	18-7315	2 1/2" to 4 1/2"	064
18-7310	1 1/16" to 1 1/2"	016	18-7316	3" to 5"	072
18-7311	3/4" to 1 3/4"	020	18-7317	5" to 7"	104
18-7312	1 1/16" to 2"	024			



18-2100 LINK BELT HEAVY DUTY GIMBAL BEARING
Replaces: 983937
Fits all OMC Cobra and King Cobra Drives



18-3763 SHIFT SHAFT
Replaces: 322941
For: V-4/V-6, Cobra, Stringer



18-2337 STUB SHAFT
Replaces: 3850814
Fits: All Cobra 1994-Up except King Cobra



18-6399
SHAFT & STUB ASSEMBLY
 Replaces: 984264
 For: Cobra Drives- 232, 302(1986-90), 252(1986), 262, 350, 460(1989), 432, 434, 502(1986-92), 504(1986-88), 574(1986-92), 584(1989-93), 754(1987-88)



18-2104
U-JOINT
 Heavy Duty
 Replaces: 912214, 915716
 Fits OMC Cobra Drives (1986-89) Includes straight grease fitting and 90° fitting (Rockwell)



18-2174
U-JOINT
 Heavy Duty
 Replaces: 915717, 3850812
 Fits OMC Cobra and King Cobra Drives (1990 & ABOVE) Includes straight grease fitting and 90° fitting. (Rockwell)



18-2338
U-JOINT
 Replaces: 983880
 For: 1986-93 OMC Cobra



18-2339
U-JOINT ASSEMBLY
 Replaces: 3852384
 Fits: All Cobra 1994-Up except King Cobra



18-2146
UNIVERSAL YOKE ASSEMBLY
 Replaces: 912212, 3850815
 For: All Cobra (1986-Up)



18-3770
U-JOINT NUT
 Replaces: 911937
 For: 232, 252, 262, 302, 350, 432, 434, 460, 502, 504, 574, 584, 744, 754, (1987-93)

Year	Model		U-joint #	U-joint Assy. OE #	Long Yoke #	Long Yoke OE #	Short Yoke #	Short Yoke OE #
1986	2.3L, 3.0L, 4.3L, 5.7L	②	18-2338	983880	18-2146	912212	18-6399	984264
1987-88	2.3L, 3.0L, 4.3L, 5.0L, 5.7L, 7.5L	②	18-2338	983880	18-2146	912212	18-6399	984264
1989	2.3L, 3.0L, 4.3L, 5.0L, 5.7L, 5.8L, 7.5L	②	18-2338	983880	18-2146	912212	18-6399	984264
1990	2.3L, 3.0L, 4.3L, 5.0L, 5.7L, 5.8L	②	18-2338	983880	18-2146	912212	18-6399	984264
1990	5.7L, 7.4L, 7.5L	③	N/A	986191	18-2146	912212	N/A	914646
1991	3.0L, 4.3L, 5.7L, 5.8L	②	18-2338	983880	18-2146	912212	18-6399	984264
1991	7.4L	③	N/A	986191	18-2146	912212	N/A	914646
1992-93	3.0L, 3.2L, 4.3L, 5.0L, 5.7L, 5.8L	②	18-2338	983880	18-2146	912212	18-6399	984264
1992-93	3.0L, 3.2L, 4.3L, 5.0L, 5.7L, 5.8L, 7.4L, 8.2L	③	N/A	986191	18-2146	912212	N/A	914646
1994	3.0L, 4.3L, 5.0L, 5.7L, 5.8L	①③	18-2339	3852384	18-2146	3850815	18-2337	3850814
1994	5.8L, 7.4L	③④	N/A	3853937	18-2146	3850815	N/A	3853563
1995	3.0L, 4.3L, 5.0L, 5.8L	③	18-2339	3852384	18-2146	3850815	18-2337	3850814
1995	7.4L	③	N/A	3853937	18-2146	3850815	N/A	3853563
1996	3.0L, 4.3L, 5.0L, 5.7L, 5.8L, 7.4L	③	18-2339	3852384	18-2146	3850815	18-2337	3850814
1997	3.0L, 4.3L, 5.7L, 7.4L	③	18-2339	3852384	18-2146	3850815	18-2337	3850814
1998	3.0L, 4.3L, 5.0L, 5.7L, 7.4L, 8.2L	③	18-2339	3852384	18-2146	3850815	18-2337	3850814

① Excludes Model 58FBPMDA ② Used where raw w/p is located on outdrive ③ Used where raw w/p is located on engine ④ Includes Model 58FBPMDA



18-2772-1
TRANSOM SEAL KIT
 For: SX Cobra Drives with cone clutch

— CONTAINS —

Part #	Description	O.E. #	Qty.
18-2100	Gimbal Bearing	3853807	1
18-2765	Bellows	3854127	1
18-1074	Bellows	3850426-2	1
18-2996	Seal	3852560, 911823	1
18-7315	Hose Clamp	853012-3	1



18-2771
BELLOWS KIT
 For: OMC Cobra without cone clutch

— CONTAINS —

Part #	Description	O.E. #
18-2613	Outdrive Gasket Set	—
18-2765	U-Joint Bellows	983973, 987467
18-2764	Exhaust Bellows	914036
18-2763	Shift Cable Bellows	911826
18-2100	Gimbal Bearing	983937
18-7315	Hose Clamp	—



**18-2128
CENTER SOCKET**
Replaces:
912213, 3850813
Fits all OMC Cobra



**18-2745
EXHAUST BOOT**
Replaces: 912374
Fits 5.7L & 7.5L (1986 & later)



**18-1074
EXHAUST BELLOW**
Replaces: 3850426
All cone clutch models (1994-up)
not using exhaust boot



**18-2763
SHIFT CABLE
BELLOWS**
Replaces: 911826
ALL COBRA



**18-2764
EXHAUST BELLOWS**
Replaces: 914036
All clutch dog Cobra models
(1986-93)



**18-2765
U-JOINT BELLOWS**
Replaces: 983973,
987467, 3854127
All clutch dog Cobra models (1986-93)



**18-21754
ENGINE COUPLER**
Replaces: 986232, 984537
Fits: 7.5L / 460 King Cobra 1987-90



**18-21751
ENGINE COUPLER**
Replaces: 3853962,
983902, 986338
Fits: 2.5L (1986), 3.0L (1986-90), (4.3L,
5.0L, 5.7L) (1986) KW & KWB suffix only,
7.4L (1990-98), 8.2L (1992-93, 1998)



**18-21752-1
ENGINE COUPLER**
Replaces: 3858437, 984290,
986120, 3853917
Fits: 4.3L (1986-98), 5.0L (1986-88, 1998)
5.7 (1986-92, 1994, 1996-98)



**18-21753
ENGINE COUPLER**
Replaces: 3853862
Fits: 5.0L & 5.8L (1989-96)



**18-21755
ENGINE COUPLER**
Replaces: 984629
2.3L Cobra



**18-2533
TRANSOM SEAL**
Replaces: 911797



**18-2767
TRANSOM SEAL**
Replaces: 313080
(1967-77) 120 HP and UP



**18-2768
TRANSOM SEAL**
Replaces: 909527
(1978-86) — ALL



**18-2245-1
SHIFT CABLE
ASSEMBLY**
Replaces: 987661
For: 1988-1993 OMC Cobra (except King)
without cone clutch



**18-2246
SHIFT CABLE ASSEMBLY**
Replaces: 987678
For: King Cobra



**18-2178
BALL GEAR KIT**
(1973-86)

— CONTAINS —

Part #	Desc.	O.E. #	Qty.	Part #	Desc.	O.E. #	Qty.
18-7121	O-Ring	308621	1	18-3725	Locknut	908064	2
18-4251	Plug	908062	2	18-7401	O-Ring	908383	1
18-2176	Ball Gear	908063	1	18-2071	Oil Seal	981195	2
18-2177	Ball Gear	908069	1	18-2072	Oil Seal	981196	2

 <p>18-2176 BALL GEAR (Intermediate Housing) Replaces: 908063 (1973-86)</p>	 <p>18-2177 BALL GEAR (Upper Gearcase) Replaces: 908069 1973-86</p>	 <p>18-3769 PINION NUT Replaces: 911753 For: 115 (1994-97), 232 (1987-90), 252 (1986), 262, 350, 460 (1989), 302, 574 (1986-92), 432 (1986-93), 502 (1988-93), 504, 754 (1986-88), .584 (1989-93), 744 (1988), 90 Jet (1994-95)</p>	 <p>18-3719 PINION NUT Replaces: 314730 (⁵/₈ - 18)</p>	
<p>PKG. OF 5</p>  <p>18-3725 18-3725-9① BALL GEAR NUT Replaces: 908064</p>	<p>PKG. OF 2</p>  <p>18-3731 18-3731-9① LOCKNUT Replaces: 907866 ³/₄ - 16</p>	<p>PKG. OF 5</p>  <p>18-4251 18-4251-9① PLUG Replaces: 908062 O.D. 1.748</p>	 <p>18-4835 CENTERING CONE Replaces: 912029 Fits: OMC Cobra (1986-93) without cone clutch</p>	 <p>18-1154 BALL BEARING Replaces: 377139</p>
 <p>18-1161 TAPERED ROLLER BEARING Replaces: 983891</p>	 <p>18-1170 LOWER PINION BEARING Replaces: 983892</p>	 <p>18-1171 U-JOINT SHAFT BEARING Replaces: 983878</p>	 <p>18-1172 CARRIER BEARING Replaces: 983877 For: 1986-95 Cobra</p>	
 <p>18-1158 CARRIER BEARING Replaces: 387247</p>	 <p>18-1350 CARRIER BEARING Replaces: 379504</p>	 <p>18-1351 CARRIER BEARING Replaces: 382407 COBRA</p>	 <p>18-1117 PINION BEARING Replaces: 387817</p>	 <p>18-1357 PINION BEARING Replaces: 384195 COBRA</p>
 <p>18-1358 REVERSE GEAR BEARING Replaces: 389039 COBRA</p>	 <p>18-1365 THRUST BEARING Replaces: 387656 COBRA DRIVE SHAFT</p>	 <p>18-1366 THRUST BEARING Replaces: 382408 COBRA REVERSE GEAR</p>	 <p>18-1370 THRUST FORWARD BEARING Replaces: 389042</p>	 <p>18-1371 THRUST FORWARD BEARING Replaces: 385043 COBRA</p>



① Priced per Package



OMC 400 & 800 SERIES GEARCASE BEARINGS

HP	Year	Pinion Bearing	Drive Shaft Bearing	Carrier Aft Bearing	Carrier Fore Bearing	Forward Thrust Bearing	Reverse Thrust Bearing	Housing Bearing
120	1978-81	18-1357	18-1365	18-1350	18-1351	18-1371	18-1366	—
2.5L	1982-86	18-1357	18-1365	18-1350	18-1351	18-1371	18-1366	18-1351
140	1978-81	18-1357	18-1365	18-1350	18-1351	18-1371	18-1366	—
3.0L	1982-86	18-1357	18-1365	18-1350	18-1351	18-1371	18-1366	18-1351
185/3.8L	1978-85	18-1117	18-1365	18-1158	18-1351	18-1370	18-1366	18-1358
4.3L	1985-86	18-1117	18-1365	18-1158	18-1351	18-1370	18-1366	18-1358
200/5.0L	1979-86	18-1117	18-1365	18-1158	18-1351	18-1370	18-1366	18-1358
225	1978	18-1117	18-1365	18-1158	18-1351	18-1370	18-1366	18-1358
230/530L	1979-86	18-1117	18-1365	18-1158	18-1351	18-1370	18-1366	18-1358
240	1978	18-1117	18-1365	18-1158	18-1351	18-1370	18-1366	18-1358
250	1979	18-1117	18-1365	18-1158	18-1351	18-1370	18-1366	18-1358
260/5.7L	1979-86	18-1117	18-1365	18-1158	18-1351	18-1370	18-1366	18-1358

OMC COBRA GEAR HOUSING BEARINGS

HP	Year	Pinion Bearing	Drive Shaft Bearing	Carrier Aft Bearing	Carrier Fore Bearing	Forward Thrust Bearing	Reverse Thrust Bearing	Housing Bearing
2.3L	1987	18-1357	18-1365	18-1350	18-1351	18-1371	18-1366	18-1351
2.3L	1988-90	18-1357	18-1365	18-1350	18-1351	18-1371	18-1366	—
2.5L	1986	18-1357	18-1365	18-1350	18-1351	18-1371	18-1366	18-1351
3.0L	1986-87	18-1357	18-1365	18-1350	18-1351	18-1371	18-1366	18-1351
3.0L	1988-89	18-1357	18-1365	18-1350	18-1351	18-1371	18-1366	—
3.0L	1990-91	18-1117	18-1365	18-1158	18-1351	18-1370	18-1366	—
3.0L/3.0L HO	1992-93	18-1117	18-1365	—	18-1351	18-1370	18-1366	—
4.3L	1986-87	18-1117	18-1365	18-1158	18-1351	18-1370	18-1366	18-1358
4.3L	1988-91	18-1117	18-1365	18-1158	18-1351	18-1370	18-1366	—
4.3L/4.3L HO	1992-93	18-1117	18-1365	—	18-1351	18-1370	18-1366	—
5.0L	1986-87	18-1117	18-1365	18-1158	18-1351	18-1370	18-1366	18-1358
5.0L	1988-91	18-1117	18-1365	18-1158	18-1351	18-1370	18-1366	—
5.0L/5.0L HO	1992-93	18-1117	18-1365	—	18-1351	18-1370	18-1366	—
5.7L	1986-87	18-1117	18-1365	18-1158	18-1351	18-1370	18-1366	18-1358
5.7L	1988-91	18-1117	18-1365	18-1158	18-1351	18-1370	18-1366	—
5.7L	1992-93	18-1117	18-1365	—	18-1351	18-1370	18-1366	—
5.8L	1989-91	18-1117	18-1365	18-1158	18-1351	18-1370	18-1366	—
5.8L	1992-93	18-1117	18-1365	—	18-1351	18-1370	18-1366	—

 18-0195 THRUST WASHER Replaces: 314731 COBRA	 18-0198 FORWARD GEAR THRUST WASHER Replaces: 324766	PKG. OF 2  18-2243 18-2243-9^① DETENT BALL Replaces: 316506 For: V-4 & V-6 gearcase OMC Sterndrive 400 Series (1978-79); 800 Series (1978)
--	--	--

 18-1501 DETENT BALL Replaces: 160084 For: Cobra drives (1980& Earlier)	 18-1732 DRIVE SHAFT RETAINER Replaces: 338504 For: V4 & V6 driveshafts
--	--

 18-1701 LOWER DRIVE SHAFT Replaces: 911693 For: Cobra Drives 262, 302, 350, 432, 434, 502, 504, 574, 584	 18-2183 DRIVE SHAFT Replaces: 909121
---	--

① Priced per Package



18-2184
DRIVE SHAFT
Replaces: 908087



18-2185
DRIVE SHAFT
Replaces: 909753



18-2186
DRIVE SHAFT
Replaces: 982424
800 Drives



18-2187
PROP SHAFT
Replaces: 395209
Cobra & Late Model 800 Drives



18-2251
PROP SHAFT
Replaces: 435022, 433017, 436740



18-2252
PROP SHAFT
Replaces: 387818, 436888



18-2216
SLIDING CLUTCH
Replaces: 337772, 337774,
334516, 336562, 910995



18-2220
SLIDING CLUTCH
Replaces: 323664, 320630



18-2383
SLIDING CLUTCH
Replaces: 914716, 915272
For: 3.0L (GM), 4.3L (GM), 5.0L (Ford), 5.7L (Ford),
5.8L (Ford) (1990-91)



18-2218
FORWARD GEAR SET
Replaces: 434063, 987966,
985050, 436746



18-2219
REVERSE GEAR
Replaces: 333077,
317838, 340490



18-1600
UPPER GEAR KIT
with bearing
Replaces: 983825
For: 5.7, 5.8L V-8 Cobra drives (21:16 ratio)



18-1601
UPPER GEAR KIT
with bearing
Replaces: 983826
For: 5.0L V-8 engines-Cobra drives (21:18 ratio)



18-1602
UPPER GEAR KIT
Replaces: 984012
For: 4.3L V-6 engines-Cobra drives (21:19 ratio)



18-2217
GEAR SET
— CONTAINS —

Part #	Desc.	O.E.#
NSS	Forward Gear	435020
NSS	Reverse Gear	910994
18-2216	Sliding Clutch	337772

APPLICATION BEGINS ON NEXT PAGE

SHAFT/GEAR/SLIDING CLUTCH APPLICATION

Model	Year	Bearing Carrier Shaft	Short/Long Water Pump Shaft	Drive Shaft	Prop Shaft	Forward Gear	Reverse Gear	Sliding Clutch
100 thru 165	1973	—	18-2185	—	—	—	—	—
120 thru 190	1974-75	—	18-2185	—	—	—	—	—
120 thru 235 ⑥	1976-77	—	18-2184	—	—	—	—	—
120 thru 190 ⑤	1976	—	18-2185	—	—	—	—	—
120/140 ⑤	1977	—	18-2185	—	—	—	—	—
120/140	1978-81	18-2183	18-2185	—	18-2252	—	—	18-2220
120 thru 235 ⑥	1977	—	18-2184	—	—	—	—	—
175/190/235 ⑤	1977	18-2183	18-2185	—	—	—	—	—
185	1978	18-2183	18-2185	18-2186	—	—	—	—
185	1980-81	18-2183	18-2185	18-2186	—	—	—	—
200	1979	18-2183	18-2185	18-2186	—	—	—	—
200	1980-81	18-2183	18-2185	18-2186	—	—	—	—
225/245	1973-75	—	18-2184	—	—	—	—	—
225	1978	18-2183	18-2185	18-2186	—	—	—	—
225	1979	—	—	18-2186	—	—	—	—
225	1980	—	—	18-2186	—	—	—	—
225	1981	—	—	18-2186	—	—	—	—
230	1979	18-2183	18-2185	18-2186	—	—	—	—
230	1980-81	18-2183	18-2185	18-2186	—	—	—	—
235	1975	18-2183	18-2185	—	—	—	—	—
235 ⑤	1976-77	18-2183	18-2185	—	—	—	—	—
240	1978	18-2183	18-2185	18-2186	—	—	—	—
240	1979	—	—	18-2186	—	—	—	—
240	1980-81	—	—	18-2186	—	—	—	—
250	1979	18-2183	18-2185	18-2186	—	—	—	—
260	1979	18-2183	18-2185	18-2186	—	—	—	—
260	1980-81	18-2183	18-2185	—	—	—	—	—
262	1989	—	—	—	18-2187	—	—	—
2.3/3.0	1987-89	—	—	—	18-2252	—	18-2219	—
2.3	1990	—	—	—	18-2252	—	—	—
2.5	1986	18-2183	18-2185	—	18-2252	—	18-2219	—
2.5	1982-87	18-2183	18-2185	—	18-2252	18-2218	18-2219	—
350 ③	1988-89	—	—	—	18-2187	18-2218	—	—
3 ①	1982-86	18-2183	18-2185	—	18-2252	18-2218	18-2219	18-2216
3.0/4.3 ③	1990-91	—	—	—	18-2187	—	—	18-2383
3.0/4.3	1992-93	—	—	—	18-2251	—	—	18-2383
3.0 H.O.	1990-91	—	—	—	18-2187	—	—	18-2383
3.0 H.O.	1992-93	—	—	—	18-2251	—	—	18-2383
3.8	1982-86	18-2183	18-2185	18-2186	18-2187	—	—	18-2216
460 ③	1988-89	—	—	—	18-2187	—	—	18-2216
4.3 ①	1985-86	18-2183	18-2185	18-2186	18-2187	—	—	18-2216
4.3 ②	1986-87	—	—	—	18-2187	—	—	—
4.3 ③	1988-91	—	—	—	18-2187	—	—	18-2383 ⑨
4.3 H.O.	1990-91	—	—	—	18-2187	—	—	18-2383
4.3 H.O.	1992-93	—	—	—	18-2251	—	—	18-2383
5.0/5.7	1982-83	18-2183	18-2185	18-2186	—	—	—	18-2216
5.0/5.7 ①	1984-86	18-2183	18-2185	18-2186	18-2187	—	—	18-2216
5 ②	1986-87	—	—	—	18-2187	—	—	—
5	1988	—	—	—	18-2187	—	—	—
5 ③	1988-91	—	—	—	18-2187	—	—	18-2383 ⑨
5.0/5.7	1992	—	—	—	18-2251	—	—	18-2383
5.0 H.O.	1990-91	—	—	—	18-2187	—	—	18-2383
5.0 H.O.	1992-93	—	—	—	18-2251	—	—	18-2383
5.7	1987-88	—	—	—	18-2187	—	—	—
5.7 ③	1988-89	—	—	—	18-2187	—	—	—
5.7 ⑧ ③	1990-92	—	—	—	18-2187	—	—	18-2383
5.8 ③	1989-90	—	—	—	18-2187	—	—	18-2383 ⑨
5.8	1991	—	—	—	18-2187	—	—	18-2383
5.8	1992-93	—	—	—	18-2251	—	—	18-2383
7.5	1987	—	—	—	18-2187	—	—	18-2216

① Except Cobra
② Cobra

③ Right hand rotation drive
⑤ Low profile

⑥ High profile
⑧ Except L.E. models

⑨ 1990-93 models only



18-3767 BEARING ASSEMBLY & HOUSING
Replaces: 389455
For: V-4, V-6 Cobra Stringer



18-1702 CARRIER BEARING
Replaces: 438039, 5000074
For: 1 3/16" diameter prop shaft-Cobra drives (1986-90) Fits all stringer mounts except 2.5L & 3.0L (1978-85)



18-1703 CARRIER BEARING
Replaces: 434400, 435096, 438040, 5000363, 5004257
For: 1 1/4" diameter prop shaft Cobra drives (1991-93)



18-4828
PINION BEARING CARRIER
 Replaces: 911750
 Fits: OMC Cobra (1986-93) without cone clutch



18-1099
BEARING HOUSING & SEAL ASSEMBLY
 Replaces: 982422
 For: OMC Stringer Drive-120, 140, 170, 200, 230, 260, (1981), 252, 302, 382, 502, 504 & 574 (1982-85), 432 (1985)



18-1343
BEARING CARRIER RETAINING TAB
 Replaces: 333957
 For: Cobra drives & V-6



18-0655
SHIFT ROD
 Replaces: 914736
 3.0L (1990-1993), 4.3L, 5.0L, 5.7L, 5.8L (1986-1993)



18-0647
SHIFT ROD ASSEMBLY
 Replaces: 986658
 3.0L (1990-1993), 4.3L, 5.0L, 5.7L, 5.8L (1986-1993)



18-0652
ROD END, SHIFT
 Replaces: 914723
 3.0L (1990-1993), 4.3L, 5.0L, 5.7L, 5.8L (1986-1993)



18-0653
SCREW, SHIFT ROD END
 Replaces: 308825
 3.0L (1990-1993), 4.3L, 5.0L, 5.7L, 5.8L (1986-1993)



18-0654
NUT, SHIFT ROD END
 Replaces: 914743
 3.0L (1990-1993), 4.3L, 5.0L, 5.7L, 5.8L (1986-1993)



18-3766
SHIFT CRADLE
 Replaces: 334163
 For: V-4/V-6, Cobra, Stringer



18-3610
RETAINER NUT
 Replaces: 911752
 Fits: OMC Cobra (1986-93) without cone clutch



18-3768
COVER NUT
 Replaces: 911751
 For: Cobra Drives 115 (1994-97), 232 (1987-90), 252 (1986) 262 (1989), 302 (1987)



18-1500
INTAKE WATER SCREEN
 Replaces: 337778
 For: 100, 120, 125, 140, 150, 175, 200, 225 (1993) (OMC Cobra & V6)



18-4750
COVER ASSEMBLY
 Replaces: 983967
 Fits: 2.3L (1987-90), 2.5L (1986), 2.6L (1989), 3.0L (1986-93), 4.3L (1986-93), 5.0L (1986-94), 5.7L (1986-92), 5.8L (1989-93), 7.4L (1988)



18-1714
CLUTCH DOG PIN
 Replaces: 313448
 For: 50-85, 100, 135, 140, 150, 175, 200, 235 (1969-82) (OMC Stringer drive)



18-2399
CLUTCH DOG
Replaces: 324369
For: V-4 & V-6



18-4222
THRUST WASHER
Replaces: 318841



18-4223
THRUST WASHER
Replaces: 333592



18-4228
PROP SPACER
Replaces: 315810



18-4194
PROP SPACER
Replaces: 3852350
For: 1994 King Cobra Lower Units



18-4231
PROP SPACER
Replaces: 320570



18-3705
18-3705-9①
PROP NUT
Replaces: 314503



18-3708-1
PROP NUT & KEEPER
Replaces: 398042

PKG. OF 5



18-3730
LOCK NUT
Replaces: 3852648
For: Cobra & King Cobra 1987-94



18-3733
PROP NUT KIT
For: SX Cobra



18-3715
PROP NUT KIT

— CONTAINS —

Part #	O.E. #	Description
18-3708-1	398042	Prop Nut/Keeper
18-3741	309955	Cotter Pin
18-4231	320570	Prop Spacer

② 18-3716D



18-3716
PROP NUT KIT
Replaces: 175267

— CONTAINS —

Part #	O.E. #	Description
18-3705	314503	Prop Nut
18-3742	314502	Cotter Pin
18-4238	315810	Prop Spacer



18-4444
PROP WRENCH
FOR ALL COBRA



18-2156
TILT SHAFT
Replaces: 980183
I/O 1964-86
EXCEPT COBRA

PKG. OF 10



18-3741
18-3741-9①
COTTER PINS
Replaces: 309955

18-3742
18-3742-9①
Replaces: 314502



18-9098
TRAILERING CLIPS
Replaces: 174448
Set of 2
For all Cobra Stern Drives

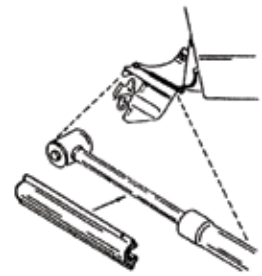

APPLICATION BEGINS ON NEXT PAGE

① Priced per Package

② Items ending in "D" are Display Packaged - Regular number is Non-Display

NUT/SPACER/WASHER/COTTER PIN/PROP NUT KIT APPLICATION

Model	Year	Nut	Spacer	Washer	Cotter Pin	Prop Nut Kit	Model	Year	Nut	Spacer	Washer	Cotter Pin	Prop Nut Kit
120	1978-81	18-3705	18-4228	18-4222	18-3742	18-3716	460	1989-90	18-3708-1	18-4231	18-4223	18-3741	18-3715
140	1978-81	18-3705	18-4228	18-4222	18-3742	18-3716	502	1992	18-3708-1	18-4231	18-4223	18-3741	18-3715
185	1978-80	18-3708-1	18-4231	18-4223	18-3741	18-3715	2.3	1987-90	18-3705	18-4228	18-4222	18-3742	18-3716
200	1979-81	18-3708-1	18-4231	18-4223	18-3741	18-3715	2.5	1982-86	18-3705	18-4228	18-4222	18-3742	18-3716
225	1978	18-3708-1	18-4231	18-4223	18-3741	18-3715	3	1982-89	18-3705	18-4228	18-4222	18-3742	18-3716
230	1979	18-3708-1	18-4231	18-4223	18-3741	18-3715	3	1990-92	18-3708-1	18-4231	18-4223	18-3741	18-3715
240	1978	18-3708-1	18-4231	18-4223	18-3741	18-3715	3.8	1981-85	18-3708-1	18-4231	18-4223	18-3741	18-3715
260	1979-81	18-3708-1	18-4231	18-4223	18-3741	18-3715	4.3	1985-92	18-3708-1	18-4231	18-4223	18-3741	18-3715
262	1987-89	18-3708-1	18-4231	18-4223	18-3741	18-3715	5	1982-92	18-3708-1	18-4231	18-4223	18-3741	18-3715
350	1988-91	18-3708-1	18-4231	18-4223	18-3741	18-3715	5.7	1979-92	18-3708-1	18-4231	18-4223	18-3741	18-3715
351	1992	18-3708-1	18-4231	18-4223	18-3741	18-3715	5.8	1989-92	18-3708-1	18-4231	18-4223	18-3741	18-3715
454	1990-92	18-3708-1	18-4231	18-4223	18-3741	18-3715	7.5	1987	18-3708-1	18-4231	18-4223	18-3741	18-3715

**18-2698
CLUTCH HOUSING SEAL KIT**
Fits: All models 1977 & below

— CONTAINS —

Part #	Desc.	O.E. #	Qty.
18-7114	O-RING	302540	1
18-7400	O-RING	908194	1
18-7952	OIL SEAL	911019	1
18-2863	GASKET, COVER	308799	1
18-4248	GASKET, OIL DRAIN	311598	1
18-0939	GASKET, DIPSTICK	315189	1

**18-8360
CLUTCH HOUSING SEAL KIT**
Fits: All models 1978 & above

— CONTAINS —

Part #	Desc.	O.E. #	Qty.
18-2060	OIL SEAL	321467	2
18-7114	O-RING	302540	1
18-7168	O-RING	202893	2
18-7400	O-RING	908194	1
18-2863	GASKET, COVER	308799	1
18-4248	GASKET, OIL DRAIN	311598	2
18-0939	GASKET, DIPSTICK	315189	1

HP	Year	Clutch Pack Seal Kit	HP	Year	Clutch Pack Seal Kit	HP	Year	Clutch Pack Seal Kit	HP	Year	Clutch Pack Seal Kit
80	1968-1969	18-2698	140	1980-1981	18-8360 ^③	190	1974-1977	18-2698	230	1980-1981	18-8360 ^②
90	All	18-2698	3.0L	1982-1985	18-8360	200	1966-1968	18-2698	235	All	18-2698
100	1972-1973	18-2698	155	1967-1972	18-2698	200	1979-1980	18-2698 ^①	240	1978	18-2698
120	1965-1978	18-2698	165	1972-1976	18-2698	200	1980-1981	18-8360 ^②	245	1972-1975	18-2698
120	1979-1980	18-2698 ^①	3.8L	1981-1983	18-8360	5.0L	1982-1985	18-8360	250	1979	18-2698
120	1980-1985	18-8360 ^③	170	1974	18-2698	210	1968-1970	18-2698	260	1979-1980	18-2698 ^①
2.5L	1982-1985	18-8360	175	1975-1977	18-2698	215	1971	18-2698	260	1980-1981	18-8360 ^②
140	1973-1978	18-2698	185	1967-1968	18-2698	225	All	18-2698	5.7L	1982-1985	18-8360
140	1979-1980	18-2698 ^①	185	1978	18-2698	230	1979-1980	18-2698 ^①			

① 1980 Models with the "C" suffix ② 1980 Models with "K" or "U" suffix ③ 1980 Models with "C1" suffix

**Zinc is for saltwater only applications.
Magnesium is for fresh water only applications.
Aluminum is for brackish water, or if boat is used in both fresh and salt environments.**

**⑤ 18-6019
ANODE**
Replaces: 982277, 982438
For intermediate housing on Stringer Drive models

**⑤ 18-6020
ANODE**
Replaces: 976669
For Stringer Drive models with central grounding point on boat hull

**⑤ 18-6024
④ 18-6024A
ANODE**
Replaces: 393023, 436745
(1982-87) For use on gearcases

**⑤ 18-6025
ANODE**
Replaces: 433458, 398331



③ **18-6027**
ANODE
 Replaces: 392123
 For exhaust housing,
 V4 & V6 (1983-90)



③ **18-6028**
 ① **18-6028A**
 ② **18-6102**
ANODE
 Replaces: 984513,
 3853818, 3855412
 For use on Gearcases: 2.3L (1987-90),
 2.6L/3.5L/4.6L (1989), 3.0L/4.3L/5.0L/5.8L
 (1987-93), 5.7L (1987-92), 7.4L (1987-88)



③ **18-6029**
ANODE
 Replaces: 397768



③ **18-6095**
 ① **18-6095A**
ANODE
 Replaces: 431708
 For use on gearcases (1988-90)



③ **18-6101**
ANODE
 Replaces: 983494
 For: Cobra Lower Unit (1987)
 2.5, 3.0, 4.3, 5.0, 5.7



③ **18-6103**
 ① **18-6103A**
ANODE
 Replaces: 984547
 For use on Transom Mounts:
 2.3L/3.0L (1987-89), 2.6L (1989)



③ **18-6155Z**
ANODE KIT
 For: Cobra Drives except King Cobra

PKG. OF 5



18-3722
18-3722-9④
STAINLESS STEEL LOCKNUT
 Replaces: 121731
 (1/4" — 28)



18-2138
PIVOT PIN BEARING
 Replaces: 911787
COBRA
(2 per Drive)



18-7634
TRIM SENDER
 Replaces: 984748
 Fits: OMC Cobra



18-2663
LOWER UNIT
SEAL KIT
 Replaces: 981797
 100-245 Stringer Unit (1968-77)

— CONTAINS —

Part #	Desc.	O.E. #	Qty.
18-0168	Grommet	908594	1
18-2012	Oil Seal	310599	4
18-2020	Oil Seal	310649	1
18-2058	Oil Seal	313353	2
18-2851	Swivel Bearing To Lower Gear Case Gsk.	313368	1
18-4248	Washer	311598	2
18-7120	O-Ring	307853, 322598	4
18-7129	O-Ring	314491	1
18-7135	O-Ring	310584	1
18-7167	O-Ring	310414	1



18-2664
LOWER UNIT
SEAL KIT
 Replaces: 982947
 4 cyl (400) Stringer Unit (1978-86)

— CONTAINS —

Part #	Desc.	O.E. #	Qty.
18-0110	Shift Housing Gasket	324670	1
18-3133	Housing Screw	908158	2
18-0188	Washer	909748	1
18-2020	Oil Seal	310649	1
18-2058	Oil Seal	313353	2
18-2060	Oil Seal	321467	2
18-3722	Locknut	121731	4
18-4248	Washer	311598	2
18-7101	O-Ring	305739	1
18-7102	O-Ring	307450	1
18-7120	O-Ring	307853, 322598	1
18-7127	O-Ring	313446	1
18-7130	O-Ring	314728	1
18-7178	O-Ring	320140	1
18-7404	O-Ring	909747	1
18-7475	Quad Ring	332583	4
18-7168	O-Ring	202893	1
18-7409	O-Ring	911871	2
18-2001	Oil Seal	330137	2
18-7479	O-Ring	—	1
18-3153	S.S. Bolt	908158	2

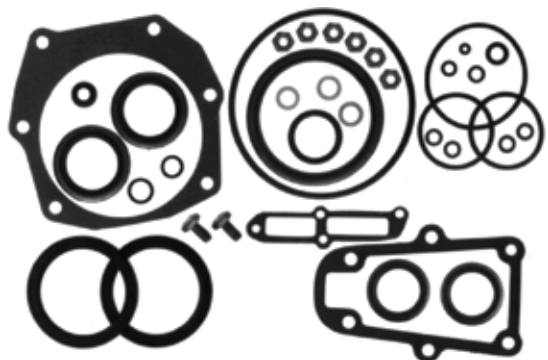

18-2665
LOWER UNIT
SEAL KIT
 Replaces: 982946
 V6,V8 (800) Stringer Unit (1978-86)

— CONTAINS —

Part #	Desc.	O.E. #	Qty.
18-0110	Shift Housing Gasket	324670	1
18-3133	Housing Screw	908158	2
18-0188	Washer	909748	1
18-2002	Oil Seal	320862	2
18-2020	Oil Seal	310649	1
18-2058	Oil Seal	313353	2
18-2060	Oil Seal	321467	2
18-2911	Swivel Bearing Housing Gasket	910236	1
18-3722	Locknut	121731	6
18-4248	Washer	311598	2
18-7101	O-Ring	305739	1
18-7102	O-Ring	307450	1
18-7120	O-Ring	307853, 322598	1
18-7130	O-Ring	314728	1
18-7142	O-Ring	322119	1
18-7178	O-Ring	320140	1
18-7403	O-Ring	909316	2
18-7404	O-Ring	909747	1
18-7475	Quad Ring	332583	4
18-7168	O-Ring	202893	1
18-7479	O-Ring	—	1
18-3153	S.S. Bolt	908158	2



18-2666
UPPER UNIT SEAL KIT
 Replaces: 981799
 100-245 Stringer Unit (1968-72)

— CONTAINS —

Part #	Desc.	O.E. #	Qty.
18-0939	Upper Gearcase Gasket	315189	1
18-2073	Oil Seal	981268	4
18-3111	Rubber Seal	907774	1
18-4248	Washer	311598	2
18-7103	O-Ring	308624	4
18-7107	O-Ring	313175	1
18-7121	O-Ring	308621	1
18-7134	O-Ring	303059	1
18-7146	O-Ring	554545	1
18-7173	O-Ring	910582	1
18-7198	O-Ring	308626	2
18-7158	O-Ring	310585, 310967	1
18-7172	O-Ring	553126	1

— CONTAINS —

Part #	Desc.	O.E. #	Qty.
18-0939	Upper Gearcase Gasket	315189	1
18-2072	Oil Seal	981196	2
18-2073	Oil Seal	981268	2
18-3111	Rubber Seal	907774	1
18-3725	Locknut	908064	1
18-4248	Washer	311598	2
18-4251	Plug	908062	1
18-7107	O-Ring	313175	1
18-7114	O-Ring	302540	1
18-7121	O-Ring	308621	1
18-7129	O-Ring	314491	1
18-7477	Quad Ring	909048	1
18-7168	O-Ring	202893	1
18-7172	O-Ring	553126	1
18-7173	O-Ring	910582, 310327	1



18-2667
UPPER UNIT SEAL KIT
 Replaces: 982949
 All Stringer Unit (1973-86)

— CONTAINS —

Part #	Desc.	O.E. #	Qty.
18-0917	Tilt Motor Gasket	311508	1
18-0923	Seal Gasket	313244	2
18-0939	Upper Gearcase Gasket	315189	1
18-0949	Trunion Cap Gasket	316499	2
18-2004	Oil Seal	—	1
18-2016	Oil Seal	313992	2
18-2066	Oil Seal	911019	1
18-2071	Oil Seal	981195	2
18-3725	Locknut	908064	1
18-4248	Washer	311598	1
18-4251	Plug	908062	1
18-7114	O-Ring	302540	1
18-7162	O-Ring	302337	1
18-7400	O-Ring	908194	1
18-7401	O-Ring	908383	1
18-7198	O-Ring	308626	2
18-2863	Tilt Clutch Cover Gasket	308799	1



18-2669
INTERMEDIATE HOUSING SEAL KIT
 Replaces: 981801
 100-245 Stringer Unit (1973-77)

— CONTAINS —

Part #	Desc.	O.E. #	Qty.
18-2004	Oil Seal	—	1
18-2016	Oil Seal	313992	2
18-2060	Oil Seal	321467	2
18-2071	Oil Seal	981195	2
18-2863	Tilt Clutch Cover Gasket	308799	1
18-3725	Locknut	908064	1
18-4248	Washer	311598	3
18-4251	Plug	908062	1
18-7114	O-Ring	302540	1
18-7162	O-Ring	302337	1
18-7400	O-Ring	908194	1
18-7401	O-Ring	908383	1
18-7168	O-Ring	202893	3
18-7198	O-Ring	308626	2
18-0917	Tilt Motor Gasket	311508	1
18-0923	Seal	313244	2
18-0939	Upper Gearcase Dipstick Gasket	315189	1
18-0947	Pivot Cap Cover Gasket	909529	2
18-0913	Tilt Motor Gasket	909902	1

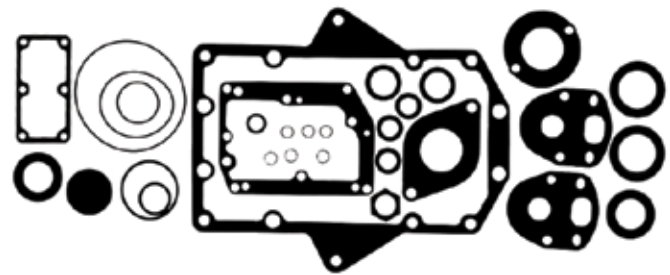

18-2670
INTERMEDIATE HOUSING SEAL KIT
 Replaces: 982948
 All Stringer Unit (1978-86)

— CONTAINS —

Part #	Desc.	O.E. #	Qty.
18-0880	Shift Cover Gasket	911878	1
18-0166	Grommet	911705	2
18-0190	Wiper	912157	1
18-4248	Washer	311598	2
18-7127	O-Ring	313446	1
18-7130	O-Ring	314728	1
18-7137	O-Ring	318372	1
18-7138	O-Ring	318717	3
18-7145	O-Ring	333572	2
18-7475	Quad Ring	332584	5
18-2001	Oil Seal	330137	2



18-2671
LOWER UNIT SEAL KIT
 Replaces: 985612
 All 4 cyl. Cobra (1986-89)



18-2672
LOWER UNIT SEAL KIT
 Replaces: 984458, 985613, 439967
 All V6/V8 Cobra (1986-1991)

-- CONTAINS --

Part #	Desc.	O.E. #	Qty.
18-0880	Shift Cover Gasket	911878	1
18-0166	Grommet	911705	2
18-0190	Wiper	912157	1
18-2002	Oil Seal	320862	2
18-4248	Washer	311598	2
18-7130	O-Ring	314728	1
18-7137	O-Ring	318372	1
18-7138	O-Ring	318717	3
18-7142	O-Ring	322119	1
18-7145	O-Ring	333572	2
18-7475	Quad Ring	332584	5
18-0440	Water Passage Gasket	915719	1



18-2673
UPPER UNIT SEAL KIT
 Replaces: 984459, 986364, 987603
 All Cobra (1986-89)

-- CONTAINS --

Part #	Desc.	O.E. #	Qty.
18-0911	Water Pump Base Gasket	911698	1
18-0884	Water Cover Gasket	911733	1
18-0166	Grommet	911705	2
18-2067	Oil Seal	911685	1
18-2068	Oil Seal	911701, 916058, 915000	1
18-2541	Rubber Seal	911704	1
18-2916	Water Pump Housing Gasket	911702	1
18-2918	Outdrive Gasket	915840	1
18-2996	Seal	911823	1
18-7107	O-Ring	313175	1
18-7116	O-Ring	303067	1
18-7138	O-Ring	318717	2
18-7153	O-Ring	—	2
18-7169	O-Ring	911686	1
18-7403	O-Ring	909316	1
18-7407	O-Ring	911700	1



18-2674
TRANSOM MOUNT SEAL KIT
 Replaces: 985518, 986423
 All Cobra (1986-89)

-- CONTAINS --

Part #	Desc.	O.E. #	Qty.
18-2070	Oil Seal	911795	1
18-2138	Bearing	911787	3
18-2139	Bearing	911794	1
18-2533	Foam Seal	911797	1
18-2918	Outdrive Gasket	915840, 911836	1
18-2996	Seal	911823	1
18-4250	Washer	911820	2
18-7141	O-Ring	321117	12
18-7143	O-Ring	322501	1
18-7162	O-Ring	302337	1
18-7165	O-Ring	304174	1
18-7406	O-Ring	911311	3
18-7408	O-Ring	911718	2
18-7409	O-Ring	911871	1
18-7168	O-Ring	202893	1



18-2783
LOWER UNIT SEAL KIT
 Replaces: 986629
 King Cobra Lower Unit - 1990



18-2791
GEARCASE SEAL KIT
 Replaces: 987251, 3850597
 Fits: 3.0L, 4.3L, 5.0L (1994), 3.2L (1992-93),
 5.7L (1992-94), 7.4L (1992-95), 8.2L (1992-93)

SEAL KIT APPLICATION

Model	Year	Lower Gearcase Seal Kit	Upper Gearcase Seal Kit	Intermediate Housing Seal Kit	Transom Mount Seal Kit	Model	Year	Lower Gearcase Seal Kit	Upper Gearcase Seal Kit	Intermediate Housing Seal Kit	Transom Mount Seal Kit
2.3	1987-90	18-2671	18-2673	N/A	18-2674	165	1972	18-2663	18-2666	18-2668	N/A
2.5 ①	1982-86	18-2664	18-2667	18-2670	N/A	165	1973-76	18-2663	18-2667	18-2669	N/A
2.5 ②	1986	18-2671	18-2673	N/A	18-2674	170	1974	18-2663	18-2667	18-2669	N/A
3 ①	1982-86	18-2664	18-2667	18-2670	N/A	175	1975-77	18-2663	18-2667	18-2669	N/A
3 ②	1986-91	18-2671	18-2667	18-2670	N/A	185	1968	18-2663	18-2666	18-2668	N/A
4.3 ①	1985-86	18-2665	18-2667	18-2670	N/A	185	1978-80	18-2665	18-2667	18-2670	N/A
4.3 ②	1986-91	18-2672	18-2673	N/A	18-2674	190	1974-77	18-2663	18-2667	18-2669	N/A
3.8	1981-86	18-2665	18-2667	18-2670	N/A	200	1968	18-2663	18-2666	18-2668	N/A
5 ①	1982-86	18-2665	18-2667	18-2670	N/A	200	1979-81	18-2665	18-2667	18-2670	N/A
5 ②	1986-91	18-2672	18-2673	N/A	18-2674	210	1968-70	18-2663	18-2666	18-2668	N/A
5.7 ①	1982-86	18-2665	18-2667	18-2670	N/A	215	1971	18-2663	18-2666	18-2668	N/A
5.7 ②	1986-89	18-2672	18-2673	N/A	18-2674	225	1972	18-2663	18-2666	18-2668	N/A
5.7 ③	1990-91	18-2672	18-2673	N/A	18-2674	225	1973-76	18-2663	18-2667	18-2669	N/A
5.8	1989-90	18-2672	18-2673	N/A	18-2674	225	1978	18-2665	18-2667	18-2670	N/A
7.5	1987	—	18-2673	N/A	18-2674	230	1979-81	18-2665	18-2667	18-2670	N/A
80	1969	18-2663	18-2666	18-2668	N/A	235	1971	18-2663	18-2666	18-2668	N/A
90	1970	18-2663	18-2666	18-2668	N/A	235	1975-77	18-2663	18-2667	18-2669	N/A
100	1972	18-2663	18-2666	18-2668	N/A	240	1978	18-2665	18-2667	18-2670	N/A
100	1973	18-2663	18-2667	18-2669	N/A	245	1972	18-2663	18-2666	18-2668	N/A
120	1968-72	18-2663	18-2666	18-2668	N/A	245	1973-75	18-2663	18-2667	18-2669	N/A
120	1973-77	18-2663	18-2667	18-2669	N/A	250	1979	18-2665	18-2667	18-2670	N/A
120	1978-81	18-2664	18-2667	18-2670	N/A	260	1979-81	18-2665	18-2667	18-2670	N/A
140	1973-77	18-2663	18-2667	18-2669	N/A	262	1989	18-2672	18-2673	N/A	18-2674
140	1978-81	18-2664	18-2667	18-2670	N/A	350	1988-89	18-2672	18-2673	N/A	18-2674
155	1968-72	18-2663	18-2666	18-2668	N/A	460	1988-89	—	18-2673	N/A	18-2674

① Except Cobra ② Cobra ③ Except L.E. N/A Not Applicable

OIL SEALS



Part #	O.E. #	Shaft Size	Dimensions (in)		Part #	O.E. #	Shaft Size	Dimensions (in)	
			O.D.	Width				O.D.	Width
18-0542	321831	0.750	1.253	0.186	18-2034	324639	0.437	0.937	0.188
18-0543	321895	1.540	1.926	0.243	18-2035	327031	0.425	0.875	0.313
18-0559	332585	0.285	0.357	0.940	18-2058	313353	1.938	2.438	0.250
18-2000	309989	1.375	2.000	0.313	18-2059	321466	0.750	1.126	0.200
18-2001	330137	1.125	1.624	0.250	18-2060	321467	1.000	1.375	0.250
18-2002	320862	1.188	1.692	0.250	18-2061	329922	0.822	1.375	0.195
18-2005	313284	0.625	1.128	0.250	18-2062	329923	0.875	1.375	0.207
18-2012	310599	1.000	1.499	0.250	18-2063	330327	0.625	1.124	0.188
18-2016	313992	1.187	1.875	0.250	18-2064	332205	0.730	1.130	0.194
18-2018	305987	1.000	1.375	0.250	18-2065	332261	0.625	1.375	0.195
18-2020	310649	2.500	3.000	0.250	18-2066	911019	1.000	1.375	0.435
18-2021	302564	0.750	1.375	0.250	18-2067	911685	2.000	2.509	0.315
18-2022	303345	0.554	1.000	0.375	18-2068	911701	0.500	0.905	0.250
18-2023	313282	0.554	1.062	0.312	18-2068	915702	0.500	0.905	0.250
18-2024	314167	0.425	0.937	0.312	18-2068	916058	0.500	0.905	0.250
18-2025	318972	0.500	0.875	0.250	18-2068	3853655	0.500	0.905	0.200
18-2026	321453	0.875	1.250	0.188	18-2071	981195	1.500	2.125	0.250
18-2027	321459	0.625	1.125	0.250	18-2072	981196	1.750	2.502	0.250
18-2028	321480	0.500	1.250	0.188	18-2073	981268	1.625	2.502	0.250
18-2029	321481	0.687	1.250	0.250	18-2074	322575	1.625	2.125	0.250
18-2030	321786	0.625	1.125	0.188	18-2074	339620	1.625	2.125	0.250
18-2031	321787	0.625	1.125	0.312	18-2075	332942	1.562	2.062	0.300
18-2032	321788	0.500	1.000	0.188	18-8349	911795,	1.375	2.186	0.500
18-2033	321928	0.625	1.375	0.250		3852548			

UPPER GEARCASE (Cobra)				
ENGINE	YEAR	OIL SEAL	DESC.	QTY
262 - 460	1988-89	18-2067	BC	1
262 - 460	1988-90	18-2068	WPS	1
2.3 - 7.5	1986-90	18-2068	WPS	1
2.3 - 7.5	① 1986-90	18-2067	BC	1

① 5.7 '90 574 AMPWS, ARPWS
BC Bearing Carrier Seal
WPS Water Pump Seal

LOWER GEARCASE (Stringer)				
ENGINE	YEAR	OIL SEAL	DESC.	QTY
80/90	1968-71	18-2066	BR,L	2
80/90	1968-71	18-2066	PS	2
88/90	1964-68	18-2012	BR	1
80 - 260	1968-81	18-2020	BR,U	1
80 - 260	1968-81	18-2058	BR,M	2
110 - 200	① 1964-67	18-2012	BR	2
110 - 245	① 1964-77	18-2012	PS	2
110/120	② 1964-67	18-2012	BR	1
120 - 245	1968-77	18-2012	BR,L	2
120 - 260	1978-81	18-2060	BR,L	2
120/140	1978-81	18-2001	PS	2
155	③ 1967	18-2058	BR,M	2
155	③ 1967	18-2020	BR,U	1
185 - 260	1978-81	18-2002	PS	2
210 - 260	④ 1972-75	18-2066	IH	1
230/260	④ 1976	18-2060	IH	1
305/350/454	④ 1977-78	18-2060	IH	1
2.5/3.0	1982-86	18-2001	PS	2
2.5 - 5.7	1981-86	18-2020	BR,U	1
2.5 - 5.7	1981-86	18-2058	BR,M	2
2.5 - 5.7	1981-86	18-2060	BR,L	2
3.8 - 5.7	1981-86	18-2002	PS	2

① 110, 120 HP '64-67 Hvy. Duty Dr.
 ② Standard Drive
 ③ HU, HUE 16 C Models
 ④ Inboard
BR Driveshaft Bearing Retainer Seal
BR,U Driveshaft Bearing Retainer Upper Seal
BR,M Driveshaft Bearing Retainer Middle Seal
BR,L Driveshaft Bearing Retainer Lower Seal
IH Impeller Housing Seal
PS Prop Shaft Seal

UPPER GEARCASE (Stringer)				
ENGINE	YEAR	OIL SEAL	DESC.	QTY
80 - 245	1968-72	18-2073	BGS	1
80 - 260	1969-81	18-2073	IH	2
88 - 200	1964-66	18-2000	BGS	1
90	③ 1967	18-2000	BGS	1
90	④ 1967	18-2073	BGS	1
100 - 245	1972-73	18-2073	BGS	1
100 - 260	1973-81	18-2072	BGS	2
120	① 1967	18-2073	BGS	1
120	② 1967	18-2000	BGS	1
120	① 1967	18-2073	IH	2
120 - 210	1968	18-2073	IH	2
155	1967	18-2073	IH	2
155	⑤ 1967	18-2000	BGS	1
155	1967	18-2073	BGS	1
185	1967	18-2000	BGS	1
200	⑥ 1967	18-2000	BGS	1
200	⑦ 1967	18-2073	IH	2
200	⑦ 1967	18-2073	BGS	1
2.5 - 5.7	1981-86	18-2072	BGS	2
2.5 - 5.7	1981-86	18-2073	IH	2

① CU, CUE 16C Models
 ② CU15S Models
 ③ DU, DUE 14D Models
 ④ DU, DUE 15S Models
 ⑤ HU, HUE 15S Models
 ⑥ TU, TUE 15S Models
 ⑦ TU, TUE 16C Models
BGS Ball Gear Shaft Seal
IH Impeller Housing Seal

LOWER GEARCASE (Cobra)

ENGINE	YEAR	OIL SEAL	DESC.	QTY
262 - 460	1988-89	18-2002	PS	2
2.3	1990	18-2001	PS	2
2.3 - 3.0	1986-89	18-2001	PS	2
3	1990	18-2002	PS	2
4.3 - 7.5	1986-90	18-2002	PS	2

PS Prop Shaft Seal

INTERMEDIATE HOUSING (Stringer)

ENGINE	YEAR	OIL SEAL	DESC.	QTY
80 - 235	1964-71	18-2000	BG,O	1
80 - 245	1964-72	18-2001	BG,I	1
80 - 260	② 1964-80	18-2066	CL	1
100 - 245	1972	18-2000	BG,O	2
100 - 260	1973-79	18-2016	BG,I	1
100 - 260	1973-81	18-2071	BG,O	2
120 - 260	1980-81	18-2016	BG,I	2
120 - 260	① 1980-81	18-2060	CL	2
2.5 - 5.7	1981-86	18-2060	CL	2
2.5 - 5.7	1981-86	18-2016	BG,I	2
2.5 - 5.7	1981-86	18-2071	BG,O	2

CL Clutch
 ① 120, 140 '80C Models/185—260 '80 K&U Models
 ② C Models in '80
BG,I Driveshaft Ball Gear Inner Seal
BG,O Driveshaft Ball Gear Outer Seal



O-RINGS

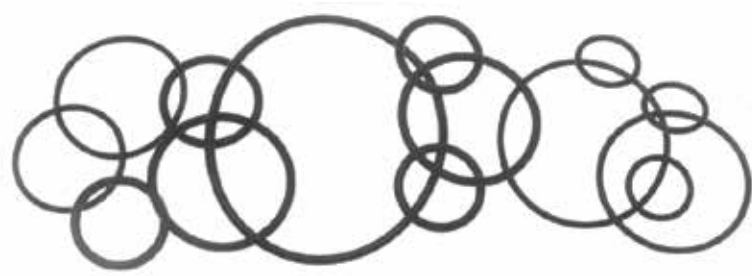

Part #	O.E. #	Dimensions (in)		Part #	O.E. #	Dimensions (in)	
		I.D.	Width			I.D.	Width
18-7100	② ⑤ 301877	.245	.155	18-7150	③ ⑤ 331380	.225	.115
18-7101	② ⑤ 305739	.250	.065	18-7150	③ ⑤ 334913	.225	.115
18-7102	② ⑤ 307450	.430	.065	18-7152	② ⑤ 307082	2.625	.135
18-7103	② ⑤ 308624	.920	.100	18-7153	① 3852565,		
18-7104	② ⑤ 308627	2.210	.135		911851	.0860	.100
18-7105	② ⑤ 311338	.750	.065	18-7155	② ⑤ 305270	1.620	.135
18-7107	② ⑤ 313175	4.750	.135	18-7156	② ⑤ 309731	1.185	.100
18-7108	② ⑤ 313893	2.550	.100	18-7158	② ⑤ 310585	.740	.100
18-7108	② ⑤ 338518	2.550	.100	18-7162	② ⑤ 302337	2.025	.135
18-7109	② ⑤ 317178	.214	.048	18-7164	② ⑤ 302537	1.375	.100
18-7111	① 301824	.197	.113	18-7165	② ⑤ 304174	.500	.065
18-7112	① 302493	1.170	.135	18-7167	② ⑤ 310414	3.625	.135
18-7114	② ⑤ 302540	1.000	.135	18-7168	② ⑤ 202893	.370	.065
18-7115	① 302588	1.735	.135	18-7169	② ⑤ 911686	3.500	.135
18-7116	① 303067	.360	.100	18-7170	① 307239	1.365	.135
18-7117	① 303360	1.060	.135	18-7172	② ⑤ 553126	3.250	.135
18-7118	② ⑤ 305242	.300	.135	18-7173	② ⑤ 310327	1.875	.135
18-7120	① 307853	.215	.065	18-7174	② ⑤ 326649	.620	.100
18-7120	① 332598	.215	.065	18-7178	② ⑤ 320140	.920	.135
18-7121	① 308621	3.100	.135	18-7180	② ⑤ 303347	.445	.090
18-7123	① 308876	2.235	.100	18-7198	② ⑤ 308626	1.430	.100
18-7126	① 313340	1.690	.100	18-7400	② ⑤ 908194	4.000	.100
18-7127	① 313446	3.315	.135	18-7401	② ⑤ 908383	2.485	.100
18-7128	① 313754	1.835	.100	18-7403	② ⑤ 909316	1.500	.100
18-7129	② ⑤ 314491	.970	.065	18-7404	② ⑤ 909747	.300	.100
18-7130	① 314728	2.125	.100	18-7406	② ⑤ 911311	0.250	.065
18-7133	② ⑤ 305123	3.780	.135	18-7407	② ⑤ 911700	4.125	.135
18-7134	② ⑤ 303059	.500	.100	18-7407	② ⑤ 3852531	4.125	.135
18-7135	① 310584	.750	.135	18-7408	② ⑤ 911718	1.060	.100
18-7137	② ⑤ 318372	0.320	.155	18-7409	② ⑤ 911871	1.175	.100
18-7138	② ⑤ 318717	1.500	.210	18-7413	② ⑤ 303191	.301	.070
18-7139	② ⑤ 319085	1.080	.210	18-7416	② ⑤ 329380	.612	.103
18-7140	② ⑤ 320303	2.750	.135	18-7417	② ⑤ 329381	.362	.103
18-7141	② ⑤ 321117	.180	.065	18-7418	② ⑤ 326741	4.484	.139
18-7142	② ⑤ 322119	3.940	.135	18-7440-1	④ 301967	.799	.103
18-7143	② ⑤ 322501, 331188	1.310	.100	18-7457	① 319662	1.799	.103
18-7144	② ⑤ 326849	4.250	.135	18-7461	① 308458	1.612	.103
18-7145	② ⑤ 333572	.250	.100	18-7475	② ⑤ 332584	.250	.065
18-7146	② ⑤ 554545	1.120	.100	18-7477	② ⑤ 909048	.480	.100
18-7150	③ ⑤ 303598	.225	.115	18-7510	① 321163	2.750	.070

① Pkg. of 1 ② Pkg. of 5 ③ Pkg. of 10 ④ Indicates Quad Rings rather than O-Rings

TRANSOM MOUNT (Cobra)					TRANSOM MOUNT (Cobra) (Cont.)				
ENGINE	YEAR	O-RING	DESC.	QTY.	ENGINE	YEAR	O-RING	DESC.	QTY.
262 - 460	1988-89	18-7165	SCS	1	2.3 - 7.5	① 1986-90	18-7165	SCS	1
262 - 460	1988-89	18-7408	NP	2	2.3 - 7.5	① 1986-90	18-7409	SC	1
262 - 460	1988-89	18-7409	SC	1	2.3 - 7.5	1986-90	18-7143	MB	1
262 - 460	1988-89	18-7406	PL	1					
262 - 460	1988-89	18-7168	BC	1					
262 - 460	1988-90	18-7162	UG	1					
262 - 460	1988-90	18-7143	MB	1					
2.3 - 7.5	① 1986-90	18-7168	BC	1					
2.3 - 7.5	1986-90	18-7162	UG	1					
2.3 - 7.5	① 1986-90	18-7406	PL	1					
2.3 - 7.5	① 1986-90	18-7408	NP	2					

① 5.7 '90 574 AMPWS, ARPWS
BC Bell Crank Seal
MB Manifold Block Seal
UG Upper Gimbal Seal
SCS Shift Cable Seal
PL Plug Seal
NP Nipple Seal
SC Sleeve and Connector Seal

⑤ This product is priced per piece. To order priced per package, please add -9 to the part number.

UPPER GEARCASE (Cobra)					POWER TILT AND TRIM (Cobra)				
ENGINE	YEAR	O-RING	DESC.	QTY	ENGINE	YEAR	O-RING	DESC.	QTY
262 - 460	1988-89	18-7403	A,S	1	262 - 460	1988-90	18-7141	OL	12
262 - 460	1988-89	18-7107	GHC	1	262 - 460	1988-90	18-7102	PL	1
262 - 460	1988-89	18-7407	A,L	1	350 - 460	1988	18-7174	VSH	1
262 - 460	1988-90	18-7169	BC	1	350 - 460	1988	18-7168	VS	4
350 - 460	1990	18-7116	OFF	1	350 - 460	1988	18-7174	VA,L	2
350 - 460	1990	18-7407	BC	1	350 - 460	1988	18-7165	VA,S	2
350 - 460	1990	18-7406	WDP	1	2.3 - 7.5	1986-88	18-7174	VSH	1
370	1988	18-7407	AB	1	2.3 - 7.5	1986-88	18-7168	VS	4
460	1990	18-7407	BC	1	2.3 - 7.5	1986-88	18-7174	VA,L	2
2.3 - 5.8	1990	18-7116	OFF	1	2.3 - 7.5	1986-88	18-7165	VA,S	2
2.3 - 7.5	① 1986-90	18-7107	GHC	1	2.3-7.5	1986-90	18-7102	PL	1
2.3 - 7.5	① 1986-90	18-7407	A,L	1	2.3-7.5	1986-90	18-7141	OL	12
2.3 - 7.5	1986-90	18-7169	BC	1					
2.3 - 7.5	① 1986-90	18-7403	A,S	1					
5.7	② 1990	18-7406	WDP	1					
5.7	② 1990	18-7407	BC	1					
① 5.7 '90 574 AMPWS, ARPWS ② 574 PEPWS GHC Gear Hsg. Cover Seal OFF Oil Fill Plug Seal BC Bearing Carrier Seal A,S Adaptor, Small Seal A,L Adaptor, Large Seal WDP Water Drain Plug Seal AB Anchor Block Seal					PL Plug Seal VS Valve Seat Assy. Seal VA,L Valve Assy., Large Seal VA,S Valve Assy., Small Seal VSH Valve Seat Hsg. Seal OL Oil Line Seal				
LOWER GEARCASE (Cobra)					OIL AND COOLING SYSTEM (Cobra)				
ENGINE	YEAR	O-RING	DESC.	QTY	ENGINE	YEAR	O-RING	DESC.	QTY
262/350	1988-89	18-7475	PBHS	4	262/454	1989-90	18-7135	AR	1
262/350	1988-89	18-7142	PBH	1	262 - 460	1988-90	18-7116	ODF	1
262 - 460	1988-89	18-7130	DS B	1	350/460	1988-90	18-7135	AR	1
262 - 460	1988-89	18-7475	BSS	1	370	1988	18-7162	THERM	1
262 - 460	1988-89	18-7138	DS BH	3	2.3 - 5.8	1988-90	18-7116	ODF	1
262 - 460	1988-89	18-7137	SR	1	4.3	① 1990	18-7135	AR	1
350 - 460	1990	18-7145	PL	1	7.5	1987	18-7135	AR	1
370	1988	18-7130	SL	2					
370/460	1988-89	18-7145	D&F S	2					
2.3	1987	18-7145	D&F S	2					
2.3	1990	18-7127	PBH	1					
2.3 - 3.0	1986-89	18-7127	PBH	1					
2.3/3.0	1988-90	18-7145	D&F S	2					
2.5 - 5.7	1986	18-7145	D&F S	2					
2.3 - 5.8	① 1986-90	18-7475	PBHS	4					
2.3 - 7.5	① 1986-90	18-7475	BSS	1					
2.3 - 7.5	① 1986-90	18-7138	DS BH	3					
2.3 - 7.5	① 1986-90	18-7137	SR	1					
2.3 - 7.5	① 1986-90	18-7130	DS B	1					
3.0 - 5.8	① 1990	18-7142	PBH	1					
4.3 - 5.8	1989-89	18-7142	PBH	1					
5.7	② 1990	18-7145	PLUG	1					
① 5.7 '90 574 AMPWS, ARPWS ② 574 PEPWS BSS Bearing Setscrew Seal DS BH Driveshaft Bearing Hsg. Seal DS B Driveshaft Bearing Seal D&F S Drain & Fill Screw Seal PBH Prop Bearing Hsg. Seal PBHS Prop Bearing Hsg. Screw Seal PL Plug Seal SR Shift Rod Seal SL Sleeve Seal					① V-4 Only ODF Oil Drain Fitting Seal AR Adapter Retainer Seal THERM Thermostat Seal				
					POWERHEAD (Stringer)				
ENGINE	YEAR	O-RING	DESC.	QTY	ENGINE	YEAR	O-RING	DESC.	QTY
80/90	1969-71	18-7108	WP	1	80	1964	18-7133	CCH	3
88	1964	18-7133	CCH	3	88/90	1964-68	18-7120	CCHS	4
88/90	1964-68	18-7120	CCHS	4	90	1965-68	18-7133	CCH	4
90	1965-68	18-7133	CCH	4	120/140	1977-80	18-7114	CP	1
120/140	1977-80	18-7114	CP	1	120 - 235	1976	18-7114	CP	1
120 - 235	1976	18-7114	CP	1					
					WP Water Pump Seal CCH Crankcase Head Seal CCHS Crankcase Head Screw Seal CP Coupling Seal				
					INTERMEDIATE HOUSING (Stringer)				
ENGINE	YEAR	O-RING	DESC.	QTY	ENGINE	YEAR	O-RING	DESC.	QTY
80	1968	18-7162	SL	1	80 - 90	1964-68	18-7174	WT	1
80 - 90	1964-68	18-7174	WT	1	80 - 210	1964-70	18-7123	BGR	1
80 - 210	1964-70	18-7123	BGR	1	80 - 245	① 1964-72	18-7174	PS	1
80 - 245	① 1964-72	18-7174	PS	1	80 - 260	1964-81	18-7198	COV	2
80 - 260	1964-81	18-7198	COV	2	80 - 260	1964-81	18-7114	WR	1
80 - 260	1964-81	18-7114	WR	1	80 - 260	1969-81	18-7162	SL	1
80 - 260	1969-81	18-7162	SL	1	88	1964	18-7104	TH	1
88	1964	18-7104	TH	1	88	1964	18-7174	TC	1
88	1964	18-7174	TC	1					

INTERMEDIATE HOUSING (Stringer) (Cont.)

ENGINE	YEAR	O-RING	DESC.	QTY
90 - 235	1970-71	18-7158	DS	1
90 - 235	② 1971	18-7123	BGR	1
100 - 260	1973-81	18-7401	BGR	1
100 - 260	1973-81	18-7400	TUC	1
120	③ 1967	18-7162	SL	1
120 - 210	1968	18-7162	SL	1
120/140	1981	18-7168	FS	3
155	④ 1967	18-7162	SL	1
2.5 - 5.7	1981-86	18-7400	TUC	1
2.5 - 5.7	1981-86	18-7198	COV	2
2.5 - 5.7	1981-86	18-7114	WR	1
2.5 - 5.7	1981-86	18-7401	BGR	1
2.5 - 5.7	1981-86	18-7162	SL	1
2.5 - 5.7	1982	18-7168	FS	3

- ① Rope or Pull-Pull Steering Models
- ② All 90/120, 155, 210 EX Models/235 XUFM20S prior to S/N 202880 and 235 XUFM20S prior to S/N 204600
- ③ CU, CUE 16C
- ④ 120, 155, 215, 20D Models/235 XUFR20S S/N 202880 & up and 235 XUFM20S S/N 204600 & up 235 20D all Models
- COV** Pivot Cap Cover Seal
- BGR** Ball Gear Retainer Seal
- DS** Driveshaft to Hsg. Seal
- TC** Driveshaft Tube Cover Seal
- TH** Driveshaft Tube to Hsg.
- FS** Fill Screw Seal
- PS** Pulley Shaft
- SL** Sleeve to Hsg. Seal
- TUC** Tilt Unit Cover Seal
- WT** Water Tube Seal
- WR** Worm Gear Retainer Seal

UPPER GEARCASE (Stringer)

ENGINE	YEAR	O-RING	DESC.	QTY
80 - 90	1968-71	18-7158	BG	1
80 - 90	1964-68	18-7174	IH	1
80 - 245	① 1964-72	18-7103	WG	1
80 - 245	① 1964-74	18-7134	G	1
80 - 260	1964-81	18-7172	IH	1
80 - 260	1964-81	18-7121	BGR	1
80 - 260	1968-80	18-7173	WW	1
80 - 260	② 1968-81	18-7107	WW	1
90	③ 1967	18-7107	WW	1
90 - 200	1964-67	18-7128	CAP	1
90 - 200	1965-67	18-7173	WW	2
90 - 245	④ 1967-72	18-7146	BG	1
100 - 245	1973-75	18-7114	WS	1
100 - 260	1973-81	18-7129	DS IH	1
110 - 120	⑤ 1964-67	18-7158	IH	1
110 - 120	⑥ 1964-67	18-7174	IH	1
120 - 200	⑦ 1967	18-7107	WW	1
120 - 235	1968-71	18-7158	IH	1
120 - 260	1975-81	18-7477	G	1
150 - 210	1964-67	18-7158	IH	1
2.5/3.0	1982	18-7168	OP	1
2.5 - 5.7	1981-86	18-7477	G	1
2.5 - 5.7	1981-86	18-7172	IH	1
2.5 - 5.7	1981-86	18-7107	WW	1
2.5 - 5.7	1981-86	18-7121	BGR	1
2.5 - 5.7	1981-86	18-7129	DS IH	1

UPPER GEARCASE (Stringer) (Cont.)







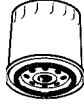

- ① Rope or Pull-Pull Steering Models
- ② 155 HP 1968 HU, HUE 16C
- ③ DU, DUE 15S
- ④ 90 HP '67 DU, DUE 15S/120 and 200 '67 16C Models
- ⑤ Heavy Duty Drive
- ⑥ Standard Gearcase
- ⑦ 16C Models
- BG** Ball Gear Seal
- BGR** Ball Gear Retainer Seal
- DS IH** Driveshaft Impeller Hsg. Seal
- IH** Impeller Hsg. Seal
- CAP** Gear Hsg. Cap Seal
- OP** Oil Plug Seal
- WR** Steering Worm Wheel Retainer Seal
- WS** Steering Worm Wheel Spacer Seal
- WG** Steering Worm Wheel Gear Seal
- WW** Steering Worm Wheel Seal
- G** Gear Seal

LOWER GEARCASE (Stringer)

ENGINE	YEAR	O-RING	DESC.	QTY
80 - 90	1964-69	18-7120	PBH S	4
80 - 90	1964-71	18-7152	PBH	1
80 - 90	1964-71	18-7115	BR	1
80 - 90	1964-71	18-7174	DS	1
88/90	1964-68	18-7173	DSB	2
90 - 245	1970-77	18-7120	PBH S	4
100 - 245	1968-72	18-7135	BR	1
100 - 245	1969-77	18-7167	PBH	1
110/120	② 1964-67	18-7167	PBH	1
110/120	① 1964-67	18-7174	DS	1
110/120	② 1964-67	18-7135	BR	1
110/120	① 1964-67	18-7152	PBH	1
110/120	① 1964-67	18-7173	DSB	2
110/120	① 1964-67	18-7115	BR	1
120	① 1964-67	18-7120	PBH S	4
120/140	1978-81	18-7127	PBH	1
120/140	1978	18-7156	SA,L	2
120 - 235	1977	18-7129	DS	1
120 - 240	1978	18-7178	SA,S	1
120 - 260	1978-81	18-7130	BR	1
120 - 260	1978-81	18-7102	PIN	1
120 - 260	1978-81	18-7109	PBH S	4
120 - 260	1978-81	18-7404	PIN	1
120 - 260	1979-81	18-7120	BSS	1
120 - 260	1981	18-7168	D&F S	1
150 - 200	1964-67	18-7135	BR	1
150 - 210	1964-68	18-7167	PBH	1
185 - 240	1978	18-7403	SA,L	2
185 - 260	1978-81	18-7142	PBH	1
2.5 - 5.7	1981-82	18-7168	D&F S	1
2.5 - 5.7	1981-83	18-7109	PBH S	4
2.5 - 5.7	1981-86	18-7130	BR	1
2.5 - 5.7	1981-86	18-7102	PIN	1
2.5 - 5.7	1981-86	18-7404	PIN	1
2.5 - 5.7	1981-86	18-7120	BSS	1
2.5 - 5.7	1981-86	18-7142	PBH	1
2.5/3.0	1982-86	18-7127	PBH	1
3.8	1981	18-7101	OSV	1

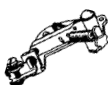
- ① Standard Drive
- ② Heavy Duty Drive
- OSV** Oil Stem Valve Seal
- PIN** Pinion Shaft Seal
- BR** Driveshaft Bearing Retainer Seal
- DS** Driveshaft Seal
- PBH** Prop Bearing Hsg. Seal
- DSB** Driveshaft Bushing Seal
- PBH S** Prop Bearing Hsg. Screw Seal
- D&F S** Drain & Fill Screw Seal
- SA,L** Shift Assy., Large Seal
- SA,S** Shift Assy., Small Seal
- BSS** Bearing Set Screw Seal

TUNE-UP APPLICATION FOR GAS ENGINE MODELS









									
Model Application	Oil Filter	Fuel Filter	Impeller	Drive Belt	Contact Set	Condenser	Rotor	Distributor Cap	Tune-Up Kit
MB 10 A	18-7878	—	18-3080	—	18-5305	—	18-5428	—	—
BB 30	18-7878	—	18-3080	—	18-5306	—	—	18-5357	—
BB 100	18-7878	—	18-3080	—	18-5306	—	—	18-5357	—
MB 18	18-7878	—	18-3080	—	18-5306	—	—	18-5357	—
AQ 60 F	18-7878	—	18-3080	—	18-5306	—	—	18-5357	—
MB 18 F	18-7878	—	18-3080	—	18-5306	—	—	18-5357	—
AQ 90	18-7878	—	18-3080	—	18-5306	—	—	18-5357	—
AQ 95	18-7878	—	18-3080	—	18-5306	—	—	18-5357	—
AQ 100	18-7878	—	18-3080	—	18-5306	—	—	18-5357	—
AQ 95A	18-7878	—	18-3080	—	18-5306	—	18-5428	18-5357	18-5257
AQ 110	18-7878	—	18-3080	—	18-5306	—	18-5428	18-5357	18-5257
AQ 120	18-7878	—	18-3080	—	18-5306	—	—	18-5357	—
BB 115 A	18-7878	—	18-3080	—	18-5305	—	18-5428	18-5356	—
BB 115 B	18-7878	—	18-3080	—	18-5305	—	18-5428	18-5356	—
BB 115 C	18-7878	—	18-3080	—	18-5305	—	18-5428	18-5356	—
MB 20 A	18-7878	—	18-3080	—	18-5305	—	18-5428	18-5356	—
MB 20 B	18-7878	—	18-3080	—	18-5306 ⑥ 18-5305 ⑦	—	18-5428 ⑥ ⑦	18-5356 ⑦	—
MB 20 C	18-7878	—	18-3080	—	18-5306 ⑥ 18-5305 ⑦	—	18-5428 ⑥ ⑦	18-5356 ⑦	—
AQ 115 A	18-7878	—	18-3080	—	18-5305	—	18-5428	18-5356 ④ 18-5357 ⑤	—
AQ 115 B	18-7878	—	18-3080	—	18-5305	—	18-5428	18-5356 ④ 18-5357 ⑤	—
AQ 130 A	18-7878	—	18-3080	—	18-5305	—	18-5428	18-5356 ④ 18-5357 ⑤	—
AQ 130 B	18-7878	—	18-3080	—	18-5305	—	18-5428	18-5356 ④ 18-5357 ⑤	—
AQ 130 C	18-7878	—	18-3080	—	18-5305	—	18-5428	18-5356 ④ 18-5357 ⑤	—
AQ 130 D	18-7878	—	18-3080	—	18-5305	—	18-5428	18-5356 ④ 18-5357 ⑤	—
BB 165 A	18-7878	—	18-3075	18-4044	18-5305 ⑨ 18-5319 ⑩	—	18-5428 ⑧ ⑨ 18-5424 ⑩	18-5393 ⑧ ⑨ 18-5394 ⑩	—
BB 170 A	18-7878	—	18-3075	18-4044	18-5305 ⑨ 18-5319 ⑩	—	18-5428 ⑧ ⑨ ⑩	18-5393 ⑧ ⑨ 18-5394 ⑩	—
BB 170 B	18-7878	—	18-3075	18-4044	18-5305 ⑨ 18-5319 ⑩	—	18-5428 ⑧ ⑨ ⑩	18-5393 ⑧ ⑨ 18-5394 ⑩	—
BB 170 C	18-7878	—	18-3075	18-4044	18-5305 ⑨ 18-5319 ⑩	—	18-5428 ⑧ ⑨ ⑩	18-5393 ⑧ ⑨ 18-5394 ⑩	—
AQ 165 A	18-7878	—	18-3075	18-4044	18-5305 ⑨ 18-5319 ⑩	18-5342 ⑧ ⑨	18-5428 ⑧ ⑨ ⑩	18-5393 ⑧ ⑨ 18-5394 ⑩	—
AQ 170 A	18-7878	—	18-3075	18-4044	18-5305 ⑨ 18-5319 ⑩	18-5342 ⑧ ⑨	18-5428 ⑧ ⑨ ⑩	—	—
AQ 170 B	18-7878	—	18-3075	18-4044	18-5305 ⑨ 18-5319 ⑩	18-5342 ⑧ ⑨	18-5428 ⑧ ⑨ ⑩	—	—
AQ 170 C	18-7878	—	18-3075	18-4044	18-5305 ⑨ 18-5319 ⑩	18-5342 ⑧ ⑨	18-5428 ⑧ ⑨	—	—
AQ 120 B	18-7878	18-7862 18-7858	18-3075	18-4044	18-5305	18-5349 ① 18-5348 ②	18-5428	18-5358 18-5356 ②	18-5284 ①
AQ 125 A	18-7878	18-7862 18-7858	18-3075	18-4044	18-5305	—	18-5428	—	—
AQ 125 B	18-7878	18-7862 18-7858	18-3075	18-15435	18-5305	—	18-5428	—	—
AQ 131 A	18-7878	18-7862 18-7858	18-3075	18-15435	18-5305	—	18-5428	—	—
AQ 131 B	18-7878	18-7862 18-7858	18-3075	18-15435	18-5305	—	18-5428	—	—
AQ 131 C	18-7878	18-7862 18-7858	18-3075	18-15435	18-5305	—	18-5428	—	—
AQ 131 D	18-7878	18-7862 18-7858	18-3075	18-15435	18-5305	—	18-5428	—	—
230A	18-7878	18-7862 18-7858	18-3075	18-15435	18-5305	—	18-5428	—	—
230B	18-7878	18-7862 18-7858	18-3075	18-4044	18-5305	—	18-5428	—	—
BB 140 A	18-7878	18-7862 18-7858	18-3075	18-4044	18-5305	18-5349 ① 18-5348 ②	18-5428	18-5358 ① 18-5356 ②	18-5284 ①
AQ 140 A	18-7878	18-7862 18-7858	18-3075	18-4044	18-5305	18-5349 ① 18-5348 ②	18-5428	18-5356	—

④ Distributor # 0231153010 & 0231153012
 ⑤ Distributor # 0231178011
 ⑥ Distributor # 0231110043
 ⑦ Distributor # 0231178005
 ⑧ Distributor # 0231116054 & 0231116060

⑨ Distributor # 0231121008
 ⑩ Distributor # 0231311002
 ⑪ Distributor # 0231178017
 ⑫ Distributor # 0231178016 & 0231178018
 ⑬ Alternator

① Mally flat cap
 ② Mally tall cap
 ③ S/N 20459 & below
 ④ S/N 20460 & up

TUNE-UP APPLICATION FOR GAS ENGINE MODELS







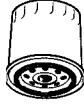

									
Model Application	Oil Filter	Fuel Filter	Impeller	Drive Belt	Contact Set	Condenser	Rotor	Distributor Cap	Tune-Up Kit
BB 145 A	18-7878	18-7862 18-7858	18-3075	18-4044	18-5305	—	18-5428	18-5358	—
AQ 145 A	18-7878	18-7862 18-7858	18-3075	18-4044	18-5305	—	18-5428	18-5358	—
AQ 145 B	18-7878	18-7862 18-7858	18-3075	18-15435	18-5305	—	18-5428	18-5358	—
AQ 151 A	18-7878	18-7862 18-7858	18-3075	18-15435	18-5305	—	18-5428	18-5358	—
AQ 151 B	18-7878	18-7862 18-7858	18-3075	18-15435	18-5305	—	18-5428	18-5358	—
AQ 151 C	18-7878	18-7862 18-7858	18-3075	18-15435	18-5305	—	18-5428	18-5358	—
250 A	18-7878	18-7862 18-7858	18-3075	18-4044	18-5305	—	18-5428	18-5358	—
250 B	18-7878	18-7862 18-7858	18-3075	18-4044	18-5305	—	18-5428	18-5358	—
AQ 171 A	18-7878	18-7862 18-7858	18-3075	18-15435	—	—	—	—	—
AQ 171 C	18-7878	18-7862 18-7858	18-3075	18-15435	—	—	—	—	—
251 A	18-7878	18-7862 18-7858	18-3075	18-4044	—	—	—	—	—
3.0 GL	18-7824	—	18-3060	—	—	—	18-5406	18-5361	—
3.0 GS	18-7824	—	18-3060	—	—	—	18-5406	18-5361	—
AQ 175 A	18-7879	18-7862 18-7858	18-3081	18-4046	18-5303	18-5345	18-5403	18-5353	—
430 A	18-7879	18-7862 18-7858	18-3081	18-4046	—	—	18-5403	18-5353	—
430 B	18-7879	18-7862 18-7858	18-3081	18-4046	—	—	18-5403	18-5353	—
AQ 190A	18-7875	—	18-3061	—	18-5303	18-5345	18-5425	18-5369	—
AQ 200 B	18-7824	18-7862 18-7858	18-3060	18-4046 ⑤	18-5314④ 18-5303⑤	18-5338④ 18-5345⑤	18-5411④ 18-5403⑤	18-5375④ 18-5352⑤	18-5256④ 18-5260⑤
AQ 200 C	18-7824	18-7862 18-7858	18-3060	18-4046 ⑤	18-5314④ 18-5303⑤	18-5338④ 18-5345⑤	18-5411④ 18-5403⑤	18-5375④ 18-5352⑤	18-5256 18-5260⑤
AQ 200 D	18-7824	18-7862 18-7858	18-3081	18-4046	18-5303	18-5345	18-5425⑥ 18-5403⑤	18-5369⑥ 18-5352⑤	—
AQ 200 F	18-7824	18-7862 18-7858	18-3081	18-4046	18-5303	18-5345	18-5403	18-5352	18-5262
AQ 205 A	18-7879	18-7845 18-7858 18-7845	—	18-4046	—	—	18-5403	18-5353	—
431 A	18-7879	18-7845 18-7858	—	18-4046	—	—	18-5403	18-5353	—
431 B	18-7879	18-7845 18-7858	18-3081	18-4046	—	—	18-5403	18-5353	—
432 A	18-7879	18-7845 18-7858	18-3081	—	—	—	—	—	—
434 A	18-7879	18-7845 18-7858	18-3081	—	—	—	—	—	—
4.3 GL	18-7879	—	18-3060	—	—	—	18-5408	18-5362	—
4.3 GS	18-7879	—	18-3060	—	—	—	18-5408	18-5362	—
4.3 GI	18-7879	—	18-3081	—	—	—	—	—	—
AQ 211 A	18-7824	18-7845 18-7858	18-3081	18-4046	18-5303	18-5345	18-5403	18-5352	18-5260
500 A	18-7824	18-7845 18-7858	18-3081	18-4046	18-5303	18-5345	18-5403	18-5352	18-5260
500 B	18-7824	18-7845 18-7858	18-3081	18-4046	—	—	18-5403	18-5352	—
AQ 225 B	18-7824	18-7862 18-7858	18-3060	18-4046 ⑤	18-5314④ 18-5303⑤	18-5338④ 18-5345⑤	18-5411④ 18-5403⑤	18-5375④ 18-5352⑤	18-5256④ 18-5260⑤
AQ 225 C	18-7824	18-7862 18-7858	18-3060	18-4046 ⑤	18-5314	18-5338	18-5411	18-5375	—
AQ 225 D	18-7824	18-7862 18-7858	—	18-4046	18-5303	18-5345	18-5425⑥ 18-5403⑤	18-5369⑥ 18-5352⑤	18-5264⑥ 18-5260⑤
AQ 225 E	18-7824	18-7862 18-7858	—	18-4046	18-5303	18-5345	18-5403	18-5352	18-5260
AQ 225 F	18-7824	18-7862 18-7858	—	18-4046	18-5303	18-5345	18-5403	18-5352	18-5260
BB 225 A	18-7824	18-7862 18-7858	18-3081	—	18-5303	18-5345	18-5403	18-5352	18-5260

④ Distributor # 0231153011 & 0231153012
 ⑤ Distributor # 0231178011
 ⑥ Distributor # 0231110043
 ⑦ Distributor # 0231178005
 ⑧ Distributor # 0231116054 & 0231116060

⑨ Distributor # 0231121008
 ⑩ Distributor # 0231311002
 ⑪ Distributor # 0231178017
 ⑫ Distributor # 0231178016 & 0231178018
 ⑬ Alternator

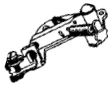
⑭ Mally flat cap
 ⑮ Mally tall cap
 ⑯ S/N 20459 & below
 ⑰ S/N 20460 & up

TUNE-UP APPLICATION FOR GAS ENGINE MODELS



									
Model Application	Oil Filter	Fuel Filter	Impeller	Drive Belt	Contact Set	Condenser	Rotor	Distributor Cap	Tune-Up Kit
BB 225 B	18-7824	18-7862 18-7858	18-3081	18-4046	18-5303	18-5345	18-5403	18-5352	18-5260
BB 225 C	18-7824	18-7845 18-7858	18-3081	18-4046	18-5303	18-5345	18-5403	18-5352	18-5260
AQ 231 A	18-7824	18-7845 18-7858	18-3081	18-4046	18-5303	18-5345	18-5403	18-5352	18-5260
AQ 231 B	18-7824	18-7845 18-7858	18-3081	18-4046	18-5303	18-5345	18-5403	18-5352	18-5260
BB 231 A	18-7824	18-7845 18-7858	—	18-4046	18-5303	18-5345	18-5403	18-5352	18-5260
501 A	18-7824	18-7845 18-7858	18-3081	18-4046	18-5303 ⑩	18-5345⑩	18-5403	18-5352	18-5260
501 B	18-7824	18-7845 18-7858	18-3081	18-4046 18-3081	—	—	18-5403	18-5352	—
5.0 FL	18-7875	—	18-3060	—	—	—	—	—	—
5.0 FI	18-7875	—	18-3060	18-3081	—	—	—	—	—
5.7 GL	18-7824	—	18-3060	—	—	—	—	—	—
5.7 GI	18-7824	—	18-3060	—	—	—	18-5405	18-5354	—
5.8 FL	18-7875	—	18-3060	18-3081	—	—	—	—	—
5.8 FI	18-7875	—	18-3060	18-3081	—	—	—	—	—
5.8 FSI	18-7875	—	18-3060	18-3081	—	—	—	—	—
AQ 240 A	18-7875	—	18-3061	—	18-5303	18-5345	18-5425	18-5369	18-5264
AQ 255 A	18-7824	18-7862 18-7858	—	18-4046	18-5314	18-5338	18-5411	18-5375	18-5256
AQ 255 B	18-7824	18-7862 18-7858	18-3081	18-4046	18-5303	18-5345	18-5425⑥ 18-5403⑧	18-5369⑥ 18-5352⑥	18-5260⑥
AQ 260 A	18-7824	18-7862 18-7858	18-3081	18-4046	18-5303	18-5345	18-5425⑥ 18-5403⑧	18-5369⑥ 18-5352⑥	18-5260
AQ 260 B	18-7824	18-7862 18-7858	—	18-4046	18-5303	18-5345	18-5403	18-5352	18-5260
BB 260 A	18-7824	18-7862 18-7858	18-3081	18-4046	18-5303	18-5345	18-5403	18-5352	18-5260
BB 260 B	18-7824	18-7862 18-7858	18-3081	18-4046	18-5303	18-5345	18-5403	18-5352	18-5260
BB 260 C	18-7824	18-7862 18-7858	18-3081	18-4046	18-5303	18-5345	18-5403	18-5352	18-5260
BB 261 A	18-7824	18-7845 18-7858	18-3081	18-4046	18-5303	18-5345	18-5403	18-5352	18-5260
AQ 271 A	18-7824	18-7845 18-7858	18-3081	18-4046	—	—	18-5403	18-5352	—
AQ 271 B	18-7824	18-7845 18-7858	18-3081	18-4046	—	—	18-5403	18-5352	—
AQ 271 C	18-7824	18-7845 18-7858	18-3081	18-4046	—	—	18-5403	18-5352	—
AQ 271 D	18-7824	18-7845 18-7858	18-3081	18-4046	—	—	18-5403	18-5352	—
570 A	18-7824	18-7845 18-7858	18-3081	18-4046	—	—	18-5403	18-5352	—
572 A	18-7824	18-7845 18-7858	18-3081	18-4046	—	—	18-5403	18-5352	—
570 A/MS 4A	18-7824	18-7845 18-7858	18-3081	18-4046	—	—	18-5403	18-5352	—
AQ 280 A	18-7824	18-7862 18-7858	18-3081	18-4046	18-5303	18-5345	18-5425⑥ 18-5403⑧	18-5369⑥ 18-5352⑥	18-5260⑥
AQ 290 A	18-7824	18-7862 18-7858	18-3081	18-4046	18-5303	18-5345	18-5425⑥ 18-5403⑧	18-5369⑥ 18-5352⑥	18-5260⑥
AQ 311 A	18-7824	18-7845 18-7858	18-3081	18-4046	—	—	18-5403	18-5352	—
AQ 311 B	18-7824	18-7845 18-7858	18-3081	18-4046	—	—	18-5403	18-5352	—
571 A	18-7824	18-7845 18-7858	18-3081	18-4046	—	—	18-5403	18-5352	—
740 A	—	18-7845	—	—	—	—	18-5403	18-5352	—
740 B	18-7824	18-7845	—	—	—	—	18-5403	18-5352	—
7.4 GL	18-7824	—	18-3081 18-3060	—	—	—	—	—	—
7.4 GI	18-7824	—	18-3081	—	—	—	18-5405	18-5362	—
7.4 GSI	18-7824	—	18-3081	—	—	—	—	—	—
8.2 GL	18-7824	—	18-3081 18-3060	—	—	—	—	—	—

④ Distributor # 0231153010 & 0231153012
 ⑤ Distributor # 0231178011
 ⑥ Distributor # 0231110043
 ⑦ Distributor # 0231178005
 ⑧ Distributor # 0231116054 & 0231116060

⑨ Distributor # 0231121008
 ⑩ Distributor # 0231311002
 ⑪ Distributor # 0231178017
 ⑫ Distributor # 0231178016 & 0231178018
 ⑬ Alternator

⑭ Mallory flat cap
 ⑮ Mallory tall cap
 ⑯ S/N 20459 & below
 ⑰ S/N 20460 & up

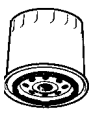
TUNE-UP APPLICATION FOR DIESEL ENGINE MODELS

									
Model Application	Oil Filter	Fuel Filter	Impeller	Drive Belt	Model Application	Oil Filter	Fuel Filter	Impeller	Drive Belt
2001, B	18-7884	18-7858	18-3076	—	TAMD 31 D	18-7878	—	18-3077	—
2002, B	18-7884	18-7858	18-3076	—	AD 31 D	18-7878	—	18-3077	—
2003, B	18-7884	18-7858	18-3076	—	AD 31 XD	18-7878	—	18-3077	—
2003 T,TB	18-7884	18-7858	18-3081	—	TMD 31 L-A	18-7878	—	18-3077	—
MD 2010 A,B	—	18-7858	18-3079	—	TAMD 31	—	—	—	—
MD 2020 A,B	—	18-7858	18-3079	—	P,L,M-A	18-7878	—	18-3077	—
MD 2030 A,B	—	18-7858	18-3080	—	AD 31 P,L-A	18-7878	—	18-3077	—
MD 2040 A,B	—	18-7858	18-3080	—	—	—	—	—	—
MD 1	—	—	18-3079 ②	—	MD 40 A	—	—	18-3077	—
MD 1 B	18-7884	—	18-3079	—	—	—	—	—	—
MD 2	18-7884	—	18-3079 ③	—	TMD 40 A	—	—	18-3077	—
MD 2 B	18-7884	—	18-3079	—	—	—	—	—	—
AQD 2 B	18-7884	—	18-3079	—	AQD 40 A	—	—	18-3077	—
MD 3 B	18-7884	—	18-3080	—	—	—	—	—	—
MD 5 A	18-7884	—	18-3076	—	TAMD 40 A	—	—	18-3078	—
MD 5 B	18-7884	—	18-3076	—	—	—	—	—	—
MD 5 C	18-7884	—	18-3076	—	AQAD 40 A	—	—	18-3078	—
MD 6 A	18-7884	—	18-3079	—	—	—	—	—	—
MD 6 B	18-7884	—	18-3076	—	TMD 40 B	—	—	18-3077	—
MD 7 A	18-7884	—	18-3076	—	—	—	—	—	—
MD 7 B	18-7884	—	18-3076	—	TAMD 40 B	—	—	18-3078	—
MD 11 C	18-7884	—	18-3076	—	—	—	—	—	—
MD 11 D	18-7884	—	18-3076	—	AQAD 40 B	—	—	18-3078	—
MD 17 C	18-7884	—	18-3080	—	—	—	—	—	—
MD 17 D	18-7884	—	18-3080	—	TMD 40 C	—	—	18-3077	—
MD 22 A	—	—	18-3081	—	TMD 41 A	—	—	18-3077	—
MD 22 L-A	—	—	18-3081	—	AQD 41 A	—	—	18-3077	—
TMD 22 A	—	—	18-3081	—	D 41 A	—	—	18-3077	—
—	—	—	18-3081 ④	—	TAMD 41 A	—	—	18-3077	—
AQD 21 A	—	18-7858	18-3075 ⑤	18-15460	AQAD 41 A	—	—	18-3077	—
—	—	—	18-3081 ④	—	AD 41 A	—	—	18-3077	—
MD 21 A	—	18-7858	18-3075 ⑤	18-15460	TMD 41 B	—	—	18-3077	—
—	—	—	18-3081 ④	—	D 41 B	—	—	18-3077	—
AQD 21 B	—	18-7858	18-3075 ⑤	18-15460	TAMD 41 B	—	—	18-3077	—
—	—	—	18-3081 ④	—	AD 41 B	—	—	18-3077	—
MD 21 B	—	18-7858	18-3075 ⑤	18-15460	KAMD 42 A	—	—	18-3077	—
AQD 32 A	—	18-7858	18-3077	—	KAD 42 A	—	—	18-3077	—
MD 32 A	—	18-7858	18-3077	—	TMD 41 D	—	—	18-3077	—
MD 30 A	18-7878	—	18-3077	—	D 41 D	—	—	18-3077	—
TMD 30 A	18-7878	—	18-3077	—	TAMD 41 D	—	—	18-3077	—
TAMD 30 A	18-7878	—	18-3077	—	AD 41 D	—	—	18-3077	—
AQAD 30 A	18-7878	—	18-3077	—	TMD 41 L-A	—	—	18-3077	—
MD 31 A	18-7878	—	18-3077	—	D 41 L-A	—	—	18-3077	—
TMD 31 A	18-7878	—	18-3077	—	TAMD 41	—	—	—	—
AQAD 31 A	18-7878	—	18-3077	—	P,L,M,H-A	—	—	18-3077	—
AD 31 A	18-7878	—	18-3077	—	KAMD 42 B	—	—	18-3077	—
TMD 31 B	18-7878	—	18-3077	—	KAD 42 B	—	—	18-3077	—
TAMD 31 B	18-7878	—	18-3077	—	KAMD 42 P-A	—	—	18-3077	—
AD 31 B	18-7878	—	18-3077	—	KAD 42 P-A	—	—	18-3077	—
TMD 31 D	18-7878	—	18-3077	—	—	—	—	—	—





② S/N 14016 & up

④ S/N 103386 & below

③ S/N 4211- & up

⑤ S/N 103387 & up

 <p>18-5256 TUNE-UP KIT</p> <p>— CONTAINS —</p> <table border="1"> <thead> <tr> <th>Part #</th> <th>O.E. #</th> <th>Description</th> </tr> </thead> <tbody> <tr> <td>18-5314</td> <td>835304</td> <td>Contact Set</td> </tr> <tr> <td>18-5338</td> <td>835308-8</td> <td>Condenser</td> </tr> <tr> <td>18-5411</td> <td>841243</td> <td>Rotor</td> </tr> </tbody> </table>	Part #	O.E. #	Description	18-5314	835304	Contact Set	18-5338	835308-8	Condenser	18-5411	841243	Rotor	 <p>18-5257 TUNE-UP KIT</p> <p>— CONTAINS —</p> <table border="1"> <thead> <tr> <th>Part #</th> <th>O.E. #</th> <th>Description</th> </tr> </thead> <tbody> <tr> <td>18-5306</td> <td>240149</td> <td>Contact Set</td> </tr> <tr> <td>18-5342</td> <td>243653</td> <td>Condenser</td> </tr> <tr> <td>18-5428</td> <td>243903</td> <td>Rotor</td> </tr> </tbody> </table> <p>Bosch 4 cyl.</p>	Part #	O.E. #	Description	18-5306	240149	Contact Set	18-5342	243653	Condenser	18-5428	243903	Rotor	<p>① 18-5260D Display Package</p>  <p>18-5260 TUNE-UP KIT</p> <p>— CONTAINS —</p> <table border="1"> <thead> <tr> <th>Part #</th> <th>O.E. #</th> <th>Description</th> </tr> </thead> <tbody> <tr> <td>18-5303</td> <td>835705, 855846-2</td> <td>Contact Set</td> </tr> <tr> <td>18-5345</td> <td>835704</td> <td>Condenser</td> </tr> <tr> <td>18-5403</td> <td>855845</td> <td>Rotor</td> </tr> </tbody> </table> <p>Prestolite</p>	Part #	O.E. #	Description	18-5303	835705, 855846-2	Contact Set	18-5345	835704	Condenser	18-5403	855845	Rotor	 <p>18-5264 TUNE-UP KIT</p> <p>— CONTAINS —</p> <table border="1"> <thead> <tr> <th>Part #</th> <th>O.E. #</th> <th>Description</th> </tr> </thead> <tbody> <tr> <td>18-5303</td> <td>835705, 855846-2</td> <td>Contact Set</td> </tr> <tr> <td>18-5345</td> <td>835704</td> <td>Condenser</td> </tr> <tr> <td>18-5425</td> <td>834975</td> <td>Rotor</td> </tr> </tbody> </table> <p>V-8 with Prestolite clip-down cap</p>	Part #	O.E. #	Description	18-5303	835705, 855846-2	Contact Set	18-5345	835704	Condenser	18-5425	834975	Rotor
Part #	O.E. #	Description																																																	
18-5314	835304	Contact Set																																																	
18-5338	835308-8	Condenser																																																	
18-5411	841243	Rotor																																																	
Part #	O.E. #	Description																																																	
18-5306	240149	Contact Set																																																	
18-5342	243653	Condenser																																																	
18-5428	243903	Rotor																																																	
Part #	O.E. #	Description																																																	
18-5303	835705, 855846-2	Contact Set																																																	
18-5345	835704	Condenser																																																	
18-5403	855845	Rotor																																																	
Part #	O.E. #	Description																																																	
18-5303	835705, 855846-2	Contact Set																																																	
18-5345	835704	Condenser																																																	
18-5425	834975	Rotor																																																	

 <p>18-5265 TUNE-UP KIT</p> <p>— CONTAINS —</p> <table border="1"> <thead> <tr> <th>Part #</th> <th>O.E. #</th> <th>Description</th> </tr> </thead> <tbody> <tr> <td>18-5305</td> <td>243799, 1306169, 243460</td> <td>Contact Set</td> </tr> <tr> <td>18-5348</td> <td>834560</td> <td>Condenser</td> </tr> <tr> <td>18-5428</td> <td>243903</td> <td>Rotor</td> </tr> </tbody> </table>	Part #	O.E. #	Description	18-5305	243799, 1306169, 243460	Contact Set	18-5348	834560	Condenser	18-5428	243903	Rotor	 <p>18-5266 TUNE UP KIT</p> <p>Fits: Flame Thrower Distributors 18-5481, 18-5482, 18-5483, 18-5477, 18-5478, 18-5479</p>	<p>① 18-5284D Display Package</p>  <p>18-5284 TUNE-UP KIT</p> <p>— CONTAINS —</p> <table border="1"> <thead> <tr> <th>Part #</th> <th>O.E. #</th> <th>Description</th> </tr> </thead> <tbody> <tr> <td>18-5305</td> <td>243799, 1306169, 243460</td> <td>Contact Set</td> </tr> <tr> <td>18-5349</td> <td>841262</td> <td>Condenser</td> </tr> <tr> <td>18-5428</td> <td>243903</td> <td>Rotor</td> </tr> </tbody> </table>	Part #	O.E. #	Description	18-5305	243799, 1306169, 243460	Contact Set	18-5349	841262	Condenser	18-5428	243903	Rotor	 <p>18-5303 CONTACT SET</p> <p>Replaces: 835705, 855846-2</p>
Part #	O.E. #	Description																									
18-5305	243799, 1306169, 243460	Contact Set																									
18-5348	834560	Condenser																									
18-5428	243903	Rotor																									
Part #	O.E. #	Description																									
18-5305	243799, 1306169, 243460	Contact Set																									
18-5349	841262	Condenser																									
18-5428	243903	Rotor																									





 <p>18-5305 CONTACT SET</p> <p>Replaces: 243460, 243799, 1306169</p>	 <p>18-5306 CONTACT SET</p> <p>Replaces: 240149</p>	 <p>18-5310 CONTACT SET</p> <p>Replaces: 818701-5</p>	 <p>18-5314 CONTACT SET</p> <p>Replaces: 835304</p>	 <p>18-5319 CONTACT SET</p> <p>Replaces: 243801</p>
---	--	--	--	--

 <p>18-5338 CONDENSER</p> <p>Replaces: 835308-8</p>	 <p>18-5342 CONDENSER</p> <p>Replaces: 243653</p>	 <p>18-5345 CONDENSER</p> <p>Replaces: 835704</p>	 <p>18-5347 CONDENSER</p>	 <p>18-5349 CONDENSER</p> <p>Replaces: 841262</p> <p>For: Bosch Distributors</p>
---	---	---	---	--

 <p>18-5348 CONDENSER</p> <p>Replaces: 834560</p>	 <p>18-5403 ROTOR</p> <p>Replaces: 855845, 841907, 3853801</p>	 <p>18-5404-1 ROTOR</p>	 <p>18-5405 ROTOR</p> <p>Replaces: 3854549-7</p> <p>V-8 Fits new GM style "Module in Cap"</p>	 <p>18-5406 ROTOR</p> <p>Replaces: 3854261</p> <p>For: 3.0L</p>
---	--	---	---	---

 <p>18-5408 ROTOR Replaces: 3854311-2 V-6 Fits new GM style "Module in Cap"</p>	 <p>18-5411 ROTOR Replaces: 841243</p>	 <p>18-5413 ROTOR For: 5.0L FI, FL, 5.8L FL, FI, FSI</p>	 <p>18-5419 ROTOR Replaces: 818525-8</p>	
 <p>18-5425 ROTOR Replaces: 834975</p>	 <p>18-5428 ROTOR Replaces: 243903</p>	 <p>18-5248 DISTRIBUTOR CAP Replaces: 3854217 For: 5.0FIPMDA, 5.0FIPMDM, 5.8FIPMDA, 5.8FIPMDM, 5.0FIPHUBCE, 5.0FIPHUCCE, 5.0FIPHUECE, 5.0FIPHURCE, 5.0FIPHUSCE, 5.0FLPHUB, 5.0FLPHUC, 5.0FLPHUE, 5.0FLPHUR, 5.0FLPHUS, 5.8FIIHU, 5.8FIP</p>	 <p>18-5301 TUNE-UP KIT Replaces: Fits: male cap v-8 flamethrower distributors</p>	
 <p>18-5302 TUNE-UP KIT Replaces: Fits: male cap v-8 flamethrower distributors</p>	 <p>18-5352 DISTRIBUTOR CAP Replaces: 841070</p>	 <p>18-5353 DISTRIBUTOR CAP Replaces: 841926</p>	 <p>18-5354 DISTRIBUTOR CAP Replaces: 3854548-9 V-8 Fits new GM style "Module in Cap"</p>	 <p>18-5356 DISTRIBUTOR CAP Replaces: 243797</p>
 <p>18-5357 DISTRIBUTOR CAP Replaces: 870690</p>	 <p>18-5358 DISTRIBUTOR CAP Replaces: 841263</p>	 <p>18-5361 DISTRIBUTOR CAP Replaces: 3854260 For: 3.0L</p>	 <p>18-5362 DISTRIBUTOR CAP Replaces: 3854331-0 V-6 Fits new GM style "Module in Cap"</p>	 <p>18-5369 DISTRIBUTOR CAP Replaces: 835702 with 18-5399 Gasket</p>
 <p>18-5375 DISTRIBUTOR CAP Replaces: 841244</p>	 <p>18-5393 DISTRIBUTOR CAP Replaces: 241669</p>	 <p>18-5473 DISTRIBUTOR CAP Black Distributor Cap w/ Male Terminals Petronix Dsistributors</p>	 <p>18-5474 DISTRIBUTOR CAP Red Distributor Cap with Male Terminals Petronix Dsistributors</p>	 <p>18-7492 COIL Replaces: 3854161 For: 1996 applications</p>

SEE PAGES 811-814 FOR APPLICATION

 <p>18-7493 COIL Replaces: 3859078 For: 8.1L 2001-2007</p>	 <p>18-5745 IGNITION COIL Replaces: 3287677 Fits: AQ171A, AQ171C 251A (1988-92)</p>	 <p>18-7648 IGNITION COIL Replaces: 3861267 Fits: 8.1Gi-A, 8.1Gi-B, 8.1Gi-BF, 8.1Gi-C, 8.1Gi-CF, 8.1Gi-D, 8.1Gi-DF, 8.1GSi-A, 8.1GXi-A, 8.1GXi-AF, 8.1GXi-B, 8.1GXi-BF, 8.1GXi-C</p>	 <p>18-5434 IGNITION COIL Replaces: 835998 Uses External Resistor</p>
--	--	--	---

 <p>18-5436 IGNITION COIL Replaces: 35254 Has Internal Resistor</p>	 <p>18-5443 IGNITION COIL Replaces: 3854002-7 3.0L/4.3L/5.7L/7.4L</p>	 <p>18-5107-1 IGNITION MODULE Replaces: 3854003</p>	 <p>18-5464 IGNITION MODULE Fits: Sierra 18-5481, 18-5482 and 18-5483 Billet HI-PERFORMANCE ELECTRONIC DISTRIBUTORS (except HEI/EST)</p>	 <p>18-5108 PICK-UP COIL SENSOR Replaces 3854001</p>
--	---	---	--	--

 <p>18-7757 THROTTLE POSITION SENSOR Replaces: 3855296 Fits: 1995-2001</p>	 <p>18-7642 PICK-UP ASSEMBLY Replaces: 3863130 Fits: 3.0, 4.3, 5.0, 5.7L models (2002-07)</p>	 <p>18-7643 CAMSHAFT SENSOR Replaces: 3859082 Fits: 8.1Gi-A, 8.1Gi-B, 8.1Gi-BF, 8.1Gi-C, 8.1Gi-CF, 8.1Gi-D, 8.1Gi-DF, 8.1GSi-A, 8.1GXi-A, 8.1GXi-AF, 8.1GXi-B, 8.1GXi-BF, 8.1GXi-C, 8.1Gi-E, 8.1Gi-EF, 8.1GXi-D, 8.1GXi-DF, 8.1OSi-A, 8.1OSi-AF, 8.1GiI-E, 8.1GXii-D (2001-07)</p>	 <p>18-7706 CRANKSHAFT POSITION SENSOR Replaces: 3858979 Fits: 4.3, 5.0, 5.7L models</p>	 <p>18-7708 CRANKSHAFT POSITION SENSOR Replaces: 3808516 Fits: Most 8.1L</p>
---	--	---	---	---

FEATURES

- ★ Oil filled for better cooling and long life
- ★ Low resistance and improved turn ratios produces the higher voltage needed to run larger spark plug gaps for added power and better fuel economy
- ★ More windings maximize energy and reliability over the full RPM range
- ★ Fits existing brackets for easy installation

 <p>18-5466 HI-PERFORMANCE IGNITION COIL 1.5 ohm (oil filled), black - 8 cylinder: Flame-Thrower 40,000 volt coil. ★ Designed for use with the original Ignitor Electronic Conversion Kits ★ Can be used with other inductive ignition systems</p>	 <p>18-5469 HI-PERFORMANCE IGNITION COIL 3.0 ohm (oil filled), black - 4 & 6 cylinder: Flame-Thrower 40,000 volt coil. ★ Designed for use with the original Ignitor Electronic Conversion Kits ★ Can be used with other inductive ignition systems</p>	 <p>18-5472 HI-PERFORMANCE IGNITION COIL 0.6 ohm (oil filled), black - 4, 6, & 8 cylinder: Flame-Thrower 45,000 volt coil. ★ Super low 0.6 ohm resistance coil designed for use with the Ignitor II Hi Performance Electronic Conversion Kits ★ Compatible with capacitive discharge systems</p>
--	---	--

Part #	Description	Recommended Coil	Resistance Ohms	Part #	Description	Recommended Coil	Resistance Ohms
18-5294	Electronic Conversion Kit	18-5469	3.0	18-5286	Hi Performance Electronic Conversion Kit	18-5472	0.6
18-5295	Electronic Conversion Kit	18-5469	3.0	18-5289	Hi Performance Electronic Conversion Kit	18-5472	0.6
18-5299	Electronic Conversion Kit	18-5466	1.5	18-5483	Flame-Thrower Distributor	18-5472	0.6

SEE PAGES 811-814 FOR APPLICATION



FEATURES

- ★ *Distributors feature the Ignitor II ignition module with adaptive dwell control adjusts the spark timing over the entire RPM range to maximize performance*
- ★ *Upper roller bearing and oil impregnated bronze sintered bottom bushing are installed and aligned bored for accuracy for maximum durability*
- ★ *Machined heat treated gear with tight tolerances insures durability and consistent timing to maximize horsepower and performance. Complete with high dielectric strength cap and rotor for years of performance*

Standard Rotation

CCW Rotation

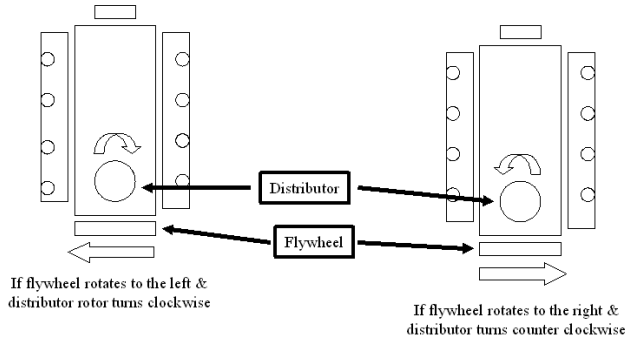

18-5483
HI-PERFORMANCE
ELECTRONIC DISTRIBUTOR

Fits: Chevrolet Marine Small and Big Block engines (Standard Deck Height)
Replacement cap/rotor kit 18-5266



18-5475
DISTRIBUTOR
Fits: 4 Cyl GM w/ Delco EST Ignition



18-5484-1
ELECTRONIC DISTRIBUTOR
(Late HEI)
Replaces: Mallory YLE624AV
For Left Hand Rotation V8/RH 262-454 & 502 (Except 348/409 and Tall Block Engines)
• Designed as a plug-in replacement for GM-style fuel ignition system distributor

—CONTAINS—

Part #	Description
18-5354	Distributor Cap
18-5405	Rotor



18-5485
ELECTRONIC DISTRIBUTOR
(Late HEI)
Replaces: Mallory YLE624BV
For Right Hand Rotation V8/RH 262-454 & 502 (Except 348/409 and Tall Block Engines)
• Designed as a plug-in replacement for GM-style fuel ignition system distributor

—CONTAINS—

Part #	Description
18-5354	Distributor Cap
18-5405	Rotor



18-5494-1
ELECTRONIC DISTRIBUTOR
Replaces: Mallory YLM624AV
Conventional Rotation
For Chevrolet all V8 includes 482, 502, 540 CID
(Except 348,409 & Tall Deck Big Block)

—CONTAINS—

Part #	Description
18-5376	Distributor Cap
18-5488	Module
18-5404-1	Rotor



18-5498-1
ELECTRONIC DISTRIBUTOR
Replaces: Mallory YLM624BV
Reverse Rotation
For Chevrolet all V8 includes 482, 502, 540 CID
(Except 348,409 & Tall Deck Big Block)

—CONTAINS—

Part #	Description
18-5376	Distributor Cap
18-5488	Module
18-5404-1	Rotor



18-5480
COMPLETE IGNITION
CONVERSION KIT
Fits: GM SB & BB with Standard Deck Height

—CONTAINS—

Part #	Description
18-5472	Coil
18-8803-2	Wire Set
18-5483	Distributor

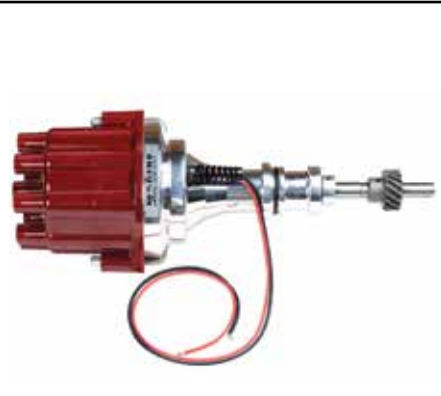

18-5477
ELECTRONIC DISTRIBUTOR
 Fits: Ford 302 V-8 engines



18-5478
ELECTRONIC DISTRIBUTOR
 Fits: Chrysler LA series V-8 engines



18-5479
ELECTRONIC DISTRIBUTOR
 Fits: GM V-8 engines-reverse rotation



FEATURES

- ★ Senses current levels in the coil and adjusts the dwell to maintain peak energy throughout the entire RPM range.
- ★ Develops, on average, 4 times more available energy between 3000 and 5000 RPM's and twice as much plug voltage as point-type systems.
- ★ Ignition energy is sustained and coil life is increased when peak current level is reached just prior to spark.
- ★ More stable timing.
- ★ Use with 18-5472 "Flame Thrower II" Coil for optimum performance



18-5286
HI-PERFORMANCE
ELECTRONIC CONVERSION KIT
 Fits: 6 Cylinder Delco Distributors



18-5288
HI-PERFORMANCE
ELECTRONIC CONVERSION KIT
 Fits: Most Prestolite V-8 Distributors with snap down cap



18-5289
HI-PERFORMANCE
ELECTRONIC CONVERSION KIT
 Fits: Most Prestolite V-8 Distributors with screw down cap



FEATURES

- ★ Replaces points & condensers for true solid state ignition.
- ★ Uses standard coil, cap and rotor.
- ★ Easy to install, one-piece, 2-wire hook-up.
- ★ Accurate to within 1/4° timing accuracy 0 to 6000 RPM range.

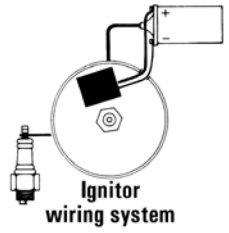
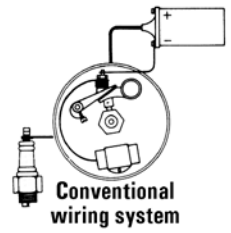

18-5292
ELECTRONIC
CONVERSION KIT
 Fits: 4 Cylinder Volvo AQ Models with Bosch Ignition (Dist # 0231178017)



18-5294
ELECTRONIC
CONVERSION KIT
 Fits: (6 Cyl.) Delco distributors



18-5295
ELECTRONIC
CONVERSION KIT
 Fits: Most 4 Cyl. Prestolite distributors (except IBM7026) For: Onan, Universal, Waukesha, Wisconsin



18-5299D Display Package
ELECTRONIC
CONVERSION KIT
 Fits: 8 (Cyl.) AQ200A, B, AQ225A, B and All 8 Cyl. w/Prestolite Dist # IBM-7013A Use with 18-5403 style rotor

① Items ending in "D" are Display Packaged - Regular number is Non-Display

PREMIUM MARINE SPARK PLUG WIRE LEADS



OE style boots provide a sealed barrier against heat, dirt and moisture.

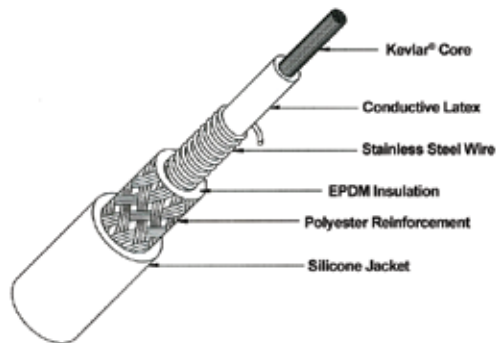

Premium Marine Wire Leads
Magnetic Suppression Core
Manufactured for your specific application

- ★ Kevlar® core for maximum durability and long life.
- ★ Durable stainless steel wound conductor for maximum horsepower and engine performance.
- ★ Premium silicone jacketing and boots for the ultimate in high temperature protection.
- ★ Superior RFI suppression for the most sensitive electronic system.
- ★ Corrosion resistant stainless steel spark plug and distributor terminals for maximum conductivity.

Model	Cyl.	Part #	Model	Cyl.	Part #
AQ120B	4	18-8813-1 ①	AQ255A-F	8	18-8802-1
AQ125A,B	4	18-8813-1 ①	AQ255A-F	8	18-8823-1 ②
AQ131A-D	4	18-8813-1 ①	AQ260A,B	8	18-8802-1
AQ140A	4	18-8813-1 ①	AQ260A,B	8	18-8823-1 ②
AQ145A,B	4	18-8813-1 ①	AQ271A-D	8	18-8802-1
AQ151A-C	4	18-8813-1 ①	AQ271A-D	8	18-8823-1 ②
AQ175A	V6	18-8801-1	AQ290A	8	18-8802-1
AQ190A	8	18-8802-1	AQ290A	8	18-8823-1 ②
AQ190A	8	18-8823-1 ②	AQ311A,B	8	18-8802-1
AQ200B-F	8	18-8802-1	AQ311A,B	8	18-8823-1 ②
AQ200B-F	8	18-8823-1 ②	BB140A	4	18-8813-1 ①
AQ205A	V6	18-8801-1	BB145A	4	18-8813-1 ①
AQ211A	8	18-8802-1	BB225A-C	8	18-8802-1
AQ211A	8	18-8823-1 ②	BB225A-C	8	18-8823-1 ②
AQ225B,D	8	18-8802-1	BB231A	8	18-8802-1
AQ225B,D	8	18-8823-1 ②	BB231A	8	18-8823-1 ②
AQ231A,B	8	18-8802-1	BB260A-C	8	18-8802-1
AQ231A,B	8	18-8823-1 ②	BB260A-C	8	18-8823-1 ②
AQ240A	8	18-8802-1	BB261A	8	18-8802-1
AQ240A	8	18-8823-1 ②	BB261A	8	18-8823-1 ②

Model	Ignition Type	Cyl.	O.E. #	Part #
AQ120B/ AQ125A/ AQ131A-D	Conventional	4	875571	18-8813-1
AQ140A/ AQ145A, B/ AQ151A-C	Conventional	4	875571	18-8813-1
BB140A/ BB145A	Conventional	4	875571	18-8813 -1
AQ175/ AQ205A	All Prestolite	6	876532-3	18-8801-1
AQ190A/ AQ200BF/ AQ211A	All Prestolite	8	8757166	18-8802-1/ 18-8823-1 ②
AQ225B,D/ AQ231A,B AQ240A	All Prestolite	8	8757166	18-8802-1/ 18-8823-1 ②
AQ225A,F/ AQ260A,B/ AQ271A-D	All Prestolite	8	8757166	18-8802-1/ 18-8823-1 ②
AQ290A/ AQ311A,B	All Prestolite	8	8757166	18-8802-1/ 18-8823-1 ②
BB225A-C/ BB231A	All Prestolite	8	8757166	18-8802-1/ 18-8823-1 ②
BB260A-C/ BB261A	All Prestolite	8	8757166	18-8802-1/ 18-8823-1 ②

① 18-8813-1 uses 7mm Wire

② For models with Mallory side terminal design



BATTERY CABLES
Gauge cable with soldered lug terminals on each end to accept a 3/8" stud.

Part No.	Size	Color	Gauge
BC88523	2'	red	4
BC88533	2'	black	4
BC88543	4'	red	2
BC88553	4'	black	2
BC88563	6'	red	2
BC88573	6'	black	2
BC88583	8'	red	1
BC88593	8'	black	1



18-5226
IGNITION WIRE
Metallic Core
100' Spool
7mm Hypalon



18-5225
SPARK PLUG WIRE KIT
Replaces:
Mercury 84-99215A26, 84-813706A26
Kit includes 25 ft. Roll of 7 MM Hypalon Ignition Wire With a Metallic Core and a Large Assortment of Three Different End Fittings.

PKG. OF 10



18-5224
18-5224-9①
SPARK PLUG WIRE TERMINAL
Replaces: Mercury 20121
OMC 510364

PKG. OF 10



18-5750
18-5750-9①
UNIVERSAL SPARK PLUG BOOTS
Supplied complete w/Terminal Connector
Replaces: OMC 581027, 580339



18-5752
UNIVERSAL SPARK PLUG BOOT
8mm



18-5657
PROTECTING SLEEVE
Replaces: 855798
Fits: Most Volvo gas & diesel engines

Standard Rotation

CCW Rotation

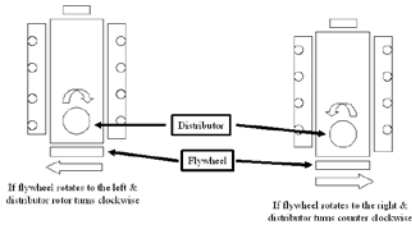

18-5923
STARTER
PMGR, Ford



18-5927
STARTER
PMGR, Ford



18-5911
STARTER



18-5900
REMANUFACTURED STARTER

(Heavy-Duty) (No Core) Clockwise
For GM engines, bottom mount straight across bolt pattern. Standard rotation.
Replaces: 834893, 855326
Replacement Solenoid: 18-5837
SAEJ1171



18-5903
STARTER
Replaces: 841066-4
(No Core)Clockwise
Bottom mount two bolt pattern for standard rotation FORD engines.
Replacement Solenoid: 18-5801

① Priced per Package



CE

18-5906
REMANUFACTURED STARTER
 Replaces: 840808
 (No Core) Clockwise
 Starter for late model 4 cyl. gas engines.
 Both ears are threaded.
 Replacement Solenoid: 18-5809



CE

18-5913
STARTER
 Replaces: 3856004, 3860764,
 3587625, 3853982, 3854751, 3885317
 (Clockwise)
 Delco permanent magnet gear reduction 2
 bolt starter. 12V - 11 Tooth Offset Bolt Pattern
 For: Late model GM 14" Flywheel
 Replacement Solenoid: 18-6287
SAEJ1171
 1.7 KW



CE

18-5919
STARTER
 Replaces: 3856003
 Permanent magnet I/O starter
 Fits: Chevy Engines with 14" flywheels
 Straight across bolt pattern
 Replacement Solenoid: 18-6287
SAEJ1171
 For: 3.0 GS
 1.7 KW



CE

18-5920
STARTER
 Replaces: 3854190
 Permanent magnet starter
 Replacement Solenoid: 18-6291
 For: 5.0 & 5.8 litre Ford engines



18-6275
STARTER
 Replaces: 3857747, 3860566
 • Inboard
 • Permanent Magnet Gear Reduction Starter
 • 2 Long Bolt Offset Pattern
 • CW Rotation
 • Use w/ Late Model 3.0L Engines with 14"
 Flywheel
 Replacement Solenoid: 18-6287
 Fits : Volvo Penta, Mercruiser, Marine Power



18-6292
STARTER
 Replaces: 872241
 • Inboard
 • Gear Reduction Starter
 • Permanent Magnet, 12 Volt
 • CW Rotation
 • Aluminum Pinion Housing w/2 Threaded
 Mounting Holes
 Fits : Volvo Penta 4 Cylinder and 6 Cylinder
 Gas Engines



NEW

18-6834
STARTER
 Replaces: GM Engines
 Used on Buick, Chevrolet, Oldsmobile, and Pontiac Race
 Engines



NEW

18-6835
STARTER
 Replaces: GM Engines
 Used on Buick, Chevrolet, Oldsmobile, and Pontiac Race
 Engines



NEW

18-6839
STARTER
 Replaces: 1357199, -7, 3523301, -4,
 5003564, -1
 Fits: 240,740,760,780,940 series 2.3L



NEW

18-6872
STARTER
 Replaces: 233991, 240501, 837924,
 842775, 843511, 847306-8, 881681
 Fits: TAMD, MD, AQD Models



NEW

18-6956
STARTER
 Replaces: 3803227, -2, 834625-6,
 841378-3, 841380, 841762, 63, 65, 66,



NEW

18-6958
STARTER
 Replaces: 847308-4, 870998, 881682
 Fits: MD, TMD, TAMD Models



**18-5882
ALTERNATOR**
Replaces: 3884950
75A, 12V, Serpentine
3.0L, 4.3L, 5.0L, 5.7L, 8.1L (2007 - Current)



**18-5957
ALTERNATOR**

Replaces: 3860769
(3-Wire) (68 AMP) (No Core)
Replaces Mando, Motorola and Original Equipment Delco.
Uses same electrical connections and mounting method.
Equipped with fan and drive pulley.
SAEJ1171



**18-5951
ALTERNATOR
REMANUFACTURED**



**18-5970
ALTERNATOR**
Replaces: 3803227, -2, 834625-6,
841378-3, 841380, 841762, 63, 65,
66,



**18-5979
ALTERNATOR**
Replaces: 3860082, Mando AC165622,
Lester 12391
65 amp, 3.0GSM-A/B/C, 3.0GSP-A/B/C, 3.0GLM-A/B,
3.0GLP-A/B, 4.3GXi-A/B/BF/C.CF.D.DF, 4.3OSI-B/BF/C/
CF/D/DF, 5.0GXi-A



**18-6261
ALTERNATOR**
Replaces: 3856600-6, 3857561
Mando for Late Model Volvo
Penta, 12 Volt, 65 Amp,
Internal Regulator, Single
Groove Pulley



**18-5959
ALTERNATOR**
Replaces: 826495, 834609,
834963, 841762, 841765, 841766.
Valeo A13N1M, 2M, 147M, 148M
14V/50 AMP: AQ120-AQ145, AQ200D-AD290-TMD40-
MD21-8070-MD5C, MD18-7D-MD30-TMD30-TAM30,
MD18-MD2B-MD2BHY-MD3B-MD21A, MD32A-
AQD32A/270D (Mot V8S), MD5-MD7-MD11-MD17-B21-
B22 Mot. TMD40), Series 2002-2003-R,V,S.



**18-5939
ALTERNATOR**
Replaces: 872235, 3803260, 873770
Valeo: A13N234, 2541451
14V/60 AMP: AQ115, AQ120B, AQ125, AQ130, AQ140,
AQ145, AQ165, AQ170, AQ200, AQ225, AQ256, AQ260,
AQ280, AQ290, BB115, BB145, MB20; Diesel Engine Ap-
plication: AQD2B, AQD21A, AQD21B, AQD27, AQD29, AQ-
D32A, MD11C, MD11D, MD17C, MD17D, MD2B, MD2010A,
MD2010B, MD2030A, MD2030B, MD2040A, MD2040B,
MD21A, MD21B, MD27, MD29, MD3B, MD32A, MD6A,
MD6B, MD7, TAM71A, TAM71B, TAM72A, TAM72W1-A.



**18-5943
ALTERNATOR**
Replaces: 872926, 3803227
Valeo: A13N259, 541663
14V/50 AMP: 431, 500, 501, 570, 740DP,
740/MSS, AQ131, AQ145B, AQ175, AQ200,
AQ205, AQ211, AQ225, AQ260, AQ271, AQ290,
AQ311, BB165, BB170, BB225, BB231, BB260,
BB261; Diesel Engine Application: 2001, 2002, 2003,
2003T, AD31A, AQAD30A, AQAD31A, AQAD40A,
AQAD41, AQAD41A, AQD40A, AQD41, AQD41A,
KAD42A, KAMD42A, MD30A, MS31A, MD40A, MD7B,
TAMD40A, TAM41A, TAM41A, TAM41B, TAM41D, TAM70E,
TMD30A, TMD31A, TMD40A, TMD41A.



**18-6845
ALTERNATOR**
Replaces: 3862613, 3862665,
3884950
Fits: 3.0GLM, 3.0GLP Engines



**18-6846
ALTERNATOR**
Replaces: Volvo Penta 1502272, 3803270-
2, 5001677, 845940, 72021, 872022,
872757, 873635, 873757, 873757-9,
873771,



**18-6847
ALTERNATOR**
Replaces: 3862613, 2655301,
Fits: 2000-07 3.0GLP, GSP, GSM, 4.3GXi, 5.0GXi, Si,
5.7Gi, GXi, Osi, Sxi



18-6848

ALTERNATOR

Replaces: Volvo 3862612, 2656299, Valeo A0002655299

Fits: 2000 and on Volvo Penta Models w/ 4.3, 5.0, and 5.7 GM engines



18-6953

ALTERNATOR

Replaces: Volvo

Fits: Diesel D3 Models



18-6955

ALTERNATOR

Replaces: Caterpillar 3001117, 10-258, Prestolite 110-258, 110-258A, Volvo 849748-9

Fits: Volvo Diesel 6 cylinder models

ALTERNATOR/STARTER APPLICATION

GASOLINE ENGINES

Model	Starter	Alternator	Model	Starter	Alternator
AQ115	18-5918	—	AQ280	18-5900	—
AQ120B	18-5918 ③	—	AQ290A	18-5900	18-5959
AQ120B	18-5906	—	AQ311A, B	18-5900	—
AQ125A	18-5918 ③	18-5959	BB115	18-5918	—
AQ125A,B	18-5906 ①	18-5959	BB140A	18-5918 ④	18-5959
AQ130	18-5918	—	BB140A	18-5906	—
AQ131A,B,C,D	18-5906	18-5959	BB145	18-5918	—
AQ140A	18-5918 ④	18-5959	BB145A	18-5918 ④	18-5959
AQ140A	18-5906 ①	18-5959	BB145A	18-5906 ②	—
AQ145	18-5918	18-5959	BB165, 170	18-5918	—
AQ145A	18-5918 ④	18-5959	BB225A,B,C	18-5900	18-5959
AQ145A,B	18-5906 ②	18-5959	BB260A	18-5900	18-5959
AQ151A,B,C	18-5906	18-5959	BB260B	18-5900	18-5959
AQ165	18-5918	—	BB260C	18-5900	18-5959
AQ170	18-5918	—	230, 250	18-5906	18-5943 ⑦
AQ171A,C	18-5906	18-5959 ⑩	251A	18-5906	—
AQ175A	18-5900 ④	—	430,431,432	18-5900	18-5943 ⑦ 18-5939 ⑤
AQ190A	18-5903	—	434	—	18-5943 ⑦ 18-5939 ⑤
AQ200B,C,D,F	18-5900	18-5959	500-570	18-5900	18-5943 ⑦ 18-5939 ⑤
AQ205A	18-5900	—	571A	18-5900	—
AQ211A	18-5900	—	572	18-5900	18-5943 ⑦ 18-5939 ⑤
AQ225A,B,C,D,E,F	18-5900	18-5959	740B	18-5900	18-5943 ⑦ 18-5939 ⑤
AQ231A, B	18-5900	—	3.0L (All models)	18-5919	—
AQ240A	18-5903	—	4.3L, 5.0 L, 5.7L,		
AQ255A,B	18-5900	—	7.4L, 8.2L (All models)	18-5913	—
AQ260A,B	18-5900	18-5959	5.0L, 5.8L		
AQ271A,B,C,D	18-5900	—	(All Ford models)	18-5920	—

① AQ125A beginning with S/N 7679/013489

② AQ145A & BB145A beginning with S/N 7705/001557

③ below S/N 7679/013489

④ below S/N 7705/001557

⑤ 18-5939 14V/50AMP

⑦ Mounting screw threads into bracket

⑩ 18-5959 14V/50AMP

ALTERNATOR/STARTER APPLICATION

DIESEL ENGINES

Model	Alternator	Model	Alternator	Model	Alternator
AD31B, D, XD	18-5943 ⑦	MD17	18-5959 ⑩	TAMD31B	18-5943 ⑦
AD31P, L	18-5939 ⑤	MD22A-A	18-5943 ⑦	TAMD31D	18-5943 ⑦
AD41D	18-5943 ⑦	MD22D-D	18-5939 ⑤	TAMD31L, M, P, S	18-5939 ⑤
D2-55A	18-5939 ⑤	MD22L-A	18-5943 ⑦	TAMD41B, D	18-5943 ⑦
D25A	18-5959 ⑩	MD22L-B	18-5939 ⑤	TAMD41L, M, P, S	18-5939 ⑤
D30A	18-5959 ⑩	MD31A	18-5943 ⑦	TAMD42B	18-5939 ⑤
D41D	18-5943 ⑦	MD201A	18-5939 ⑤	TAMD60C	18-5959 ⑩
D49A	18-5959 ⑩	MD201B	18-5939 ⑤	TAMD61A, 62A	18-5939 ⑤ 18-5959 ⑩
D63	18-5939 ⑤	MD201C	18-5939 ⑤	TAMD71A, 72A	18-5939 ⑤ 18-5959 ⑩
D71	18-5939 ⑤	MD202A	18-5939 ⑤	TAMD72P	18-5939 ⑤
D71D	18-5939 ⑤	MD202B	18-5939 ⑤	TAMD72WJ	18-5939 ⑤
D73	18-5939 ⑤	MD202C	18-5939 ⑤	TAMD100, 120	18-5976 ②
KAD42B	18-5939 ⑤	MD203A	18-5939 ⑤	TMD21D	18-5939 ⑤
KAMD42A	18-5943 ⑦	MD203B	18-5939 ⑤	TMD22A-A	18-5939 ⑤ 18-5943 ⑦
KAMD42B	18-5939 ⑤	MD203C	18-5939 ⑤	TMD22-B	18-5939 ⑤
MD5	18-5959 ⑩	MD204A	18-5939 ⑤	TMD31B, D, L	18-5943 ⑦
MD6	18-5959 ⑩	MD204B	18-5939 ⑤	TMD41B	18-5943 ⑦
MD7	18-5959 ⑩	MD204C	18-5939 ⑤	TMD41D, L	18-5939 ⑤
MD11	18-5959 ⑩	TAMD22D-B	18-5939 ⑤	2001, 2002, 2003	18-5943 ⑦

⑤ 18-5939 14V/50AMP

⑦ 18-5943 14V/50AMP

⑩ 18-5959 14V/50AMP

② 18-5976 28V/45AMP



18-6291
SOLENOID
 Replaces: 3854194-2, OMC 3854194
 Fits: Ford Gear Reduction
 Starters on Late Model 5.0L, 5.8L,
 OMC and Volvo Penta



18-5806
SOLENOID
 Replaces: 834520
 BOSCH 0331-302-050, 0331-302-081,
 0331-302-085, 0331-302-581, 0331-302-585
 For starters with aluminum nose.
 Slot in end of solenoid shaft is 13/32" long.



18-5811
STARTER SOLENOID
 Replaces: 3850216, 3859054
 For: PG 260 series starters, GM V6 & V8 (1983-Up)



18-5837
SOLENOID
 Replaces: 3853869, 3853998
 For: 3.0 ; GL, GS, 4.3L GL, GS, 5.7L GL, GI,
 7.4L GL, 8.2L GL



18-9802
TIMING LIGHT
 Self-powered accurate up to 10,000 RPM's



18-6271
RELAY
 Replaces: 870670, 6643474, 876038,
 241812
 12 Volt, 30 Amp



18-6268
RELAY
 Replaces: 841177, 872272
 12 Volt, 30 Amp



18-6266
RELAY
 Replaces: 876040, 872300
 12 Volt, 30 Amp



18-5705
POWER TRIM RELAY
 Replaces: 876039
 5 Terminal
 For: AQ 175, 200, 225D,
 260, 290A

① 18-5705D



18-5700
TRIM RELAY
 Replaces:
 3858081, 3858809
 For: (1998 SX-M-MAC, MDA, MLT), 3.0GLP-D,
 4.3GL-E, 4.3GL-EF, 4.3GXl-F, 4.3GXl-FF, 4.3OSl-F,
 4.3OSl-FF, 5.0GL-F, 5.0GL-FF, 5.0GXl-F, 5.0GXl-FF,
 5.0Sl-F, 5.0Sl-FF, 5.7Gll-F/FF, 5.7GXl-G/GF, 5.7OSl-E/
 EF, 5.7OXl-E/EF, 5.7Gll-F, 5.7GXl-G, 8.1Gll-G/GF,
 8.1GXl-F/FF, 8.1OSl-C/CF, 8.1Gll-G, 8.1GXl-F, DPH-A,
 DPH-B, DPR-A, DPH-B, EF drives, SX-M TSKs 1998-
 05, SX-M, DP-SM, (WT drives, PJX-C, PJX-S SX-M,
 -MACLT, -MDA, -MDB, -MHP, -MTD, DP-E, DP-S, -S1,
 -S2, DP-SM, -SM)XDP-B



18-5704
POWER TRIM RELAY
 Replaces: 876037
 20 Amps Resistive
 15 Amps Inductive
 Single Pull 5 Terminal
 For: AQ270, 280

PKG. OF 5



18-6951
18-6951-9^②
POWER TILT FUSE
(30 Amp)
 Replaces: 851120

① Items ending in "D" are Display Packaged - Regular number is Non-Display

② Priced per package



**18-6770
TILT/TRIM
PUMP**

Replaces: 854346
Oildyne
For: Early Version SX Drive with 2.5" bolt centers and fine threads



**18-6806
TRIM PUMP ASSEMBLY**

Replaces: 3587079, 3857489, 3860879
For: SX - Late Model with Coarse Thread



**18-6822
TRIM PUMP**

Replaces: Volvo Penta 852928, 820545, OMC 172543, 382715



**18-6804
TRIM MOTOR**

Replaces: 3861575
For: SX Drives - Later Version / 2.3" Bolt Centers w/ Coarse Thread



**18-6805
TRIM MOTOR**

Replaces: 3858071
For: SX - Early Version / Fine thread & 2.5" bolt centers



**18-6817
TRIM MOTOR**

Replaces: 854525-3
Fits: Late model Volvo Penta



**18-6838
TRIM MOTOR**

Replaces: 3586765, 852928, 872449, 873051
Fits: DP, DPX Drives



**18-6881
TRIM MOTOR**

Replaces: Volvo 852928, 872449, 873051,
Fits: DP, DPX Drives



**18-6823
WIRING HARNESS**

Replaces: Universal
Converts 3-wire Tilt and Trim motors to 2-Wire design



**18-6274
TILT/TRIM MOTOR**

Replaces: 852928, 3857265
Replaces: Prestolite HYK4001
Includes Hydraulic Valve Body



**18-6758
TILT/TRIM MOTOR**

Replaces: 850834
Electrolux KP5024/120



**18-6779
TRIM MOTOR**

Replaces: 986280, 3853945
For: PJX, SX, DPS, DP, DPX, 3.0L GS, GL, 4.3L GL, GS, GI, 5.0L FL, FI, 5.7L GL, GI, 5.8L FL, FI, FSI



**18-6790
TILT MOTOR**
Replaces: 839430,
Electrolux KS3448/290
Fits: Older model Volvo



**18-6791
TILT MOTOR**
Replaces: 850046, 853520
Fits: Older model Volvo



**18-6792
TILT MOTOR**
Replaces: 897720, 854329
Fits: Older model Volvo



**18-7627
INTAKE MANIFOLD**

Small-block GM with vortec cylinder heads



**18-7628
INTAKE MANIFOLD**

Small-block GM with vortec cylinder heads with brass lined water jackets



**18-7641
CARBURETOR
(Remanufactured)**

Replaces: 841047-4, 841313-0, 3856393
AQ225B,C,D,E,F; 225A,B; AQ260A,B; 290A; BB225A,AV,
BB225B,C; 260A,AV,B,C; 501A, 501A/MS4A; 570/MS4A



**18-7000
CARB KIT**

Replaces: 841836-0, 841292
SOLEX DOWN DRAFT
(856471 + 856472 = 18-7000)



**18-7001
CARB KIT**

Replaces: 841293-4
SOLEX SIDE DRAFT



**18-7008
CARB KIT**



**18-7040
CARB KIT**

Contains adjustable needle & seats



**18-7072
CARB KIT**

Replaces: 855889



**18-7085
CARB KIT**
Replaces: 875407



**18-7086
CARB KIT**
Replaces: 841994



**18-7095
CARB KIT**
Replaces: 834985-4



**18-7237
CARB KIT**



**18-7238
CARB KIT**
Replaces: 3854020
For: 4.3L GL, GS, 5.0L GL, 5.7L GL



**18-7241
CARB KIT**
Replaces: 3855017
For: 7.4L GL, 8.2L GL



**18-7242
CARB KIT**
Replaces: 3854105



**18-7244
CARB KIT**
Replaces: 3854106



**18-7245
CARB KIT**
Replaces: 3854107



**18-7246
CARB KIT**
Replaces: 3854116
For: 3.0L GLM, GLP, GSM, GSP, GS, GL



**18-7099
CARB GASKET SET**
Replaces: 824803, 856470



**18-7200
FLOAT**
Replaces: 841634-9
(ALCOHOL RESISTANT)
Brass



**18-7201
FLOAT**
(ALCOHOL RESISTANT)
Brass



**18-7202
FLOAT**
(ALCOHOL RESISTANT)
Brass

CARBURETOR KIT/FLOAT/CARBURETOR GASKET KIT APPLICATION

Model	Cyl.	Mfg Code	Carb Model	Carburetor #	Carb Kit ①	Carb Float	Carb Gasket Kit
AQ115A,B,125A,B,130C,D, AQ131A,B,C,D,145A,B AQ151A,B,C,171A,C BB115B,C,145A	4	—	—	SOLEX 44 PA1	18-7000	—	18-7099
AQ120B,140A,BB140A	4	—	—	SOLEX 44 PHN-3	18-7001	—	—
AQ80	4	—	—	ZENITH 34VN	18-7008	—	—
AQ95,95A,100,105A,110, 115 W/109", (1780cc) Dual Carb. Installation	4	ZS-1	150CD	150CD-SE (C1865F,R, C304D,F,R)	18-7085	—	—
AQ120, AQ130A,B,BB115A,w. 121" (1986cc) Dual Carb. Installation	4	ZS-1	175CD	175CD-2S, (C3098F,R, C3200 F,R,C,3231 F,R)	18-7085	—	—
3.0L GL,GS	4	H-2	2300	R-80316A,R-80316-1A	18-7246	—	—
AQ170A,B,C,BB170A,B,C	6	—	—	SOLEX 44 PA1	18-7000	—	18-7099
AQ165A,BB165A (3 Carb. Installation)	6	ZS-1	175CD	175CD-2S, (C3201F,M, R,C 3232F,M,R)	18-7085	—	—
AQ175A	6	R-2	2GE	17059059	18-7086	18-7200	—
4.3L GL,GS	6	H-2	2300	R-80312A,R-80312-1A	18-7238	—	—
4.3L GL,GS	6	H-4	4160	R-80403A,R-80403-1A	18-7237	—	—
AQ200D,F and 500A AQ225B,C,D,E,F,255A,B, AQ260A,B,290A,BB225A,AV, BB225B,C,260A,AV,B,C 501A,501A/MS4A,570/MS4A	8	R-2	2GE	17057133, 17059059	18-7086	18-7200	—
305" (5.0L),307" (5.0L),350" (5.7),	8	R-4	4ME, 4MC, 4MV	17059283,296, 298 7044288,7044289, 1705,628717,057,290	18-7095 18-7072	18-7201	—
5.0L, 5.8L (Fi, FL,SX) (Ford)	8	H-2	2300	R-80382A,R-80382-1A	18-7244	—	—
5.0L, 5.8L (Fi, FL) (Ford)	8	H-4	4150	R-80383A,R-80383-1A	18-7245	—	—
740A/MS5A	8	H-4	4011	R84026AA	18-7040	—	—
454" (7.4L)	8	R-4	4MC, 4MV	7044288,7044289, 1705,628717,057,290	18-7072	18-7201	—
7.4L GL	8	H-4	4150	R-80378A,R-80378-1A	18-7242	—	—
8.2L GL	8	H-4	4150	R-80378A,R-80378-1A	18-7242	—	—

① Does not include metering rods



**18-8114
FUEL LINE HOSE**

For fuel pump to carburetor connection. Replaces copper or steel tubing 3/8" X 31" PTFE composite hose with 5/8"-18 male inverted flare straight one end, 5/8"-18 90° one end. SAE J1527 type A1

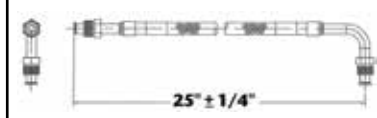

**18-8115
FUEL LINE HOSE**

For fuel pump to carburetor connection. Replaces copper or steel tubing 3/8" X 25" PTFE composite hose with 5/8"-18 male inverted flare straight one end, 5/8"-18 90° one end. SAE J1527 type A1



**18-7326
ELECTRIC FUEL PUMP**

Replaces: 3850809, 3858261, 3854620, 3857986



**18-7330
ELECTRIC FUEL PUMP**

Replaces: 3857650, 3855958



**18-7331
ELECTRIC FUEL PUMP**

Replaces: 3850810, 3857985, 3858714

ELECTRIC FUEL PUMP APPLICATION

Year	Engine	Application	OE #	#'s Superseded from	Part #
1994-99	262/4.3L (HU-WT)	High Pressure pump	3857650		18-7330
1994-99	262/4.3L GL/GS (All)	Carbureted - Low Pressure	3858261	3850809	18-7326
1994-99	262/4.3L GI (HU-WT)	W.Elec. Pump - Low Pressure	3858261	3850809	18-7326
1994-99	454/7.4L & 502/8.2L (HU-WT)	Low pressure system	3858714	3850810, 3857985	18-7331
1993-99	350/5.7L, 454/7.4L, & 502/8.2L	Engines w/MPI - High Pressure	3857650		18-7330
1996-99	454/7.4L & 502/8.2L (HU-WT)	Engines w/MPI - High Pressure	3857650		18-7330
1994-99	5.0L thru 5.8L	Low pressure electric fuel pump	3858261	3850809	18-7326
1994-99	454/7.4L & 502/8.2L (HU-WT)	GM Mark V Eng. - Low Pressure	3858714	3850810, 3857985	18-7331
1992-93	454/7.4L	GM Mark V Eng. - Low Pressure	3858714	3850810, 3857985	18-7331



**18-7268
FUEL PUMP**

Replaces: 3855276
For: 5.7L Liter Engines
Dual Diaphragm requires sight glass



**18-7281
FUEL PUMP**

Replaces: 826493
For: GM (V-8) 305, 350



**18-7286
FUEL PUMP**

Replaces: 841161
For: XP stamped steel pump
AQ120B (spec# 867465), AQ125A/B, AQ131A/B/C/D, AQ140A (spec# 867464), BB140A, AQ145A, BB145A, AQ151A/B/C, AQ171A/C, AQ230A/B, AQ250A/B, AQ251A

**18-7783
FUEL PUMP GASKET SET**

Replaces: 273663
Fits: D30, D31, D32, D40, D42, D44, AD30A, AQAD30A, TAMD30A, TMD30A, AD31A, AD31B, AD31D, AD31XD, AQAD31A, MD31A, TAMD31A, TAMD31B, TAMD31D, TMD31A, TMD31B, TMD31D, KAD32P-A, AD40B, AQAD40A, AQAD40B, AQD40A, MD40A, TAMD40A, TAMD40B, TMD40A, TMD40B, TMD40C, AD41A, AD41B, AD41D, AQAD41A, D41A, D41B, D41D, TAMD41A, TAMD41B, TAMD41D, TMD41A, TMD41B, TMD41D, KAD42A, KAD42B, KAD42P-A, KAMD42A, KAMD42B, KAMD42P-A, TAMD42B, TAMD42WJ-A, KAD43P-A, KAMD43P-A, KAD44P-A, KAMD44P-A

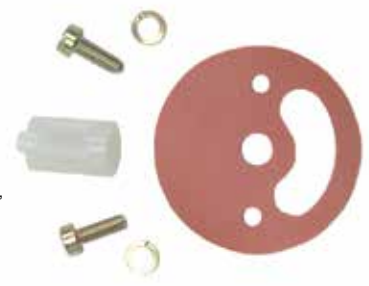

**18-7229
FLAME ARRESTOR**

Replaces: 3854026
For: 3.0L GS, GL, 4.3L GL, GS, GSI, 5.0L FL, FI, 5.7L GL, GI, 5.8L FL, FI, FSI

- UNIVERSAL DESIGN -

FUEL WATER SEPARATOR BRACKETS



Bracket Type	Part #	Bracket Type	Part #
1/4" Stainless Steel	18-7777	1/4" Aluminum	18-7853-1
3/8" Stainless Steel	18-7776	3/8" Aluminum	18-7775

FUEL WATER SEPARATOR KITS



21 MICRON FILTER KITS - FOR CARBURETED ENGINES

Kit Type	Part #	Micron Rating	Contents
1/4" Aluminum (Short Filter)	18-7848-1	21	1 - 18-7844 filter & 1 18-7853-1 bracket 2 - 18-4256 1/4" pipe plugs
1/4" Aluminum Bonus Pack Contains spare filter	18-7848-2	21	2 - 18-7844 filter & 1 18-7853-1 bracket 2 - 18-4256 1/4" pipe plugs
1/4" Aluminum (Tall Filter)	18-7852-1	21	1 - 18-7845 filter & 1 18-7853-1 bracket 2 - 18-4256 1/4" pipe plugs
1/4" Aluminum Bonus Pack Contains spare filter	18-7852-2	21	2 - 18-7845 filter & 1 18-7853-1 bracket 2 - 18-4256 1/4" pipe plugs
3/8" Aluminum (Tall Filter)	18-7775-1	21	1 - 18-7845 filter & 1 18-7775 bracket 2 - 18-4264 3/8" pipe plugs
1/4" Stainless Steel (Tall Filter)	18-7777-1	21	1 - 18-7845 filter & 1 18-7777 bracket 2 - 18-4256 1/4" pipe plugs
3/8" Stainless Steel (Tall Filter)	18-7776-1	21	1 - 18-7845 filter & 1 18-7776 bracket 2 - 18-4264 3/8" pipe plugs



10 MICRON FILTER KITS FOR FUEL INJECTED ENGINES

Kit Type	Part #	Micron Rating	Contents
1/4" Aluminum (Short Filter)	18-7983-1	10	1 - 18-7944 filter & 1 18-7853-1 bracket 2 - 18-4256 1/4" pipe plugs
1/4" Aluminum Bonus Pack Contains spare filter	18-7983-2	10	2 - 18-7944 filter & 1 18-7853-1 bracket 2 - 18-4256 1/4" pipe plugs
1/4" Aluminum (Tall Filter)	18-7982-1	10	1 - 18-7945 filter & 1 18-7853-1 bracket 2 - 18-4256 1/4" pipe plugs
1/4" Aluminum Bonus Pack Contains spare filter	18-7982-2	10	2 - 18-7945 filter & 1 18-7853-1 bracket 2 - 18-4256 1/4" pipe plugs
1/4" Aluminum (High Capacity Filter)	18-7966-1	10	1 - 18-7866 filter & 1 18-7853-1 bracket 2 - 18-4256 1/4" pipe plugs
3/8" Aluminum (Tall Filter)	18-7986-1	10	1 - 18-7945 filter & 1 18-7775 bracket 2 - 18-4264 3/8" pipe plugs
1/4" Stainless Steel (Tall Filter)	18-7984-1	10	1 - 18-7945 filter & 1 18-7777 bracket 2 - 18-4256 1/4" pipe plugs
3/8" Stainless Steel (Tall Filter)	18-7985-1	10	1 - 18-7945 filter & 1 18-7776 bracket 2 - 18-4264 3/8" pipe plugs



10 MICRON FILTER KITS WITH DRAIN BOWLS

Sierra AquaVue™ and metal bowl separator filters allow water to be drained from the filter to extend service life. Use the AquaVue™ bowl for outboard, above deck installations. USCG regulations require the use of the flame resistant metal bowl below deck.

Kit Type	Part #	Micron Rating	Contents
1/4" Aluminum w/ metal drain bowl	18-7951	10	1 - 18-7919 filter & 1 18-7853-1 bracket 1 - 18-7924 metal bowl 2 - 18-4256 1/4" pipe plugs
1/4" Stainless Steel w/ metal drain bowl	18-7938	10	1 - 18-7919 filter & 1 18-7777 bracket 1 - 18-7924 metal bowl 2 - 18-4256 1/4" pipe plugs

VOLVO STYLE BRACKETS AND SEPARATOR KITS

 <p>18-7778 VOLVO ALUMINUM REPLACEMENT BRACKET Replaces: 3850861</p>	 <p>18-7990-1 21 MICRON SEPARATOR KIT Contains: 1 - 18-7778 bracket 1 - 18-7789 filter</p>	 <p>18-7991-1 10 MICRON SEPARATOR KIT Contains: 1 - 18-7778 bracket 1 - 18-7989 filter</p>
--	---	--

COMPACT BRACKET AND SEPARATOR KIT - FOR SMALL OUTBOARDS AND FRESH WATER APPLICATIONS

 <p>18-7774 COMPACT ALUMINUM BRACKET</p>	 <p>18-7965-1 10 MICRON COMPACT SEPARATOR KIT Contains: 1 - 18-7774 bracket 1 - 18-7865 filter</p>
--	--

REPLACEMENT FILTERS



UNIVERSAL DESIGN

10 MICRON REPLACEMENT FILTERS			21 MICRON REPLACEMENT FILTERS		
Part #	Description		Part #	Description	
18-7944	Short - 3.875"		18-7844	Short - 3.875"	
18-7945	Long - 4.35"			Long - 4.35"	
18-7866	High Capacity - 6"			18-7845	Short - 3.875"
18-7865	Compact 10 Micron		Long - 4.35"		

REPLACEMENT FILTERS FOR VOLVO

10 MICRON REPLACEMENT FILTERS			21 MICRON REPLACEMENT FILTERS		
Part #	Description	Replaces	Part #	Description	Replaces
18-7946	OMC thread		18-7846	OMC thread	
18-7989	Volvo SX/EFI Cobra EFI	Volvo 3851218-2, 3852413, 3862228	18-7789	Volvo SX/EFI Cobra EFI	Volvo 3851218-2, 3852413



10 MICRON REPLACEMENT FILTERS AND KITS WITH DRAIN BOWLS

REPLACEMENT FILTERS

Part #	Description	Replaces
18-7919	Spin on replacement	Racor S3213
18-7920	Spin on replacement	Racor S3214
18-7947	Spin on replacement Fits - 120RRAC01	Racor S3240
18-7948	Spin on replacement Fits - 320RRAC01	Racor S3227
18-7949	Spin on replacement Fits - 660RRAC02	Racor S3232

REPLACEMENT BOWLS

Part #	Description
18-7924	Metal Collection Bowl

FILTER & BOWL KITS

Part #	Description
18-7929	Filter & Metal Bowl Contains: 18-7919 filter, 18-7924 bowl

**18-8125
DIESEL FUEL FILTER**

Replaces: 3583443
 D4-180i-B, D4-180i-C, D4-210A-A, D4-210A-B, D4-210i-A, D4-210i-B, D4-225A-B, D4-225A-C, D4-225i-B, D4-225i-C, D4-260A-A, D4-260A-B, D4-260A-C, D4-260D-B, D4-260D-C, D4-260i-A, D4-260i-B, D4-260i-C, D4-300A-A, D4-300A-C, D4-300D-A, D4-300D-C, D4-300i-A, D4-300i-C, D6-280A-A, D6-280A-B, D6-280i-A, D6-280i-B, D6-310A-A, D6-310A-B, D6-310D-A, D6-310D-B, D6-310i-A, D6-310i-B, D6-330A-B, D6-330A-C, D6-330D-B, D6-330D-C, D6-330i-B, D6-330i-C, D6-350A-A, D6-350A-B, D6-370A-B, D6-370A-C, D6-370D-A, D6-370D-B, D6-370i-A, D6-370i-B, D6-370i-C, D6-435D-A, D6-435D-C, D6-435i-A, D6-435i-C



**18-8126
DIESEL FUEL FILTER**

Replaces: 861477
 D1-13 A, D1-13 B, D1-20 A, D1-20 B, D1-30 A, D1-30 B, D2-40 A, D2-40 B, D2-55 A, D2-55 B, D2-55 C, D2-55 D, D2-55 E, D2-55F, D2-75 A, D2-75 B, D2-75 C, D2-75F, MD2010A, MD2010B, MD2020A, MD2020B, MD2030A, MD2030B, MD2040A, MD2040B



**18-7940
FUEL FILTER**

Replaces: 838593, 3588378, 860874
 KAD32P, TAMD42WJ, KAD43P/44P/300, KAMD43P/44P/300, KAMD42A, KAD42A, KAMD42P, KAD42P, MD22L-A, MD22A-A, TMD22A-A, MD22L-B, MD22P-B, TMD22-B, TMD22P-C, TAMD22P-B, TAMD42B, KAMD42B, KAD42B, TMD31L, TAMD31P/L/M/S, AD31P/L, TMD41L, TAMD41P/L/M/H, TMD41B, TAMD41B, D41B, AD41B (SN 2204141573 & Up), TMD41D, TAMD41D, D41D, AD41D, D41 (SN 2204141572 & Below), MD40, TMD40, TAMD40, AQAD40, KAD32P, TAMD42WJ, KAD43P/44P/300, KAMD43P/44P/300



**18-7858
FUEL FILTER
For CAV Type Unit**

Replaces: 858201
 AQ120B, 125A, B, 131A, 140A, 145A,B, 151, BB, 140, 145A



**18-7862
FUEL FILTER
ELEMENT
(Includes Gasket)**
 Replaces: 841162



**18-8149
HIGH CAPACITY
FUEL WATER SEPARATING FILTER**

Replaces: Volvo 3847644
 Fits most gasoline applications with electric fuel pump. (some height restrictions may occur when using with 18-7778, Volvo 3850861)



**18-7942
FUEL FILTER**

Replaces: 466987, 3825133
 For: MD100A, TMD100A, MD100B, MD120A, TMD120A, TAMD120A, MD120B, TMD120B, TAMD120B, MD70B, TMD70B, TAMD70B, THAM-D70B, AQAD70B, MD70C, TMD70C, TAMD70C, AQD70C, TAMD60A, TAMD60B, TAMD60C, D5/D7 MARINE GENSET, D5A-T, D5A-TA, D7A-T, D7A-TA, D7C-TA, D63 MARINE, D71/73 MARINE, KAD32P, TAMD42WJ, KAD43P/44P/300, KAMD43P/44P/300, TAMD103A, TAMD61A, TAMD62A, TAMD71A, TAMD72A, TAMD72P, TAMD72WJ, TAMD74, TAMD75 MARINE, TMD102A, TAMD102A, TAMD102D, TMD122A, TAMD122A, TAMD122P, TMD31L, TAMD31P/L/M/S, AD31P/L, TMD41L, TAMD41P/L/M/H



**18-7709
FUEL FILTER**

Replaces: 3840335
 Fits: KAD42P-A, KAMD42P-1, KAD44P-B, KAD44P-C, KAMD44P-A, KAMD44P-B, KAMD44P-C, TAMD42WJ-A, KAD43P-A, KAMD43P-A, KAT44P-C, KAD300-A, KAMD300-A, MD6A, MD6B, MD7A, MD7B, D41L-A, TAMD41H-B, TMD41L-A, AD41L-A, AD41P-A, TAMD41H-A, TAMD41P-A, MD22A, MD22A-A, MD22L-A, TMD22A, TMD22-A, D3-110i-A, D3-130A-A, D3-130i-A, D3-160A-A, D3-160i-A, D3-110i-B, D3-110i-C, D3-130A-B, D3-130i-B, D3-130A-C, D3-130i-C, D3-160A-B, D3-160i-B, D30160A-B, D3-160A-C, D3-160i-C, D3-190A-B, D3-190i-B, D3-190A-C, D3-190i-C, KKAD42A, KAMD42A, AD41D, D41D, TAMD41D, TMD41D, MD22L-B, MD22P-B, TMD22-B, TMD22P-C, TAMD22P-B



**18-7859
FUEL FILTER**
 Replaces: 835576
 For: AQ175, 200, 226, 266, 290, BB200, 225, 260



**18-8124
DIESEL FUEL FILTER**

Replaces: 829913
 Fits: 2001, 2001B, 2002, 2002B, 2003, 2003B/T/TB, AQD2B, MD11C/D, MD17C/D, MD1B, MD2B, MD3B, MD5A/B/C, MD7/B





**18-7792
FUEL FILTER**
Replaces: 3855104
For: Volvo 3.0L (1994-99),
OMC 3.0L (1995-98)



**18-7964
TRANSMISSION
FILTER KIT**
For: Mercruiser V-8 Inboard
with Hurth Transmission



**18-7717
FILTER ELEMENT**
For: Rochester 2 bbl &
4 bbl Carburetors



**18-79007
AIR FILTER**
Replaces: 3825038
Fits: TAMD63L-1, TAMD63P-A



**18-7689
FUEL INJECTOR**
Replaces: 3855182
Fits: 5.7GLPMDA, 5.7GIPMDA, 5.7GIPMDACE, 5.7GLIM-
DA, 5.7GIIMDA, 4.3GLPHUB, 4.3GSPHUB, 4.3GSPHUS,
4.3GIPHUSCE, 5.7GIPHUS, 4.3GLPNCA, 4.3GLPNCB,
4.3GLPNCS, 4.3GSJNCS, 4.3GSPNCS, 4.3GSPNCA,
4.3GSPNCB, 4.3GSPNCM, 4.3GSPNCS, 4.3GIPNCAE,
4.3GIPNCBCE, 4.3, 5.7GLPNCS, 5.7GIPNCACE,
5.7GIPNCSCCE, 5.7GIPNCMCE, 5.7GIPNCBCE,
5.7GIINCCCE, 5.7GIINCSCE, 4.3GLPKD, 4.3GLPLKE,
4.3GSPLKD, 4.3GSPLKE, 4.3GIPLKDC, 4.3GIPLKECE,
4.3GSJLKD, 5.7GLPLKA, 5.7GLPKD, 5.7GLPLKE,
5.7GLPLKR, 5.7GSPDK, 5.7GSPDK, 5.7GLPKDC, 5.7GLPKDC,
5.7GIPLKDC, 5.7GIPLKECE, 5.7GSICPKD, 5.7GSIPLK,
4.3GLPBYC, 4.3GSPBYC, 4.3GIPBYCCE, 4.3GSJBYA,
4.3GIJBYA (1994-07)



**18-7685
TBI INJECTOR**
Replaces: 3858941
Fits: 4.3GXi-A, 4.3GLPWTC, 4.3GLPWTR,
4.3GSPWTC, 4.3GSPWTR, 4.3GIPWTC,
4.3GIPWTR, 4.3GIJWTR, 4.3GSJWTR,
4.3GLPEFS, 4.3GIPEFS



**18-7702
AIR CHARGE
TEMPERATURE SENDER**
Replaces: 3854527
Fits: 5.0L Gxi-A(2001-02), 5.7L GiL-A
(2001), 5.7L Gi-A(2000-01), 5.7L GSiL-A
(2000-01), 5.7L Gxi-A(00-01), 5.7L XiL-A
(00-01), 5.7L Gxi-B(01-02), Many 7.4L
(1994-00), Many 8.1L (2005-Current)



**18-7601
AIR CHARGE
TEMPERATURE
SENSOR**
Replaces: 3854158
For: 5.0 Fi/5.8 Fi (1994-96) &
5.0 FL/5.8 FL/5.8 FSi (1995-96)



**18-7647
TEMPERATURE SENDER**
Replaces: 872066
Fits: 4.3GL-A, 4.3GL-B, 4.3GL-C, 4.3GL-D,
5.7GL-A, 5.7GL-B, 5.7GL-C, 5.7GL-D, 5.7GL-E,
5.0GL-A, 5.0GL-B, 5.0GL-C, 5.0GL-D, 5.0GL-E,
3.0GLP-A, 3.0GLP-B, 3.0GLM-A, 3.0GLM-B,
3.0GSP-A, 3.0GSP-B, 3.0GSP-C, 3.0GSM-A,
3.0GSM-B, 3.0GSM-C, 3.0GLM-C, 3.0GLP-C,
3.0GLP-D, 4.3GL-E, 4.3GL-EF, 5.0GL-F, 5.0GL-
FF, 3.0GLP-E, 4.3GL-G, 4.3GL-GF 4.3GL-J,
4.3GL-JF, 5.0GL-H, 5.0GL-HF, 3.0GLP-J,
3.0GLP-N, 5.0GL-J, 5.0GL-JF (1998-2007)



**18-7513
TEMPERATURE SENSOR**
Replaces: 3862500



**18-5897
TEMPERATURE
SENDER**
Replaces: 3853787
For: 5.0L FL, FI, 5.8L FL, FI, FSi



**18-7700
THROTTLE
POSITION SENSOR**
Replaces: 3857487
Fits: 4.3, 5.0, 5.7, 8.1, 8.2L models



**18-5899
OIL PRESSURE SENDER**
Replaces: 3857532
For: 230, 250, 3.0L GLM, GLP, GSM,
GSP, 4.3L GL, GXI, OSI, 5.0L GL, GXI,
OSI, 5.7L GL, GI, GXI, GiL, GXIL, OSI,
OSXI, 8.1L GI, GXI, OSI, GiL



**18-7704
IAC MOTOR**
Replaces: 3855194
Fits: 4.3, 5.0, 5.7, 7.4L models



**18-7705
IAC MOTOR**
Replaces: 3843751
Fits: 4.3GXIE-M



**18-7684
MAP SENSOR**
Replaces: 3850396
Fits: 4.3, 5.0, 5.7, 7.4L models
(1994-2007)



**18-7677
KNOCK SENSOR**
Replaces: 3850357
Fits: 4.3, 5.0, 5.7L models (2002-07)



**18-7703
KNOCK SENSOR**
Replaces: 3854512
Fits: 7.4, 8.2L (1999-2001)



**18-7679
KNOCK SENSOR**
Replaces: 3854905
Fits: 4.3L (1994-2002), 5.0L Gxi-A
(2001-02), 5.7L GiL-A(2001), 5.7Gi-A,
5.7GXi-A, 5.7GXi-B, 5.7GiL-A, 5.7GSiL-A,
5.7GXii-A, 5.7GXii-B(2000-03), 5.7GLPNCS,
5.7GIPNCACE, 5.7GIPNCBCE,
5.7GIPNCMCE, 5.7GIPNCBCE,
5.7GIINCCCE, 5.7GIINCSCE(1995-96)



**18-7888
DRAIN PLUG
& GASKET**
Replaces: 826648, 862293
For CAV Filter

PKG OF 10



SNAPPER CLAMPS

Part #	Range	Size
18-8200 ①	.360 - .406	2
18-8201 ①	.410 - .468	4
18-8202 ①	.475 - .536	6
18-8020 ①	.538 - .608	8
18-8021 ①	.597 - .665	10
18-8034 ①	.670 - .780	12
18-8203 ①	.750 - .875	14
18-8204 ①	.875 - .975	19



**18-3575
CIRCULATING
WATER PUMP**
Replaces: 3854017
Fits: 3.0L 4 cyl. engines
(Bi-Directional)



**18-3577
CIRCULATING WATER PUMP**
Replaces: 3855991, 856609
(Bi-Directional)



**18-3583
CIRCULATING WATER PUMP**
Replaces: 835390, 856364, 3853850
Fits: 4.3, 5.0, 5.7 engines
(Bi-Directional)



**18-3584
CIRCULATING WATER PUMP**
Replaces: 3853796
For Ford 5.0 and 5.8
(Bi-Directional)



**18-3599
CIRCULATING WATER PUMP**
Replaces: 3853850
For late model GM V-6 & V-8 engines
using a composite timing cover



**18-3586
WATER PUMP**
Replaces: 841640
(Crank Shaft Mounted)
Fits: 431A, 500A/B, 501A, 570A, 571A, AQ180, AQ200,
AQ200B/C/D/F, AQ250A, AQ211A, AQ225, AQ231A/B,
AQ260, AQ255B, AQ260A, AQ271A/B/C/D/, AQ280A,
AQ290A



**18-0368
WATER CIRCULATING
PUMP GASKET SET**
Fits: B21, B23, AQ120B, AQ125A, AQ140A, BB140A,
AQ145A, BB145A



**18-2779
EXHAUST HOSE**
Replaces: 3852696
For: 4.3L GL, GS, GI, GXI, OSI, 5.0L FI, GL, FL,
GXI, OSI, 5.7L GL, GI, GIL, OSI, GXI, OSXI, 5.8L
FL, FI, FSI, 7.4L GL, GI, 8.1L GI, GXI, OSI, 8.2L GL



**18-2780-1
HOSE**
Replaces: 3852741, 3863450
For: 3.0L GL, GS, GI, GLM, GLP, GSM, GSP, GS,
4.3L GL, GS, GI, GXI, OSI, 5.0L FL, FI, GL, GXI,
OSI, 5.7L GL, GI, GXI, OSI, OSXI, GIL, GXIL, 5.8L
FL, FI, FSI, 7.4L GL, GI, GSI, 8.2L GSI



**18-2781
EXHAUST HOSE**
Replaces: 3852742
For: 5.0L FL, GL, GXI, OSI, 5.7L GL, GI, GXI,
GIL, GXIL, OSI, OSXI, 5.8L FL, FSI, 7.4L GL,
GI, GSI, 8.1L, 8.2L GL, GSI



**18-3106
WATER PUMP COUPLER**
Replaces: 806256, 831009
AQ90, 95, 100, 110, 120A, 115, 130,
MB3B, 17C, D

**18-3175
WATER PUMP COUPLER**

Replaces: 858467
Fits: D31, D32, D41, D42, D43, D44, D300, AD31A, AD31B, AD31D, AD31L-A,
AD31P-A, AD31XD, AQAD31A, MD31A, TAMD31A, TAMD31B, TAMD31D, TAMD31L-
A, TAMD31M-A, TAMD31P-A, TMD31A, TMD31B, TMD31D, TMDL-A, KAD32P-A,
AD41A, AD41B, AD41D, AD41L-A, AD41P-A, AQAD41A, D41A, D41B, D41D, D41L-A,
TAMD41A, TAMD41B, TAMD41D, TAMD41H-A, TAMD41L-A, TAMD41M-A,
TAMD41P-A, TMD41A, TMD41B, TMD41D, TMD41L-A, KAD42A, KAD42B, KAD42P-A,
TAMD42B, TAMD42WJ-A, KAD43P-A, KAMD43P-A, KAD44P-A, KAD44P-B, KAD44P-
C, KAMD44P-A, KAMD44P-B, KAMD44P-C, KAD300A, KAMD300A



① This product is priced per piece. To order priced per package, please add -9 to the part number.



**18-3274
IMPELLER KEY**
Replaces: 808007
MD21B, AQD21B, 230A/SP-A/
MT, 230A, 230B, 250A, 250B,
AQ125B, AQ145B, AQ131A,
AQ151, AQ151A, AQ151B,
AQ151C, AQ171, AQ171A,
AQ171C, 251A



**18-3275
IMPELLER KIT**
Volvo 877066
Fits: TAM74A, A-A, A-B (2000-2005); TAM74C-A, C-B (2000-2005); TAM74L-A, B (1999-2005); TAM74P-A, P-B (1998-2005); TAM75P-A (1998-2005); TAM71B (1989-2000); TAM73P-A (1997-1998); TAM73WJ-A (1997-1999).



**18-3504
IMPELLER KIT**
Volvo 3588475
Fits: D4-180I-B, D4-180I-C, D4-180I-D, D4-210A-A, D4-210A-B, D4-210I-A, D4-210I-B, D4-225A-B, D4-225A-C, D4-225A-D, D4-225I-B, D4-225I-C, D4-225I-D, D4-260A-A, D4-260A-B, D4-260A-C, D4-260A-D, D4-260D-B, D4-260D-C, D4-260D-D, D4-260I-A, D4-260I-B, D4-260I-C, D4-260I-D, D4-300A-A, D4-300A-C, D4-300A-D, D4-300D-A, D4-300D-C, D4-300D-D, D4-300I-A, D4-300I-C, D4-300I-D



**18-3276-1
IMPELLER KIT**
Replaces: 3862567, 21213660
Fits: Volvo (1999 and Later)



**18-3277
IMPELLER KIT**
Replaces: 3862281, Yanmar
192470-42530, 192470-42532
Fits: Volvo (1998 and Earlier),
Johnson Pump 09-102 BB



**18-3047
IMPELLER KIT**
Replaces: 835874
Sherwood 10615K,
Jabsco 18948-0001
12 FINS



**18-3060
IMPELLER**
Replaces: 835512, 3854286
Sherwood 9959,
Jabsco 18838-0001
Oberdorfer 132-0317
OMC 3854286
Neoprene, 12 FINS



**18-3046
IMPELLER**
Replaces: 3854286



**18-3061
IMPELLER**
Replaces: 835874,
Sherwood 0615K,
Jabsco 18948-0001
Neoprene
12 FINS
For: GM engines with V-Belt



18-3075D Display Package
**18-3075
IMPELLER KIT**
Replaces: 875575, Jabsco 2877-0001,
4568-0001, Johnson 09-801B,
Oberdorfer B6620
12 FINS
Neoprene



**18-3076
IMPELLER KIT**
Replaces: 875583, 833995
Jabsco 22405-0001
Johnson Pump 09-45589,
09-808B
6 FINS, Neoprene



**18-3077 (Neoprene) 18-3038 (Nitrile)
WATER PUMP KIT**
Replaces: 877061-2, 3841697
For: AQ 30, 31, 40, 41 AQD 19, 27, 29, 32, KAD/KAMD
42A, B, P, MD, 19, 27, 29, 32, TAMD 60A, B, C



**18-3078 (Neoprene) 18-3037 (Nitrile)
WATER PUMP KIT**
Replaces: 875736, 875660, 2430184
Jabsco 836-0003,
Johnson Pump 09-1029B-9
For: AQ, AD 40 A, B, TAMD 40 A, B, TAMD 61-62 A, 71-72A



**18-3287
IMPELLER KIT**
Replaces: 876120
Fits: 431A, BB231A, 570A, 571A, 572A, 740A, 740B,
AQ200D, AQ205A, AQ225D, AQ255B, AQ260A, AQ260B,
AQ271A, AQ271B, AQ271C, AQ271D, AQ280A, AQ290A,
AQ311A, AQ311B, BB225A, BB225AV, BB225B, BB260A,
BB260AV, BB261A



**18-3079
IMPELLER KIT**
Replaces: 875807-0, 3586498
Johnson Pump 09-806B Sherwood 9979K
6 FINS
Neoprene
Jabsco 4528-0001
Side Width 3/4" Dia. 1 9/16"

① Items ending in "D" are Display Packaged - Regular number is Non-Display



18-3080
(Neoprene)
WATER PUMP KIT

Volvo 875808, 3593659
Jabsco 673-0001
Johnson Pump 09-1026B-1

For: AQ 60, 80, 90, 95, 100, 105, 110, 115, 120A, 130, B 16, BB 25, 30, 70, 100, MB 18, 20, MD 3B, 17C, D, ND2010B, 2020B, 2030B, 2040BC

18-3036
(Nitrile)

Jabsco 673-0003
Johnson Pump 09-1026B-9

① **18-3081D**

Display Package



18-3081
IMPELLER KIT

Replaces: 875811-2,
3858256, 3862281
OMC 3858256
Johnson Pump 09-1027B
Neoprene
12 SPLINES 12 FINS
Jabsco 1210-0001



18-3089
WATER PUMP KIT

Replaces: 09-45825
Johnson Pump
For 18-3587 Pump

18-30777
IMPELLER KIT

Replaces: 3841697

Fits: D70CHC, D70CRC, TD70CHC, TD70 CRC, KAD42P-A, KAD42, KAMD42, KAMD42P-A, DPX, HS1A, DP-D1, DP-E, DP-G, KAD32P, TAMD42WJ-A, KAD43P, KAMD43P, KAD44P, KAMD44P, KAD300, KAMD300, MD100A, TMD100A, MD100B, MD120, TMD120A, TMD120AK, TAMD120A, TAMD120AK, TMD120B, TAMD120B, TAMD120B-CC, TAMD60A, TAMD60B, TMD31L, TAMD31P/L/M/S, AD31P/L, TMD41L, TAMD41P/L/M/H, TAMD60C, MD70B, MD70BK, TMD70B, THAMD70B, TAMD70B, AQD70BL, AQD70B, MD70C, TMD70C, THAMD70C, AQD70C, TAMD70D, AQD70D, TAMD70E, AD30A, AQAD30A, MD30A, TAMD30A, TMD30A, AD30, AQAD30, MD30, TAMD30, TMD30, MD40, TMD40, AQD40, TAMD40, AQAD40, TMD41, D41A, TAMD41, AQAD41A, AD41A, AD41B, 290A, DP-A, DP-B, DP-1A, DP-B1, SP-A, SP-A1, TMD121C, TAMD121C, TAMD121D, TAMD122C, TAMD122D, MD31A, TMD31B, TAMD31B, AD31B, TMD41B, D41B, TAMD41B, AD31B, TMD41B, D41B, TAMD41B, AD41B, KAD42A, KAMD42A, DP-D, MS5B, AD31D, AD31XD, TAMD31D, TMD31D, AD41D, D41D, TAMD41D, TMD41D, DP-D1, DP-E, DP-S, DPX, SP-C1, HS1A, KAD42B, KAMD42B, TAMD42B.



18-3205
WATER PUMP REPAIR KIT

Replaces: 875574
AQ120B, 125A, B, 131A, 140A, 145A, B, 151A, B

18-3208
WATER PUMP REPAIR KIT

Replaces: 875584
MD5A, B, C, MD6B, MD7A, B, MD11C, D



18-3209
WATER PUMP REPAIR KIT

Replaces: 875383
AQ165A, 170A, B, C, MD21A (S/N MD103387 & UP), MD21B



18-3261
WATER PUMP REPAIR KIT

Replaces: 875769
Fits: D40, AD40B, AQAD40A, AQAD40B, TAMD40A, TAMD40B



18-3262
WATER PUMP REPAIR KIT

Replaces: 875759
For sea water pumps: Fits: D30, D31, D32, D40, D41, D42, D43, D44, AD30A, AQAD30A, TAMD30A, TMD30A, AD31A, AD31B, AD31D, AD31XD, AQAD31A, MD31A, TAMD31A, TMD31B, TAMD31D, TMD31A, TMD31B, TMD31D, KAD32P-A, AQD40A, MD40A, TMD40A, TMD40B, TMD40C, AD41A, AD41B, AD41D, AQAD41A, D41A, D41B, D41D, TAMD41A, TAMD41B, TAMD41D, TMD41A, TMD41B, TMD41D, KAD42A, KAD42B, KAD42P-A, KAMD42A, KAMD42B, KAMD42P-A, TAMD42B, TAMD42WJ-A, KAD43P-A, KAMD43P-A, KAD44P-A, KAMD44P-A

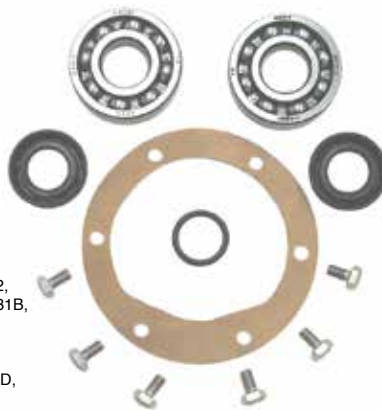

18-3263
WATER PUMP REPAIR KIT

Replaces: 875698
For sea water pumps: Fits: B18, B20, D3, D17, AQ60F, AQ90, AQ95A, AQ110, AQ120, BB30, BB100, MB18, AQ105A, AQ115A, AQ115B, AQ130A, AQ130B, AQ130C, AQ130D, BB115, BB115B, BB115C, MB20A, MB20B, MB20C, MD3B, MD17C, MD17D,



SINGLE DIAMETER HOSE

 <p>18-70021 MOLDED HOSE 3/4" ID</p> <p>4 3/4"</p>	 <p>18-70704 MOLDED HOSE 1 1/4" ID</p> <p>5"</p>	
 <p>18-70924 MOLDED HOSE 1 3/4" ID</p> <p>5"</p>	 <p>18-71218 MOLDED HOSE 1" ID</p> <p>12 1/2"</p>	 <p>18-71337 MOLDED HOSE 1 3/4" ID</p> <p>12 3/4"</p>

STRAIGHT HOSE

 <p>18-75100 MOLDED HOSE Straight 48" 1" ID</p>	 <p>18-75125 MOLDED HOSE Straight 48" 1 1/4" ID</p>
---	---

V-BELTS



- 1 High strength synthetic cords resist shockload failure. Their low stretch properties assure uniform performance over the life of the belt.
- 2 The compression section is a special rubber compound that assures smooth and even transfer of load forces to the cords.
- 3 Cogs are molded to precise engineering tolerances to improve flexibility and maintain cord support. Cog geometry provides a large area for air circulation to keep the belt cool and prevent damaging heat build up in the cushion section.
- 4 Rubber edges maintain positive, no-slip contact with pulley grooves for reliable energy transfer.

BELT SIZE LISTING BY NUMBER

Part #	Effective Length (Inches)	Top Width (Inches)	Part #	Effective Length (Inches)	Top Width (Inches)	Part #	Effective Length (Inches)	Top Width (Inches)
18-15290	29	29/64	18-15405	40 1/2	29/64	18-15460	46	29/64
18-15300	30	29/64	18-15410	41	29/64	18-15470	47	29/64
18-15325	32 1/2	29/64	18-15415	41 1/2	29/64	18-15480	48	29/64
18-15345	34 1/2	29/64	18-15430	43	29/64	18-15495	49 1/2	29/64
18-15370	37	29/64	18-15435	43 1/2	29/64	18-15500	50	29/64
18-15380	38	29/64	18-15440	44	29/64	18-15520	52	29/64
18-15390	39	29/64	18-15450	45	29/64	18-15550	55	29/64
18-15400	40	29/64	18-15455	45 1/2	29/64			

V-BELT INTERCHANGE

Part #	Volvo #	Part #	Volvo #	Volvo #	Part #	Volvo #	Part
18-15325	958303	18-15450	960336	829207	18-15460	# 960336	18-15450
18-15390	958310	18-15450	3858462	841821	18-15430	966382	18-15435
18-15405	958311	18-15455	3852464	950813	18-15410	985357	18-15415
18-15410	950813	18-15460	829207	950818	18-15460	958359-2	18-15435
18-15415	985357	18-15460	950818	952141	18-15500	958498	18-4046
18-4044	966694-2	18-15495	958320	958303	18-15325	966694-2	18-4044
18-15430	841821	18-15500	952141	958310	18-15390	966857	18-4046
18-15435	958314	18-4046	958498	958311	18-15405		
18-15435	958359	18-4046	966857	958314	18-15435		
18-15435	958359-2			958320	18-15495		
18-15435	966382			958359	18-15435		

HOSE INTERCHANGE

Part #	Volvo #	Part #	Volvo #	Volvo #	Part #	Volvo #	Part #
18-70704	838513	18-75125	826423	826423	18-75125	845792	18-75125
18-70704	856306	18-75125	845792	838513	18-70704	856306	18-70704

**Fits GM Small Block V8 305-350 cu. in.
Models AQ & BB 200, 205, 211, 231, 225,
260, 271, 290, 311, 500, 501, 570, 571 & 572**

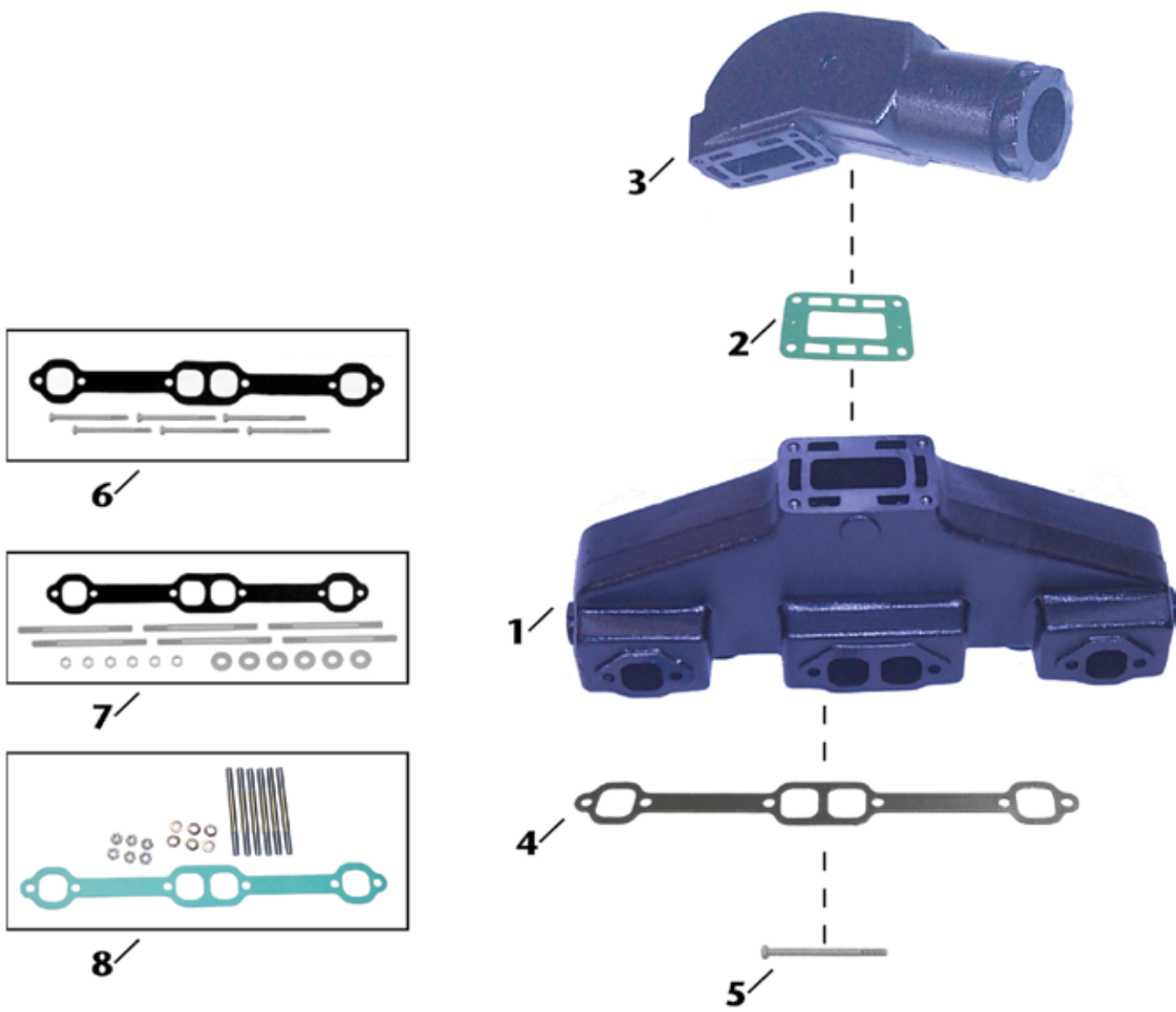

Item No	Description	OE No.	Application
1	18-1931-1 MANIFOLD	835804-6	GM Small Block (V8) 305-350 cu.in. Model AQ & BB 200, 205, 231, 225, 260, 271, 290, 311, 500, 501, 570, 571, & 572. Use with Manifold Gasket: 18-2949; Mounting Kit: 18-8511.
2	18-2971 ELBOW GASKET	856039-3	Use with Manifold: 18-1931-1; Elbow: 18-1935-1
3	18-1935-1 ELBOW	855384-4	Use with Manifold: 18-1931-1; Elbow Gasket: 18-2971.
4	18-2949 MANIFOLD GASKET	N/A	Use with Manifold: 18-1931-1; Included in 18-8511 mounting kit.
5	NSS MOUNTING BOLT	N/A	Included in 18-8511 mounting kit.
6	18-8511 MOUNTING KIT	N/A	Use with Manifold: 18-1931-1.
7	18-8502 MOUNTING KIT	N/A	Use with Manifold: 18-1931-1. Includes mounting studs and hardware.
8	18-8502 MOUNTING KIT	N/A	Use with Manifold: 18-1931-1. Includes mounting studs and hardware.

Fits GM V6 (1993 & Before) AQ 175, 205, 430A/B, 431, 434

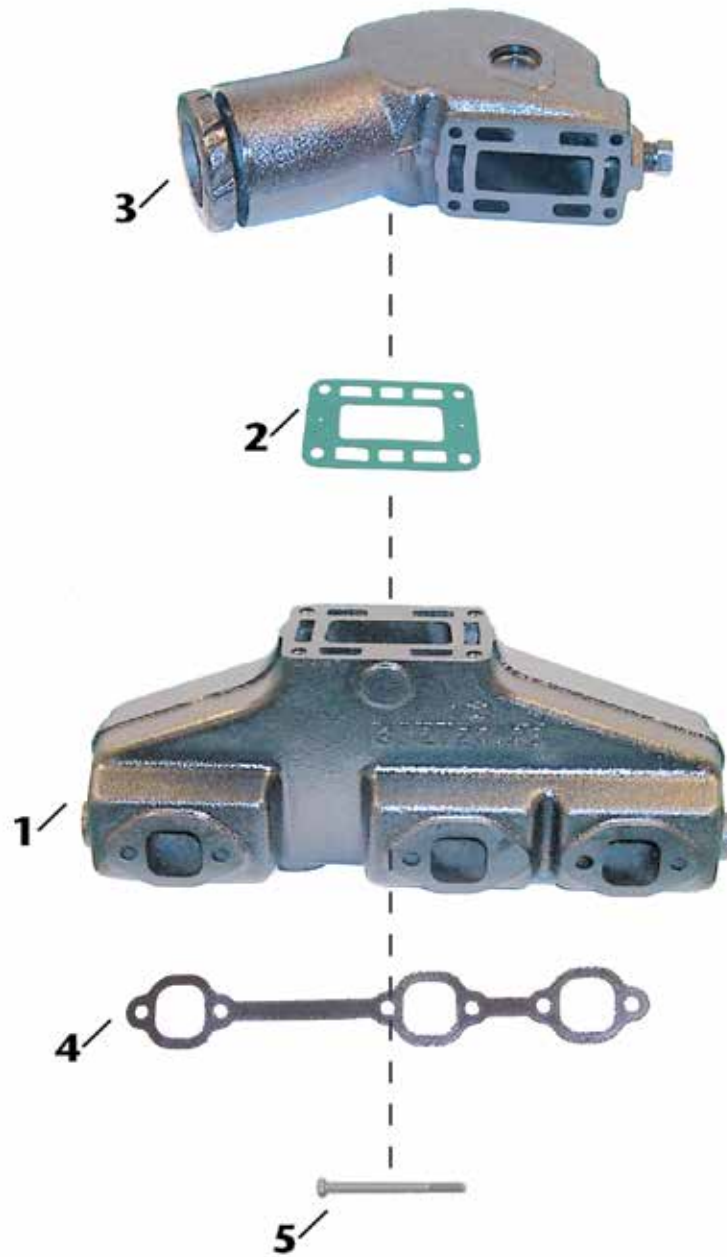

Item No	Description	OE No.	Application
1	18-1932 MANIFOLD	856894-1	GM (V6) (1993 & Before) Model AQ 175, 205, 430 A/B, 432, 434. Use with 18-2909 Manifold Gasket.
2	18-2971 ELBOW GASKET	856039-3	Use with Manifold: 18-1932; Elbow: 18-1936.
3	18-1936 ELBOW	857037-6	Use with Manifold: 18-1932; Elbow Gasket: 18-2971
4	18-2909 MANIFOLD GASKET	N/A	Use with Manifold: 18-1932.
5	NSS MOUNTING BOLT	N/A	Use to secure 18-2909 to 18-1932.

**SIERRA MANIFOLDS
ARE PAINTED, PACKAGED AND LEAK TESTED**



**18-1848
MANIFOLD**
Replaces: 3857656
Fits: Volvo 4.3L V-6



**18-1898
MANIFOLD**
Port & Starboard
Replaces: Barr CHVA-1-84, Marine Power 0991-110
Fits 454 cu.in. GM big block V8 engines
Use with:
Exhaust Manifold Gasket: 18-0418
***For Exploded View - See Pages 556-557**



**18-1930-1
MANIFOLD**
Replaces: 855387, 834438-4
FITS: Volvo AQ120B, 125A, 140A, 145A, BB140A, 145A
Supplied with Mounting Package
Use with:
Exhaust Manifold Gasket: 18-2991
Mounting Kit: 18-8539



**18-1931-1
MANIFOLD**
Port & Starboard
Replaces: 835804, 856883
FITS: Volvo AQ200D, 200F, 225D, 225E, 225F, 255B, 260A, 271A, 280A, 290A, 311A, AQ500, 570: BB225, 225AV, 225B, 260A, 260AV, 260B, 260C
Supplied with Mounting Package
Use with:
Mounting Kit: 18-8511



**18-1986-1
MANIFOLD**
Port & Starboard
Replaces: 3852374-2, 3857723, 3847501
For: 5.0L & 5.7L GM (New Style)
Use with:
Exhaust Manifold Gasket: 18-2949
Mounting Kit: 18-8502



**18-1932
MANIFOLD**
Port & Starboard
Replaces: 856894
For: 4.3L Fits: AQ175, AQ430, AQ431A, AQ431B, AQ432, AQ434
Use with:
Exhaust Manifold Gasket: 18-2909

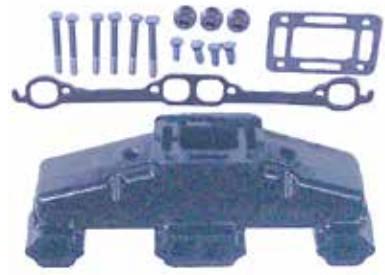

**18-1997-1
MANIFOLD**
Port & Starboard
Replaces: Barr CHV-1-83
Universal Center Riser Manifold
FITS: GM 283, 305, 307 and 350 CID engines
Use with:
Exhaust Manifold Gasket Set: 18-0604
***For Exploded View - See Pages 558-559**



**18-1936
RISER**
Replaces: 857037
For: 4.3L Fits: AQ175, AQ430, AQ431A, AQ431B, AQ432, AQ434
Use with:
Riser Gasket: 18-2971

18-1999

ELBOW

Replaces: Barr 20-0082
 Comes with 18-4364 Exhaust Elbow Kit (open)
 If blocked mounting kit is required use 18-8535
 Replaces: Barr 20-0082-P

Use with:
 Manifold: 18-1997-1
 Riser Gasket: 18-2854 open or 18-0476 blocked



18-1935-1

RISER

Replaces: 855384-4, 856891

Use with:
 Manifold: 18-1931-1
 Exhaust Riser Gasket: 18-2971
 Mounting Kit: 18-8510



18-1909-1

RISER

Replaces: OMC 913784, 3855270, 3850456,
 Volvo 3855270-9, 3863061
 OMC Riser, 4" outlet 7": Fits many GM & Ford center rise manifolds.

Use with:
 Manifold: 18-1986-1
 Riser Gasket: 18-0943-1 open
 Mounting Kit: 18-8507 open



18-1939

RISER

Replaces: Barr 20-0100, Marine Power 0992-593 Barr, Indmar,
 and Marine Power Ford Small Block V8 302-351cu.in., GM
 Small Block V8 305-350cu.in., GM Big Block V8 454cu.in.

Use with:
 Manifold: 18-1997-1, 18-1998-1
 Riser Gasket: 18-2854 open or 18-0476 blocked
 Mounting Kit: 18-4364 open or 18-8535 blocked



18-1907

RISER

Replaces: Barr 20-0102, Indmar 53-2009, 53-2018 Barr
 and Indmar Ford Small Block V8 302-351cu.in.

Use with:
 Manifold: 18-1997-1, 18-1998-1
 Riser Gasket: 18-2854 open or 18-0476 blocked
 Mounting Kit: 18-4364 open or 18-8535 blocked



18-1991

ELBOW ADAPTER

For use with 3" I.D. Exhaust Hose

Use with:
 Manifold Riser: 18-1999
 30°



18-1992-1

ELBOW ADAPTER

For 3" I.D. Exhaust Hose
 (As used in 18-1987 Exhaust Manifold
 Conversion Kit)
 80°



18-4007

EXHAUST ELBOW

Replaces: 845261
 Fits: D30, D40, AD30A, AQAD30, TAMD30A, TMD30A,
 AD40B, AQAD40A, AQAD40B, AQD40A, TAMD40A,
 TAMD40B, TMD40A, TMD40B, TMD40C



18-1949

MANIFOLD SPACER

Barr, Indmar and Marine Power Ford Small Block V8
 302-351cu.in., GM Small Block V8 305-350cu.in., GM Big
 Block V8 454cu.in.

Used with:
 Manifolds: 18-1998-1, 18-1997-1,
 18-1898



18-4364 (Open)

EXHAUST ELBOW KIT

Replaces: Barr 20-0082-P
 Use with:
 Riser: 18-1999, 18-1907, 18-1939





18-8502
EXHAUST MANIFOLD MOUNTING KIT
 OMC GM Small Block V8 305-350cu.in.
 (1979-89) OMC/Volvo GM Small Block
 305-350cu.in.
 Used with:
 Manifold: 18-1931-1, 18-1902, 18-1903
 & 18-1986-1



18-8507
EXHAUST ELBOW MOUNTING KIT
 OMC/Volvo GM Small Block V8
 305-350cu.in.
 Used with:
 Riser: 18-1909-1



18-8510
EXHAUST ELBOW MOUNTING KIT
 Volvo GM Small Block V8 305-350cu.in.
 (Models: AQ and BB200, 205, 211, 231, 225,
 260, 271, 290, 311, 500, 501, 570, 571, 572)
 Used with:
 Riser: 18-1935-1



18-8511
EXHAUST MANIFOLD MOUNTING KIT
 Volvo GM Small Block V8 305-350cu.in.
 (Models: AQ and BB200, 205, 211, 231,
 225, 260, 271, 290, 311, 500, 501, 570,
 571, 572)
 Used with:
 Manifold 18-1931-1



18-8535 (Blocked)
EXHAUST ELBOW MOUNTING KIT
 Barr, Indmar and Marine Power Ford Small
 Block V8 302-351cu.in., GM Small Block V8
 305-350cu.in., GM Big Block V8 454cu.in.
 Used with:
 Riser: 18-1939, 18-1999, and 18-1907



18-8536
EXHAUST ELBOW MOUNTING KIT
 Barr, Indmar and Marine Power
 GM Small Block V8 305-350cu.in.
 Used with:
 Manifold: 18-1997-1



18-8538
EXHAUST MANIFOLD MOUNTING KIT
 Barr and Indmar Ford Small Block
 V8 302-351cu.in.
 Used with:
 Manifold: 18-1998-1



18-8539
EXHAUST MANIFOLD MOUNTING KIT
 Volvo 4 Cylinder B20 2.3 and 2.5L (Models:
 AQ 120, 125, 131, 140, 145, and 151.
 BB140, 145, 230, and 250) Volvo 4 Cylinder
 B20 2.3 and 2.5L (Models: AQ 120, 125,
 131, 140, 145, and 151. BB140, 145, 230,
 and 250)
 Used with:
 Manifold: 18-1930-1

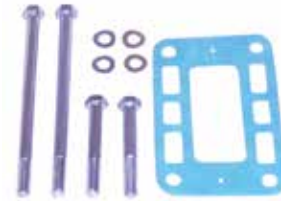

18-19360
HARDWARE KIT
 Used with:
 Riser: 18-1936



18-0146
HEAT EXCHANGER GASKET SET
 Fits: B21, B23, AQ120B, AQ125A, AQ140A,
 BB140A, AQ125B, AQ145A, AQ145B, BB145A

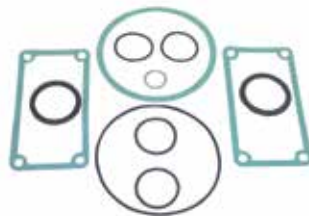

18-0337
HEAT EXCHANGER GASKET SET
 Fits: AD40B, AQAD40A, AQAD40B, TAMD40A,
 TAMD40B, TMD40B, TMD40C

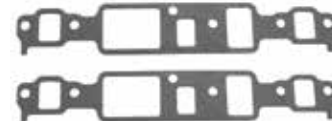

18-4408
**INTAKE MANIFOLD
 GASKET SET**
 Replaces: 3850379
 Fits: 4.3L GL, GS, GI



18-0476 (Blocked)
RISER BLOCKOFF GASKET
 Replaces: Barr 01-0105
 Indmar & Marine Power Ford
 Small Block V8 302-351cu.in.
 Used with:
 Riser: 18-1939, 18-1999 &
 18-1907



PKG. OF 2
18-2854 (Open)
18-2854-9
EXHAUST ELBOW GASKET
 Replaces: Barr 01-0107
 Used with:
 Manifold: 18-1999, 18-1939,
 18-1907



PKG. OF 2
18-2875
18-2875-9
EXHAUST ELBOW GASKET
 Replaces: 3850495
 For: 3.0L GS, GL, GLM, GLP, GSM, GSP

PKG. OF 2



18-2902
18-2902-9①
MANIFOLD GASKET
 Replaces: 3852468
 For: 5.0L GL, GXI, OSI, 5.7L GL, GI, GXI, GIL, GXIL, OSI, GXIL, OSXI

PKG. OF 2



18-2949
18-2949-9①
EXHAUST MANIFOLD GASKET
 Replaces: Barr CHV-47-000
 Used with: Manifold: 18-1986-1, 18-1997-1 and 18-1931-1
 AQ200, 225, 260, 271, 290, 311



18-2971
EXHAUST MANIFOLD GASKET
 Replaces: 835908-5, 856039-3
 Used with: Riser: 18-1935-1

PKG. OF 4



18-2991
18-2991-9①
EXHAUST MANIFOLD GASKET
 Replaces: 855967, 855383
 Used with: Manifold: 18-1930-1
 AQ200, 225, 260, 271, 290, 311



18-4461
HOSE BARB
 3/4" - 14 NPT x 1" Hose
 Corrosion Resistant Brass Fitting



PIPE PLUGS

Part #	Thread Size
18-4256	1/4"
18-4257	1/4"
18-4258	3/4"
18-4263	1/8" - 27 NPT
18-4264	3/8" - 18 NPT

56507 Pipe Sealant with Teflon® is recommended for use on plug threads.



DRAIN TAPS

Part #	Replaces:
18-4216	807036
18-4217	82744
18-4218	82745
18-4218D②	
18-4219	829592
18-4697	
18-4699	

18-3223-9 ③
 Bulk pack of 12 (18-4218)
 Use with most OEM manifolds











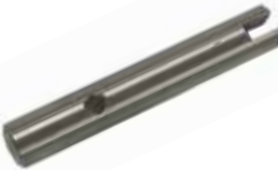







DRAIN TAP APPLICATION

Model	Thread Size	Location	Tap
MD1A,B,2A,B,3B,5A,B,MD6A	10 x 1	Cyl Block	18-4216
AQ90,95,100,105,110,115,120,130,140A,145A,B,151A,B,170,171A,MB18,20,BB30,100,MD19,21,32	1/8" NPT	Cyl Block	18-4217
AQ90,95,100,110,115,120,125A,B,130,131A,140A,145A,B,151A,B,171A,MB18,MB20,BB30,100,AQD40,AQAD40,TMD40	1/4" NPT	Cyl Block	18-4218
MD5C,11C,D,17C,D	1/8" NPT	Cyl Block	18-4219
B18, B20, B21, B23, B25, B30, D31,	1/4" NPT	Oil Cooler	18-4699
D40, 2001, 2002, 2003 V6, B23, B25, D30, D31, D40, D41	1/4" NPT	Oil Cooler	18-4697

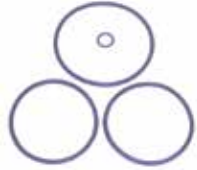
① Priced per Package
 ② Items ending in "D" are Display Packaged - Regular number is Non-Display
 ③ This product is priced per piece. To order priced per package, please add -9 to the part number

Model	Exhaust Manifold	Exhaust Elbow	Manifold Mounting Kits	Exhaust Elbow Kits	Manifold Gasket	Elbow Gasket
230	18-1930-1	-	18-8539	-	18-2991	-
250	18-1930-1	-	18-8539	-	18-2991	-
AQ120B	18-1930-1	-	18-8539	-	18-2991	-
AQ125A	18-1930-1	-	18-8539	-	18-2991	-
AQ131A,B,C,D	18-1930-1	-	18-8539	-	18-2991	-
AQ140A	18-1930-1	-	18-8539	-	18-2991	-
AQ145A,B	18-1930-1	-	18-8539	-	18-2991	-
AQ151A,B,C	18-1930-1	-	18-8539	-	18-2991	-
AQ200C,D/280	18-1931-1	18-1935-1	18-8511⑤/18-8502⑥	18-8510	18-2949	18-2971
AQ200D,F	18-1931-1	18-1935-1	18-8511⑤/18-8502⑥	18-8510	18-2949	18-2971
AQ225C,D/280	18-1931-1	18-1935-1	18-8511⑤/18-8502⑥	18-8510	18-2949	18-2971
AQ225D,E,F	18-1931-1	18-1935-1	18-8511⑤/18-8502⑥	18-8510	18-2949	18-2971
AQ255A,B/280	18-1931-1	18-1935-1	18-8511⑤/18-8502⑥	18-8510	18-2949	18-2971
AQ260A,B	18-1931-1	18-1935-1	18-8511⑤/18-8502⑥	18-8510	18-2949	18-2971
AQ290A	18-1931-1	18-1935-1	18-8511⑤/18-8502⑥	18-8510	18-2949	18-2971
AQ430	18-1932	18-1936	-	-	18-2909	18-2971
AQ431	18-1932	18-1936	-	-	18-2909	18-2971
AQ432	18-1932	18-1936	-	-	18-2909	18-2971
AQ434	18-1932	18-1936	-	-	18-2909	18-2971
BB140A	18-1930-1	-	18-8539	-	18-2991	-
BB145A	18-1930-1	-	18-8539	-	18-2991	-
BB225A,B,C	18-1931-1	18-1935-1	18-8511⑤/18-8502⑥	18-8510	18-2949	18-2971
BB260A,B,C	18-1931-1	18-1935-1	18-8511⑤/18-8502⑥	18-8510	18-2949	18-2971
500B	-	18-1936	-	-	18-2909	18-2971
501B	-	18-1936	-	-	18-2909	18-2971
570	18-1931-1	18-1935-1	-	-	18-2909	18-2971
572	-	18-1936	-	-	18-2909	18-2971
740B	-	18-1936	-	-	18-2909	18-2971
LK 4.3L	-	18-1936	-	-	18-2909	18-2971
LK 5.7L	18-1986-1	18-1909-1	18-8502	18-4364⑦/18-8535⑧	18-2949	18-2854⑦/18-0476⑧
HU 5.7 Gi	18-1986-1	18-1909-1	18-8502	18-4364⑦/18-8535⑧	18-2949	18-2854⑦/18-0476⑧
MD 5.7GL / 5.7Gi	18-1986-1	18-1909-1	18-8502	18-4364⑦/18-8535⑧	18-2949	18-2854⑦/18-0476⑧
NC5.7 GL / 5.7Gi	18-1986-1	18-1909-1	18-8502	18-4364⑦/18-8535⑧	18-2949	18-2854⑦/18-0476⑧

⑤ Volvo Configuration Match (Bolts Used in Hardware Kit) ⑦ Open Gasket
 ⑥ OMC Configuration Match (Studs Used in Hardware Kit) ⑧ Closed Gasket

<p>PKG. OF 5</p>  <p>18-4236 18-4236-9^① WASHER Replaces: 941907</p>	 <p>18-4150 WATER PUMP SHAFT Replaces: 812994 For Pump Without Ball Bearing AQ90, 95, 100, 105, 110, 115, 120, 130, MD3B, 17C</p>	 <p>18-2774 MOLDED HOSE Replaces: 875847 AQ290, AQ290DP Includes (2) 18-7306 Clamps</p>	 <p>18-2775 MOLDED HOSE Replaces: 875822 AQDRIVE UNITS 200, 250, 270, 270T, 275, 280, 280T, 280PT, DP UNIT: 280 Includes (2) 18-7306 Clamps</p>
 <p>18-2776 MOLDED HOSE Replaces: 832831 AQ270T, 280T Includes (2) 18-7306 Clamps</p>	 <p>18-0163 COOLING PIPE GASKET SET For: B30, AQ165A, AQ170A, AQ170B, AQ170C, BB165A, BB170A, BB170B, BB170C</p>	 <p>18-0376 COOLING PIPE GASKET SET Fits: D6, D7, MD6A, MD6B, MD7A, MD7B</p>	 <p>18-0377 COOLING PIPE GASKET SET Fits: B21, B23, AQ120B, AQ125A, AQ140A, BB140A, AQ125B, AQ145A, AQ145B, BB145A</p>
 <p>18-0590 COOLING PIPE GASKET SET Fits: B20, AQ125A, AQ115B, AQ130A, AQ130B, AQ130C, AQ130D, BB115A, BB115B, BB115C</p>	 <p>18-0648 COOLING PIPE GASKET SET Fits: D11, D17, MD11C, MD11D, MD17C, MD17D</p>	 <p>18-3889 COOLING PIPE GASKET SET Fits: B23, B25, 230A, 230B, AQ131A, AQ131B, AQ131C, AQ131D, 250A, 250B, 251A, AQ151A, AQ151B, AQ151C, AQ171A, AQ171C</p>	 <p>18-0606 COOLING PIPE GASKET SET Fits: B18, B20, AQ60F, AQ90, AQ95, AQ95A, AQ110, AQ120, BB30, BB100, MB18, AQ105A, MB20A, MB20B, MB20C</p>
 <p>18-0907 OIL DRAIN PLUG GASKET SET For oil plugs: Fits: 200, 250, 270, 270T, 275, 275A</p>	 <p>18-3890 OIL COOLER GASKET SET Fits: B20, B21, B23, B25, B30, AQ115A, AQ115B, AQ130A, AQ130B, AQ130C, AQ130D, BB115A, BB115B, BB115C, MB20A, MB20B, MB20C, AQ120B, AQ125A, AQ140A, BB140A, 230A, 230B, AQ145A, AQ145B, BB145A, 250A, 250B, 251A, AQ151A, AQ151B, AQ151C, AQ171A, AQ17C, AQ165A, AQ170A, AQ170B, AQ170C, BB165A, BB170A, BB170B, BB170C</p>	 <p>18-2777 THERMOSTAT HOUSING Replaces: 854031 *AQ120B, *AQ125A, B, AQ130A, B, D, *AQ130C, *AQ131A, AQ140A, AQ145A, *AQ165A, *AQ170A, B, C, *AQ175A, AQ200D, AQ225D, *AQ225E, AQ260A, AQ260B, AQ290A, *AQAD31A, AQD40A, AQD21A, AQAD40A * Models with Power Trim</p>	 <p>18-2778 THERMOSTAT HOUSING Replaces: 832846 AQ140A, AQ145A, AQ165A, AQ170A, *AQ175D, AQ200D, AQ225D, AQ260A, AQ290A, *AQ280, *AQ280L, AQAD30A, AQAD40A, B *Models with Power Trim</p>
 <p>18-3557 THERMOSTAT Replaces: 21148403 143°</p>	 <p>18-3558 THERMOSTAT Replaces: 3853799</p>	 <p>18-3654 THERMOSTAT KIT (60°C) Replaces: 875779</p>	 <p>18-3539 THERMOSTAT KIT Closed Cooling System (Includes sealing ring) Replaces: 3831426</p>

① Priced per Package



18-3538
THERMOSTAT KIT
 (Includes sealing ring)
 Replaces: 3831424

① **18-3676D** Display Package



18-3676
THERMOSTAT KIT
 Replaces: 3853983
140°
 — **Contains** —

Part #	OE#	Description
18-7170	3852071	O-Ring
18-2917	3852111	Gasket
—	3853983	Thermostat

① **18-3670D** Display Package



18-3670
THERMOSTAT KIT
 — **CONTAINS** —

Part #	O.E.#	Desc.
18-3558	3853799	Thermostat
18-2858	3852127	Thermostat Housing Cover Gasket
18-0929	3852120	Thermostat Gasket

① **18-3677D** Display Package



18-3677
THERMOSTAT KIT
 Replaces: 3856961
160°
 — **Contains** —

Part #	OE#	Description
18-7170	3852071	O-Ring
18-2917	3852111	Gasket
—	3856961	Thermostat



18-3656
THERMOSTAT KIT
 (60°C)
 Replaces: 876097, 875781

Display Package



18-3658
THERMOSTAT KIT
 (74°C)
 Replaces: 875784, 877349



18-3659
THERMOSTAT KIT
 (71°C)
 Replaces: 875785



18-3660
THERMOSTAT KIT
 (76°C)
 Replaces: 875787, 3831425



18-3662
THERMOSTAT KIT
 (62°C)
 Replaces: 875794, 876305



18-3663
THERMOSTAT KIT
 (55°C)
 Replaces: 875791



18-3664
THERMOSTAT KIT
 (74°C)
 Replaces: 875795



18-3665
THERMOSTAT KIT
 (60°C)
 Replaces: 875796



18-3666
THERMOSTAT KIT
 (82°C)
 Replaces: 875580



18-3615
THERMOSTAT - RAW WATER
 Replaces: 3587597



18-3617
THERMOSTAT KIT



18-3620
THERMOSTAT KIT



18-3621
THERMOSTAT KIT



18-3626
THERMOSTAT KIT



18-3618
THERMOSTAT KIT - RAW WATER COOLED



18-3619
THERMOSTAT KIT - FRESH WATER COOLED

THERMOSTAT APPLICATION ON NEXT PAGE

① Items ending in "D" are Display Packaged - Regular number is Non-Display

RAW WATER (OPEN) COOLING SYSTEM - RAW (RIVER, LAKE, SEA) WATER RUNS THROUGH CYLINDER BLOCK

Model	Version	Identifier	Model Year	Thermostat	Seal	Gasket	Thermostat & Seal Kit	Complete Kit Thermostat Seal Gasket
AQ90			1962-1964	NSS	18-2933		18-3656	
AQ95			1964-1968	NSS	18-2933		18-3656	
AQ100			1961-1963	NSS	18-2933		18-3656	
AQ130	A, B, C, D		1968-1977	NSS	18-2933		18-3656	
AQ115	A, B		1969-1975	NSS	18-2933		18-3656	
AQ140	A		1975-1979	NSS	18-2933	18-7181	18-3666	18-3620
AQ120	B		1977-1980	NSS	18-2933	18-7181	18-3666	18-3620
AQ145	A, B		1979-1985	NSS	18-2933	18-7181	18-3666	18-3620
AQ125	A, B		1981-1985	NSS	18-2933	18-7181	18-3666	18-3620
AQ131	A, B, C, D		1985-1989	NSS	18-2933	18-7181	18-3666	18-3620
230	A, B		1989-1993	NSS	18-2933	18-7181	18-3666	18-3620
AQ151	A, B, C		1985-1989	NSS	18-2933	18-7181	18-3666	18-3620
AQ171	A, C		1986-1989	NSS	18-2933	18-7181	18-3666	18-3620
250	A, B		1986-1993	NSS	18-2933	18-7181	18-3666	18-3620
251	A		1989-1992	NSS	18-2933	18-7181	18-3666	18-3620
3.0 GL, GS		MD,HU,NC	1993-1996	18-3558	18-0929	18-2858		18-3670
3.0 GL, GL, GSP, GLP, GLM		LK,BY,WT,EF	1996-2000	18-3558	NSS	18-0164		18-3621
3.0 GLP, GLM, GSP, GSM	A, B, C, D, E, J		2000-Current	18-3558	NSS	18-0164		18-3621
3.0 GXi, 3.0GXiC	J		2009-Current	18-3557	NSS	18-0164		18-3626
AQ175			1981-1985	18-3551	18-2933	18-0398		18-3662
AQ205	A		1988-1989	18-3551	18-2933	18-0398		18-3662
431	A, B		1989-1991	18-3551	18-2933	18-0398		18-3662
430	A, B		1990-1991	18-3551	18-2933	18-0398		18-3662
432	A		1992-1993	18-3551	18-2933	18-0398		18-3662
434	A		1992-1993	18-3551	18-2933	18-0398		18-3662
4.3 (All Models)		MD,HU,NC,LK, BY,WT,EF	1993-2000	NSS	18-7170	18-2917		18-3677
4.3 (All Models)	A, B		2001-2002	NSS	18-7170	18-2917		18-3677
4.3 (All Models)	C, D, E, F, G, J		2002-Current	NSS	NSS	18-2917	18-3615	18-3618
AQ190	A		1976-1977	18-3551		18-0398		18-3662
AQ200	B,C		1974-1976	18-3551		18-0398		18-3662
AQ225	B, C		1974-1976	18-3551		18-0398		18-3662
AQ200	D, F		1977-1986	18-3551		18-0398		18-3662
AQ225			1977-1986	18-3551	18-2933	18-0398		18-3662
AQ211	A		1986-1989	18-3551	18-2933	18-0398		18-3662
AQ231			1986-1989	18-3551	18-2933	18-0398		18-3662
500			1989-1993	18-3551	18-2933	18-0398		18-3662
501			1989-1993	18-3551	18-2933	18-0398		18-3662
5.0 FiP, FLP		MD,HU,NC	1993-1996	NSS	18-7170	18-2917		18-3677
5.0 GiP, GLP		BY,WT,EF	1997-2000	NSS	18-7170	18-2917		18-3677
5.0 GL, GXi, OSi	A, B		2001-2003	NSS	18-7170	18-2917		18-3677
5.0 (All Models)	C, D, E, F, G, H, J, K		2002-Current	NSS	NSS	18-2917	18-3615	18-3618
AQ271	A, B		1986	18-3551	18-2933	18-0398		18-3662
AQ260	A, B		1979-1985	18-3551	18-2933	18-0398		18-3662
AQ311	A		1986-1987	18-3551	18-2933	18-0398		18-3662
AQ271	C		1986-1989	18-3551	18-2933	18-0398		18-3662
AQ255	A, B		1977-1978			18-0398		
571	A		1989-1992	18-3551	18-2933	18-0398		18-3662
5.7 (All Models)		MD, HU, NC, LK, BY, WT, EF	1993-2000	NSS	18-7170	18-2917		18-3677
5.7 (All Models Except OSi)	A, B, C		2001-2003	NSS	18-7170	18-2917		18-3677
5.7 OSi, OSXi	B, C		2001-2003	NSS	NSS	18-2917	18-3615	18-3618
5.7 (All Models)	D, E, F, G, H, J, K		2002-Current	NSS	NSS	18-2917	18-3615	18-3618
5.8 (All Models)		HU, NC	1993-1996	NSS	18-7170	18-2917		18-3677
740	A, B		1991-1993	18-3551	18-2933	18-0398		18-3662
7.4 (All Models)		MD, HU, NC, LK, BY, WT, EF	1993-2000	NSS	18-7170	18-2917		18-3676
8.1 (All Models)			2000-Current	NSS	18-7170	NSS		18-3617
8.2 (All Models)		MD, HU, NC, LK, BY, WT, EF	1993-2000	NSS	18-7170	18-2917		18-3676
FRESH WATER (CLOSED) COOLING SYSTEM - ENGINE IS EQUIPPED WITH RESEVOIR TO HOLD ANTI-FREEZE								
4.3, 5.0, 5.7 (All Models)			1993 - Current	NSS	18-2933	18-2917	18-3539	18-3619
5.8 (All Models)			1993 - 1996	NSS	18-2933	18-2917	18-3539	18-3619
7.4 (All Models)			1991 - 2000	NSS	18-2933	18-2917	18-3539	18-3619
8.1 (All Models)			2000-Current	NSS	18-2933	18-2917	18-3539	18-3619
8.2 (All Models)			1993 - 2000	NSS	18-2933	18-2917	18-3539	18-3619



18-1476
CAMSHAFT KIT
 Fits:AQ165A, AQ170A, AQ170B, AQ170C, BB165A, BB170A, BB170B, BB170C



18-1477
CAMSHAFT KIT
 Fits:B18, B20, AQ60F, AQ90, AQ95, AQ110, AQ120, BB30, BB100, MB18, AQ105, AQ115A, AQ115B, AQ130A, AQ130B, AQ130C, AQ130D, BB115A, BB115B, BB115C, MB20A, MB20B, MB20C

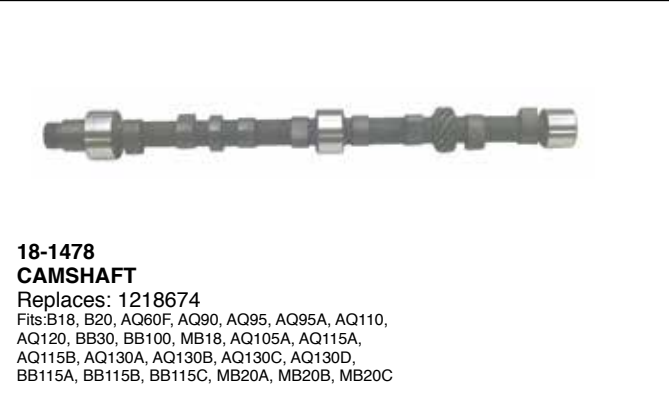

18-1478
CAMSHAFT
 Replaces: 1218674
 Fits:B18, B20, AQ60F, AQ90, AQ95, AQ95A, AQ110, AQ120, BB30, BB100, MB18, AQ105A, AQ115A, AQ115B, AQ130A, AQ130B, AQ130C, AQ130D, BB115A, BB115B, BB115C, MB20A, MB20B, MB20C



18-1479
CAMSHAFT
 Replaces: 461511
 Fits:B30, AQ165A, AQ170A, AQ170B, AQ170C, BB165A, BB170A, BB170B, BB170C



VALVES

Part #	Type	O.E. #	Application
18-4464	Exhaust	829620	D1, D2, D3, 3AA, D17, AQD2B, MD1B, MD2B, MD3B, MD11C, MD11D, MD17C, MD17D
18-4469	Exhaust	1542389	D40, AD40B, AQAD40A, AQAD40B, AQD40A, MD40A, TAMD40A, TAMD40B, TMD40A, TMD40B, TMD40C
18-4470	Exhaust	419735	B20, B30, AQ105A, AQ115A, AQ115B, AQ130A, AQ130B, AQ130C, AQ130D, BB115A, BB115B, BB115C, MB20A, MB20B, MB20C
18-4471	Exhaust	838638	D31, D32, D41, D42, D43, AD31L-A, AD31P-A, TAMD31L-A, TAMD31M-A, TAMD31P-A, TMD31L-A, KAD32PA, AD41L-A, AD41P-A, D41L-A, TAMD41H-A, TAMDS41L-A, TAMD41P-A, TMD41A, TMD41L-A, KAD42A, KAD42P-A, KAMD42A, KAMD42B, KAMD42P-A, TAMD42B, TAMD42WJ-A, KAD43P-A, KAMD43P-A
18-4463	Intake	833188	D1, D2, D3, 3AA, D17, AQD2B, MD1B, MD2B, MD3B, MD11C, MD11D, MD17C, MD17D
18-4466	Intake	838637	D31, D32, D41, D42, D43, AD31L-A, AD31P-A, TAMD31L-A, TAMD31M-A, TAMD31P-A, TMD31L-A, KAD32PA, AD41L-A, AD41P-A, D41L-A, TAMD41H-A, TAMDS41L-A, TAMD41P-A, TMD41A, TMD41L-A, KAD42A, KAD42P-A, KAMD42A, KAMD42B, KAMD42P-A, TAMD42B, TAMD42WJ-A, KAD43P-A, KAMD43P-A
18-4467	Intake	1542472	D40, AD40B, AQAD40A, AQAD40B, AQD40A, MD40A, TAMD40A, TAMD40B, TMD40A, TMD40B, TMD40C
18-4468	Intake	419734	B20, B30, AQ105A, AQ115A, AQ115B, AQ130A, AQ130B, AQ130C, AQ130D, BB115A, BB115B, BB115C, MB20A, MB20B, MB20C



18-4465
VALVE GUIDE
 Replaces: 3582609
 for exhaust, 230, 250, AQ115, BB115, MB20, AQ130, AQ165, BB165, AQ170, BB170, AQD21A, MD21A, AQ120B, AQ125A, AQ140A, BB140A, AQ125B, AQ131A, AQ131B, AQ131C, AQ131D, AQ145A, BB145A, AQ145B, AQ151A, AQ151B, AQ151C, MB10



18-4472
VALVE LIFTER
 Replaces: 1218630
 Fits:B18, B20, B30, AQ120, AQ90, AQ95, AQ110, AQ120, BB30, BB100, MB18, AQ105A, AQ115A, AQ115B, AQ130A, AQ130B, AQ130C, AQ130D, BB115A, BB115B, BB115C, MB20A, MB20B, MB20C, AQ165A, AQ170A, AQ170C, BB165A, BB170A, BB170B, BB170C



18-4473
VALVE GUIDE
 Replaces: 419653, 35882561
 Fits:AQ115, BB115, MB20, AQ130, AQ165, AQ170, BB170, AQD21A, MD21A, KAMD42A, KAD42A, KAMD42P, KAD42P, MD11, MD17, MD1B, MD2B, MD3B, MD30, TMD30, TAMD30, AQAD30, MD31A, TMD31B, TAMD40, AQAD40, TAMD42B, KAMD42B, KAD42B, TMD31D, TAMD31D, AD31D, AD31XD, TMD41B, TAMD41B, D41B, TMD41D, TAMD41D, D41D, AD41D



18-4474
VALVE GUIDE
 Replaces: 419652, 3582606
 For intake: Fits:230, 250, AQ115, BB115, MB20, AQ130, AQ165, BB165, AQ170, BB170, AQD21A, MD21A, AQ120B, AQ125A, AQ140A, BB140A, AQ125B, AQ131A, AQ131B, AQ131C, AQ131D, AQ145A, BB145A, AQ145B, AQ151A, AQ151B, AQ151C, MB10



18-4029
TIMING BELT
 Replaces: 463377
 AQ120B, 125A,B, 131A,B,C,D 140, 145, 151A,B,C, 230, 250, BB140A, 145A,B 4 Cyl.



18-4044
DRIVE BELT
 Replaces: 834548, 966694-2
 Generator: AQ120B, 125A, 140A, 145A, 165, 170A, B, C



18-4046
DRIVE BELT
 Replaces: 958498, 966857
 Generator:AQ175A, 200A, B, C, D, 225A,B, 260A, B, 280A, 290A
 Water Pump AQ210
 V-6, V-8



EXPANSION PLUGS

Part #	Pkg.	O.E. #	Size
18-4200 ① ②	5	477024	35MM (1.375")
18-4201 ① ②	5	192212	45MM (1.770")
18-4245 ②	5	463902	42MM (1.655")
18-4246 ②	5	463903-5	35MM (1.375")
18-4247 ②	5	463904	45MM (1.770")

① Stainless Steel

② This product is priced per piece. To order priced per package, please add -9 to the part number.



**18-2367
CYLINDER HEAD NUT**

Replaces: 943414

For cylinder head: Fits: D1, D2, D3, D11, D17, MD1B, AQD2B, MD2B, MD11C, MD11D, MD3B, MD17C, MD17D



**18-2793
SEAL RING KIT**

Replaces: 875550

For cylinder liner: Fits:D11, D17, MD11C, MD11D, MD17C, MD17D: NOTE: Model MD11 requires two 18-2793 and Model MD17requires three 18-2793



**18-1727
RUBBER CUSHION**

Replaces: 803762

For propeller shaft coupler:

Fits: B18, B20, B30, MB10, 2001, 2002, 2003, 2010, 2020, 2030, 2040, D1, D2, D3, D5, D6, D7, D11, D17, D21, D22, D29, D32, BB30, BB100, BB115, BB165, BB170, MB10A, MB18, MB20, MD1, MD2, MD3, MD5, MD6, MD7, MD11, MD17, MD21, MD22, MD29, MD32



**18-4005
ENGINE MOUNT**

Replaces: 833950

Fits:D5, D6, D7, D11, D17, MB10, MB10A, MD5A, MD5B, MD5C, MD6A, MD6B, MD7A, MD7B, MD11C, MD11D, MD17C, MD17D



**18-7907
AIR FILTER**

Replaces: 858488

Fits:D31, D41, D42, AD31A, AD31B, AD31D, AD31L-A, AD31P-A, AD31XD, AQAD31A, MD31A, TAM31A, TAM31B, TAM31D, TAM31L-A, TAM31M-A, TAM31P-A, TAM31A, TAM31B, TAM31D, TAM31L-A, AD41A, AD41B, AD41D, AD41L-A, AD41P-A, AQAD41A, D41A, D41B, D41D, D41L-A, TAM41A, TAM41B, TAM41D, TAM41H-A, TAM41L-A, TAM41M-A, TAM41P-A, TMD41A, TMD41B, TMD41D, TMD41L-A, TAM42B, TAM42WJ-A



**18-7908
AIR FILTER**

Replaces: 3582358

Fits:D31, D41, AD31A, AD31B, AD31D, AD31L-A, AD31P-A, AD31XD, AQAD31A, TAM31A, TAM31B, TAM31D, TAM31L-A, TAM31M-A, TAM31P-A, TAM31A, TAM31B, TAM31D, TAM31L-A, AD41D, AD41L-A, AD41P-A, AQAD41A, AQD41A, D41A, D41B, D41D, D41L-A, TAM41A, TAM41B, TAM41D, TAM41H-A, TAM41L-A, TAM41M-A, TAM41P-A, TMD41A, TMD41B, TMD41D, TMD41L-A



**18-7890
AIR FILTER**

Replaces:

463505, 876185

MD30, MD40, KAD42A, KAMD42A Diesel



**18-0035
DIESEL OIL FILTER, FULL FLOW**

Replaces: 3582732

Fits: D4-180i-B, D4-180i-C, D4-210A-A, D4-210A-B, D4-210i-A, D4-210i-B, D4-225A-B, D4-225A-C, D4-225i-B, D4-225i-C, D4-260A-A, D4-260A-B, D4-260A-C, D4-260D-B, D4-260D-C, D4-260i-A, D4-260i-B, D4-260i-C, D4-300A-A, D4-300A-C, D4-300D-A, D4-300D-C, D4-300i-A, D4-300i-C, D6-280A-A, D6-280A-B, D6-280i-A, D6-280i-B, D6-310A-A, D6-310A-B, D6-310D-A, D6-310D-B, D6-310i-A, D6-310i-B, D6-330A-B, D6-330A-C, D6-330D-B, D6-330D-C, D6-330i-B, D6-330i-C, D6-350A-A, D6-350A-B, D6-370A-B, D6-370A-C, D6-370D-A, D6-370D-B, D6-370D-C, D6-370i-A, D6-370i-B, D6-370i-C, D6-435D-A, D6-435D-C, D6-435i-A, D6-435i-C



**18-0036
DIESEL OIL FILTER, BYPASS**

Replaces: 3582733

Fits: D4-180i-B, D4-180i-C, D4-210A-A, D4-210A-B, D4-210i-A, D4-210i-B, D4-225A-B, D4-225A-C, D4-225i-B, D4-225i-C, D4-260A-A, D4-260A-B, D4-260A-C, D4-260D-B, D4-260D-C, D4-260i-A, D4-260i-B, D4-260i-C, D4-300A-A, D4-300A-C, D4-300D-A, D4-300D-C, D4-300i-A, D4-300i-C, D6-280A-A, D6-280A-B, D6-280i-A, D6-280i-B, D6-310A-A, D6-310A-B, D6-310D-A, D6-310D-B, D6-310i-A, D6-310i-B, D6-330A-C, D6-330D-B, D6-330D-C, D6-330i-C, D6-350A-A, D6-350A-B, D6-370A-B, D6-370A-C, D6-370D-A, D6-370D-B, D6-370D-C, D6-370i-A, D6-370i-B, D6-370i-C, D6-435D-A, D6-435D-C, D6-435i-A, D6-435i-C



SEE PAGES 152-154 FOR ADDITIONAL INFORMATION

OIL FILTERS

Part #	O.E. #	Application
18-8003	8692305	—
18-7824-1	835440	Short GM Filter
18-7876	3850559	Long GM Filter
18-7878-1	430143, 1266286, 3517857	Short Ford Filter
18-7879	841750	V-6 GM

DIESEL OIL FILTER

18-0032	847741	—
18-0033	478436	—
18-0034	477556	—
18-7880	466634	TAMD100, TMD102, TMD121, TMD122, TAMD122 & TAMD162
18-7884	834337	—
18-7974	3827069	—

**18-7974
OIL FILTER**

Replaces: 3827069

Thread Specs: 18mm x 1.5

Fits: Diesel Models AQD21A-B, AQD32A, MD21A/B, MD32A, TAM61A, TAM62A, TAM63L-A, TAM63P-A, TAM671A/B, TAM672A, TAM673P-A, TAM673WJ-A, TAM674A-A, TAM674A-B, TAM674C-A, TAM674C-B, TAM674P-B, TAM675P-A

CYLINDER HEAD ASSEMBLIES

*All cylinder heads are new castings and complete assemblies with new - stainless steel valves, hardened steel exhaust seats, valve springs, valve locks, and retainers.
All GM cylinder heads utilize high performance screw-in rocker arm studs in place of factory press in rocker arm studs.*



18-4484
CYLINDER HEAD ASSEMBLY
Fits: 5.7L V-8 GM (1969-86) with 12 intake manifold mounting bolts, perimeter mount valve cover



18-4485
CYLINDER HEAD ASSEMBLY
Fits: 5.7L V-8 GM (1987-95) with press in rocker arm studs with 12 intake manifold mounting bolts- (4 inside intake manifold bolts at 23 degrees), center mount valve covers



18-4486
CYLINDER HEAD ASSEMBLY
Fits: 5.7L V-8 GM Vortec (1996-Up) with press in rocker arm studs with 8 intake manifold mounting bolts, composite valve cover



18-4489
CYLINDER HEAD ASSEMBLY
Fits: 2.5L/3.0L GM (1968-95) (non MerCruiser LX models) (1968-95)



18-4491
CYLINDER HEAD ASSEMBLY
Replaces 4.3L Vortec V-6 (1996-Up) with screw in rocker arm studs (non-adjustable valve train), 8 intake manifold mounting bolts, center mount valve cover. NOTE: not for use with engines using factory roller rocker arms.



18-4495
CYLINDER HEAD ASSEMBLY
Replaces: 3854339,3853894
Fits: (1980& Up) 5.0L Ford with D-shape 58 cc combustion chamber



18-4501
CYLINDER HEAD
Fits: 5.0L Vortec



18-4502
CYLINDER HEAD
High Performance
Aluminum cylinder head sold in pairs only. This utilizes a 185cc intake runner/62cc exhaust runner and 2.02/1.60 stainless valves placed in a 72cc combustion chamber.
Fits: 5.7, 6.2L GM small block V-8



18-1400
HYDRAULIC LIFTER
 Replaces: 3856127
 GM 4.3L/V-6 Late/5.0L/5.7L



18-1401
HYDRAULIC LIFTER
 Replaces: 3853847, 985316
 Ford 302/351
 Ford 5.0L & 5.8L



18-1402
HYDRAULIC LIFTER
 Replaces: 3854033, 502036
 GM 2.5L/120
 For: Volvo 3.0L/181 CID GM 3.0L, 4.3L, 5.0L & 5.7L

ALL PISTONS ARE SUPPLIED COMPLETE WITH PISTON RINGS AND WRIST PIN.



RINGS

STD	OMC / VOLVO
18-3937	*14089025
18-3937	328506
18-3937	3853960
18-3937	914555
18-3937	3853268
18-3937	985083, 986336
18-3940	328536
18-3944	370409

RINGS (Cont.)

STD	OMC / VOLVO
.020	
18-3939	3854252
18-3939	914556
.030	
18-3938	*14089026
18-3938	328516
18-3938	914557

PISTONS

18-4161	3853340
	914816
18-4173	*14077948
18-4173	3911020
.020	
18-4160	3853477, 915236
.030	
18-4164	*14077949
	3911023
* OMC References GM Number	

PISTON/ RING APPLICATION

VOLVO		PISTONS			RINGS			Qty.
Model	Serial Number	Std.	.020	.030	Std.	.020	Per .030	Eng.
GM								
2.5L/153 CID		18-4180	18-4183	-	18-3942	-	-	4
3.0L/181 CID		18-4161	18-4160	18-4191	18-3937	18-3939	18-3938	4
4.3L/V-6		18-4173	18-4188	18-4164	18-3937	18-3939	18-3938	6
5.0L/305 CID		-	-	18-4178	18-3944	-	-	8
5.7L/350 CID		18-4173	18-4188	18-4164	18-3937	18-3939	18-3938	8
7.4L/454 CID		18-4171	18-4189	18-4172	18-3940	18-3950	18-3941	8
FORD								
5.0L/302 CID		-	-	-	18-3937	18-3939	18-3938	8



ROD BEARINGS

Part #	Size
18-1308	Std.
18-1309	.010
18-1327	Std.
18-1332	.020
18-1333	.010
18-1334	Std.
18-1337	.010
18-1341	.020

Rod bearings sold individually,
1 per rod



MAIN BEARINGS

Part #	Per Eng.	Size	Part #	Per Eng.	Size
18-1300	②	Std.	18-1316	②	.010
18-1311	②	Std.	18-1317	②	Std.
18-1315	②	Std.			

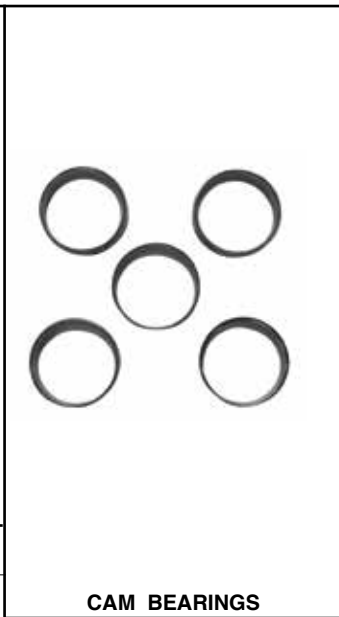

CAM BEARINGS

Part #	Per Eng.
18-1339	1 ②

BEARING APPLICATION

Model	ROD BEARING			MAIN BEARING			CAM BEARING
	Std.	.010	.020	Std.	.010	.020	

VOLVO

GM

3.0L/181 CID	18-1308	18-1309	18-1341	18-1317	18-1316	-	18-1339
4.3L/V-6	18-1327	18-1337	-	18-1311	-	-	-
5.0L/305 CID	18-1308	18-1309	18-1341	18-1300	-	-	-
5.7L/350 CID	18-1308	18-1309	18-1341	18-1300	-	-	-
7.4L/454 CID	18-1334	18-1333	18-1332	18-1315	-	-	-

FORD

5.0L/302 CID	-	-	-	-	-	-	-
--------------	---	---	---	---	---	---	---

18-0518
VALVE STEM SEAL
Replaces: 3854956, 914323, 3853132
For: most inline 4 and 6 cyl. GM (Early) and 305-350 CID GM

PKG. OF 8

18-4024
18-4024-9①
VALVE STEM SEAL
Replaces: 3853226, 914445
For: Chevy 4.3L/5.0L/5.7L

18-4031
VALVE STEM SEAL
Replaces: 1306630
AQ120B, 125A, B, 131A, 140A, 145A, B, 151A, B, MD1B, 2B, 3B, 5A, 2001, 2002, 2003, MD5B, C, 11C, D, 17C, D, 30, 31, 40, 41

One Piece Rear Main Seals

18-1234
Replaces: 3853528
For: 7.4L, GL, GI, GSI: 8.2L, GL

18-0519
Replaces: 3852657, 912957
4.3L/3.0L/5.0L 5.7L

Two Piece Rear Main Seals

18-0528
Replaces: 3852805

18-1211

Timing Cover Seals

18-1213
Replaces: 3853341

18-1230
Replaces: 3853827

① Priced per Package

② Complete Engine Set

	VOLVO SEAL APPLICATION		
Engine Model	2 Piece Rear Main Crankshaft Seal Conv. Rotation (LH)		Timing Cover Seal
GM			
3.0L/181 CID	18-1211 ②		18-1213
4.3L/V-6	18-1211 ②		18-1213
5.0L/305 CID	18-1211 ①		18-1213
5.7L/350 CID	18-1211 ①		18-1213
7.4L/454 CID	③		18-1233
FORD			
5.0L/302 CID	18-0528		18-1230
5.8L/351 CID	—		18-1230

① Large Journal Crankshaft GM Engine ② For one piece seal (LH) models use 18-0519 ③ For one piece seal (LH) models use 18-1234

FOR MODULAR GASKET SETS SEE PAGES 570-577



**18-0252
CONVERSION GASKET SET**
Replaces: 876314
Fits: D6, D7, MD6A, MD6B, MD7A, MD7B



**18-0489
CONVERSION GASKET SET**
Replaces: 876384
Fits: D11, MD11C, MD11D



**18-2814
SHORT BLOCK GASKET SET**
Replaces: 876306
(6 CYL.)



**18-2699
OUTDRIVE
GASKET**
For: SX and DP-SM Drives thru 2006
— CONTAINS —

Part #	Description	O.E. #	Qty.
18-7153	O-Ring	911851	2
18-2996	Outdrive Seal	911823	1



**18-2596
HEAD GASKET SET**
Replaces: 875422
Fits: D1, D2, D1A, MD1A, D2A, MD2, MD2A:
NOTE: Model MD2A requires two 18-2596



**18-3870
HEAD GASKET SET**
Replaces: 876303
Fits: B25, 251A, AQ171A, AQ171C



**18-4341
HEAD GASKET SET**
Replaces: 876380
Fits: D17, MD17C, MD17D



**18-4342
HEAD SET**
Replaces: 876376
Fits: D11, MD11C, MD11D



**18-2813
HEAD GASKET SET**
Replaces: 876302
(4 CYL.)

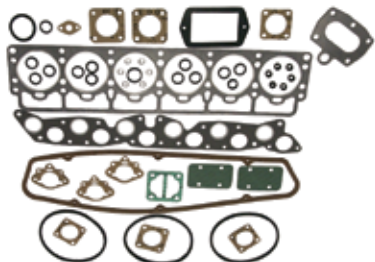

**18-2816
HEAD GASKET SET**
Replaces: 876337
(6 CYL.)

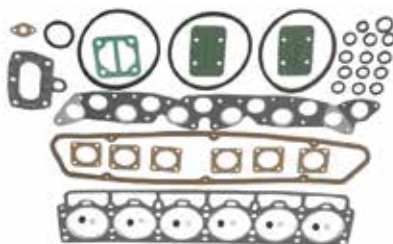

**18-2817
HEAD GASKET SET**
Replaces: 876359
(6 CYL.)



**18-2818
OIL PAN GASKET SET**
Replaces: 876433
(4 CYL.)

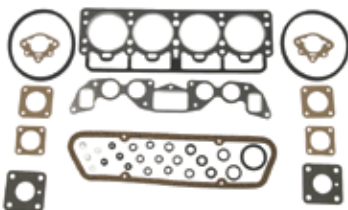

**18-2980
HEAD GASKET SET**
Replaces: 875401 (Old), 876356
(4 CYL.)



**18-2982
HEAD GASKET SET**
Replaces: 875569 (Old), 876358
(4 CYL.)



**18-2983
SHORT BLOCK GASKET SET**
Replaces: 875400 (Old), 876342
(4 CYL.)



**18-2998
HEAD GASKET SET**
Replaces: 386300
(4 CYL.)



**18-0410
INTAKE MANIFOLD
GASKET SET**
Replaces: 3853912, 3853913, 3854406
For: Volvo 5.0L FL, FI, 5.8L FL, FI, FSI



**18-0868
INTAKE MANIFOLD
GASKET SET**
Replaces: 3854269



**18-1238
INTAKE GASKET SET**
Replaces: 3850379, 912979
For: Volvo 4.3GL/GS 1994-96, 4.3Gi 1995-97



**18-0498
HEAD GASKET**
Replaces: 3580309
Fits: MD2030A, MD2030B



**18-2811
HEAD GASKET**
Replaces: 461618
(6 CYL.)

















**18-2812
HEAD GASKET**
Replaces: 430107
(6 CYL.)



**18-2946
HEAD GASKET**
Replaces: 3853336, 908611
Fits: GM 181 (3.0L) CID Eng.























**18-2965
HEAD GASKET**
Replaces: 419310, 419763-8
(4 CYL.)

 <p>18-2966 HEAD GASKET Replaces: 462623 (4 CYL.)</p>	 <p>18-2968 HEAD GASKET Replaces: 1378645 (4 CYL.)</p>	 <p>18-2970 HEAD GASKET Replaces: 1378646 (4 CYL.)</p>	
 <p>18-3834 HEAD GASKET Replaces: 833453</p>	 <p>18-3842 HEAD GASKET Replaces: 833274 Fits:D1,D2, MD1A, MD2A</p>	 <p>18-3843 HEAD GASKET Replaces: 859155 Fits:D40, AD40B, AQAD40A, AQAD40B, AQD40A, MD40A, TAMD40A, TAMD40B, TMD40B, TMD40C</p>	 <p>18-3867 HEAD GASKET Replaces: 859647 Fits:MD22A, MD22L-A, MD22L-B, MD22P-B, TAMD22P-B, TMD22A, TMD22B</p>
 <p>18-3868 HEAD GASKET Replaces: 3583786 Fits:D41, D42, D43, D44, AD41A, AD41B, AD41D, AD41L-A, AD41P-A, AQAD41A, D41A, D41B, D41D, D41L-A, TAMD41A, TAMD41B, TAMD41D, TAMD41H-A, TAMD41L-A, TAMD41M-A, TAMD41P-A, TMD41A, TMD41B, TMD41D, TMD41LA, KAD42A, KAD42B, KAD42P-A, KAMD42A, KAMD42B, KAMD42P-A, TAMD42B, TAMD42WJ-A, KAD43P-A, KAMD43P-A, KAD44P-A, KAD44P-B, KAD44P-C, KAMD44P-A, KAMD44P-B, KAMD44P-C</p>		 <p>18-3873 HEAD GASKET Replaces: 3853587 Fits:7.4L GL, GI, GSI, 8.2L GL</p>	 <p>18-3869 HEAD GASKET Replaces: 3584202 Fits:MD2040A, MD2040B</p>
 <p>18-3876 HEAD GASKET Replaces: 841207-4, 856474-2 Fits: GM 305 (5.0L)/350 (5.7L) CID Eng.</p>	 <p>18-3879 HEAD GASKET Replaces: 3854299, 912227, 914930 Fits: GM 262 (4.3L) CID Eng.</p>	 <p>18-3883 HEAD GASKET Replaces: 3853732 Fits: Ford 302 (5.0L) 351 (5.8L) CID Eng.</p>	 <p>18-3887 HEAD GASKET Replaces: 3853511 For: Volvo 7.4L</p>





















HEAD GASKET SET/GASKET SET/HEAD GASKET APPLICATION

Model	Head Gasket Set	Gasket Set	Head Gasket	Model	Head Gasket Set	Gasket Set	Head Gasket	Model	Head Gasket Set	Gasket Set	Head Gasket
AQ60	—	18-2983	—	AQ140A	18-2998	18-2818	18-2968	BB115C	—	—	18-2966
AQ90	—	18-2983	—	AQ145A	—	18-2818	18-2970	BB140A	18-2998	18-2818	18-2968
AQ95	—	18-2983	—	AQ145B	18-2813	—	18-2970	BB145A	18-2999	18-2818	—
AQ100	—	18-2983	—	AQ151A,B,C	18-2813	—	18-2970	BB165	—	18-2814	—
AQ105	—	18-2983	—	AQ165	—	18-2814	18-2812	BB170C	18-2817	18-2814	18-2811
AQ110	—	18-2983	—	AQ170A	—	18-2814	18-2812	BB30	—	18-2983	—
AQ115	—	18-2983	—	AQ170B	18-2816	18-2814	18-2812	MB18	—	18-2983	—
AQ115A	18-2980	—	18-2965	AQ170C	18-2817	18-2814	18-2811	MB20	—	18-2983	—
AQ115B,C	—	18-2982	18-2966	AQD2B	18-2985	—	18-3833	MB20A	18-2981	—	—
AQ120A	—	18-2983	—	B20 (0.8MM)	—	—	18-2965	MB20B	18-2980	—	18-2965
AQ120B	18-2998	18-2818	18-2968	B20 (1.2MM)	—	—	18-2966	MB20C	18-2982	—	18-2966
AQ125A	18-2998	18-2818	18-2968	B21	—	—	18-2968	MD11C,D	—	—	18-3834
AQ125B	18-2813	—	18-2970	B23	—	—	18-2970	MD17C,D	—	—	18-3834
AQ130	—	18-2983	—	B30 (0.8MM)	—	—	18-2812	MD1B	—	—	—
AQ130A	18-2980	—	18-2965	B30 (1.2MM)	—	—	18-2811	MD2B	18-2985	—	—
AQ130B	—	—	—	BB30	—	18-2983	—	MD3B	—	—	—
AQ130C	18-2980	—	18-2965	BB100	—	18-2983	—	230A,B	18-2813	—	—
AQ130D	18-2982	—	18-2966	BB115A,B	—	—	—	250A,B	18-2813	—	—
AQ131A,B,C,D	18-2813	—	18-2970								

<p>PKG. OF 2</p>  <p>18-0876 18-0876-9① FUEL PUMP GASKET For GM 4.3L, 5.0L & 5.7L Replaces: 3852113</p>	<p>PKG. OF 2</p>  <p>18-0889 18-0889-9① FUEL PUMP GASKET For GM 4.3L, 5.0L & 5.7L Replaces: 3852095</p>	<p>PKG. OF 2</p>  <p>18-2989 18-2989-9① CARB MOUNTING GASKET Replaces: 824677 AQ115, 125A, B, 130C, D, 131A, 145A, B, 151A, B, 170, 171A</p>	<p>PKG. OF 2</p>  <p>18-0398 18-0398-9① THERMOSTAT GASKET Replaces: 835417</p>
<p>PKG. OF 2</p>  <p>18-2933 18-2933-9① THERMOSTAT GASKET Replaces: 416033, 1317466 Used with most Volvo thermostats (Except AQ175, V-8, MD1A)</p>	<p>PKG. OF 2</p>  <p>18-2858 18-2858-9① THERMOSTAT HOUSING COVER GASKET Replaces: 3852127 For: 3.0L GS, GL, GLM, GLP, GSM, GSP</p>	<p>PKG. OF 2</p>  <p>18-0164 18-0164-9① THERMOSTAT HOUSING GASKET Replaces: 3852096 For: 3.0L GS, GL</p>	<p>PKG. OF 2</p>  <p>18-0929 18-0929-9① THERMOSTAT GASKET For: 3.0L GS, GL</p>
 <p>18-0183 EXHAUST MANIFOLD GASKET Replaces: 3853742, 3852455</p>	 <p>18-0680 EXHAUST MANIFOLD GASKET Replaces: 3853256</p>	 <p>18-0418 EXHAUST MANIFOLD GASKET Replaces: 3852472 For: Volvo 7.4L GL, GI, GSI, 8.2L GL, GI, GSI</p>	<p>PKG. OF 2</p>  <p>18-2909 18-2909-9① EXHAUST MANIFOLD GASKET Replaces: 856116, 3853412 For: Volvo 4.3GL, GS, GI, GXI, OSI</p>
 <p>18-2971 EXHAUST MANIFOLD GASKET Replaces: 856039, 835908 AQ200, 225, 260, 271, 290, 311</p>	 <p>18-2925 EXHAUST MANIFOLD GASKET Replaces: 461092 (Old), 1378913 AQ165, 170B, BB165, 170 6 Cyl.</p>	 <p>18-2922 EXHAUST MANIFOLD GASKET Replaces: 418870 (Old), 1378911 AQ90, 95, 100, 105, 110, 115, 120, 120A, 130, BB30, 100, 115, MB18, 20 4Cyl.</p>	 <p>18-2815 PUSH ROD COVER GASKET Replaces: 3852692 For: 3.0L</p>
 <p>18-1231 INTAKE GASKET Replaces: 3854095 For: Volvo 7.4L GL, GI, GSI, 8.2L GL</p>	<p>PKG. OF 2</p>  <p>18-2995 18-2995-9① HEAT EXCHANGE GASKET Replaces: 856037 AQ120B, 125A, B, 140A, 145A,B</p>	 <p>18-2928 EXHAUST MANIFOLD GASKET Replaces: 824633, 856044 AQ105, 115, 130, BB115, MB20 4 Cyl.</p>	 <p>18-2930 EXHAUST MANIFOLD GASKET Replaces: 1266796 (Old), 1378879 AQ125A, B, 145A, B, 131A, 151A, B, 120B, 140A</p>

SEE PAGES 166-167 FOR OUR COMPLETE LINE OF GASKET SEALANTS

① Priced per Package

<p>PKG. OF 2</p>  <p>18-2949 18-2949-9① EXHAUST MANIFOLD GASKET Replaces: 835966, 856034 AQ200, 225, 260, 271, 290, 311 V-8</p>	<p>PKG. OF 4</p>  <p>18-2991 18-2991-9① EXHAUST MANIFOLD GASKET Replaces: 855967, 855383 AQ120B, 125A, B, 131, 140, 145, 151, B21, B23</p>	 <p>18-0311 VALVE COVER GASKET Replaces: 3854942 For: 4.3 Litre 262 CID</p>	 <p>18-0664 VALVE COVER GASKET Replaces: 3852687 For: GM 305/350, 5.0 & 5.7L</p>
 <p>18-0347 VALVE COVER GASKET Replaces: 3852693 For: GM 153 & 181 CID (2.5L & 3.0L)</p>	 <p>18-0352 VALVE COVER GASKET Replaces: 3852818 For: Ford 302/351 CID (5.0L & 5.8L)</p>	 <p>18-2923 VALVE COVER GASKET Replaces: 419678 AQ105, 115, 120, 130, BB115, MB20 4 Cyl.</p>	 <p>18-2924 VALVE COVER GASKET Replaces: 430039 AQ165, 170, BB165, 170 6 Cyl.</p>
 <p>18-2927 VALVE COVER GASKET Replaces: 463999 (Old), 1378909 AQ120B, 125A, 140A, 145A, BB140, 145A 4Cyl.</p>	 <p>18-2972 VALVE COVER GASKET Replaces: 1378870 AQ125B, 145B, 131A, 151A, B</p>	 <p>18-2926 OIL PAN GASKET Replaces: 463587 (Old), 1378864 AQ90, 95, 100, 105, 110, 115, 120, 120B, 125A, B, 130, 131A, 140A, 145A, B, 151A, B, 171A</p>	 <p>18-0307 OIL PAN GASKET Replaces: 861250 Fits: D30, D31, D32, AD300A, AQAD30A, MD30A, TAM30A, TMD30A, AD31A, AD31B, AD31D, AD31L-A, AD31P-A, AD31XD, AQAD31A, MD31A, TAM31A, TAM31B, TAM31D, TAM31L-A, TAM- D31M-A, TAM31P-A, TMD31A, TMD31B, TMD31D, TMD31L-A, KAD32P-A</p>
 <p>18-0310 OIL PAN GASKET Replaces: 861251 Fits: D40, D41, D42, D43, D44, D300, AD40A, AQAD40A, AQAD40B, AQD40A, MD40A, TAM40A, TAM40B, TMD40A, TMD40B, TMD40C, AD41A, AD41B, AD41D, AD41L-A, AD41P-A, AQAD41A, D41A, D41B, D41D, D41L-A, TAM41A, TAM41B, TAM41D, TAM41H-A, TAM41L-A, TAM41M-A, TAM41P-A, TMD41A, TMD41B, TMD41D, TMD41L-A, KAD42A, KAD42B, KAD42P-A, KAMD42A, KAMD42B, KAMD42P-A, TAM42B, TAM42WJ-A, KAD43P-A, KAMD43P-A, KAD44P-A, KAD44P-B, KAD44P-C, KAMD44P-C, KAMD44P-B, KAMD44P-C, KAD300, KAMD300A</p>	 <p>18-1237 OIL PAN GASKET Replaces: 3856138</p>	 <p>18-1239 OIL PAN GASKET Replaces: 3853343 For: Volvo 3.0L</p>	 <p>18-0405 OIL PAN GASKET Replaces: 3852655 For: Volvo 4.3L</p>
 <p>18-1232 OIL PAN GASKET Replaces: 3853510 For: Volvo 7.4L GL, GI, GSI, 8.2L GL</p>	 <p>18-0903 WATER PUMP GASKET Replaces: 3853361 454 CID</p>	 <p>18-0327 WATER PUMP GASKET Replaces: 3853342 4 & 6 Cyl.</p>	<p>PKG. OF 2</p>  <p>18-0891 18-0891-9① WATER PUMP MOUNTING GASKET Replaces: 3852477 For: GM 4.3L, 5.0L & 5.8L</p>

① Priced per Package

<p>PKG. OF 2</p>  <p>18-0893 18-0893-9① WATER PUMP BACK-IN PLATE GASKET Replaces: 3850595 GM 4.3L, 5.0L & 5.7L</p>	 <p>18-0147 WATER PUMP GASKET For Ford V-8 Replaces: 3852824</p>	<p>PKG. OF 2</p>  <p>18-2979 18-2979-9① WATER PUMP GASKET Replaces: 1378906 AQ120B, 125A, 140A, 145A</p>	
 <p>18-0468 TIMING COVER GASKET Replaces: 3852654, 3853512 GM 4.3L, 5.0L & 5.7L</p>	<p>PKG. OF 2</p>  <p>18-0887 18-0887-9① TIMING COVER GASKET Replaces: 3852691 4 & 6 Cyl.</p>	 <p>18-25250 SEALING RING Replaces: 3863085 Fits: Volvo SX-A/DPS-A (2007 & Up)</p>	 <p>18-25251 SEALING RING Replaces: 853868 Fits: Volvo SX Thru 2006</p>
<p>PKG. OF 2</p>  <p>18-2519 18-2519-9① SEAL RING Replaces: 831622 For cooling water pipe 120B, 125A, B, 131A, 140A, 145A, B, 151A, B, 171A</p>	<p>PKG. OF 5</p>  <p>18-2525 18-2525-9① SEAL RING Replaces: 430018 Circulation pump to cylinder head AQ165A, 170A, B, C</p>	<p>PKG. OF 5</p>  <p>18-2526 18-2526-9① SEAL RING Replaces: 430172 Circulation pump to cylinder head AQ165A, 170A, B, C</p>	<p>PKG. OF 5</p>  <p>18-2527 18-2527-9① SEAL RING Replaces: 831617 For cooling water pipe AQ165A, 170A, B, C, MD21A (S/N MD-103387 & UP), MD21B</p>
<p>PKG. OF 5</p>  <p>18-2528 18-2528-9① SUPPORT RING Replaces: 831891 AQ120B, 125A, B, 140A, 145A, B</p>	<p>PKG. OF 5</p>  <p>18-2529 18-2529-9① SEAL RING Replaces: 831892 AQ120B, 125A, B, 140A, 145A, B</p>	 <p>18-4259 WASHER Replaces: 804261</p>	<p>PKG. OF 5</p>  <p>18-2530 18-2530-9① SEAL RING Replaces: 1336255, 3547991 Circulation pump to cylinder head AQ120B, 125A, B, 131A, 140A, 145A, B, 151A, B, 171A</p>
<p>PKG. OF 2</p>  <p>18-2934 18-2934-9① RUBBER SEAL Replaces: 829714 AQ90, 95, 100, 105, 110, 115, 120, 130, MD5A, B, C, 7A, B, 11D, MD2001, 2002, 2003T</p>	<p>PKG. OF 2</p>  <p>18-2935 18-2935-9① RUBBER SEAL Replaces: 418411 AQ90, 95, 100, 105, 110, 115, 120, 130, MB18, 20, BB30, 100, MD11C, D, 17C, D, MD2001, 2002, 2003, 2003T</p>	<p>PKG. OF 2</p>  <p>18-2936 18-2936-9① RUBBER SEAL Replaces: 418445 AQ90, 95, 100, 105, 110, 115, 120, 130, MB18, 20, BB30, 100, MD11C, D, 17C, D, 2001, 2002, 2003, 2003T</p>	<p>PKG. OF 2</p>  <p>18-2937 18-2937-9① RUBBER SEAL Replaces: 418412 AQ90, 95, 100, 110, 120B, 125A, B, 131A, 140A, 145A, B, 151A, B, 165A, 170, 171A, MD21A, B</p>

① Priced per Package

<p>PKG. OF 5</p>  <p>18-2994 18-2994-9^① RUBBER SEAL Replaces: 430020 AQ120B, 125A, B, 131A, 140A, 145A, B, 151A, B, 171A</p>	<p>PKG. OF 5</p>  <p>18-2996 18-2996-9^① OUTDRIVE SEAL Replaces: 3852560 3.0L GL, GS, 4.3L GL, GS, GI, 5.0L FL, FI, 5.7L GL, GI, 5.8L FL, FI, FSI</p>	<p>PKG. OF 2</p>  <p>18-0322 18-0322-9^① REAR SEAL GASKET Replaces: 3852656 GM 5.0L & 5.7L</p>	<p>PKG. OF 2</p>  <p>18-2929 18-2929-9^① COVER PLATE GASKET Replaces: 856028 AQ105, 115, 130, BB115, MB20</p>
<p>PKG. OF 2</p>  <p>18-2939 18-2939-9^① RUBBER SEAL Replaces: 814356 AQ200, 250, 270, 275, 280, 290</p>	<p>PKG. OF 2</p>  <p>18-0874 18-0874-9^① DISTRIBUTOR GASKET For GM V6 & V8 Replaces: 3852109</p>	<p>PKG. OF 2</p>  <p>18-4431 18-4431-9^① EXHAUST ELBOW GASKET Replaces: 3850496 Late Model Volvo Applications</p>	
<p>PKG. OF 2</p>  <p>18-2990 18-2990-9^① UPPER GEAR HOUSING GASKET Replaces: 832669 AQ270, 275, 280, 290</p>	<p>PKG. OF 2</p>  <p>18-2199 SHORT YOKE SPACER Replaces: 832675 AQ270, 275, 280, 290</p>	<p>PKG. OF 2</p>  <p>18-2945 18-2945-9^① (PKG. OF 50) DRAIN SCREW GASKET For: use with 18-2944 drain screw</p>	
 <p>18-2432 POWER TRIM HOSE Replaces: 873228 For: DP, DPX</p>	 <p>18-2433 POWER TRIM HOSE Replaces: 873229 For: DP, DPX</p>	 <p>18-21751 ENGINE COUPLER Replaces: 3853962-3 Fits: 2.5L (1986), 3.0L (1986-90), 4.3L, 5.0L, 5.7L (1986) KW & KWB suffix only, 7.4L (1990-98), 8.2L (1992-93, 1998)</p>	
 <p>18-21752-1 ENGINE COUPLER Replaces: 3858437-1 Fits: 4.3L (1986-Current), 5.0L (1986-88, 1998-Current), 5.7 (1986-92, 1994, 1996-Current)</p>	 <p>18-21753 ENGINE COUPLER Replaces: 985727, 3853862-5 Fits: Ford Engines 5.0L & 5.8L (1989-96)</p>	 <p>18-2194 TRIM FIN Replaces: 851452, 854040</p>	

① Priced per Package



**18-6456
IDLER PULLEY**
Replaces: 855507
Fits:251A, AQ171A, AQ171C



**18-9096
TRAWLING CLIP**
Volvo 3847547
Fits: Volvo SX-A, DPS-A (2007-Up)

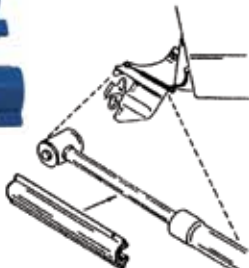

**18-9098
TRAWLING CLIPS**
Replaces: 174448
Set of 2
For all SX Models thru 2006



**18-2772-1
TRANSOM
SEAL KIT**
For: SX Drives

— CONTAINS —

Part #	Description	O.E. #	Qty.
18-2100	Gimbal Bearing	3853807	1
18-2765	Bellows	3854127	1
18-1074	Bellows	3850426-2	1
18-2996	Seal	3852560, 911823	1
18-7315	Hose Clamp	853012-3	1



STAINLESS STEEL CLAMPS

Part #	Sizes	O.E. #
18-7300 ① ②	50MM	—
18-7306 ① ②	38MM	853548
18-7314	—	3852604
18-7315	112MM	853012



**18-2744
DRIVE BELLOWS KIT**
Replaces: 875826, 876294
(with ridge)
AQ200, 250, 270, 270T, 275, 280, 280T,
PT, 290 DP UNIT: 280, 290



**18-2755
DRIVE BELLOWS KIT**
Replaces: 875827
SAIL DRIVE: 100S, AQ DRIVE: 100, 100B



**18-2757
EXHAUST
BELLOWS KIT**
with flapper valve
Replaces: 875828, 876633
AQ175, 280, 280DP, T, PT, AQD40,
AQAD40, V-8



**18-2758
EXHAUST
BELLOWS KIT**
Replaces: 875848, 876631
AQ200, 250, 270, 275, 280, 280DP,
290, 290DP



**18-1074
EXHAUST BELLOWS**
Replaces: 3850426
For: SX Drives includes 302, 432,
434, 502, 572, 584, 744 (1994-98)
Uses 18-7314 Clamp



**18-2765
U-JOINT BELLOWS**
Replaces: 3854127
For: DP-S, SX



**18-2766
EXHAUST HOSE**
Replaces: 834751
(I.D. 95MM, LENGTH 160 MM)
V-8

① This product is priced per piece. To order priced per package, please add -9 to the part number.
② Priced per Package



**18-6523
SPRING SET**

For reverse tilt lock: Fits: AQ250, 270, 275, 275A, 280, 280DP, 280L, 285A, 290, 290A, 290DP, SP-A, SP-A/MT, SP-A1, SP-A2, DP-A, DP-A1, DP-A2, DP-B, DP-B1



**18-0184
RUBBER RING**

Replaces: 804190
For clamp ring: Fits: 230A/SP-AMT, 250A/SP-AMT, 500A, 501A, 571A, 740A, AQ100, AQ105, AQ110, AQ115A, AQ110B, AQ120A, AQ120B, AQ125A/B, AQ130A/B, AQ131A/D, AQ175A, AQ190A, AQ200A/C/D/F, AQ210A, AQ211A, AQ225A/B/C/D/E/F, AQ231A/B, AQ240A, AQ255A/B, AQ260A/B, AQ271A/B/C/D, AQ280A, AQ290A, AQ311A/B, AQ60F, AQ80, AQ90, AQ95, AQD19, AQD29A, AQD32A



**18-8368
RUBBER RING**

Replaces: 813967
For clamp ring: 230A/SP-A/SP, A1, 230B, 250A/B, 251A, 430A/B, 431A/B, 432A, 434A, 500B, 501B, 570A, 572A, 740B, AD31A/B/D/XD, AD40B, AD41A/B/D, AQ100, AQ105, AQ110, AQ115A/B, AQ130A/B, AQ131B/C, AQ140A, AQ145A/B, AQ151A/B/C, AQ171A/C, AQ205A, AQ60F, AQ90, AQ95, AQAD30A, AQAD31A, AQAD40A/B, AQAD41A, AQD19, AQD21A/B, AQD40A, D41A/B/D, KAD32, KAD42A/B/F, KAD43P, KAD44P, KAMD42A, TAMD41A



HEAVY DUTY U-JOINTS

Part #	O.E. #	Application
18-2104	897707, 853255	AQ200,250,270, 280,290 (Rockwell)
18-2174	3850812	3.0L GS, GL, 4.3L GL, GS, GI, 5.0L GL, GI, 5.7L GL, GI, 5.8L FL, FI, FSI



**18-2100
LINK BELT
GIMBAL BEARING**

Replaces: 3853807
Fits: OMC/Volvo- 3.0L, 4.3L, 5.0L, 5.7L, 7.4L (1994-1998), 5.8L (1994-1996), 8.2L(1998)



**18-2337
YOKE**

Replaces: 3850814
Fits: 3.0L GS, GL, 4.3L GS, GL, GI, 5.0L FL, FI, 5.7L GL, GI, 5.8L FL, FI, FSI



**18-2146
UNIVERSAL U-JOINT ASSEMBLY**

Replaces: 3850815



**18-2339
U-JOINT ASSEMBLY**

Replaces: 3852384



**18-2128
CENTER SOCKET**

Replaces: 3850813, 912213

Drive Model	U-joint Assy. #	O.E. U-joint Assy. #	Long Yoke #	O.E. Long Yoke #	Short Yoke #	O.E.Short Yoke #	Double Yoke #	O.E. Double Yoke #
SX, DP-SM	18-2339	3852384	18-2146	3850815	18-2337	3850814	18-2128	3850813



**18-4204
PLASTIC BUSHING**

Replaces: 826341, 876278
AQ200, 250, 270, 275, 280, 280DP,290DP,
NOT FOR 270T, 280T, AND 290



**18-2366
LOWER
GEARCASE SEAL**

Replaces: 876279
290, 290A, 290DP, SP-A, SP-A1 & SP-A2



**18-4205
PLASTIC BUSHING**

Replaces: 832820
A270T, 280T



**18-4206
STERNDRIVE COVER**

Replaces: 832570
AQ200, 250, 270, 275, 280, 290



**FISH LINE
PROTECTOR SPACER**

Part #	O.E. #	Application
18-4208	839423	AQ280, 290
18-4209	839534	AQ250, 270, 275
18-4234	832965	AQ110S, 200



**18-4210
PROP CONE**

Replaces: 850785, 854045
AQ200, 250, 270, 270T, 275, 280, 280T, 280PT, 290



**18-4211
PLASTIC WASHER**

Replaces: 850888



**18-3730
LOCK NUT**

Replaces: 3852648-9
For: SX Drives



**18-4212
PROP CONE SCREW**
Replaces: 850889
(5/16" — 18)



**18-4213
SPACER**
Replaces: 851261,
854047
AQ275, 280, 290



**18-4214
LOCKING WASHER**
Replaces: 897367
AQ Drive Units: 200, 250,
270, 270T (TID UTF) 275, 280,
280T, 280PT (TID UTF)



**18-4215
COVER SCREW**
Replaces: 941816
(1/4" — 20)



**18-2153
SETTING PIVOT PIN**
Replaces: 814301
AQ200, 250, 270, 275, 280



**18-4254
PRESSURE PLATE**
Replaces: 814219

② **18-3733D** 



**18-3733
PROP NUT KIT**
For: SX Cobra
— Contains —

Part #	Description	Qty.
18-4194	Spacer	1
18-3708-1	Nut & Keeper	1
18-3741	Cotter Pin	1



**18-4194
PROP SPACER**
Replaces: 3852350
For: Lower gearcase models SX-M (1994)



**18-3708-1
PROP NUT & KEEPER**
Replaces: 3850984

PKG. OF 10



**18-3744
18-3744-9①
COTTER PIN**
Replaces: 3852255
For: XDP, MDSSL, MD22P, TMD22,
TMD22P, TAMD22P, PJX, SX, DPS,
DP, 3.0L GS, GL, 4.3L GL, GS, GI,
5.0L FL, FI, 5.7L GL, GI, 5.8L FL, FI, FSI

PKG. OF 3



**18-3745
18-3745-9①
COTTER PIN**
Replaces: 17253-6

PKG. OF 5



**18-4238
18-4238-9①
LOCK CATCH SCREW**
For Stern Drive Cover 18-4206
Replaces: 943218
AQ200, 250, 270, 275, 280, 290



**18-4239
LOCK CATCH**
For Stern Drive Cover 18-4206
Replaces: 897873
AQ200, 250, 270, 275, 280, 290

PKG. OF 5



**18-4241
18-4241-9①
ROLL PIN**
Replaces: 951924
AQ200, 250, 270, 275, 280, 290



**18-1501
DETENT BALL**
Replaces: 3852023
For: 3.0L GS, GL, 4.3L GL, GS, GI,
5.0L FL, FI, 5.7L GL, GI, 5.8L FL, FI, FSI

PKG. OF 5



**18-3722
18-3722-9①
STAINLESS STEEL LOCKNUT**
Replaces: 3852005
For: PJX, SX, DPS, DP, DPX, 3.0L GL, GS,
4.3L GL, GS, GI, 5.0L FL, FI, 5.7L GL, GI,
5.8L FL, FI, FSI, 7.4L GL, GI, GSI, 8.2L GL



**18-0549
PLUG OFF CAP**
Replaces: 3852476
For: 4.3L GL, GS, GI, GSI, 5.0L FL, FI, 5.7L GL,
GI, 5.8L FL, FI, FSI, 7.4L GL, GI, GSI, 8.3L GI,
GSI, GXI, 8.2L GL, GSI



**18-2138
PIVOT PIN BEARING**
Replaces: 3852544
For: 3.0L GS, GL, 4.3L GL, GS, GI,
5.0L FL, FI, 5.7L GL, GI, 5.8L FL, FI, FSI

① Priced per Package
② Items ending in "D" are Display Packaged - Regular number is Non-Display

Zinc is for saltwater only applications.
 Magnesium is for fresh water only applications.
 Aluminum is for brackish water, or if boat is used in both fresh and salt environments.



③ 18-6123Z
ANODE
 Replaces: 873395
 Transom Shield



③ 18-6124Z
ANODE
 Replaces: 872793
 DPS Steering Arm



① 18-6125A
 ② 18-6125M
 ③ 18-6125Z
TRANSOM PLATE
 Replaces:
 3586461 (Aluminum)
 3855610 (Magnesium)
 3854130 (Zinc)



① 18-6126A
 ② 18-6126M
 ③ 18-6126Z
TRANSOM ANODE (with bolt)
 Replaces:
 3888816 (Aluminum)
 3888818 (Magnesium)
 3888817 (Zinc)
 SX-A, DPS-A, DPS-A Oxi



① 18-6127A
 ② 18-6127M
 ③ 18-6127Z
TRANSOM ANODE (with bolt)
 Replaces:
 3888813 (Aluminum)
 3888815 (Magnesium)
 3888814 (Zinc)
 SX-A, DPS-A, DPS-A Oxi



③ 18-6000
 ① 18-6000A
 ② 18-6104
ANODE
 Replaces: 832598,
 873179
 For 200, 250, 250C, 250D, 270,
 270B, 270C, 270D, 275, 280,
 280C, 280D, 280DP, 280L, 280PT



③ 18-6001
ANODE
 Replaces: 838929
 AQ200 (For shield), MD19, 21,
 27, 29, 32, 2003, AQ30, 31, 40, 41
 For Fresh Water Cooler



③ 18-6004
 ① 18-6004A
 ② 18-6105
ANODE
 Replaces: 852835,
 873178
 For 290, 290A, 290ADP, 290B



③ 18-6005
ANODE
 Replaces: 875805
 AQ250, 270, 270T, 275



③ 18-6009
 ① 18-6009A
ANODE
 Replaces: 875815



③ 18-6028
 ① 18-6028A
 ② 18-6102
ANODE
 Replaces: 3855411, 984513
 (18-6028), 3863193 (18-6028A),
 3854412 (18-6102)
 For use on Gearcases: 2.3L (1987-90), 2.6L/
 3.5L/4.6L (1989), 3.0L/4.3L/5.0L/5.8L (1987-
 93), 5.7L (1987-92), 7.4L (1987-88)



③ 18-6010
 ① 18-6010A
 ② 18-6106
ANODE
 Replaces: 875821
 280DP, 290DP



NEW

**18-6130
ANODE**
Replaces: Volvo
Fits: Volvo IPS Drives



NEW

**18-6131
ANODE**
Replaces: Volvo
Fits: Volvo IPS Drives



NEW

**18-6128A
ANODE KIT**
Replaces: Volvo
Fits: Volvo SX-A & DPS Drives



NEW

**18-6128M
ANODE KIT**
Replaces: Volvo
Fits: Volvo SX-A & DPS Drives



NEW

**18-6128Z
ANODE KIT**
Replaces: Volvo
Fits: Volvo SX-A & DPS Drives



NEW

**18-6129A
ANODE KIT**
Replaces: Volvo
Fits: Volvo DPH Drives



NEW

**18-6129M
ANODE KIT**
Replaces: Volvo
Fits: Volvo DPH Drives



NEW

**18-6129Z
ANODE KIT**
Replaces: Volvo
Fits: Volvo DPH Drives



NEW

**18-1076
BELLOWS**
Replaces: Volvo 3888916
Fits: Volvo SX-A & DPS-A Drives



**18-6021
ANODE PLUG**
Replaces: 838928
AQ30, 31, 40, 41, MD10, 21,
27, 29, 32, 2003



**18-2598
GEAR HOUSING SEAL KIT**
Replaces: 3855275
Fits: Volvo SX Thru 2006



**18-2586
UPPER UNIT SEAL KIT**
Replaces: 3850594
Fits: Volvo SX Thru 2006



**18-2726
UPPER UNIT SEAL KIT**
Replaces: 3888917
Fits: Volvo SX-A/DPS-A (2007& Up)



**18-3893
GEAR SHIFT
MECHANISM GASKET SET**
Fits: 275A, 280, 280DP, 280T, 285A, 290, 290A, 290DP, SP-A, SP-A/MT,
SP-A1, SP-A2, SP-C, SP-C1, DP-A, DP-A1, DP-A2, DP-B, DP-B1, DP-C,
DP-C1, DP-D, DP-D1, DP-E, DP-G, DP-X, XDP-B



18-2597
UPPER GEAR
UNIT SEAL KIT

For intermediate housing: Fits: 200, 250, 270, 270T, 275, 275A, 280, 280DP, 280T, 285A, 290, 290A, 290DP, SP-A, SP-A/MT, SP-A1, SP-A2, SP-C, SP-C1, DP-A, CP-A1, DP-B, DP-B1, DP-C, DP-C1, DP-D, DP-D1, DP-E, DP-G, DPX, DPX-S, DPX-S1



18-3888
LOWER GEAR
UNIT SEAL KIT

For intermediate housing: Fits: 200, 250, 270, 270T, 275, 275A, 280, 280DP, 280T, 285A, 290, 290A, 290DP, SP-A, SP-A/MT, SP-A1, SP-A2, SP-C, SP-C1, DP-A, CP-A1, DP-B, DP-B1, DP-C, DP-C1, DP-D



18-8357
COMPLETE
GEARCASE SEAL KIT
Replaces: 875741
For: 280DP/290DP

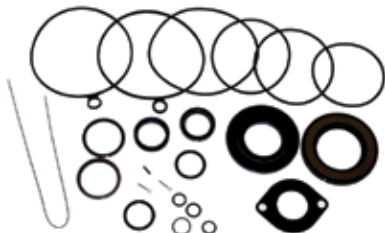

18-8361
UPPER SEAL KIT
Replaces: 576266-8
For: AQ200-AQ290

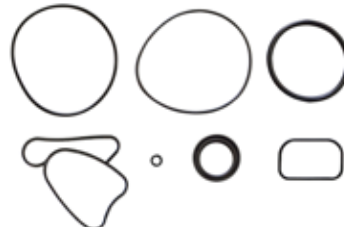

18-2583
LOWER UNIT SEAL KIT
Replace: 3888821
Fits: SX-A Drives (2007 and UP)



18-2584
LOWER UNIT SEAL KIT
Replaces: 3888822
Fits: DPS-A Drives (2007 and UP)

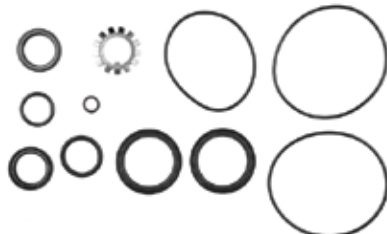

18-8358
LOWER UNIT SEAL KIT
Replaces: 876267
For: 280DP/290DP



18-8359
LOWER GEARCASE
SEAL KIT
Replaces: 876268
For: AQ200-AQ290



18-2791
LOWER UNIT SEAL KIT
Replaces: 3850597

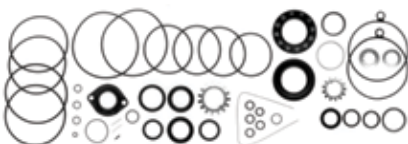

18-2625
STERNDRIVE GASKET KIT
Replaces: 875192
AQ200, 250, 270, 275, 280, 290



18-32882
WATER TUBE SEAL
Replaces: 3852315



OIL SEALS

Part #	O.E. #	Dimensions (mm)		
		I.D.	O.D.	Width
18-0558	851407	44	58.33	7
18-2039	804695	13	25.4	6
18-2040	853670	45	75	8
18-2041	897426	33	45.25	7
18-2043	958838	25	35	7
18-2044	833996	12	24	7
18-2045	827247	16	28	7
18-2046	946242	35	55	10
18-2047	958860	35	62	7
18-2057	181620	34	42	4

O-RINGS

Part #	Pkg.	Dimensions (mm)				Part #	Pkg.	Dimensions (mm)			
		O.E. #	I.D.	Width	O.E. #			I.D.	Width		
18-7122		925095	—	—	18-7182	5	925092	55	3		
18-7154		949656	—	—	18-7183	5	925093	69.5	3		
18-7102	5	3852073	.430	.065	18-7184	5	925256	79	3		
18-7116		3852045	.360	.10	18-7186	5	925259	102	3		
18-7135		3852089	.750	.135	18-7187	5	925261	106	3		
18-7141	5	3852165	.180	.065	18-7188	5	955983	9.1	1.6		
18-7143	5	3852169	1.310	.100	18-7190	5	925065	34	3		
18-7149	5	955989	15	1.5	18-7192	5	955995	25.1	1.6		
18-7162	5	3852044	2.025	.135	18-7193	5	955974	10.3	2.4		
18-7168	5	3852033	.370	.065	18-7194	5	956000	37.1	1.6		
18-7178	5	125017	23.5	3.5	18-7406	5	3852523	.250	.065		
18-7180	5	925055	11.3	2.4	18-7407	5	3852531	4.125			
18-7181	5	925091	50.5	3							

① This product is priced per piece. To order priced per package, please add -9 to the part number.



**18-3060
IMPELLER**
Replaces: 835512, 3854286
Sherwood 9959,
Jabsco 18838-0001
Oberdorfer 132-0317
OMC 3854286
Neoprene, 12 FINS



**18-5280
COMPLETE TUNE-UP KIT**
For: In-line 4

— CONTAINS —

Part #	Description	Qty.
18-5361	DISTRIBUTOR CAP	1
18-5406	ROTOR	1



**18-5278
COMPLETE TUNE-UP KIT**
For: V-6



**18-5301
TUNE-UP KIT**
Replaces:
Fits: male cap v-8 flamethrower distributors



**18-5302
TUNE-UP KIT**
Replaces:
Fits: male cap v-8 flamethrower distributors



**18-59640
ALTERNATOR**
Replaces: Prestolite



**18-6843
ALTERNATOR**
Replaces: Mando A000B0341,
TA000B0341,
Yamaha 19-1400-10
Fits: Crusader and Yamaha Sterndrive
engines



**18-6834
STARTER**
Replaces: GM Engines
Used on Buick, Chevrolet, Oldsmobile, and Pontiac Race Engines



**18-6835
STARTER**
Replaces: GM Engines
Used on Buick, Chevrolet, Oldsmobile, and Pontiac Race Engines

PREMIUM MARINE SPARK PLUG WIRE LEADS

MAGFORCE™



OE style boots provide a sealed barrier against heat, dirt and moisture.

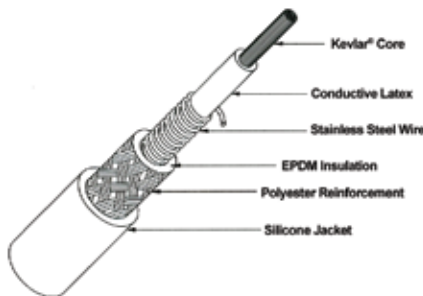

Model	Ignition Type	Cyl.	Part #
4.3L	Delco EST	V-6	18-8810-1
5.0L/5.7L	Delco EST	V-8	18-8820-1
7.4L	Delco EST	V-8	18-8820-1

Premium Marine Wire Leads
Magnetic Suppression Core
Manufactured for your specific application

- ★ Kevlar® core for maximum durability and long life.
- ★ Durable stainless steel wound conductor for maximum horsepower and engine performance.
- ★ Premium silicone jacketing and boots for the ultimate in high temperature protection.
- ★ Superior RFI suppression for the most sensitive electronic system.
- ★ Corrosion resistant stainless steel spark plug and distributor terminals for maximum conductivity.

FUEL WATER SEPARATORS



Sierra offers a complete line of 10 and 21 micron fuel water separating filters including drainable bowl filters to protect your carbureted and fuel injected engine.

Refer to pages 100-104 for a complete listing of OEM and universal applications.

Sierra fuel water separators remove over 99.8% of emulsified water from your gasoline. Sierra's 10 micron filters are over 90% efficient at removing particles as small as 10 micron. All filters flow @ 90 GPH to feed even the hungriest motor. Sierra 10 micron filters are recommended to prevent damage to sensitive inboard and outboard fuel injection systems.



STERNDRIVE & INBOARD OIL FILTERS		
All 3.0L	YSC-13231-20-0C	18-7824
All V-8 5.0L, 5.7L (Spin on Lube)	YSC-14231-20-02	18-7876
All V-8 5.0L, 5.7L, 7.4L	YSC-10231-20-0C	18-7875

SEE PAGES 152-154 FOR ADDITIONAL INFORMATION









V-BELTS



- 1 High strength synthetic cords resist shockload failure. Their low stretch properties assure uniform performance over the life of the belt.
- 2 The compression section is a special rubber compound that assures smooth and even transfer of load forces to the cords.
- 3 Cogs are molded to precise engineering tolerances to improve flexibility and maintain cord support. Cog geometry provides a large area for air circulation to keep the belt cool and prevent damaging heat build up in the cushion section.
- 4 Rubber edges maintain positive, no-slip contact with pulley grooves for reliable energy transfer.

Part #	OE #	Application
18-15106	YSC-13260-60-0C	L4 Sterndrive 3.0L (For: water pump)
18-15107	YSC-13260-70-0C	L4 Sterndrive 3.0L (For: alternator/power steering)
18-15108	YSC-22260-10-0C	V-8 Sterndrive 7.4L (For: power steering)
18-15109	YSC-22260-00-0C	V-8 Sterndrive 7.4L (For: alternator)
18-15110	YSC-10260-10-0C	V-6 Sterndrive 4.3L/V-8 5, 5.7L (For: crank/power steering)
18-15111	YSC-10260-00-0C	V-6 Sterndrive 4.3L/V-8 5, 5.7L (For: crank/pump alternator)

YAMAHA STERNDRIVE GASKETS

<p>PKG. OF 2</p>  <p>18-0164 18-0164-9① THERMOSTAT GASKET Replaces: YSC-13080-00-0C, GM 3789161</p>	<p>PKG. OF 2</p>  <p>18-0876 18-0876-9① FUEL PUMP GASKET Replaces: YSG-10108-43-8G</p>	<p>PKG. OF 2</p>  <p>18-0889 18-0889-9① FUEL PUMP GASKET Replaces: YSG-10114-14-1G</p>	<p>PKG. OF 2</p>  <p>18-0891 18-0891-9① WATER PUMP MOUNTING GASKET Replaces: YSG-37545-87-G0</p>	<p>PKG. OF 2</p>  <p>18-0874 18-0874-9① DISTRIBUTOR GASKET Replaces: YSG-10108-44-5G</p>
<p>PKG. OF 2</p>  <p>18-2909 18-2909-9① EXHAUST MANIFOLD GASKET Replaces: YSC-12190-00-AC For: 262 CID (4.3L)</p>	<p>PKG. OF 2</p>  <p>18-0903 WATER PUMP GASKET Replaces: YSG-38600-39-G0</p>	<p>PKG. OF 2</p>  <p>18-0887 18-0887-9① TIMING COVER GASKET Replaces: YSG-14096-15-6G</p>	<p>PKG. OF 2</p>  <p>18-0905 OIL PAN DRAIN PLUG GASKET Replaces: YSG-14090-90-8G</p>	<p>PKG. OF 2</p>  <p>18-4698 18-46981-9① (PKG. OF 50) DRAIN FILL WASHER Replaces: 90430-08020-00</p>

① Priced per Package

Mallery Distributor Parts Guide

Distributor No.	Cyl. & Rotation	Description	Contact Set	Condenser	Dist. Cap	Rotor	Tune-Up Kit
ZD345A, B	8RH	Crusader	18-5314	18-5344	18-5376	18-5404-1	—
ZD347A	8LH	Crusader	18-5314	18-5344	18-5375	18-5411	—
ZD347B	8RH	Crusader	—	18-5344	18-5375	18-5411	—
YD349A	4LH	Burmeister & Wain	18-5314	18-5338	18-5355	18-5427	—
YD350A	8LH	Dearborn	18-5314	18-5338	18-5375	18-5411	18-5256 ①
YL350A	8LH	262, 272, 292, 312 Engs.	18-5314	18-5338	18-5376	18-5404-1	18-5251 ②
ZD352	8RH	Crusader	18-5314	18-5344	18-5375	18-5411	—
YD356A	8RH	Flagship Owens	18-5314	18-5338	18-5375	18-5411	18-5256 ①
YL356A	8RH	Flagship Owens	18-5314	18-5338	18-5375	18-5411	18-5256 ①
YL356A-2	8RH	Flagship	18-5314	18-5338	18-5375	18-5411	18-5256 ①
ZD358A	8LH	Crusader	18-5314	18-5344	18-5375	18-5411	—
YD359C, D, E, F	8LH	Gray (250, 327) AM Mtrs.	18-5314	18-5338	18-5376	18-5404-1	18-5251 ②
YL362A, B	8LH	Dearborn 390 Eng.	18-5314	18-5338	18-5375	18-5411	18-5256 ①
YD362A, B	8LH	Dearborn 390 Eng.	18-5314	18-5338	18-5375	18-5411	18-5256 ①
YL362C, D, E, F, G, H	8LH	390, 427 Eng.	18-5314	18-5338	18-5375	18-5411	18-5256 ①
YL362AV, BV, CV, DV	8LH	Dearborn 390 Eng.	18-5314	18-5338	18-5375	18-5411	18-5256 ①
ZD366A, B	8LH	Crusader (Cadillac 275 Eng.)	18-5314	18-5344	18-5375	18-5411	—
YD370A	4RH	Universal Mts.	18-5314	18-5338	18-5355	18-5427	—
YD370B	6RH	Universal Mts.	18-5314	18-5338	—	18-5427	—
YD370C	4RH	Universal Mts.	18-5314	18-5338	18-5355	18-5427	—
YL370A	4RH	Universal Mts.	18-5314	18-5338	18-5355	18-5427	—
YL370B	6RH	Universal Mts.	18-5314	18-5338	—	18-5427	—
YD372A, B, C, D	8LH	Chris Craft 430 Eng.	18-5314	18-5338	18-5375	18-5411	18-5256 ①
YL372C, D	8LH	Chris Craft 430 Eng.	18-5314	18-5338	18-5375	18-5411	18-5256 ①
YD372F-2	8LH	431 Eng.	18-5314	18-5338	18-5375	18-5411	18-5256 ①
YD375A	8RH	Chrysler M80	18-5314	18-5338	18-5376	18-5404-1	18-5251 ②
YD377A	6LH	Palmer	18-5314	18-5338	—	18-5427	—
YL387A	8LH	Dearborn	18-5314	18-5338	18-5376	18-5404-1	18-5251 ②
YD396A	6RH	Palmer 308 Eng.	18-5314	18-5338	—	18-5427	—
YD397A	6RH	Palmer 308 Eng.	18-5314	18-5338	—	18-5427	—
YD410A	4RH	Gray	18-5314	18-5338	18-5355	18-5427	—
YD410C	6RH	Gray	18-5314	18-5338	—	18-5427	—
YD411A	4RH	Gray	18-5314	18-5338	18-5355	18-5427	—
YD411B	4LH	Gray	18-5314	18-5338	18-5355	18-5427	—
YD411C	6RH	Gray	18-5314	18-5338	—	18-5427	—
YD411D	6LH	Gray	18-5314	18-5338	—	18-5427	—
YL411A	4RH	F-4 Turbo	18-5314	18-5338	18-5355	18-5427	—
YL411B	4LH	F-4 Turbo	18-5314	18-5338	18-5355	18-5427	—
YL411C	6RH	F-6 Turbo	18-5314	18-5338	—	18-5427	—
YL411D	6LH	F-6 Turbo	18-5314	18-5338	—	18-5427	—
YL414D, E, J, K	6RH	Dearborn	18-5314	18-5338	—	18-5427	—
YD420A, B, C, D	8RH	Palmer 345 Eng.	18-5314	18-5338	18-5375	18-5411	18-5256 ①
YL420E	8RH	IHC 304, 345, 392 Engs.	18-5314	18-5338	18-5375	18-5411	18-5256 ①
YD429A, B	8LH	Gray	18-5314	18-5338	18-5376	18-5404-1	18-5251 ②
YD429C, D	8LH	Gray	18-5314	18-5338	18-5375	18-5411	18-5256 ①
YL429C, D	8LH	138, 175 Engs.	18-5314	18-5338	18-5375	18-5411	18-5256 ①
ZD430A	8RH	170, 220, 225 HP	—	18-5338	18-5375	18-5411	—
YL431A	8RH	Crusader	18-5314	18-5338	18-5375	18-5411	18-5256 ①
ZYLD431A	8RH	185, 220, 230 HP	18-5314	18-5338	18-5375	18-5411	18-5256 ①
YL436A,B	6RH	Dorsett	18-5314	18-5338	—	18-5427	—

① 18-5272 Kit with distributor cap

② 18-5271 Kit with distributor cap

Mallory Distributor Parts Guide (Cont.)

Distributor No.	Cyl. & Rotation	Description	Contact Set	Condenser	Dist. Cap	Rotor	Tune-Up Kit
YL445A, B, BD, JV, KV	8LH	Dearborn	18-5314	18-5338	18-5375	18-5411	18-5256 ①
YP451A, B, C, D, E, F, G, H	6 RH	Chrysler M170 & M225 Engs.	18-5314	18-5338	—	—	—
YL455A, B,	8RH	Gray	18-5314	18-5338	18-5376	18-5404-1	18-5251 ②
YL457AC,AV, BV, CV, DV	8LH	Dearborn	18-5314	18-5338	18-5375	18-5411	18-5256 ①
YL458B	8RH	Gray	18-5314	18-5338	18-5376	18-5404-1	18-5251 ②
YL459A	8RH	Gray	18-5314	18-5338	18-5375	18-5411	18-5256 ①
YL461A, B	8RH	Crusader 409 Eng.	18-5314	18-5338	18-5376	18-5404-1	18-5251 ②
YL461A-2, B-2	8RH	427 Eng.	18-5314	18-5338	18-5376	18-5404-1	18-5251 ②
YL467A	8RH	Daytona (283, 327 Chevy Eng.)	18-5314	18-5338	18-5376	18-5404-1	18-5251 ②
YL469A	8RH	Chris-Craft (283, 327 Chevy Eng.)	18-5314	18-5338	18-5375	18-5411	18-5256 ①
YL474D, E	6RH	Dearborn (200 Ford Eng.)	18-5314	18-5338	—	18-5427	—
YL481A, B	6RH	Chevy 230, 292 Engs.	18-5314	18-5338	—	18-5427	—
YL486A,B,	6RH	Crusader (230, 292 Chevy Eng.	18-5314	18-5338	—	18-5427	—
YL486C,D,	4 RH	Crusader 153 Eng.	18-5314	18-5338	18-5355	18-5427	—
YL487A	8RH	Crusader (283, 327 Chevy Eng.	18-5314	18-5338	18-5376	18-5404-1	18-5251 ②
YL494A, BO	8LH	Dearborn	18-5314	18-5338	18-5376	18-5404-1	18-5251 ②
YL494A-2, B-2	8LH	427 Eng.	18-5314	18-5338	18-5376	18-5404-1	18-5251 ②
YL495A,B	6RH	Dearborn (170 Ford Eng.)	18-5314	18-5338	—	18-5427	—
YL496A, B,	8LH	Holman & Moody	18-5314	18-5338	18-5375	18-5411	18-5256 ①
YL501AV, CV, EV, GV	8LH	Oldsmobile Eng.	18-5314	18-5338	18-5375	18-5404-1	18-5251 ②
YL502A, B	8LH	Chris-Craft (427 Ford Eng.)	18-5314	18-5338	18-5375	18-5411	18-5256 ①
YL512A	8LH	289 Eng.	18-5314	18-5338	18-5376	18-5404-1	18-5251 ②
YL512CV, DV	8LH	Ford 302 Eng.	18-5314	18-5338	18-5376	18-5404-1	18-5251 ②
YL513A, B	8LH	Dearborn (289 Ford Eng.)	18-5314	18-5338	18-5376	18-5404-1	18-5251 ②
YL513CV, DV	8LH	Ford 289, 302 Engs.	18-5314	18-5338	18-5376	18-5404-1	18-5251 ②
YL514A, B, C, D	8LH	352, 390, 427, 428 Engs.	18-5314	18-5338	18-5376	18-5404-1	18-5251 ②
YL515A, B	8RH	283, 327 Engs.	18-5314	18-5338	18-5375	18-5411	18-5256 ①
YL519A, B, AV, BV	8LH	Dearborn (289 Ford Eng.)	18-5314	18-5338	18-5375	18-5411	18-5256 ①
YL520AV, BV, CV, CV2, DV, EV, JV	8RH	OMC	18-5314	18-5338	18-5375	18-5411	18-5256 ①
YL524AV, BV	6RH	300 Eng.	18-5314	18-5338	—	18-5427	—
YL529A, B	8RH	Crusader (283, 327 Engs.)	18-5314	18-5338	18-5375	18-5411	18-5256 ①
YL539AV	8RH	Chris-Craft (327 Chevy Eng.)	18-5314	18-5338	18-5375	18-5411	18-5256 ①
YL554CV, DV, EV, FV	8LH	Ford 351W Eng.	18-5314	18-5338	18-5376	18-5404-1	18-5251 ②
YL555CV, DV	8LH	Ford 351W Eng.	18-5314	18-5338	18-5376	18-5404-1	18-5251 ②
YL558AV, BV	8LH	Ford 351C Eng.	18-5314	18-5338	18-5375	18-5411	18-5256 ①
YL566AV	8RH	Chris-Craft (327 Chevy Eng.)	18-5314	18-5338	18-5375	18-5411	18-5256 ①
YL567CV, DV	8LH	Ford 351 Eng.	18-5314	18-5338	18-5376	18-5404-1	18-5251 ②
YL585AV, CV-2	8RH	Chris-Craft	18-5314	18-5338	18-5375	18-5411	18-5256 ①
YL623AV	8	Chris-Craft Thermo-Electron	18-5314	18-5338	18-5376	18-5404-1	18-5251 ②
YL623AV-2	8	Chris-Craft, Mercury	18-5314	18-5338	18-5375	18-5404-1	18-5251 ②
YL624AV	8	Gale Banks, Maritec,Mercury	18-5314	18-5338	18-5375	18-5404-1	18-5251 ②
YL624AV-2	8	Harmin	18-5314	18-5338	18-5375	18-5404-1	18-5251 ②
YL624JV	8	O.M.C.	18-5314	18-5338	18-5376	18-5404-1	18-5251 ②
YL624MV	8	Mercury (Mercuriser)	18-5314	18-5338	18-5376	18-5404-1	18-5251 ②
YL670AV	8	Chevy - Exc 348, 409 Eng.	18-5314	18-5338	18-5376	18-5404-1	18-5251 ②
YL673AV	4	Chevy 153 Eng.	18-5314	18-5338	18-5397	18-5404-1	18-5251 ②
YL676AV	6	Chevy In Line	18-5314	18-5338	—	—	18-5251 ②
YL677AV	6	Chevy Odd Fire	18-5314	18-5338	—	18-5404-1	—
YL/YS700AV	6	Chevy Even Fire	18-5314	18-5338	—	18-5404-1	18-5251 ②
YL703AV	8	Crusader/Thermo-Electron	18-5314	18-5338	18-5376	18-5404-1	18-5251 ②

① 18-5272 Kit with distributor cap

② 18-5271 Kit with distributor cap

PRESTOLITE DISTRIBUTOR PARTS GUIDE

Distributor Number	Contact Set	Condenser ③	Rotor	Cap	Ignition Coil	Tune-Up Kit
IAD-6004-2F, 2N, 2P	18-5307	18-5345	—	—	18-5435 ①	—
IAO-4109-1M	18-5307	18-5345	18-5430	18-5392	18-5435 ①	—
IAO-4113-1M	18-5307	18-5345	18-5430	18-5392	18-5435 ①	—
IAO-4114-1M	18-5307	18-5345	18-5430	18-5392	18-5435 ①	—
IAY-4010, A	18-5307	18-5345	18-5427	—	18-5435 ①	—
IAY-4014	18-5307	—	18-5427	—	18-5435 ①	—
IAY-4014C	18-5307	18-5345	18-5427	—	18-5435 ①	—
IBB-4205	18-5303 ②	—	18-5407	—	18-5435 ①	—
IBB-4301B	18-5303 ②	18-5345	18-5407	18-5369	18-5434	18-5255 ⑦
IBB-7003	18-5303 ②	18-5345	18-5407	18-5369	18-5435 ①	18-5255 ⑦
IBM-4106	18-5303	18-5345	18-5407	18-5369	—	18-5255 ⑦
IBM-4107, A	18-5303	18-5345	18-5407	18-5369	18-5435 ①	18-5255 ⑦
IBM-4108, A, B, C	18-5303	18-5345	18-5407	18-5369	—	18-5255 ⑦
IBM-4109, A	18-5303	18-5345	18-5407	18-5369	—	18-5255 ⑦
IBM-4110	18-5303	18-5345	18-5429	18-5391	—	18-5259
IBM-4112	18-5303	18-5345	18-5429	18-5391	18-5435 ①	18-5259
IBM-4115	18-5303	18-5345	18-5429	18-5391	18-5435	18-5258
IBM-4116	18-5303	18-5345	18-5429	18-5391	18-5435	18-5258
IBM-4117A	18-5303	18-5345	18-5407	18-5369	18-5435 ①	18-5255 ⑦
IBM-4118A	18-5303	18-5345	18-5429	18-5391	18-5435 ①	18-5259
IBM-4119, A	18-5303	18-5345	18-5429	18-5391	18-5435 ①	18-5259
IBM-4120	18-5303	18-5347	18-5429	18-5391	18-5434	18-5259
IBM-4122	18-5303	18-5347	18-5407	18-5369	18-5435 ①	18-5258 ⑦
IBM-7003B, BS	18-5303	18-5345	18-5407	18-5369	18-5434	18-5255 ⑦
IBM-7004A, AS, B, BS	18-5303	18-5345	18-5407	18-5369	18-5435 ①	18-5255 ⑦
IBM-7007, A, AS, S	18-5303	18-5345	18-5407	18-5369	18-5435 ①	18-5255 ⑦
IBM-7008, A, AS, B, BS, C, CS, S	18-5303	18-5345	18-5407	18-5369	18-5435 ①	18-5255 ⑦
IBM-7010	—	18-5345	18-5407	18-5369	18-5434	—
IBM-7011	18-5303	18-5345	18-5407	18-5369	18-5434	18-5255 ⑦
IBM-7011A	18-5303	18-5345	18-5407	18-5369	18-5435 ①	18-5255 ⑦
IBM-7011B	—	18-5345	18-5407	18-5369	18-5435 ①	—
IBM-7011C, D	18-5303	18-5345	18-5407	18-5369	18-5435 ①	18-5255 ⑦
IBM-7013	18-5303	18-5345	18-5403	18-5352	—	18-5260 ④
IBM-7013A	18-5303	18-5345	18-5403	18-5352	18-5434	18-5260 ④
IBM-7013B	—	18-5345	18-5403	18-5352	—	—
IBM-7013C, D, E	18-5303	18-5345	18-5403	18-5352	—	18-5260 ④
IBM-7014	18-5303	18-5345	18-5403	18-5353	—	18-5260 ⑥
IBM-7014A	18-5303	18-5347	18-5403	18-5353	18-5434	18-5258 ⑥
IBM-7016	18-5303	18-5345	18-5409	18-5352	—	18-5260 ④
IBM-7017	18-5303	18-5345	18-5409	18-5352	—	18-5260 ④
IBM-7018	18-5303	18-5345	18-5409	18-5353	—	18-5260 ⑥
IBM-7019, A, AS, S	18-5303	18-5345	18-5403	18-5352	18-5435 ①	18-5260 ④
IBM-7020, A, AS, B, BS, C, CS, S	18-5303	18-5345	18-5403	18-5352	18-5435 ①	18-5260 ④
IBM-7021	18-5303	18-5345	18-5403	18-5353	—	18-5260
IBP-4105, A	—	18-5345	18-5407	18-5369	18-5435 ①	—
IBP-4110, A, B	—	18-5345	18-5429	18-5391	18-5435 ①	—
IBP-4111A	—	18-5345	18-5407	18-5369	18-5435 ①	—
IBP-4112A, B	—	18-5345	18-5429	18-5391	18-5435 ①	—
IBP-4113A, B, C	—	18-5345	18-5429	18-5391	18-5435 ①	—
IBR-4205, A, S	—	18-5347	—	—	18-5435 ①	—
IBR-7002, A, AS, S	18-5307	18-5345	18-5430	18-5392	18-5434	—
IDD-7001	N/A	N/A	18-5407	18-5369	—	N/A
IDH-7001, S	N/A	N/A	18-5407	18-5369	—	N/A
IDH-7002, S	N/A	N/A	18-5407	18-5369	—	N/A
IDH-7003, A, AS, S	N/A	N/A	18-5407	18-5369	—	N/A
IDH-7004	N/A	N/A	18-5409	18-5352	—	N/A
IDH-7005	N/A	N/A	18-5409	18-5352	—	N/A
IDH-7006, A	N/A	N/A	18-5403	18-5352	—	N/A
IDH-7802	N/A	N/A	18-5403	—	18-5433	N/A
IDU-7601	N/A	N/A	18-5403	18-5353	—	N/A
IDU-7801, A, B	N/A	N/A	18-5403	18-5352	18-5433	N/A
IGC-5501A	18-5307	18-5345	18-5430	—	18-5435 ①	—
IGW-4056	—	—	—	—	18-5434	—
IGW-4118A	—	—	—	—	18-5435 ①	—
IGW-4199B, C	—	—	—	—	18-5435 ①	—
IGW-4301	—	—	—	—	18-5435 ①	—
IGW-4409A	—	—	—	—	18-5435 ①	—

N/A Not Applicable ① 12 Volt System Only ② 2 Required ③ Condensers 18-5340 (Wire Conductor) and 18-5347 (Strap Conductor) are interchangeable.
 ④ 18-5275 Kit with distributor cap ⑥ 18-5276 Kit with distributor cap ⑦ 18-5277 Kit with distributor cap

Evinrude Outboards 1950-1979			Evinrude Outboards 1950-1979			Evinrude Outboards 1950-1979			Evinrude Outboards 1950-1979		
MODEL NO.	HP	YEAR	MODEL NO.	HP	YEAR	MODEL NO.	HP	YEAR	MODEL NO.	HP	YEAR
3402	3	1964	6203	6	1972	10925	9.9	1979	25702	25	1977
3412	3	1964	6302	6	1973	10935	9.9	1979	25703	25	1977
3432	3	1964	6303	6	1973	10954	9.9	1979	25752	25	1977
3433	3	1964	6402	6	1974	10955	9.9	1979	25753	25	1977
3502	3	1965	6403	6	1974	15032	18	1960	25802	25	1978
3512	3	1965	6502	6	1965	15033	18	1960	25803	25	1978
3532	3	1965	6503	6	1965	15034	18	1961	25852	25	1978
3533	3	1965	6504	6	1975	15035	18	1961	25853	25	1978
3602	3	1966	6505	6	1975	15036	18	1962	25902	25	1969
3603	3	1966	6602	6	1966	15037	18	1962	25903	25	1969
3606	3	1966	6603	6	1966	15404	15	1974	25904	25	1979
3612	3	1966-67	6604	6	1976	15405	15	1974	25905	25	1979
3632	3	1966	6605	6	1976	15454	15	1974	25952	25	1979
3633	3	1966	6702	6	1967	15455	15	1974	25953	25	1979
3636	3	1966	6703	6	1967	15504	15	1975	28202	28	1962
3702	3	1967	6704	6	1977	15505	15	1975	28203	28	1962
3703	3	1967	6705	6	1977	15554	15	1975	28302	28	1963
3706	3	1967	6802	6	1968	15555	15	1975	28303	28	1963
3707	3	1967	6803	6	1968	15604	15	1976	28352	28	1963
3712	3	1967	6804	6	1978	15605	15	1975	28402	28	1964
3716	3	1967	6805	6	1978	15654	15	1976	28403	28	1964
3732	3	1967	6902	6	1969	15655	15	1976	28452	28	1964
3733	3	1967	6903	6	1969	15704	15	1977	33002	33	1970
3736	3	1967	6904	6	1979	15705	15	1977	33003	33	1970
3737	3	1967	6905	6	1979	15754	15	1977	33052	33	1970
3802	3	1968	9022	9.5	1970	15755	15	1977	33053	33	1970
3803	3	1968	9023	9.5	1970	15804	15	1978	33502	33	1965
3806	3	1968	9122	9.5	1971	15805	15	1978	33503	33	1965
3807	3	1968	9123	9.5	1971	15854	15	1978	33552	33	1965
3832	3	1968	9222	9.5	1972	15855	15	1978	33553	33	1965
3833	3	1968	9223	9.5	1972	15904	15	1979	33602	33	1966
3836	3	1968	9322	9.5	1973	15905	15	1979	33603	33	1966
3837	3	1968	9323	9.5	1973	15954	15	1979	33652	33	1966
4006	4	1970	9422	9.5	1964	15955	15	1979	33653	33	1966
4036	4	1970	9423	9.5	1964	18002	18	1970	33702	33	1967
4106	4	1971	9522	9.5	1965	18003	18	1970	33703	33	1967
4136	4	1971	9523	9.5	1965	18102	18	1971	33752	33	1967
4206	4	1972	9622	9.5	1966	18103	18	1971	33753	33	1967
4236	4	1972	9623	9.5	1966	18202	18	1972	33802	33	1968
4306	4	1973	9722	9.5	1967	18203	18	1972	33803	33	1968
4336	4	1973	9723	9.5	1967	18302	18	1963	33852	33	1968
4406	4	1974	9822	9.5	1968	18303	18	1963	33853	33	1968
4436	4	1974	9823	9.5	1968	18304	18	1973	33902	33	1969
4506	4	1975	9922	9.5	1969	18305	18	1973	33903	33	1969
4536	4	1975	9923	9.5	1969	18402	18	1964	33952	33	1969
4606	4	1976	10020	10	1960	18403	18	1964	33953	33	1969
4636	4	1976	10021	10	1960	18502	18	1965	35018	40	1960
4706	4	1977	10022	10	1961	18503	18	1965	35019	40	1960
4736	4	1977	10023	10	1961	18602	18	1966	35022	40	1961
4806	4	1978	10024	10	1962	18603	18	1966	35023	40	1961
4836	4	1978	10025	10	1962	18702	18	1967	35028	40	1962
4837	4	1978	10302	10	1963	18703	18	1967	35029	40	1962
4902	4	1969	10303	10	1963	18802	18	1968	35520	40	1960
4904	4	1979	10422	9.5	1964	18803	18	1968	35521	40	1960
4906	4	1969	10424	9.9	1974	18902	18	1969	35524	40	1961
4932	4	1979	10425	9.9	1974	18903	18	1969	35525	40	1961
4933	4	1979	10454	9.9	1974	25002	25	1970	35530	40	1962
4936	4	1969	10455	9.9	1974	25003	25	1970	35531	40	1962
5302	5.5	1963	10522	9.5	1965	25102	25	1971	35602	35	1976
5303	5.5	1963	10524	9.9	1975	25103	25	1971	35603	35	1976
5402	5.5	1964	10525	9.9	1975	25202	25	1972	35652	35	1976
5403	5.5	1964	10554	9.9	1975	25203	25	1972	35653	35	1976
5502	5	1965	10555	9.9	1975	25252	25	1972	35702	35	1977
5503	5	1965	10622	9.5	1966	25253	25	1972	35703	35	1977
5520	5.5	1960	10624	9.9	1976	25302	25	1973	35752	35	1977
5521	5.5	1960	10625	9.9	1976	25303	25	1973	35753	35	1977
5522	5.5	1961	10654	9.9	1976	25352	25	1973	35802	35	1978
5523	5.5	1961	10655	9.9	1976	25353	25	1973	35803	35	1978
5524	5.5	1962	10722	9.5	1967	25402	25	1974	35852	35	1978
5525	5.5	1962	10724	9.9	1977	25403	25	1974	35853	35	1978
5602	5	1966	10725	9.9	1977	25452	25	1974	35902	35	1979
5603	5	1966	10754	9.9	1977	25453	25	1974	35903	35	1979
5702	5	1967	10755	9.9	1977	25502	25	1975	35932	40	1962
5703	5	1967	10822	9.5	1968	25503	25	1975	35933	40	1962
5802	5	1968	10824	9.9	1978	25552	25	1975	35952	35	1979
5803	5	1968	10825	9.9	1978	25553	25	1975	35953	35	1979
6002	6	1970	10835	9.9	1978	25602	25	1976	40002	40	1970
6003	6	1970	10854	9.9	1978	25603	25	1976	40003	40	1970
6102	6	1971	10855	9.9	1978	25652	25	1976	40052	40	1970
6202	6	1972	10924	9.9	1979	25653	25	1976	40053	40	1970

Evinrude Outboards 1950-1979			Evinrude Outboards 1950-1979			Evinrude Outboards 1950-1979			Evinrude Outboards 1950-1979		
MODEL NO.	HP	YEAR	MODEL NO.	HP	YEAR	MODEL NO.	HP	YEAR	MODEL NO.	HP	YEAR
40072	40	1970	50272	50	1972	70573	70	1975	100693	100	1966
40073	40	1970	50273	50	1972	70673	70	1976	100782	100	1967
40102	40	1971	50302	50	1973	70773	70	1977	100783	100	1967
40103	40	1971	50303	50	1973	70873	70	1978	100882	100	1968
40152	40	1971	50372	50	1973	70973	70	1979	100883	100	1968
40153	40	1971	50373	50	1973	75352	75	1963	100990	100	1979
40202	40	1972	50442	50	1974	75353	75	1963	100993	100	1979
40203	40	1972	50443	50	1974	75382	75	1963	100999	100	1979
40252	40	1972	50472	50	1974	75383	75	1963	115083	115	1970
40253	40	1972	50473	50	1974	75392	75	1963	115393	115	1973
40302	40	1963	50522	75	1960	75393	75	1963	115493	115	1974
40303	40	1963	50523	75	1960	75432	75	1964	115499	115	1974
40304	40	1973	50524	75	1961	75433	75	1964	115593	115	1975
40305	40	1973	50525	75	1961	75452	75	1964	115693	115	1976
40352	40	1963	50528	75	1962	75453	75	1964	115699	115	1976
40353	40	1963	50529	75	1962	75482	75	1964	115742	115	1967-68
40354	40	1973	50542	50	1975	75483	75	1964	115790	115	1977
40355	40	1973	50543	50	1975	75492	75	1964	115793	115	1977
40362	40	1963	50572	50	1975	75493	75	1964	115799	115	1977
40363	40	1963	50573	50	1975	75532	75	1965	115890	115	1978
40372	40	1963	50802	50	1978	75533	75	1965	115893	115	1978
40373	40	1963	50803	50	1978	75542	75	1975	115899	115	1978
40402	40	1964	50902	50	1979	75543	75	1975	115983	115	1969
40403	40	1964	50903	50	1979	75552	75	1965	115990	115	1979
40404	40	1974	50926	75	1961	75553	75	1965	115993	115	1979
40405	40	1974	50927	75	1961	75582	75	1965	115999	115	1979
40452	40	1964	50930	75	1962	75583	75	1965	125183	125	1971
40453	40	1964	50931	75	1962	75592	75	1965	125283	125	1972
40454	40	1974	55642	55	1976	75593	75	1965	135342	135	1973
40455	40	1974	55643	55	1976	75642	75	1976	135383	135	1973
40462	40	1964	55672	55	1976	75643	75	1976	135443	135	1974
40463	40	1964	55673	55	1976	75742	75	1977	135483	135	1974
40472	40	1964	55772	55	1977	75743	75	1977	135489	135	1974
40473	40	1964	55773	55	1977	75842	75	1978	135543	135	1975
40502	40	1965	55872	55	1968	75843	75	1978	135583	135	1975
40503	40	1965	55873	55	1968	75942	75	1979	135589	135	1975
40504	40	1975	55874	55	1978	75943	75	1979	135643	135	1976
40505	40	1975	55875	55	1978	80652	80	1966	135683	135	1976
40552	40	1965	55902-55903	55	1979	80653	80	1966	140740	140	1977
40553	40	1965	55972	55	1969	80682	80	1966	140743	140	1977
40554	40	1975	55973	55	1969	80683	80	1966	140783	140	1977
40555	40	1975	55974	55	1979	80692	80	1966	140840	140	1978
40562	40	1965	55975	55	1979	80693	80	1966	140843	140	1978
40563	40	1965	60062	60	1970	80752	80	1967	140883	140	1978
40572	40	1965	60063	60	1970	80753	80	1967	140940	140	1979
40573	40	1965	60072	60	1970	80792	80	1967	140943	140	1979
40602	40	1966	60073	60	1970	80793	80	1967	140983	140	1979
40603	40	1966	60162	60	1971	85093	85	1970	150840	150	1978
40604	40	1976	60163	60	1971	85193	85	1971	150849	150	1978
40605	40	1976	60172	60	1971	85293	85	1972	150940	150	1979
40652	40	1966	60173	60	1971	85393	85	1973	150949	150	1979
40653	40	1966	60432	60	1964	85493	85	1974	175740	175	1977
40654	40	1976	60433	60	1964	85593	85	1975	175749	175	1977
40655	40	1976	60452	60	1964	85693	85	1976	175840	175	1978
40662	40	1966	60453	60	1964	85699	85	1976	175849	175	1978
40663	40	1966	60532	60	1965	85790	85	1977	175940	175	1979
40672	40	1966	60533	60	1965	85793	85	1977	175949	175	1979
40673	40	1966	60552	60	1965	85799	85	1977	200640	200	1976
40702	40	1967	60553	60	1965	85852	85	1968	200649	200	1976
40703	40	1967	60632	60	1966	85853	85	1968	200740	200	1977
40752	40	1967	60633	60	1966	85890	85	1978	200749	200	1977
40753	40	1967	60652	60	1966	85892	85	1968	200840	200	1978
40772	40	1967	60653	60	1966	85893	85	1968	200849	200	1978
40773	40	1967	60732	60	1967	85895	85	1978	200940	200	1979
40802	40	1968	60733	60	1967	85899	85	1978	200949	200	1979
40803	40	1968	60752	60	1967	85990	85	1979	235840	235	1978
40852	40	1968	60753	60	1967	85993	85	1969	235849	235	1978
40853	40	1968	65272	65	1972	85995	85	1979	235940	235	1979
40872	40	1968	65273	65	1972	85999	85	1979	235949	235	1979
40873	40	1968	65372	65	1973	90482	90	1964			
40902	40	1969	65373	65	1973	90483	90	1964			
40903	40	1969	65832	65	1968	90492	90	1964			
40952	40	1969	65833	65	1968	90493	90	1964			
40953	40	1969	65852	65	1968	90582	90	1965			
40972	40	1969	65853	65	1968	90583	90	1965			
40973	40	1969	70442	70	1974	90592	90	1965			
50172	50	1971	70443	70	1974	90593	90	1965	1R69	1.5	1969
50173	50	1971	70472	70	1974	100193	100	1971	1R70	1.5	1970
50202	50	1972	70473	70	1974	100293	100	1972	2R71	2	1971
50203	50	1972	70572	70	1975	100683	100	1966	2R72	2	1972
									2R73	2	1973
									2R74	2	1974
									2R75	2	1975

Johnson Outboards 1960-1979		
1R69	1.5	1969
1R70	1.5	1970
2R71	2	1971
2R72	2	1972
2R73	2	1973
2R74	2	1974
2R75	2	1975

Johnson Outboards 1960-1979			Johnson Outboards 1960-1979			Johnson Outboards 1960-1979			Johnson Outboards 1960-1979		
MODEL NO.	HP	YEAR	MODEL NO.	HP	YEAR	MODEL NO.	HP	YEAR	MODEL NO.	HP	YEAR
2R76	2	1976	25E75-25EL75	25	1975	85EL76	85	1976	235TXL79	235	1979
2R77	2	1977	25E76-25EL76	25	1976	85EL77	85	1977	CD-17	5.5	1960
2R78	2	1978	25E77-25EL77	25	1977	85ESL69	85	1969	CD-18	5.5	1961
2R79	2	1979	25E78-25EL78	25	1978	85ESL70	85	1970	CD-19	5.5	1962
4R69-4RL69	4	1969	25E79-25EL79	25	1979	85ESL71	85	1971	CD-20	5.5	1963
4R70-4RL70	4	1970	25R69-25RL69	25	1969	85ESL72	85	1972	CD-21	5.5	1964
4R71-4RL71	4	1971	25R70-25RL70	25	1970	85ESL73	85	1973	CD-22	6	1965
4R72-4RL72	4	1972	25R71-25RL71	25	1971	85ESL74	85	1974	CD-23	6	1966
4R73-4RL73	4	1973	25R72-25RL72	25	1972	85ESL75	85	1975	CD-24	6	1967
4R74-4RL74	4	1974	25R73-25RL73	25	1973	85ETLR76	85	1976	CD-25	6	1968
4R75-4RL75	4	1975	25R74-25RL74	25	1974	85ETLR77	85	1977	FD-14	18	1960
4R76-4RL76	4	1976	25R75-25RL75	25	1975	85ETLR78	85	1978	FD-15	18	1961
4R77-4RL77	4	1977	25R76-25RL76	25	1976	85ML78	85	1978	FD-16	18	1962
4R78-4RL78	4	1978	25R77-25RL77	25	1977	85ML79	85	1979	FD-17	18	1963
4R79-4RL79	4	1979	25R78-25RL78	25	1978	85TL79	85	1979	FD-18	18	1964
4W69	4	1969	25R79-25RL79	25	1979	85TXL79	85	1979	FD-19	18	1965
4W70-4WL70	4	1970	33E69-33EL69	33	1969	85TXLR77	85	1977	FD-20	20	1966
4W71-4WL71	4	1971	33E70-33EL70	33	1970	85TXLR78	85	1978	FD-21	20	1967
4W72	4	1972	33R69-33RL69	33	1969	100ESL71	100	1971	FD-22	20	1968
4W73	4	1973	33R70-33RL70	33	1970	100ESL72	100	1972	JH-19	3	1964
4W74	4	1974	35E76-35EL76	35	1976	100ML79	100	1979	JH-20	3	1965
4W75	4	1975	35E77-35EL77	35	1977	100TLR79	100	1979	JH-21	3	1966
4W76	4	1976	35E78-35EL78	35	1978	100TXLR79	100	1979	JH-22	3	1967
4W77	4	1977	35E79-35EL79	35	1979	115EL76	115	1976	JH-23	3	1968
4W78	4	1978	35R76-35RL76	35	1976	115EL77	115	1977	JHF-21	3	1967
4W79	4	1979	35R77-35RL77	35	1977	115ESL69	115	1969	JHF-22	3	1967
6R69-6RL69	6	1969	35R78-35RL78	35	1978	115ESL70	115	1970	JHF-23	3	1968
6R70-6RL70	6	1970	35R79-35RL79	35	1979	115ESL73	115	1973	JW-16	3	1960
6R71-6RL71	6	1971	40E69-40EL69	40	1969	115ESL74	115	1974	JW-17	3	1961-62
6R72-6RL72	6	1972	40E70-40EL70	40	1970	115ESL75	115	1975	JW-18	3	1963
6R73-6RL73	6	1973	40E71-40EL71	40	1971	115ETL74	115	1974	JW-19	3	1964
6R74-6RL74	6	1974	40E72-40EL72	40	1972	115ETL75	115	1975	JW-20	3	1965
6R75-6RL75	6	1975	40E73-40EL73	40	1973	115ETL76	115	1976	JW-21	3	1966
6R76-6RL76	6	1976	40E74-40EL74	40	1974	115ETL77	115	1977	JW-22	3	1967
6R77-6RL77	6	1977	40E75-40EL75	40	1975	115ETL78	115	1978	JW-23	3	1968
6R78-6RL78	6	1978	40E76-40EL76	40	1976	115ML78	115	1978	JWF-21	3	1967
6R79-6RL79	6	1979	40ES69-40ESL69	40	1969	115ML79	115	1979	JWF-23	3	1968
8RCI-8RLCI	7.5	1981	40ES70-40ESL70	40	1970	115TL79	115	1979	LD-10	5	1965
8RCN-8RLCN	7.5	1982	40R69-40RL69	40	1969	115TXL77	115	1977	LD-11	5	1966
8RCS-8RLCS	7.5	1980	40R70-40RL70	40	1970	115TXL78	115	1978	LD-12	5	1967
8RCT-8RLCT	7.5	1983	40R71-40RL71	40	1971	115TXL79	115	1979	LD-13	5	1968
9R69-9RL69	9.5	1969	40R72-40RL72	40	1972	125ESL71	125	1971	MQ-10	9.5	1964
9R70-9RL70	9.5	1970	40R73-40RL73	40	1973	125ESL72	125	1972	MQ-11	9.5	1965
9R71-9RL71	9.5	1971	40R74-40RL74	40	1974	135EL76	135	1976	MQ-12	9.5	1966
9R72-9RL72	9.5	1972	40R75-40RL75	40	1975	135ESL73	135	1973	MQ-13	9.5	1967
9R73-9RL73	9.5	1973	40R76-40RL76	40	1976	135ESL74	135	1974	MQ-14	9.5	1968
10E74-10EL74	9.9	1974	50ES71-50ESL71	50	1971	135ESL75	135	1975	QD-21	10	1960
10E75-10EL75	9.9	1975	50ES72-50ESL72	50	1972	135ETL74	135	1974	QD-22	10	1961
10E76-10EL76	9.9	1976	50ES73-50ESL73	50	1973	135ETL75	135	1975	QD-23	10	1962
10E77-10EL77	9.9	1977	50ES74-50ESL74	50	1974	135ETL76	135	1976	QD-24	10	1963
10E78-10EL78	9.9	1978	50ES75-50ESL75	50	1975	140ML77	140	1977	RD-22	40	1960
10E79-10EL79	9.9	1979	50R72-50RL72	50	1972	140ML78	140	1978	RD-23	40	1961
10R74-10RL74	9.9	1974	50R73-50RL73	50	1973	140ML79	140	1979	RD-24	40	1962
10R75-10RL75	9.9	1975	50R77-50RL77	50	1977	140TL77	140	1977	RD-25	40	1963
10R76-10RL76	9.9	1976	50R78-50RL78	50	1978	140TL78	140	1978	RD-26	40	1964
10R77-10RL77	9.9	1977	50R79-50RL79	50	1979	140TL79	140	1979	RD-27	40	1965
10R78-10RL78	9.9	1978	55E76-55EL76	55	1976	140TXL77	140	1977	RD-28	40	1966
10R79-10RL79	9.9	1979	55E77-55EL77	55	1977	140TXL78	140	1978	RD-29	40	1967
10SEL78	9.9	1978	55E78-55EL78	55	1978	140TXL79	140	1979	RD-30	40	1968
10SEL79	9.9	1979	55E79-55EL79	55	1979	150TL78	150	1978	RDS-22	40	1960
15E74-15EL74	15	1974	55ES69-55ESL69	55	1969	150TL79	150	1979	RDS-23	40	1961
15E75-15EL75	15	1975	55R79-55RL79	55	1979	150TXL78	150	1978	RDS-24	40	1962
15E76-15EL76	15	1976	60ES70-60ESL70	60	1970	150TXL79	150	1979	RDS-25	40	1963
15E77-15EL77	15	1977	60ES71-60ESL71	60	1971	175TL77	175	1977	RDS-26	40	1964
15E78-15EL78	15	1978	65ES72-65ESL72	65	1972	175TL78	175	1978	RDS-27	40	1965
15E79-15EL79	15	1979	65ES73-65ESL73	65	1973	175TL79	175	1979	RDS-28	40	1966
15R74-15RL74	15	1974	65ESLR72	65	1972	175TXL77	175	1977	RDS-29	40	1967
15R75-15RL75	15	1975	65ESR73-65ESLR73	65	1973	175TXL78	175	1978	RDS-30	40	1968
15R76-15RL76	15	1976	70EL76	70	1976	175TXL79	175	1979	RK-24	40	1962
15R77-15RL77	15	1977	70EL77	70	1977	200TL76	200	1976	RK-25	40	1963
15R78-15RL78	15	1978	70EL78	70	1978	200TL77	200	1977	RK-26	40	1964
15R79-15RL79	15	1979	70EL79	70	1979	200TL78	200	1978	RK-27	40	1965
20R69-20RL69	20	1969	70ES74-70ESL74	70	1974	200TL79	200	1979	RK-28	40	1966
20R70-20RL70	20	1970	70ES75-70ESL75	70	1975	200TXL76	200	1976	RK-29	40	1967
20R71-20RL71	20	1971	70ESLR74	70	1974	200TXL77	200	1977	RK-30	40	1968
20R72-20RL72	20	1972	75ER76-75ELR76	75	1976	200TXL78	200	1978	RX-10	28	1962
20R73-20RL73	20	1973	75ER77-75ELR77	75	1977	200TXL79	200	1979	RX-11	28	1963
25E72-25EL72	25	1972	75ER78-75ELR78	75	1978	235TL78	235	1978	RX-12	28	1964
25E73-25EL73	25	1973	75ER79-75ELR79	75	1979	235TL79	235	1979	RX-13	33	1965
25E74-25EL74	25	1974	75ESR75-75ESLR75	75	1975	235TXL78	235	1978	RX-14	33	1966

Johnson Outboards 1960-1979			Johnson Outboards 1980 & Later			Johnson Outboards 1980 & Later			Johnson Outboards 1980 & Later		
MODEL NO.	HP	YEAR	MODEL NO.	HP	YEAR	MODEL NO.	HP	YEAR	MODEL NO.	HP	YEAR
RX-15	33	1967	4RCC-4RLCC	4	1988	8RCT-8RLCT	7.5	1983	15RCS-15RLCS	15	1980
RX-16	33	1968	4RCE-4RLCE	4	1989	8RCU-8RLCU	8	1987	15RCT-15RLCT	15	1983
RXE-11	28	1963	4RCU-4RLCU	4	1987	8RES-8RLES	8	1990	15RCU-15RLCU	15	1987
RXE-12	28	1964	4RDCD-4RDLCD	4	1986	8SRLCC	8	1988	15RELES	15	1990
RXE-13	33	1965	4RDCC-4RDLCO	4	1985	8SRLCD	8	1986	15RES-15RLES	15	1990
RXE-14	33	1966	4RDCC-4RDLCR	4	1984	8SRLCN	7.5	1982	15SPCE-15SPLCE	15	1989
RXE-15	33	1967	4RDHCC-4RDHLCC	4	1988	8SRLCO	8	1985	15SPES-15SPLES	15	1990
RXE-16	33	1968	4RDHCD-4RDHLCD	4	1986	8SRLCR	8	1984	20BFCC-20BFLCC	20	1988
SC-10	1.5	1968	4RDHCE-4RDHLCE	4	1989	8SRLCT	7.5	1983	20BFCD-20BFLCD	20	1986
TR-10	55	1968	4RDHCO-4RDHLCO	4	1985	8SRLCU	8	1987	20BFCE-20BFLCE	20	1989
V4A-13	75	1961	4RDHCR-4RDHLCR	4	1984	10BACC-10BALCC	9.9	1988	20BFCC-20BFLCC	20	1988
V4A-14	75	1962-63	4RDHCU-4RDHLCU	4	1987	10BACD-10BALCD	9.9	1986	20BFCD-20BFLCD	20	1986
V4A-15	75	1962-63	4RDHES-4RDHLES	4	1990	10BACE-10BALCE	9.9	1989	20BFCC-20BFLCC	20	1988
V4A-16	75	1964	4RES-4RLES	4	1990	10BACO-10BALCO	9.9	1985	20BFCE-20BFLCE	20	1989
V4A-17	75	1965	4RLCS	4	1980	10BACR-10BALCR	9.9	1984	20BFCD-20BFLCD	20	1986
V4A-18	80	1966	4WCI	4	1981	10BACU-10BALCU	9.9	1987	20BFCC-20BFLCC	20	1988
V4A-19	80	1967	4WCN	4	1982	10BAES-10BALES	9.9	1990	20BFCD-20BFLCD	20	1986
V4A-20	85	1968	4WCS	4	1980	10ECC-10ELCC	9.9	1988	20BFCE-20BFLCE	20	1989
V4H-16	75	1964	5BFCD-5BFLCD	5	1986	10ECD-10ELCD	9.9	1986	20BFCC-20BFLCC	20	1988
V4H-17	75	1965	5BFCO-5BFLCO	5	1985	10ECE-10ELCE	9.9	1989	20BFCD-20BFLCD	20	1986
V4H-18	75	1966	5BFCC-5BFLCC	5	1984	10ECO-10ELCO	9.9	1985	20BFCE-20BFLCE	20	1989
V4M-10	90	1964	5BFCC-5BFLCC	5	1987	10ECS-10ELCS	9.9	1980	20BFCD-20BFLCD	20	1986
V4M-11	90	1965	5DRCC-5DRLCC	5	1988	10ECU-10ELCU	9.9	1987	20BFCE-20BFLCE	20	1989
V4ML-12	100	1966	5DRCE-5DRLCE	5	1989	10EES-10ELES	9.9	1990	20BFCC-20BFLCC	20	1988
V4S-12	75	1960	5DRES-5DRLES	5	1990	10ELCI	9.9	1981	20BFCD-20BFLCD	20	1986
V4S-13	75	1961	5RCI-5RLCI	4.5	1981	10ELCN	9.9	1982	20BFCE-20BFLCE	20	1989
V4S-14	75	1962	5RCN-5RLCN	4.5	1982	10ELCR	9.9	1984	20BFCC-20BFLCC	20	1988
V4S-15	75	1963	5RCS-5RLCS	4.5	1980	10RCC-10RLCC	9.9	1988	20BFCD-20BFLCD	20	1986
V4S-16	75	1964	5RCT-5RLCT	4.5	1983	10RCD-10RLCD	9.9	1986	20BFCE-20BFLCE	20	1989
V4S-17	75	1965	5RHCD	4.5	1986	10RCE-10RLCE	9.9	1989	20BFCC-20BFLCC	20	1988
V4S-18	80	1966	5RHCI-5RHLCI	4.5	1981	10RCI-10RLCI	9.9	1981	20BFCD-20BFLCD	20	1986
V4S-19	80	1967	5RHCN-5RHLCN	4.5	1982	10RCN-10RLCN	9.9	1982	20BFCE-20BFLCE	20	1989
V4S-20	85	1968	5RHCO	4.5	1985	10RCO-10RLCO	9.9	1985	20BFCC-20BFLCC	20	1988
V4T-13	100	1967	5RHCR	4.5	1984	10RCR-10RLCR	9.9	1984	20BFCD-20BFLCD	20	1986
V4T-14	100	1968	5RHCS-5RHLCs	4.5	1980	10RCS-10RLCS	9.9	1980	20BFCE-20BFLCE	20	1989
V4TL-13	100	1967	5RHCT-5RHLCt	4.5	1983	10RCT-10RLCT	9.9	1983	20BFCC-20BFLCC	20	1988
V4TL-14	100	1968	5RHCU	4.5	1987	10RCU-10RLCU	9.9	1987	20BFCD-20BFLCD	20	1986
VX-10	60	1964	6BACC-6BALCC	6	1988	10RELES	9.9	1990	20BFCE-20BFLCE	20	1989
VX-11	60	1965	6BACD-6BALCD	6	1986	10RES-10RLES	9.9	1990	20BFCC-20BFLCC	20	1988
VX-12	60	1966	6BACE-6BALCE	6	1989	10SELCC	9.9	1988	20BFCD-20BFLCD	20	1986
VX-13	60	1967	6BACO-6BALCO	6	1985	10SELCD	9.9	1986	20BFCE-20BFLCE	20	1989
VX-14	65	1968	6BACR-6BALCR	6	1984	10SELCE	9.9	1989	20BFCC-20BFLCC	20	1988
VXH-10	60	1964	6BACU-6BALCU	6	1987	10SELCI	9.9	1981	20BFCD-20BFLCD	20	1986
VXH-11	60	1965	6BAES-6BALES	6	1989	10SELCN	9.9	1982	20BFCE-20BFLCE	20	1989
VXH-12	60	1966	6BFCD-6BFLCD	6	1986	10SELCO	9.9	1985	20BFCC-20BFLCC	20	1988
VXH-13	60	1967	6BFCC-6BFLCC	6	1985	10SELCR	9.9	1984	20BFCD-20BFLCD	20	1986
VXH-14	65	1968	6BFCC-6BFLCC	6	1984	10SELCS	9.9	1980	20BFCE-20BFLCE	20	1989
			6BFCC-6BFLCC	6	1987	10SELCT	9.9	1983	20BFCC-20BFLCC	20	1988
			6DRCC-6DRLCC	6	1988	10SELCO	9.9	1987	20BFCD-20BFLCD	20	1986
			6DRCE-6DRLCE	6	1989	10SELES	9.9	1990	20BFCE-20BFLCE	20	1989
			6DRES-6DRLES	6	1990	10SPCC-10SPLCC	9.9	1988	20BFCC-20BFLCC	20	1988
			6RCC-6RLCC	6	1988	10SPCE-10SPLCE	9.9	1989	20BFCD-20BFLCD	20	1986
			6RCD-6RLCD	6	1986	10SPES-10SPLES	9.9	1990	20BFCE-20BFLCE	20	1989
			6RCE-6RLCE	6	1989	14RCC	14	1988	20BFCC-20BFLCC	20	1988
			6RCO-6RLCO	6	1985	14RCE	14	1989	20BFCD-20BFLCD	20	1986
			6RCR-6RLCR	6	1984	15BACC-15BALCC	15	1988	20BFCE-20BFLCE	20	1989
			6RCU-6RLCU	6	1987	15BACD-15BALCD	15	1986	20BFCC-20BFLCC	20	1988
			6RES-6RLES	6	1990	15BACE-15BALCE	15	1989	20BFCD-20BFLCD	20	1986
			6SLCC	6	1988	15BACO-15BALCO	15	1985	20BFCE-20BFLCE	20	1989
			6SLCD	6	1986	15BACR-15BALCR	15	1984	20BFCC-20BFLCC	20	1988
			6SLCE	6	1989	15BACU-15BALCU	15	1987	20BFCD-20BFLCD	20	1986
			6SLCO	6	1985	15BAES-15BALES	15	1990	20BFCE-20BFLCE	20	1989
			6SLCR	6	1984	15ECC-15ELCC	15	1988	20BFCC-20BFLCC	20	1988
			6SLCU	6	1987	15ECD-15ELCD	15	1986	20BFCD-20BFLCD	20	1986
			6SLES	6	1990	15ECE-15ELCE	15	1989	20BFCE-20BFLCE	20	1989
			8BACC-8BALCC	8	1988	15ECI	15	1981	20BFCC-20BFLCC	20	1988
			8BACD-8BALCD	8	1986	15ECN	15	1982	20BFCD-20BFLCD	20	1986
			8BACE-8BALCE	8	1989	15ECO-15ELCO	15	1985	20BFCE-20BFLCE	20	1989
			8BACO-8BALCO	8	1985	15ECR-15ELCR	15	1984	20BFCC-20BFLCC	20	1988
			8BACR-8BALCR	8	1984	15ECS-15ELCS	15	1980	20BFCD-20BFLCD	20	1986
			8BACU-8BALCU	8	1987	15ECT-15ELCT	15	1983	20BFCE-20BFLCE	20	1989
			8BAES-8BALES	8	1990	15ECU-15ELCU	15	1987	20BFCC-20BFLCC	20	1988
			8RCC-8RLCC	8	1988	15EES-15ELES	15	1990	20BFCD-20BFLCD	20	1986
			8RCD-8RLCD	8	1986	15RCC-15RLCC	15	1988	20BFCE-20BFLCE	20	1989
			8RCE-8RLCE	8	1989	15RCD-15RLCD	15	1986	20BFCC-20BFLCC	20	1988
			8RCI-8RLCI	7.5	1981	15RCE-15RLCE	15	1989	20BFCD-20BFLCD	20	1986
			8RCN-8RLCN	7.5	1982	15RCI-15RLCI	15	1981	20BFCE-20BFLCE	20	1989
			8RCO-8RLCO	8	1985	15RCN-15RLCN	15	1982	20BFCC-20BFLCC	20	1988
			8RCR-8RLCR	8	1984	15RCO-15RLCO	15	1985	20BFCD-20BFLCD	20	1986
			8RCS-8RLCS	7.5	1980	15RCR-15RLCR	15	1984	20BFCE-20BFLCE	20	1989

Johnson Outboards 1980 & Later		
2RCI	2	1981
2RCN	2	1982
2RCO	2	1985
2RCR	2	1984
2RCS	2	1980
2RCT	2	1983
3BRC	3	1989
3BRE	3	1990
3RCC	2.5	1988
3RCU	2.5	1987
4BRCC-4BLRCC	4	1988
4BRCD-4BRLCD	4	1986
4BRCI-4BRLCI	4	1981
4BRCN-4BRLCN	4	1982
4BRCO-4BRLCO	4	1985
4BRCR-4BRLCR	4	1984
4BRCT-4BRLCT	4	1983
4BRCU-4BRLCU	4	1987
4BRES-4BRLES	4	1990
4BRHCC-4BRHLCC	4	1988
4BRHCD-4BRHLCD	4	1986
4BRHCE-4BRHLCE	4	1989
4BRHCI-4BRHLCI	4	1981
4BRHCN-4BRHLCN	4	1982
4BRHCO-4BRHLCO	4	1985
4BRHCR-4BRHLCR	4	1984
4BRHCT-4BRHLCT	4	1983
4BRHCU-4BRHLCU	4	1987
4BRHES-4BRHLES	4	1990

Johnson Outboards 1980 & Later				Johnson Outboards 1980 & Later				Johnson Outboards 1980 & Later				Johnson Outboards 1980 & Later			
MODEL NO.	HP	YEAR		MODEL NO.	HP	YEAR		MODEL NO.	HP	YEAR		MODEL NO.	HP	YEAR	
25RCI-25RLCI	25	1981		35RCU-35RLCU	35	1987		60ELCD	60	1986		100MLCS	100	1980	
25RCN-25RLCN	25	1982		35RELC	35	1983		60ELCE	60	1989		100SLES	100	1990	
25RCO-25RLCO	25	1985		35RES-35RELES	35	1990		60ELCU	60	1987		100STLCC	100	1988	
25RCR-25RLCR	25	1984		35TELCN	35	1982		60ELES	60	1990		100STLCE	100	1989	
25RCS-25RLCS	25	1980		35TELCR	35	1984		60TLCC	60	1988		100STLES	100	1990	
25RCT-25RLCT	25	1983		40AELCC	40	1988		60TLCD	60	1986		100TLC	100	1980	
25RCU-25RLCU	25	1987		40ARLCC	40	1988		60TLCE	60	1989		100TXCS	100	1980	
25RES-25RLES	25	1990		40ATLCC	40	1988		60TLCI	60	1981		110MLCC	110	1988	
25SECC-25SELCC	25	1988		40BACC-40BALCC	40	1988		60TLCN	60	1982		110MLCD	110	1986	
25SECE-25SELCE	25	1989		40BACD-40BALCD	40	1986		60TLCO	60	1985		110MLCE	110	1989	
25SEES-25SELES	25	1990		40BACE-40BALCE	40	1989		60TLCR	60	1984		110MLCU	110	1987	
25SRCC-25SRLCC	25	1988		40BACO-40BALCO	40	1985		60TLCT	60	1983		110TLAE	110	1989	
25SRCS-25SRLCS	25	1989		40BACU-40BALCU	40	1987		60TLCU	60	1987		110TLCC-110TXCC	110	1988	
25SRCT-25SRLCT	25	1990		40BAES-40BALES	40	1990		60TLES	60	1990		110TLCD	110	1986	
25TECC-25TELCC	25	1988		40ECC-40ELCC	40	1988		60TLLE	60	1989		110TLCE-110TXCE	110	1989	
25TECD-25TELCD	25	1986		40ECD-40ELCD	40	1986		60TLLES	60	1990		110TLCU-110TXCU	110	1987	
25TECE-25TELCE	25	1989		40ECE-40ELCE	40	1989		60TTLCC	60	1988		115MLCI	115	1981	
25TECI-25TELCI	25	1981		40ECO-40ELCO	40	1985		70ELCC	70	1988		115MLCN	115	1982	
25TECN-25TELCN	25	1982		40ECL-40ELCL	40	1984		70ELCD	70	1986		115MLCO	115	1985	
25TECO-25TELCO	25	1985		40ECU-40ELCU	40	1987		70ELCE	70	1989		115MLCR	115	1984	
25TECR-25TELCR	25	1984		40EES-40ELES	40	1990		70ELCI	70	1981		115MLCS	115	1980	
25TECS-25TELCS	25	1980		40RCC-40RLCC	40	1988		70ELCN	70	1982		115MLCT	115	1983	
25TECT-25TELT	25	1983		40RCD-40RLCD	40	1986		70ELCO	70	1985		115MLES	115	1990	
25TECU-25TELCU	25	1987		40RCE-40RLCE	40	1989		70ELCR	70	1984		115TLCI-115TXCI	115	1981	
25TEES-25TELES	25	1990		40RCO-40RLCO	40	1985		70ELCS	70	1980		115TLCN-115TXCN	115	1982	
28ELCD	28	1986		40RCU-40RLCU	40	1987		70ELCT	70	1983		115TLCO	115	1985	
28ESLCC	28	1988		40RES-40RLES	40	1990		70ELCU	70	1987		115TLCR-115TXCR	115	1984	
28ESLCE	28	1989		40TECC-40TELCC	40	1988		70ELES	70	1990		115TLCS-115TXCS	115	1980	
28ESLCU	28	1987		40TECD-40TELCD	40	1986		70TLCC	70	1988		115TLCT-115TXCT	115	1983	
28ESLES	28	1990		40TECE-40TELCE	40	1989		70TLCD	70	1986		115TLES-115TXES	115	1990	
30BACC-30BALCC	30	1988		40TECO-40TELCO	40	1985		70TLCE	70	1989		120TLAE	120	1989	
30BACD-30BALCD	30	1986		40TECR-40TELCR	40	1984		70TLCI	70	1981		120TLAS	120	1990	
30BACO-30BALCO	30	1985		40TECU-40TELCU	40	1987		70TLCN	70	1982		120TLCC-120TXCC	120	1988	
30BACU-30BALCU	30	1987		40TEES-40TELES	40	1990		70TLCO	70	1985		120TLCD-120TXCD	120	1986	
30BAES-30BALES	30	1990		40TLCC	40	1988		70TLCR	70	1984		120TLCE-120TXCE	120	1989	
30ECC-30ELCC	30	1988		40TLCD	40	1986		70TLCT	70	1983		120TLCO-120TXCO	120	1985	
30ECD-30ELCD	30	1986		40TLCE	40	1989		70TLES	70	1990		120TLCU-120TXCU	120	1987	
30ECE-30ELCE	30	1989		40TLCU	40	1987		75ECC	75	1988		120TLES-120TXES	120	1990	
30ECO-30ELCO	30	1985		40TLES	40	1990		75ECD	75	1986		140CXCC	140	1988	
30ECL-30ELCL	30	1984		40TTLCC	40	1988		75ECO	75	1985		140CXCE	140	1989	
30ECU-30ELCU	30	1987		40TTLCE	40	1989		75ECL	75	1984		140CXES	140	1990	
30EES-30ELES	30	1990		40TTLES	40	1990		75ECU	75	1987		140MLCI	140	1981	
30RCC-30RLCC	30	1988		48ESLCC	48	1988		75ELCO	75	1985		140MLCN	140	1982	
30RCD-30RLCD	30	1986		48ESLCE	48	1989		75ELCR	75	1984		140MLCR	140	1984	
30RCE-30RLCE	30	1989		48ESLCU	48	1987		75ERCI-75ERLCI	75	1981		140MLCS	140	1980	
30RCO-30RLCO	30	1985		48ESLES	48	1990		75ERCN-75ERLCN	75	1982		140MLCT	140	1983	
30RCU-30RLCU	30	1987		50BECC-50BELCC	50	1988		75ERCS-75ERLCS	75	1980		140TLAE	140	1989	
30RES-30RLES	30	1990		50BECD-50BELCD	50	1986		75ERCT-75ERLCT	75	1983		140TLAS	140	1990	
30TECC-30TELCC	30	1988		50BECE-50BELCE	50	1989		75TLCO	75	1985		140TLCC-140TXCC	140	1988	
30TECD-30TELCD	30	1986		50BECL-50BELCL	50	1981		75TLCL	75	1984		140TLCE-140TXCE	140	1989	
30TECE-30TELCE	30	1989		50BECN-50BELCN	50	1982		75TRLCI	75	1981		140TLCO-140TXCO	140	1985	
30TECO-30TELCO	30	1985		50BECO-50BELCO	50	1985		75TRLCS	75	1980		140TLCL-140TXCL	140	1984	
30TECU-30TELCU	30	1987		50BECL-50BELCL	50	1984		75TRLCT	75	1983		140TLCU-140TXCU	140	1987	
30TEES-30TELES	30	1990		50BECS-50BELCS	50	1980		85MLCS	85	1980		140TLES-140TXES	140	1990	
35AECD-35AELCD	35	1986		50BECT-50BELCT	50	1983		85TLCS-85TXCS	85	1980		140TRLCI-140TRXCI	140	1981	
35AELCU	35	1987		50BECL-50BELCL	50	1987		88MSLCC	88	1988		140TRCN-140TRXCN	140	1982	
35ARCD-35ARLCD	35	1986		50BEES-50BELES	50	1990		88MSLCE	88	1989		140TRCS-140TRXCS	140	1980	
35ARLCU	35	1987		50ECS-50ELCS	50	1980		88MSLES	88	1990		140TRLCT-140TRXCT	140	1983	
35ATECD-35ATELCD	35	1986		50TELCC	50	1988		90MLCC	90	1988		150ANCO	150	1985	
35ATECU-35ATELCU	35	1987		50TELCD	50	1986		90MLCD	90	1986		150CXCC	150	1988	
35ATLCU	35	1987		50TELCE	50	1989		90MLCE	90	1989		150CXCE	150	1989	
35BACI-35BALCI	35	1981		50TELCO	50	1985		90MLCI	90	1981		150CXES	150	1990	
35BACN-35BALCN	35	1982		50TELCR	50	1984		90MLCN	90	1982		150GTLCU	150	1987	
35BACR-35BALCR	35	1984		50TELC	50	1983		90MLCO	90	1985		150SLCE	150	1989	
35BACS-35BALCS	35	1980		50TELCU	50	1987		90MLCR	90	1984		150SLES	150	1990	
35BACT-35BALCT	35	1983		50TELES	50	1990		90MLCT	90	1983		150STLCC	150	1988	
35ECI-35ELCI	35	1981		50TLCC	50	1988		90MLCU	90	1987		150STLCD	150	1986	
35ECN-35ELCN	35	1982		50TLCD	50	1986		90TLAE	90	1990		150STLCE	150	1989	
35ECL-35ELCL	35	1984		50TLCE	50	1989		90TLAS	90	1989		150STLCO	150	1985	
35ECS-35ELCS	35	1980		50TLCO	50	1985		90TLCC-90TXCC	90	1988		150STLCR	150	1984	
35ECT-35ELCT	35	1983		50TLCL	50	1984		90TLCD-90TXCD	90	1986		150STLCT	150	1983	
35RCC-35RLCC	35	1988		50TLCU	50	1987		90TLCE-90TXCE	90	1989		150STLCU	150	1987	
35RCD-35RLCD	35	1986		50TLES	50	1990		90TLCL-90TXCL	90	1981		150STLES	150	1990	
35RCE-35RLCE	35	1989		60ECI-60ELCI	60	1981		90TLCN-90TXCN	90	1982		150TLAE	150	1989	
35RCI-35RLCI	35	1981		60ECN-60ELCN	60	1982		90TLCO-90TXCO	90	1985		150TLAS	150	1990	
35RCN-35RLCN	35	1982		60ECO-60ELCO	60	1985		90TLCL-90TXCL	90	1984		150TLCC-150TXCC	150	1988	
35RCO-35RLCO	35	1985		60ECL-60ELCL	60	1984		90TLCR-90TXCR	90	1984		150TLCD-150TXCD	150	1986	
35RCR-35RLCR	35	1984		60ECS-60ELCS	60	1980		90TLCT-90TXCT	90	1983		150TLCE-150TXCE	150	1989	
35RCS-35RLCS	35	1980		60ECT-60ELCT	60	1983		90TLCU	90	1987		150TLCO-150TXCO	150	1985	
35RCT-35RLCT	35	1983		60ELCC	60	1988		90TLES-90TXES	90	1990		150TLCL-150TXCL	150	1984	

Johnson Outboards 1980 & Later			Johnson Outboards 1980 & Later			Johnson Evinrude Commercial			Johnson Evinrude Commercial		
MODEL NO.	HP	YEAR	MODEL NO.	HP	YEAR	MODEL NO.	HP	YEAR	MODEL NO.	HP	YEAR
150TLCU-150TXCU	150	1987	300CXES	300	1990	10RSC-M	10	1983	25RWA-25RWLA	25	1988
150TLES-150TXES	150	1990	300PLCC-300PXCC	300	1988	10RSD-10RSLD	10	1985	25RWCD-25RWLCD	25	1986
150TRLCI-150TRXCI	150	1981	300PLCE-300PXCE	300	1989	10RSE-10RSL	10	1987	25RWCI-25RWLCI	25	1981
150TRLCN-150TRXCN	150	1982	300PLCU-300PXCU	300	1987	10RSG-2-10RSLG-2	10	1981	25RWCN-25RWLCN	25	1982
150TRLCS-150TRXCS	150	1980	300PLES-300PXES	300	1990	10RSJ-10RSLJ	10	1989	25RWCO-25RWLCO	25	1985
150TRLCT-150TRXCT	150	1983	300PTLCD-300PTXCDC	300	1986	10RSLC-M	10	1983	25RWCR-25RWLCR	25	1984
175STLAC	175	1988	300TLCO-300TXCO	300	1985	10RSN-10RSLN	10	1990	25RWCT-25RWLCT	25	1983
175STLCC	175	1988	C-275TLCO	275	1985	10RSR-10RSLR	10	1986	25RWCU-25RWLCU	25	1987
175STLCE	175	1990	C-275TXCO	275	1985	10RSU-10RSLU	10	1988	25RWES-25RWLES	25	1990
175TLCC-175TXCC	175	1988	C-300TLCO	300	1985	10RSW-10RSLW	10	1982	25RWK-25RWLK	25	1989
175TLCD-175TXCD	175	1986	C-300TXCO	300	1985	10RSYC-M	10	1983	35RSP-35RSLP	35	1981
175TLCE-175TXCE	175	1989	C-E275PTLCD	275	1986	10RSYD	10	1985	40R78B-40RL78B	40	1978
175TLCO-175TXCO	175	1985	C-E275PTXCD	275	1986	10RSYR	10	1986	40R79E-40RL79E	40	1979
175TLCU-175TXCU	175	1987	C-E300PTLCD	300	1986	10RSYZ	10	1984	40RCA-40RCLA	40	1989
175TLES-175TXES	175	1990	C-E300PTXCD	300	1986	10RSZ-10RSLZ	10	1984	40RCB-40RCLB	40	1986
175TRLCI-175TRXCI	175	1981	CO-CC	1.2	1988	11KCA-11KCLA	11	1983	40RCH-40RCLH	40	1985
175TRLCN-175TRXCN	175	1982	CO-CD	1.2	1986	11KCG-11KCLG	11	1985	40RCK-40RCLK	40	1990
175TRLCS-175TRXCS	175	1980	CO-CE	1.2	1990	11KCS-11KCLS	11	1984	40RCP-40RCLP	40	1984
175TRLCT-175TRXCT	175	1983	CO-CU	1.2	1987	11KCW-11KCLW	11	1986	40RCT-40RCLT	40	1987
185ESXES	185	1990	CO-ES	1.2	1990	11KSLW-11KSYW	11	1986	40RCV-RCLV	40	1983
185ESXW	185	1989	JR-CC	1.2	1988	12K79S	12	1979	40RCY-40RCLY	40	1988
185TLCO-185TXCO	185	1985	JR-CD	1.2	1986	12KCCSC	12	1980	40RCYA	40	1989
185TLCR-185TXCR	185	1984	JR-CE	1.2	1989	12KCLCSC	12	1980	40RCYB	40	1986
200CXCE	200	1989	JR-CU	1.2	1987	12KCXCSC	12	1980	40RCYH	40	1985
200CXES	200	1990	JR-ES	1.2	1990	12KXL79S	12	1979	40RCYK	40	1990
200SLES	200	1990	KT-11C	15A	1987	12LK79S	12	1979	40RCYP	40	1984
200STLAC	200	1988	KT-12R	15A	1988	12R78S	12	1978	40RCYT	40	1987
200STLCC	200	1988	KT-13A	15A	1989	12RL78S	12	1978	40RCYV	40	1983
200STLCD	200	1986	KT-14M	15A	1990	12RL79C-R	12	1979	40RCYY	40	1988
200STLCE	200	1989	RTE-11C	45SS	1987	12RSCSA	12	1980	40RSCSD	40	1980
200STLCU	200	1987	RTE-12R	45SS	1988	12RSLCSA	12	1980	40RSD-R	40	1981
200STLES	200	1990	RTE-13A	45SS	1989	12RSXCSA	12	1980	40RSLCSD	40	1980
200TLCT-200TRXCT	200	1983	RTE-14M	45SS	1990	12RXL78S	12	1978	40RSLD-R	40	1981
200TRLCI-200TRXCI	200	1981	STE-13A	SST-60	1989	12RL79R	12	1979	40RSR-40RSLR	40	1982
200TRLCN-200TRXCN	200	1982	STE-14M	SST-60	1990	14RSB-14RSLB	14	1990	40RWCD-40RWLCD	40	1986
200TRLCS-200TRXCS	200	1980	Johnson Evinrude Commercial			14RSE-14RSL	14	1982	40RWCI-40RWLCI	40	1981
200TXCC	200	1988	4RST-4RSLT	4	1981	14RSF-14RSLF	14	1985	40RWCC-40RWLCC	40	1982
200TXCD	200	1986	4RSY-4RSLY	4	1982	14RSH-14RSLH	14	1989	40RWCO-40RWLCO	40	1985
200TXCE	200	1989	6K79S-6KL79S	6	1979	14RSLR-2	14	1981	40RWCR-40RWLCR	40	1984
200TXCU	200	1987	6KCB-6KCLB	6	1983	14RSLU-J	14	1983	40RWCCD-40RWLCD	40	1983
200TXES	200	1990	6KCCSC	6	1980	14RSLN-14RSLN	14	1984	45RCCD-45RCLCD	45	1986
225CLCU-225CXCU	225	1987	6KCH-6KCLH	6	1981	14RSQ-14RSLQ	14	1988	45RCCU-45RCLCU	45	1987
225CXCC	225	1988	6KCLCSC	6	1980	14RSR-2	14	1981	45RCE-45RCL	45	1989
225CXCE	225	1989	6KCT-6KCLT	6	1984	14RSU-J	14	1983	45RCR-45RCLR	45	1988
225CXES	225	1990	6RST-6RSLT	6	1978	14RSV-14RSLV	14	1987	45RSD-45RSLD	45	1986
225PLAE	225	1989	6RS78B-6RSL78B	6	1978	14RSYF	14	1985	45RSE-45RSLE	45	1988
225PLAS	225	1990	6RS79E-6RSL79E	6	1979	14RSYN	14	1984	45RSJ-45RSLJ	45	1990
225PLCC-225PXCC	225	1988	6RSCSD-6RSLCSD	6	1980	14RSYQ	14	1986	45RSR-45RSLR	45	1987
225PLCU-225PXCU	225	1987	6RSM-6RSLM	6	1981	14RSYU-J	14	1983	45RSU-45RSLU	45	1989
225PLES-225PXES	225	1990	6RSZ-6RSLZ	6	1983	15RSH-B	15	1983	45RSYD	45	1986
225PLES-225SPXES	225	1990	7RSA-7RSLA	6.5	1989	15RSLH-B	15	1983	45RSYK	45	1990
225PTLCD-225PTXCD	225	1986	7RSB-7RSLB	7	1986	15RSP-15RSLP	15	1982	45RSYR	45	1987
225SCXES	225	1990	7RSF-7RSLF	6.5	1981	23R79C-R	12	1979	45RSYU	45	1989
225SLES	225	1990	7RSH-7RSLH	6.5	1985	25KCG-25KCLG	25	1986	45RSYZ	45	1985
225STLES	225	1990	7RSK-7RSLK	7	1990	25KCS-25KCLS	25	1985	45RSZ-45RSLZ	45	1985
225TLAE	225	1989	7RSP-7RSLP	6.5	1984	25KCW-25KCLW	25	1987	45RWD-45RWLD	45	1986
225TLAS	225	1990	7RSQ-7RSLQ	6.5	1982	25RPB-25RPLB	25	1984	45RWLE-45RWYE	45	1988
225TLCC-225TXCC	225	1988	7RST-7RSLT	7	1987	25RPD	25	1989	45RWLJ-45RWYJ	45	1990
225TLCD-225TXCD	225	1986	7RSV-7RSLV	6.5	1983	25RPH-25RPLH	25	1982	45RWLW-45RWYR	45	1987
225TLCE-225TXCE	225	1989	7RSY-7RSLY	7	1988	25RPR	25	1990	45RWLU-45RWYU	45	1989
225TLCO-225TXCO	225	1987	9K79S	9	1979	25RS78C-25RSL78C	25	1978	45RWYD	45	1986
225TLCU-225TXCU	225	1987	9KCCSC	9	1980	25RS79R-25RSL79R	25	1979	45RWZ-45RWLZ	45	1985
225TLES-225TXES	225	1990	9KCLCSC	9	1980	25RSA-25RSLA	25	1981	45WMLE	45	1989
235STLCO	235	1985	9KXCSC	9	1980	25RSC-25RSLC	25	1986	45WMLES	45	1990
235STLCR	235	1984	9KXL79S	9	1979	25RSCSA-25RSLCSA	25	1980	50RS78C-G	50	1978
235STLCT	235	1983	9KX79S	9	1979	25RSG-2-25RSLG-2	25	1984	50RS79R-50RSL79R	50	1979
235TLCO-235TXCO	235	1985	9R78S	9	1978	25RSK-25RSLK	25	1982	50RSL78C-G	50	1978
235TLCR-235TXCR	235	1984	9R79C-R	9	1979	25RSM-25RSLM	25	1987	55AWQ-55AWLQ	55	1985
235TRLCI-235TRXCI	235	1981	9RL78S	9	1978	25RSR-25RSLR	25	1990	55RCI-55RLCI	55	1981
235TRLCN-235TRXCN	235	1982	9RL79C-R	9	1979	25RSS-25RSLS	25	1983	55RCN-55RLCN	55	1982
235TRLCS-235TRXCS	235	1980	9RSCSA	9	1980	25RSW-25RSLW	25	1985	55RCT-55RLCT	55	1983
235TRLCT-235TRXCT	235	1983	9RSLCSA	9	1980	25RSYD	25	1986	55RLCS	55	1980
275CLCU-275CXCU	275	1987	9RSXCSA	9	1980	25RSYR	25	1989	55RSB-55RSLB	55	1989
275CXCC	275	1988	9RXL78S	9	1978	25RSYG-2	25	1984	55RSCS-55RSLCS	55	1980
275CXCE	275	1989	9RXL79R	9	1979	25RSYM	25	1987	55RSF-55RSLF	55	1984
275PLCC-275PXCC	275	1988	10KCC-10KCLC	10	1987	25RSYS	25	1983	55RSH-55RSLH	55	1988
275PLCU-275PXCU	275	1987	10KCLD	10	1990	25RSYW	25	1985	55RSJ-55RSLJ	55	1982
275PTLCD-275PTXCD	275	1986	10KSLC	10	1987	25RSYZ	25	1988	55RSN-55RSLN	55	1983
275TLCO-275TXCO	275	1985				25RSZ-25RSLZ	25	1988	55RSP-55RSLP	55	1987
300CLCUR-300CXCU	300	1987									
300CXCC	300	1988									
300CXCE	300	1989									

Johnson Evinrude Commercial			Johnson Evinrude Commercial			McCulloch Outboard			McCulloch Outboard			
MODEL NO.	HP	YEAR	MODEL NO.	HP	YEAR	MODEL NO.	HP	YEAR	MODEL NO.	HP	YEAR	
55RSQ-55RSLQ	55	1985	125WTPG-125WTPXG	125	1988	80355	7.5	1966-68	65302810	28	1965	
55RST-55RSLT	55	1990	125WTPLS-125WTPXS	125	1987	80370	14	1966-67	65302830	28	1965	
55RSU-55RSLU	55	1981	125WTPLW-125WTPXW	125	1989	80373	14	1966-67	65304510	45	1965	
55RSV-55RSLV	55	1986	155WTALA	155	1990	80378	45	1966-69	65304511	45	1965	
55RSYB	55	1989	155WTALY	155	1989	80382	45	1966-69	65304520	45	1965	
55RSYF	55	1984	155WTLCD-155WTXCD	155	1986	80386	45	1966-67	65304521	45	1965	
55RSYH	55	1988	155WTLCO-155WTXCO	155	1985	80450	75	1966-68	65304530	45	1965	
55RSYN	55	1983	155WTLCR-155WTXCR	155	1984	80454	75	1966-68	65304531	45	1965	
55RSYP	55	1987	155WTLCU-155WTXCU	155	1987	80914	28	1966-67	65304540	45	1965	
55RSYQ	55	1985	155WTLCS-155WTXCS	155	1990	80915	28	1966-67	65304541	45	1965	
55RSYT	55	1990	155WTLM-155WTXM	155	1988	80916	45	1966-67	65307530	75	1965	
55RSYV	55	1986	155WTLZ-155WTLZX	155	1989	81605	7.5	1968	65307531	75	1965	
55RWCR-55RWLCR	55	1984	155WTPLA-155WTPXA	155	1990	81635	7.5	1969	65307540	75	1965	
55RWLCD	55	1986	155WTPLB-155WTPXB	155	1987	81660	9	1967-69	661301210-20	14	1961	
55RWLCO	55	1985	155WTPLH-155WTPXH	155	1986	81680	9	1967-69	Mercury Outboard			
55RWLCU	55	1987	155WTPLP-155WTPXP	155	1985	81700	9	1967-69				
55RWLE	55	1989	155WTPLT-155WTPXT	155	1988	81710	4	1966-68	HP	CYL	BEG. S/N	YEAR
55RWLES	55	1990	155WTPLV-155WTPXV	155	1984	6530310	3.5	1965	2.2	1	8075603	1984
55RWLR	55	1988	155WTPLY-155WTPXY	155	1989	6530710	7.5	1965	2.2	1	8087123	1985
65RELCR	65	1984	200WTPLV-200WTPXV	200	1990	6530720	7.5	1965	2.2	1	A800761	1986
65RSLA-65RSYA	65	1990	6834B	6	1978	6530750	7.5	1965	2.2	1	A805221	1987
65RSLB-65RSYB	65	1987	6835B	6	1978	6530760	7.5	1965	2.2	1	A817421	1988
65RSLH	65	1986	6912S	6	1979	10700305C	4	1969	2.2	1	A837101	1989
65RSLP-65RSYP	65	1985	6913S	6	1979	10700325D	7.5	1969	2.2	1	A855097	1990
65RSLT-65RSYT	65	1988	6934E	6	1979	10700395D	7.5	1969	3	1	A855097	1990
65RSLV-65RSYV	65	1984	6935E	6	1979	10800305C	4	1969	3.4 L	6	6436883	1984
65RSLY-65RSYY	65	1989	9800S	9	1978	10800395D	7.5	1969	3.4 L	6	A129445	1985
65RWLCD	65	1986	9802S	9	1978	61300310	3.6	1961	3.4 L	6	A912426	1986
65RWLCO	65	1985	9803S	9	1978	61300610-710	7.5	1961	3.5	1	6202173	1983
65RWLCR	65	1984	9900R	9	1979	61302510-20	27	1961	3.5	1	6434771	1984
65TELCD	65	1986	9901S	9	1979	61302530-40	27	1961	3.5	1	6594744	1985
65TELCO	65	1985	9902C-R	9	1979	61304010-11	43	1961	3.6	1	5404657	1980-81
65WMLA-65WMYA	65	1990	9903C-R	9	1979	61304020-21	43	1961	3.6	1	5910968	1982
65WMLB-65WMYB	65	1987	9912S	9	1979	61304030-31	43	1961	3.9	1	1655013	1964
65WMLCD	65	1986	9913S	9	1979	61304040-41	43	1961	3.9	1	1738941	1965
65WMLCO	65	1985	12800S	12	1978	61304050-51	43	1961	3.9	1	1865633	1966
65WMLCU	65	1987	12802S	12	1978	61304050-51	43	1961	3.9	1	2098037	1967
65WMLCSM	65	1990	12803S	12	1978	61307030-40	7.5	1961	3.9	1	2278851	1968
65WMLH	65	1986	12900R	12	1979	61307050-70	7.5	1961	4	1	2498136	1969
65WMLM	65	1988	12902C-R	12	1979	61307080-90	7.5	1961	4	1	2771662	1970
65WMLP-65WMPYP	65	1985	12903C-R	12	1979	62300310	3.6	1962	4	1	3028361	1971
65WMLT-65WMYT	65	1988	12910S	12	1979	62300610-710	7.5	1962	4	1	3296137	1972
65WMLY-65WMYT	65	1989	12912S	12	1979	62301410-20	14	1962	4	1	3529446	1973
65WMLZ	65	1990	12913S	12	1979	62302810-20	27	1962	4	1	3764825	1974
65WTLCO	65	1985	25832C	25	1978	62302830-40	27	1962	4	2	5589202	1980-81
65WTLCR	65	1984	25833C	25	1978	62304411-21	43	1962	4	2	9075839	1976
100TEMLH-100TEMXH	100	1986	25932R	25	1979	62304431-41	43	1962	4	2	9172806	1978
100WMLCD	100	1986	25933R	25	1979	62304450-60	43	1962	4	1	A818721	1988
100WMLCO	100	1985	40804B	40	1978	62307030-40	7.5	1962	4	1	A837101	1989
100WMLCR	100	1984	40805B	40	1978	62307530-40	7.5	1962	4	1	A855097	1990
100WMPLA	100	1990	40904E	40	1979	63104060-61	43	1961	4	1	A906702	1986
100WMPLB	100	1987	40905E	40	1979	63300311	3.5	1963	4	1	B114109	1987
100WMPLH	100	1986	50832C-G	50	1978	63300411	3.5	1963	4.5	1	4108120	1975
100WMPLP	100	1985	50833C-G	50	1978	63300711	7.5	1963	4.5	1	4377557	1976
100WMPLT	100	1988	50932R	50	1979	63300712	7.5	1963	4.5	1	4597262	1977
100WMPLV	100	1984	50933R	50	1979	63301411	14	1963	4.5	1	4869518	1978
100WMPLY	100	1989			63301412	14	1963	4.5	1	5270784	1979	
100WTLCD-100WTXCD	100	1986	McCulloch Outboard			63302811	28	1963	4.5	1	5595532	1980-81
100WTLCO	100	1985	A3BB	3.6	1960	63302821	28	1963	4.5	1	6025119	1982
100WTLCR	100	1984	A3EB	7.5	1960	63302831	28	1963	4.5	1	6232381	1983
100WTLCU-100WTXCU	100	1987	A3FB	12	1960	63302831	28	1963	4.5	1	6428076	1984
100WTLES-100WTXES	100	1990	A3GB	25	1960	63302841	28	1963	4.5	1	6608536	1985
100WTLM-100WTXM	100	1988	A3HB	40	1960	63304511	45	1963	5	1	A819951	1988
100WTLZ-100WTLZX	100	1989	A3HB	40	1960	63304521	45	1963	5	1	A837101	1989
100WTPLA	100	1990	A3KB	7.5	1960	63304531	45	1963	5	1	A855097	1990
100WTPLB	100	1987	B3GB	25	1960	63304541	45	1963	6	2	1408611	1961
100WTPLH	100	1986	B3HB	40	1960	63307531	7.5	1963	6	2	1485612	1962
100WTPLP	100	1985	C3GB	25	1960	63307541	7.5	1963	6	2	1551443	1963
100WTPLT	100	1988	C3HB	40	1960	63507541	7.5	1965	6	2	1607513	1964
100WTPLV	100	1984	C3JB	60	1960	64300310	3.5	1964	6	2	1745521	1965
100WTPLY	100	1989	D3GB	25	1960	64300710	7.5	1964	6	2	1958278	1966
125ESXES	125	1990	D3HB	40	1960	64300720	7.5	1964	6	2	2096171	1967
125ESXW	125	1989	D3JB	60	1960	64301410	14	1964	6	2	2284857	1968
125RWLC-125RWYC	125	1990	E3HB	40	1960	64301420	14	1964	6	2	A910596	1986
125RWLG-125RWXG	125	1988	F3HB	40	1960	64302810	28	1964	6	2	B114231	1987
125RWLS-125RWXS	125	1987	1410-20	14	1962	64302830	28	1964	6	2	B233200	1988
125RWLW-125RWYW	125	1989	78500	4	1966-67	64302830	28	1964	6	2	B385500	1989
125RWYG	125	1988	80000	7.5	1966-67	64304510	45	1964	7.5	2	2529895	1969
125RWYS	125	1987	80351	7.5	1966-67	64304530	45	1964	7.5	2	2810637	1970
125WTPLC-125WTPXC	125	1990				64304540	45	1964	7.5	2	3016581	1971
						64307530	7.5	1964	7.5	2	3274633	1972
						65301410	14	1965	7.5	2	3488153	1973
						65301420	14	1965	7.5	2	3801458	1974

CROSS REFERENCE — Mercury Outboard

Mercury Outboard				Mercury Outboard				Mercury Outboard				Mercury Outboard			
HP	CYL	BEG.S/N	YEAR	HP	CYL	BEG.S/N	YEAR	HP	CYL	BEG.S/N	YEAR	HP	CYL	BEG.S/N	YEAR
7.5	2	4087015	1975	25	2	6593849	1985	65	4	2119749	1967	115	6	4112635	1975
7.5	2	4314385	1976	25	2	A911346	1986	65	4	2309311	1968	115	6	4310785	1976
7.5	2	4691222	1977	25	2	B114231	1987	65	4	2503991	1969	115	6	4567952	1977
7.5	2	4851693	1978	25	2	B238464	1988	65	4	2803562	1970	115	6	4855153	1978
7.5	2	5226935	1979	25	2	B385500	1989	65	4	2997339	1971	115	6	5168574	1979
7.5	2	5524660	1980-81	25	2	C221500	1990	65	3	3293184	1972	115	6	5600967	1980-81
7.5	2	5936301	1982	35	4	1570507	1963	65	3	3547987	1973	115	6	6006834	1982
7.5	2	6239857	1983	35	2	1628795	1964	65	3	3807833	1974	115	6	6262961	1983
7.5	2	6430041	1984	35	2	1755799	1965	65	3	4136685	1975	115	6	6440183	1984
7.5	2	6611886	1985	35	2	1960827	1966	65	3	4382057	1976	115	6	6630171	1985
8	2	A197112	1986	35	2	2097800	1967	70	3	1296411	1960	115	6	A907777	1986
8	2	B114231	1987	35	2	2300972	1968	70	3	1413611	1961	115	6	B117567	1987
8	2	B233200	1988	35	2	2487558	1969	70	3	1503459	1962	115	6	B239242	1988
8	2	B385500	1989	35	2	6445653	1984	70	3	4382057	1976	115	4	C100000	1989
8	2	C221500	1990	35	2	6626696	1985	70	3	4571652	1977	115	4	C221500	1990
9.8	2	5206550	1979	35	2	A922171	1986	70	3	4825249	1978	125	6	2314956	1968
9.8	2	5541280	1980-81	35	2	B110789	1987	70	3	5128280	1979	125	6	2536210	1969
9.8	2	5965263	1982	35	2	B238644	1988	70	3	5579017	1980-81	135	6	2839369	1970
9.8	2	6263906	1983	35	2	B393190	1989	70	3	5974683	1982	135	6	3036066	1971
9.8	2	6438338	1984	35 (300)	4	1271885	1960	70	3	6279960	1983	V-135	6	A909997	1986
9.8	2	6620196	1985	40	2	2874704	1970	70	3	B110054	1987	V-135	6	B116662	1987
9.8 (100)	2	1397581	1961	40	2	3043031	1971	70	3	B240451	1988	V-135	6	B241881	1988
9.8 (110)	2	1455240	1962	40	2	3219678	1972	70	3	C100000	1989	V-135	6	C100861	1989
9.8 (110)	2	1474328	1963	40	2	3474578	1973	75	4	6432901	1984	V-135	6	C221500	1990
9.8 (110)	2	1607083	1964	40	2	3859435	1974	75	4	6613221	1985	140	6	3293234	1972
9.8 (110)	2	1742746	1965	40	2	4118385	1975	75	4	A197882	1986	140	6	4865678	1978
9.8 (110)	2	1865779	1966	40	2	4362215	1976	75	3	C100000	1989	140	6	5189788	1979
9.8 (110)	2	2098352	1967	40	2	4564002	1977	75	3	C221500	1990	140	6	5625108	1980-81
9.8 (110)	2	2290663	1968	40	2	4860103	1978	80	4	1335465	1960	150	6	3502806	1973
9.8 (110)	2	2508759	1969	40	2	5174089	1979	80	4	1398630	1961	150	6	3752620	1974
9.8 (110)	2	2798057	1970	40	2	5556230	1980-81	80	4	2559001	1969	150	6	4125985	1975
9.8 (110)	2	3002814	1971	40	2	5991215	1982	80	4	2783253	1970	150XS	6	4319880	1976
9.8 (110)	2	3263263	1972	40	2	6228285	1983	80	4	2986444	1971	150XS	6	4602012	1977
9.8 (110)	2	3482753	1973	40	4	C159200	1989	80	4	3186263	1972	150XS	6	4868648	1978
9.8 (110)	2	3795658	1974	40	4	C221500	1990	80	4	4831999	1978	V-150	6	4868998	1978
9.8 (110)	2	4079675	1975	40 350	2	1356948	1961	80	4	5141097	1979	V-150	6	5129480	1979
9.8 (110)	2	4304785	1976	45	4	1476510	1962	80	4	5582562	1980-81	V-150	6	5503247	1980-81
9.8 (110)	2	4605112	1977	45	4	A914859	1986	80	4	5987161	1982	V-150	6	5944791	1982
9.8 (110)	2	4839254	1978	45	4	B110789	1987	80	4	6232941	1983	V-150	6	6220254	1983
9.9	2	A918999	1986	45	4	B238644	1988	80	3	A966142	1987	V-150	6	6443213	1984
9.9	2	B114231	1987	45	4	B393190	1989	80	3	B240451	1988	V-150	6	6616991	1985
9.9	2	B233200	1988	45 (400)	4	1279685	1960	80	3	C100000	1989	V-150	6	A904646	1986
9.9	2	B385500	1989	45 (400)	4	1384806	1961	85	6	1460999	1963	V-150	6	B116662	1987
9.9	2	C221500	1990	50	4	1421113	1961	85	6	1648888	1964	V-150	6	B242881	1988
10	2	1290910	1960	50	4	1477910	1962	85	4	3493913	1973	V-150	6	C100861	1989
15	2	1288910	1960	50	4	1552535	1963	85	4	3865695	1974	V-150	6	C221500	1990
15	2	1346448	1961	50	4	1605952	1964	85	4	4092965	1975	V-150XR2	6	A905191	1986
15	2	B293117	1988	50	4	1755549	1965	85	4	4590512	1977	V-150XR2	6	B289430	1988
15	2	B385500	1989	50	4	1870389	1966	85XS	4	4366802	1976	V-150XR4	6	B242885	1988
15	2	C221500	1990	50	4	2097445	1967	90	6	1755444	1965	V-175	6	4301235	1976
18	2	5860332	1980-81	50	4	2305101	1968	90	6	4854301	1978	V-175	6	4563802	1977
18	2	5954911	1982	50	4	2514919	1969	90	6	5160324	1979	V-175	6	4838074	1978
18	2	6171607	1983	50	4	2736807	1970	90	6	5594657	1980-81	V-175	6	5180109	1979
18	2	6443973	1984	50	4	3009934	1971	90	6	5996390	1982	V-175	6	5488752	1980-81
18	2	6617631	1985	50	4	3235063	1972	90	6	6246856	1983	V-175	6	6618751	1985
20	2	1558310	1963	50	4	3478003	1973	90	6	6436123	1984	V-175	6	A918329	1986
20	2	1606903	1964	50	4	3816308	1974	90	6	6623151	1985	V-175	6	B116662	1987
20	2	1755849	1965	50	4	4141450	1975	90	6	A902436	1986	V-175	6	B241881	1988
20	2	1866496	1966	50	4	4357650	1976	90	3	B110054	1987	V-175	6	C100861	1989
20	2	1997990	1967	50	4	4576237	1977	90	3	B240451	1988	V-175	6	C221500	1990
20	2	2296267	1968	50	4	4962056	1978	90	3	C100000	1989	V-200	6	4839034	1978
20	2	2550065	1969	50	4	5193259	1979	90	3	C221500	1990	V-200	6	5158929	1979
20	2	2827677	1970	50	4	5531630	1980-81	90cc	2	A907702	1986	V-200	6	5464486	1980-81
20	2	2991679	1971	50	4	5949386	1982	90cc	2	B114221	1987	V-200	6	6073192	1982
20	2	3226958	1972	50	4	6275323	1983	95	6	1869776	1966	V-200	6	6203991	1983
20	2	3537531	1973	50	4	6448808	1984	95	6	2097280	1967	V-200	6	6435503	1984
20	2	3755885	1974	50	4	6586624	1985	100	6	1503332	1962	V-200	6	6625221	1985
20	2	4103290	1975	50	3	A912478	1986	100	6	1518384	1963	V-200	6	A913228	1986
20	2	4293920	1976	50	3	B110789	1987	100	6	1665002	1964	V-200	6	B116662	1987
20	2	4580036	1977	50	3	B239242	1988	100	6	1755459	1965	V-200	6	B241881	1988
20	2	4819249	1978	50	3	B396036	1989	100	6	2318586	1968	V-200	6	C100861	1989
20	2	5183393	1979	50	3	C221500	1990	100	6	2484633	1969	V-200	6	C221500	1990
20	2	5606492	1980-81	60	3	1303411	1960	100	4	B209468	1988	210cc	2	A918999	1986
20	2	A910971	1986	60	3	6428681	1984	100	4	C100000	1989	210cc	2	B114231	1987
20	2	B114231	1987	60	3	6609651	1985	100	4	C221500	1990	210cc	2	B233405	1988
20	2	B238464	1988	60	3	A197392	1986	102cc	2	A819211	1988	210cc	2	B385500	1989
20	2	B385500	1989	60	3	B110789	1987	102cc	2	A837101	1989	V-220	6	B241881	1988
20	2	C221500	1990	60	3	B239242	1988	110	6	1870204	1966	V-225	6	5615282	1980-81
22 (200)	2	1292910	1960	60	3	B396036	1989	110	6	2097385	1967	V-250	6	C139860	1989
22 (200)	2	1339948	1961	60	3	C221500	1990	115	6	2836019	1970	V-250	6	C221500	1990
25	2	1467499	1962	65	4	1542745	1963	115	6	3023086	1971	V-275	6	C139860	1989
25	2	5705532	1980-81	65	4	1606282	1964	115	6	3270480	1972	V-275	6	C221500	1990
25	2	5942041	1982	65	4	1765044	1965	115	6	3525441	1973	V-300	6	5611648	1980-81
25	2	6185159	1983	65	4	1869564	1966	115	6	3761035	1974	V-300	6	6239853	1983
25	2														

Mer cruiser Inboard/Outdrive				Mer cruiser Inboard/Outdrive			Mer cruiser Inboard/Outdrive		
Sea Ray				GM Inline 6 Cylinder (Stern Drive)			GM V8 283, 327, 305 & 350 CID (Stern Drive)		
MODEL NO.	MERC. NO.	S/N	YEAR	MODEL	S/N	YEAR	MODEL	S/N	YEAR
3.0L	3.0L	B787205-B917529	88	140	1538930-1725960	63	190	1564539-1730903	63-64
4.3L2	4.3L	B785483-B921276	88	150	1666495-2048046	64-66	898 (2bbl.)	4762210-6218461	77-82
4.3L4	4.3LX	B785981-B922330	88	160	2048022-2770031	67-69	898 (2bbl.)	6218462-B525981	83-84
5.7L	5.7L	B784799-B917017	88	165	2770032-5178958	70-78	200/5.0L (2bbl.)	6218462-F600999	85-95
SRX5.7L	350 Mag	B785241-B919012	88	165	5178959-5813433	79-81	5.0L (2bbl.)	L015751-UP	98-
SRX7.4L	454 Mag			200	2453769-2712072	69	5.0L EFI	L012052-L340000	98-99
SRX7.4L-H	Alpha	B785149-B924857	88				228 (4bbl.)	4765100-5170008	77-78
	Bravo	B721206-B919343	88				228 (4bbl.)	5170009-6218461	79-82
							228 (4bbl.)	6218462-B525981	82-84
							230 (4bbl.)	6218462-B525981	85-86
							230/5.0LX (4bbl.)	B525982-F600999	87-95
							225	1539620-2694014	63-69
							250	2314301-2639854	68-69
							255	4175500-4767999	75-76
							250	4768000-4908849	77
							260/5.7L	4908850-6218461	78-82
							260/5.7L	621462-B525981	82-86
							260/5.7L	B525982-F600999	87-95
							5.7L (2bbl.)	F601000-UP	96-98
							5.7L EFI	F225560-UP	95-
							5.7LX (4bbl.)	F601000-K999999	96-97
							5.7LX EFI	F752400-K999999	96-97
							5.7LX Bravo EFI	F800300-K999999	96-97
							350 Mag. Alpha	A635178-B525981	86-87
							350 Mag. Alpha	B525982-F600999	87-95
							350 Mag. Alpha	F601000-K001526	96
							350 Mag. Alpha	K001527-K999999	97
							350 Mag. Alpha EFI	F800300-K999999	96-97
							350 Mag. Bravo MPI	F415189-K999999	95-97
							350 Mag. MPI (GEN +)	F602000-K999999	96-97
							350 Mag. MPI (GEN+)	L010019-UP	98-
							270	2851074-3385720	69-72
							280TRS	4176250-4770199	75-76
							300 Tempest	6668677-B430367	85-86
							320 (EFI)	A543604-C622418	87-89
Stern Drives				GM V6 (Stern Drive)					
3.0L-SRX7.4L Alpha B803866-C348032 88 SRX7.4L-H Bravo B803872-B999972 88				MODEL S/N YEAR					
				185 (4bbl.) 6330183-6919655 83-84					
				185 (2bbl.) A331455-B527954 85-87					
				175/4.3L (2bbl.) B527955-D714106 87-92					
				4.3L (GEN II)(2bbl.) D714107-F000877 92-93					
				4.3L (GEN II)(2bbl.) F000878-F601126 93-95					
				4.3L (GEN II)(2bbl.) F601127-F000878 96					
				4.3LX (GEN+)(2bbl.) F803000-K999999 96-97					
				4.3L (GEN+)(2bbl.) L010044-UP 98-					
				4.3L EFI (GEN+)(TBI) L012009-UP 98-					
				205 (4bbl.) A331455-B527954 85-87					
				205/4.3LX (4bbl.) B527955-D714369 87-91					
				4.3LX (GEN II)(4bbl.) D714370-F001219 92-93					
				4.3LX (GEN II)(4bbl.) F001220-F601126 93-95					
				4.3LX (GEN II)(4bbl.) F601127-F802999 96					
				4.3LXH (GEN+)(4bbl.) F803114-UP 96-97					
				4.3LH(GEN+)(4bbl.) L010044-UP 98					
				262 Mag. (TBI)(GEN+) F803800-K999999 96-97					
Inboard Engines									
5.7L 5.7L B788204-B919356 88 7.4L 7.4L B788179-B913769 88									
Renault 4 Cylinder (Stern Drive)									
MODEL S/N YEAR									
60 1887079-2049044 65-68									
80 2049045-2851423 66-69									
90 2851424-3226957 70-72									
GM 4 Cylinder (Stern Drive)									
MODEL S/N YEAR									
110 1537370-2044033 63-66									
120 1666601-3377340 64-72									
120 3377341-3770649 72-73									
120 3770650-4952700 74-77									
120 4952701-5192048 78									
120 5192049-6229717 79-82									
120 6229718-6853913 83-84									
120 6853914-B531853 85-86									
120/2.5L B531854-C853255 87-89									
140 2508261-6229717 68-82									
140/3.0L 6229718-C856558 82-89									
3.0L/LX C856559-UP 90-									
Mercury Marine 4 Cylinder (Stern Drive)									
MODEL S/N YEAR									
470 (2bbl.) 4208730-5520114 76-79									
470 (2bbl.) 5520115-6218036 80-82									
470 (2bbl.) 6218037-6916778 83-84									
170 (2bbl.) 6916779-UP 85-86									
165/3.7L (2bbl.) 6916779-UP 87-89									
485 (2bbl.) 5685394-6218036 80-82									
488 (4bbl.) 6170297-6916778 83-84									
190 (4bbl.) 6916779-UP 85-86									
180/3.7LX (4bbl.) 6916779-UP 87-89									
Ford V8 (Stern Drive)									
MODEL S/N YEAR									
888 (2bbl.) 3108723-4887829 71-77									
215 (4bbl.) 2781153-3385720 70-72									
225 (4bbl.) 3385721-4166999 73-74									
225-S (4bbl.) 3385721-4166999 73-74									
233 4173000-4902304 75-77									
255 3258728-4175499 71-74									

Mercruiser Inboard/Outdrive			Mercruiser Inboard/Outdrive				Mercruiser Inboard/Outdrive		
GM V8 427, 454, 502, 540 & 572 (Stern Drive)			MCM 4, 5, 6 & V8 Cylinder Diesel Stern Drive Engines				GM MIE V8 427, 454, 482 & 502 CID (Inboard)		
MODEL	S/N	YEAR	MODEL	HP	S/N	YEAR	MODEL	S/N	YEAR
325	2278747-3780449	69-72	Rover	60	31400000F-UP	65-67	325	2278747-3780449	68-74
330	4623115-6083144	77-81	530 D-TA	150	B993000-B993492	89	330	4623115-5889913	77-80
330	6083145-B816450	82-87	636 D-TA	180	B993500-C696047	89	340/7.4L		
7.4L Bravo	B771113-D603117	88-91	D183	140	B993493-D725149	90-93	w/B/W MK4	5889914-UP	81-92
7.4L Bravo (Gen.V)	D603118-F800699	92-96	D219	170	C696048-D850124	90-93	7.4L w/Hurth (LH) MK4	C391564-D715493	89-92
7.4L Bravo (Gen.VI)	F800700-K999999	96-97	D254	200	C849484-D554729	90-93	7.4L (LH)	D715494-K999999	92-97
7.4LX Bravo (MPI)(Gen.V)	F602010-F801999	96	D3.0L	140	D725150-UP	94	7.4L MPI (LH)	F563052-K999999	95-97
7.4LX Bravo (MPI)(Gen.VI)	F802000-K999999	96-97	D3.6L	170	D850125-UP	94	7.4L MPI (L29) Gen VI	L002006-UP	98
7.4L MPI (Gen.VI)	L010003-UP	98	D4.2L	200	D554730-UP	94	7.4L TBI (LH) Gen VI	F874815-K999999	96-97
7.4LX Bravo (TBI)(Gen.VI)	F820000-K999999	96-97	D7.3L	238	F060000-UP	94	454 Mag. MPI Horizon	L002200-L086049	98-99
454 Mag. Alpha	A631894-UP	86-88	Mercury Marine MIE 4 Cylinder (Inboard)				454 Mag. MPI (Gen.V)	F215800-F820099	95-96
454 Mag. Bravo (Gen.V)	D805069-F304999	92-94	MODEL	S/N	YEAR	470	5520115-6218036	80-81	
454 Mag. Bravo (Gen.V)	F305000-F801699	95-96	Ford MIE V8 (Inboard)				454 Mag. MPI (SKI)(Gen.VI)	F820100-K999999	96-97
454 Mag. Bravo (Gen.VI)	F801700-K999999	96-97	MODEL	S/N	YEAR	215	2781153-3563181	70-72	
454 EFI (Gen.V)	F115700-F802349	94-96	215	2781153-3563181	70-72	225	3385721-4176999	70-72	
454 Mag. MPI (Gen.VI)	F802350-K999999	96-97	225	3385721-4176999	70-72	233	4173000-4775784	75-76	
454 Mag. MPI (Gen.VI)	L010029-L085399	98	233	4173000-4775784	75-76	255	3258728-4178299	73-74	
454 Mag. MPI (Gen.VI)	L085400-UP	99-	GM MIE V8 305,327,350 CID (Inboard)				350	9780450-4623109	74-76
370 TRS	4179554-6721527	78-85	MODEL	S/N	YEAR	390	2781129-2825059	69-70	
370 TRS	6721528-B714586	85-87	198	4762210-6218461	77	8.2L w/ Hurth	C878221-D857199	90-92	
400 TRS	4179554-B457644	80-86	228	4765100-5170008	77-78	8.2L (Gen.V)	D857200-F819619	93-96	
420	A398941-D937011	87-89	228	5170009-5907057	79-80	8.2L MPI (LH) Gen VI	F819620-K999999	96-97	
425	A398941-D937011	90-93	230/5.0L (4bbl.)	5907058-B788151	81-87	8.2L MPI (LH) Gen VI	L002450-L0086012	98	
440 TRS	4179554-B485220	83-86	225	2278647-2694014	68	8.2L MPI (LH) Gen VI	L0086013-UP	99	
450 (Gen.V)	F347100-F347277	95-96	250	2314301-2639854	68-69				
525 SC	D456000-F348963	91-92	255	4175500-5907057	75-80				
525 SC (Gen.V)	D456000-F348963	92-95	260/5.7L	5907058-F024999	81-93				
525 SC (Gen.V)	F615814-F745215	96	270	2851074-3077735	69-72				
525 SC (Gen.VI)	F745260-UP	96-97	5.7L	F025000-K999999	94-97				
390	2781129-3042731	69-70	5.7L (Gen+)	L002003-UP	98				
460 TRS	4719554-6181046	83-86	5.7L MPI	K040300-K999999	97				
465	C849992-F213244	90-92	350 Mag. MPI (Gen+)	L002008-L304499	98				
465 (Gen.V)	C849992-F213244	92-94	350 Mag. MPI (Gen+)	L304500-UP	99				
500 (Gen.V)	F213293-F745159	94-96	350 Horizon	L304700-UP	99-				
500 (Gen.VI)	F745195-L001772	97-98	5.7L Ski	A338533-B514626	85-87				
502 Mag. Bravo	C878221-D824588	90-92	5.7L Competition Ski	B514627-F775199	87-95				
502 Mag. Bravo (Gen.V)	D824589-F114528	92-93	5.7L Competition Ski	F775200-K040003	96				
502 EFI (Gen.V)	D840650-F802599	93-96	5.7L Competition Ski (Gen+)	L002005-UP	98-				
502 Mag. MPI (Gen.VI)	F802600-K999999	96-97	350 Mag. Ski	D505450-K999999	91-97				
500 EFI	L001477-UP	99-	350 Mag. EFI Ski	F215561-K999999	94-97				
502 Mag. MPI (Gen.VI)	L085433-UP	98	350 Mag. MPI Ski	F350583-F799999	95-98				
600 SC	D456489-F877642	91-92	Black Scorpion Ski	F800000-UP	96-98				
600 SC (Gen.V)	D456489-F877642	92-96							
600 SC (Gen.VI)	K000227-UP	97							
500 Bulldog	C577254-F745405	90-96							
500 Bulldog	K000248-UP	97							
575	A677429-D763716	86-92							
800 SC (Gen.V)	D763836-UP	93-96							

Mercruiser Inboard/Outdrive				Mercruiser Inboard/Outdrive			Mercruiser Inboard/Outdrive		
MIE 5, 6 & V8 Cylinder Diesel Inboard Engines				MC 120, 140, 160 & 165			MC Bravo & Blackhawk		
MODEL	HP	S/N	YEAR	MODEL	S/N	YEAR	MODEL	S/N	YEAR
530 D-TA	150	B993002-C539258	89	120/140	2062141-378049	67-73	Bravo One	B664190-UP	88-
636 D-TA	180	B993750-C696011	89	120/140	3780850-4893634	74-77	Bravo Two	C564952-UP	89-
D183	150	C539259-D725149	90-93	120/140	4893635-6225576	78-82	Bravo Three	D763691-UP	93-
D219	180	C696012-D850124	90-93	160	2065190-2763441	67-69	Blackhawk	F186717-UP	94-
D254	210	C849461-D554729	90-93	165	2763442-3780849	70-73			
D3.0L	150	D725150-UP	94-	165	3780849-4890459	74-77			
D3.6L	180	D850125-UP	94-	165	4890460-6268064	78-82			
D4.2L	210	D554730-UP	94-				MC 215E & 215H		
D7.3L	262	F060000-UP	94-				MODEL	S/N	YEAR
							215H	2782203-2909034	70
							215E	2782203-2909034	70-72
MC 60, 80 & 90 Stern Drives & Transom Plates				MC470 & 485					
MODEL		S/N	YEAR	MODEL	S/N	YEAR			
60 (O)		1830753-2063740	65-66	470	4208730-4893834	76-77			
80		2063741-2898029	66-69	470	4893835-6225576	78-82			
90		2898020-3225967	70-72	485	5487437-6225576	80-82			
							MC TR & TRS		
							MODEL	S/N	YEAR
							TR	3377316-3787239	73
							TR	3787240-4794899	74-76
							TR	4794900-5009866	77
							TR	5009867-UP	78-
							TRS	3787240-4203749	74-75
							TRS	4203750-4795399	76
							TRS	4795400-UP	77-
							MC II, III & III		
MODEL		S/N	YEAR						
I		1534570-1684187	63						
II (1.33:1)		1474909-2278488	62-67						
II (1.78:1)		2398798-2671321	68-69						
III		2373127-3002613	68-72						
III		5128065-UP	78-						
							MC 888, 225S & 233		
							MODEL	S/N	YEAR
							888	3106717-3784374	71-73
							888	3784375-4782329	74-77
							225S	3856268-4200499	74
							233	4200500-4782329	75-77
							MC 898, 228, 250 & 260		
							MODEL	S/N	YEAR
							898/228	4782330-4898729	77
							898/228	4898730-6229157	78-82
							250	4791300-4898729	77
							260	4898730-6229157	78-82
							MC II, III, IV & V SSM		
							MODEL	S/N	YEAR
							II SSM	Z2021100C-Z2021313C	82-84
								A544504Z-C576702Z	85-90
							III SSM	Z38022378C-X38092085C	78-84
								A568120-UP	86-
							IV SSM	A568120-UP	86-
							V SSM	C576812-UP	89-
							VI SSM	D456231-UP	91-
							MC 1A, 1B & 1C		
MODEL		S/N	YEAR						
1A, 1B & 1C		1684188-1777798	64						
1A, 1B & 1C (E-Z Shift)		1776349-2065189	65-66						
							MC R, MR, Alpha One, Alpha One SS & Alpha One Gen II		
							MODEL	S/N	YEAR
							R	6152230-6847029	83-84
							MR	6810538-A479506	85
							Alpha One	A470165-UP	86-90
							Alpha One SS	A545004-UP	86-89
							Alpha One Gen II	D469859-UP	91-

2014 Phase-Out Items

Items listed below are currently on phase-out status. Phase-out items have limited quantity. Once the stock is depleted, the product will become obsolete.

95003	Setscrew, S/S Allen - Marine/Vehicle Light	16-205-12004	12" Marine Exh/Wtr Plus 12 1/2' Lgth.
95006	Hardware Mounting Kit, Marine/Vehicle Lt.	16-205-1340	1 3/4" Marine Exh/Wtr Plus 50' Coil
95010	Light Kit, 12V Black	16-205-1341	1 3/4" Marine Exh/Wtr Plus 6.25' Lgth.
95018	Docking Light Set, 28V-Blk-I W/ Switch Kit	16-205-1343	1 3/4" Marine Exh/Wtr Plus 10' Lgth.
99006	Skeggard	16-205-1344	1 3/4" Marine Exh/Wtr Plus 12 1/2' Lgth.
99010	Skeggard	16-205-1380	1 3/8" Marine Exh/Wtr Plus 50' Coil
99014	Skeggard	16-205-1381	1 3/8" Marine Exh/Wtr Plus 6.25' Lgth.
99019	Skeggard	16-205-1383	1 3/8" Marine Exh/Wtr Plus 10' Lgth.
99023	Skeggard	16-205-1384	1 3/8" Marine Exh/Wtr Plus 12 1/2' Lgth.
99025	Skeggard	16-205-1580	1 5/8" Marine Exh/Wtr Plus 50' Coil
99026	Skeggard	16-205-1581	1 5/8" Marine Exh/Wtr Plus 6.25' Lgth.
99027	Skeggard	16-205-1583	1 5/8" Marine Exh/Wtr Plus 10' Lgth.
99029	Skeggard	16-205-1584	1 5/8" Marine Exh/Wtr Plus 12 1/2' Lgth.
99030	Skeggard	16-205-1780	1 7/8" Marine Exh/Wtr Plus 50' Coil
99031	Skeggard	16-205-1781	1 7/8" Marine Exh/Wtr Plus 6.25' Lgth.
1504877	Eng. Synch Module, Diesel Alternator	16-205-1783	1 7/8" Marine Exh/Wtr Plus 10' Lgth.
1507574	Eng. Synch Module, Diesel Mag. P.u., 159 Teeth	16-205-1784	1 7/8" Marine Exh/Wtr Plus 12 1/2' Lgth.
13372P	Press, O/B Water Kit, 60 Psi, Red International, 2"	16-205-2000	2" Marine Exh/Wtr Plus 50' Coil
13521P	Speedo Kit, 35 Mph, Red International, 3"	16-205-2001	2" Marine Exh/Wtr Plus 6.25' Lgth.
13521Ph	Speedo Head Only, 35 Mph, Red International, 3"	16-205-2003	2" Marine Exh/Wtr Plus 10' Lgth.
13746P	Trim, Honda, Red International, 2"	16-205-2004	2" Marine Exh/Wtr Plus 12 1/2' Lgth.
16-131-0120	1/2" Silicone Heater Hose - 250' Reels	16-205-2381	2 3/8" Marine Exh/Wtr Plus 6.25' Lgth.
16-131-0125	1/2" Silicone Heater Hose - 25' R/O Ctn.	16-205-3001	3" Marine Exh/Wtr Plus 6.25' Lgth.
16-131-0126	1/2" Silicone Heater Hose - 50' R/O Ctn.	16-205-3004	3" Marine Exh/Wtr Plus 12 1/2' Lgth.
16-131-0145	1/4" Silicone Heater Hose - 25' R/O Ctn.	16-205-3120	3 1/2" Marine Exh/Wtr Plus 50' Coil
16-131-0345	3/4" Silicone Heater Hose - 25' R/O Ctn.	16-205-3121	3 1/2" Marine Exh/Wtr Plus 6.25' Lgth.
16-135-0140B	1/4" #1350 Water Hose 500 Reel Blk.	16-205-3123	3 1/2" Marine Exh/Wtr Plus 10' Lgth.
16-135-0380B	3/8" #1350 Water Hose 500' Reel Blk.	16-205-3124	3 1/2" Marine Exh/Wtr Plus 12 1/2' Lgth.
16-142-0340	3/4" Shields Vac Cuffs 100 Pcs/Ctn.	16-205-5000	5" Marine Exh/Wtr Plus 50' Coil
16-142-1000	1" Shields Vac Cuffs 100 Pcs/Ctn.	16-205-5001	5" Marine Exh/Wtr Plus 6.25' Lgth.
16-145-1123	1 1/2" Shields Vac W/Fda Liner 10' Polypac	16-205-5003	5" Marine Exh/Wtr Plus 10' Lgth.
16-150-0367	3/16" Pvc Tubing - Clear 100' R/O Ctn.	16-205-6001	6" Marine Exh/Wtr Plus 6.25' Lgth.
16-150-0387	3/8" Pvc Tubing - Clear 100' R/O Ctn.	16-205-6004	6" Marine Exh/Wtr Plus 12 1/2' Lgth.
16-150-1185	1 1/8" Pvc Tubing - Clear 25' Polypac	16-205-8004	8" Marine Exh/Wtr Plus 12 1/2' Lgth.
16-164-0386	3/8" Wht. Reinf Pvc W/Blue Tracer 50' R/O Ctn.	16-250-3144	3 1/4" Shieldsflex li Water/Exhaust 12 1/2' Lgth.
16-200-1343	1 3/4" Marine Exhaust/Water 10' Lgth.	16-250-4123	4 1/2" Shieldsflex li Water/Exhaust 10' Lgth.
16-200-1383	1 3/8" Marine Exhaust/Water 10' Lgth.	16-250-4184	4 1/8" Shieldsflex li Water/Exhaust 12 1/2' Lgth.
16-200-1563	1 5/16" Marine Exhaust/Water 10' Lgth.	16-250-5124	5 1/2" Shieldsflex li Water/Exhaust 12 1/2' Lgth.
16-200-1583	1 5/8" Marine Exhaust/Water 10' Lgth.	16-250-5184	5 1/8" Shieldsflex li Water/Exhaust 12 1/2' Lgth.
16-200-2340	2 3/4" Marine Exhaust/Water 50' Coil	16-252-2180	2 1/8" Shields Exhaust - Corr. 50' Coil
16-200-2580	2 5/8" Marine Exhaust/Water 50' Coil	16-255-0583	5/8" Shieldsflex Ultra Water/Exhaust 10' Lgth.
16-200-4120	4 1/2" Marine Exhaust/Water 50' Coil	16-255-1003	1" Shieldsflex Ultra Water/Exhaust 10' Lgth.
16-200-4181	4 1/8" Marine Exhaust/Water 6 1/4' Lgth.	16-255-1124	1 1/2" Shieldsflex Ultra Water/Exhaust 12 1/2' Lgth.
16-200-4184	4 1/8" Marine Exhaust/Water 12 1/2' Lgth.	16-255-1144	1 1/4" Shieldsflex Ultra Water/Exhaust 12 1/2' Lgth.
16-200-6584	6 5/8" Marine Exhaust/Water 12 1/2' Lgth.	16-255-1184	1 1/8" Shieldsflex Ultra Water/Exhaust 12 1/2' Lgth.
16-202-1184	1 1/8" Silicone Water/Exhaust 12' Lgth.	16-255-1340	1 3/4" Shieldsflex Ultra Water/Exhaust 50' Coil
16-202-1344	1 3/4" Silicone Water/Exhaust 12' Lgth.	16-255-1341	1 3/4" Shieldsflex Ultra Water/Exhaust 6 1/4' Lgth.
16-202-1384	1 3/8" Silicone Water/Exhaust 12' Lgth.	16-255-1343	1 3/4" Shieldsflex Ultra Water/Exhaust 10' Lgth.
16-202-1784	1 7/8" Silicone Water/Exhaust 12' Lgth.	16-255-1344	1 3/4" Shieldsflex Ultra Water/Exhaust 12 1/2' Lgth.
16-202-2344	2 3/4" Silicone Water/Exhaust 12' Lgth.	16-255-1380	1 3/8" Shieldsflex Ultra Water/Exhaust 50' Coil
16-202-2784	2 7/8" Silicone Water/Exhaust 12' Lgth.	16-255-1381	1 3/8" Shieldsflex Ultra Water/Exhaust 6 1/4' Lgth.
16-202-5121	5 1/2" Silicone Water/Exhaust 6' Lgth.	16-255-1383	1 3/8" Shieldsflex Ultra Water/Exhaust 10' Lgth.
16-205-0340	3/4" Marine Exh/Wtr Plus 50' Coil	16-255-1384	1 3/8" Shieldsflex Ultra Water/Exhaust 12 1/2' Lgth.
16-205-0341	3/4" Marine Exh/Wtr Plus 6.25' Lgth.	16-255-2001	2" Shieldsflex Ultra Water/Exhaust 6 1/4' Lgth.
16-205-0343	3/4" Marine Exh/Wtr Plus 10' Lgth.	16-257-1120	1 1/2" Shields Exhaust Ultra C 50' Coil
16-205-0344	3/4" Marine Exh/Wtr Plus 12 1/2' Lgth.	16-257-1121	1 1/2" Shields Exhaust Ultra C 6 1/4' Lgth.
16-205-0783	7/8" Marine Exh/Wtr Plus 10' Lgth.	16-257-1123	1 1/2" Shields Exhaust Ultra C 10' Lgth.
16-205-0784	7/8" Marine Exh/Wtr Plus 12 1/2' Lgth.	16-257-1124	1 1/2" Shields Exhaust Ultra C 12 1/2' Lgth.
16-205-1000	1" Marine Exh/Wtr Plus 50' Coil	16-257-1340	1 3/4" Shields Exhaust Ultra C 50' Coil
16-205-10004	10" Marine Exh/Wtr Plus 12 1/2' Lgth.	16-257-1341	1 3/4" Shields Exhaust Ultra C 6 1/4' Lgth.
16-205-1001	1" Marine Exh/Wtr Plus 6.25' Lgth.	16-257-1343	1 3/4" Shields Exhaust Ultra C 10' Lgth.
16-205-1003	1" Marine Exh/Wtr Plus 10' Lgth.	16-257-1344	1 3/4" Shields Exhaust Ultra C 12 1/2' Lgth.
16-205-1004	1" Marine Exh/Wtr Plus 12 1/2' Lgth.	16-257-1580	1 5/8" Shields Exhaust Ultra C 50' Coil
16-205-1120	1 1/2" Marine Exh/Wtr Plus 50' Coil	16-257-1581	1 5/8" Shields Exhaust Ultra C 6 1/4' Lgth.
16-205-1121	1 1/2" Marine Exh/Wtr Plus 6.25' Lgth.	16-257-1583	1 5/8" Shields Exhaust Ultra C 10' Lgth.
16-205-1123	1 1/2" Marine Exh/Wtr Plus 10' Lgth.	16-257-1584	1 5/8" Shields Exhaust Ultra C 12 1/2' Lgth.
16-205-1124	1 1/2" Marine Exh/Wtr Plus 12 1/2' Lgth.	16-257-1780	1 7/8" Shields Exhaust Ultra C 50' Coil
16-205-1140	1 1/4" Marine Exh/Wtr Plus 50' Coil	16-257-1781	1 7/8" Shields Exhaust Ultra C 6 1/4' Lgth.
16-205-1141	1 1/4" Marine Exh/Wtr Plus 6.25' Lgth.	16-257-1783	1 7/8" Shields Exhaust Ultra C 10' Lgth.
16-205-1143	1 1/4" Marine Exh/Wtr Plus 10' Lgth.	16-257-1784	1 7/8" Shields Exhaust Ultra C 12 1/2' Lgth.
16-205-1144	1 1/4" Marine Exh/Wtr Plus 12 1/2' Lgth.	16-257-2004	2" Shields Exhaust Ultra C 12 1/2' Lgth.
16-205-1184	1 1/8" Marine Exh/Wtr Plus 12 1/2' Lgth.	16-257-2120	2 1/2" Shields Exhaust Ultra C 50' Coil

16-257-2121	2 1/2" Shields Exhaust Ultra C 6 1/4' Lgth.	18-1279	Stainless Steel Screw
16-257-2123	2 1/2" Shields Exhaust Ultra C 10' Lgth.	18-1281	Stainless Steel Screw
16-257-2124	2 1/2" Shields Exhaust Ultra C 12 1/2' Lgth.	18-1283	Molded Intake Port Gasket
16-257-2380	2 3/8" Shields Exhaust Ultra C 50' Coil	18-1284	Molded Intake Port Gasket
16-257-2381	2 3/8" Shields Exhaust Ultra C 6 1/4' Lgth.	18-1289	Reverse Gear
16-257-2383	2 3/8" Shields Exhaust Ultra C 10' Lgth.	18-1314	Main Bearing
16-257-2384	2 3/8" Shields Exhaust Ultra C 12 1/2' Lgth.	18-1320	Main Bearing
16-257-2780	2 7/8" Shields Exhaust Ultra C 50' Coil	18-1340	Cam Bearings
16-257-2784	2 7/8" Shields Exhaust Ultra C 12 1/2' Lgth.	18-1347	Main Bearing
16-257-3000	3" Shields Exhaust Ultra C 50' Coil	18-1349	Ball Bearing
16-257-3001	3" Shields Exhaust Ultra C 6 1/4' Lgth.	18-1397	Ball Bearing
16-257-3004	3" Shields Exhaust Ultra C 12 1/2' Lgth.	18-1399	Ball Bearing
16-257-3120	3 1/2" Shields Exhaust Ultra C 50' Coil	18-15106	V-Belt
16-257-3124	3 1/2" Shields Exhaust Ultra C 12 1/2' Lgth.	18-15107	Serpentine Belt
16-257-3180	3 1/8" Shields Exhaust Ultra C 50' Coil	18-15108	V-Belt
16-257-3181	3 1/8" Shields Exhaust Ultra C 6 1/4' Lgth.	18-15109	V-Belt
16-257-3184	3 1/8" Shields Exhaust Ultra C 12 1/2' Lgth.	18-15110	V-Belt
16-257-4004	4" Shields Exhaust Ultra C 12 1/2' Lgth.	18-15113	Serpentine Belt
16-257-5000	5" Shields Exhaust Ultra C 50' Coil	18-15117	Serpentine Belt
16-257-5001	5" Shields Exhaust Ultra C 6 1/4' Lgth.	18-15120	Serpentine Belt
16-257-5003	5" Shields Exhaust Ultra C 10' Lgth.	18-15124	Serpentine Belt
16-257-5004	5" Shields Exhaust Ultra C 12 1/2' Lgth.	18-15525	V-Belt
16-257-6000	6" Shields Exhaust Ultra C 50' Coil	18-1704	Screw
16-257-6004	6" Shields Exhaust Ultra C 12 1/2' Lgth.	18-1712	Bearing Retainer
16-257-8004	8" Shields Exhaust Ultra C 12 1/2' Lgth.	18-1726	Washer
16-262-2180	2 1/8" Corr. Silicone Water/Exhaust 50' Coil	18-1750	Complete Bearing Housing
16-262-2580	2 5/8" Corr. Silicone Water/Exhaust 50' Coil	18-17570	V-Belt
16-314-0380	3/8" Type B1 Fuel Line 250' Coil	18-1801	Ignition Switch
16-315-0383	3/8" Silverado 2000 10' Polypac	18-1964	Manifold
16-360-0125	1/2" Fire - Acol 25' R/O Ctn.	18-2087	Oil Seal
16-360-0143	1/4" Fire - Acol 10' Polypac	18-2088	Oil Seal
16-450-7000	7" Fibervent Blower Duct 25' Lgth.	18-2091	Oil Seal
18-0194	Thrust Washer	18-2325	Upper Drive Shaft Assembly
18-0196	Thrust Washer	18-2328	Upper Drive Shaft Assembly
18-0208	Shim	18-2402	Lower Gear Housing
18-0210	Shim	18-2437	Power Trim Hose
18-0212	Shim	18-2438	Power Trim Hose
18-0214	Shim	18-2518	Circulation Pump Gasket
18-0218	Shim	18-2518-9	Circulation Pump Gasket (Priced Per Pkg Of 2)
18-0222	Shim	18-2531	Clamp Ring
18-0224	Shim	18-2730-9	Grommet (Priced Per Pkg Of 2)
18-0226	Shim	18-2731	Grommet
18-0242	Valve Seat Gasket	18-2737	Reed Block Gasket
18-0246	Carb To Airbox Gasket	18-2780-1	Bellow
18-0247	Exhaust Cover Gasket	18-2780-1	Exhaust Hose
18-0308	Drain Cover To Manifold Gasket	18-2910	Fuel Pump Gasket
18-0363	Carb Flange Gasket	18-2910-9	Fuel Pump Gasket (Priced Per Pkg Of 2)
18-0380	Thermostat Gasket	18-2974	Distributor Gasket
18-0422	Distributor Cap Gasket	18-2975	Carb Gasket
18-05002	Seloc On-Line .P.p.u.	18-2975-9	Carb Gasket (Priced Per Pkg Of 2)
18-05501	Seloc Pro-Pay	18-3154	Water Coupling Assembly
18-05502	Seloc Pro-Pay	18-3167	Seal Ring Kit
18-05503	Seloc Pro-Pay	18-3233	Manifold Stud
18-05504	Seloc Pro-9 Month	18-3352	Wear Plate
18-0588	Oil Seal	18-3750	Spanner Nut
18-0608	Oil Pan Gasket Set	18-3765	Housing Pin
18-0624	Attenuator Gasket	18-3795	Prop Spacer
18-0628	Cover Gasket	18-3798	Prop Spacer
18-0740	Throttle Body Gasket	18-3799	Prop Spacer
18-0769	Float Chamber Gasket	18-3859	Head Gasket
18-0863	Cylinder Drain Cover Gasket	18-3897	Head Gasket
18-0884-9	Water Cover Gasket (Priced Per Pkg Of 2)	18-3940	Piston Rings
18-0898	Oil Pump Mounting Gasket	18-3947	Piston Rings
18-0914-9	Thermostat Cover Gasket (Priced Per Pkg Of 2)	18-3950	Piston Rings
18-09200	Seloc Manual	18-3961	Piston Rings
18-1111	Reverse Gear Bearing	18-3962	Piston Rings
18-1120	Pinion Bearing	18-3974	Piston Rings
18-1126	Tapered Roller Bearing	18-3977	Piston Rings
18-1137	Main Bearing	18-3978	Piston Rings
18-1163	Tapered Roller Bearing	18-3981	Piston Rings
18-1180	Needle Bearing	18-3984	Piston Rings
18-1183	Needle Bearing	18-3985	Piston Rings
18-1189	Thrust Bearing	18-3986	Piston Rings
18-1192	Center Main Bearing	18-3992	Piston Rings
18-1228	Exhaust Manifold Gasket	18-3999	Piston Rings
18-1230	Timing Cover Seal	18-4000	Piston Rings
18-1235	Oil Pan Gasket	18-4014	Piston Kit

18-4020	Piston Rings	52320S009	Sndr, Temp, Sgl Sta, 100-240F, 3/8" Npt
18-4021	Piston Rings	52776P	Accessory, Drive Tang - .104 Square
18-4051	Piston Rings	53210P	Speedo Kit, 60 Mph, Red International, 3"
18-4052	Piston Rings	53210Ph	Speedo Head Only, 60 Mph, Red International, 3"
18-4087	Piston Kit	53211P	Speedo Kit, 80 Mph, Red International, 3"
18-4089	Piston Rings	53211Ph	Speedo Head Only, 80 Mph, Red International, 3"
18-4090	Piston Rings	53214P	Press, Elec, Oil, 0-80 Psi, Red International, 2"
18-4096	Piston Kit	53260P	Eng Synch 2" Gauge Only (Requires Module) Red International, 2"
18-4131	Piston Kit	53453P	Press, O/B Water Kit, 15 Psi, Red International, 2"
18-4133	Piston Kit	53721P	Trim, J/E O/B, Red International, 2"
18-4136	Piston Kit	53930P	Ammeter, 60-0-60 Direct, Red International, 2"
18-4144	Piston Kit	54125P	Shunt, 100-0-100
18-4145	Piston Kit	56246P	Shunt, 60-0-60
18-4156	Piston Kit	56928P	Speedo Kit, 80 Mph, Vector, 3"
18-4165	Piston Kit	56928Ph	Speedo Head Only, 80 Mph, Vector, 3"
18-4169	Piston Kit	56929P	Speedo Kit, 60 Mph, Vector, 3"
18-4181	Piston Kit	56929Ph	Speedo Head Only, 60 Mph, Vector, 3"
18-4197	Crankshaft	56931P	Voltmeter, 8-18, Vector, 2"
18-4242	Bolt	56935P	Trim, Merc And Cobra, Vector, 2"
18-4277	Stainless Steel Bolt	56964P	Speedo Kit, 35 Mph, Vector, 3"
18-4287	Wrist Pin	56964Ph	Speedo Head Only, 35 Mph, Vector, 3"
18-4338	Powerhead Gasket Set	57646P	Temp, Elec, O/B Kit, Universal, Vector, 2"
18-4410	Powerhead Gasket Set	57649P	Tach/Hr, El O/B Alt & 4-Cycle Gas, 6K, Vector, 3"
18-4565	Piston Kit	59608P	Trim Gauge, Yamaha O/B, Vector, 2"
18-4580	Piston Kit	59609P	Trim Gauge, Yamaha O/B, Red International, 2"
18-4639	Piston Kit	61166P	Clock, Sahara, 2"
18-4640	Piston Kit	61870P	Water Pressure Kit O/B, Sahara 2In, 30 Psi
18-4641	Piston Kit	65482P	4 Gauge Set, Red International
18-4642	Piston Kit	65483P	4 Gauge Set, Vector
18-4643	Piston Kit	65484P	4 Gauge Set, Sportsman
18-4644	Piston Kit	65487P	6 Gauge Set, Vector
18-4842	Complete Lower Unit Assembly	67130P	Voltmeter, 8-18, Sportsman, 2"
18-500-3812	3/8" X 1/2" Brass Fitting Male Pipe	67150P	Fuel Gauge, Sportsman, 2"
18-502-3834	3/8" X 3/4" 45 Deg Fem Swivel Brass F	67180P	Press, Elec, Oil, 0-80 Psi, Sportsman, 2"
18-5394	Distributor Cap	67281P	Dual Hourmeter - Lcd
18-5493	Ignition Pickup Coil Assembly	67346P	Fuel, Heavy Duty Nylon 2" 24 Volt
18-5661	Drive Plate	67511P	Speedo Kit, 80 Mph, Sportsman, 3"
18-5916	Reman Starter	67511Ph	Speedo Head Only, 80 Mph, Sportsman, 3"
18-5976	Alternator	67513P	Speedo Kit, 65 Mph, Sportsman, 3"
18-5978	Alternator Bracket	67513Ph	Speedo Head Only, 65 Mph, Sportsman, 3"
18-6034A	Anode, Aluminum	67521P	Speedo Kit, 35 Mph, Sportsman, 3"
18-6040	Anode	67521Ph	Speedo Head Only, 35 Mph, Sportsman, 3"
18-6063	Anode	67590P	Temp, Elec, Water, 120-240, Sportsman, 2"
18-6108	Anode	67625P	Temp, El, O/B Kit (All W/Elect. Start), Sportsman, 2"
18-6109	Anode	67740P	Trim, J/E O/B, Sportsman, 2"
18-6264	Relay	67744P	Trim Gauge, Yamaha O/B, Sportsman, 2"
18-6265	Alternator	67746P	Trim, Honda, Sportsman, 2"
18-6284	Alternator	Cb41200b	Circuit Breaker
18-7147-9	O-Ring (Priced Per Pkg Of 5)	Cb41220b	Circuit Breaker
18-7148-9	O-Ring (Priced Per Pkg Of 5)	Cb41230b	Circuit Breaker
18-7179	O-Ring	Cb4123b	Circuit Breaker
18-7195	O-Ring	Cb42100	Circuit Breaker
18-725-2000	Constant Tension Clamp	Cb42102	Circuit Breaker
18-725-3120	Constant Tension Clamp	Cb42110	Circuit Breaker
18-725-4000	Constant Tension Clamp	Cb42112	Circuit Breaker
18-7318	Stainless Steel Clamp	Cb42120	Circuit Breaker
18-7410	O-Ring	Cb42122	Circuit Breaker
18-7435	O-Ring	Cb42130	Circuit Breaker
18-7439-9	O-Ring (Priced Per Pkg Of 2)	Cb42132	Circuit Breaker
18-7472	O-Ring	Cb42140	Circuit Breaker
18-7490	O-Ring	Cb42142	Circuit Breaker
18-7599	Fuel Lock	Ec06110	Clips
18-7874	Oil Filter	Ec06112	Clips
18-7894	Oil Drain Kit	Fs40500	Fuse Block
18-8207	Seal & Bearing Kit	Fs40540	Fuse Block
18-8316	Oil Seal	Fs40700	Junction Block
18-8545	Exhaust Manifold Mounting Kit	Fs40710	Junction Block
18-9022-1	Fast Orange Hand Cleaner - 15 Oz	Fs40712	Junction Block
18-9032	Greaseless Lubricant	Fs79010	Fuse
18-9066	Threadlocker, Blue	Fs79020	Fuse
18-9067	Threadlocker, Red	Fs79030	Fuse
18-9805	Puller Washer	Fs79040	Fuse
18-99065	Gasket	Fs79230	Fuse
1838575P	Accessory, Bulb & Socket Kit, 24 Volt	Fs79240	Fuse
50446-002P	Accessory, Dropping Resistor, 24-12 V, Trims		
52320S002	Sndr, Temp, Sgl Sta, 140-320F, 1/2" Npt		
52320S005	Sndr, Temp, Sgl Sta, 100-280F, 1/2" Npt		

Fs79300	Fuse	Rk19512r	Rocker Switch
Fs79310	Fuse	Rk19520ac	Rocker Switch
Fs79330	Fuse	Rk19520ag	Rocker Switch
Fs79340	Fuse	Rk19520gc	Rocker Switch
Fs79380	Fuse	Rk19520rc	Rocker Switch
Fs79390	Fuse	Rk19522ac	Rocker Switch
Fs79800	Fuse	Rk19522ag	Rocker Switch
Fs79810	Fuse	Rk19522gc	Rocker Switch
Fs79830	Fuse	Rk19522rc	Rocker Switch
Fs79832	Fuse	Rk19530ac	Rocker Switch
Fs79850	Fuse	Rk19530ag	Rocker Switch
Fs79852	Fuse	Rk19530gc	Rocker Switch
Fs79890	Fuse	Rk19530rc	Rocker Switch
Fs79892	Fuse	Rk19532ac	Rocker Switch
Fs79900	Fuse	Rk19532ag	Rocker Switch
Fs79902	Fuse	Rk19532gc	Rocker Switch
Fs79910	Fuse	Rk19532rc	Rocker Switch
Fs79912	Fuse	Rk19650	Rocker Switch
Fs79920	Fuse	Rk19652	Rocker Switch
Fs79930	Fuse	Rk19660	Rocker Switch
Fs79940	Fuse	Rk19662	Rocker Switch
Fs79942	Fuse	Rk21920	Rocker Switch
Fs79950	Fuse	Rk21922	Rocker Switch
Fs79952	Fuse	Rk22070	Rocker Switch Panel
Fs80020	Fuse	Rk22072	Rocker Switch Panel
Mb10463	Bracket	Tc43362	Connector
Mc45110	Knob	Tc43364	Connector
Mp35660	Light	Tc43932	Connector
Mp35662	Light	Tc43934	Connector
Mp39370	Push Button Switch	Tc43954	Connector
Mp39372	Push Button Switch	Tc44514	Connector
Mp39700	Ignition Switch	Tc44564	Connector
Mp39702	Ignition Switch	Tc44804	Connector
Mp39710	Ignition Switch	Tc44914	Connector
Mp39712	Ignition Switch	Tc44974	Connector
Mp39720	Ignition Switch	Tg21000	Toggle Switch
Mp39722	Ignition Switch	Tg21002	Toggle Switch
Mp39740	Ignition Switch	Tg21030-1	Toggle Switch
Mp41092	Ignition Switch	Tg21032-1	Toggle Switch
Mp49510	Latch	Tg21160	Toggle Switch
Mp49512	Latch	Tg21162	Toggle Switch
Mp49520	Plate	Wh10200	Connector
Mp49522	Plate		
Mp59062	Switch, Rotary		
Mp59112	Switch, Rotary		
Mp78740	Rotary Switch		
Mp78750	Rotary Switch		
Mp78752	Rotary Switch		
Mp78760	Rotary Switch		
Mp78762	Rotary Switch		
Mp78780	Rotary Switch		
Mp78790	Rotary Switch		
Mp78792	Rotary Switch		
Op24331	Oil Pressure Sender		
Pd49600	Brass Padlock, 1"		
Pd49602	Brass Padlock, 1"		
Pd49620	Brass Padlock, 1"		
Pd49622	Brass Padlock, 1"		
Pd49650	Brass Padlock, 2" (Priced Per Pkg Of 2)		
Pd49652	Brass Padlock, 2" (Priced Per Pkg Of 2)		
Pd49670	Brass Padlock (Three)		
Pd49680	Brass Padlock, 1"		
Pd49682	Brass Padlock, 1"		
Rk19500a	Rocker Switch		
Rk19500c	Rocker Switch		
Rk19500g	Rocker Switch		
Rk19500r	Rocker Switch		
Rk19502a	Rocker Switch		
Rk19502c	Rocker Switch		
Rk19502g	Rocker Switch		
Rk19502r	Rocker Switch		
Rk19510a	Rocker Switch		
Rk19510c	Rocker Switch		
Rk19510g	Rocker Switch		
Rk19510r	Rocker Switch		
Rk19512a	Rocker Switch		
Rk19512g	Rocker Switch		

ARCO		ARCO (Cont.)		ARCO (Cont.)		BARR (Cont.)	
ARCO No.	Sierra No.	ARCO No.	Sierra No.	ARCO No.	Sierra No.	BARR No.	Sierra No.
ARCO		6266	18-6789	R177	18-6268	CC-1-07686	18-1914
3410	18-6418	6267	18-6259	R211	18-5729	CC47-1650-06022	18-0473
3412	18-6432	6270	18-6765	R473	18-5705	CHV-1-83	18-1997-1
3420	18-6410	6275	18-6769-1	R670	18-6271	CHV470000	18-2902
3421	18-6420	6276	18-6777	R832	18-5704	CHVA470000	18-0418
3422	18-6411	6277	18-6757	SR102	18-6250	CM-1-5972-A	18-1915
3423	18-6421	6278	18-6273-1	SR104	18-6251	CM-1-5972B	18-1911
3424	18-6412	7325	18-5618	SR410	18-56001	CM-1-5972P	18-0474
3425	18-6422	7326	18-6282	SR412	18-56003	CM-1-6677A	18-1940
3426	18-6413	10112	18-5906	SR420	18-56003	CM-1-6672-B	18-1941
3427	18-6423	10113	18-6292	SR422	18-56003	CM-1-6672-J	18-0472
3428	18-6415	20102	18-5950	SR423	18-56003	CM-20-2847405	18-1913
3429	18-6424	20104	18-5951	SR424	18-56004	CM-20-4142411	18-1944
3430	18-6425	20800	18-6293	SR425	18-56003	CM-20-6672	18-1946
3431	18-6426	20800	18-6298	SR426	18-56005	CM206672JP	18-4360
3432	18-6427	20810	18-5983	SR427	18-56004	CM-20-6674	18-1945
3440	18-6414	20820	18-5984	SR428	18-56006	CM-20-6674P	18-4361
3442	18-6417	20820	18-6450	SR429	18-56007	CM206674P	18-4361
3444	18-6416	20825	18-6288	SR440	18-56008	CM-20-9234	18-1948
5360	18-6435	20830	18-6299	SR442	18-56008	CM-20-9234 P	18-8501
5362	18-6436	20840	18-6454	SR444	18-56009	CM-20-6674JP	18-8506
5364	18-6437	20850	18-6455	SW054	18-5816	CR 20 97169	18-1916
5365	18-6438	30119	18-5900	SW058	18-5817	CR 20 97386	18-1918
5366	18-5601	30121	18-5901	SW064	18-5818	CR 20 97387	18-1919
5367	18-5611	30122	18-5902	SW079	18-5840	CR 20 97624	18-1924
5368	18-5623	30140	18-5905	SW081	18-5807	CR 20 97772	18-1927
5369	18-5617	30450	18-5910	SW090	18-5805	CR 20 98068	18-1934
5369	18-6434	30456	18-5907	SW091	18-5806	CR-1-97752	18-1925
5370	18-5635	30457	18-5908	SW092	18-5809	CR-1-97992	18-1929
5371	18-5630	30459	18-5603	SW097	18-5819	CR-1-97993	18-1933
5372	18-5634	30460	18-5911	SW099	18-5820	CR-1-97753	18-1926
5373	18-5600	30462	18-6443	SW109	18-5834	CR-20-97296	18-1917
5374	18-5602	30470	18-6275	SW125	18-6291	CR2097924	18-1928
5375	18-5604	40112	18-5954	SW268	18-5812	FM183	18-1998-1
5376	18-5629	40152	18-5964	SW268	18-5812	MC-1-65603	18-1962-1
5377	18-5636	50143	18-6272	SW268	18-5812	MC-1-65604	18-1958-1
5379	18-5605	60050	18-5957	SW275	18-5815	MC-1-77234	18-1950-1
5380	18-5608	60055	18-5967	SW288	18-5814	MC-1-77235	18-1951-1
5381	18-6283	60060	18-5960	SW295	18-5835	MC-1-87114	18-1953-2
5382	18-6439	60065	18-5965	SW394	18-5801	MC-1-89011	18-1957-1
5386	18-5628	60070	18-6261	SW412	18-5842	MC-1-99746	18-1952-1
5387	18-5619	60071	18-6265	SW424	18-5843	MC199798	18-1956-1
5388	18-5606	60072	18-5979	SW450	18-6287	MC-20-12076	18-1975-1
5389	18-5624	60108	18-6263	SW580	18-5823	MC-20-44354	18-1976-1
5390	18-5627	60122	18-6262	SW580	18-5823D	MC-20-55538	18-1973
5391	18-5612	60125	18-6260	SW590	18-5833	MC2060426P	18-4362
5392	18-5610	70100	18-5903	SW590	18-5833D	MC-20-60426	18-1971
5393	18-5613	70101	18-5904	SW622	18-5808	MC-20-61851A2	18-1906
5393	18-5613	70110	18-5914	SW661	18-5836	MC-20-76325	18-1972
5394	18-5622	70111	18-5915	SW774	18-5803	MC-20-76771	18-1978
5395	18-5620	70112	18-6276	SW917	18-5841	MC-20-90880	18-1905
5396	18-5621	70114	18-5916	SW926	18-5822	MC-20-93320A3	18-1908
5397	18-5614	70116	18-5917	SW926	18-5822D	MC-20-98502	18-1974-1
5398	18-5631	70125	18-5920	SW945	18-5821	MC-20-98504	18-1970-1
5399	18-5632	80108	18-5939	SW975	18-5838	MC-20-60207	18-4008
5400	18-6440	84135	18-6284	SW981	18-5802	MC2947441	18-1977-1
5551	18-6441	84150	18-6278	SW984	18-5837	MC47-27-33395	18-0872
6204	18-6755	5381X	18-5609	TAK217	18-6253	MC47-27-33395A2	18-4394
6206	18-6761	AR103	18-5708	TR208	18-6252	MC472735898	18-0332
6208	18-6767-1	AR104	18-5709	TR217	18-6254	MC47273589A4	18-4395
6209	18-6754	AR351	18-5707	VR404	18-5711	MC472739915	18-2819
6211	18-6764	BK900	18-5697	VR405	18-5710	MC472739917	18-1209
6212	18-6279	DV366	18-5650	VR406	18-5727	MC472739923	18-1210
6214	18-6257	DV373	18-5674	VR407	18-5712	MC-47-27-41811	18-0672
6216	18-6762	DV374	18-5656	VR785	18-5740	MC47-27-41813	18-0897
6217	18-6763	DV376	18-5655			MC47-27-46401	18-2830
6218	18-6772	DV381	18-5658			MC47-27-46401A1	18-4396
6220	18-6759	DV389	18-5678			MC47-27-46820	18-0418
6223	18-6758	DV390	18-5671			MC472746820A1	18-4397
6224	18-6274	DV393	18-5673			MC472747590	18-2831
6227	18-6770	DV394	18-5677			MC472747644	18-0342
6228	18-6756	DVK68	18-5679			MC472748042	18-0885
6238	18-6281	M525	18-6771			MC47-27-48043	18-2832
6239	18-6258	PWB 1000	18-6442			MC472748818	18-2844
6241	18-6780	PWK440	18-6294			MC472752546	18-2896
6242	18-6280	PWK650	18-6295			MC47-27-53354	18-2912
6243	18-6285	PWP650	18-6296			MC47-27-53354A1	18-4398
6244	18-6277	PWY500	18-6289			MC472754014	18-2847
6245	18-6779	PWY650	18-6290			MC47-27-54566A1	18-4399
6250	18-6773	R036	18-6264			MC47-27-58764	18-0353
6255	18-6286	R040	18-6266			MC472760208	18-2834
				BARR			
				BARR No.	Sierra No.		
				10107	18-2854		
				147638	18-1995		
				160252	18-4009		
				200082	18-1999		
				1 73813	18-1990		
				1-54870	18-1912		
				200087P	18-1992-1		
				200089P	18-1991		
				20-0097	18-1949		
				20-0100	18-1939		
				CC 47 1650 05944	18-0470		

FRAM (Cont.)		GLM (Cont.)		GLM (Cont.)		GLM (Cont.)	
FRAM No.	Sierra No.	GLM No.	Sierra No.	GLM No.	Sierra No.	GLM No.	Sierra No.
P4102A	18-7942	11236	18-2365	12391	18-3145	12880	18-3346
P8043	18-7940	11238	18-6353	12395	18-3405	12881	18-6070
P8263	18-7802	11240	18-2205	12400	18-3129	12883	18-6112
PH13	18-7876	11245	18-2259	12405	18-3206	12884	18-6091
PH13	18-7876	11246	18-2363	12410	18-3116	12885	18-6090
PH16	18-7878	11300	18-2200	12415	18-3571	12886	18-6036
PH25	18-7923	11312	18-2407	12416	18-3572	12887	18-6032
PH2821	18-7886	11380	18-2299	12420	18-3118	12888	18-6098
PH2821A	18-7886	11381	18-2298	12430	18-3130	12889	18-6033
PH2870A	18-7925	11405	18-2191	12440	18-3363	12920	18-2707
PH30	18-7824	11406	18-1702	12450	18-3336	12930	18-2715
PH3306A	18-7926	11410	18-1158	12460	18-3180	13010	18-3553
PH3545	18-7927	11416	18-1708	12470	18-3367	13020	18-3550
PH3593A	18-7910	11420	18-1157	12500	18-3122	13030	18-3551
PH3612	18-7874	11430	18-1356	12501	18-3350	13040	18-3555
PH3614	18-7884	11500	18-2171	12502	18-3351	13050	18-3552
PH3614	18-7915	11510	18-2173	12510	18-3117	13060	18-3554
PH3980	18-7879	11520	18-2172	12520	18-3107	13070	18-3558
PH43	18-7878	11610	18-5967	12540	18-3139	13080	18-3557
PH4743	18-7886	11620	18-2372	12550	18-3127	13100	18-3649
PH4967	18-7906	11800	18-8210	12560	18-3126	13101	18-3647
PH4967	18-7916	11810	18-8211	12590	18-3141	13120	18-3549
PH49A	18-7880	12000	18-3315-2	12610	18-3178	13124	18-3569
PH5046	18-7917	12010	18-3507	12620	18-3343	13150	18-3561
PH6017A	18-7902	12020	18-3423	12630	18-3359	13170	18-3500
PH6017A	18-7910	12030	18-3424	12670	18-6011	13200	18-3556
PH6017A	18-7911	12041	18-3151	12675	18-6068	13220	18-1977-1
PH6607	18-7910	12042	18-3214	12680	18-6014	13230	18-1994
PH6607	18-7911	12043	18-3154	12690	18-6249	13270	18-3673
PH7317	18-7914	12050	18-3327	12700	18-6015-9	13280	18-3674
PH7575	18-7884	12060	18-3383	12702	18-6093	13350	18-3672
PH7575	18-7915	12061	18-3401	12703	18-6067	13370	18-3650
PH8842	18-7880	12070	18-3382	12703	18-6114	13380	18-3646
PH8A	18-7875	12071	18-3381	12704	18-6089	13380	18-3651
PH977A	18-7887	12082	18-3216	12704	18-6092	13381	18-3662
PH977A	18-7899	12084	18-3237	12710	18-6016	13390	18-3668
PS3808	18-7844	12085	18-3309	12711	18-6080	13400	18-3652
PS3808	18-7845	12088	18-3150	12712	18-6094	13410	18-3671
		12091	18-3212-1	12713	18-6066	13420	18-3667
		12100	18-3324	12730	18-6017	13430	18-3653
		12101	18-3393	12731	18-6018	13440	18-3670
		12102	18-3392	12733	18-6027	13450	18-3669
		12103	18-3391	12736	18-6025	13520	18-3678
		12104	18-3390	12737	18-6095	13530	18-1993
		12105	18-3211	12738	18-6026	13540	18-3531
		12106	18-3210	12739	18-6115	13550	18-3532
		12107	18-3215	12740	18-6012	13950	18-8112
		12108	18-3201	12741	18-6029	13984	18-4461
		12110	18-3317	12743	18-6113	13990	18-4224
		12120	18-3320	12744	18-6097	13991	18-4227
		12130	18-3321	12745	18-6034	13992	18-4226
		12140	18-3314	12750	18-6013	13993	18-4218
		12150	18-3316	12760	18-3121	14010	18-4500
		12170	18-3322	12770	18-6020	14020	18-4505
		12180	18-3323	12772	18-6019	14030	18-4515
		12190	18-3386	12773	18-6101	14040	18-4520
		12200	18-3219	12774	18-6028	14060	18-4535
		12202	18-3220	12775	18-6103	14110	18-4510
		12210	18-3378	12776	18-6024	14115	18-4010
		12211	18-3380	12780	18-6000	14120	18-4545
		12221	18-3385	12781	18-6023	14125	18-4011
		12243	18-3994	12782	18-6004	14130	18-4525
		12244	18-3388	12784	18-6005	14135	18-4012
		12246	18-3387	12787	18-6009	14140	18-4560
		12250	18-3207	12788	18-6010	14145	18-4013
		12251	18-3400	12789	18-6001	14155	18-4014
		12260	18-3252	12810	18-3114	14160	18-4575
		12270	18-3239	12812	18-3358	14165	18-4015
		12280	18-3517	12813	18-3179	14190	18-4090
		12290	18-3217	12817	18-3113	14210	18-3918
		12305	18-3149-1	12820	18-3109	14220	18-3919
		12310	18-3417	12821	18-3226	14230	18-3920
		12320	18-3420	12822	18-3197	14240	18-3921
		12330	18-3421	12824	18-3151	14250	18-3922
		12341	18-2354	12825	18-3222	14260	18-3923
		12350	18-3416	12826	18-2722	14270	18-3924
		12352	18-3445	12829	18-3221	14275	18-3927
		12360	18-3419	12830	18-3110	14280	18-3925
		12370	18-3414	12836	18-2728	14315	18-4600
		12380	18-3422	12840	18-3106	14320	18-4555
		12390	18-3119	12860	18-3115	14330	18-4565
GLM		GLM No.	Sierra No.				
01056	18-7315						
01070	18-7314						
01073	18-7307						
01100	18-7316						
10561	18-3290						
10562	18-3566						
11013	18-2408						
11020	18-2409						
11030	18-2286						
11040	18-2130						
11050	18-2348						
11051	18-2398						
11052	18-2399						
11055	18-1502						
11060	18-2202						
11061	18-2236						
11071	18-3293						
11091	18-2406						
11100	18-2410						
11110	18-2167						
11120	18-2180						
11130	18-2179						
11131	18-2324						
11140	18-2261						
11150	18-2166						
11151	18-2239						
11155	18-2166						
11163	18-2181						
11190	18-3719						
11200	18-6350						
11210	18-2201						
11215	18-2256						
11216	18-2358						
11220	18-2203						
11225	18-2257						
11226	18-2364						
11230	18-2204						
11235	18-2258						

GLM (Cont.)		GLM (Cont.)		GLM (Cont.)		GLM (Cont.)	
GLM No.	Sierra No.	GLM No.	Sierra No.	GLM No.	Sierra No.	GLM No.	Sierra No.
14410	18-4635	21190	18-3723	21771	18-2345	22420	18-2244
14430	18-4637	21210	18-3200	21780	18-2160	22420	18-22441-9
14440	18-4636	21220	18-3204	21790	18-7321	22420	18-2387
14470	18-4626	21230	18-3700	21791	18-7311	22420	18-23871-9
14480	18-4627	21231	18-3737	21800	18-4267	22421	18-2288
14490	18-4628	21240	18-3704	21811	18-2140	22430	18-2361
14600	18-4055	21241	18-3726	21820	18-1156	22433	18-2326
14610	18-4056	21242	18-3703	21830	18-1166	22435	18-2327
14640	18-4059	21245	18-0654	21840	18-1153	22436	18-2330
14650	18-4060	21250	18-3701	21850	18-2101	22440	18-3229
14660	18-4623	21251	18-3782	21860	18-1154	22445	18-8551
14670	18-4624	21260	18-3702	21870	18-3199	22490	18-2243
14680	18-4625	21261	18-3781	21880	18-3198	22491	18-1501
14910	18-3979	21290	18-4233	21885	18-1500	22500	18-4040
14920	18-3980	21300	18-4220	21887	18-8111	22520	18-1600
14930	18-3981	21321	18-8348	21890	18-3232	22540	18-1602
14940	18-3982	21330	18-7426	21892	18-4258	22560	18-1601
14950	18-3983	21350	18-4221	21893	18-4263	22612	18-2217
14960	18-3984	21360	18-3714	21894	18-4264	22616	18-2290
15100	18-3575	21370	18-2462	21896	18-4265	22620	18-2217
15201	18-3583	21380	18-2463	21900	18-2100	22625	18-2216
15201	18-3599	21419	18-3749	21910	18-2461	22630	18-2221
15301	18-3574	21420	18-2169	21930	18-2148	22631	18-2218
15400	18-3584	21421	18-2322	21951	18-8205	22633	18-2220
15500	18-3581	21423	18-3236	21960	18-8206	22661	18-2310
15600	18-3582	21424	18-2395	21961	18-8212	22662	18-2309
15700	18-3578	21425	18-2464	21962	18-2771	22663	18-2308
16100	18-4035	21430	18-2149	21980	18-2142	22670	18-2210
16120	18-4036	21432	18-3754	22010	18-2176	22671	18-2207
16150	18-4037	21433	18-2303	22020	18-2177	22672	18-2208
16180	18-1186	21440	18-2600	22030	18-4251	22673	18-2209
16200	18-1194	21450	18-2603	22031	18-4273	22681	18-2289
16210	18-4038	21451	18-2190	22040	18-2156	22683	18-2287
16220	18-1374	21453	18-2604	22050	18-2178	22700	18-1362
16230	18-1376	21460	18-2159	22090	18-2380	22710	18-1377
16240	18-1375	21480	18-2396	22100	18-3740	22720	18-1099
16300	18-1366	21481	18-2397	22110	18-3741	22750	18-1112
16310	18-1371	21510	18-1165	22120	18-3742	22760	18-1113
16320	18-1367	21511	18-1179	22130	18-3743	22770	18-1114
16330	18-1365	21512	18-1129	22140	18-3744	22780	18-1115
16340	18-1370	21520	18-1160	22150	18-3705	22800	18-1352
16350	18-1363	21540	18-1161	22160	18-3706	22810	18-1353
16360	18-1364	21541	18-1170	22170	18-3707	22820	18-1361
16370	18-1368	21542	18-1172	22185	18-3708-1	22830	18-1378
16400	18-4039	21543	18-1171	22190	18-4231	22840	18-1359
16420	18-1195	21560	18-1142	22191	18-4274	22850	18-1360
16470	18-1347	21570	18-1164	22200	18-3715	22860	18-1350
16520	18-1196	21580	18-1143	22220	18-4223	22870	18-1351
17000	18-2402	21584	18-1193	22230	18-4222	22880	18-1357
18000	18-2401	21590	18-1159	22240	18-4230	22890	18-1354
18100	18-2443	21591	18-1173	22250	18-4228	22900	18-1355
19100	18-2450	21592	18-1130	22252	18-4194	22910	18-1358
19200	18-2451	21593	18-1197	22260	18-4232	22920	18-1372
19300	18-2452	21600	18-1150	22280	18-0550	22930	18-1373
19310	18-3729	21610	18-1117	22290	18-0549	22940	18-1369
19350	18-3728	21620	18-1155	22300	18-2377	22960	18-1118
19400	18-2453	21622	18-1346	22317	18-4244	22980	18-1121
21010	18-2154	21623	18-1345	22320	18-3153	22990	18-1122
21015	18-2353	21625	18-1398	22321	18-4276	23010	18-2778
21020	18-2155	21630	18-1162	22322	18-4277	23011	18-2777
21030	18-2150	21641	18-0193	22323	18-3133	23020	18-2939
21031	18-2320	21642	18-0195	22325	18-3365	23030	18-2199
21032	18-0647	21643	18-0194	22330	18-3725	23040	18-4210
21033	18-0655	21644	18-0198	22340	18-3717	23050	18-4213
21040	18-2193	21645	18-0200	22350	18-3716	23060	18-4214
21060	18-2164	21646	18-0199	22360	18-3369	23070	18-4211
21070	18-2165	21647	18-0196	22370	18-3135	23080	18-2153
21080	18-2141	21648	18-0197	22380	18-3136	23090	18-4204
21090	18-2163	21649	18-0201	22388	18-0653	23100	18-4206
21100	18-2151	21710	18-2157	22390	18-0190	23110	18-2194
21110	18-3750	21711	18-2145	22391	18-3233	23140	18-2342
21111	18-3768	21715	18-2245-1	22407	18-9219	23141	18-3759
21120	18-3751	21725	18-4236	22408	18-2279	23150	18-4208
21130	18-2152	21731	18-2375	22409	18-2277	23160	18-4209
21131	18-2357	21731	18-23751-9	22410	18-2185	23200	18-2346
21136	18-4295	21731	18-2378	22411	18-2184	23203	18-7296
21140	18-2161	21731	18-23781-9	22412	18-2183	23210	18-2294
21160	18-3720	21740	18-3245	22413	18-2186	23220	18-2285
21161	18-2344	21740	18-6245	22414	18-2187	23230	18-4215
21170	18-3721	21750	18-2170	22416	18-2252	23240	18-4212
21180	18-3722	21770	18-4289	22417	18-2251	23260	18-2283

GLM (Cont.)		GLM (Cont.)		GLM (Cont.)		GLM (Cont.)	
GLM No.	Sierra No.	GLM No.	Sierra No.	GLM No.	Sierra No.	GLM No.	Sierra No.
23261	18-2282	26200	18-2134	30363	18-0740	31400	18-0879
23270	18-2293	26200	18-2137	30370	18-0905	31410	18-2819
23280	18-2292	26210	18-2116	30380	18-2848	31420	18-1210
23300	18-2295	26220	18-2126	30381	18-0435	31430	18-2831
23510	18-2231	26240	18-2115	30390	18-0419	31440	18-2830
23580	18-2230	26250	18-2136	30410	18-0867	31450	18-2846
23590	18-2229	26310	18-2701	30430	18-2514	31460	18-2553
23710	18-3931	26320	18-2336	30440	18-0980	31470	18-0342
23800	18-4122	26330	18-2702-1	30450	18-0350	31480	18-0885
23810	18-4121	26340	18-4288	30470	18-0352	31490	18-2832
23810	18-4294	26350	18-2341	30480	18-0982	31500	18-2802
23820	18-4112	26380	18-2428	30490	18-0898	31510	18-2844
23830	18-4111	26400	18-2427	30510	18-0353	31520	18-2833
23840	18-4102	26410	18-2426	30530	18-0976	31530	18-0378
23850	18-4101	26440	18-0652	30570	18-0904	31540	18-0462
23910	18-4107	26460	18-2425	30580	18-0354	31550	18-2896
23930	18-4127	26470	18-2424	30610	18-0182	31560	18-2917
23940	18-4123	26480	18-2465-9	30640	18-0910	31570	18-2912
23950	18-4113	26490	18-2466-9	30670	18-0129	31580	18-2515
23960	18-4103	26500	18-2420	30680	18-2806	31590	18-0568
24010	18-4120	26510	18-2421	30700	18-0912	31600	18-2838
24020	18-4110	26520	18-2423	30720	18-0914	31620	18-2834
24030	18-4100	26530	18-2422	30730	18-0149	31630	18-2554
24040	18-4124	27700	18-3767	30740	18-0359	31640	18-0988
24050	18-4065	27720	18-1731	30760	18-0918	31650	18-2572
24060	18-4114	27782	18-1712	30770	18-0131	31660	18-0356
24080	18-4104	27931	18-2192	30790	18-0410	31670	18-2552
24090	18-4067	27940	18-1729	30800	18-0922	31680	18-2501
24100	18-4066	28020	18-2104	30850	18-4366	31690	18-2509
24110	18-4125	28030	18-2174	30860	18-0868	31710	18-0992
24112	18-4115	28040	18-2097	30870	18-0363	31720	18-2835
24130	18-4105	28050	18-9218	30880	18-0926	31730	18-2573
24140	18-4068	28060	18-6401	30890	18-2513	31740	18-0434
24210	18-3904	28100	18-2128	30900	18-0133	31750	18-0158
24240	18-3910	28180	18-1152	30920	18-0928	31770	18-0903
24250	18-3975	28190	18-1151	30930	18-2512	31780	18-0942
24260	18-3911	28300	18-3231	30940	18-0932	31790	18-0137
24280	18-3912	28310	18-2125	30960	18-0101	31810	18-2804
24290	18-3974	28315	18-2146	30970	18-0866	31820	18-0685
24300	18-3905	28317	18-2337	30980	18-0372	31830	18-0389
24310	18-3913	28318	18-2339	30990	18-0103	31840	18-2843
24330	18-3915	28325	18-2338	31000	18-0938	31850	18-0365
24410	18-4106	28330	18-3712	31010	18-2914	31860	18-2800
24430	18-3933	28340	18-6400	31020	18-2915	31870	18-0369
24430	18-4126	28350	18-3752	31030	18-2801	31880	18-0151
24570	18-3907	28360	18-3713	31040	18-2826	31890	18-2507
24590	18-3908	28370	18-0577	31050	18-2919	31900	18-0147
24830	18-7826	28380	18-2296	31060	18-2823	31900	18-0747
24840	18-7859	28390	18-4296	31070	18-2824	31910	18-0105
24841	18-7869	28400	18-2381	31080	18-2825	31920	18-2805
24880	18-7860	28402	18-2382	31090	18-2827	31930	18-2836
24900	18-7861	30010	18-2340	31100	18-0872	31940	18-0934
24910	18-7862	30020	18-0681	31100	18-2949	31950	18-2837
24930	18-7846	30030	18-2316	31101	18-2902	31960	18-0371
24940	18-7845	30050	18-0123	31105	18-8536	31970	18-0373
24941	18-7844	30060	18-0870	31110	18-2829	31980	18-0139
24950	18-7852-1	30090	18-2564	31120	18-2847	31990	18-0936
24951	18-7848-1	30100	18-0328	31130	18-2820	32000	18-2561
24970	18-7854	30120	18-0329	31141	18-2743	32010	18-2500
24980	18-7855	30160	18-0895	31150	18-0894	32030	18-5399
25000	18-7853-1	30170	18-0333	31160	18-2840	32040	18-0422
25110	18-8207	30180	18-0334	31170	18-29451-9	32050	18-2839
25115	18-2404	30190	18-1209	31171	18-42481-9	32070	18-0946
25120	18-8208	30220	18-0672	31180	18-2948	32080	18-2849
25125	18-2405	30230	18-0893	31190	18-2841	32090	18-2504
25135	18-2369	30240	18-0897	31200	18-2828	32100	18-2555
26030	18-2119	30260	18-2810	31210	18-2560	32110	18-0385
26040	18-2105	30270	18-2809	31220	18-2558	32120	18-2803
26050	18-2106	30290	18-2563	31230	18-2559	32130	18-0357
26060	18-2107	30290	18-2566	31260	18-2568	32140	18-0360
26070	18-2108	30300	18-4380	31270	18-2569	32150	18-2502
26080	18-2109	30320	18-2565	31280	18-2570	32160	18-0667
26090	18-2120	30330	18-0344	31300	18-2571	32170	18-2909
26100	18-2103	30350	18-0464	31310	18-2567	32175	18-8533
26110	18-2112	30351	18-1238	31330	18-4261	32180	18-0994
26120	18-2113	30353	18-0428	31340	18-0164	32190	18-2575
26130	18-2110	30353	18-2845	31350	18-0327	32200	18-2910
26140	18-2111	30354	18-0322	31360	18-0889	32210	18-0347
26170	18-2123	30357	18-0664	31370	18-0874	32220	18-0320
26180	18-2124	30359	18-0311	31380	18-0891	32280	18-2574
26190	18-2114	30360	18-0887	31390	18-0332	32300	18-0948

GLM (Cont.)		GLM (Cont.)		GLM (Cont.)		GLM (Cont.)	
GLM No.	Sierra No.	GLM No.	Sierra No.	GLM No.	Sierra No.	GLM No.	Sierra No.
32320	18-2807	33511	18-0108	34520	18-0124	35960	18-3897
32330	18-0952	33530	18-2873	34530	18-1212	35990	18-2957
32350	18-0384	33540	18-2956	34540	18-0134	36080	18-2968
32360	18-2562	33560	18-2856	34550	18-2865	36090	18-2970
32370	18-0111	33570	18-1204	34560	18-3360	36100	18-3879
32390	18-0185	33580	18-0680	34570	18-3803	36100	18-7879
32400	18-0160	33590	18-2545	34580	18-2905	36110	18-3877
32420	18-2505	33600	18-2546	34590	18-3839	36120	18-3878
32440	18-2808	33610	18-0148	34610	18-2913	36130	18-3880
32450	18-2510	33620	18-2549	34620	18-2938	36140	18-3881
32460	18-0113	33630	18-0985	34630	18-2548	36150	18-2946
32470	18-0881	33640	18-2864	34640	18-0933	36160	18-3876
32480	18-0950	33650	18-0977	34650	18-0927	36170	18-3883
32500	18-0388	33660	18-0991	34700	18-0937	36180	18-3887
32510	18-2511	33680	18-0102	34710	18-0188	36200	18-3825
32520	18-2506	33690	18-0106	34720	18-2911	36220	18-3822
32530	18-2503	33700	18-3899	34730	18-2918	36230	18-3823
32540	18-2508-1	33710	18-2852	34740	18-0935	36240	18-3824
32560	18-0945	33730	18-2557	34750	18-0923	36250	18-3820
32580	18-0114	33740	18-0118	34770	18-2916	36260	18-3814
32600	18-0318	33750	18-2857	34771	18-0911	36290	18-3855
32630	18-0954	33760	18-0418	34780	18-0941	36300	18-3857
32640	18-2815	33765	18-8532	34790	18-0424	36820	18-0476
32650	18-7106	33770	18-2875	34800	18-1218	36830	18-2854
32680	18-0431	33780	18-0401	34850	18-1224	36840	18-0475
32730	18-0386	33790	18-0183	34860	18-0951	37000	18-4313
32740	18-0916	33795	18-8509	34870	18-0953	37010	18-4312
32750	18-0876	33800	18-0956	34870	18-0953	37020	18-4314
32760	18-0323	33810	18-0943	34880	18-0957	37100	18-2991
32770	18-0324	33820	18-0673	34890	18-0397	37110	18-0962
32780	18-0336	33830	18-2961	34910	18-3827	37120	18-0869
32800	18-2343	33840	18-2947	34920	18-3829	37130	18-0154
32820	18-0339	33850	18-2884	34930	18-3830	37150	18-0960
32830	18-0670	33860	18-2888	34940	18-3831	37160	18-0417
32840	18-0341	33870	18-2964	34950	18-3805	37190	18-0968
32870	18-0930	33880	18-3804	34960	18-3832	37200	18-0119
32880	18-0135	33890	18-3828	34970	18-0959	37210	18-0853
32890	18-0374	33900	18-0548	34980	18-0961	37220	18-0855
32920	18-0380	33910	18-0884	34990	18-0967	37240	18-0857
32930	18-0940	33930	18-0104	35020	18-2929	37250	18-0861
32940	18-0944	33950	18-0913	35030	18-0391	37260	18-0141
32950	18-0107	33960	18-0880	35060	18-0398	37270	18-0152
32960	18-0970	33970	18-0440	35070	18-0346	37290	18-0863
32980	18-2850	33970	18-0440	35070	18-0349	37310	18-0873
32990	18-2883-1	34000	18-0679	35080	18-2971	37320	18-0314
33010	18-2851	34010	18-3841-2	35090	18-2729	37330	18-0115
33020	18-0110	34020	18-2889	35180	18-0983	37360	18-0958
33030	18-0430	34030	18-2959	35190	18-0112	37370	18-0915
33050	18-0939	34040	18-2891	35200	18-0120	37400	18-0315
33060	18-2863	34050	18-2892	35320	18-0122	37410	18-0854
33080	18-2863	34080	18-0850	35330	18-0126	37430	18-0415
33090	18-2907	34090	18-2893	35340	18-0128	37470	18-0622
33100	18-2862	34120	18-0882	35360	18-0136	37490	18-0345
33110	18-2890	34140	18-2963	35370	18-0138	37500	18-0416
33120	18-2879	34150	18-2895	35380	18-0140	37520	18-0624
33130	18-2908	34200	18-2897	35390	18-0142	37530	18-0644
33140	18-2903	34220	18-2881	35400	18-0144	37540	18-0645
33150	18-2906	34230	18-0917	35410	18-0441	37550	18-0646
33170	18-2709	34240	18-3801	35420	18-0851	37560	18-0642
33180	18-2901	34250	18-3802	35430	18-1205	37570	18-0643
33190	18-2867	34260	18-0929	35440	18-1202	37590	18-0641
33210	18-2904	34280	18-3836	35460	18-0150	37630	18-2942
33220	18-2887	34290	18-2866	35480	18-0157	37640	18-2621
33230	18-2880	34300	18-0117	35540	18-0161	37660	18-2741
33240	18-2871	34310	18-2543	35620	18-0633	37650	18-2740
33250	18-2870	34320	18-2853	35650	18-3898	37660	18-2943
33280	18-0426	34330	18-0969	35730	18-0978	37670	18-2611
33280	18-2876	34340	18-0971	35740	18-0130	37680	18-2610
33330	18-2861	34350	18-2878	35750	18-0987	37690	18-2582
33340	18-2860	34370	18-2544	35780	18-0965	37760	18-0626
33370	18-2900	34380	18-0979	35800	18-0963	37795	18-0628
33400	18-2960	34390	18-0981	35830	18-3895	37797	18-0627
33410	18-2865	34400	18-3837	35840	18-2954	39010	18-4386
33420	18-2855	34410	18-0189	35850	18-3861	39020	18-4387
33430	18-2877	34420	18-0975	35860	18-3862	39030	18-4385
33440	18-2858	34430	18-0989	35870	18-3864	39040	18-4381
33450	18-2874	34440	18-0675	35880	18-3863	39050	18-4383
33460	18-0973	34450	18-2547	35890	18-3871	39060	18-4384
33470	18-0947	34460	18-2550	35900	18-3872	39080	18-4303-1
33480	18-0949	34470	18-0995	35930	18-3866	39090	18-4304-1
33500	18-0677	34480	18-0997	35940	18-3896	39100	18-4358
33510	18-0955	34490	18-0999	35950	18-3838		

GLM (Cont.)		GLM (Cont.)		GLM (Cont.)		GLM (Cont.)	
GLM No.	Sierra No.	GLM No.	Sierra No.	GLM No.	Sierra No.	GLM No.	Sierra No.
39110	18-4382	40150	18-7830	47130	18-3603	70670	18-5212
39120	18-4397	40160	18-7831	50006	18-4008	70680	18-5206
39130	18-0340	40280	18-7818-1	50310	18-1908K	71000	18-5428
39140	18-4350	40290	18-7817	50330	18-1906	71020	18-5418
39150	18-4351	40310	18-7804	50610	18-1985	71030	18-5420
39160	18-0407	40320	18-7807	51010	18-4009	71040	18-5404-1
39170	18-0465	40330	18-7808	51030	18-1990	71050	18-5407
39180	18-4352	40340	18-7809	51110	18-1970-1	71050	18-5425
39190	18-4353	40350	18-7811	51120	18-1971	71060	18-5403
39210	18-4354	40360	18-7812	51130	18-1972	71070	18-5432
39230	18-0153	40370	18-7813	51140	18-1976-1	71080	18-5431
39240	18-4357	40380	18-7814	51160	18-1975-1	71090	18-5411
39250	18-4319	40390	18-7810	51180	18-1937	71100	18-5405
39260	18-0411	40410	18-7004	51190	18-1978	71110	18-5408
39270	18-4396	40420	18-7005	51210	18-1956-1	71120	18-5406
39280	18-4394	40435	18-7006-1	51212	18-1955-1	71130	18-5403
39290	18-4395	40460	18-7007	51220	18-1952-1	71400	18-5354
39300	18-4398	40470	18-7013	51224	18-1960-1	71410	18-5362
39310	18-4399	40480	18-7021	51230	18-1953-2	71420	18-5361
39320	18-4367	40490	18-7211-1	51237	18-1950-1	71450	18-5393
39330	18-4355	40500	18-7033	51238	18-1951-1	71460	18-5394
39331	18-4340	40501	18-7037	51240	18-1957-1	71470	18-5356
39332	18-4339	40510	18-7043	51250	18-1958-1	71480	18-5358
39333	18-4336	40530	18-7024	51252	18-1962-1	71490	18-5357
39335	18-4334	40540	18-7026	51320	18-1921	71500	18-5396
39336	18-4326	40550	18-7223	51330	18-1909	71510	18-5395
39337	18-4325	40560	18-7042	51340	18-1922	71520	18-5384
39338	18-4338	40570	18-7046	51410	18-1902	71530	18-5386
39340	18-4315	40580	18-7220	51420	18-1903	71540	18-5385
39350	18-4300	40590	18-7221	51430	18-1986	71550	18-5389
39350	18-4302	40600	18-7219	51442	18-1901	71560	18-5352
39354	18-4310	40610	18-7212	51480	18-1848	71570	18-5369
39355	18-4324	40620	18-7213	51510	18-1935-1	71580	18-5375
39360	18-4301	40630	18-7214	51520	18-1936	71590	18-5376
39370	18-4305	40640	18-7215	51610	18-1930-1	71600	18-5353
39380	18-4306	40650	18-7750-1	51630	18-1931-1	71700	18-5270
39390	18-4321	40651	18-7226	51640	18-1932	71710	18-5269
39400	18-4322	40710	18-7093	52080	18-1938	71720	18-5268
39410	18-4323	40720	18-7094	52090	18-1984	71730	18-5275
39420	18-4307	40800	18-7801	52230	18-1983	71740	18-5277
39430	18-4309	40810	18-7823	52240	18-1982	71750	18-5276
39440	18-4317	40820	18-7820	53100	18-4362	71760	18-5271
39470	18-0466	40830	18-7821	53300	18-8529	71770	18-5267
39490	18-0348	40840	18-7822	53330	18-8554	71780	18-5273
39500	18-0611	40850	18-7800	53360	18-8556	71790	18-5274
39520	18-4359	40860	18-7805	53430	18-8555	71800	18-5272
39550	18-4356	40870	18-7806-1	53770	18-8539	71810	18-5281
39560	18-4316	40900	18-7233	54110	18-1899	71820	18-5278
39590	18-2614	40910	18-7061	54250	18-1996	71830	18-5280
39600	18-2620	40920	18-7057	56030	18-1949	72010	18-5179
39620	18-2619-1	40930	18-7041	56110	18-1999	72020	18-5196
39630	18-2613	40950	18-7062	56120	18-1907	72030	18-5172
39640	18-2615	40970	18-7295	56140	18-1939	72040	18-5192
39650	18-4388	41120	18-7477	56230	18-1997-1	72050	18-5194
39660	18-4389	44990	18-7956	56240	18-1898	72060	18-5170
39670	18-4390	45010	18-4217	56250	18-1998-1	72070	18-5193
39680	18-4391	45020	18-7179	70010	18-5303	72080	18-5176
39690	18-4392	45030	18-7180	70020	18-5311	72100	18-5181
39700	18-4393	45050	18-7190	70030	18-5310	72110	18-5433
39710	18-4375	45060	18-7181	70040	18-5318	72113	18-5443
39720	18-4376	45080	18-7183	70050	18-5317	72114	18-5442
39730	18-4337	45090	18-7184	70060	18-5314	72115	18-5434
39740	18-4378	45100	18-7186	70070	18-5156	72120	18-5178
39750	18-4379	45160	18-7194	70080	18-5157	72130	18-5108
39770	18-4369	45170	18-7185	70082	18-5305	72240	18-5740
39780	18-4370	45180	18-7187	70100	18-5306	72260	18-5711
39790	18-4371	45200	18-7137	70110	18-5148	72310	18-5707
39800	18-4372	45230	18-7100	70160	18-5153	72320	18-5708
39810	18-4373	45250	18-0298	70170	18-5140	72350	18-5709
39820	18-4374	45280	18-7405	70200	18-5141	72360	18-5801
39830	18-4368	46100	18-1219	70500	18-5349	72370	18-5815
39840	18-0405	46110	18-1221	70510	18-5347	72380	18-5820
39850	18-1237	46120	18-3562	70520	18-5344	72390	18-5816
39870	18-4347-1	46130	18-1222	70530	18-5345	72400	18-5817
39880	18-4349	46140	18-3567	70540	18-5346	72402	18-5819
39890	18-4348	46150	18-1243	70570	18-5199	72403	18-5812
39910	18-0604	46160	18-3565	70580	18-5338	72410	18-5802
39920	18-0603	46170	18-3564	70590	18-5200	72420	18-5807
40130	18-7832	46180	18-3563	70591	18-5348	72430	18-5808
40130	18-7838	47110	18-3602	70640	18-5205	72440	18-5814
40140	18-7829	47120	18-3601	70660	18-5169	72460	18-5837

GLM (Cont.)		GLM (Cont.)		GLM (Cont.)		GLM (Cont.)	
GLM No.	Sierra No.	GLM No.	Sierra No.	GLM No.	Sierra No.	GLM No.	Sierra No.
72480	18-5836	77011	18-7286	81360	18-7171	85480	18-2008
72490	18-5838	77040	18-7267	81380	18-7130	85490	18-1211
72500	18-5834	77050	18-7266	81390	18-7176	85520	18-2052
72510	18-5297	77060	18-7265	81400	18-7123	85530	18-2053
72520	18-5296-2	77070	18-7274	81430	18-0858	85580	18-2055
72530	18-5298	77080	18-7269	81430	18-7163	85581	18-2054
72540	18-5299	77090	18-7275	81440	18-7401	85590	18-2599
72550	18-5295	77101	18-7263	81450	18-7108	85600	18-2007
72570	18-5294	77102	18-7268	81470	18-7419	85610	18-2010
72590	18-5265	77103	18-7270	81510	18-7467	85630	18-0539
72600	18-5284	77105	18-7260	81520	18-0860	85680	18-2048
72610	18-5250	77106	18-7272	81540	18-7110	85700	18-2076
72620	18-5251	77108	18-7271	81550	18-7400	85790	18-0519
72630	18-5252	77113	18-7284	81570	18-7449	85800	18-0526
72640	18-5253	77114	18-7278	82030	18-7118	85810	18-0531
72650	18-5260	77115	18-7289	82050	18-7472	85830	18-0540
72660	18-5258	77116	18-7288	82060	18-7959	85840	18-8353
72660	18-5264	77200	18-4200	82080	18-7490	85850	18-2349
72670	18-5254	77200	18-7200	82100	18-7135	85860	18-1508
72680	18-5256	77220	18-7201	82110	18-7420	85910	18-2094
72800	18-5011	77230	18-7202	82130	18-7178	85960	18-0520
72810	18-5006	77250	18-7208	82140	18-7114	86010	18-2071
72820	18-5002	77260	18-72000	82150	18-7117	86011	18-8300
72830	18-5003	77290	18-7210	82170	18-7112	86012	18-8301
72840	18-5001	79110	18-7605	82200	18-7170	86013	18-8325
72970	18-5012	79120	18-7615	82230	18-7155	86030	18-2001
72980	18-5008	79120	18-7618	82240	18-7115	86040	18-2020
73010	18-5705	79140	18-7616	82240	18-7464	86050	18-2058
73020	18-5704	79150	18-7617	82250	18-7173	86060	18-2060
73110	18-5116-1	79180	18-7609	82260	18-7162	86070	18-2066
73120	18-5115-1	79190	18-7608	82270	18-7196	86080	18-2072
73180	18-6769-1	79210	18-7603	82280	18-7104	86090	18-2073
73190	18-5107-1	80070	18-7421	82280	18-7459	86100	18-3111
74000	18-5750	80080	18-7141	82310	18-7152	86120	18-2025
74000	18-5950	80090	18-7120	82320	18-7140	86130	18-2536
74000	18-5956	80100	18-7101	82340	18-7151	86140	18-2532
74001	18-5951	80100	18-7109	82350	18-7121	86150	18-2027
74001	18-5957	80100	18-7406	82360	18-7172	86160	18-2059
74100	18-5903	80110	18-7413	82370	18-7127	86170	18-2028
74110	18-5904	80120	18-7168	82380	18-7169	86180	18-2029
74140	18-5905	80130	18-7102	82390	18-7167	86190	18-2031
74140	18-5910	80140	18-7165	82400	18-7133	86200	18-2033
74150	18-5900	80160	18-7166	82430	18-7407	86210	18-2537
74150	18-5911	80160	18-7466	82440	18-7144	86230	18-2539
74170	18-5902	80170	18-7410	82460	18-7418	86240	18-2061
74170	18-5908	80180	18-7105	82480	18-7107	86250	18-2062
74180	18-5901	80190	18-7445	82900	18-7957	86270	18-2063
74180	18-5907	80220	18-7129	83200	18-7139	86300	18-2996
74190	18-5913	80330	18-7414	83250	18-7138	86310	18-2516
75330	18-5754	80350	18-7412	83340	18-7157	86350	18-2021
75340	18-5753	80380	18-7177	83410	18-7157	86360	18-2022
75350	18-5756	80390	18-7195	83440	18-7159	86370	18-2000
75360	18-5757	80420	18-7161	84026	18-7474	86380	18-2018
75370	18-5755	80440	18-7415	85010	18-2016	86390	18-2023
75380	18-5759	81030	18-7197	85020	18-2049	86400	18-2024
75390	18-5760	81070	18-7111	85030	18-2003	86410	18-2005
75400	18-5758	81080	18-0175	85040	18-2013	86420	18-2030
76068	18-7070	81080	18-7145	85040	18-2026	86430	18-2032
76068	18-7746	81090	18-7404	85050	18-2009	86440	18-2074
76081	18-7081	81100	18-7116	85060	18-2056	86450	18-2035
76082	18-7080	81100	18-7417	85070	18-2014	86460	18-2064
76082	18-7089	81120	18-7134	85080	18-2011	86470	18-2075
76083	18-7076	81140	18-7174	85090	18-0523	86480	18-2704
76084	18-7078	81140	18-7416	85100	18-2019	86481	18-2391
76085	18-7097	81160	18-7158	85110	18-2012	86490	18-2703
76086	18-7098	81170	18-7440-1	85120	18-2051	86491	18-2705
76088	18-7017	81180	18-7153	85130	18-2002	86492	18-3329
76096	18-7096	81190	18-7103	85130	18-2077	86494	18-3337
76101	18-7000	81210	18-7408	85140	18-2944	86496	18-2392
76102	18-7001	81220	18-7146	85150	18-0521	86497	18-2708
76103	18-7008	81230	18-7156	85160	18-0583	86500	18-2706
76104	18-7040	81230	18-7409	85170	18-0522	86510	18-2034
76105	18-7085	81240	18-7411	85200	18-0563	86520	18-2065
76107	18-7075	81250	18-7143	85210	18-2015	86530	18-2067
76111	18-7071	81260	18-7164	85230	18-0514	86540	18-2769
76120	18-7086	81270	18-7198	85260	18-0515	86570	18-7481
76123	18-7077	81280	18-7403	85270	18-0516	86610	18-2068
76150	18-7095	81290	18-7461	85290	18-2017	86620	18-0166
76160	18-7072	81310	18-7126	85330	18-2006	86630	18-2541
77010	18-1256	81320	18-7457	85380	18-0525	86640	18-7475
77010	18-7256	81340	18-7128	85440	18-0517	86654	18-8352
				85460	18-0527	86660	18-7963

GLM (Cont.)		GLM (Cont.)		GLM (Cont.)		MES (Cont.)			
GLM No.	Sierra No.	GLM No.	Sierra No.	GLM No.	Sierra No.	MES No.	Sierra No.		
86700	18-2767	87807	18-2640	89880	18-3074	5323M	18-5905		
86710	18-2768	87808	18-2624	89890	18-3067	5399M	18-5913		
86711	18-2724	87809	18-2635	89900	18-3068	5401M	18-5919		
86712	18-2692	87810	18-2636	89910	18-3069	D1002M	18-5674		
86720	18-1240	88170	18-7175	89920	18-3070	D1004M	18-5677		
86740	18-0173	89010	18-2757	89930	18-3071	D1008M	18-5673		
86750	18-0174	89020	18-2758	89940	18-3082	D2000M	18-5678		
86760	18-0542	89030	18-2744	89950	18-3058	D2001M	18-5679		
86760	18-0592	89040	18-2752	89990	18-3366	RL-001	18-5705		
86770	18-0543	89050	18-2751	90050	18-4442	RL-003	18-5704		
86790	18-8307	89060	18-2759	90065	18-4446	RL-O06	18-5729		
86810	18-8367	89070	18-2762	90070	18-9099	RSV01	18-6771		
86840	18-0584	89080	18-2753-2	90100	18-9803	RSV02	18-6778		
87010	18-2990	89090	18-2761	90110	18-9806E	S1060M	18-5645		
87020	18-2047	89100	18-2750	90140	18-9817	S1062M	18-5641		
87030	18-2040	89120	18-2748	90160	18-9853	S1063M	18-5642		
87050	18-2043	89130	18-2746	90170	18-9855	S1064M	18-5649		
87060	18-2041	89140	18-2756	90180	18-9856	S1068M	18-5643		
87070	18-2057	89150	18-2760	90190	18-9858	S1070M	18-6413		
87120	18-2093	89160	18-2733	90200	18-9861	S1072M	18-6412		
87130	18-8351	89170	18-2732	90210	18-9857	S1098M	18-6442		
87140	18-8350	89180	18-2747	90220	18-9854	S1663M	18-5906		
87400	18-2649	89190	18-2764	90230	18-9868	S2030M	18-5619		
87410	18-2291	89200	18-2765	90240	18-9842	S2031M	18-5618		
87480	18-2643	89210	18-2763	90260	18-9837	S2032M	18-5602		
87490	18-2645	89220	18-2745	90270	18-9829	S2033M	18-5605		
87500	18-2648	89222	18-2780	90280	18-9819	S2034M	18-5628		
87501	18-2644	89224	18-2779	MARINE ELECTRICAL SUPPLY (MES)				S2035M	18-5623
87510	18-2652	89230	18-2781					MES No.	Sierra No.
87511	18-2646-1	89240	18-4456	1018M	18-5842	S2037M	18-5606		
87513	18-2642	89250	18-4457	1019M	18-5843	S2038M	18-5624		
87520	18-2653	89260	18-4458	1700M	18-5655	S2039M	18-5627		
87530	18-2654	89450	18-3030	1713M	18-5650	S2040M	18-5612		
87540	18-2655	89451	18-3062	1726M	18-5671	S2041M	18-5610		
87550	18-2590	89470	18-3005	1729M	18-5656	S2043M	18-5611		
87561	18-2622	89480	18-3006	1780M	18-5708	S2044M	18-5622		
87562	18-3760	89490	18-3090	1781M	18-5709	S2045M	18-5620		
87573	18-2627	89500	18-3091	1782M	18-5707	S2046M	18-5621		
87574	18-2628	89510	18-3079	1937M	18-5836	S2047M	18-5614		
87575	18-2629	89520	18-3080	1938M	18-5808	S2048M	18-5631		
87576	18-2697-1	89530	18-3075	197M	18-5838	S2049M	18-5632		
87580	18-8371	89540	18-3081	3140M-D	18-5964	S2050M	18-6438		
87590	18-2626	89550	18-3077	3144M	18-5966	S2051M	18-6437		
87600	18-2623	89560	18-3078	3145M	18-5967	S2060M	18-5629		
87601	18-2660	89570	18-3059	3146M	18-5960	S2061M	18-5600		
87602	18-2656	89580	18-3001	3147M-N	18-5950	S2061M	18-5640		
87603	18-2659	89590	18-3299	3147M-R	18-5956	S2062M	18-5601		
87604	18-2679	89592	18-3138	3159M	18-5965	S2063M	18-5604		
87605	18-2682	89593	18-3295	3160M	18-5979	S2064M	18-5636		
87606	18-2684	89594	18-3294	3174M	18-5848	S2065M	18-5635		
87607	18-2686	89595	18-3108	3175M	18-5846	S2066M	18-5648		
87608	18-2689	89596	18-3326	3186M-N	18-5951	S2066M	18-5634		
87609	18-2690	89600	18-3012	3186M-R	18-5957	S2066M	18-5647		
87611	18-2691	89610	18-3060	3200M	18-6454	S2067M	18-5630		
87614	18-2694	89611	18-3061	3201M	18-6455	S2067M	18-5646		
87616	18-2680	89612	18-3044	3202M	18-6288	S2068M	18-5608		
87617	18-2681	89614	18-8903	3203M	18-5983	S2069M	18-5613		
87618	18-2683	89615	18-8901	3204M	18-6293	S2069M-R	18-5644		
87619	18-2685	89620	18-3046	3205M	18-6298	S2070M	18-6418		
87620	18-2663	89621	18-3047	325M	18-5837	S2072M	18-6411		
87621	18-2687	89630	18-3056	3364M	18-5801	S2073M	18-6415		
87622	18-2688	89640	18-3057	3365M	18-5815	S2075M	18-6416		
87630	18-2665	89650	18-3002	3366M	18-5813	T1073M	18-6273-1		
87640	18-2664	89660	18-3083	3367M	18-5803	T1076M	18-6281		
87650	18-2667	89670	18-3003	3368M	18-5802	T1077M	18-6780		
87651	18-2666	89680	18-3043	3369M	18-5807	T1078M	18-6780		
87652	18-2669	89690	18-3055	3371M	18-5819	T1080M	18-6765		
87653	18-2670	89710	18-3053	3372M	18-5818	T1081M	18-6755		
87654	18-2673	89740	18-3087	3373M	18-5820	T1082M	18-6773		
87655	18-2671	89750	18-3051	3374M	18-5835	T1085M	18-6754		
87656	18-2672	89760	18-3086	337M	18-5903	T1086M	18-6759		
87660	18-2698	89770	18-3050	337ML	18-5904	T1087M	18-6772		
87670	18-8360	89780	18-3368	3386M	18-5816	T1088M	18-6769-1		
87680	18-2658	89790	18-3104	3387M	18-5817	T1089M	18-6770		
87690	18-2657	89800	18-3054	338M	18-5916	WP307M	18-3581		
87700	18-2625	89810	18-3039	5075M	18-5920	WP415M	18-3577		
87800	18-2630	89820	18-3052	5275M	18-5901	WP447M	18-3575		
87802	18-2637	89830	18-3007	5275ML	18-5902	WP453ML	18-3599		
87803	18-2632	89840	18-3017	5314M	18-5900	WP520M	18-3584		
87804	18-2638	89850	18-3072						
87805	18-2639	89860	18-3073						
87806	18-2633	89870	18-3066						

GENERATOR PRODUCTS

FISCHER PANDA			Kohler (Cont.)			Westerbeke (Cont.)		
O.E. #	SIERRA #	PAGE #	O.E. #	SIERRA #	PAGE #	O.E. #	SIERRA #	PAGE #
IC78.460.000B	23-1104	103, 123, 125	11-10015	23-0830	109	33417	23-0803	108, 117
IC78.460.000A	23-1105	103, 123	24-22009	23-1102	103	33966	23-0807	108, 115
J009-46840	23-3311	106	24-28003	23-1103	103	34093	23-2800	111
J009-1027B-1	23-3312	106	25-12009	23-2005	105, 124	34113	23-2701	110
JABSCO			25-12009	23-3315	106, 124	34196	23-0802	108, 115, 117
22799-0001	23-2003	105	ONAN			34440	23-3307	106, 114
JOHNSON PUMP			122-0185	23-7841	112, 123	34552	23-5601	113, 114, 116
09-808B-1	23-2001	105, 114, 116, 122	122-0810	23-7840	112	35109	23-5840	104
KOHLER			122-0810	23-7840	112	35595	23-7801	111, 115, 117, 125
26987	23-7762	104, 120, 122	130-4434	23-6401	113, 123	35608	23-2702	110
229432	23-0810	108, 119	130-6228	23-6402	113, 123	35610	23-2801	111
229433	23-0812	109, 119, 121	132-0349	23-3300	105	35736	23-3601	107, 114, 116
229678	23-7822	112, 117, 119	132-0436	23-3309	106	35828	23-7825	112, 115
229715	23-7751	103, 116, 118, 124	149-0428	23-7750	104	35920	23-7720	104, 114, 116
229826	23-2002	105, 116, 118, 120, 122	149-1445	23-7720	104	36450	23-7200	103, 117
229826	23-3303	105, 116, 118, 120, 122	149-2106	23-7760	104	36918	23-7800	111
229955	23-3304	105	185-5835	23-7842	112	37387	23-3602	107, 114, 116
229963	23-0813	109, 117, 119, 121, 123	185-7444	23-7804	111	37922	23-0808	108, 115, 117
249433	23-7771	104, 120, 122	309-0130	23-3606	107	38100	23-7201	103, 115, 117
249865	23-0811	108, 119, 121	541-1519	23-3310	106	39181	23-4000	113
249930	23-3608	107, 120, 122	A026K278	23-7760	104	39378	23-3603	107, 114, 116
250872	23-2003	105	SHERWOOD			39705	23-1101	103, 115, 117, 121
252896	23-3609	107, 118	09000K	23-2002	105, 116, 118, 120, 122	40154	23-7826	112, 115
252898	23-7740	103, 118, 120	10077K	23-2000	105, 114, 116, 122	40434	23-0805	108, 117
260085	23-6400	113	WESTERBEKE			40859	23-2700	110
267709	23-1100	103	11672	23-4001	113	40860	23-2802	111
267714	23-7823	112, 121	11885	23-6400	113	42201	23-2804	111
267717	23-3610	108, 120	11907	23-3301	105, 114, 116	42260	23-0800	108, 115, 117
267718	23-0809	108, 121	13810	23-4005	106	43050	23-2803	111
278857	23-1130	103, 117, 119	24132	23-5880	104, 115, 117	43060	23-4500	111
279449	23-7820	111, 123	24323	23-0806	108, 115	45232	23-4003	113
326817	23-7803	111, 121, 123	24353	23-1000	104, 115	46097	23-3604	107
352018	23-3607	107, 120	24363	23-7764	104, 114	46124	23-0801	108, 115, 117
352031	23-0814	109, 121	24639	23-5800	113, 115	46592	23-2703	110
352122	23-3308	106, 120	24690	23-3605	107, 114, 116	46596	23-4501	111
359771	23-7821	112, 121	26488	23-3600	107, 114, 116	46622	23-3306	106, 114, 116
359978	23-2004	105, 120	30200	23-7770	104, 114, 116	47060	23-7770	104, 114, 116
359978	23-3314	106, 120	30376	23-4007	107	48076	23-7802	111, 115
500190G	23-3314	106, 120	30475	23-4004	113	24688 & 24323	23-3650	109, 115
8000K	23-3314	106, 120	30592	23-4002	113	24688 & 33966	23-3658	110, 115
GM24510	23-7202	103	30593	23-5600	113, 114	24688 & 34196	23-3653	109, 115
GM32359	23-7761	104	30594	23-5900	113, 114	24690 & 33417	23-3657	109, 117
GM34570	23-7780	104	31152	23-4006	107	35736 & 33417	23-3652	109, 117
GM47465	23-7824	112	32620	23-3305	105, 114, 116, 122	35736 & 34196	23-3651	109, 115, 117
			33104	23-3313	106, 114	37387 & 37922	23-3659	110, 115, 117
			33112	23-3302	105, 114, 116	39378 & 42260	23-3654	109, 115, 117
			33373	23-0804	108, 115	39378 & 46124	23-3655	109, 115, 117
						46097 & 33417	23-3656	109, 117

SIERRA MARINE PRODUCTS

A.C. DELCO			Barr (Cont.)			Cerlist Diesel (Cont.)		
O.E. #	SIERRA #	PAGE #	O.E. #	SIERRA #	PAGE #	O.E. #	SIERRA #	PAGE #
GF-61	18-7856-1	130	CHV-47-000	18-2949	491, 534, 552, 559, 563, 671, 778, 843	1512904	18-7934	129
GF-61P	18-7857-1	130				CHRIS-CRAFT		
ARCTIC CAT PWC			CHVA-1-84	18-1898	489, 506, 530, 557, 562, 664, 775, 840	7056	18-1914	488-491
3008-093	18-6919	471	FM-1-83	18-1998-1	489, 530, 551, 561, 562, 664, 775	7686	18-1914	488-491
3008-327	18-6919	471, 472	FM-1-83-P	18-4363	490, 532, 551, 561, 562, 668, 777	1869704	18-5346	480
3008-462	18-6919	471	MC20-60426P	18-4362	668	16.11-01236	18-2845	491, 535, 571-573, 685, 686, 692, 787
3008-536	18-6919	471	BORG-WARNER			16.50-00074	18-0889	491, 552, 570-576, 685, 687-689, 855, 866
BARR			A4876HA	18-2590	477	16.50-00078	18-0891	491, 571-574, 685, 693, 788, 856, 866
01-0105	18-0476	491, 842	BOSCH			16.50-00162	18-0874	491, 570-575, 687, 690, 785, 858, 866
01-0107	18-2854	491, 842	0-001-109-035	18-6944	579	16.50-00204	18-2946	491, 570, 689, 785, 853
20-0082	18-1999	489, 530, 539, 551, 557, 559, 561, 562, 666, 776, 841	0331-302-050	18-5806	825	16.50-00232	18-0868	491, 571-574, 685, 686, 688, 783, 853
20-0082-P	18-4364	490, 508, 532, 539, 551, 557, 559, 561, 562, 668, 776, 777, 841	0331-302-081	18-5806	825	16.50-00250	18-3876	491, 535, 553, 571-574, 685, 686, 689, 785, 854
20-0100	18-1907	489, 506, 532, 539, 557, 559, 561, 562, 667, 776, 841	0331-302-085	18-5806	825	16.50-00259	18-3877	491, 535, 574, 686, 689, 785
20-0100	18-1939	489, 506, 532, 539, 557, 559, 561, 562, 667, 776, 841	0331-302-581	18-5806	825	16.50-05756	18-0876	491, 571-574, 685, 689, 785, 855, 866
20-0102	18-1907	667, 776, 841	0331-302-585	18-5806	825	16.60-00031	18-5712	484, 485
CHV-1-83	18-1964	882-885	CATERPILLAR			16.61-00042	18-5900	484
CHV-1-83	18-1997-1	489, 506, 530, 539, 551, 559, 562, 664, 775, 840	3001117	18-6955	578, 824	16.61-00042	18-5911	484, 598, 605-607, 753, 821
			10-258	18-6955	578, 824	16.69-00039	18-5314	480
			163-3361	18-6944	579	16.69-00040	18-5338	480
			1R-0658	18-7880	152, 155, 581, 848	16.69-00042	18-5411	480, 492, 512
			1R-0714	18-7927	152, 155, 581			
			CERLIST DIESEL					
			1512903	18-7970	129			

Chrysler Inboard (Cont.)			Crusader (Cont.)			Crusader (Cont.)		
O.E. #	SIERRA #	PAGE #	O.E. #	SIERRA #	PAGE #	O.E. #	SIERRA #	PAGE #
2847405	18-1913	501, 507, 508	41058	18-5303	479	7243110	18-5107-1	516
2847480	18-2941	501, 505-508	41059	18-5407	480	7243200	18-5443	516
2847527	18-5710	496	41061	18-5399	512	9002514	18-7875	153
2847623	18-1944	503, 505, 506, 508	41069	18-5353	512	RO29015	18-1938	531
3004886	18-3581	498	41074	18-5403	480	RP061022	18-8926	520
3420600	18-5347	492	41076	18-5352	480	CUMMINS		
3527501	18-5954	496	41080	18-5434	516	160596	18-3078	473
3527502	18-5954	496	41080	18-5435	516	166758	18-3078	473
3527794	18-1946	501, 507, 508	41089	18-5403	480	214169	18-6952	578
3549957	18-7878-1	153, 155, 498	42001	18-5717	517	216040	18-5982	578
3619542	18-3581	498	42090	18-5901	517	299670	18-7874	882-885
3619659	18-1915	503, 506-508	42090	18-5907	517	556540	18-3078	473
3619859	18-3582	498	42091	18-5902	517	556850	18-3078	473
3656017	18-5102	494	42091	18-5908	517	650607	18-3077	474
3675826	18-1940	501, 503, 505-508	45303	18-7200	519	3920618	18-6952	578
3675826	18-1942	501, 505-508	45334	18-7095	518	21601R	18-3078	473
3744870	18-5954	496	47002	18-7600	518	3603853RX	18-6952	578
3745209	18-0608	882-885	47032	18-7630	518	3604234RX	18-5982	578
3745217	18-0607	507	47033	18-7632	518	DELCO		
3745220	18-4346	501, 505, 507	47047	18-7958	520	1100077	18-6952	578
3745414	18-7254	139, 141, 498	67859	18-3577	521, 549, 628, 767, 768, 834	1100093	18-6952	578
3745415	18-7255	139, 141, 498				1100211	18-6952	578
3745639	18-1944	503, 505, 506, 508	91351	18-2845	535	1100274	18-6952	578
3745985	18-3581	498	91606	18-7862	520	1105474	18-6952	578
3780600	18-5103	494	96108	18-0305	523, 527, 531, 534	1105475	18-6952	578
3874020	18-5105	494	96120	18-1925	527, 530-532	1105476	18-6952	578
3874767	18-5451	494	96121	18-1926	527, 530-532	1114356	18-5838	755
4106140	18-5450	494	96216	18-0306	535	1114458	18-5838	755
4142322	18-1940	501, 503, 505-508	96306	18-2949	491, 534, 552, 563, 671, 778	1115202	18-5433	588
4142408	18-5369	492				10459244	18-6952	578
4142817	18-5352	492	96319	18-3551	521	995435	18-6868	470, 472
4142880	18-3860	498	96331	18-0308	882-885	101211-3020	18-6960	605
4142885	18-3551	498	96358	18-3552	521	101211-3021	18-6960	605
4142886	18-7230	498	96562	18-0309	523, 527, 531, 534	101211-3460	18-6844	604
4273129	18-0609	498	96653	18-0418	534, 563, 669, 691, 787	101211-9940	18-6849	578
4417375	18-3878	498	96938	18-2434	476, 517, 553, 601	128000-4860	18-6868	470
4417905	18-3581	498	97039	18-7272	139, 621	128000-4861	18-6868	470, 472
24695566	18-1942	507	97114	18-1929	523, 527, 530-534, 563, 669	128000-4862	18-6868	470, 472
0009231E	18-6601	507				128000-4863	18-6868	470, 472
118-614	18-0956	507	97115	18-1933	523, 527, 530-534, 563, 669	128000-4864	18-6868	470, 472
7087-OR	18-7512	508				228000-4550	18-6867	470
E7081M	18-1915	503, 506	97169	18-1916	523, 527, 531, 532	428000-0081	18-6873	470
E9234M	18-1948	503, 507	97214	18-7231	519	DETROIT DIESEL		
E9923M	18-1944	503, 506	97296	18-1917	523, 527, 534	5574508	18-7931	129
L-1008	18-7878-1	153, 498	97361	18-3671	521	25010495	18-7899	152, 155, 581
L-19	18-7878-1	153, 155, 498	97386	18-1918	523, 527, 531, 532	ELECTROLUX		
CRUSADER			97387	18-1919	523, 527, 531	5024/120	18-6758	826
12525	18-5310	480	97498	18-2909	534	KS3448/290	18-6790	826
12526	18-5344	480	97595	18-7231	519	FORCE		
12528	18-5384	513	97624	18-1924	523, 527, 531	F664068	18-3527	193
12530	18-5338	480	97686	18-0311	535	FRAM		
12531	18-5411	480	97752	18-1925	527, 530-532	CCS 1136	18-7935	129
12532	18-5375	480	97753	18-1926	527, 530-532	GENERAC		
17670	18-3577	521, 549, 628, 767, 768, 834	97772	18-1927	523, 527, 531, 533	10257778	18-7939	129, 420
			97854	18-8112	523, 525, 527, 529, 532	GM		
			97895	18-3649	521	3701777	18-2917	785
20117	18-5314	480	97924	18-1928	523, 527, 531, 532, 534	6269358	18-3577	767
20129	18-0976	535	97992	18-1929	523, 527, 530-534, 563, 669	6269577	18-3876	553
20222	18-5376	480				6414989	18-7258	139
20223	18-5404-1	480	97993	18-1933	523, 527, 530-534, 563, 669	10482803	18-5117	588
20300	18-3061	520				14077948	18-4173	781, 850
20309	18-3168	521	98041	18-7846	520	14077949	18-4164	781, 850
20310	18-3061	520	98068	18-1934	523, 527, 531, 532	14089025	18-3937	781, 850
20318	18-3583	521	98125	18-1982	525, 530-532, 534, 563, 669	14089026	18-3938	781, 850
20502	18-3140	520				HITACHI		
21140	18-7270	139, 621	98126	18-1938	525, 529, 531, 533, 534, 563, 669	LR180-03A	18-6929	578
21141	18-7271	141				129470-77200	18-6929	578
22212	18-3060	520	98128	18-1984	525, 529, 532	LR135-105	18-6925	578
22687	18-7852-1	520	98243	18-1983	529-532, 534	LR135-74	18-6928	578
23250	18-7976	520	201104	18-7824	153	LR135-74B	18-6928	578
30103	18-3577	521	201104	18-7876	153	LR180-03B	18-6929	578
30184	18-3940	882-885	700425	18-5899	521	LR180-03C	18-6929	578
30185	18-3941	Obsolete	700427	18-5898	521	S114-257	18-6880	578
30266	18-3877	535	705786	18-5427	512	S114-257G	18-6880	578
31136	18-3887	535	705787	18-5345	480	S114-303	18-6937	579
31137	18-3874	535	705788	18-5307	511	S114-303A	18-6937	579
32722	18-7256	139, 621	707125	18-5717	517	S114-483	18-6880	578
33393	18-4408	534	811573	18-3577	521, 549, 628, 767, 768, 834	S114-483A	18-6880	578
33408	18-3879	535				S114-559B	18-6861	413
33628	18-7232	519, 565, 620	1003026	18-3060	520	S114-682	18-6942	413
37061	18-5313	515	1003062	18-3046	520			
37068	18-5433	516	1003317	18-5375	480			
37068	18-5438	516	1003318	18-5411	512			
38070	18-5354	512	3000121	18-5389	512			
38071	18-5405	512	3000122	18-5420	512			
40057	18-3169	521	3000124	18-5318	511			
41052	18-5369	512	7057500	18-3876	535			
41057	18-5345	480	7142520	18-3583	521			

Mercury Marine (Cont.)			Mercury Marine (Cont.)			Mercury Marine (Cont.)		
O.E. #	SIERRA #	PAGE #	O.E. #	SIERRA #	PAGE #	O.E. #	SIERRA #	PAGE #
35329	18-4492	567, 676	758321	18-2174	713	8107492	18-7213	322
35915	18-3759	723	774811	18-2150	724	8107493	18-7214	322
35983	18-4296	699, 701, 715	803148	18-7757	588	8168112	18-3752	715
37721	18-0539	355, 365, 369	803149	18-7697	608	8227731	18-0202-9	380
38547	18-5433	303, 588	803470	18-7878-1	153	8503991	18-3583	628
41639	18-7230	620	804184	18-7382	617	8503991	18-3599	628
41815	18-7879	153	805100	18-3784	728	8504541	18-3577	628
42785	18-5740	605	805629	18-5021	668	392881732	18-7648	588
43433	18-2149	718, 719	806105	18-6079	735	392889925	18-7493	588
43436	18-3754	719	806105	18-6093	735	811637001	18-5107-1	588
43585	18-1730	337	806105	18-6093A	735	833072003	18-3536	335
43713	18-2724	715	806189	18-6067	735	833072004	18-3537	335
46895	18-3139	337	806189	18-6067A	735	850055001	18-3534	335
47594	18-3557	634	806189	18-6114	735	879194002	18-7006-1	321
47638	18-1995	668	806190	18-6089	735	881693004	18-7698	609
47886	18-5808	313	806190	18-6092	735	885599004	18-3535	335
48752	18-3114	337	806190	18-6092A	735	892615002	18-7646	608
48753	18-3115	337	808483	18-5354	587	898253003	18-5345	586
52699	18-3750	882-885	808484	18-5405	586	898253007	18-5318	586
52731	18-7876	153	808500	18-2641	616	898253008	18-5418	586
54111	18-7824	675	809064	18-7748	616	898253009	18-5402	586
54705	18-3107	337	809065	18-7749	616	898253010	18-5405	586
56045	18-6841	604, 757	809066	18-7664	617	898253011	18-5406	586
56045	18-6842	604, 757	809569	18-7380	617	898253012	18-5408	586
56153	18-1401	676	809910	18-0612	675	898253013	18-5245	586
57380	18-5650	320	811573	18-3577	521, 549, 628, 767, 768, 834	27-13461A99	18-4340	354, 359
57882	18-7232	519, 565, 620				27-14697A87	18-4339	354, 359
58033	18-5318	586	811618	18-6751	308	27-41499A87	18-4334	353, 359
58034	18-5346	586	811628	18-6774	309	27-43004A99	18-4336	353, 359
58217	18-5418	586	811635	18-5361	587	27-812867A97	18-4337	354, 359
59078	18-3550	634	811636	18-5406	586	27-814754A00	18-4338	882-885
59137	18-3551	634	811639	18-5108	588	47-43026T11	18-3214	338
59369	18-2165	377, 728	811841	18-3599	628	47-43026T6	18-3214	338
59755	18-6841	604, 757	815471	18-2145	718	47-43026T8	18-3214	338
59755	18-6842	604, 757	815471	18-2145E	718	50-859168T	18-6829	319
60207	18-4008	668	816597	18-3151	337	88183A5	18-6813	603
60565	18-7875	153	816607	18-1728	717	10-14834A1	18-2375	377, 728
60658	18-3583	628	816685	18-3749	715	10-14834A1	18-2375-9	377, 728
60930	18-2727	629	816770	18-5707	313	10-20518	18-2303	719
61851	18-1906	667	817276	18-3122	193, 337	10-28668	18-3229	629, 699, 701, 715
62092	18-7267	139, 621	817377	18-5475	591	10-30206	18-2361	695
64850	18-5317	586	817378	18-5443	588	10-30720	18-3226	629, 633, 703, 705
65864	18-5420	586	821509	18-5852	314	10-31700	18-2163	715, 719
67859	18-3577	521, 549, 628, 767, 768, 834	821629	18-6080	735	10-32470	18-6245	383
			821629	18-6080A	735	10-43749	18-8410	668
68575	18-5656	320, 321	821629	18-6099	735	10-44387	18-8411	668
69729	18-6841	604, 757	821630	18-6094	735	10-45590	18-2170	715
69729	18-6842	604, 757	821630	18-6094A	735	10-76156	18-3197	373, 629, 695, 703, 705
69729	18-5950	604	821630	18-6240	735			
69729	18-5956	604	821663	18-6960	605	10-79953A2	18-2244	377
70977	18-3113	337	821663	18-6449	Obsolete	10-79953Q 2	18-2244	377
72638	18-1402	676	823033	18-5182	303	10-8053432	18-8402	601
74639	18-2753-2	717	823728	18-7749	616	10-8053433	18-8403	601
75384	18-5697	320	824051	18-6784	310	10-8083434	18-8404-1	601
75660	18-5674	221, 320, 321	824519	18-2346	723	10-816601	18-3230	695
75692	18-3553	335, 336, 344, 345	826134	18-6068	207, 382, 735	10-86801	18-1706	714
76214	18-6016	382, 383, 707, 734	828151	18-5849	314	10-93886	18-1342	Obsolete
76214	18-60161	382, 734	828708	18-6773	309	10-97934	18-3729	695
76214	18-6016A	382, 734	834832	18-6844	604	10-97934A1	18-2141	695
76214	18-6244	382, 734	835076	18-7749	616	10-98794	18-3231	695
76270	18-3552	634	849896	18-7686	608, 610	11-13439-1	18-3721	695
76865	18-2130	724	849899	18-7683	608	11-20361	18-3722	373, 380, 705, 731
77123	18-1705	714	849934	18-7682	608	11-22339	18-3713	699, 701, 714
77987	18-4220	382	850399	18-3599	628	11-34932	18-3720	380, 731
78016	18-5420	586	850454	18-3574	628	11-34933	18-3721	369, 373, 380, 731
78249	18-2143	353	850484	18-5362	587	11-35888	18-3722	380, 633, 705, 731
78477	18-5951	604	850485	18-5408	586	11-35921	18-2359	378, 723
78477	18-5957	604	853292	18-5852	314	11-35921	18-3719	378, 723
78687	18-2144	353	854445	18-7668	608	11-45592	18-3723	380, 731
79448	18-3751	380, 724	858763	18-7083	331	11-45812	18-2344	Obsolete
85552	18-2742	198, 383, 384	859168	18-6829	319	11-52707	18-3700	381
86177	18-5658	320, 321	861578	18-8297	676	11-52707A1	18-3701	381, 728
86246	18-7274	139, 621	862209	18-1710	717	11-52707Q1	18-3701	381
86247	18-7275	139, 621	862998	18-7701	608	11-69578	18-3704	381
87581	18-5315	592	881540	18-7979	334	11-69578A1	18-3702	381
88035	18-2372	731	881731	18-7660	608	11-69578Q1	18-3702	369, 381
89902	18-5838	601	882571	18-6948	579, 605	11-69578T1	18-3702	369, 381
90806	18-5899	640	883885	18-3584	628	11-826711 27	18-3785	728
90880	18-1905	666	883925	18-3573	628	11-859116	18-3721	695
93322	18-1908	667	884727	18-3593	628	11-859131	18-3783	728
93322	18-1985	667	884790	18-5245	586	11-862907	18-3786	728
93476	18-0613	675	884792	18-5244	586	11-863332	18-3728	695
94576	18-3350	629, 630	885174	18-7662	608	11-88228	18-3703	381
94916	18-3351	629, 630	885176	18-7688	609	11-99298	18-3728	695
97351	18-2707	724	888731	18-5243	586	11497M	18-7833	327
99186	18-6273-1	309	893409	18-3607	382	11502M	18-7765	323
621041	18-2322	715	934231	18-3199	724	12-12577	18-1191	371, 374
681001	18-2342	723	934241	18-3198	724	12-19183	18-2945	365

Mercury Marine (Cont.)			Mercury Marine (Cont.)			Mercury Marine (Cont.)		
O.E. #	SIERRA #	PAGE #	O.E. #	SIERRA #	PAGE #	O.E. #	SIERRA #	PAGE #
12-19183 2	18-2945	365	1395-811691 3	18-7356	321, 326	15-36178A1	18-2293	708
12-20260	18-2945	365	1395-8236354	18-7750-1	323	15-42637A1	18-2294	708
12-29245	18-4275	366	1395-8318	18-7061	323	15-45691A1	18-2283	708
12-29395	18-4267	695	1395-83181	18-7061	323	15-47397A1	18-2285	373, 708
12-31211A2	18-3714	380, 724	1395-8506	18-7354	321	15-57007A1	18-2295	373, 708
12-31266	18-2340	695	1395-8673	18-7208	323	15-71013	18-2296	708
12-32834	18-0681	695	1395-879194024	18-7006-1	321	15103A3	18-1137	882-885
12-34961	18-9805	882-885	1395-8983	18-7208	323	1547-861063A10	18-2417	709
12-35935	18-0203	695	1395-9022	18-7295	323	1547-861063A12	18-2416	709
12-36001	18-4270	373, 632, 633, 695, 703, 705	1395-9024	18-7215	322	1547-861063A4	18-2411	708
			1395-9258	18-7057	323	1547-861063A6	18-2419	709
12-45176	18-4858-9	365	1395-9258 1	18-7057	323	1547-861063A8	18-2418	709
12-45810	18-3712	699, 701, 714	1395-9293	18-7209	323	1547-9412A20	18-2450	709
12-49221	18-2948	365, 694	1395-9594	18-72000	323	1547-9412A21	18-2451	709
12-49221-1	18-2948	365	1395-95951	18-7062	323	1547-9412A22	18-2452	709
12-77674	18-2316	695	1395-9650	18-7226	322	1547-9412A23	18-2453	709
12-815472	18-0318	695	1395-97611	18-7212	322	16-49545	18-3233	882-885
12-835467 1	18-4220	382	1396-4148	18-7227	617	16061T	18-5792	304
12-855682-2	18-9078	382	1396-4656	18-7081	616	16064A1	18-5185	303
12-86645	18-2560	365	1396-5222	18-7096	616	1623-5356A4	18-2402	882-885
12-86645 1	18-2560	365	1396-5238	18-7096	616	1623-815822A36	18-2415	707
12-88263	18-1186	350	1397-2060	18-7200	616	1623-815822A53	18-2400	708
12-92721	18-2343	695	1397-2072	18-7070	615	1623-8951A27	18-2401	710
12-92721	18-2359	378, 723	1397-2150	18-7855	627	1623-8951A43	18-2443	709
12076A2	18-1975-1	667	1397-2605	18-7078	616	16457A4	18-5395	587
12449A1	18-5966	604	1397-2637	18-7070	615	1647-9148R84	18-4851	379
12632A6	18-2321	720	1397-3306	18-7072	616	1647-9148T93	18-4832	379
12632A7	18-2195	719	1397-3327	18-7201	617	1667-9011G59	18-4830	379
12644A1	18-4457	99, 737	1397-3458	18-7071	615	1667-9011R6	18-4850	379
12784A10	18-6401	713	1397-3464	18-7070	615	16755A1	18-2615	696
13-888363-2	18-9077	382	1397-4329	18-7072	616	16755Q1	18-2615	696
13191A1	18-4221	371, 382	1397-5635	18-7072	616	16755T1	18-2615	696
13310T1	18-5674	320, 321	1397-5830	18-7075	615	16792A39	18-7508	676
13330A3	18-8005EP-1	130, 136, 330	1397-5831	18-7075	615	17-14872A1	18-2463	732
13330A3	18-8005S	130, 136, 330	1397-5837	18-7202	617	17-14873A1	18-2462	731
13330Q	18-8005EP-1	130, 136, 330	1397-6367	18-7076	616	17-30632	18-2357	371, 705, 707, 722
13330Q	18-8005S	130, 136, 330	1397-6367A1	18-7076	618	17-35973	18-3227	337
13330Q5	18-8005EP-1	330	1397-6638	18-7072	616	17-44166	18-2396	733
1347-804623A1	18-7605-1	143, 611	1397-7099	18-7075	615	17-44166T1	18-2461	731
1347-804623R02	18-7604-1	142, 144, 611	1397-7539	18-7095	616	17-44167A1	18-2397	733
1347-804623R02	18-7605-1	143-145, 611, 613, 759, 760	1397-7542	18-7070	615	17-45735	18-2152	733
			1397-7542	18-7070	615	17-45738	18-2151	733
1347-804624 R02	18-7615-1	143, 145	1397-7543	18-7070	615	17-815953	18-2395	733
1347-804624 R02	18-7618-1	143, 144, 612-614	1397-7544	18-7095	616	17-815953T1	18-2464	732
1347-804624 R1	18-7618-1	143, 144, 612-614	1397-8535	18-7095	616	17-828507 1	18-15129	317
1347-804624R1	18-7615-1	143, 145	1397-8545	18-7869	627	17177A1	18-5313	592
1347-804625 R02	18-7617-1	143, 144, 612, 614	1397-8546	18-7201	617	17649T	18-6772	703
1347-804625 R1	18-7617-1	143, 144, 612, 614	1397-8582	18-7666	617	18311A17	18-2412	620
1347-804626 R02	18-7616-1	143, 144, 612, 614, 615	1397-8760	18-7075	615	18495A26	18-5790	185, 304
			1397-8767	18-7869	627	18525A1	18-6771	308, 603
1347-816373A4	18-7615-1	142-145, 611, 612, 614, 759	1397-8872	18-7070	615	18643A5	18-2323	720
			1397-8952	18-7077	616	18643A7	18-2175	719
1347-818619	18-7609-1	143, 144, 611	1397-8959	18-7201	617	18654A1	18-2750	716, 717
1347-818619 1	18-7609-1	143-145, 611, 612, 759, 760	1397-9723	18-7095	616	19-14842	18-2465-9	731
			1398-3089	18-7080	616	19-32652	18-4272	695
1347-818619 1R02	18-7609-1	143-145, 611, 612, 759, 760	1399-1138	18-7057	323	19-42682	18-4273	695
			1399-1473	18-7057	323	19-47579	18-3232	733
1347-818620	18-7608-1	143, 144, 611, 613	1399-1717	18-7006-1	321	19-815951	18-2466-9	731
1347-818620 1	18-7608-1	143-145, 611-613, 759, 760	1399-2015	18-7006-1	321	19052A8	18-5791	304
			1399-3523	18-7006-1	321	19217A1	18-6777	188, 309
1347-818620R02	18-7608-1	143, 611-613	1399-3938	18-7832	334	19217A5	18-6777	188, 309
1347-818621	18-7610-1	143, 611	1399-5135	18-7007	322	19291A3	18-2370	198, 375
1347-818621 1	18-7610-1	143, 144, 611, 612	1399-5137	18-7815	327	19543A10	18-2190	718
1347-818621 1R02	18-7610-1	143, 144, 611, 612	1399-5198	18-7007	322	19543A10	18-2190E	718
1347-818622	18-7603-1	142, 611	1399-5207	18-2910	882-885	19543A4	18-2157	718, 719
1347-818622 1	18-7603-1	142, 144, 611, 613, 614	1399-99	18-2575	360	19543A4	18-2190	718, 719
			14-18323	18-2298	380, 731	19543A4	18-2190E	718, 719
1347-818622R02	18-7603-1	142, 611, 614	14-31210	18-3200	381	19543T1	18-2603	719
1347-8288A1	18-7616-1	143, 144, 147, 612, 614, 619	14-34817	18-3788-9	728	19543T1	18-2603E	719
			14-76281	18-3204	369, 381	19755A2	18-2286	723
1347-8289A1	18-7618-1	143, 144, 612-614	14-79447	18-2299	380, 724	19755A4	18-2196	723
1347-8460A3	18-7619-1	147, 612, 618	14-816629	18-3200	381, 728	21-42990A10	18-7817	358
1347-9142A2	18-7619-1	143-145, 612, 613	14034A3	18-2420	732	21-42990A7	18-7817	327
1347-9661A3	18-7605-1	143, 144, 147, 611, 613, 618, 619	14035A3	18-2421	732	21-42990A8	18-7817	327
			14244T	18-0616	675	21-42990A9	18-7817	355-357
1347-9863A3	18-7617-1	143, 144, 612, 614	14336A15	18-6813	603	21-857005A1	18-7817	189, 327, 353, 354
13524A5	18-5431	586	14336A20	18-6813	603	22-13563A3	18-8076	331
13524A6	18-5432	586	14336A20	18-6274	310, 603	22-13563Q3	18-8076	331
13524T1	18-5431	586	14336A6	18-6813	603	22-13563Q7	18-8091	331
13753A2	18-5396	587	14336A8	18-6813	603	22-13563T3	18-80410	331
1376-5659A1	18-7603-1	142, 144, 611, 613, 614	14336A8	18-6769-1	603	22-13563T7	18-8091	331
			14336A9	18-6813	603	22-14213M	18-8075	331
1395-4808	18-7006-1	321	14336A9	18-6752	602	22-14213Q	18-8075	331
1395-6200	18-7004	321	14336A9	18-6753	602	22-16951A1	18-4218	671
1395-6452	18-7005	321	14505A2	18-2172	720	22-16951Q1	18-4218	490, 508, 533,
1395-7824	18-7233	323	15-31535A1	18-2284	708			552, 671, 776, 843
1395-8112231	18-7211-1	322	15-32563A1	18-2282	708	22-16951T1	18-4218	671
1395-811691 2	18-7355	321, 326	15-35980A1	18-2292	708	22-32802	18-4263	668

Mercury Marine (Cont.)			Mercury Marine (Cont.)			Mercury Marine (Cont.)		
O.E. #	SIERRA #	PAGE #	O.E. #	SIERRA #	PAGE #	O.E. #	SIERRA #	PAGE #
22-328022	18-4263	668	25-29845	18-7103	739	26-32121	18-2017	388, 738
22-32803	18-4264	668	25-29976	18-7157	739	26-32511	18-2049	738
22-33198A1	18-4258	563, 668	25-30224	18-7173	391	26-32511A1	18-2648	736
22-36305	18-8216	671	25-30271	18-7426	391	26-32911	18-0517	388, 738
22-36382	18-8111	668	25-30529	18-7171	384, 391, 739	26-33144A2	18-2652	722, 736
22-41622	18-4258	668	25-30613	18-7158	739	26-33467	18-2006	738
22-428611	18-4265	668	25-31305	18-7172	391, 739	26-34217	18-0518	388, 683, 685, 686
22-63186	18-8054	135, 330	25-31534	18-7159	739	26-36556	18-0563	365, 736
22-63187	18-8055	135, 330	25-31986	18-7160	739	26-36557	18-0521	365
22-67892A1	18-2375	377, 728	25-32509	18-7165	391, 739	26-38970	18-3110	337
22-67892A1	18-23751-9	377, 728	25-32546	18-7161	739	26-41131	18-0579	388
22-806608A1	18-4226	671	25-33145	18-7162	808	26-41132	18-0580	388
22-806926	18-4227	671	25-33465	18-7163	383, 391, 630, 736, 739	26-41365	18-0581	386, 388
22-806926A1	18-4224	671				26-41365A3	18-2697-1	199, 386
22-807155	18-4461	563, 671	25-33466	18-7164	391	26-41953	18-2016	388, 738
22-816856T2	18-80412	331	25-33504	18-7170	739	26-421021	18-2728	365
22-87238	18-4218	671	25-35027	18-7117	739	26-43035	18-0583	388
22831A3	18-8069	331	25-35029	18-7121	739	26-43035A4	18-2626	198, 383
22831Q3	18-8069	331	25-35276	18-7135	198, 383, 384, 391, 739	26-43036	18-0522	198, 371, 383, 388, 738
23-11992	18-1327	679	25-35480	18-7411	739			
23-1761515	18-0208	882-885	25-36318	18-7440-1	391	26-43993	18-0523	388, 738
23-1761516	18-0210	882-885	25-36390	18-7410	882-885	26-45577	18-2944	694
23-1761517	18-0212	882-885	25-38933	18-7120	739	26-45587	18-0525	388, 738
23-1761518	18-0214	882-885	25-39695	18-7464	391, 739	26-48443	18-0526	388, 738
23-1761520	18-0218	882-885	25-45253	18-7165	391, 739	26-55682	18-2050	388, 738
23-1761522	18-0222	882-885	25-45254	18-7166	391, 739	26-55682A1	18-2653	385
23-1761523	18-0224	882-885	25-45710	18-7198	198, 353, 354, 371, 383, 391, 696, 735, 739	26-56397	18-0527	388, 738
23-1761524	18-0226	882-885				26-56788	18-2008	388, 738
23-29804	18-3109	337				26-56866	18-1230	882-885
23-29804T	18-3109	337	25-45711	18-7174	739	26-56868	18-0528	683
23-30617A2	18-2154	724	25-47254	18-7961	354, 356, 357, 391	26-58203	18-1211	683
23-32632	18-3236	695	25-47632	18-7146	391, 739	26-59341	18-1213	683
23-43045	18-0568-9	366	25-48171	18-7168	391	26-62818	18-0529	388, 738
23-43293	18-1339	679	25-53421	18-7177	391, 739	26-66022	18-0584	199, 200
23-67370	18-2349	694	25-54029	18-0858	353, 354, 358, 391, 739	26-66302	18-2056	388, 701, 735, 736
23-67484	18-1340	882-885	25-54030	18-7467	391, 739	26-66303	18-0595	383, 388
23-77631A2	18-2155	377	25-55801	18-7445	739	26-66303A1	18-2627	383
23-801793	18-1311	679	25-60342A2	18-2291	732	26-67388	18-0578	683, 738
23-801803	18-1320	882-885	25-62700	18-0860	739	26-68493	18-2003	738
23-805041A2	18-2622	715	25-62702	18-7413	391	26-69188	18-2051	388, 738
23-806036A1	18-3760	715	25-62704	18-7116	199, 384	26-69189	18-2052	388, 738
23-807073	18-4288	733	25-62705	18-7105	353, 354, 391, 696, 735, 739	26-70081	18-2053	198, 371, 373, 383, 385, 388, 738
23-811858	18-1337	679						
23-815921A21	18-2353	724	25-62706	18-7102	391, 735	26-72785	18-0531	388, 738
23-815950	18-2341-1	733	25-62817	18-7175	739	26-75413	18-4023	683
23-815950	18-2341-1-9	733	25-64067	18-7414	353, 354, 357, 391, 739	26-75988	18-4022	683
23-8159501	18-2341-1	733				26-76384	18-2054	388
23-8159501	18-2341-1-9	733	25-64068	18-7145	357, 391, 739	26-76868	18-2002	198, 371, 373, 383, 385, 388, 703, 705, 735-738
23-816583	18-3222	629	25-64966	18-7415	357, 391, 739			
23-818465	18-1300	679	25-65936	18-7143	357, 391, 739			
23-818469	18-1317	679	25-67202	18-7107	391, 739	26-76868A2	18-2645	736
23-818471	18-1316	679	25-69202	18-7419	391	26-77066A1	18-2628	384
23-818473	18-1315	679	25-70937	18-7169	739	26-79223	18-1213	683
23-818477	18-1314	882-885	25-805726	18-7188	383, 391, 739	26-79831	18-2055	369, 385, 388, 738
23-85677	18-1329	679	25-8071341	18-1508	363	26-79831A1	18-2654	369, 385
23-85691	18-1333	679	25-818573	18-7400	358	26-811554	18-1234	683
23-85701	18-1308	679	25-823683	18-7414	391	26-814669A2	18-2635	199, 384
23-85704	18-1309	679	25-85549	18-7956	291	26-814754	18-8305	354, 358, 366
23-85705	18-1341	679	25-85594	18-7100	291	26-81607M	18-2731	882-885
23-85726	18-1334	679	25-87400A2	18-2649	732	26-816464	18-2054	198, 383, 385, 388, 738
23-88690-1	18-9076	382, 429	25-88198	18-7472	882-885			
23-88690	18-9075	382	25-897536	18-7113-9	335	26-816575A2	18-2599	342, 383, 384, 632, 707, 715
23-89574	18-2701	733	25-8M0027717	18-7195	882-885			
23-89574	18-2701-04	733	25-90011	18-7176	391	26-816575A3	18-2646-1	385, 707, 735
23-90203	18-2336	733	25-94288	18-7474	391, 739	26-816575A4	18-8382	386
23-99291	18-2702-04	733	25-97386	18-7167	371, 391, 735, 739	26-816575A5	18-2642	384
23-99291	18-2702-1	733	25-97386	18-7961	371, 391, 735, 739	26-821309	18-3013	337
23-99291T	18-2702-04	733	25-97387	18-7449	739	26-821310	18-3014	337
23-99291T	18-2702-1	733	25-F40342	18-7134	739	26-821928	18-0585	386, 388
23014A1	18-7804	327, 356	25-F84305	18-7127	739	26-8219471	18-1233	683
24-17997A1	18-2715	701, 715, 735, 736	25661 1	18-5836	314	26-82233M	18-0296	386, 388
24-29340A1	18-6506	366	25661 T1	18-5836	314	26-82234M	18-0297	386, 388
24-29340T1	18-6506	366	26-12224	18-2076	388, 738	26-82257M	18-0267	386, 388
24-30893	18-2348	371, 703, 705, 707, 722	26-14077	18-2077	388, 738	26-823894	18-2003	388, 736
24-46312	18-4252	733	26-14240	18-0519	738	26-830749	18-2430	365
24-824326	18-1238	687	26-16709A2	18-2643	735	26-830749	18-24301-9	365
25-20081	18-7151	355, 356, 391, 739	26-16977	18-2013	738	26-830749A01	18-2725	386
25-20415	18-7421	391	26-16977	18-2026	738	26-83406M	18-0296	386, 388
25-20826	18-7459	391, 739	26-20070	18-2004	738	26-84813M	18-0554	386, 388
25-20863	18-7152	354, 391, 739	26-23517	18-2015	388, 738	26-85090A1	18-2629	199, 384
25-21836	18-7153	391	26-24590	18-2048	388, 738	26-85090A2	18-2624	198, 383
25-23145	18-7114	391, 739	26-25329	18-0514	365	26-85107	18-0537	388, 738
25-25439	18-7420	391	26-26805	18-2019	383, 388, 738	26-864319	18-3289	694
25-26543	18-0175	739	26-27163	18-2019	388, 738	26-88397A1	18-2644	736
25-26722	18-7115	739	26-30530	18-0515	388, 738	26-88416	18-2094	694
25-26802	18-7180	383, 384, 391, 739	26-30696	18-8308	388	26-888483	18-0564	388
25-26855	18-7155	739	26-30900	18-8310	388	26-89236	18-2009	388, 705, 707, 738
25-29439	18-7156	384, 391, 739	26-30913	18-0516	388, 738	26-892361	18-2009	388, 738

Mercury Marine (Cont.)			Mercury Marine (Cont.)			Mercury Marine (Cont.)		
O.E. #	SIERRA #	PAGE #	O.E. #	SIERRA #	PAGE #	O.E. #	SIERRA #	PAGE #
26-89238	18-2014	388	27-385011	18-0879	362	27-60715	18-0354	689
26-89238A2	18-2655	385	27-39401	18-0333	362	27-62386	18-0182	335, 353-355, 357, 358, 363
26-896600	18-0560	388	27-39402	18-0334	362			
26-90562	18-2011	369, 385, 388, 738	27-39623	18-2827	339, 342, 364, 383	27-628601	18-0988	363
26-90925	18-0864	683, 687	27-39625	18-2828	339, 342, 364, 383	27-63309	18-2572	359
26-94038	18-2007	388, 738	27-39915	18-2819	670	27-64203A75	18-4351	356
26-96063	18-2010	388	27-39923	18-1210	670	27-64692	18-0356	661, 685, 689
26-96503	18-2056	738	27-41245-1	18-3872	358	27-64763A2	18-4391	686
26-965031	18-2056	388, 738	27-41246-1	18-3862	354, 355, 358	27-64798	18-0407	688
26-97335	18-1213	683	27-41382	18-2837	362	27-64818	18-2820	693
26-97530	18-0172	738	27-414172	18-2710	360	27-64818A1	18-2614	696
26-97664	18-4024	683	27-414181	18-2712	360	27-64818A3	18-2619-1	696
26-99325	18-0586	198-200, 383, 386, 388	27-41475-8	18-2717	362	27-64818Q4	18-2614	696
27-11338	18-2513	354, 355, 358, 360	27-41499-5	18-2714	362	27-64818Q4	18-2820	696
27-11338A88	18-4319	355	27-414991	18-2716	362	27-64818T1	18-2614	696
27-11977	18-4408	684	27-41610	18-0467	690	27-65184	18-0465	686
27-11977A88	18-4388	686	27-41670-3	18-0336	362	27-65577	18-0357	689
27-11977A92	18-4388	686	27-41670-5	18-0336	362	27-657443	18-0129	360
27-11986	18-3879	689	27-41812	18-2554	634, 685, 686, 690	27-65788	18-2806	361
27-11988	18-0311	692	27-41813	18-0897	670	27-661021	18-0912	362
27-11999	18-2845	686, 692	27-41899M	18-2785	386, 387	27-66847	18-0914	357, 363
27-12775-2	18-0866	360	27-42206	18-2559	363	27-672751	18-0359	360
27-13687	18-3877	689	27-42457A1	18-4377	688	27-67751	18-2509	355, 358, 359
27-13709T	18-3878	687, 689	27-426311	18-2919	365, 694	27-68714A6	18-4380	688
27-138651	18-1237	687	27-43004-7	18-2741	362	27-68715	18-0956	687, 692
27-13937-6	18-0320	353, 354, 360	27-430057	18-2740	361	27-692381	18-2835	363
27-139581	18-2621	360	27-43006-2	18-0339	353, 354, 363	27-695242	18-0918	360
27-14247	18-0322	694	27-430075	18-0670	362	27-69524A75	18-4352	359
27-14247-1	18-0405	687	27-430086	18-0341	362	27-695252	18-0131	360
27-14250	18-0976	685, 692	27-430331	18-2564	363, 371, 693	27-70142	18-0360	690
27-14318 3	18-0323	363	27-430341	18-2563	363	27-70143-1	18-0994	685, 687, 690
27-14318-2	18-0323	363	27-430472	18-2565	363, 371, 694	27-703351	18-0922	361
27-146972	18-0644	360	27-43186A1	18-4381	687	27-70905	18-0158	687, 691
27-14765	18-25001	692	27-433374	18-2713	362	27-721421	18-2573	361
27-14901A1	18-0466	687	27-437772	18-2810	362	27-72479A5	18-4366	687, 688
27-15172-3	18-0324	353	27-437792	18-2809	361	27-72486A32	18-4353	356
27-151724	18-0324	359	27-43779A87	18-4326	353	27-72622	18-3881	570, 689, 785
27-167371	18-0645	360	27-443284	18-2943	361	27-733771	18-2804	359
27-17145	18-0868	685, 686, 688	27-46401	18-2830	670	27-73398	18-0363	882-885
27-17467	18-0664	692	27-46401A1	18-4396	685	27-73645	18-0926	356, 361
27-18272	18-0881	670	27-46820	18-0418	563, 651, 669, 684, 685, 691	27-73645A87	18-4354	356
27-18307-1	18-0643	358, 362				27-73665	18-0133	356, 360
27-183076	18-0643	362	27-46820A1	18-4397	685	27-73666	18-0685	689
27-18785-1	18-3861	358	27-47257	18-2846	363	27-73814	18-0928	685, 687, 691
27-18786-1	18-3871	358	27-47453	18-3881	689	27-73866	18-0183	563, 659, 669, 691
27-188891	18-0624	882-885	27-47453A1	18-4389	686	27-74830	18-2843	634, 687, 690
27-18937	18-3828	358	27-47510	18-2553	634, 685, 686, 690	27-74830A3	18-4382	687
27-18937M	18-3828	358	27-475901	18-2831	690	27-75450	18-0365	691
27-190503	18-0642	361	27-476441	18-0342	694	27-75483	18-0611	688
27-190506	18-2735	362	27-48042	18-0885	670	27-75611	18-3876	685, 686, 689
27-19138	18-3804	358, 443, 444	27-480431	18-2832	670	27-75611A03	18-1254	358
27-19138M	18-3804	358	27-481641	18-2802	359	27-75611A2	18-4392	686
27-19202	18-2559	363	27-48399	18-0462	690	27-75647	18-3883	689
27-19204-2	18-2558	363	27-488181	18-2844	690	27-75648	18-0410	688
27-192061	18-0633	359	27-49110	18-0903	688, 693	27-757911	18-2800	359
27-194541	18-2593	364	27-49121	18-0464	692	27-75909	18-0369	362
27-19551	18-2824	364	27-49936	18-0346	692	27-76636	18-0151	361
27-19552	18-2841	364	27-49949	18-0340	687	27-768621	18-0932	361
27-19553	18-2823	364	27-49953	18-0887	688, 692	27-76952	18-0101	356, 359
27-19701	18-0622	365	27-49955	18-0905	685, 694	27-77417	18-2841	338, 340, 341, 356, 357, 364, 385
27-25848	18-2568	360	27-52145	18-0347	692			
27-25849	18-2569	360	27-52364	18-2946	689	27-78028A78	18-4355	357
27-25851	18-2570	360	27-524572	18-2848	690	27-78035	18-2836	361
27-279361	18-0870	361	27-52546	18-2896	670	27-78069	18-0934-1	363
27-31402	18-2571	356, 359	27-52550	18-0348	687	27-78246	18-0135	354, 355, 358, 362
27-32438	18-2801	364	27-530451	18-0398	690	27-782461	18-0135	354, 355, 358, 362
27-32769	18-2823	364	27-530451	18-2917	690	27-78409	18-0371	360
27-32770	18-2824	364	27-53354	18-2912	670	27-78410	18-0372	361
27-32771	18-2825	364	27-53354A1	18-4398	685	27-78411	18-0373	360
27-331792	18-2552	690	27-53650	18-2514	356, 360	27-78690	18-0936	354, 355, 358, 363
27-33395	18-0872	670	27-53862	18-2515	357	27-796501	18-0103	362
27-33395A2	18-4394	684	27-54014	18-2847	693	27-801853	18-4387	686
27-33956	18-0327	688, 693	27-54014A1	18-2620	696	27-801855	18-4365	686
27-34208	18-0328	692	27-54014Q1	18-2620	696	27-803508	18-3844	358
27-34209	18-0329	693	27-54506	18-0349	690	27-8052151	18-0916	693
27-34213	18-0889	685, 687-689	27-54529	18-0980	688, 692	27-805396	18-0740	882-885
27-34213A2	18-4375	688	27-54529A1	18-4378	688	27-805403A1	18-0404	684
27-34273	18-3880	689	27-54566A1	18-4399	685	27-805722A1	18-0403	684
27-344863	18-0874	690	27-552791	18-2838	361	27-807473A1	18-0488	688
27-34895A2	18-4376	685	27-55810	18-0894	693	27-81031M	18-0232	361
27-34897	18-0891	685, 693	27-558101	18-0894	693	27-81084	18-2946	689
27-34898	18-0876	685, 689	27-56173	18-0352	692	27-810841	18-3880	689
27-35380	18-0893	685, 693	27-56859	18-0898	882-885	27-810846T	18-1239	687
27-35898A4	18-4395	685	27-56880	18-0147	693	27-811546	18-3874	689
27-35982	18-2840	693	27-58764	18-0353	669	27-811566	18-1232	675
27-35996	18-2556	693	27-60208	18-2834	634, 690	27-811572	18-0468	692
27-35996A1	18-2556	696	27-60286	18-2512	357, 360	27-811588	18-25002	692
27-35996A1	18-2617	696	27-60317	18-0904	357, 362	27-812775-4	18-2610	354, 362

Mercury Marine (Cont.)			Mercury Marine (Cont.)			Mercury Marine (Cont.)		
O.E. #	SIERRA #	PAGE #	O.E. #	SIERRA #	PAGE #	O.E. #	SIERRA #	PAGE #
27-812775-5	18-2611	354, 362	27-94914	18-0386	630, 693	31-32898T	18-1115	374
27-8128671	18-2749	360	27-94996-2	18-2743	693	31-33138A1	18-1193	725
27-8128672	18-2729	360	27-94996Q2	18-2619-1	696	31-35246	18-1120	882-885
27-813859	18-0646	358, 360	27-94996Q2	18-2743	696	31-35928A1	18-1159	374
27-81417M	18-0292	342, 363, 386	27-94996T2	18-2619-1	696	31-35928T1	18-1159	374
27-814210	18-0463	690	27-961711	18-2505	361	31-35988A12	18-1160	726
27-81421M	18-0294	363, 386	27-96278	18-2808	355, 361	31-35988A2	18-1160	699, 701, 711, 712, 726
27-814703	18-2815	693	27-96429	18-1204	670	31-35990A1	18-1161	711
27-815528	18-0680	691	27-96542-1	18-3863	355, 358	31-36387A1	18-1143	374
27-815791A92	18-4359	358	27-967611	18-2510	360	31-38356A1	18-1162	374
27-816460	18-3879	689	27-97542	18-0113	687, 691	31-41326	18-1097	Obsolete
27-817277	18-2566	364	27-981853	18-2807	361	31-42647A1	18-1117	374
27-818188-1	18-1231	687	27-987691	18-0970	360	31-42677A1	18-1118	371, 374
27-818832	18-2849	670	27-988231	18-0388	694	31-43012A1	18-1195	350
27-81987M	18-4698	366	27-98990M	18-3828	358	31-48939A2	18-1144	374
27-81987M	18-4698-1-9	366	27-99173-2	18-2511	354, 355, 358, 363	31-48941A1	18-1163	882-885
27-822189	18-0345	364	27-99176-3	18-2506-1	354, 355, 358, 363	31-53079A1	18-1164	373, 375, 705, 725
27-822844-1	18-3864	358	27-99176-3	18-2506-1-9	354, 355, 358, 363	31-54036A1	18-1126	882-885
27-823142	18-0378	362	27-991764	18-2506-1	354, 363	31-54038A1	18-1127	725
27-823142 2	18-0378	362	27-991764	18-2506-1-9	363	31-54042T	18-1180	882-885
27-8243261	18-0487	688	27-99177-1	18-2503	354, 355, 363	31-54928	18-1356	724
27-824853	18-0835	363	27-991772	18-2503	354, 355, 363	31-61100A1	18-1165	699, 701, 711, 712, 725
27-825032	18-3845	358	27-993261	18-2562	363	31-62596A1	18-4038	350
27-8254821	18-3827	358	27-995061	18-0667	690	31-62799A1	18-1111	882-885
27-827284	18-2721	354, 360	27-99757	18-2909	684, 692	31-69220	18-1121	374
27-828292	18-0641	358, 359	27-997761	18-2508-1	363	31-69220T	18-1121	374
27-828553	18-0319	362	27-997772	18-2833	670	31-73363	18-1122	373, 374
27-832933-5	18-2739	362	27-99777A1	18-4367	684	31-73363T	18-1122	374
27-83899M	18-3828	358	27-99960	18-0389	691	31-74248T	18-1196	350
27-83940M	18-0380	882-885	2704-821896A3	18-4627	347	31-78172A1	18-1166	373, 375
27-84733M	18-3804	358	2704-821896A4	18-4628	347	31-803090T1	18-8208	736
27-850283	18-2737	882-885	2704-826191T4	18-4626	347	31-812767A1	18-1170	375
27-8503181	18-3675	361	28-43037	18-3293	337	31-812768	18-1198	Obsolete
27-850470	18-3887	689	28-81603M	18-3294	337	31-815480	18-1189	882-885
27-85087	18-2561	193, 338, 363	28-81912M	18-3305	337	31-828437A2	18-1173	725
27-85487	18-2507	356, 361	28-83444M	18-3300	337	31-828439A2	18-1197	374, 725
27-854882	18-0940	361	29-20046T	18-4035	Obsolete	31-86748A1	18-1129	725
27-85489-2	18-0105	357, 360	29-47270	18-4036	350	31-87156	18-1183	882-885
27-85490-2	18-2805	357, 361	29-71422	18-4037	350	31-88269T	18-1347	882-885
27-85491-2	18-0942	356, 361	29-88258	18-1186	350	31-88903T	18-1192	882-885
27-854913	18-0942	361	30-20066	18-1151	304	31-92366A1	18-1150	725
27-85491A90	18-4325	355	30-20839T	18-1190	374	31-M8004528	18-1194	350-352
27-85492-2	18-0137	355, 356, 360	30-23679	18-1152	304	31640A1	18-6011	382
27-85493	18-2500	356, 361	30-36418	18-2101	714	31640A1	18-6011A	382
27-854952	18-2574	361	30-41341	18-1397	882-885	31640A1	18-6241	382
27-854961	18-0944	361	30-43011T	18-1346	350	31640Q4	18-6011	382
27-854972	18-2839	361	30-562540A3	18-21005	714	31640Q4	18-6011A	382
27-85498-1	18-0107	356, 360	30-60794A4	18-2100	714, 716	31640Q4	18-6241	382
27-856081	18-2914	365	30-63326	18-1153	350, 374, 725	31640T6	18-6011	207, 382, 734
27-85609-1	18-2915	365	30-63326T	18-1153	374, 725	31640T6	18-6011A	207, 382, 734
27-85610-1	18-2826	364	30-63742	18-1154	350, 374	31640T6	18-6241	207, 382, 734
27-85653-1	18-0946	357, 361	30-63742T	18-1154	374	32-12817	18-75125	644
27-85653A87	18-4356	357	30-67923T	18-1345	350	32-12818	18-75125	644
27-856704	18-2826	364	30-72961	18-1398	350	32-14358T	18-2746	717
27-856705	18-0113	691	30-803097T1	18-8213	716	32-16011	18-70955	641
27-856730	18-0946	361	30-803097T1	18-2601-1	716	32-16012	18-70956	641
27-85817A1	18-0153	685, 687	30-803098T1	18-8217	716	32-160211	18-70925	643
27-858524	18-2915	365, 694	30-803098T1	18-8205	716	32-32461	18-3601	643, 645
27-858935	18-0649	362	30-803099T1	18-8218	716	32-33189	18-71337	645
27-860231	18-0672	670	30-803099T1	18-8206	s/s to 18-8206-1	32-38377	18-2160	718
27-8637251	18-0672	670	30-803099T1	18-8206-1	716	32-41642A3	18-70957	642
27-863726	18-2849	670	30-803100T1	18-8219	716	32-4172533	18-3602	643
27-863895	18-2736	358	30-803100T1	18-8212	716	32-43437	18-3603	643, 645
27-87105-1	18-2849	670	30-879194A01	18-21006	713	32-44348T	18-2748	661, 717
27-87707	18-0948	688, 690	30-879194A02	18-21001	713	32-45973	18-2105	729
27-88046	18-0950	687, 694	30-88957A1	18-1155	374, 726	32-45974	18-2106	729
27-880729	18-0791	362	30-88957T	18-1155	374	32-48132	18-71218	645
27-881715	18-0322	694	30185A3	18-8070	331	32-52481	18-70930	644, 645
27-883964	18-0405	687	30185A3	18-8084	331	32-52951A1	18-2126	730
27-88449	18-2504	357, 361	30185Q3	18-8070	331	32-53461-70	18-75125	644
27-88449A32	18-4357	357	30185Q3	18-8084	331	32-54236	18-3220	629, 699
27-884511	18-0139	362	31-12576	18-1112	371, 374	32-55816	18-2107	729
27-88907	18-0952	354, 355, 363	31-12578	18-1113	371, 374	32-59841	18-2108	729
27-892211	18-0384	359	31-12578T	18-1113	374	32-59842	18-2109	729
27-89221A88	18-4319	355	31-17514A1	18-1194	350	32-71613	18-70928	644, 645
27-896561	18-2555	690	31-17514A2	18-4039	350	32-73794	18-70929	644, 645
27-89657	18-0111	687, 691	31-21700	18-1095	369	32-73795	18-70927	643, 645
27-89937	18-0385	362	31-21739	18-1096	Obsolete	32-73796	18-70926	643, 645
27-90430	18-2803	355, 359	31-30894A1	18-1156	374, 725	32-802885Q	18-7876	675
27-904301	18-2803	359	31-30894A5	18-1182	725	32-8066351	18-70938	642
27-90458A1	18-0411	688	31-30895	18-1157	371, 374	32-8066361	18-70939	642
27-904841	18-2502	361	31-30895T	18-1157	374, 725	32-8066362	18-70946	642
27-90484A88	18-4317	355	31-30956	18-1158	374	32-806856	18-70935	642, 645
27-90556	18-2554	634, 690	31-30956T	18-1158	374	32-807407	18-70949	641
27-91892	18-0185	685, 687, 693	31-32573A1	18-1142	724	32-807458T	18-2770	717
27-92648M	18-2787	386, 387	31-32575A1	18-1179	725	32-807661	18-70950	642
27-92720	18-0954	687, 691	31-32575T1	18-1179	725	32-807697	18-70941	643, 645
27-935361	18-2501	360	31-32898	18-1115	374	32-808033	18-70948	641

Mercury Marine (Cont.)			Mercury Marine (Cont.)			Mercury Marine (Cont.)		
O.E. #	SIERRA #	PAGE #	O.E. #	SIERRA #	PAGE #	O.E. #	SIERRA #	PAGE #
32-8080441	18-70953	641	33981T	18-2162	715, 719	38399A2	18-2189	718
32-857103K12	18-8023EP-1	133, 330	34127A1	18-6012	734	39-15320M	18-3976	347
32-857103Q12	18-8023EP-1	133, 330	34127T2	18-6012	734	39-15322M	18-3978	882-885
32-858104K08	18-8024EP-1	132, 329	34235Q1	18-5250	584	39-17464	18-3937	676
32-858104Q08	18-8024EP-1	132, 329	34235T	18-5311	585	39-17465	18-3938	676
32-858105K08	18-8025EP-1	132, 330	34235T1	18-5250	584	39-18487A12	18-3924	349
32-858105Q08	18-8025EP-1	132, 330	34762A1	18-6013	734	39-18653A1	18-3967	347, 349
32-858109K12	18-8016EP-1	133, 330	34765A1	18-4456	99, 737	39-18653A12	18-3966	347, 349
32-858109K12	18-8016S	137	34765A2	18-4456	737	39-18653A2	18-3968	347, 349
32-858109Q12	18-8016EP-1	133, 330	35-11004A1	18-7784	627	39-18939M	18-3977	882-885
32-858109Q12	18-8016S	137	35-16248	18-7712	334	39-19721A1	18-4020	882-885
32-858114K08	18-8012EP-1	132, 329	35-16494	18-7829	130, 335	39-19721A2	18-4021	882-885
32-858114Q08	18-8012EP-1	132, 329	35-16494-1	18-7830	130, 335	39-19721A6	18-4019	347, 349
32-8600891	18-70954	641	35-16595Q	18-7876	156	39-27841A12	18-3903	349
32-8601144	18-70940	643, 645	35-16595T1	18-7876	153	39-66217	18-3939	676
32-860205	18-70951	641	35-18458Q3	18-7967	126, 334	39-67127	18-3940	676
32-860220	18-3221	629, 701	35-18458Q4	18-7968	126, 334	39-67132	18-3942	676
32-86036	18-2103	729	35-49088A2	18-7860	627	39-74381A1	18-3928	676
32-86036Q	18-2103	729	35-49088Q2	18-7860	627	39-75609	18-3944	676
32-861127	18-2435	730	35-53336	18-7859	627	39-78811A12	18-3916	347, 349
32-861128	18-2436	730	35-53336Q	18-7859	627	39-78816A12	18-3902	349
32-861590A05	18-70944	641	35-60494A4	18-7848-1	126, 332, 625	39-78918A4	18-3922	349
32-861634	18-70933	642, 645	35-60494A4	18-7983-1	126, 332, 625	39-81095M	18-3985	882-885
32-862124	18-70947	642	35-802884Q	18-7879	153, 675	39-81096M	18-3986	882-885
32-862139	18-70945	641	35-802885Q	18-7824	153, 675	39-81097M	18-3987	Obsolete
32-864588	18-2137	730	35-802886Q	18-7875	153, 156, 675	39-81260M	18-3988	Obsolete
32-864589	18-2136	730	35-802893A4	18-7848-1	126, 332, 625	39-81261M	18-3989	Obsolete
32-864959	18-2115	730	35-802893A4	18-7983-1	126, 332, 625	39-81262M	18-3990	Obsolete
32-864960	18-2114	730	35-802893Q	18-7844	126, 334, 565, 626	39-813011A12	18-3927	349
32-87108	18-71337	645	35-802893Q	18-7845	126, 334, 565, 626	39-815267A4	18-3925	349
32-871171	18-70932	644	35-802893Q	18-7944	126, 334, 565, 626	39-817096A16	18-3919	347, 349
32-87234	18-2112	730	35-802893Q	18-7945	126, 334, 565, 626	39-817096A26	18-3920	347, 349
32-87235	18-2113	730	35-802893Q4	18-7848-1	126, 225, 332,	39-817096A6	18-3918	347, 349
32-88005	18-2110	381			421, 625, 765, 830	39-822321A12	18-3982	347, 349
32-88006	18-2111	381	35-802893Q4	18-7983-1	126, 333, 625	39-822321A2	18-3984	882-885
32-883702K	18-7879	153, 675	35-80365M	18-7713	334	39-826293A12	18-4051	882-885
32-883702Q	18-7879	153, 675	35-803897Q1	18-7784	627	39-826297A12	18-4052	882-885
32-88795	18-75125	644	35-805809	18-7871	152, 581, 675	39-827179A12	18-4050	349
32-887952	18-70952	641	35-805809T	18-7871	156	39-83195M	18-3991	Obsolete
32-89653	18-70704	645	35-807172	18-7844	126, 334, 626	39-83196M	18-3992	882-885
32-897181	18-70934	642	35-807172	18-7845	126, 334, 626	39-83197M	18-3993	Obsolete
32-897301	18-70942	643	35-807172	18-7944	126, 334, 626	39-85636A4	18-3923	349
32-897491	18-70943	643	35-807172	18-7945	126, 334, 626	39-88392A12	18-3917	347, 349
32-90949T	18-2761	717	35-808275	18-7873	129, 627	39-92625M	18-3994	Obsolete
32-92837	18-75125	644	35-809097	18-7919	127, 334, 626, 627	39-92626M	18-3995	Obsolete
32-95858	18-2435	730	35-809099	18-7920	128, 334, 626	39-92627M	18-3996	Obsolete
32-95859	18-2436	730	35-809100	18-7929	84, 127, 227, 334,	39-93481A12	18-3921	349
32-96246A4	18-70958	642			422, 626, 766, 832	39-96170A12	18-3979	347
32-96879	18-70931	644, 645	35-815419	18-7964	627	39-96170A3	18-3980	Obsolete
32-99902	18-2136	730	35-816296	18-7829	130, 335	39-96170A4	18-3981	882-885
32-99902-1	18-2114	730	35-816296-1	18-7830	335	391-5075	18-5376	587
32-99903	18-2137	730	35-816296-T1	18-7830	130, 335	391-5075Q1	18-5376	587
32-99903-1	18-2115	730	35-816296K03	18-7829	130, 335	391-5076	18-0422	882-885
32-99904	18-2116	730	35-816296Q	18-7829	130, 335	391-5088	18-5404-1	586
32193A2	18-5433	303, 588	35-816296Q2	18-7830	130, 335	391-5090	18-5314	585
32734A3	18-2750	716, 717	35-816296T	18-7829	335	391-5092	18-5338	584-586
3302-804844002	18-7098-1	616	35-822626Q03	18-7913	154-156, 207, 353	391-7057	18-5404-1	584-586
3302-804845	18-7097	616	35-822626Q04	18-7914	156	391-7057T	18-5404-1	586
3302-9031	18-7202	617	35-822626Q1	18-7913	154, 156, 353	391-898253001	18-5338	586
3302-9033	18-7859	627	35-822626Q15	18-7906-1	353	391-898253004	18-5314	585
3302-9437	18-7097	616	35-822626Q2	18-7914	154, 156, 353	391-898253029	18-5404-1	586
3304-9354A2	18-7604-1	142, 144, 611	35-822626T7	18-7906-1	154, 156, 353	392-2529	18-6256	603
3310-806969 R01	18-7613-1	143, 144, 612,	35-853333T	18-7997	335	392-2940	18-6254	603
		614, 615	35-864572	18-7721	627	392-6318	18-5369	587
3310-806969A1	18-7613-1	143, 144, 612,	35-866171A01	18-7977	627	392-6318T	18-5369	587
		614, 615	35-866340K01	18-7824	675	392-6324	18-5347	584-586
3310-807312 R02	18-7611-2	143, 144, 611, 614	35-866340Q02	18-7824	s/s to 18-7824-1	392-6326	18-5407	584-586
3310-807312A1	18-7611-2	143, 144, 611, 614	35-866340Q02	18-7824-1	153	392-6326T	18-5407	586
3310-864941A01	18-7373N	142, 611, 613	35-866340Q03	18-7824	675	392-6329	18-5399	587
3310-864943A01	18-7639	143, 611, 614	35-877565T1	18-7714	334	392-7803A4	18-5438	588
332-4911A2	18-5786	304	35-877761K01	18-7758	153, 353	392-805570A2	18-5438	588
332-4911A8	18-5787	304	35-877761Q01	18-7758	153, 353	392-806529A1	18-5433	303, 588
332-5772A7	18-5881	185, 304	35-877767K01	18-7921	154, 353	392-825101T	18-5180	303
332-7778A12	18-5775	185, 186, 303,	35-877769K01	18-7918	154, 353	8M0054588	18-5465	588
		306, 307	35-87946A3	18-7802	334	392-898253002	18-5347	586
332-7778A6	18-5775	185, 303	35-87946Q3	18-7802	335	392-898253005	18-5303	585
332-7778A9	18-5775	185, 303	35-87946Q4	18-7802	334, 335	392-8989	18-6255	603
336-4318A2	18-5139	302	35-879885T	18-7718	334	392-9086	18-5353	587
33765T	18-5386	587	35-883701K01	18-7918	154, 156, 353	392-9086T	18-5353	587
339-6222A8	18-5788	304	35-884380T	18-7981	334	392-9089	18-5403	511, 585, 586, 743
339-7370A13	18-5186	185, 303	35-886638	18-7948	129, 334, 626	392-9089T	18-5403	586
339-7452A14	18-5778	304	35-888289T2	18-7936	334	392-9766	18-5352	511, 585, 586, 743
339-7452A15	18-5777	304	35-893318T01	18-7998	335	392-9766Q1	18-5352	586
339-7452A19	18-5777	304-307	35-896247	18-7999	335	392-9767	18-5403	586
339-7452A21	18-5778	304-307	35-896546T	18-7921	154, 156, 353	393-4988T	18-5389	587
339-7452A3	18-5776	303	35-8M0020349	18-7981	334	393-4988T2	18-5389	587
339-832757A4	18-5186	303	35-93568	18-7717	627	393-9459	18-5385	587
339-85699A1	18-5187	303	36223A2	18-2752	717	393-9459Q1	18-5385	587

Mercury Marine (Cont.)			Mercury Marine (Cont.)			Mercury Marine (Cont.)		
O.E. #	SIERRA #	PAGE #	O.E. #	SIERRA #	PAGE #	O.E. #	SIERRA #	PAGE #
39383 1	18-2128	713	44-860308	18-2166	722	47-89984	18-3017	336, 339, 340, 628,
39383T	18-2128	699, 701, 713	44-860308	18-2254	722			630-633, 703, 705, 737
394-1100A3	18-5148	302, 303	44-94148	18-2239	373, 378	47-89984T4	18-3017	193, 336, 628
394-1130A1	18-5169	302, 303	44354A3	18-1976-1	651, 655, 663, 667	47-95611M	18-3063	336
398-173	18-5178	303	44357A2	18-9010	167, 382, 731	47-96305M	18-3073	336
398-174	18-5153	302, 303	44357Q2	18-9010	167	47-97108M	18-3069	336, 342
398-2202	18-5140	303	45-41939A1	18-2167	723	47441A1	18-1977-1	634
398-5255	18-5856	311	45-42634	18-2180	723	47487T	18-5978	882-885
398-5454A17	18-5854	311	45-43031A1	18-1736	371, 378	47886T	18-5808	313
398-5454A26	18-5859	311	45-440001	18-1737	378	48752T	18-3114	337
398-5454A32	18-5871	310	45-55796	18-2179	714	50-12066A9	18-4915	366
398-5454A35	18-5860	311	45-557961	18-2324	714	50-12066Q9	18-4915	366
398-5454A7	18-5857	311	45-816919	18-2261	723	50-12177A2	18-5905	599
398-5704A7	18-5865	310	45-853648	18-2331	723	50-12177A2	18-5910	599
398-6231A10	18-5872	603	45518A2	18-2161	715, 716	50-12872	18-5903	601
398-693	18-5206	302, 303	45589A3	18-2169	715	50-17251A3	18-5900	598
398-713	18-5207	303	45706A14	18-2142	732	50-17251A3	18-5911	598
398-832075A14	18-5874	311	45876-20	18-5511	308	50-38890A1	18-5601	318, 320
398-832075A20	18-5874	310-312	46-42040A5	18-3149-1	338, 386	50-38890A1	18-5641	318, 320
398-832075A21	18-5870	185, 310, 312	46-42579A3	18-3419	338, 340	50-41583	18-6828	319
398-832075A4	18-5870	185	46-42579A4	18-3319	340	50-44369	18-5606	318
398-832075A6	18-5873	185, 310	46-44292A3	18-3420	629, 631, 632, 703	50-44369A1	18-5606	318, 320, 321
398-9610A19	18-5876	311	46-46893A6	18-3447	342	50-44414	18-5608	319, 321
398-9610A5	18-5875	311	46-48744A3	18-3448	342	50-44414	18-5643	319
398-9873A4	18-5867	310	46-48748A1	18-3421	629, 631	50-44415	18-5608	319, 321
40-52035	18-4294	347	46-57234A1	18-3417	629, 631, 633, 705	50-44415	18-5643	319
41141A2	18-7284	140, 621	46-60366A1	18-3507	340	50-55601	18-5601	318, 320
41639A-1	18-7230	620	46-60367A1	18-3517	340, 631	50-55601	18-5641	318, 320
41951A1	18-2157	718	46-70941A3	18-3446	341	50-55601A2	18-5601	318, 320
42419A1	18-6749	602	46-72774A32	18-3600	630	50-55601A2	18-5641	318, 320
42419A1	18-6750	602	46-73640A1	18-3423	338, 341	50-56886	18-5903	601
42431M	18-3426	342	46-73640A2	18-3323	341	50-57465A1	18-5636	319, 321
42724A3	18-3219	715	46-77177A1	18-3424	338, 341, 369	50-57465A1	18-5649	319
42725A3	18-7282	139, 621	46-77177A3	18-3324	341	50-57867	18-5636	319
42909A3	18-7818-1	327	46-77516A1	18-3422	338, 340	50-57867	18-5649	319
42909A4	18-7818-1	327	46-77516A3	18-3322	340	50-58788A3	18-5636	319
43-18410A2	18-2201	710	46-77822A1	18-3118	337	50-58788A3	18-5649	319
43-18411A2	18-2201	710	46-78400A2	18-3316	340	50-60315	18-5606	318, 320, 321
43-45814A5	18-2203	711	46-807151A14	18-3150	630	50-60594A	18-6824	600
43-55778A3	18-2205	711	46-812966A7	18-3445	338	50-60594A1	18-6824	600
43-75325A3	18-2204	711	46-84277M	18-3148	341	50-60594T01	18-6824	600
43-803068T1	18-8207	882-885	46-84277T	18-3148	341	50-64975	18-5636	319, 321
43-803069T1	18-2369	722	46-862914A13	18-3160	630	50-64975	18-5649	319
43-803071T1	18-2368	722	46-879194401	18-3506	628	50-65436	18-5604	318, 321
43-803079T1	18-2404	722	46-96146A5	18-3414	338, 340	50-65436	18-5642	318
43-803091T1	18-2405	722	46-96146A6	18-3416	338, 340, 373	50-66015	18-5604	318, 321
43-803101T1	18-2259	712	46-96148A1	18-3116	337	50-66015	18-5642	318, 321
43-803102T1	18-2358	710	46-96148A5	18-3517	339, 340, 630, 631	50-66015 3	18-5610	319, 321
43-803103T1	18-6351K	710	46-96148A8	18-3317	340, 631	50-66015-1	18-5610	321
43-803104T1	18-6350K	710	46-96148A8	18-3517	340, 631	50-66015T1	18-5604	318, 321
43-803105T1	18-6353K	710	46-96148T	18-3116	337	50-66015T1	18-5642	318
43-803106T1	18-6352K	710	46020T	18-2125	699, 701, 712	50-67341	18-5602	318, 321
43-803112T1	18-2257	712	46399A1	18-6014	382, 734	50-69865A1	18-5903	601
43-803114T1	18-2258	712	46399A1	18-6014A	382, 734	50-72467	18-5636	319, 321
43-803116T1	18-2256	711	47-11590M	18-3066	336	50-72467	18-5649	319
43-803118T1	18-2363	710	47-161543	18-3098	337	50-72550A2	18-5901	599
43-803119T1	18-2364	710	47-19453	18-8900	193, 337	50-72550A2	18-5907	599
43-803120T1	18-2365	710	47-20813	18-3008	336	50-73521	18-5605	318, 320
43-803615T2	18-1551	378	47-22748	18-3012	336, 342	50-73521T	18-5605	318
43-803615T2	18-1564	378	47-30221	18-3017	336, 628	50-76965A3	18-5902	599
43-828072A2	18-2206-1	721	47-42038-2	18-3062	193, 336	50-76965A3	18-5908	599
43-828072A3	18-2360	721	47-43026-2	18-3056	193, 336, 628,	50-76965A4	18-5900	598
43-828073A1	18-2206-1	721			630, 632, 707	50-76965A4	18-5911	598
43-828073A1	18-2408	721	47-43026-T2	18-3056	336	50-77141	18-5608	319, 321
43-828175A1	18-1566	378, 379	47-43026Q06	18-3265	339	50-77141	18-5643	319
43-850036T	18-1560	378	47-59362	18-3087	628, 630	50-77328A3	18-5900	598
43-853640A2	18-6350	711	47-59362A4	18-3216	630	50-77328A3	18-5911	598
43-853641A2	18-6351	711	47-59362Q08	18-3318	630	50-79472	18-5608	319, 321
43-853642A2	18-6352	711	47-59362T	18-3087	628	50-79472	18-5643	319
43-853643A2	18-6353	711	47-65960	18-3017	336, 628	50-79472 1	18-5608	319, 321
43-878087A2	18-2206-1	721	47-72774A89	18-3155	630	50-79472 1	18-5643	319
43-878087A2	18-2406	721	47-80395M	18-3072	336	50-79604A3	18-5901	599
43-878087A4	18-2407	722	47-81423M	18-3069	336, 342	50-79604A3	18-5907	599
43-881260A3	18-1550	378	47-84027M	18-3074	336, 341	50-801333980	18-6957	579, 600
43-92320T	18-2409	721	47-84027T	18-3074	336	50-804312T1	18-6425	318
43-96084A4	18-2200	721	47-84797M	18-3067	336, 342	50-805833	18-6870	578, 600
43-96084A7	18-2410	721	47-85089-3	18-3057	193, 336, 338	50-805833T	18-6870	578, 600
43077T	18-5131	410	47-85089T7	18-3215	338	50-805991	18-6947	579, 600
43396A2	18-6249	383	47-862232A2	18-3016-1	628	50-806963A4	18-5919	599
43396A2	18-6249A	383	47-89980	18-3054	336	50-806965A2	18-5919	599
43567T1	18-1567	373, 375	47-89981	18-3039	336, 339, 341	50-806965A4	18-5919	599
43994A2	18-6066	734	47-89982	18-3052	336, 339, 342	50-807904A1	18-6275	598
43994A2	18-6066A	734	47-89982T1	18-3252	339	50-808011A1	18-5902	599
43994A2	18-6243	734	47-89983	18-3007	336, 338, 340,	50-808011A1	18-5908	599
44-17915	18-2260	378			341, 369, 628	50-808011A4	18-5603	598
44-66060	18-2166	722	47-89983Q1	18-3207	338	50-812428A3	18-5913	599
44-66060-3	18-2166	722	47-89983T	18-3007	336	50-812604A2	18-5913	599
44-824110	18-2166	722	47-89983T2	18-3207	338	50-818445-2	18-5620	319, 321

Mercury Marine (Cont.)			Mercury Marine (Cont.)			Mercury Marine (Cont.)		
O.E. #	SIERRA #	PAGE #	O.E. #	SIERRA #	PAGE #	O.E. #	SIERRA #	PAGE #
50-818445-3	18-5620	319, 321	55989T9	18-6015A-9	734	700-878574A2	18-4644	882-885
50-8184455	18-5620	319, 321	55989T9	18-6242-9	734	70125A 1	18-7665	617
50-819271	18-6864	319	56-864641A24	18-2464	732	70981A3	18-2762	717
50-820193A1	18-6864	319	57-13457	18-15290	645	71464A01	18-7667	617
50-822330A2	18-5913	599	57-13457T	18-15290	645	71683A1	18-3584	628
50-822462	18-5621	319, 320	57-13458T	18-15550	645	73020A14	18-2191	723
50-822462T1	18-5621	319	57-32850	18-15400	645	733-3818	18-4160	676
50-825991A2	18-6940	320	57-33170	18-15520	645	733-3819	18-4161	676
50-830308T	18-6437	318	57-33170Q	18-15520	645	733-803850T	18-4161	676
50-831001562	18-6949	579, 600	57-36356	18-15415	645	73345A1	18-4233	369, 382
50-831001671	18-6954	579	57-37619T	18-15520	645	735-6370	18-4173	676
50-831001672	18-6954	579	57-45856	18-15440	645	735-6371	18-4164	676
50-831001961	18-6949	579, 600	57-48120A1	18-15460	645	735-6538	18-4181	882-885
50-831002050	18-6954	579	57-48122	18-15480	645	735-808674	18-4173	676
50-8329972	18-6282	318	57-49043A1	18-15410	645	735-850097	18-4173	676
50-8331535	18-6283	318	57-49211	18-15430	645	735-850098	18-4164	676
50-834749	18-6436	318	57-49213A1	18-15440	645	735-9686	18-4173	676
50-852570	18-6829	319	57-49756	18-15300	645	735-9687	18-4164	676
50-852570T	18-6829	319	57-52692	18-15390	645	735-9715	18-4178	676
50-853329T	18-6440	318	57-64032A1	18-15410	645	736-2343	18-4180	676
50-854178	18-6957	579, 600	57-64416	18-15435	645	73723A1	18-2248	718, 719
50-854636T	18-6438	318	57-65607T	18-15370	645	73813A1	18-1990	667
50-855507	18-6957	579, 600	57-69143T	18-15400	645	73873A1	18-8227	676
50-857065	18-6829	319	57-74271T	18-15345	645	73971A2	18-9010	167, 382, 731
50-859168	18-6829	319	57-76269	18-15405	645	74313A1	18-1147	Obsolete
50-859169T	18-6437	318	57-77274A1	18-15325	645	74313A4	18-1131	682
50-859170T	18-6438	318	57-78200A1	18-15470	645	74639A2	18-2753-2	717
50-859171T	18-6436	318	57-8077554	18-15112	649	75282A1	18-4221	382
50-859377T	18-6435	317	57-8077555	18-15113	882-885	75832A2	18-2104	699, 701, 713
50-863007A1	18-5913	598	57-816295T	18-15490	645	75832A3	18-2174	713
50-863007A1	18-6275	598	57-817113	18-15125	649	75832T	18-2104	713
50-864340A2	18-5913	599	57-828507Q4	18-18100	317	75832T1	18-2174	713
50-86976	18-6825	319	57-861049	18-15114	649	759-80661A7	18-4109	676
50-86976	18-5609	317, 319, 321	57-861757	18-15115	649	759-80661A8	18-4134	676
50-884044T	18-6435	317	57-861758	18-15116	649	761-7982M	18-4135	347
50-884045T	18-6438	318	57-861759	18-15117	882-885	761-7982T	18-4135	347
50-888151T	18-6437	318	57-863876 1	18-15119	649	761-8022M	18-4136	882-885
50-888160T	18-6438	318	57-863876 2	18-15120	882-885	761-8484M	18-4138	347
50-888161T	18-6435	317	57-863876 3	18-15100	649	76214Q5	18-6016	382
50-892339T	18-6440	318	57-863876 4	18-15101	649	76214Q5	18-60161	382
50-893894	18-6943	320	57-863876 6	18-15102	649	76214Q5	18-6016A	382
50-897755T	18-6840	317	57-863876 7	18-15103	649	76214Q5	18-6244	382
50-8m8021116	18-6946	600	57-863876 8	18-15104	649	76214T3	18-6016	382
50-90983A1	18-5611	320	57-863876 9	18-15105	649	76214T3	18-60161	382
50-90983T1	18-5611	319	57-864639	18-15123	649	76214T3	18-6016A	382
50-97499A2	18-5901	599	57-865615005	18-15121	649	76214T3	18-6244	382
50-97499A2	18-5907	599	57-865615007	18-15103	649	76270T	18-3552	634
50-97499R4	18-5901	517, 546, 599, 605-607, 753, 754	57-865615009	18-15105	649	76314A3	18-5866	310
			57-865615010	18-15122	649	76325A2	18-1972	666
50-97499R4	18-5907	517, 546, 599, 605-607, 753	57-880566014	18-15128	317	76351A2	18-1971	666
			57-881754	18-15124	882-885	765-7442T32	18-4010	Obsolete
50-99417A2	18-5900	598	57-892318	18-18000	317	765-7443A11	18-4013	349
50-99417A2	18-5911	598	57-91035A1	18-15495	645	765-7443A12	18-4560	348, 349
50-99418A2	18-5905	599	57-96834Q	18-15500	645	765-7443A2	18-4560	349
50-99418A2	18-5910	599	57-96834T	18-15500	645	765-7446A11	18-4014	882-885
50-99419A3	18-5900	598	57-98043	18-15410	645	766-8667A36	18-4565	882-885
50-99419A3	18-5911	598	57882T	18-7232	565, 620	766-8667A43	18-4565	882-885
52-66063	18-2202	722	58759A10	18-1960-1	665	76771A2	18-1978	666
52-822539	18-2236	371, 378	58759A14	18-1960-1	665	76771A3	18-1978	666
52-822539T	18-2236	378	59826A3	18-2173	720	76850A2	18-2171	720
52-850048T	18-1562	378	59830A1	18-2146	699, 701, 712	77234A2	18-1950-1	664
52-853594T	18-2202	722	59830A7	18-2146	712	77235A2	18-1951-1	664
52-859340T	18-1565	378, 379	60252A2	18-4009	653, 657, 659,	77235A8	18-1951-1	664
53-29641	18-4295	724			661, 668	774-9096A1	18-4530	348, 677
53-805272	18-4289	733	60932A4	18-2751	716, 717	774-9137A10	18-4515	347
53-815949	18-2345	733	62092T	18-7267	139	774-9137A11	18-4530	347
53114A1	18-2759	717	62351A1	18-5707	313	774-9137A12	18-4505	347
54-31765	18-7316	719	62351A2	18-5707	313	774-9137A13	18-4520	347
54-32533	18-7314	719	65057A1	18-5802	313, 601	774-9137A14	18-4535	347
54-38863	18-7321	716, 718	65057T1	18-5802	313, 601	77442A1	18-2148	732
54-41582-7	18-8020	135	65142A1	18-3575	628	776-8896A3	18-4505	347
54-815504372	18-7316	719	65603A12	18-1962-1	665	776-8897A2	18-4520	347
54293A13	18-5822	313	65603A4	18-1962-1	665	776-8898A2	18-4535	347
55278A1	18-7807	327, 356, 357	65604A12	18-1958-1	665	776-9096A1	18-4156	882-885
55278A4	18-7809	327, 357	65604A4	18-1958-1	665	777-815965A5	18-4624	347
55278A5	18-7808	327, 356	66069A2	18-2159	718	777-815965A6	18-4625	347
55331A5	18-3532	635	66081A2	18-0577	699, 701, 715	777-815965T4	18-4623	347
55538A2	18-1973	666	66599A3	18-7813	327	778-9441A3	18-4109	676
55989A3	18-6015-9	734	672, 50-831002051	18-6954	579	778-9441A5	18-4134	676
55989A3	18-60151-9	734	672, 50-831002052	18-6954	579	780-9229A10	18-4621	347
55989A3	18-6015A-9	734	67914A2	18-6763	603	780-9229A11	18-4622	347
55989A3	18-6242-9	734	68704A1	18-1148	679	780-9229A7	18-4620	347
55989Q9	18-6015-9	734	69354A2	18-2413	720	783-9613A2	18-4017	347
55989Q9	18-60151-9	734	700-858294T1	18-4639	882-885	783-9613A3	18-4018	347
55989Q9	18-6015A-9	734	700-858295T1	18-4640	882-885	78403A2	18-5951	604
55989Q9	18-6242-9	734	700-878571A2	18-4641	882-885	78403A2	18-5957	604
55989T9	18-6015-9	734	700-878572A2	18-4642	882-885	78458A1	18-2760	716, 717
55989T9	18-60151-9	734	700-878573A2	18-4643	882-885	785-9737A10	18-4637	349

Mercury Marine (Cont.)			Mercury Marine (Cont.)			Mercury Marine (Cont.)		
O.E. #	SIERRA #	PAGE #	O.E. #	SIERRA #	PAGE #	O.E. #	SIERRA #	PAGE #
785-9737T9	18-4635	349	809463A1	18-5811	313, 602	823653A9	18-6765	309
785-9738T10	18-4638	349	81-64851	18-5346	586	825096T01	18-5821	313
785-9738T9	18-4636	349	811618A1	18-6751	308	825467A1	18-7901	153, 353
78687T	18-2144	353	811635Q2	18-5280	585	825467T1	18-7901	153, 156
78984A01	18-1993	635	811635T3	18-5361	587	826134Q	18-6068	207, 382, 735
79271A4	18-6763	603	811636 1	18-5406	743	826763A	18-3154	882-885
802128A1	18-7831	130, 335	811639T	18-5108	516, 588, 744, 817	828151A1	18-5849	314
802371A1	18-5181	303	811673 1	18-6775	188, 309	828692A1	18-2382	714
802630T01	18-7663	608	812454A1	18-7288-1	140, 621	828708A1	18-6774	309
802706A1	18-7738	322	812843A1	18-6751	308	830250A3	18-6777	188, 309
803061T1	18-3569	335	813442A1	18-6751	308	830250T3	18-6777	188, 309
803470Q	18-7878-1	153	813442A2	18-6751	308	832021A1	18-6777	188, 309
804346T1	18-7743	322	814309A1	18-2434	476, 601	832021A2	18-6777	188, 309
805016A1	18-7228	620	814481M	18-7769	323	832021T2	18-6777	188, 309
805016A1	18-7234	620	814819A2	18-9218	713	832021T4	18-6777	188, 309
805101T	18-3787	728	815279-1	18-5741	313	834832T2	18-6844	604
805185A36	18-5471	591	815279-3	18-5743	313	84-813706A26	18-5225	308
805185A37	18-5470	591	815279-5	18-5743	313	84-813715A1	18-5227-1	307
805218T	18-7600	608	815279A2	18-5741	313	84-813715A1	18-5228-1	307
805223T	18-7702	640	815407A2	18-5396	587	84-813720A10	18-8803-2	597
805224A1	18-7632	608	815425T	18-5899	18, 640	84-813720A11	18-8810-1	597
805226A1	18-7630	608	815471A3	18-2145	718, 719	84-813720A12	18-8802-1	597
805227A1	18-7652	608	815471A3	18-2145E	718, 719	84-813720A13	18-8811-1	597
805320A03	18-7633	732	815471A6	18-2145	718, 719	84-813720A2	18-8804-1	597
805536A2	18-2097	713	815471A6	18-2145E	718	84-813720A3	18-8804-1	597
805544T	18-7703	608	815471T1	18-2604	719	84-813720A3	18-8821-1	597
805656A2	18-7326	140, 621	815471T1	18-2604E	719	84-813720A4	18-8804-1	597
805759Q3	18-5273	585	815919A1	18-2320	724	84-813720A4	18-8821-1	597
805759T	18-5395	587	815935A7	18-2422	732	84-813720A5	18-8800-1	597
805759T1	18-5395	587	815954A7	18-2423	732, 733	84-813720A6	18-8808-2	597
805759T3	18-5273	585	816431A1	18-2747	716, 717	84-813720A7	18-8801-1	597
805884T	18-5965	604	816770T	18-5707	313	84-813720A8	18-8809-1	597
80606M	18-7839	327	816811-1	18-3752	699, 701, 715	84-813720A9	18-8803-2	597
806105A1	18-6079	707	817019A1	18-9099	731	84-816608K68	18-8832-1	150, 151, 597
806105A1	18-6093	707	817019Q2	18-9099	731	84-816608Q61	18-8804-1	150, 151, 597
806105A1	18-6093A	707	817119A1	18-5965	604	84-816608Q71	18-8836-1	150, 597
806105Q1	18-6079	735	817119A4	18-5965	604	84-816608Q78	18-8824-1	151
806105Q1	18-6093	735	817119A4	18-5966	604	84-816608Q80	18-8830-1	597
806105Q1	18-6093A	735	817275A08	18-3406	339	84-816608Q81	18-8822-1	150, 597
806105T1	18-6079	735	817275A09	18-3407	339	84-816608Q82	18-8835-1	151, 597
806105T1	18-6093	735	817275A1	18-3571	341, 346	84-816608Q83	18-8834-1	150, 597
806105T1	18-6093A	735	817275A2	18-3572	341, 342, 371	84-816761A17	18-8821-1	597
806188A1	18-6117A	734	817275T4	18-3147	630	84-816761A4	18-8804-1	597
806188A1	18-6117M	734	817276 1	18-3122	337	84-816761A4	18-8821-1	597
806188A1	18-6117Z	734	817378T	18-5443	588	84-816761A8	18-8809-1	597
806188A2	18-6117A	734	818298A1	18-6249	383	84-816761A9	18-8803-2	597
806188A2	18-6117M	734	818298A1	18-6249A	383	84-816761K14	18-8833-1	151, 597
806188A2	18-6117Z	734	818298Q1	18-6249	383	84-816761Q10	18-8803-2	150, 151, 597
806189A1	18-6067	735	818298Q1	18-6249A	383	84-816761Q12	18-8802-1	151, 597
806189A1	18-6067A	735	818763A10	18-2376	724	84-816761Q13	18-8811-1	150, 597
806189A1	18-6114	735	818903A1	18-6777	188, 309	84-816761Q16	18-8810-1	150, 151, 597
806189Q1	18-6067	735	819479A1	18-6777	188, 309	84-816761Q17	18-8821-1	150, 151, 597
806189Q1	18-6067A	735	819480A1	18-6777	188, 309	84-816761Q3	18-8804-1	150, 151, 597
806189Q1	18-6114	735	819762A4-A7	18-6777	188, 309	84-816761Q3	18-8821-1	150, 151, 597
806189T1	18-6067	735	81977A8-A9	18-6777	188, 309	84-816761Q4	18-8804-1	150, 151, 597
806189T1	18-6067A	735	821509T1	18-5852	314	84-816761Q4	18-8821-1	150, 151, 597
806189T1	18-6114	735	821629A1	18-6080	701	84-816761Q5	18-8800-1	150, 151, 597
806190A1	18-6089	735	821629A1	18-6080A	701	84-816761Q6	18-8808-2	150, 151, 597
806190A1	18-6092	735	821629A1	18-6099	701	84-816761Q7	18-8801-1	150, 597
806190A1	18-6092A	735	821629Q1	18-6080	735	84-816761Q8	18-8809-1	150, 597
806190Q1	18-6089	735	821629Q1	18-6080A	735	84-816761Q9	18-8803-2	150, 151, 597
806190Q1	18-6092	735	821629Q1	18-6099	735	84-822253A20	18-5511	308
806190Q1	18-6092A	735	821630A1	18-6094	735	84-822253T20	18-5511	308
806190T1	18-6089	735	821630A1	18-6094A	735	84-847701A7	18-8837-1	597
806190T1	18-6092	735	821630A1	18-6240	735	84-847701Q7	18-8837-1	150, 151
806190T1	18-6092A	735	821630Q1	18-6094	735	84-863656A1	18-8828-1	151, 597
806191T	18-2373	731	821630Q1	18-6094A	735	84-863656A2	18-8829-1	597
806490T	18-5897	640	821630Q1	18-6240	735	84-881262A2	18-6500	317
806612T	18-7677	608	821630T1	18-6094	735	84-881698	18-8838-1	151, 597
806673T	18-5442	588	821630T1	18-6094A	735	84-99215A26	18-5225	308
806673T1	18-5442	588, 594,	821630T1	18-6240	735	84141M	18-7840	327
806867A 8	18-1956-1	665	821631Q1	18-6066	734	84188M	18-3425	342
807078A 6	18-1957-1	665	821631Q1	18-6066A	734	84188T	18-3425	342
807166A3	18-2732	629	821631Q1	18-6243	734	84262M	18-7837	327
807252-2	18-3649	634	821663-1	18-6960	605	84265M	18-7838	327
807252Q3	18-3646	634	821663A1	18-6960	605	84419M	18-7290	322
807252Q5	18-3647	634	821663A1	18-6449	605	84456M	18-7770	323
807252T1	18-3551	634	821759A4	18-2354	724	84475M	18-7291	322
807476A6	18-1908K	667	822777A1	18-6014	382, 734	845668T	18-0614	675
807652T	18-5967	604	822777A1	18-6014A	382, 734	850454 1	18-3574	628, 767
807653T	18-5960	604	822777Q1	18-6014	382	850484T	18-5362	587
807757T	18-6457	628	822777Q1	18-6014A	382	850484T2	18-5362	587
807914A1	18-1976-1	655, 663,	822870A1	18-6777	188, 309	850484T3	18-5278	585
808483K2	18-5291	584	823034T	18-5793	304	850485 1	18-5408	512, 587, 744, 816
808483Q2	18-5281	585	823426A1	18-7072	616	852956A1	18-7685	608, 609
808483T3	18-5354	587	823426A1	18-7077	616	853678T	18-7700	608
808484 1	18-5405	512	823427A1	18-7746	616	854472A2	18-6777	309
809449A1	18-7216	322	823653A5	18-6765	309	854472A3	18-6777	188, 309

Mercury Marine (Cont.)			Mercury Marine (Cont.)			Mercury Marine (Cont.)		
O.E. #	SIERRA #	PAGE #	O.E. #	SIERRA #	PAGE #	O.E. #	SIERRA #	PAGE #
854472A4	18-6777	188, 309	883166A2	18-6778	603	91-37311	18-9833	169, 173
855654A1	18-6777	188, 309	884794A02	18-5351	591	91-37312	18-9834	169, 173
855654T2	18-6777	188, 309	888751A03	18-5350	591	91-37323	18-9835	169
855998A09	18-6800	309	888755Q01	18-6158M	734	91-37324	18-9815	169, 172
857006A3	18-6844	604	888756Q01	18-6158A	734	91-37350	18-9836	169
85784A1	18-7228	620	888756Q02	18-6150A	735	91-38628T	18-9837	169
85785-2	18-7229	620	888756Q02	18-6150M	735	91-38756	18-9838	170, 173
85785A2	18-7231	620	888756Q02	18-6150Z	735	91-38918T	18-9839	170
85785T	18-7229	620	888757Q01	18-6159M	734	91-38919	18-9840	170, 173
859168T	18-6829	319	888758Q01	18-6159A	734	91-42840T	18-9841	170
860246A10	18-1953-2	664	888760Q01	18-6160M	734	91-43506T	18-9842	170
860256A4	18-3530-1	635	888761Q01	18-6160A	734	91-43559	18-9843	170, 173
861006A	18-1989	566, 635-639	888909A1	18-0557	375	91-43578A1	18-9864	170, 173
861155A3	18-8868	621	889955T01	18-6454	317	91-43579	18-9844	170, 173
861155A6	18-8867	620	89-18080	18-5837	601	91-43591T	18-9845	170
861156A02	18-8861	620	89-68258A4	18-5815	313, 602	91-44110	18-9846	170, 173
861156A03	18-8862	620	89-76416A1	18-5801	601	91-45497A1	18-9847	170, 173
861156A04	18-8863	620	89-76545	18-5815	313, 602	91-52393	18-9848	169, 173
861188A1	18-3531	635	89-817109A2	18-5834	185, 314	91-52394	18-9849	169, 172
861493A07	18-1910	635	89-818864	18-5818	313	91-53459	18-9850	170, 173
861493A3	18-1993	635	89-818864T	18-5818	313	91-55916	18-9851	170, 173
861523A9	18-2412	720	89-818997A1	18-5819	313	91-55918	18-9852	170, 173
861677T	18-8860	621	89-818997T1	18-5819	313	91-56048001	18-9853	170
861678A1	18-7283	139, 621	89-818999A2	18-5820	313, 602	91-56048T	18-9853	170
86177 1	18-5658	320, 321	89-825096T	18-5821	313	91-56775T	18-9854	171
862030T	18-5983	604	89-825842A1	18-5820	313, 602	91-57797A3	18-4442	721
862031T	18-6293	604	89-850188T1	18-5820	313, 602	91-60523	18-9855	171, 173
862048A1	18-7288-1	140, 621	89-853654A1	18-5815	313, 602	91-60526T	18-9856	171
862077A1	18-7284	140, 621	89-91975	18-5816	313, 602	91-61067A3	18-9857	171, 173
862129A1	18-1709	712	89-96054	18-5816	313, 602	91-61069T	18-9858	171
862132T	18-1711	713	89-96054T	18-5816	313	91-61077	18-9868	171, 173
86234A05	18-7278	139, 621	89-96158	18-5817	313, 602	91-63616	18-9859	171, 173
86234A4	18-7278	139, 621	89-96158T	18-5817	313	91-63638T	18-9860	171
86246T	18-7274	139	89-99253	18-5837	601	91-78310	18-9861	171, 173
86247T	18-7275	139	89011A8	18-1957-1	665	91-813653	18-9873	172
862548A1	18-6749	602	89031A1	18-7811	327	91-817570T	18-9869	171
862548A1	18-6750	602	89031A2	18-7812	327, 355	91-818162	18-9870	171, 173
863077T	18-6298	604	89031A3	18-7813	327, 357	91-818169T	18-9871	171
864244A2	18-6401	713	89031A4	18-7814	327	91-821571A1	18-9872	171, 173
864281A01	18-6405	712	891736T	18-6772	603	91-821887A-1	18-4459	381, 729
864281A2	18-6402	713	892940T	18-5929	317	91-859046Q4	18-4459	729
864282T	18-6403	712	893929A01	18-6751	308	91-87119	18-9862	172
864856A1	18-7684	608	89396A38	18-8004EP-1	130, 136, 330	91-89865	18-9863	171, 173
865380A13	18-6813	603	89396A38	18-8004S	130, 136, 330	91-89897	18-9866	171, 173
865380A25	18-6813	603	89396Q38	18-8004EP-1	130, 136, 330	91-90244A1	18-9875	172, 173
865491A01	18-6405	712	89396Q38	18-8004S	130, 136, 330	91-90774	18-9865	172, 173
865492T	18-6403	712	896173A01	18-2700	382	91-95830A1	18-4444	381, 729
865493A01	18-6406	713	897755T	18-6840	317	91-99379	18-9802	172, 310
865496A01	18-6406	713	898253T22	18-5244	542, 586, 594, 595	91-99750A1	18-9801	172, 310
866169T01	18-8864	620	898253T23	18-5243	586	91748M	18-7834	327
866170A01	18-8865	620	898253T24	18-5433	303, 588	92-12564 2	22423	166
86617A17	18-5863	310	898253T27	18-5443	588	92-12564-1	22423	166
86617A20	18-5864	310	898253T28	18-5246	584	92-34227 1	1525607	166
86840A05	18-2756	717	898253T29	18-5247	584	92-41669-1	37534	167
86840A3	18-2756	716, 717	89876A3	18-7853-1	126, 332, 624	92-59327-1	37509	166
87-17009A2	MP41070-2	308	899106T10	18-8866	327	92-78383A12	18-9013	164
87-17009A5	MP51090	25, 308	90363A1	18-7810	327	92-78383A12	18-9024	164
87-17009A5	MP51092	25, 308	907964A1	18-5476	591, 593, 748	92-78383A12	18-9065	164
87-18211	18-5729	314	91-12037	18-9806E	168, 173	92-78383A12	18-9080	164
87-19761	18-5737	314	91-12427	18-9807	168, 173	92-802833Q1	18-9420-2	161
87-71831	18-5317	586	91-14311A2	18-9874	168, 173	92-802835Q1	18-9420-3	161
87-861780A2	18-5116-1	588	91-15755T	18-9808	168, 169	92-802836A1	18-9420-7	161
87-861780Q4	18-5116-1	588	91-17256	18-9803	168, 173	92-802837Q1	18-9400-2	161
87-88107	MP41000	308	91-17257	18-9809	168, 173	92-802841A1	18-9400-7	161
87-88107A5	MP52000	25, 308	91-17262A1	18-9810	168, 173	92-802881A-1	1525607	166
87-88107A5	MP52002	25, 308	91-17275A1	18-9812	168, 173	92-809819	37478	166
87114A19	18-1953-2	664	91-17302	18-9813	168, 173	92-809820	37479	166
87290A4	18-1989	566, 635	91-29310	18-9814	168, 169	92-816391A4	18-9200	721
87290A4	18-1994	566, 635	91-30366T1	18-9816	169, 172	92-81639A4	18-9200	163
87399A2	18-2428	732	91-31107T	18-9817	168	92-817529A12	18-9013	164
87399A3	18-2429	732	91-31108T	18-9818	168	92-817529A12	18-9024	164
875285T1	18-6454	317	91-31229	18-9819	169, 172	92-817529A12	18-9065	164
875286A1	18-6455	317	91-31229A7	18-9820	169, 173	92-817529A12	18-9080	164
875286T	18-6455	317	91-32325T	18-9821	169	92-823506 1	37534	167
878265A4	18-6773	309	91-32336	18-9822	169, 172	92-857389A1	18-9400-4	161
878265A6	18-6774	309	91-33489	18-9823	169, 173	92-858037K01	18-9530-3	159
88-79023A91	18-8220	605	91-33491	18-9824	169, 173	92-858039K01	18-9530-7	159
881247A1	18-6455	317	91-33492T	18-9825	169	92-858042K01	18-9553-3	160
881248T02	18-6454	317	91-33493T	18-9826	169	92-858042Q01	18-9553-3	160
88183A12	18-6813	603	91-34379T	18-9827	169	92-858057K01	18-9440-7	161
88183A12	18-6752	602	91-36235	18-9803	721	92-858084K01	18-9552-3	160
88183A12	18-6753	602	91-36379	18-9828	169, 172	92-86166	18-9031	166, 718
88183A5	18-6769-1	603	91-36569	18-9829	169	92-883722K01	18-9440-8	162
88183A8	18-6813	603	91-36569T	18-9829	169	92-883723K01	18-9440-3	162
882751A04	18-5850	314	91-36571	18-9830	169	92-883724K01	18-9440-2	161
882751A1	18-5849	314	91-36571T	18-9830	169	92-883724K01	18-9440-2P	161
882751A2	18-5849	314	91-36577	18-9831	169, 173	92-883725K01	18-9440-4	161
883072T	18-5743	313	91-37292	18-9832	169, 172	92-883725K01	18-9440-4P	161

Mercury Marine (Cont.)			Oberdorfer (Cont.)			OMC (Cont.)		
O.E. #	SIERRA #	PAGE #	O.E. #	SIERRA #	PAGE #	O.E. #	SIERRA #	PAGE #
92459A4	18-6765	309	8922	18-3061	475	176288	MP28890	32, 215, 751
92497A3	18-5951	604	132-0317	18-3060	476, 835, 865	176445	18-8092	228
92497A3	18-5957	604	B6620	18-3075	475, 835	202893	18-7168	296
92520M	18-7293	322	C7441	18-3077	475	203034	18-2952	254
92975A28	18-6763	309	OETIKER			203130	18-3841-2	255
92975A32	18-6763	603				787133	18-9125	167, 229
92975A6	18-6763	603	14100082	18-9141	167, 229	203698	18-6513	264
93247A7	18-6768	603	16700004	18-9126-9	167, 229	277181	18-3001	229
93247A7	18-6799	603	16700006	18-9127-9	167, 229	300611	18-3326	231
93320A5	18-1908K	667	16700007	18-9128-9	167, 229	301824	18-7111	296
93477T	18-0615	675	16700010	18-9129-9	167, 229	301877	18-7100	296
936-5544	18-4489	567, 675	16700011	18-9130-9	167, 229	301967	18-7440-1	808
936-810840	18-4489	567, 675	16700012	18-9131-9	167, 229	302325	18-3369	257
936-986767	18-4489	567, 675, 780, 849	16700013	18-9132-9	167, 229	302337	18-7162	296
938-803860T	18-4486	567, 675	16700016	18-9133-9	167, 229, 426	302493	18-7112	296
938-827178 1	18-4491	568, 675, 780, 849	16700017	18-9134-9	167, 229	302497	18-3329	296
938-883297 1	18-4486	567, 675, 780, 849	16700020	18-9140-9	167, 229	302537	18-7164	296
938-883490 1	18-4485	567, 675, 780, 849	16700024	18-9135-9	167, 229	302540	18-7114	296
949-4057	18-4495	568, 675	16700031	18-9136-9	167, 229	302557	18-2887	264
949-5798	18-4495	568, 675	16700037	18-9137-9	167, 229	302564	18-2021	293
949-5913	18-4496	Obsolete	16700040	18-9138-9	167, 229	302588	18-7115	296
949-6560	18-4496	Obsolete	16700053	18-9139-9	167, 229	302675	18-2889	258
94998A2	18-2381	714	OMC			302804	18-3740	277
94998A4	18-2381	714				121731	18-3722	802
95611M	18-3427	342	122838	18-8052	136, 229	303067	18-7116	296
95862A5	18-1954-1	664	123009	18-6017	289	303069	18-3103	230
96455A11	18-5795	311	123009	18-6017A	289	303191	18-7413	296
96455A15	18-5796	311	123009	18-6100	289	303339	18-2891	236, 263, 290
96455A8	18-5797	311	123018	18-1599	791, 792	303345	18-2022	290, 293, 806
96455A9	18-5798	311	124249	18-8201	135, 229, 767, 834	303347	18-7180	296
96705A1	18-1955-1	665	125115	16-331-0566	135, 136, 228	303355	18-2892	258
97257A1	18-5897	640	125530	18-2881	264	303360	18-7117	296
97258A1	18-5898	640	127084	18-4222	800	303438	18-2885	254
97401A2	18-7283	139, 621	160084	18-1501	275, 796, 861	303598	18-7150	296
97401A8	18-7283	139	171960	18-5898	18, 521, 640, 769	303615	18-0850	250-252, 257
97432A2	18-2414	720	172521	18-5011	209	303750	18-2893	257
97793M	18-3426	342	172522	18-5006	209	304023	18-2880	262
97793T	18-3426	342	172523	18-5002	209	304026	18-3332	263
98502A2	18-1974-1	666	172525	18-5001	743	304174	18-7165	296
98504A3	18-1970-1	651, 655, 663, 666	172531	18-5256	742	304314	18-2894	260
98562A6	18-1937	666	172543	18-6762	216	304720	18-2951	254
98703A26	18-2424	732	172543	18-6762	216	304762	18-2871	260
98703A3	18-2426	732	172543	18-6822	826	304764	18-0882	262
98704A17	18-2425	732	172588	18-6816	758	304784	18-1229	261
98704A26	18-2425	732	172806	18-5003	209	305123	18-7133	296
98704A3	18-2427	732	172850	18-6767-1	216	305146	18-7490	882-885
99155A1	18-3555	634	172869	18-5814	217	305176	18-2870	259
99155T1	18-3568	634	173029	18-6017	289	305185	18-7826	227
99186-1	18-6273-1	309	173029	18-6017A	289	305196	18-0426	261
99186T	18-6273-1	309	173029	18-6100	289	305242	18-7118	296
99297A1	18-2193	695	173231	18-7875	153	305270	18-7155	296
99356A2	18-2587	477	173232	18-7824	153	305303	18-3102	230
99370A2	18-2733	629	173233	18-7876	153	305312	18-2869	263
99660A1	18-6751	308	173311	18-8055	100, 135, 228, 330, 425, 767	305739	18-7101	296
99746A17	18-1952-1	664	173312	18-8074	100, 135	305762	18-2532	263
99746A8	18-1952-1	655, 664	173564	18-6767-1	216	305987	18-2018	293
99798A18	18-1956-1	665	173596	18-6767-1	216	306048	18-2959	254
YLM579AV	18-5497-1	592	173619	18-5251	742	306643	18-3135	792
MOTOROLA			173690	18-5258	742	307069	18-2957	254
510-802	18-5976	882-885	173829	18-5260	742	307082	18-7152	296
NISSAN/TOHATSU			173834	18-7879	153, 780	307103	18-7428	262
334-65021-0	18-8921	396	173944	18-6816	758	307133	18-2876	249-251, 261
345-65021-0	18-8923	396	174177	18-8072	228, 767	307239	18-7170	296
345-70250-0	18-8088	396	174275	18-9013	164	307450	18-7102	296
345-87122-0	18-7290	396	174275	18-9024	164	307551	18-2387	277
346-76010-0AO	18-6431	394	174275	18-9065	164	307551	18-2387-1-9	277
346-87122-0	18-7291	396	174275	18-9080	164	307552	18-4255	277
353-76010-4	18-6418	394	174448	18-9098	800, 859	307573	18-2945	789
369-87122-1	18-7765	396	174508	18-8056	228	307583	18-6501	264
369022300M	18-7712	395	174509	18-8014EP-1	132, 228	307853	18-7106	222
394-70250-0	18-80410	396	174509	18-8014S	137	308186	18-7120	808
394-70260-0	18-80417	396	174511	18-8004EP-1	84, 130	308458	18-4075	244
3B2-50021-1	18-8920	396	174512	18-8004S	136, 138	308621	18-7461	296
3B2-70260-0	18-8089	133, 395, 396	174512	18-8005EP-1	84, 130	308624	18-7121	296
3B2-70281-0	18-8079	396	174512	18-8005S	136	308626	18-7103	296
3B7-65021-2	18-8924	396	175068	18-9013	164	308627	18-7198	296
3C7-65021-1	18-8924	396	175068	18-9024	164	308799	18-7104	289, 296, 298, 808, 809
3C8-65021-2	18-8922	396	175068	18-9065	164	308825	18-2863	788
3C8-75014-0	18-56002	395	175068	18-9080	164	308876	18-0653	799
3C8-76010-1	18-6432	394	175158	18-0871	222	308928	18-7123	296
3R0076150M	18-7911-1	154, 156, 396	175257	18-5250	479, 509, 584, 593, 742, 750	308928	18-3108	231
B29A-90500A	18-6430	394	175266	18-3715	277	309044	18-2534	263
OBERDORFER			175267	18-3716	800	309243	18-1236	269, 276, 277, 789
6603	18-3021	476	175268	18-3717	277	309612	18-2950	254
7054	18-3078	475				309731	18-7156	296
						309955	18-3741	800
						309956	18-2898	260

OMC (Cont.)			OMC (Cont.)			OMC (Cont.)		
O.E. #	SIERRA #	PAGE #	O.E. #	SIERRA #	PAGE #	O.E. #	SIERRA #	PAGE #
309989	18-2000	293, 806	317178	18-7109	296	321221	18-3567	238, 240, 241, 636
310058	18-0182	261	317201	1525607	166	321222	18-3562	238, 240, 241
310137	18-2868	260	317230	18-0194	882-885	321435	18-2549	259
310327	18-7173	296	317232	18-2234	271, 288	321453	18-2026	293, 806
310414	18-7167	296	317245	18-1243	238, 240, 241	321459	18-2027	289-291, 293, 294, 806
310433	18-1362	Obsolete	317305	18-0951	249, 250, 258	321466	18-2059	806
310584	18-7135	296	317624	18-1279	882-885	321467	18-2060	806
310585	18-7158	296	317763	18-1280	264, 792	321479	18-0981	251, 259
310599	18-2012	293, 806	317831	18-4290	242	321480	18-2028	289, 293, 294, 806
310649	18-2020	293, 806	317838	18-2219	284	321481	18-2029	289, 293, 294, 806
310913	18-2947	769, 786	317841	18-3182	230	321497	18-0983	250, 252, 258
310953	18-15460	771	317914	18-2866	249, 250, 259	321504	18-8351	293
310967	18-7158	231	317951	18-0953	249, 250, 262	321573	18-2862	251, 259
311046	18-15440	771	317955	18-0117	259	321648	18-5655	189, 220, 221
311068	18-2896	778	318156	18-0955	249, 259	321692	18-2391	239-241, 263
311069	18-0164	784, 785	318303	18-2209	271, 284, 286	321722	18-0985	250, 258
311121	18-2861	778	318304	18-2208	271, 284, 286	321727	18-2864	249, 250, 260
311130	18-2860	786	318334	18-2872	261	321786	18-2030	293
311131	18-2859	786	318335	18-2873	249, 250, 261	321787	18-2031	289, 290, 293, 294, 806
311145	18-0679	262	318358	18-2956	250, 254, 256	321788	18-2032	290, 293, 294, 806
311210	18-3880	785	318372	18-7137	296	321794	18-0989	250, 252, 258
311338	18-7105	296	318373	18-0957	249, 260	321830	18-8304	279, 293, 294
311364	18-1228	882-885	318395	18-3564	238, 240, 241	321831	18-0542	293, 806
311508	18-0917	264, 804	318544	18-2378	789	321886	18-3290	228
311598	18-4248	789	318544	18-23781-9	277, 789	321895	18-0543	293, 806
311598	18-42481-9	276, 789	318544	18-4249	277	321907	18-0991	249-251, 259
311606	18-15400	771	318609	18-2543	249, 250, 261	321921	18-7411	296
311684	18-7854	766	318717	18-7138	296	321928	18-2033	293
312456	18-7860	767	318841	18-4222	800	321932	18-0675	240, 261
312780	18-0874	785	318917	18-0397	261	321940	18-3126	231
312781	18-71337	771	318924	18-0959	251, 258	322119	18-7133	275, 289, 296,
312797	18-2917	785	318925	18-2853	251, 259			297, 808, 809
312800	18-0876	785	318932	18-0961	251, 257	322119	18-7142	289, 296, 299,
312932	18-6511	264	318940	18-1505	264			803, 805, 808-810
313065	18-2901	260	318944	18-6503	264	322236	18-4911	173, 264
313080	18-2767	794	318971	18-3706	277, 278	322332	18-2962	254
313175	18-7107	296	318972	18-2025	293	322411	18-0892	261
313176	18-3141	769	318995	18-3178	231	322501	18-7143	296
313244	18-0923	789	319085	18-7139	808	322575	18-2074	250-253, 293, 295, 806
313282	18-2023	236, 290, 293,	319126	18-3369	232-236, 257,	322652	18-8020	135, 229, 396, 767, 834
		294, 806			269, 273, 275	322653	18-8200	135, 229, 767, 834
313283	18-0173	293	319174	18-2867	249, 250, 259	322654	18-8202	135, 229, 767, 834
313284	18-2005	293	319275	18-3127	230	322656	18-8051	136, 229
313340	18-7126	296	319332	18-0967	251, 261	322858	18-2547	250, 251, 262
313353	18-2058	293, 806	319348	18-2904	261	322941	18-3763	273, 275, 792
313368	18-2851	788	319586	18-0969	234, 262, 290	323214	18-2550	250, 251, 260
313413	18-2960	250, 254, 256	319633	18-2954	254	323222	18-0995	250, 251, 260
313416	18-0929	261	319661	18-0971	251, 261	323311	18-0446	262
313446	18-7127	296	319662	18-7457	296	323312	18-0445	262
313448	18-1714	271, 273, 275, 799	319665	18-2856	261	323361	18-2230	273, 275, 288, 792
313754	18-7128	296	319710	18-2878	260	323362	18-2229	273, 275, 288, 792
313763	18-2865	249, 250, 260	319771	18-2857	249-251, 258	323459	18-0999-9	259
313782	18-2884	254	319890	18-4229	277	323469	18-0102	250, 259
313893	18-7108	296	319891	18-3707	277	323582	18-8372	264
313992	18-2016	293, 806	319895	18-2287	285	323626	18-3136	232-236, 257, 275
314008	18-2703	263	320041	18-2379	271, 276	323653	18-6522	264
314082	18-2855	262, 271, 290, 291	320140	18-7178	296	323664	18-2220	797
314115	18-0933	249, 258	320166	18-2224	288	323889	18-2232	271, 288
314167	18-2024	290, 293, 806	320167	18-2225	288	323890	18-2233	271, 288
314322	18-0935	249, 258	320168	18-2226	288	323943	18-4232	277
314421	18-2877	260	320169	18-2227	288	324073	22423	166
314491	18-7129	296	320170	18-2228	288	324097	18-3179	230
314502	18-3742	800	320303	18-7140	296	324323	18-0106	251, 259
314503	18-3705	800	320305	18-4230	277	324334	18-4276	236, 257
314728	18-7130	296	320311	18-2398	269, 286	324369	18-2399	271, 273, 275, 286, 800
314730	18-3719	795	320499	18-1377	245	324430	18-4277	882-885
314731	18-0195	296	320570	18-4231	277	324449	18-0108	236, 263, 289
314745	18-2231	273, 275, 288, 792	320630	18-2220	284	324639	18-2034	293, 806
314809	18-2858	769, 770, 784, 785	320745	18-2964	250, 255, 256	324670	18-0110	262
314832	18-2389	233, 263	320785	18-3743	277	324701	18-2557	231
314876	18-2874	262	320862	18-2002	293, 806	324717	18-0112	251, 260
315052	18-0973	259	320880	18-1219	238, 240, 241,	324766	18-0198	271, 273, 279, 796
315055	18-0937	785			252, 253, 263	324825	18-8204	135, 229, 767, 834
315189	18-0939	788	320936	18-0540	263	324937	18-2537	263
315232	18-7296	222	320943	18-2704	263	324981	18-7481	234, 235, 262,
315538	18-0941	250, 252, 261	320961	18-8353	263			269, 271, 291
315539	18-2958	254	320981	18-3343	231	325092	18-0118	249-252, 257
315578	18-0424	258	321008	18-2706	234, 235, 263,	325211	18-0120	250, 259
315748	18-2705	232-235, 263, 271, 291			271, 273, 275	325260	18-0122	251, 258
315810	18-4228	800	321027	18-3563	238, 240, 241	325273	18-3800	255
315837	18-3337	232-235, 263	321028	18-2544	250, 251, 261	325398	18-3352	882-885
315868	18-1218	252, 259	321117	18-7141	296	325537	18-0124	233, 262, 267, 290
315869	18-1224	252, 259	321120	18-2536	231	325647	18-3801	251, 255, 256
316499	18-0949	263	321163	18-7510	216, 296, 808	325721	18-2907	251, 261
316506	18-2243	267, 269, 286, 796	321182	18-2545	250, 259	326260	18-2862	251, 259
316563	18-2377	273, 275, 276, 289	321183	18-0979	250, 251, 258	326264	18-0126	251, 259
316705	18-4913	173, 264	321184	18-2546	240, 250, 251, 262	326468	18-0128	250, 252, 260
316706	18-4914	173, 264	321220	18-3565	239-241	326649	18-7174	808

OMC (Cont.)			OMC (Cont.)			OMC (Cont.)		
O.E. #	SIERRA #	PAGE #	O.E. #	SIERRA #	PAGE #	O.E. #	SIERRA #	PAGE #
326716	18-0174	293	332010	18-2888	254	340619	18-3455	231
326741	18-7418		332108	18-2548	239, 249, 250, 262	340919	18-0492	255
326765	18-4292	251-253, 296, 808	332205	18-2064	806	340975	18-70936	249
326849	18-7144	296	332253	18-8352	257	340976	18-70937	249
326877	18-6509	264	332261	18-2065	293	341013	18-1598	791, 792
326926	18-1212	252, 259	332266	18-0130	252, 253, 258	341280	18-8300	289, 293
327031	18-2035	290, 293, 806	332319	18-0987	252, 253, 259	341281	18-8301	289, 293
327035	18-2392	232, 236, 263	332369	18-0977	261	341440	18-9892	169
327361	22423	166	332403	18-2881	264	341501	18-0628	882-885
327606	18-6018	289	332489	18-2309	269, 285, 286	342786	18-8325	271, 293
327655	18-1289	882-885	332491	18-2308	269, 285, 286	342787	18-8326	271, 293
327656	18-0200	273, 275, 279	332514	18-0196	882-885	346004	18-1723	282
327674	18-3899	261	332584	18-7475	296	346007	18-0491	255
327707	18-0134	249-251, 257	332585	18-0559	293, 806	346150	18-9140-9	167, 229
327795	18-3802	250, 252, 255, 256	332598	18-7120	808	346151	18-9135-9	167, 229
327861	18-4280	242	332694	18-2900	258	346152	18-9136-9	167, 229
328283	18-0136	250, 252, 260	332696	18-2903	257	346153	18-9137-9	167, 229
328313	18-1288	267, 284, 286, 287	332816	18-3895	255	346785	18-9132-9	167, 229
328360	18-9885	169	332817	18-3896	255	346786	18-9133-9	167, 229, 426
328361	18-9886	169	332818	18-3897	882-885	346930	18-9126-9	167, 229
328363	18-9887	169	332819	18-3898	255	346931	18-9131-9	167, 229
328364	18-9888	169	332942	18-2075	251-253, 293, 295, 806	347107	18-9129-9	167, 229
328365	18-9889	169	333008	18-0975	250, 252, 258	347108	18-9130-9	167, 229
328366	18-9890	169	333077	18-2219	797	347205	18-0690	260
328367	18-9891	169	333341	16-331-0386	135, 136, 228	348838	18-9127-9	167, 229
328506	18-3937	781	333418	18-2906	257	348839	18-9134-9	167, 229
328516	18-3938	781	333572	18-7145	296	349516	18-9128-9	167, 229
328536	18-3940	781	333592	18-4223	277	349729	18-9139-9	167, 229
328590	18-0138	251, 252, 260	333670	18-3839	253, 255, 256	349759	18-9138-9	167, 229
328603	18-8350	293	333725	18-0197	269, 279	349957	18-9876	168, 792
328604	18-0140	251, 258	333758	18-2708	235, 263, 291	351271	18-1281	882-885
328622	18-0142	251-253, 258	333771	18-0201	269, 279	352165	18-0313	262
328623	18-3837	251, 255, 256	333879	18-0965	253, 260	352670	18-0465	783
328626	18-0144	252, 258	333957	18-1343	269, 285, 799	357159	18-0153	783
328743	18-1726	882-885	334043	18-0626	257	357159	18-0411	783
328751	18-3358	231	334163	18-3766	271, 273, 275, 285, 799	370409	18-3944	781
328753	18-2539	233, 262, 267, 290	334353	18-0437	257	375638	18-3002	229
328755	18-3359	230	334516	18-2216	284	377139	18-1154	279
329076	18-0441	261	334665	18-4197	882-885	377178	18-3003	229
329103	18-2961	254	334726	18-3839	253, 255, 256	377230	18-3083	230
329380	18-7416	251, 296, 808	334742	18-1734	239	377992	18-3005	229
329381	18-7417	251, 296, 808	334897	18-3138	231	378065	18-3543	239
329390	18-3360	233, 236, 261, 289	334913	18-7150	296	378231	18-5437	745
329419	18-3803	251, 255, 256	334950	18-8367	293	378444	18-5807	217, 218, 755, 756
329653	18-8203	135, 229, 767, 834	335334	18-7796	224	378891	18-3006	229
329654	18-8034	135, 229, 767, 834	335359	18-3802	250, 252, 255, 256	378895	18-7093	222
329718	18-0148	250, 251, 258	335360	18-2964	250, 255, 256	379312	18-7038	222
329826	18-0851	250, 262	335361	18-3801	251, 255, 256	379313	18-7094	222
329828	18-1205	252, 260	335403	18-1285	260	379475	18-3086	768, 769
329830	18-1202	252, 261	335523	18-7110	255	379504	18-1350	280
329833	18-1207	252, 259	335523	18-0490	255	379628	18-2192	757
329836	18-3836	252, 255, 256	335633	18-0963	250, 252, 259	379777	18-7801	224
329920	18-2905	251, 261	335677	18-9219	282	379957	18-4218	776
329922	18-2061	293	335679	18-2279	282	380186	18-7071	760
329923	18-2062	293	335722	18-2277	282, 283	380537	18-5345	743
329975	18-0150	Obsolete	335818	18-1283	882-885	380538	18-5311	743
330081	18-4076	244	335819	18-1284	882-885	380541	18-5385	744
330137	18-2001	293, 806	335981	18-1507	239	380542	18-5419	744
330273	18-1221	238, 241, 252, 253, 263	336226	18-0694	260	380543	18-5310	743
330327	18-2063	289, 293-295, 806	336227	18-0693	260	380640	18-3575	767
330412	18-0155	251-253, 262	336232	18-1286	248	380986	18-7258	139, 141
330525	18-6512	264	336388	18-0696	260	381389	18-7200	763
330560	18-3363	231	336389	18-0695	260	381494	18-7609-1	145
330619	18-3295	231	336430	18-0945	251, 259	381668	18-7608-1	145
330621	18-2852	251, 260	336530	18-2709	262	381690	18-7860	767
330698	18-0157	250, 252, 258	336562	18-2216	284	382045	18-7043	222
330818	18-2963	251, 254, 256	336982	18-4253-9	269, 276, 789	382046	18-7043	222
330854	18-1391	245	336982	18-42531-9	276, 789	382047	18-7043	222
330909	18-0159	250, 258	337020	18-1290	267, 284-286	382049	18-7043	222
331103	18-8307	250, 293-295	337068	18-0412	253, 261	382050	18-7010	222
331107	18-3299	231	337772	18-2216	284	382051	18-7010	222
331188	18-7143	808	337774	18-2216	284	382052	18-7024	222
331203	18-2890	257	337778	18-1500	285, 799	382053	18-7024	222
331211	18-3838	255	338484	18-2557	231	382054	18-7010	222
331353	18-7963	263	338504	18-1732	282, 796	382057	18-7026	222
331363	18-2879	251, 258	338518	18-7108	296	382125	18-5344	743
331380	18-7150	296	338534	18-6522	264	382133	18-5375	744
331499	18-2908	257	338813	18-2582	257	382135	18-5314	743
331532	18-0161	253, 258	338876	18-2879	251, 258	382136	18-5338	743
331598	18-0978	251, 253, 258	338878	18-2908	257	382138	18-6754	757
331880	18-3765	882-885	338879	18-2900	258	382218	18-3583	767
331894	18-3566	239	338880	18-2903	257	382296	18-3402	236
331916	18-2913	249, 250, 260	338882	18-2579	257	382343	18-1356	280
331917	18-2938	249, 250, 260	338886	18-2890	257	382354	18-7352	224
331979	18-3133	232-236, 257, 271, 803	339601	18-0692	260	382363	18-7210	222
331980	18-1704	882-885	339620	18-2074	250-253, 293, 295, 806	382385	18-3557	239
331999	18-4826	276	340115	18-3866	252, 255, 256	382407	18-1351	280
332000	18-2769	234, 235, 263, 273	340490	18-2219	284	382408	18-1366	795

OMC (Cont.)			OMC (Cont.)			OMC (Cont.)		
O.E. #	SIERRA #	PAGE #	O.E. #	SIERRA #	PAGE #	O.E. #	SIERRA #	PAGE #
382468	18-3377	232	389275	18-5630	220	395091	18-7350	224
382547	18-3082	230	389275	18-5646	220	395204	18-5825	218
382715	18-6822	826	389455	18-3767	275, 798	395207	18-5600	219
382733	18-7609-1	145	389556	18-4303-1	250	395207	18-5640	219
382821	18-7605-1	145	389576	18-3091	230	395209	18-2187	283
383052	18-7043	222	389589	18-3055	230	395209	18-2187	283
383067	18-7043	222	389613	18-1394	Obsolete	395270	18-3383	233
383087	18-7201	763	389642	18-3043	229	395271	18-3401	236
383307	18-3554	769	389954	18-5634	220	395289	18-3051	230
383440	18-5711	757	389954	18-5647	s/s to 18-5634	395419	18-5808	217
383444	18-5437	745	390055	18-7046	222	395460	18-6501	264
383587	18-5384	744	390076	18-4318	252	395627	18-1374	245
383615	18-7070	760	390078	18-4302	250	395713	18-7352	224
383766	18-7605-1	145	390082	18-3972	242	395861	18-1753	244
383918	18-7095	760	390286	18-3366	230	395864	18-3059	230
384087	18-3336	231	390381	18-3379	233	395867	18-7821	224
384163	18-5630	220	390509	18-3907	242	395911	18-6527	288
384163	18-5646	220	390510	18-3908	242	396041	18-1360	244
384194	18-7605-1	145	390641	18-1396	245	396141	18-5765	212
384195	18-1357	795	390770	18-3380	233	396161	18-6528	288
384719	18-3560	239	390905	22355	166	396235	18-5619	219
384735	18-5418	744	390928	79040	166	396349	18-2660	271, 290, 292
384743	18-7072	760	391170	18-3913	242	396350	18-2656	289
384777	18-5635	220	391264	18-6759	216	396351	18-2658	267, 290, 292
384777	18-5648	220	391300	18-4303-1	250	396352	18-2657	289
384781	18-5671	220, 221	391305	18-7223	222	396355	18-2659	290
384848	38653	166	391416	18-3915	242	396377	18-3910	242
384884	37509	166	391472	18-2187	283	396378	18-3911	242
384956	18-3376	232	391511	18-5619	219	396379	18-3912	242
385043	18-1371	280	391635	18-3378	233	396503	18-3906	242
385068	18-1367	280	391638	18-7350	224	396504	18-3905	242
385072	18-3044	229	391653	18-4101	242	396520	18-7038	222
385356	18-7024	222	391698	18-3327	232, 237	396521	18-7093	222
385416	18-4300	249	391698	18-3400	236, 237	396522	18-7094	222
385503	18-1395	245	391735	18-5635	220	396581	18-4105	242
385529	18-5634	220	391735	18-5648	220	396583	18-4104	242
385529	18-5647	s/s to 18-5634	391798	18-4125	Obsolete	396585	18-4100	242
385662	18-3906	242	391937	18-7223	222	396587	18-4103	243
385781	18-7352	224	391988	18-4304-1	250	396588	18-4100	242
385952	18-5697	221	392061	18-7042	222	396701	18-7042	222
386014	18-1296	245	392061	18-7222	222	396701	18-7222	222
386084	18-3050	230	392123	18-6027	289, 802	396725	18-3053	230
386124	18-3384	233	392133	18-5629	220	396750	18-4310	251
386279	18-3931	242	392133	18-5645	220	396809	18-3368	230
386280	18-3933	242	392455	18-4123	242	396932	18-3385	234
386430	18-6434	219	392462	18-6026	289	396933	18-3399	235
386545	MP39100	215	392475	18-1287	267, 284, 286	396987	18-3557	239
386545	MP39830	215	392550	18-7046	222	397003	18-6525	288
386573	18-2857	249-251, 258	392567	18-4307	251	397004	18-6526	288
386591	18-5629	220	392615	18-4307	251	397023	18-5619	219
386591	18-5645	220	392621	18-4107	242	397087	18-4818	285
386657	18-5635	220	393023	18-6024	271, 273, 275, 289, 801	397131	18-3059	230
386657	18-5648	220	393023	18-6024A	289, 801	397274	18-7350	224
386659	18-2355	283	393061	18-0466	783	397338	18-2207	271, 284, 286
386697	18-3327	232	393088	18-7823	224	397537	18-1363	269, 280, 281
386764	18-1354	269, 280, 281	393103	18-7820	224	397538	18-1364	269, 280, 281
386765	18-1355	269, 280, 281	393159	18-0153	783	397541	18-2288	283
387041	18-1353	244	393185	18-9893	Obsolete	397627	18-2310	269, 285, 286
387094	18-5600	219	393271	18-4120	242	397768	18-6029	802
387094	18-5640	219	393279	18-9894		397839	18-7350	224
387139	18-4040	245	393301	MP39760	215	398042	18-3708-1	277
387142	18-4040	245	393433	18-4305	250	398047	18-4321	252
387247	18-1158	280	393509	18-3381	233	398051	18-2093	282
387262	18-7038	222	393561	18-0927	251, 259	398327	18-7830	130, 335
387277	18-6761	216	393566	18-4122	243	398331	18-6025	207, 289, 801
387284	18-4124	242	393570	18-5628	220	398338	18-7352	224
387285	18-4114	242	393612	18-4102	242	398387	18-7352	224
387326	18-3325	232	393630	18-3382	233, 237, 267	398452	18-7223	222
387361	18-3090	230	393632	18-3367	231	398453	18-7223	222
387656	18-1365	795	393659	18-3543	239-241	398483	18-4064	242
387660	18-4061	242	393896	18-1393	245	398514	18-7821	224
387661	18-4062	242	393924	18-4120	242	398526	18-7046	222
387683	18-5674	221, 320, 321	393942	18-2585	216	398532	18-7043	222
387684	18-5630	220	393988	18-6759	216	398549	18-8009EP-1	131, 228
387684	18-5646	220	394176	18-6759	216	398549	18-8009S	137
387787	18-1361	245	394408	18-1222	238, 241, 252, 253, 262	398602	18-1282	32, 215
387817	18-1117	279	394411	18-1506	239	398729	18-7042	222
387818	18-2252	797	394461	18-4063	242	398729	18-7222	222
387879	18-2250	283	394462	18-1752	244	398901	18-1368	269, 280, 281
388268	18-7352	224	394488	18-4148-1	244	431708	18-6095	289, 802
388344	18-1378	245	394543	18-7352	224	431708	18-6095A	289, 802
388517	37478	166	394546	18-4306	251	431844	18-3974	882-885
388602	18-4301	249	394711	18-3327	232	431870	18-3975	242
388644	18-3403	236	394885	18-4309	251	431897	18-7219	222
388891	18-3238	231	394930	18-3904	242	432072	18-4065	242
389039	18-1358	795	395060	18-3390	234	432073	18-4066	242
389042	18-1370	280	395072	18-3391	234	432077	18-4067	242
389143	18-3388	234	395073	18-3393	235	432078	18-4068	242

OMC (Cont.)			OMC (Cont.)			OMC (Cont.)		
O.E. #	SIERRA #	PAGE #	O.E. #	SIERRA #	PAGE #	O.E. #	SIERRA #	PAGE #
432230	MP28880	32, 215, 751	437059	18-3104	230	509410	18-7275	139
432264	18-1369	269, 280, 281	437090	18-3545	239	510364	18-5224	752
432451	18-7352	224	437155	18-4406	253	510883	18-5226	215
432570	18-4322	252	437228	18-0993	222	552906	18-3744	277
432803	18-4069	242	437327	18-7248	222	553126	18-7172	296
432925	18-5612	219	437409	18-4063	242, 243	554545	18-7146	296
432941	18-3104	230	437725	18-4428	253	580148	18-5156	209
432956	18-3387	234	437779	18-4402	253	580256	18-5200	743
432962	18-7822	224	437801	18-6280	216	580290	18-5157	743
432969	18-4065	242	438039	18-1702	798	580321	18-5199	209
432970	18-4066	242	438040	18-1703	798	580339	18-5750	752
433003	18-4067	242	438399	18-1722	282	581027	18-5750	752
433004	18-4068	242	438529	18-6780	216	581130	18-5163	210
433017	18-2251	283, 286, 287, 797, 798	438531	18-6780	216	581207	18-5141	209
433067	18-1721	269, 282	438555	18-7353	224	581397	18-5755	212
433190	18-79781	227	438556	18-7352	224	581407	18-5196	210
433226	18-6285	216	438562	18-7351	224	581419	18-5205	209
433386	18-7353	224	438592	18-3454	232	581528	18-5814	217
433387	18-7352	224	438616	18-7800	224	581726	18-5754	212
433458	18-6025	207, 289, 801	438786	18-6281	216	581731	18-5753	212
433503	18-1299	280	438996	18-7247	222	581778	18-5709	218
433519	18-7800	224	439015	18-4195	242	581786	18-5172	210
433548	18-3394	235, 237, 269	439071	18-7043	222	582048	18-6761	216
433550	18-2694	269, 291, 292	439072	18-7223	222	582056	18-5756	212
433570	18-2289	285	439073	18-7219	222	582057	18-5757	212
433580	18-6115	289	439076	18-7046	222	582091	18-5192	210
433935	18-3015	229	439078	18-7248	222	582115	18-5762	212
433941	18-4307	251	439079	18-7248	222	582125	18-5759	212
434063	18-2218	797	439138	18-2288	269, 283, 286	582138	18-5760	212
434107	18-3913	242	439141	18-2623	289	582155	18-6761	216
434109	18-3915	242	439202	18-4420	253	582160	18-5194	210
434137	18-3500	239	439476	18-4807	280, 285	582261	18-5764	212
434381	18-4309	251	439515	18-4165	882-885	582262	18-5892	214
434400	18-1703	798	439516	18-4086	242	582285	18-5763	212
434421	18-3392	235, 238, 273, 275	439517	18-4087	882-885	582365	18-5231-1	215
434424	18-3001	229	439521	18-4060	Obsolete	582365	18-8815-1	215
434588	18-1729	285	439538	18-3947	882-885	582365	18-8816-1	215
434839	18-7916	154, 155, 249	439561	18-5828	218	582365	18-8818-1	215
434841	18-3543	239-241	439937	18-6281	216	582366	18-5176	210
434844	18-1376	245	439967	18-2672	805	582382	18-5193	210
434888	18-7046	222	458625	18-0153	783	582399	18-5708	218
435022	18-2251	283, 286, 287, 797, 798	458625	18-0411	783	582400	18-5760	212
435027	18-3346	230	473424	18-1211	782	582452	18-5758	212
435096	18-1703	798	500421	37477	166	582453	18-5758	212
435276	18-4841	276	500422	37478	166	582472	18-5705	217
435277	18-4840	276	500423	37479	166	582508	18-5179	210
435279	18-4843	276	502036	18-1402	676, 781	582556	18-5760	212
435280	18-4842	882-885	502867	18-8063	228	582642	18-5760	212
435390	18-3180	231	502880	18-5196	210	582705	18-5782	213
435442	18-7247	222	502900	18-7875	153	582708	18-5808	217
435443	18-7046	222	502901	18-7876	153, 780	582811	18-5783	213
435491	18-3544	239	502902	18-7824	153	582995	18-5181	210, 303
435548	18-6277	216	502903	18-7879	153	583110	18-5784	213
435673	18-3129	231	502904	18-7878-1	153, 780	583114	18-5761	212
435676	18-7220	222	502905	18-7846	128, 227, 520,	583170	18-5763	212
435677	18-7220	222			766, 831	583266	18-5832	218
435677	18-7221	222	502905	18-7946	128, 227, 766, 831	583380	18-5758	212
435678	18-7220	222	502906	18-7789	128, 227, 766, 831	583408	18-5708	218
435748	18-3059	230	502906	18-7989	128, 227, 766, 831	583473	18-5627	220
435752	18-7220	222	503747	18-8807-1	752	583476	18-5893	214
435760	18-2325	882-885	503748	18-8800-1	752	583482	18-5624	220
435761	18-2328	882-885	503749	18-8811-1	752	583605	18-5891	214
435821	18-3059	230	503749	18-8814-1	752	583689	18-5832	218
435929	18-3315-2	236	503749	18-8841-1	752	583737	18-5176	210
435957	18-3501	224	503750	18-8801-1	752	583740	18-5170	210
435959	18-3405	231	503751	18-8810-1	752	583748	18-5766	212
436195	18-3561	239	503752	18-8802-1	151	583865	18-5885	213
436232	18-2326	282	503752	18-8803-2	753	583896	18-5794	213
436234	18-2327	282	503752	18-8823-1	752	584028	18-5770	213
436235	18-2330	282	503753	18-8842-1	752	584032	18-5771	213
436243	18-4056	Obsolete	503754	18-8820-1	752	584037	18-5893	214
436251	18-3949	Obsolete	503755	18-8802-1	151	584041	18-5772	213
436254	18-3901	242	503755	18-8803-2	753	584107	18-6761	216
436353	18-4088	244	503755	18-8823-1	752	584122	18-5886	214
436354	18-4090	882-885	503756	18-8843-1	752	584128	18-5813	217
436367	18-5886	214	508105	18-2613	784	584329	18-5794	213
436740	18-2251	283, 286, 287, 797, 798	508180	MP39760	215	584331	18-5794	213
436745	18-6024	271, 273, 275, 289, 801	508235	1525607	166	584416	18-5705	217
436745	18-6024A	289, 801	508626	18-3543	239	584424	18-5832	218
436746	18-2218	284	508713	18-0340	783	584476	18-5827	218
436834	18-1725	283	508871	18-0348	783	584477	18-5181	210, 303
436853	18-7247	222, 223	508872	18-0407	783	584488	18-5883	213
436859	18-4079	242	508876	18-0411	783	584489	18-5794	213
436860	18-4190	242	509395	18-7278	139	584561	18-5176	210
436888	18-2252	273, 283, 286,	509404	18-7283	139	584580	18-5823	217
		287, 797, 798	509407	18-7282	139	584632	18-5194	210
436891	18-4323	253	509408	18-7284	140	584641	18-5831	218
436957	18-3389	234	509409	18-7274	139	584642	18-5773	213

OMC (Cont.)			OMC (Cont.)			OMC (Cont.)		
O.E. #	SIERRA #	PAGE #	O.E. #	SIERRA #	PAGE #	O.E. #	SIERRA #	PAGE #
584643	18-5877	216	787145	18-9125	167, 229	911678	18-0211	791, 792
584783	18-5767	212	787145	18-9141	167, 229	911678	18-0227	791, 792
584799	18-5619	219	907761	18-0114	196, 772, 777,	911679	18-0229	791, 792
584818	18-5631	220			784, 786	911680	18-02060	791, 792
584890	18-5826	218	907764	18-0104	784, 786	911681	18-02061	791, 792
584908	18-5768	213	907774	18-3111	768, 769	911685	18-2067	293
584980	18-5632	220	907775	18-2883-1	786	911686	18-7169	296
584981	18-5878	216	907866	18-3731	795	911693	18-1701	796
584985	18-5887	214	907932	18-2830	786	911698	18-0911	787, 791
585001	18-5827	218	908013	18-2875	778	911700	18-7407	296
585050	18-5635	220	908034	18-7859	767	911701	18-2068	293
585050	18-5648	220	908062	18-4251	794, 795	911702	18-2916	769, 788, 791
585051	18-5634	220	908063	18-2176	794, 795	911703	18-3121	769, 791
585051	18-5647	s/s to 18-5634	908064	18-3725	794, 795	911704	18-2541	262
585056	18-5624	220	908069	18-2177	794, 795	911705	18-0166	788
585057	18-5634	220	908079	18-2912	786	911718	18-7408	296
585057	18-5647	s/s to 18-5634	908087	18-2184	797	911734	18-4837	768, 791
585058	18-5635	220	908158	18-3153	234, 236, 257,	911750	18-4828	791, 799
585058	18-5648	220			271, 803	911751	18-3768	277, 791, 799
585059	18-5627	220, 221	908194	18-7400	296	911752	18-3610	791, 799
585060	18-5628	220	908237	18-3881	785	911753	18-3769	791, 795
585061	18-5629	220	908383	18-7401	296	911787	18-2138	802, 805, 861
585061	18-5645	220	908611	18-2946	785	911795	18-8349	293, 806
585062	18-5600	219	908717	18-0183	777	911797	18-2533	794
585062	18-5640	219	908765	18-0435	785	911820	18-4250	789
585063	18-5630	220	908929	18-15455	771	911823	18-2996	784, 789
585063	18-5646	220	908935	18-2850	778	911826	18-2763	792
585134	MP28870	32, 215	909048	18-7477	296	911836	18-2918	784, 789
585145	18-5774	213	909121	18-2183	796	911844	18-3145	769, 791
585189	18-5780	213	909314	18-2902	778	911851	18-7153	296
585219	18-5828	218	909316	18-7403	296	911871	18-7409	296
585261	18-5785	213	909515	18-0548	787	911878	18-0880	788
585267	18-5679	221	909527	18-2768	794	911937	18-3770	791, 793
585269	18-5678	221	909529	18-0947	787	912029	18-4835	791, 795
585459	18-5627	220	909533	18-3365	233-236, 257	912157	18-0190	788
585995	18-5831	218	909613	18-0418	787	912164	18-1204	787
586000	18-5832	218	909747	18-7404	296	912212	18-2146	791, 793
586048	18-5829	218	909748	18-0188	263	912213	18-2128	699, 713, 794, 860
586075	18-5830	218	909753	18-2185	797	912214	18-2104	791, 793
586217	18-5893	214	909758	18-0434	785	912227	18-3879	785
586224	18-5705	217	909786	18-0943-1	777	912374	18-2745	794
586271	18-5831	218	909818	18-15500	771	912405	18-0956	786
586274	18-5617	219	909829	18-0549	789	912418	18-15500	771
586277	18-5631	220, 221	909830	18-0550	789	912424	18-75100	771
586281	18-5635	220, 221	909835	18-0891	788	912441	18-1902	775
586281	18-5648	220	909863	18-1921	776	912442	18-1903	775
586284	18-5632	220, 221	909902	18-0913	264, 804	912471	18-0431	786
586286	18-5612	219	909971	18-15460	771	912477	18-0430	786
586287	18-5612	219	910048	56507	167	912509	18-15435	771
586288	18-5600	219	910113	18-0673	786	912614	18-3502	769
586288	18-5640	219	910139	18-7855	766	912714	18-15520	771
586343	18-5884	214	910169	18-5399	785	912766	18-3878	785
586661	18-5781	213	910236	18-2911	788	912768	18-0464	787
586667	18-5893	214	910305	18-75100	771	912793	18-75125	771
586731	18-5619	219	910343	18-15415	771	912954	18-0468	788
586768	18-6826	220	910384	18-4009	776	912955	18-0405	783
586774	18-5833	217	910414	18-15380	771	912965	18-2845	787
678882	18-7093	222	910582	18-7174	296	912978	18-4408	784
763364	18-7903	154, 155, 157, 249,	910641	18-7792	766	912979	18-1238	783
763735	18-3090	230	910995	18-2216	284	912981	18-0347	787
764354	18-9530-3	159	911019	18-2066	293, 806	912988	18-0887	788
764357	18-9540-3	159	911311	18-7406	296	912989	18-1213	782
771839	18-7920	128, 227, 334,	911616	18-8021	135, 229, 396,	913270	18-0664	787
		422, 626, 766, 832			767, 834	913275	18-0887	788
772577	18-4911	263	911662	18-02062	791, 792	913276	18-2815	788
772578	18-4913	264	911663	18-02063	791, 792	913277	18-0347	787
772579	18-4914	264	911664	18-02064	791, 792	913393	18-0401	786
772584	18-5226	215	911665	18-02065	791, 792	913488	18-75100	771
772681	18-8063	228	911666	18-02066	791, 792	913745	18-0528	782
772831	18-7609-1	145	911667	18-02067	791, 792	913758	18-0352	787
775518	18-3002	229	911668	18-0207	791, 792	913783	18-4431	786
775519	18-3003	229	911669	18-0209	791, 792	913784	18-1909-1	776
775521	18-3006	229	911669	18-0211	791, 792	914036	18-2764	793
775613	18-9013	164	911670	18-0209	791, 792	914323	18-0518	789
775613	18-9024	164	911670	18-0211	791, 792	914445	18-4024	789
775613	18-9065	164	911671	18-0209	791	914488	18-8369	789, 791
775613	18-9080	164	911671	18-0211	791	914555	18-3937	781
775640	18-8056	228	911672	18-0209	791, 792	914556	18-3939	781
775641	18-8092	228	911672	18-0211	791, 792	914557	18-3938	781
777120	18-9540-7	159	911673	18-0209	791, 792	914578	18-0680	787
777130	18-3086	768	911673	18-0211	791, 792	914716	18-2383	797
777213	18-3083	230	911674	18-0209	791, 792	914723	18-0652	799
777228	18-9530-7	159	911674	18-0211	791, 792	914736	18-0655	799
778885	18-7915-1	154, 155, 249, 406	911675	18-0209	791, 792	914743	18-0654	799
778886	18-7896	153, 155, 157, 249, 406	911675	18-0211	791, 792	914787	18-15450	771
778887	18-7897	153, 155, 157, 249, 406	911676	18-0209	791, 792	914816	18-4161	781, 850
778888	18-7895	153, 155, 157, 249	911676	18-0211	791, 792	914817	18-1213	782
787133	18-9125	167, 229	911677	18-0209	791, 792	914820	18-1239	783

OMC (Cont.)			OMC (Cont.)			OMC (Cont.)		
O.E. #	SIERRA #	PAGE #	O.E. #	SIERRA #	PAGE #	O.E. #	SIERRA #	PAGE #
914849	18-3877	785	982515	18-3584	767	985080	18-4484	780
914930	18-3879	785	982517	18-3584	767	985083	18-3937	781
914971	18-3876	785	982537	18-7081	760	985237	18-6759	216
915025	18-2909	787	982539	18-7096	761	985316	18-1401	676, 781
915236	18-4160	781	982554	18-3558	769, 770	985429	18-3583	767
915272	18-2383	797	982650	18-5899	769	985466	18-5951	757
915325	18-3887	785	982706	18-6755	757	985466	18-5957	757
915326	18-0468	788	982880	18-5403	743	985518	18-2674	805
915702	18-2068	293	982946	18-2665	803	985560	18-5313	749
915716	18-2104	791	982947	18-2664	803	985602	18-7278	139, 141
915717	18-2174	793	982948	18-2670	804	985603	18-7278	139, 141
915719	18-0440	787	982949	18-2667	804	985612	18-2671	804
915720	18-4833	768	982957	18-6257	757	985613	18-2672	805
915735	18-5433	744	982997	18-7289	140, 141, 764	985630	18-0868	783
915840	18-2918	789	983195	18-6257	757	985799	18-5837	755
916058	18-2068	293	983218	18-3386	769	985822	18-7615-1	145
916262	18-0183	777	983247	18-6842	604, 757	985966	18-5900	753
976669	18-6020	289, 801	983296	18-3577	767	985966	18-5911	753
979659	18-7072	760	983298	18-3119	768, 769	986007	18-5902	754
979719	18-7080	760	983318	18-6764	758	986007	18-5908	754
979774	18-5803	755	983424	18-5951	757	986008	18-5951	757
980014	18-1712	882-885	983424	18-5957	757	986008	18-5957	757
980152	18-5386	744	983424	18-6842	604, 757	986074	18-3577	767
980183	18-2156	800	983444	18-5900	753	986085	18-4496	Obsolete
980477	18-3583	767	983444	18-5911	753	986086	18-4495	568, 675, 780, 849
980528	18-7608-1	145	983494	18-6101	802	986103	18-0410	783
980530	18-7609-1	145	983538	18-7081	146, 147, 548, 613, 616, 760	986104	18-0410	783
980613	18-5897	769				986120	18-21752-1	794
980617	18-1876	776	983790	18-5900	753	986145	18-2438	882-885
980803	18-5903	754	983790	18-5911	753	986232	18-21754	794
980892	18-5407	743	983825	18-1600	791, 797	986280	18-6779	758
980893	18-5303	743	983826	18-1601	791, 797	986336	18-3937	781
980894	18-5347	743	983836	18-5951	757	986338	18-21751	794
980902	18-5309	749	983836	18-5957	757	986364	18-2673	805
980959	18-1904	775	983836	18-6841	604, 757	986380	18-4806	792
981078	18-5900	753	983836	18-6842	604, 757	986381	18-4804	792
981078	18-5911	753	983855	18-7615-1	145	986382	18-4805	792
981080	18-5312	749	983864	18-7095	760	986423	18-2674	805
981195	18-2071	293, 806	983870	18-7855	766	986505	18-5905	754
981196	18-2072	293, 806	983871	18-7201	763	986505	18-5910	754
981268	18-2073	293, 806	983877	18-1172	791, 795	986620	18-5837	755
981288	18-5902	754	983878	18-1171	791, 795	986629	18-2783	805
981288	18-5908	754	983880	18-2338	791, 793	986642	18-5108	743
981289	18-5901	753	983891	18-1161	280	986643	18-5361	744
981289	18-5907	753	983892	18-1170	791, 795	986651	18-5406	743
981359	18-7615-1	145	983895	18-3058	768, 769	986658	18-0647	799
981428	18-7615-1	145	983902	18-21751	794	986779	18-3575	767
981564	18-7615-1	145	983937	18-2100	793	986782	18-7236	761
981566	18-7229	763	983967	18-4750	791, 799	986783	18-7235	761
981650	18-7268	139, 141	983973	18-2765	793	986784	18-7237	762
981705	18-7615-1	145	984012	18-1602	791, 797	986796	18-7238	762
981790	18-7018	760	984054	18-1901	775	986799	18-7237	762
981797	18-2663	803	984180	18-7609-1	145	986800	18-7239	762
981799	18-2666	803	984264	18-6399	791, 793	986804	18-7241	762
981801	18-2669	804	984290	18-21752-1	794	986865	18-7229	763
981803	18-7615-1	145	984356	18-6814	758	987136	18-5303	743
981821	18-5903	754	984360	18-3575	767	987251	18-2791	805
981911	18-7861	767	984398	18-5353	744	987313	18-7242	762
982019	18-6950	758	984401	18-5352	744	987315	18-7243	762
982058	18-6755	757	984456	18-5905	754	987317	18-7244	762
982063	18-7267	139, 141	984456	18-5910	754	987319	18-7245	762
982069	18-6764	758	984458	18-2672	805	987438	18-7246	762
982073	18-6764	758	984459	18-2673	805	987440	18-7246	762
982121	18-5900	753	984461	18-3212-1	769	987447	18-3577	767
982121	18-5911	753	984461	18-3348	769, 791	987467	18-2765	793
982132	18-2595	293	984487	18-7086	760	987485	18-7246	762
982195	18-5902	754	984491	18-7854	766	987603	18-2673	805
982195	18-5908	754	984513	18-6028	802, 862	987661	18-2245-1	794
982202	18-5901	753	984513	18-6028A	802, 862	987678	18-2246	794
982202	18-5907	753	984513	18-6102	802, 862	987738	18-5888	745
982209	18-5376	744	984536	18-6270	753	987739	18-5889	745
982211	18-5404-1	743	984536	18-6276	753	987740	18-5890	745
982217	18-7608-1	145	984537	18-21754	794	987774	18-6261	757
982217	18-7609-1	145	984547	18-6103	802	987784	18-1922	776
982219	18-7608-1	145	984547	18-6103A	802	987811	18-5920	547, 753, 822, 824
982223	18-7615-1	145	984628	18-5917	754	987894	18-5303	743
982230	18-7862	767	984629	18-21755	794	987895	18-5347	743
982240	18-7278	139, 141	984744	18-3206	768, 791	987925	18-5258	742
982277	18-6019	801	984765	18-4806	792	987970	18-4496	Obsolete
982336	18-5369	744	984770	18-4804	792	987986	18-5413	744
982342	18-5411	744	984771	18-4805	792	987995	18-7650	758
982352	18-7018	760	984876	18-3578	767	988013	18-6270	753
982364	18-5951	757	984982	18-5902	754	988013	18-6276	753
982364	18-5957	757	984982	18-5908	754	988037	18-7330	140, 764, 829
982384	18-7070	760	985050	18-2218	284	988162	18-0410	783
982422	18-1099	799	985052	18-7017	760	988163	18-4495	568, 675, 780, 849
982424	18-2186	797	985063	18-5812	755	988217	18-5919	753
982438	18-6019	801	985064	18-5801	755	988247	18-6841	604, 757

OMC (Cont.)			OMC (Cont.)			OMC (Cont.)		
O.E. #	SIERRA #	PAGE #	O.E. #	SIERRA #	PAGE #	O.E. #	SIERRA #	PAGE #
989966	18-2218	284	3854190	18-5920	753	5033919	18-7897	153, 155, 157, 249, 406
1984462	18-5717	755	3854194	18-6291	755			
3850216	18-5811	755	3854217	18-5248	744	5035703	18-7895	153, 155, 157, 249
3850357	18-7677	758	3854252	18-3939	781	5035974	18-7953	227
3850379	18-1238	783	3854269	18-0868	783	5036216	18-3498	224
3850396	18-7684	758	3854280	18-7330	829	5036972	18-6945	220, 398
3850426	18-1074	793, 794	3854286	18-3060	835	9484748	18-7634	802
3850456	18-1909-1	776	3854299	18-3879	785	14079398	18-0411	576, 577, 688, 783
3850495	18-2875	778	3854311	18-5408	744	584605, 586275	18-6863	220
3850496	18-0943-1	777	3854331	18-5362	744	85R-4541	18-7096	761
3850595	18-0893	788	3854339	18-4495	849	PERKINS		
3850597	18-2791	805, 864	3854406	18-0410	783	2654347	18-7887	Obsolete
3850809	18-7326	140, 621, 764, 829	3854512	18-7703	758	2654403	18-7886	152, 157, 581
3850810	18-7331	140, 764, 829	3854548	18-5354	743	2654407	18-7887	Obsolete
3850812	18-2174	793	3854549	18-5405	744	185086600	18-6944	579
3850813	18-2128	699, 713, 794, 860	3854620	18-7326	829	PLEASURECRAFT		
3850814	18-2337	792	3854751	18-5913	754	47047	18-7976	520, 548
3850815	18-2146	793	3854809	18-6261	757	3705042	18-0889	552
3852109	18-0874	785	3854905	18-7679	758	R017066	18-3700	553
3852113	18-0876	785	3854942	18-0311	787	R020027	18-7677	548
3852350	18-4194	800, 861	3854956	18-0518	789	R020035A	18-7646	548
3852374	18-1986-1	775	3855104	18-7792	766	R077001	18-7875	153, 553
3852384	18-2339	793	3855182	18-7889	758	R077002	18-7824	153, 553, 565
3852455	18-0183	777	3855270	18-1296	245	R084003	18-7697	548
3852477	18-0891	788	3855270	18-1909-1	776	R096117	18-3200	553
3852531	18-7407	296	3855412	18-6028	802	R098002	18-5727	547
3852548	18-8349	293, 806	3855412	18-6028A	802	R103001	18-5404-1	540, 541
3852560	18-2996	789	3855412	18-6102	802	R103003	18-5407	540, 541
3852563	18-1713	791, 792	3855958	18-7330	829	R103004	18-5403	540, 541
3852565	18-7153	296	3855991	18-3574	768	R103011	18-5245	541
3852568	18-4749-9	791, 792	3856127	18-1400	676, 781	R108001	18-5376	540, 542
3852648	18-3730	791, 800	3856138	18-1237	783	R114001	18-5314	540, 541
3852654	18-0468	788	3856600	18-6261	757	R114002	18-5303	540, 541
3852655	18-0405	783	3857561	18-6261	757	R114004	18-5314	540, 541
3852656	18-0322	788	3857650	18-7330	829	R115001	18-5338	540, 541
3852657	18-0519	782	3857723	18-1986-1	775	R115002	18-5345	540, 541
3852687	18-0664	787	3857944	18-1909-1	776	R117001	18-5434	546
3852691	18-0887	788	3857985	18-7331	829	R117012	18-7648	546
3852692	18-2815	788	3857986	18-7326	829	R119001	18-5450	546
3852693	18-0347	787	3858261	18-7326	829	R130001	18-5801	547
3852696	18-2779	777	3858437	18-21752-1	794	R142006	18-2434	476, 553
3852741	18-2780-1	834	3858714	18-7331	829	RA057004	18-3584	549
3852742	18-2781	777	3858868	18-4496	782	RA057018	18-3583	549
3852824	18-0147	787	3860095	18-1233	757	RA057019	18-3577	549
3853132	18-0518	789	3860171	18-6261	757	RA057023	18-3586	549
3853226	18-4024	789	3911020	18-4173	781, 850	RA057024	18-3587	549
3853256	18-0680	671, 691, 787	3911023	18-4164	781, 850	RA0970007	18-6450	539, 547
3853268	18-3937	781	3921473	18-0466	783	RA097002	18-5951	547
3853336	18-2946	785	3923440	18-0466	783	RA097002	18-5957	547
3853340	18-4161	781, 850	3930912	18-0346	787	RA097003	18-5951	547
3853341	18-1213	782	3931593	18-0348	783	RA097003	18-5957	547
3853342	18-0327	787	3935449	18-0980	788	RA097006	18-5957	547
3853361	18-0903	787	5000074	18-1702	798	RA097006	18-5957	547
3853380	18-3876	785	5000309	18-8383	292	RA097006B	18-5984	547
3853477	18-4160	781, 850	5000356	18-4801	276	RA097007B	18-6288	547
3853510	18-1232	783	5000363	18-1703	798	RA097007C	18-6453	547
3853511	18-3874	785	5000400	18-4421	253	RA097009	18-6452	547
3853512	18-0468	788	5000581	18-6528	288	RA107001	18-5309	543
3853528	18-1234	782	5001036	18-3546	239	RA108002	18-5369	541, 542
3853655	18-2068	293	5001344	18-5768	213	RA108003	18-5352	540, 542
3853732	18-3883	785	5001593	18-3059	230	RA108009	18-5244	542
3853742	18-0183	777	5001595	18-3315-2	236	RA122001	18-5903	547
3853796	18-3584	768	5004257	18-1703	798	RA122001	18-5920	547
3853799	18-3558	769, 770	5004632	18-4800	276	RA122001	18-5901	546
3853818	18-6028	802	5004705	18-4148-1	244	RA122008	18-5907	546
3853818	18-6028A	802	5005113	18-6801	217	RA122008	18-5907	546
3853818	18-6102	802	5005114	18-6802	217	RA122009	18-5603	546
3853827	18-1230	782	5005114	18-6865	413	RA122009	18-5902	546
3853847	18-1401	676, 781	5005115	18-6803	217	RA122009	18-5908	546
3853850	18-3583	768	5005254	18-6281	216	RA122019	18-6443	546
3853862	18-21753	794	5005266	18-7722	227	RA970007	18-6450	539, 547
3853912	18-0410	783	5005401	18-4802	276	RK122014	18-5920	547, 753, 822, 824
3853913	18-0410	783	5005440	18-3543	239	RM0002	18-0677	550, 552
3853917	18-21752-1	794	5005831	18-6815	216	RM0003	18-0878	552
3853945	18-6779	758	5006373	18-8384	292	RM0007	18-0183	550, 552, 561
3853960	18-3937	781	5006511	18-3453	232	RM0017	18-0898	552
3853962	18-21751	794	5007662	18-6803	217	RM0032	18-3883	553
3854001	18-5108	744	5030087	18-3735	277	RM0099	18-0676	552
3854002	18-5443	745	5030699	18-3499	224	RN0067	18-7227	547
3854003	18-5107-1	744	5031411	18-7915-1	406	RN0116	18-7081	548
3854017	18-3575	768	5031456	18-8337	292	RN0116-2	18-7081	548
3854033	18-1402	676, 781	5032238	18-7719	227	RN0118	18-7096	548
3854095	18-1231	783	5032323	18-7716	227	RN0118-1	18-7017	548
3854118	18-3577	767	5032424	18-7773	222	RN0120	18-7096	548
3854127	18-2765	793	5033102	18-7903	406	RN0120-1	18-7017	548
3854158	18-7601	758	5033112	18-3099	230	RO096116	18-4220	553
3854159	18-7602	Obsolete	5033372	18-3497	224	RO20001	18-5899	549
3854182	18-6261	757	5033539	18-7896	153, 155, 157, 249, 406			

Pleasurecraft (Cont.)			Rochester (Cont.)			Suzuki (Cont.)		
O.E. #	SIERRA #	PAGE #	O.E. #	SIERRA #	PAGE #	O.E. #	SIERRA #	PAGE #
RO26002E	18-3551	549	17059054	18-7609-1	143-145, 611, 612, 759, 760	09282-24003	18-8321	Obsolete
RO28001	18-1996	550, 551				09282-24004	18-0544	409
RO29001	18-1899	550, 551	17059057	18-7608-1	143-145, 611-613, 759, 760	09282-30007	18-0546	409
RO47111	18-7480	549				09283-10011	18-0551	409
RO85035	18-2103	553	17059280	18-7615-1	143, 144, 612, 614	09284-08003	18-0569	409
RO94020A	18-2702-1	553, 733	17059280	18-7617-1	143-145, 612, 613	09289-10002	18-0545	409
RO96081	18-4214	553	17059283	18-7619-1	143, 144, 612, 613	09289-22007	18-8345	408, 409
RP026002E	18-3671	549	17059287	18-7616-1	143, 144, 612, 614, 615	09381-14001	18-42940-9	405
RP061015	18-3060	549				09381-18002	18-42950-9	405
RP061017	18-3061	549	17059288	18-7615-1	143, 145	09381-20003	18-42960-9	405
			17059289	18-7618-1	143, 144, 612-614	09420-04009	18-3404	402
			17059290	18-7616-1	143, 144, 612, 614, 615	09420-05005	18-3296	402
POWER POLE						09420-05006	18-3291	402
PUMP PRO-F	18-6819	60	17059291	18-7605-1	143-145, 611, 613, 759, 760	11141-87D90	18-3825	406
PUMP SPN-F	18-6818	60				11141-87E90	18-3822	406
PRESTOLITE						11141-92D01	18-3817	406
873051	18-6881	826	17059292	18-7605-1	613, 759, 760	11141-93901	18-3808	405
110-258	18-6955	578, 824				11141-94401	18-3810	405
110-258A	18-6955	578, 824	17059298	18-7619-1	143-145, 612, 613	11141-94506	18-3823	406
15-79	18-5840	484, 496, 517, 601	17068453	18-7855	766	11141-94600	18-3824	406
ETK 4001	18-6754	757	17078904	18-7854	766	11141-94701	18-3820	406
ETK 4101	18-6754	757	17080560	18-7616-1	143, 144, 612, 614, 615	11141-94702	18-3820	406
ETK 4102	18-6754	757				11141-95305	18-3813	405
EVD 4001	18-6755	757	17080561	18-7615-1	143, 145	11141-95505	18-3814	406
EVD 4002	18-6755	757	17080561	18-7618-1	143, 144, 612-614	11141-95D90	18-3819	406
HYK4001	18-6274	826	17080562	18-7618-1	143, 144, 612-614	11141-96303	18-3809	405
SAW4201	18-5840	484, 496, 517	17080564	18-7605-1	143-145, 611, 613, 759, 760	11141-98101	18-3807	405
SAW4206	18-5807	217, 755				11141-98401	18-3806	405
SAW4207	18-5840	484, 496, 517, 601	17080565	18-7605-1	143-145, 611, 613, 759, 760	11141-98504	18-3816	406
SAW4210	18-5840	484, 496, 517, 601				11141-98522	18-3816	406
VSH-6201 AFY	18-5711	757	17081060	18-7610-1	143, 144, 611, 612	12110-93120	18-40140	405
VSH-6201ACY	18-5712	484, 485	17081299	18-7619-1	143-145, 612, 613	12110-94400	18-40110	405
VSH-6201ADY	18-5727	547	17082403	18-7607-1	143, 518	12140-93121	18-39480	405
VSH-6201JY	18-5710	484, 496, 518	17083522	18-7619-1	143-145, 612, 613	12140-94400	18-39540	405
			17085013	18-7615-1	143, 145	12151-92502	18-42870	405
RACOR			SEA-DOO			12151-93100	18-42860	405
B32013	18-7928	84, 127, 227, 334, 422	278-000-123	18-6878	471	12151-94400	18-42850	405
B32020MAM	18-7929	84, 127, 227, 334, 422, 626, 766, 832	278-000-186	18-6868	470	12161-93902	18-1757	405
RK10012	18-7394	127	278-000-311	18-6868	470, 472	12161-93902	18-1757K	405
RK10222	18-7987	128, 129, 400	278-000-316	18-6868	470, 472	12161-94400	18-1759	405
RK22244	18-0179	127	278-000-484	18-6867	470	12161-94400	18-1759K	405
RK22628	18-9884	127, 129, 130	278-000-485	18-6867	470	12161-96300	18-1758	405
S3213	18-7919	127, 227, 334, 422, 626, 627, 766, 832	278-000-576	18-6866	470	12410-96351-050	18-39530	405
			278-000-577	18-6866	470	13119-91J00	18-0792	404
S3214	18-7920	128, 227, 334, 422, 626, 766, 832	278-001-038	18-6866	470	13910-87D00	18-7752	400
			278-001-239	18-6879	471	13910-89J01	18-7773	399
S3227	18-7948	129, 334, 422, 626, 766, 832	278-001-292	18-6871	471, 472	13910-94400	18-7753	400
			278-001-300	18-6867	470	13910-94701	18-7754	400
S3232	18-7949	129, 422, 626, 766, 832	278-001-301	18-6866	470	13910-95D00	18-7755	400
			278-001-376	18-6859	470	15170-91J00	18-3497	399
S3240	18-7947	129, 422, 626, 766, 832	278-001-497	18-6869	470	15170-93911	18-3495	399
			278-001-554	18-6876	471	15170-94320	18-3496	399
ROCHESTER			278-001-581	18-6874	471	15170-94J00	18-3498	399
1708563	18-7616-1	143, 145	278-001-802	18-6859	470	15170-94JOV	18-3498	399
7036543	18-7609-1	143-145, 611, 612, 759, 760	278-001-935	18-6867	470	15170-99E00	18-3499	399
			278-001-936	18-6869	470, 472	15410-87J10	18-7716	400
7040080	18-7608-1	143-145, 611-613, 759, 760	290-888-993	18-6905	470	15410-87J30	18-7953	400
			290-888-999	18-6905	470, 472	15410-94400	18-7735	400
7040082	18-7609-1	143-145, 611, 612, 759, 760	420-888-9933	18-6905	470	15410-96J00	18-7711	400
			420-888-994	18-6905	470, 472	15410-98500	18-7719	400
7040083	18-7608-1	143-145, 611-613, 759, 760	420-888-996	18-6905	470, 472	15412-93J00	18-7936	400
			SHERWOOD PUMP			16510-05240	18-7903	154, 157, 406
7040089	18-7608-1	143	9959	18-3060	476	16510-61A20-MHL	18-7896	153, 406
7041369	18-7609-1	143-145, 611, 612, 759, 760	10615	18-3061	476	16510-82703	18-7897	153, 157, 406
			10927	18-3168	476, 498, 521	16510-87J00	18-7915-1	154, 157, 406
7042183	18-7608-1	143-145, 611-613, 759, 760	10931	18-3140	476	16510-93J00	18-7895	153, 157
			12322	18-3169	476	16510-96J00	18-7905	154, 157, 406
7043182	18-7609-1	143-145, 611, 612, 759, 760	12859	18-3169	476	17400-87D11	18-3253	403
			18200	18-3077	475	17400-87E03	18-3254	403
7043183	18-7608-1	143-145, 611-613, 759, 760	10615K	18-3047	475, 835	17400-90J11	18-3258	403
			9959K	18-3046	475, 498	17400-92D01	18-3255	403
7043184	18-7608-1	143-145, 611-613, 759, 760	9979K	18-3079	835	17400-93-J00	18-3264	403
			SUZUKI			17400-93951	18-3256	403
7044182	18-7609-1	143-145, 611, 612, 759, 760	09141-14008	18-3710	407	17400-94611	18-3257	403
			09141-18005	18-3726	407	17400-94700	18-3243	403
7044185	18-7603-1	142, 144, 611, 613, 614	09168-10022	18-8331	407, 408	17400-95550	18-3244	403
			09204-02004	18-3737	407	17400-96350	18-3242	403
7044291	18-7618-1	143, 144, 612-614	09204-03003	18-3735	407	17400-96351	18-3242	403
17057283	18-7605-1	143-145, 611, 613, 759, 760	09204-03004	18-3735	407	17400-98551	18-3259	403
			09263-14022	18-1414	405	17400-98652	18-3260	403
17057285	18-7605-1	143	09263-18016	18-1415	405	17400-98661	18-3266	404
17057287	18-7616-1	143, 144, 612, 614, 615	09263-20051	18-1412	405	17400-98J00	18-3267	404
			09263-20072	18-1417	405	17411-93901	18-3480	404
17057298	18-7615-1	143, 145	09263-27005	18-1416	405	17411-94421	18-3481	404
17059052	18-7608-1	143-145, 611-613, 759, 760	09280-08008	18-7118	408, 409	17461-87E11	18-3049	402
			09280-08008	18-7118	408, 409	17461-87E12	18-3049	402
			09280-75002	18-7140	409	17461-90J00	18-3023	402
						17461-90J01	18-3023	402

Suzuki (Cont.)			Suzuki (Cont.)			Volvo (Cont.)		
O.E. #	SIERRA #	PAGE #	O.E. #	SIERRA #	PAGE #	O.E. #	SIERRA #	PAGE #
17461-92D02	18-3000	402	38100-87J11	18-6793	399	418445	18-2936	857
17461-93001	18-3092	402	38100-87J11	18-6837	201, 399	418754	18-2975	882-885
17461-93003	18-3092	402	38100-87J20	18-6793	399	418870	18-2922	855
17461-93004	18-3092	402	38100-87J20	18-6837	201, 399	419310	18-2965	853
17461-93901	18-3099	402	38100-92E00-0ED	18-6786-1	399	419652	18-4474	847
17461-93902	18-3099	402	48600-94511-0ED	18-6865	399	419653	18-4473	847
17461-93J00	18-3035	402	55125-87D00	18-6033	407	419678	18-2923	856
17461-94500	18-3023	402	55125-96310	18-6098	407	419734	18-4468	847
17461-94501	18-3023	402	55320-95310	18-6032	407	419735	18-4470	847
17461-94502	18-3023	402	56132-95J00	18-0650	407	423135	18-7926	152
17461-94503	18-3023	402	57630-92E00	18-3775	407	430017	18-2518	882-885
17461-94504	18-3023	402	57630-94300	18-3777	407	430018	18-2525	857
17461-94505	18-3023	402	57630-94500	18-3774	407	430020	18-2994	858
17461-94506	18-3023	402	57630-96300	18-3778	407	430039	18-2924	856
17461-94510	18-3023	402	57633-87D30	18-3795	882-885	430107	18-2812	853
17461-94511	18-3023	402	57633-94500	18-3798	882-885	430143	18-7878-1	153
17461-94520	18-3023	402	57633-96300	18-3799	882-885	430172	18-2526	857
17461-94700	18-3094	402, 403	65700-87J10	18-8035EP-1	134, 401	461092	18-2925	855
17461-94701	18-3094	402	65700-95513	18-8018EP-1	133, 401	461511	18-1479	847
17461-95300	18-3095	402, 403	65720-94401	18-80409	401	461618	18-2811	853
17461-95301	18-3095	402	65720-94411	18-8087	402	462623	18-2966	854
17461-95302	18-3095	402	65720-986B0	18-80425	401	463377	18-4029	847
17461-96301	18-3096	402	65740-95500	18-8078	402	463505	18-7890	848
17461-96311	18-3096	402, 403	65750-87J10	18-80419	401	463587	18-2926	856
17461-96312	18-3096	402	65750-87J11	18-80419	401	463902	18-4245	848
17461-98501	18-3097	402	65750-94404	18-80418	401	463904	18-4247	848
17461-98502	18-3097	402	65750-95500	18-8079	396, 402	463999	18-2927	856
17461-98503	18-3097	402	65750-95510	18-8079	402	466634	18-7880	152, 155, 581, 848
17462-93990	18-3292	402	65750-98505	18-8062	402	466987	18-7942	129, 832
17471-87D01	18-3189	402	990C0-10W40-1GL	18-9551-3	160	477024	18-4200	848
17471-87E01	18-3192	403	990C0-10W40-1QT	18-9551-2	160	477556	18-0034	152, 581, 848
17471-92D10	18-3193	403	99105-00192	18-8071	402	478736	18-0033	152
17471-93902	18-3190	403	99105-00193	18-8078	402	502036	18-1402	676, 781, 850
17471-94501	18-3191	403	99105-20004-BWL	18-7922	127-129, 226, 227, 333, 334, 400, 422, 766	803762	18-1727	848
17471-98503	18-3188	402				804190	18-0184	860
17472-91J00	18-0761	404	99105-20005	18-7948	129, 400	804261	18-4259	857
17472-92D10	18-0479	404	99105-20006	18-7947	129, 400	804695	18-2039	864
17472-93911	18-0478	404	99105-20006-BWL	18-7987	129, 400	806256	18-3106	834
17472-93J00	18-0778	404				807036	18-4216	843
17472-95200	18-0459	403, 404, 408				808007	18-3274	835
17472-95310	18-0460	403, 404, 408	288182	18-6263	555	812994	18-4150	844
17472-96301	18-0461	403, 404, 408	288759	18-6263	555	813967	18-8368	860
17472-98503	18-0477-9	404	299381	18-7884	152	814219	18-4254	861
17472-98611	18-0480	404	301068	18-6140	478	814301	18-2153	861
17472-98J00	18-0651	407	301069	18-6141	478	814356	18-2939	858
17491-93903	18-3099	230				820545	18-6822	826
17582-93J00	18-0793	404				824633	18-2928	855
17685-87D10	18-0797	404	541663	18-5943	823	824677	18-2989	855
17685-97J00	18-0794	404	2541451	18-5939	823	824803	18-7099	828
17685-98J00	18-0795	404	A0002655299	18-6848	824	826341	18-4204	860
17685-99E00	18-0796	404	A13N147M	18-5959	823, 824	826423	18-75125	837
25223-94400	18-8334	407, 408	A13N148M	18-5959	823, 824	826493	18-7281	139, 141
25700-87D00	18-8335	408	A13N1M	18-5959	822	826495	18-5959	822
25700-90J01	18-8373	408	A13N234	18-5939	823	826648	18-7888	834
25700-92J00	18-8374	408	A13N259	18-5943	823	827247	18-2045	864
25700-93J00	18-8380	407	A13N2M	18-5959	823, 824	829207	18-15460	837
25700-94400	18-8337	408				829592	18-4219	843
25700-94500	18-8338	408				829620	18-4464	847
25700-94700	18-8339	408	35254	18-5436	817	829714	18-2934	857
25700-95500	18-8340	408	72021	18-6846	578, 823	829913	18-8124	129, 832
25700-95D00	18-8341	408	82744	18-4217	843	831009	18-3106	834
25700-95J00	18-8385	409	82745	18-4218	843	831617	18-2527	857
25700-98J00	18-8386	409	125017	18-7178	864	831622	18-2519	857
25700-99E00	18-8381	407	174448	18-9098	800, 859	831891	18-2528	857
31100-89J00	18-6419	398	181620	18-2057	864	831892	18-2529	857
31100-90J00	18-6831	398	192212	18-4201	848	832570	18-4206	860
31100-92E00	18-6417	397	233991	18-6872	578, 822	832598	18-6000	862
31100-93J00	18-6941	398	240149	18-5306	815	832598	18-6000A	862
31100-94600	18-6827	398	240501	18-6872	578, 822	832598	18-6104	862
31100-94601	18-6827	398	241669	18-5393	816	832669	18-2990	858
31100-94610	18-6416	397	241812	18-6271	825	832675	18-2199	858
31100-94610	18-6827	398	243460	18-5305	815	832820	18-4205	860
31100-94702	18-6429	398	243653	18-5342	815	832831	18-2776	844
31100-95600	18-6414	398	243658	18-5394	882-885	832846	18-2778	844
31100-95J00	18-6945	398	243797	18-5356	816	832965	18-4234	860
31100-95J01	18-6945	220, 398	243799	18-5305	815	833188	18-4463	847
31100-96J00	18-6941	398	243801	18-5319	815	833274	18-3842	854
31100-96J01	18-6941	398	243903	18-5428	811, 812, 815, 816	833453	18-3834	854
31173-95310	18-56008	398	273663	18-7783	829	833950	18-4005	848
31173-99E00	18-56009	399	275595	18-3167	882-885	833995	18-3076	835
37110-99-E00	MP51010	25, 399	324825	18-8204	135, 229, 767, 834	833996	18-2044	864
37110-99-E00	MP51012	25, 399	328516	18-3938	850	834337	18-7884	152, 157, 158, 581, 814, 848
38100-87000-0IT	18-6785	399	329653	18-8203	135, 229, 767, 834			
38100-87D10-0ED	18-6786-1	399	370409	18-3944	850	834476	18-2531	882-885
38100-87D10-0IT	18-6786-1	399	416033	18-2933	855	834520	18-5806	825
38100-87D10-35J	18-6786-1	399	418265	18-2974	882-885	834548	18-4044	847
38100-87E10-0ED	18-6785	399	418411	18-2935	857	834560	18-5348	815
38100-87E20-0ED	18-6785	399	418412	18-2937	857	834609	18-5959	822

Volvo (Cont.)			Volvo (Cont.)			Volvo (Cont.)		
O.E. #	SIERRA #	PAGE #	O.E. #	SIERRA #	PAGE #	O.E. #	SIERRA #	PAGE #
834751	18-2766	859	854346	18-6770	826	875781	18-3656	845
834893	18-5900	821	855326	18-5900	821	875784	18-3658	845
834893	18-5911	821	855326	18-5911	821	875785	18-3659	845
834963	18-5959	822	855383	18-2991	840, 843, 856	875787	18-3660	845
834975	18-5425	812, 813, 815, 816	855387	18-1930-1	840	875791	18-3663	845
835304	18-5314	815	855389	18-5661	882-885	875794	18-3662	845
835390	18-3583	834	855507	18-6456	859	875795	18-3664	845
835417	18-0398	855	855798	18-5657	821	875796	18-3665	845
835440	18-7824	153	855845	18-5403	815	875805	18-6005	862
835512	18-3060	835	855889	18-7072	828	875808	18-3080	836
835576	18-7859	832	855967	18-2991	840, 843, 856	875815	18-6009	862
835702	18-5369	816	856028	18-2929	858	875815	18-6009A	862
835704	18-5345	815	856034	18-2949	856	875821	18-6010	862
835705	18-5303	815	856037	18-2995	855	875821	18-6010A	862
835804	18-1931-1	840	856044	18-2928	855	875821	18-6106	862
835874	18-3047	835	856116	18-2909	855	875822	18-2775	844
835874	18-3061	835	856306	18-70704	837	875826	18-2744	859
835966	18-2949	856	856364	18-3583	834	875827	18-2755	859
835998	18-5434	817	856470	18-7099	828	875828	18-2757	859
837924	18-6872	578, 822	856471	18-7000	828	875847	18-2774	844
838513	18-70704	837	856472	18-7000	828	875848	18-2758	859
838593	18-7940	129, 832	856474	18-3876	491, 535, 553, 571-574, 685, 686, 689, 785, 854	876037	18-5704	825
838637	18-4466	847				876038	18-6271	825
838638	18-4471	847	856609	18-3577	834	876039	18-5705	825
838928	18-6021	863	856883	18-1931-1	840	876040	18-6266	825
838929	18-6001	862	856891	18-1935-1	841	876097	18-3656	845
839423	18-4208	860	856894	18-1932	840	876120	18-3287	835
839430	18-6790	826	857037	18-1936	840	876185	18-7890	848
839534	18-4209	860	858201	18-7858	129	876267	18-8358	864
840808	18-5906	822	858467	18-3175	834	876268	18-8359	864
841070	18-5352	816	858488	18-7907	848	876278	18-4204	860
841161	18-7286	140, 141, 829	859155	18-3843	854	876279	18-2366	860
841162	18-7862	832	859647	18-3867	854	876294	18-2744	859
841177	18-6268	825	860874	18-7940	129, 832	876300	18-2998	853
841207	18-3876	491, 535, 553, 571-574, 685, 686, 689, 785, 854	861250	18-0307	856	876302	18-2813	852
			861251	18-0310	856	876303	18-3870	852
			861477	18-8126	129, 832	876305	18-3662	845
841243	18-5411	812	862293	18-7888	834	876306	18-2814	852
841244	18-5375	816	870670	18-6271	825	876314	18-0252	852
841262	18-5349	815	870690	18-5357	816	876337	18-2816	853
841263	18-5358	816	870998	18-6958	579, 822	876342	18-2983	853
841292	18-7000	828	872022	18-6846	578, 823	876356	18-2980	853
841380	18-59700	822, 823	872066	18-7647	833	876358	18-2982	853
841640	18-3586	834	872235	18-5939	823	876359	18-2817	853
841750	18-7879	153	872241	18-6292	822	876376	18-4342	852
841762	18-5959	822	872272	18-6268	825	876380	18-4341	852
841762	18-59700	822, 823	872300	18-6266	825	876384	18-0489	852
841763	18-59700	822, 823	872449	18-6838	826	876392	18-2726	863
841765	18-5959	822	872449	18-6881	826	876433	18-2818	853
841765	18-59700	822, 823	872757	18-6846	578, 823	876631	18-2758	859
841766	18-5959	822	872793	18-6124Z	862	876633	18-2757	859
841766	18-59700	822, 823	872926	18-5943	823	877066	18-3275	835
841821	18-15430	837	873051	18-6838	826	877349	18-3658	845
841907	18-5403	815	873178	18-6004	862	881681	18-6872	578, 822
841926	18-5353	816	873178	18-6004A	862	881682	18-6958	579, 822
841994	18-7086	828	873178	18-6105	862	897367	18-4214	861
842775	18-6872	578, 822	873179	18-6000	862	897426	18-2041	864
843511	18-6872	578, 822	873179	18-6000A	862	897707	18-2104	860
845261	18-4007	841	873179	18-6104	862	897720	18-6792	826
845792	18-75125	837	873228	18-2432	858	897873	18-4239	861
845940	18-6846	578, 823	873229	18-2433	858	908611	18-2946	853
847741	18-0032	152, 581, 848	873395	18-6123Z	862	912213	18-2128	699, 713, 794, 860
850046	18-6791	826	873635	18-6846	578, 823	912227	18-3879	854
850785	18-4210	860	873757	18-6846	578, 823	912957	18-0519	851, 852
850834	18-6758	826	873770	18-5939	823	912979	18-1238	853
850888	18-4211	860	875192	18-2625	864	914323	18-0518	851
850889	18-4212	861	875383	18-3209	836	914445	18-4024	851
851120	18-6951	825	875400	18-2983	853	914556	18-3939	850
851261	18-4213	861	875401	18-2980	853	914557	18-3938	850
851407	18-0558	864	875407	18-7085	828	914816	18-4161	781, 850
851452	18-2194	858	875422	18-2596	852	914930	18-3879	854
852520	18-6791	826	875550	18-2793	848	914971	18-3876	785
852835	18-6004	862	875569	18-2982	853	915236	18-4160	781, 850
852835	18-6004A	862	875571	18-8813-1	151, 820	925054	18-7179	882-885
852835	18-6105	862	875574	18-3205	836	925055	18-7180	864
852928	18-6274	826	875575	18-3075	835	925065	18-7190	864
852928	18-6838	826	875580	18-3666	845	925091	18-7181	864
852928	18-6881	826	875583	18-3076	835	925092	18-7182	864
853012	18-7315	859	875584	18-3208	836	925093	18-7183	864
853255	18-2104	860	875660	18-3037	835	925095	18-7122	864
853548	18-7306	859	875660	18-3078	835	925256	18-7184	864
853670	18-2040	864	875698	18-3263	836	925259	18-7186	864
853868	18-25251	857	875736	18-3037	835	925261	18-7187	864
854031	18-2777	844	875736	18-3078	835	941816	18-4215	861
854040	18-2194	858	875741	18-8357	864	941907	18-4236	844
854045	18-4210	860	875759	18-3262	836	943218	18-4238	861
854047	18-4213	861	875769	18-3261	836	943414	18-2367	848
854329	18-6792	826	875779	18-3654	844	946242	18-2046	864

Volvo (Cont.)			Volvo (Cont.)			Volvo (Cont.)		
O.E. #	SIERRA #	PAGE #	O.E. #	SIERRA #	PAGE #	O.E. #	SIERRA #	PAGE #
949656	18-7154	864	3831425	18-3660	845	3853336	18-2946	853
950813	18-15410	837	3831426	18-3539	844	3853340	18-4161	781, 850
950818	18-15460	837	3840335	18-7709	832	3853341	18-1213	851, 852
951924	18-4241	861	3841697	18-3038	835	3853342	18-0327	856
952141	18-15500	837	3841697	18-3077	835	3853343	18-1239	856
955974	18-7193	864	3841697	18-30777	836	3853361	18-0903	856
955983	18-7188	864	3842343	18-9410-2	112, 162	3853380	18-3876	785
955989	18-7149	864	3842344	18-9410-4	162	3853412	18-2909	855
955995	18-7192	864	3843751	18-7705	833	3853477	18-4160	781, 850
956000	18-7194	864	3847501	18-1986-1	840	3853510	18-1232	856
958303	18-15325	837	3847547	18-9096	859	3853511	18-3887	854
958310	18-15390	837	3847644	18-8149	128, 832	3853512	18-0468	857
958311	18-15405	837	3850216	18-5811	825	3853528	18-1234	851, 852
958314	18-15435	837	3850357	18-7677	833	3853587	18-3873	854
958320	18-15495	837	3850379	18-1238	783	3853732	18-3883	854
958357	18-15415	837	3850379	18-4408	842	3853742	18-0183	855
958359	18-15435	837	3850396	18-7684	833	3853787	18-5897	833
958498	18-4046	812, 813, 837, 847	3850426	18-1074	793, 794	3853796	18-3584	834
958838	18-2043	864	3850495	18-2875	842	3853799	18-3558	769, 770
958860	18-2047	864	3850496	18-4431	786, 858	3853801	18-5403	815
960324	18-15330	Obsolete	3850559	18-7876	153	3853807	18-2100	860
960336	18-15450	837	3850594	18-2586	863	3853827	18-1230	851, 852
966382	18-15435	837	3850595	18-0893	857	3853847	18-1401	676, 781, 850
966857	18-4046	812, 813, 837, 847	3850597	18-2791	805, 864	3853850	18-3583	834
984513	18-6028	802, 862	3850809	18-7326	140, 621, 764, 829	3853850	18-3599	834
985316	18-1401	676, 781, 850	3850810	18-7331	140, 764, 829	3853869	18-5837	825
985727	18-21753	858	3850812	18-2174	860	3853894	18-4495	568, 675, 780, 849
986280	18-6779	826	3850813	18-2128	699, 713, 794, 860	3853912	18-0410	853
988037	18-7330	140, 764, 829	3850814	18-2337	860	3853913	18-0410	853
1141679	18-9680-2	163	3850815	18-2146	860	3853945	18-6779	826
1141681	18-9680-5	163	3850861	18-7778	128, 831, 832	3853960	18-3937	850
1141682	18-9680-7	163	3850984	18-3708-1	861	3853982	18-5913	822
1218630	18-4472	847	3851982	18-3599	834	3853983	18-3676	845, 846
1218674	18-1478	847	3852005	18-3722	861	3853998	18-5837	825
1266286	18-7878-1	153	3852023	18-1501	861	3854001	18-5108	744
1266796	18-2930	855	3852033	18-7168	864	3854003	18-5107-1	744
1306169	18-5305	815	3852044	18-7162	864	3854017	18-3575	834
1306630	18-4031	851	3852045	18-7116	864	3854020	18-7238	828
1317466	18-2933	855	3852073	18-7102	864	3854026	18-7229	829
1336255	18-2530	857	3852089	18-7135	864	3854033	18-1402	676, 781, 850
1357199	18-6839	822	3852095	18-0889	855	3854095	18-1231	855
1378491	18-2993	857	3852096	18-0164	855	3854105	18-7242	828
1378645	18-2968	854	3852109	18-0874	858	3854106	18-7244	828
1378646	18-2970	854	3852113	18-0876	855	3854107	18-7245	828
1378864	18-2926	856	3852127	18-2858	769, 770, 784, 855	3854116	18-7246	828
1378870	18-2972	856				3854127	18-2765	794
1378879	18-2930	855	3852165	18-7141	864	3854130	18-6125Z	862
1378906	18-2979	857	3852169	18-7143	864	3854158	18-7601	833
1378909	18-2927	856	3852170	18-8020	135, 229, 396, 767, 834	3854159	18-7602	833
1378911	18-2922	855	3852171	18-8200	135, 229, 767, 834	3854161	18-7492	816
1378913	18-2925	855	3852172	18-8202	135, 229, 767, 834	3854190	18-5920	822
1502272	18-6846	578, 823	3852196	18-8034	135, 229, 767, 834	3854202	18-3869	854
1542389	18-4469	847	3852255	18-3744	861	3854214	18-4496	Obsolete
1542472	18-4467	847	3852315	18-32882	864	3854217	18-5248	744
2430184	18-3037	835	3852350	18-4194	800, 861	3854252	18-3939	781
2430184	18-3078	835	3852384	18-2339	860	3854260	18-5361	816
2655301	18-6847	823	3852413	18-7789	128, 227, 766, 831	3854261	18-5406	815
2656299	18-6848	824	3852413	18-7989	128, 227, 766, 831	3854269	18-0868	853
3287677	18-5745	817	3852455	18-0183	855	3854280	18-7330	140, 764, 829
3517857	18-7878-1	153	3852464	18-15455	837	3854286	18-3046	835
3523301	18-6839	822	3852468	18-2902	843	3854286	18-3060	835
3547991	18-2530	857	3852472	18-0418	855	3854299	18-3879	854
3580309	18-0498	853	3852476	18-0549	861	3854339	18-4495	568, 675, 780, 849
3582358	18-7908	848	3852477	18-0891	856	3854406	18-0410	853
3582606	18-4474	847	3852523	18-7406	864	3854512	18-7703	833
3582609	18-4465	847	3852529	18-8021	135, 229, 396, 767, 834	3854527	18-7702	833
3582732	18-0035	152, 581, 848	3852531	18-7407	296	3854620	18-7326	140, 621, 764, 829
3582733	18-0036	152, 581, 848	3852544	18-2138	861	3854751	18-5913	822
3583443	18-8125	129, 832	3852560	18-2996	858	3854905	18-7679	833
3583555	18-6944	579	3852604	18-7314	859	3854942	18-0311	856
3583786	18-3868	854	3852654	18-0468	857	3854956	18-0518	851
3586461	18-6125A	862	3852655	18-0405	856	3855017	18-7241	828
3586498	18-3079	835	3852656	18-0322	858	3855104	18-7792	833
3586765	18-6838	826	3852657	18-0519	851, 852	3855182	18-7689	833
3587079	18-6806	826	3852687	18-0664	856	3855194	18-7704	833
3587597	18-3615	845	3852691	18-0887	857	3855275	18-2598	863
3587625	18-5913	822	3852692	18-2815	855	3855276	18-7268	139, 141
3588378	18-7940	129, 832	3852693	18-0347	856	3855296	18-7757	817
3588475	18-3504	835	3852696	18-2779	834	3855411	18-6028	862
3803227	18-5943	823	3852741	18-2780-1	834	3855412	18-6102	802
3803227	18-59700	822, 823	3852742	18-2781	834	3855610	18-6125M	862
3803260	18-5939	823	3852805	18-0528	851	3855958	18-7330	140, 764, 829
3803645	18-6953	578, 824	3852818	18-0352	856	3855991	18-3577	834
3808516	18-7708	817	3852824	18-0147	857	3856003	18-5919	822
3825038	18-79007	833	3853132	18-0518	851	3856004	18-5913	822
3825133	18-7942	129, 832	3853226	18-4024	851	3856127	18-1400	676, 781, 850
3827069	18-7974	154, 157, 158, 848	3853256	18-0680	855	3856138	18-1237	856
3831424	18-3538	845	3853268	18-3937	850	3856393	18-7641	827

Volvo (Cont.)			Volvo (Cont.)			Yamaha (Cont.)		
O.E. #	SIERRA #	PAGE #	O.E. #	SIERRA #	PAGE #	O.E. #	SIERRA #	PAGE #
3856961	18-3677	845, 846	3523301-4	18-6839	822	61A-13646-00	18-99055	447
3857265	18-6274	826	3803227-2	18-59700	822, 823	61A-24563-00-00	18-7782	423
3857487	18-7700	833	3803270-2	18-6846	578, 823	61A-41134-A0	18-99000	445
3857489	18-6806	826	3851218-2	18-7789	128, 831	61A-43880-01-00	18-6782	415
3857532	18-5899	833	3851218-2	18-7989	128, 831	61A-43880-02-00	18-6782	415
3857561	18-6261	823	3852374-2	18-1986-1	840	61A-44311-00-00	18-3173	427
3857650	18-7330	140, 764, 829	3852648-9	18-3730	860	61A-44311-01	18-3523	430
3857656	18-1848	840	3853862-5	18-21753	858	61A-44322-00-00	18-3333	427
3857723	18-1986-1	840	3853962-3	18-21751	858	61A-44322-02-00	18-3519	427
3857747	18-6275	822	3854002-7	18-5443	817	61A-44527-00-00	18-9076	382, 429
3857813	18-6265	882-885	3854194-2	18-6291	825	61A-45113-A0	18-99056	447
3857985	18-7331	140, 764, 829	3854311-2	18-5408	816	61A-45114-A0	18-99001	445
3857986	18-7326	140, 621, 764, 829	3854331-0	18-5362	816	61A-45371-00-00	18-6119A	454
3858061	18-9410-7	162	3854548-9	18-5354	816	61A-45371-00-00	18-6119Z	454
3858071	18-6805	826	3854549-7	18-5405	815	61A-45538-00-00	18-9075	429
3858081	18-5700	825	3855270-9	18-1909-1	841	61A-81800-01-00	18-6861	413
3858256	18-3081	836	3856600-6	18-6261	822	61A-81840-00-00	18-56007	414
3858261	18-7326	140, 621, 764, 829	3857846-4	18-2434	476	61A-81941-00-00	18-5853	411
3858462	18-15450	837	3857944-7	18-1909-1	776	61A-W0001-01-00	18-4400	441
3858714	18-7331	140, 764, 829	3858437-1	18-21752-1	858	61A-W0001-21-00	18-2799	468
3858809	18-5700	825	419763-8	18-2965	853	61A-W0001-A1-00	18-4400	441
3858867	18-4496	Obsolete	463903-5	18-4246	848	61A-W0001-C1-00	18-2799	468
3858941	18-7685	833	5003564-1	18-6839	822	61A-W0078-01-00	18-3395	432
3858979	18-7706	817	576266-8	18-8361	864	61A-W0078-A2-00	18-3396	432
3859054	18-5811	825	818525-8	18-5419	816	61A-W0078-A3-00	18-3396	432
3859078	18-7493	817	818701-5	18-5310	815	61A-W0093-01-00	18-7772	417
3859082	18-7643	817	834438-4	18-1930-1	840	61B-82510-01-00	MP51030	25, 411
3860082	18-5979	822	834625-6	18-59700	822, 823	61B-82510-01-00	MP51032	25, 411
3860566	18-6275	822	834985-4	18-7095	827	61N-11631-00-95	18-4144	882-885
3860764	18-5913	822	835308-8	18-5338	815	61N-11635-00-00	18-4145	882-885
3860769	18-5957	822	835908-5	18-2971	843	61N-11636-00-00	18-4146	438
3860879	18-6806	826	841047-4	18-7641	827	61N-24560-10	18-79910	424
3861267	18-7648	817	841066-4	18-5903	821	61N-24563-00-00	18-7781	423
3861575	18-6804	826	841293-4	18-7001	828	61N-44311-01-00	18-3185	427
3862228	18-7989	128, 227, 766, 831	841313-0	18-7641	827	61N-44322-01-00	18-3443	427
3862281	18-3081	836	841378-3	18-59700	822, 823	61N-44323-00-00	18-3194	427, 434
3862281	18-3277	835	841634-9	18-7200	828	61N-45251-01-00	18-6120A	454
3862500	18-7513	833	841836-0	18-7000	828	61N-45251-01-00	18-6120Z	454
3862567	18-3276-1	835	847306-8	18-6872	578, 822	61N-W0078-11-00	18-3432	430
3862612	18-6848	824	847308-4	18-6958	579, 822	61N-W0093-00-00	18-7737	416
3862613	18-6845	823	849748-9	18-6955	578, 824	61T-11193-A1	18-99057	447
3862613	18-6847	823	852928,	18-6822	826	626-14390-90	18-7079	417
3862665	18-6845	823	854525-3	18-6817	826	62X-43880-00-00	18-6811	413
3863061	18-1909-1	841	855384-4	18-1935-1	838, 841	62X-43880-00-00	18-6812	413
3863085	18-25250	857	855846-2	18-5303	815	62X-43880-01-00	18-6811	413
3863130	18-7642	817	856039-3	18-2971	838, 839, 843	62X-43880-01-00	18-6812	413
3863193	18-6028A	862	873757-9	18-6846	578, 823	62X-43880-09-00	18-6789	415
3863450	18-2780-1	834	873771,	18-6846	578, 823	62X-43880-09-00	18-6812	413
3863450	18-2780-1	834	875807-0	18-3079	835	62Y-12414-00-00	18-0835	452
3867069	18-5951	823	875808-8	18-3036	473	62Y-41133-00	18-99002	445
3884950	18-5882	823	875811-2	18-3081	836	62Y-41134-01	18-99003	445
3884950	18-6845	823	876532-3	18-8801-1	752	63D-11181-A1	18-99060	443
3885317	18-5913	822	877061-2	18-3038	835	63D-11193-A0	18-99059	443
3888813	18-6127A	862	877061-2	18-3077	835	63D-44316-00-00	18-0483	452
3888814	18-6127Z	862	958359-2	18-15435	837	63D-44322-00-00	18-3449	427
3888815	18-6127M	862	966694-2	18-4044	837, 847	63D-44323-00-00	18-3186	428
3888816	18-6126A	862	WESTERBEKE			63D-45114-A0	18-99004	445
3888817	18-6126Z	862	21235	18-7925	152, 158, 581	63D-45123-00	18-99005	445
3888818	18-6126M	862	30220	18-7910	152, 158, 581	63D-W0001-00	18-99061	440
3888821	18-2583	864	YAMAHA			63D-W0078-01-00	18-3415	433
3888822	18-2584	864	61A-44311-01	18-3522	430	63D-W0078-01-00	18-3434	433
3888916	18-1076	863	19-1400-10	18-6843	865	63M-81800-00-00	18-6908	471
3911020	18-4173	781, 850	3FV-13440-00-00	18-7902	153, 158, 440	63M-81960-00-00	18-6857	471
3911023	18-4164	152	5GH-13440-00-00	18-7911-1	154, 158	63P-13915-00-00	18-79902	424
4785974	18-7926	578, 823	5GH-13440-20	18-8700	154, 439	63P-14984-00	18-0712	418
5001677	18-6846	822	60E-81800-00-00	18-6921	471	63V-11181-A2	18-99140	450
5003564	18-6839	822	60V-11181-00	18-99048	443	63V-14985-00	18-7064	417
6209190	18-6956	825	60V-13621-A0	18-99049	447	63V-24411-00	18-7390	419
6643474	18-6271	578, 824	60V-13645-00	18-99050	447	63V-41133-A1	18-99006	445
8602629	18-6953	578, 824	60V-13907-00	18-7343	419	63V-44301-00-00	18-3356	427
8602710	18-6953	578, 824	60V-24251-01-00	18-79907	424	63V-44322-00-00	18-3444	427
8602714	18-6953	578, 824	60V-43880-00-00	18-6798	414	63V-44323-00-00	18-3195	428
8676496	18-6953	578, 824	60V-81800-00-00	18-6832	412	63V-44352-01-00	18-3040	426
8676498	18-6953	578, 824	60X-43315-A0-00	18-0406	445	63V-44365-10-00	18-3505	429
8676499	18-6953	154, 848	60X-44323-00-00	18-3520	427	63V-45113-A1	18-99150	451
8692305	18-8003	820	60X-81800-00-00	18-6832	412	63V-45315-A0	18-99063	447
8757166	18-8802-1	820	60X-44323-00-00	18-3520	427	63V-85520-00	18-5183	307, 410
8757166	18-8823-1	820	60X-81800-00-00	18-6832	412	63V-85540-01	18-5132	410
21148403	18-3557	844	60X-W0078-00	18-3522	430	63V-W0001-01	18-99175	442
21213660	18-3276-1	835	60X-W0078-00-00	18-3516	429	63V-W0078-01-00	18-3412	433
21323043	18-6944	579	61A-11181-A0-00	18-3891	443	63V-W0078-01-00	18-3433	433
35882561	18-4473	847	61A-11181-A1-00	18-3891	443	63V-W0093-00	18-7058	415, 418
40005011	18-9553-2	112, 160	61A-11193-A1	18-99051	447	646-24251-02-00	18-7713	423
40005012	18-9553-3	160	61A-11381-A0	18-99052	447	646-44322-00-00	18-3328	428
40005013	18-9553-5	160	61A-12414-A0-00	18-0829	436, 452	646-44323-00-00	18-3357	428
40005014	18-9553-7	160	61A-13411-00	18-79976	439	646-44352-01-00	18-3072	426
1357199-7	18-6839	822	61A-13621-A0	18-99053	447	647-14385-00	18-7065	417
17253-6	18-3745	861	61A-13645-00	18-99054	447	647-44366-00	18-1833	429

Table with columns: Yamaha (Cont.) O.E. #, SIERRA #, PAGE # and Yamaha (Cont.) O.E. #, SIERRA #, PAGE # and Yamaha (Cont.) O.E. #, SIERRA #, PAGE #. Rows list part numbers and their interchangeability.

Yamaha (Cont.)			Yamaha (Cont.)			Yamaha (Cont.)		
O.E. #	SIERRA #	PAGE #	O.E. #	SIERRA #	PAGE #	O.E. #	SIERRA #	PAGE #
6A0-24410-02-00	18-7334	419	6F3-W0001-A4-00	18-4403	441	6H3-14590-00	18-7056	417-419
6A0-24410-03-00	18-7334	419	6F3-W0001-C1-00	18-2794-1	468	6H3-41112-A0	18-99128	450
6A0-24410-04-00	18-7334	419	6F5-12411-03-00	18-3625	436	6H3-41114-A0	18-99129	450
6A0-24410-05-00	18-7334	419	6F5-24563-00-00	18-7780	423	6H3-44315-A0-00	18-0756-1	433, 453, 468
6A0-W0001-21	18-99104	440	6F5-44352-00-00	18-3088	426	6H3-44324-A0-00	18-0757	433, 453, 468
6A1-44325-00-00	18-1079	453	6F5-81800-11	18-6421	412	6H3-44352-00-00	18-3069	426, 432, 433
6A1-W0001-22-00	18-0026	467	6F5-W0078-00-00	18-3374	432	6H3-45113-A0	18-99130	450
6A1-W0001-23-00	18-0027	467	6F5-W0078-A0-00	18-3398	432	6H3-45114-A1	18-99046	447
6A1-W0078-01-00	18-3463	430	6G1-11193-A1	18-99108	449	6H3-45123-00	18-99047	447
6A1-W0078-02-00	18-3462	430	6G1-13621-A1	18-99109	449	6H3-81800-10	18-6411	412
6A1-W0093-01-00	18-7293	416	6G1-13645-A1	18-99110	449	6H3-81800-11-00	18-6411	412, 413
6AW-14984-00	18-0714	418	6G1-14198-A1	18-99111	449	6H3-85510-A1	18-5746	412
6AW-44352-00-00	18-8925	426	6G1-14546-01	18-7054	417, 418	6H3-W0001-02	18-99176	442
6BG-13915-00	18-79970	423	6G1-14985-00	18-7067	417	6H3-W0001-21-00	18-2788	468
6C5-13915-00	18-79973	424	6G1-24305-04	18-80414	425	6H3-W0001-A0-00	18-4427	443
6C5-43880-00-00	18-6836	413	6G1-24305-05-00	18-80414	425	6H3-W0001-C1-00	18-2788	468
6D3-81800-00-00	18-6907	470	6G1-24411-00	18-7388	419	6H3-W0078-00-00	18-3428-1	433
6D8-WS24A-00-00	18-79799	423	6G1-24431-01	18-99147	450	6H3-W0078-00-00	18-3461	433
6E0-24411-00	18-7389	419	6G1-24471-00-00	18-7833	420	6H3-W0078-01-00	18-3464	430
6E0-24471-00-00	18-7834	420	6G1-41112-A1	18-99112	449	6H3-W0078-01-00	18-3466	430
6E0-44352-00-00	18-3073	426	6G1-41114-A0	18-99113	449	6H3-W0078-02-00	18-3465	430
6E0-44366-00-00	18-3166	429	6G1-41133-A0	18-99114	449	6H3-W0078-02-00	18-3466	430
6E0-W0001-C1-00	18-0028	467	6G1-44315-A0-00	18-0753	452	6H3-W0078-A0-00	18-3428-1	433
6E5-11181-02-00	18-3832	441, 443	6G1-44322-00-00	18-3456	427	6H3-W0078-A0-00	18-3461	433
6E5-11181-A1-00	18-3832	443	6G1-44352-00-00	18-3066	426	6H3-W0093-02-00	18-7766	416
6E5-11193-A0-00	18-0781	452	6G1-45113-A1	18-99115	449	6H4-11181-00-00	18-3830	441-443
6E5-11381-A1-00	18-0782	452	6G1-45315-A0	18-99116	449	6H4-11181-A1-00	18-3830	443
6E5-11610-03-00	18-3934	438	6G1-81941-10-00	18-5821	411	6H4-11193-A1-00	18-0815	452
6E5-12411-02-00	18-3623	436	6G1-W0001-A2	18-99117	440	6H4-11610-00-00	18-3960	438
6E5-12411-30-00	18-3540	436	6G1-W0001-C1-00	18-0029	467	6H4-11610-10-00	18-3961	882-885
6E5-13411-00	18-79975	439	6G1-W0078-A1	18-3460	430	6H4-11610-20-00	18-3962	882-885
6E5-13621-A1	18-99105	449	6G1-W0093-00-00	18-7765	416	6H4-11631-00-96	18-4141	438
6E5-13645-A1-00	18-0823	452	6G5-11181-00-00	18-3894	443	6H4-11635-01-00	18-4142	438
6E5-14198-A1-00	18-0785	451	6G5-11181-A0-00	18-3894	441, 443	6H4-11636-00-00	18-4143	438
6E5-14384-02-00	18-0786	451	6G5-11193-A0-00	18-0779	452	6H4-13621-A1	18-99132	450
6E5-14384-03-00	18-2592	451	6G5-11382-A1-00	18-0808	452	6H4-14198-01	18-99133	450
6E5-14385-01	18-7068	417	6G5-11631-00-93	18-4129	438	6H4-15369-A1	18-99134	450
6E5-14385-02	18-7069	417	6G5-11636-00-00	18-4133	882-885	6H4-41112-A0	18-99135	450
6E5-14546-00	18-7055	417	6G5-11642-00-93	18-4128	438	6H4-41114-A0-00	18-0798	452
6E5-24305-05	18-80415	425	6G5-13645-A1-00	18-0809	451	6H4-44352-00-00	18-3068	426, 433
6E5-24410-00-00	18-7349	419	6G5-14483-A1	18-99118	449	6H4-44352-02-00	18-3068	426, 433, 459
6E5-24410-01-00	18-7349	419	6G5-41112-A1-00	18-0812	452	6H4-81800-12-00	18-6422	412
6E5-24410-02-00	18-7349	419	6G5-41134-A1	18-99039	447	6H4-W0001-01-00	18-4407	441
6E5-24410-03-00	18-7349	419	6G5-43864-00-00	18-7468	469	6H4-W0001-02-00	18-4419	442
6E5-24410-04-00	18-7349	419	6G5-43880-02-00	18-6760	415	6H4-W0001-03-00	18-4409	441
6E5-24410-10-00	18-7349	419	6G5-44323-00-00	18-3345	465, 428, 463	6H4-W0001-04-00	18-4409	441
6E5-24411-00-00	18-7843	420	6G5-45113-A0-00	18-0813	452	6H4-W0001-20-00	18-2792	459, 468
6E5-24471-00-00	18-7842	420	6G5-45114-A1	18-99040	447	6H4-W0001-21-00	18-2792	468
6E5-41112-A1-00	18-0799	452	6G5-45251-01-00	18-6090	454	6H4-W0001-A1-00	18-4407	441
6E5-41134-A0	18-99037	447	6G5-W0001-03-00	18-4404	441	6H4-W0001-A2-00	18-4419	442
6E5-41135-A0	18-99038	447	6G5-W0001-21-00	18-2794-1	465, 468	6H4-W0078-00-00	18-3408	433, 459
6E5-43880-01-00	18-6821	413	6G5-W0001-A3-00	18-4404	441	6H4-W0078-00-00	18-3429	433, 459
6E5-43880-02-00	18-6821	413	6G5-W0001-C1-00	18-2794-1	468	6H4-W0078-A0-00	18-3408	433
6E5-44311-00-00	18-3170	427, 432, 463, 465	6G5-W0078-01-00	18-3310	431	6H4-W0078-A0-00	18-3429	433
6E5-44315-A0-00	18-0244	469	6G5-W0078-A1-00	18-3311	431	6H4-W0093-01-00	18-7767	416
6E5-44323-00-00	18-3344	428	6G5-W0093-08-00	18-7747	416	6H4-W0093-03-00	18-7768	417
6E5-44352-00-00	18-3071	426, 463, 465	6G5-W4599-00-00	18-3782	455	6H5-43880-02-00	18-6788	415
6E5-44352-01-00	18-3071	426	6G8-11181-00-00	18-3827	443	6J4-81800-01-00	18-6421	412
6E5-45371-01-00	18-6097	454, 463	6G8-11181-A1-00	18-3827	443	6J8-11181-00-00	18-3829	443
6E5-45611-01-00	18-2385	453	6G8-11351-A0	18-99119	449	6J8-11181-A1-00	18-3829	443, 444
6E5-81800-11-00	18-6413	412, 413	6G8-12414-A0	18-99120	449	6J8-12414-A0-00	18-0829	436, 452
6E5-81800-12-00	18-6413	412, 413	6G8-13440-00-00	18-7901	153, 158, 440	6J8-13411-00	18-79974	439
6E5-81840-10-00	18-56005	413	6G8-13646-A0	18-99121	450	6J8-24471-00-00	18-7841	420
6E5-81941-11-00	18-5853	411	6G8-14198-A0	18-99122	450	6J8-W0001-21-00	18-2789	468
6E5-85570-11-00	18-5110	410	6G8-15374-00	18-99123	450	6J8-W0001-C2-00	18-2789	468
6E5-W0001-51-00	18-2794-1	463, 468	6G8-45113-A1	18-99045	447	6J8-W0078-A1-00	18-3430	433
6E5-W0001-F1-00	18-2794-1	468	6H0-W0093-00-00	18-7742	416	6J9-45371-01-00	18-6035	454, 465
6E5-W0078-01-00	18-3372	431	6H1-11631-03-95	18-4097	438	6J9-45371-01-00	18-6112	454, 465
6E5-W0078-A1-00	18-3373	432	6H1-11636-03-00	18-4099	438	6K1-45371-00-00	18-6034	454
6E5-W0093-06-00	18-7002	415	6H1-43880-00-00	18-6259	415	6K1-45371-00-00	18-6034A	882-885
6E581941-00-00	18-5853	411	6H1-43880-02-00	18-6781	415	6K1-45371-02-00	18-6121A	454
6E581941-10-00	18-5853	411	6H1-45251-02-00	18-6091	454	6K1-45371-02-00	18-6121Z	454
6E7-11181-00-00	18-3828	443	6H1-W0001-00-00	18-4405	441	6K1-82510-06-00	MP51050	25, 411
6E7-11181-A1-00	18-3828	443	6H1-W0001-01-00	18-4405	441	6K1-82510-06-00	MP51052	25, 411
6E7-11631-00-97	18-4135	438	6H1-W0001-A0-00	18-4405	441	6K5-11601-02-00	18-3963	438
6E7-11635-00-00	18-4136	438	6H1-W0093-01-00	18-7291	416	6K5-11636-03-00	18-4096	882-885
6E7-14227-00	18-99144	450	6H1-W4599-00-00	18-3781	455	6K7-13645-A1-00	18-0807-1	451
6E7-14385-00	18-7393	418	6H2-81960-00-00	18-6858	471	6K7-13686-A1	18-99136	450
6E7-85570-19-00	18-5112	410	6H3-11181-01-00	18-3831	443	6K7-W0001-04-00	18-4410	882-885
6E7-W0093-04-00	18-7769	417	6H3-11181-A1-00	18-3831	443	6K7-W0093-09-00	18-7759	416
6E8-14390-12	18-7073	417	6H3-11193-A1	18-99141	450	6L2-11181-A1-00	18-3847	442, 443
6E9-11193-A0	18-99106	449	6H3-11631-01-96	18-4091	438	6L2-11181-A2-00	18-3847	443
6E9-12414-A1	18-99142	450	6H3-11636-01-00	18-4093	438	6L2-14384-00-00	18-0765	442, 451
6E9-41114-A0	18-99107	449	6H3-12411-11-00	18-3622	436	6L2-14385-00	18-7063	417
6E9-W0093-02-00	18-7740	416	6H3-12414-A1	18-99124	450	6L2-14392-00	18-7049	417, 418
6E9-W0093-03-00	18-7741	416	6H3-13621-A1	18-99143	450	6L2-41112-A1-00	18-0743	442, 452
6F3-W0001-04-00	18-4403	441	6H3-13622-00	18-99125	450	6L2-41114-A1-00	18-0744	442, 452
6F3-W0001-21-00	18-2794-1	468	6H3-14198-01	18-99126	450	6L2-41133-A2	18-99137	450

Yamaha (Cont.)			Yamaha (Cont.)			Yanmar (Cont.)		
O.E. #	SIERRA #	PAGE #	O.E. #	SIERRA #	PAGE #	O.E. #	SIERRA #	PAGE #
6L2-44352-00-00	18-3065	426, 433	93102-35M13-00	18-2085	441, 469	119573-77201	18-6929	578
6L2-45315-A0	18-99138	450	93102-40M36-00	18-2087	882-885	119773-42600-01	18-3306	473
6L2-81800-20-00	18-6420	412	93102-40M38-00	18-2088	882-885	119773-77010	18-6938	579
6L2-W0001-01-00	18-4422	442	93104-22M07-00	18-2091	882-885	119773-77200	18-6849	578
6L2-W0001-02-00	18-4422	442	93106-09014-00	18-0267	461, 467-469	119836-77200	18-6926	578
6L2-W0001-A2-00	18-4422	442	93210-19123-00	18-7463	469	119836-77200-2	18-6926	578
6L2-W0001-C3-00	18-0030	467	93210-32738-00	18-7432	469	119836-77200-3	18-6926	578
6L2-W0078-00-00	18-3431	433	93210-33M85-00	18-7119	469	121120-77010	18-6931	579
6L2-W0093-00-00	18-7739	416	93210-37M67-00	18-7483	469	121120-77011	18-6931	579
6L5-24251-00	18-79977	424	93210-41042-00	18-0298	459, 467-469	121120-77012	18-6931	579
6L5-44322-00-00	18-3164	426	93210-42159-00	18-7435	882-885	121254-77010	18-6939	579
6L5-44323-00-00	18-3163	428	93210-46044-00	18-7436	469	121254-77011	18-6939	579
6L5-44352-00	18-8911	426	93210-66M98-00	18-0299	459, 467-469	121254-77012	18-6939	579
6M6-81800-10-00	18-6862	470	93210-74M35-00	18-7442	441, 469	121254-77019	18-6939	579
6N0-W0001-C0-00	18-0031	467	93210-86M38-00	18-7485	469	121370-77010	18-6932	579
6N0-W0078-A0-00	18-3460	430	93210-97M55-00	18-0275	465, 468, 469	123500-77010,	18-6934	579
6N6-W0001-03-00	18-4411	441	93211-04384-00	18-7444	441, 469	12423-42092	18-8950	580
6N6-W0001-A3-00	18-4411	441	93310-32337-00	18-1410	439	124450-35100	18-7910	152, 158, 581
6N6-W0078-00-00	18-3312	431	93310-620V5-00	18-1411	439	124450-35110	18-7917	152, 158, 581
6N6-W0078-01-00	18-3313	431	93310-730V8-00	18-4077	439	124520-77010	18-6931	579
6N6-W0093-02-00	18-7744	416	93310-836V2-00	18-4078	439	124520-77011	18-6931	579
6N7-81800-10-00	18-6415	412	95307-16900-00	18-3732	454	124550-35110	18-7917	152, 158, 581
6N7-81840-00-00	18-56006	413	97080-08045-00	18-2602	427, 463, 465	124610-77010	18-6934	579
6OV-13646-00	18-99139	450	97095-06040-00	18-2607	427	124610-77019	18-6934	579
6P2-14984-00	18-0713	418	97095-08045-00	18-0256	427, 459	127610-42200	18-3077	474
6P2-44323-00-00	18-3518	427	99999-03249-00	18-6412	412	128170-01331	18-55600	580
6P2-W0078-00-00	18-3515	429	ABA-FBARB-90-DG	18-8040	425	128170-11310	18-56000	580
6P3-24564-00-00	18-7488	423	ABA-FLINE-BA-RB	18-8055	425	128170-42090	18-56602	580
6P3-WS24A-00-00	18-79809	423	ABB-FUELF-IL-TR	18-7845	126, 422, 565	128170-42090	18-56602	580
6R3-85570-01-00	18-5128	410	ABB-FUELF-IL-TR	18-7945	126, 422, 565	128170-77010	18-6937	579
6R3-W0001-03-00	18-4412	441	ABB-SPRTR-HD-SS	18-7777-1	126, 421	128170-77010D	18-6937	579
6R3-W0001-A3-00	18-4412	441	LUB-2STRK-M1-4	18-9530-3	159	128170-77200	18-6928	578
6R5-11603-00	18-39320	438	LUB-2STRK-M1-55	18-9530-7	159	128170-77201	18-6928	578
6R5-11631-11-93	18-4081	438	MAR-10171-00-10	18-7924	127, 422	128170-77202	18-6928	578
6R5-11635-11-00	18-4083	438	MAR-10171-30-00	18-7606	425	128171-01911	18-55601	580
6R5-11636-11-00	18-4085	438	MAR-24563-00-00	18-7919	127, 422	128176-42071	18-8951	580
6R5-11642-11-93	18-4080	438	MAR-FLTHD-AL-12	18-7853-1	126, 421	128270-77200	18-6925	578
6R5-11645-11-00	18-4082	438	MAR-FLTHD-SS-12	18-7777	126, 421	128271-01911	18-55602	580
6R5-11646-11-00	18-4084	438	MAR-FUELF-IL-TR	18-7866	126, 422, 566	128374-01911	18-55603	580
6R5-11650-10-00	18-4157	439	MAR-MINIF-IL-TR	18-7865	84, 128	129242-77010	18-6932	579
6R6-W0001-01-00	18-4413	442	MAR-MINIF-LT-AS	18-7965-1	128, 422	129429-77010	18-6939	579
6S5-81800-00-00	18-6909	471	MAR-SEPAR-AT-OR	18-7852-1	126, 421	129429-77011	18-6939	579
6Y1-24305-04	18-80413	425	MAR-SEPAR-AT-OR	18-7966-1	126, 421	129470-77200	18-6927	578
6Y2-24305-05	18-80415	425	MAR-SPRTR-HD-SS	18-7984-1	126, 421	129573-77010	18-6880	578
6YL-24306-60-00	18-8017EP-1	134, 425	N26-13440-00-00	18-7954	154, 158, 439, 440	129612-77230	18-6926	578
6YL-24306-60-00	18-8017S	138	YB-6AW04-1	18-9133-9	426	129698-77010	18-6932	579
703-82510-12-00	MP51020	25, 411	YB-6AW04-3	18-9146-9	167, 426	171008-77010	18-6880	578
703-82510-12-00	MP51022	25, 411	YB-6AW04-A	18-9145	167, 426	171056-35110	18-7917	152, 158, 581
703-82510-43-00	MP51040	25, 411	YSC-10231-20-0C	18-7824	153, 565, 866	171056-35111	18-7917	152, 158, 581
703-82510-43-00	MP51042	25, 411	YSC-10231-20-0C	18-7875	153, 565, 866	18-55501	18-55501	580
90105-10M00-00	18-6246	454	YSC-10231-20-0C	18-7876	153, 565, 866	192470-42530	18-3277	835
90119-08M13-00	18-2606	427	YSC-10260-00-0C	18-15111	866	192470-42532	18-3277	835
90119-08M15-00	18-8400-9	427	YSC-10260-10-0C	18-15110	866	27210-200200	18-6200	580
90119-08M87-00	18-2605	427	YSC-12190-00-AC	18-2909	866	27210-200300	18-6201	580
90171-10M01	18-3773	454	YSC-13080-00-0C	18-0164	866	424610-77010	18-6934	579
90171-16011-00	18-3732	454, 461	YSC-13231-20-0C	18-7824	866	728170-92600	18-55500	580
90171-18M04-00	18-3726	463, 465	YSC-13260-60-0C	18-15106	866	728271-92605	18-55502	580
90201-22M01	18-9078	429	YSC-13260-70-0C	18-15107	866	728374-92605	18-55503	580
90206-22M19	18-9077	429	YSC-14231-20-0C	18-7876	153, 866			
90280-03024-00	18-3305	427, 459	YSC-16231-20-0C	18-7875	153			
90280-03M03-00	18-3297	427	YSC-22260-00-0C	18-15109	866	K-2035	18-7732	148, 485, 486
90280-04M00-00	18-3300	427, 432	YSC-22260-10-0C	18-15108	866	K-2036	18-7732	148, 485, 486
90280-04M04-00	18-3301	427, 431, 461	YSG-10108-43-8G	18-0876	866			
90280-04M05-00	18-3302	427, 431, 432,	YSG-10108-44-5G	18-0874	866			
		463, 465	YSG-10114-14-1G	18-0889	866			
90340-08002-00	18-2371	453	YSG-14090-90-8G	18-0905	467, 468, 866			
90340-08002-00	18-23711-9	453	YSG-14096-15-6G	18-0887	866			
90340-08M04-00	18-2371	453	YSG-37545-87-G0	18-0891	866			
90340-08M04-00	18-23711-9	453	YSG-38600-39-G0	18-0903	866			
904-30142-28-00	18-0755	445						
90430-08020-00	18-4698	453	YANMAR					
90430-08020-00	18-46981-9	453	104211-42070	18-3079	474			
90430-14115-00-00	18-0826	442, 453	104211-49160	18-56601	580			
90430-14228-00	18-0755	445	104211-49160	18-56601	580			
90430-14M09-00	18-0755	445	104211-77010	18-6930	578			
90790-74001-00	22423	166	104211-77011	18-6930	578			
91490-30030-00	18-2380	455	104500-55710	18-79960	129, 580			
91490-30045-00	18-3748	455	114361-77011	18-6936	579			
91490-40030-00	18-3735	455, 461, 463, 465	114362-77010	18-6936	579			
93101-20M07-00	18-0554	457, 467-469	114362-77011	18-6936	579			
93101-22067-00	18-0296	457, 459, 467-469	114399-77010	18-6936	579			
93101-22M15-00	18-2079	441, 469	119209-77010	18-6931	579			
93101-23070-00	18-0297	459, 467-469	119225-77010	18-6935	579			
93101-25M03-00	18-0587	461, 469	119225-77011	18-6935	579			
93101-28M16-00	18-0265	463, 465, 468, 469	119226-77010	18-6935	579			
93101-30M17-00	18-0266	463, 465, 468, 469	119573-77200	18-6927	578			
93102-23096-00	18-0570	442, 469	119573-77200	18-6929	578			
93102-25M28-00	18-0588	882-885	119573-77201	18-6927	578			

SIERRA #	PAGE #	SIERRA #	PAGE #	SIERRA #	PAGE #	SIERRA #	PAGE #
GAUGES							
10860	21	62546PH	7	67103P	Obsolete	69073FP	13
1471175	20	62547P	2, 7	67104P	Obsolete	69073FP	13
40102E007	21	62548P	7	67105P	Obsolete	69074FP	13
1507678P	20	62549P	2, 7	67106P	Obsolete	69074FP	13
1508370P	20	62550P	2, 7	67106PH	Obsolete	69268P	4, 21
18-5896	18, 336	62550P	2, 7	67107P	Obsolete	69268P	4, 21
18-5897	18	62551P	2, 7	67173P	Obsolete	69269P	4, 21
18-5898	18, 521, 640, 769	62555P	2, 7	67173PH	Obsolete	69269P	4, 21
18-5899	18	62561P	2, 7	67174P	Obsolete	69270P	4, 21
18-7513	18, 833	62565P	2, 7	67175P	Obsolete	69270P	4, 21
1827871P	21	62698P	2, 10	67175P	Obsolete	69380P	21
52320S26	18	62714P	2, 6	67176P	Obsolete	69380P	4, 21
56353P	20	62715P	2, 6	67281P	882-885	69381P	21
56966P	19, 112	62718P	2, 6	67283P	3, 13	69381P	4, 21
56967P	19, 112	62719P	2, 6	67283PH	13	69703P	11
56968P	19	62720P	2, 6	67285P	3, 13	69704P	11
56969P	19	62721P	2, 6	67346P	882-885	69708P	14
56973P	20	62722P	2, 6	67353P	17	69709P	14
57897P	14	62723P	2, 6	67363P	3, 13	69710P	15
57898P	3, 14	62723PH	6	67364P	3, 13	69711P	15
57898PH	14	62724P	2, 6	67365P	3, 13	69712P	16
57899P	3, 14	62725P	2, 6	67382P	3, 13	69713P	16
57899PH	14	62726P	2, 6	67437P	20	69716P	11
57900P	3, 14	62726P	2, 6	67457P	20	69717P	11
57900PH	14	62727P	2, 6	67653P	2, 8	69721P	14
57901P	3, 14	62728P	2, 6	67654P	2, 7	69722P	14
57902P	3, 14	62729P	2, 6	67657P	2, 7	69723P	15
57903P	3, 14	62730P	2, 6	67669P	2, 8	69724P	15
57904P	3, 14	62748P	2, 6	67855P	13	69725P	16
57905P	3, 14	62952P	2, 10	67873P	Obsolete	69726P	16
57929P	3, 14	62960P	2, 10	68356P	3, 14	69741P	19
58255P	3, 14	63076P	3, 11	68357P	3, 14	69743P	11
58342P	3, 14	63076PH	11	68358P	3, 14	69743P	11
58342PH	14	63473P	3, 12	68359P	3, 14	69992D	4
58431P	3, 14	63474P	3, 12	68361P	3, 14	69993D	4
58431P	3, 14	63475P	3, 12	68362P	3, 14	69994D	4
58862P	3, 14	63475PH	12	68363P	14	69995K	4
58935P	3, 14	63476P	3, 12	68364P	3, 15	69996K	4
59416P	2, 8	63476PH	12	68365P	3, 15	69997K	4
59649P	2, 8	63477P	3, 12	68366P	3, 15	69998K	4
59653P	2, 8	63478P	3, 12	68367P	3, 15	69999K	4
59654P	2, 8	63479P	3, 12	68369P	3, 15	70000D	4
59655P	2, 8	63480P	3, 12	68370P	3, 15	70001D	4
59656P	2, 8	63481P	3, 12	68371P	3, 15	70002D	4
59657P	2, 8	63482P	3, 12	68372P	3, 15	70003D	4
59677P	20	63483P	3, 12	68373P	3, 15	70004D	4
59703P	3, 11	63483P	3, 12	68374P	3, 15	70005D	4
59704P	3, 11	63516P	2, 10	68375P	3, 15	70006D	4
59704PH	11	63523P	2, 8	68376P	3, 15	781-310-035P	2, 5, 8
59705P	3, 11	63531P	2, 6	68377P	3, 15	781-310-060P	2, 5, 8
59706P	3, 11	63585P	3, 12	68378P	3, 15	781-579-035P	3, 5, 14
59707P	3, 11	63941P	2, 10	68379P	3, 15	781-579-035P	3, 5, 14
59708P	3, 11	64475P	3, 12	68380P	3, 15	781-579-060P	3, 5, 14
59709P	3, 11	64477FP	2, 9	68381P	3, 15	781-579-080P	3, 5, 14
59713P	2, 8	65129P	2, 9	68383P	3, 15	781-579-080P	3, 5, 14
59737P	2, 8	65205P	3, 14	68384P	3, 15	781-625-035P	2, 5, 7
61163P	3, 11	65206SSP	2, 9	68385P	3, 15	781-625-035P	2, 5, 7
61238P	3, 14	65481P	3, 11	68386P	3, 15	781-625-060P	2, 5, 6
61546P	2, 10	65485P	3, 11	68387P	3, 15	781-625-080P	2, 5, 7
61547P	2, 10	65495P	2, 9	68388P	3, 15	781-625-080P	2, 5, 7
61548P	2, 10	65496P	2, 9	68389P	3, 16	781-625-120P	2, 5, 7
61549P	2, 10	65497P	2, 9	68390P	3, 16	781-625-120P	2, 5, 7
61550P	2, 10	65498P	2, 9	68391P	3, 16	781-627-035P	2, 5, 6
61551P	2, 10	65501P	2, 9	68392P	3, 16	781-627-035P	2, 5, 6
61552P	2, 10	65502P	2, 9	68393P	3, 16	781-627-060P	2, 5
61748P	3, 14	65502P	2, 9	68394P	3, 16	781-627-080P	2, 5, 6
61751P	2, 9	65503P	2, 9	68395P	3, 16	781-627-080P	2, 5, 6
61751PH	9	65504P	2, 9	68396P	3, 16	781-627-120P	2, 5, 6
61752FP	8	65505P	2, 9	68397P	3, 16	781-627-120P	2, 5, 6
61752P	2, 9	65506P	2, 9	68398P	3, 16	781-683-035P	3, 5, 15
61752PH	9	65507P	2, 9	68399P	3, 16	781-683-035P	3, 5, 15
61826P	3, 11	65508P	2, 9	68400P	3, 16	781-683-060P	3, 5, 15
61826PH	11	65509P	2, 9	68401P	3, 16	781-683-080P	3, 5, 15
61870P	882-885	65510P	2, 9	68402P	3, 16	781-683-080P	3, 5, 15
61886P	6, 9-14, 21	65626SSFP	2, 7	68403P	3, 16	781-684-035P	3, 5, 16
61901P	3, 11	65668BMDP	3, 14	68404P	3, 16	781-684-035P	3, 5, 16
61908P	3, 11	65669SSP	2, 9	68405P	3, 16	781-684-060P	3, 5, 16
61908P	3, 11	65670P	2, 9	68406P	3, 16	781-684-080P	3, 5, 16
6219371P	21	65670PH	9	68408P	3, 16	781-684-080P	3, 5, 16
62369P	3, 11	65671P	2, 9	68409P	3, 16	80131P	3, 17
62372P	2	65692P	9	68410P	3, 16	80134P	3, 17
62373P	2, 10	65693P	2, 9	68411P	3, 16	80150P	3, 17
62373P	2, 10	66956P	3, 11	68412P	3, 16	80180P	3, 17
62375P	2, 10	67019P	3, 13	68413P	3, 16	80181P	3, 17
62538P	2, 7	67020P	3, 13	68443P	3, 14	80514P	3, 17
62539P	2, 7	67021P	3, 13	68755P	5	80514PH	17
62540P	2, 7	67022P	3, 13	68960P	3, 13	80590P	3, 17
62542P	2, 7	67023P	3, 13	68960PH	13	80593P	17
62543P	2, 7	67101P	Obsolete	68982P	5	80596P	17
62546P	2, 7	67102P	Obsolete	69044P	14	80710P	3, 17
						80712P	17

SIERRA #	PAGE #	SIERRA #	PAGE #	SIERRA #	PAGE #	SIERRA #	PAGE #
GAUGES							
80730P	3, 17	82760P	3, 17	IH15105	20	OP24301	18
82288P	3, 17	84730P	2, 6	LL-0000-120-02P	Obsolete	OP24891	18
82301P	17	84760P	3, 14	LL-0000-240-02P	Obsolete	OP72533	18
82302P	3, 17	IA17537	21	LL-0000-240-03P	Obsolete	TS25101	18, 52
82303P	17	IA59335	Obsolete	LL-0000-360-02P	Obsolete	TS25111	18
82380P	17	IA62995	21	LL-0000-360-03P	Obsolete	TS26611	18
82410P	17	IA65476	21	LL-0300-120-01P	Obsolete	TS26621	18
82418P	17, 21	IA65477	21	LL-0300-240-01P	Obsolete	TS26631	18
82430P	17	IA96042	Obsolete	LL-0300-360-01P	Obsolete	TS26651	18
82431P	Obsolete	IH14767	20	OP22891	18, 52		
				OP22900	18, 52		

SIERRA SWITCH & ELECTRICAL

95001	60	CB60000	52	EC04270-100	58	FS40600-1	48
95002	60	CL49300	59	EC04280	58	FS40602-1	48
95004	60	CL49310	59	EC04280-100	58	FS40610-1	48
95005	60	CL49320	59	EC04290	58	FS40612-1	48
95010	882-885	CL49330	59	EC04290-100	58	FS40630-1	48
95011	60	CL49330KA	59	EC04300	57	FS40632-1	48
95013	60	CL49332	59	EC04300-100	57	FS40640-1	48
95016	60	CL52422	59	EC04490	58	FS40642-1	48
95018	882-885	EC01310	59	EC04490-100	58	FS40650	48
95021	60	EC01340	OBSOLETE	EC04500	58	FS40652-1	48
95026	60	EC01350	59	EC04500-100	58	FS40660	50
18-1100	57	EC01360	59	EC04510-100	58	FS40662	50
18-1105	57	EC01370	59	EC04520-100	58	FS40670	50
18-1106	57	EC01380	59	EC04670-100	57	FS40672	50
18-1107	57, 375, 376	EC01390	OBSOLETE	EC04680-100	57	FS40680	50
18-1109	57	EC01440	58	EC04690-100	57	FS40682	50
18-1110	57	EC01450	58	EC04700-100	58	FS40690	50
18-1175	57	EC01460	58	EC04710-100	57	FS40692	50
18-1176	57	EC01570	58	EC04720-100	57	FS40700	882-885
18-1177	57	EC01620	58	EC06110	882-885	FS40710	882-885
18-1178	57	EC01630	58	EC06230	58	FS40712	882-885
18-1199	57	EC01750	58	EC09040	59	FS40720	50
18-1282	32, 215	EC01760	59	EC09090	59	FS40722	50
18-3746	57	EC04000	58	EC10250	59	FS40730	47
18-3747	57	EC04000-100	58	EC10290	58	FS40732	47
18-3748	57, 455	EC04010	57	EC63120	57	FS40740	47
18-5840	55	EC04010-100	57	EC63130	57	FS40742	47
BA58003	55	EC04020	57	EC63140	57	FS40750	50
BA58010	55	EC04020-100	57	EC63190	57	FS40752	50
BA58020	55	EC04030-100	57	EC63200	57	FS40760	50
BA58050	55	EC04040-100	57	EC63240	57	FS40762	50
BC88523	56	EC04050	58	EC63250	57	FS45350	51
BC88533	56	EC04050-100	58	EC63260	57	FS45352	51
BC88543	56	EC04060	58	EC63300	57	FS45360	51
BC88553	56	EC04060-100	58	EC63720	57	FS45362	51
BC88563	56	EC04070-100	58	EC64000	57	FS45370	51
BC88573	56	EC04080	58	EC64000-100	57	FS45372	51
BC88583	56	EC04080-100	58	EC64110	57	FS45380	51
BC88593	56	EC04090	58	EC64110-100	57	FS45382	51
BT44430	56	EC04090-100	58	EC64230	57	FS45390	51
BT44470	56	EC04100	58	EC64230-100	57	FS45392	51
BT44480	56	EC04100-100	58	FS22080	52	FS45400	51
BT44490	56	EC04110	58	FS22082	52	FS45402	51
BT44501	56	EC04110-100	58	FS35870	50	FS45410	50
BT44511	56	EC04120	57	FS35872	50	FS45412	50
CB40190	52	EC04120-100	57	FS40410	47	FS45430	52
CB40200	52	EC04130	57	FS40412	47	FS45432	52
CB40220	52	EC04130-100	57	FS40420	47	FS45440	51
CB40230	52	EC04140	57	FS40422	47	FS45442	51
CB40240	52	EC04140-100	57	FS40430	47	FS45460	51
CB40250	52	EC04150	58	FS40432	47	FS45462	51
CB40260	52	EC04150-100	58	FS40440	47	FS45470	51
CB40270	52	EC04160-100	58	FS40442	47	FS45472	51
CB40280	52	EC04170	58	FS40450	47	FS45620	50
CB41100	52	EC04170-100	58	FS40452	47	FS45622	50
CB41200	52	EC04180	58	FS40500	882-885	FS45630	50
CB41200B	52	EC04180-100	58	FS40502-1	48	FS45632	50
CB41210	52	EC04190	57	FS40510-1	48	FS45640	50
CB41210B	52	EC04190-100	57	FS40512-1	48	FS45642	50
CB41220	52	EC04200	57	FS40520-1	48	FS45650	50
CB41220B	52	EC04200-100	57	FS40522-1	48	FS45652	50
CB41230	52	EC04210	58	FS40530-1	48	FS46100	49
CB41230B	52	EC04210-100	58	FS40532-1	48	FS46102	49
CB41240	52	EC04220	58	FS40540	48	FS46150	49
CB42100	882-885	EC04220-100	58	FS40542-1	48	FS46152	49
CB42110	882-885	EC04230	58	FS40550-1	48	FS46200	49
CB42120	882-885	EC04230-100	58	FS40552-1	48	FS46202	49
CB42130	882-885	EC04240	57	FS40560-1	48	FS46250	49
CB42140	882-885	EC04240-100	57	FS40562-1	48	FS46252	49
CB42240	52	EC04250	57	FS40570-1	48	FS46300	49
CB42250-1	52	EC04250-100	57	FS40572-1	48	FS46302	49
CB43240	52	EC04260	57	FS40590-1	48	FS46350	49
CB43250	52	EC04260-100	57	FS40592-1	48	FS46352	49

SIERRA #	PAGE #	SIERRA #	PAGE #	SIERRA #	PAGE #	SIERRA #	PAGE #
SIERRA SWITCH & ELECTRICAL							
FS46400	49	FS79940	882-885	MP28870	32, 215	MP39590	44
FS46402	49	FS79950	882-885	MP28880	32, 215, 751	MP39592	44
FS46450	49	FS80000	47	MP28890	32, 215, 751	MP39600	44
FS46452	49	FS80010	47	MP35650	52	MP39602	44
FS46551	49	FS80020	47	MP35660	882-885	MP39610	44
FS46561	49	FS80030	47	MP38910	56	MP39612	44
FS56232	47	FS80040	47	MP39010	26, 28	MP39620	45
FS56242	47	FS80050	47	MP39012	28	MP39622	45
FS56252	47	FS80060	47	MP39020	26, 28	MP39640	45
FS69100	51	FS80070	47	MP39022	28	MP39642	45
FS69110	51	FS80080	47	MP39030	42, 43	MP39670	45
FS69120	51	FS80090	47	MP39032	43	MP39672	45
FS69130	50	FS81000	47	MP39040	26, 31	MP39680	45
FS69140	51	FS81010	47	MP39042	31	MP39682	45
FS69150	51	FS81020	47	MP39060-1	28	MP39690	45
FS69160	51	FS81030	47	MP39062-1	28	MP39692	45
FS69170	51	FS81040	47	MP39070	27	MP39700	26, 27
FS69180	51	FS81050	47	MP39072	27	MP39702-1	27
FS79000	46	FS81060	47	MP39077	27	MP39710	26, 29
FS79010	882-885	FS81080	47	MP39080-1	28	MP39712-1	29
FS79020	882-885	FS81082	47	MP39082-1	28	MP39720	26, 29
FS79030	882-885	FSC46100	49	MP39090	31	MP39722-1	29
FS79040	882-885	FSC46200	49	MP39092	31	MP39730	26, 29
FS79050	46	FSC46300	49	MP39100	26, 31, 32, 215	MP39732	29
FS79060	46	FSC46400	49	MP39102	31	MP39733	29
FS79070	46	FSC46550	49	MP39120	26, 28, 32	MP39740-1	30
FS79080	46	FSC46560	49	MP39122	28	MP39742-1	30
FS79090	46	GS62600	23	MP39140	46	MP39760	26, 30, 215
FS79100	46	GS62610	23	MP39142	46	MP39762	30
FS79110	46	GS62620	23	MP39160	45, 411	MP39770	26, 28
FS79120	46	GS62630	23	MP39162	45	MP39772	28
FS79130	46	GS62640	23	MP39170	46	MP39780	26, 28
FS79140	46	GS62650	23	MP39172	46	MP39782	28
FS79150	46	GS62660	23	MP39180	45	MP39800	26, 27
FS79160	46	GS62670	23	MP39182	45	MP39802	27
FS79170	46	GS62680	23	MP39190	32	MP39820-1	26, 29
FS79180	46	GS62690	23	MP39200	26, 28	MP39822-1	29
FS79190	46	GS62700	23	MP39202	28	MP39830	26, 31, 215
FS79200	46	GS62710	23	MP39210	52	MP39832	31
FS79210	46	GS62720	23	MP39220	43	MP40950	32
FS79220	46	GS62730	23	MP39222	43	MP40960	32
FS79230	882-885	GS62740	23	MP39240	43	MP40962	32
FS79240	882-885	GS62750	23	MP39242	43	MP40970-1	32
FS79250	46	GS62760	23	MP39260	46	MP40972-1	32
FS79260	46	GS62770	23	MP39262	46	MP40980	32
FS79270	46	GS62780	23	MP39270	32	MP40982	32
FS79280	46	GS62790	23	MP39280	43	MP40988	32
FS79290	46	GS62800	23	MP39282	43	MP40990	32
FS79300	882-885	GS62810	23	MP39300	45	MP40992	32
FS79310	882-885	GS62820	23	MP39302	45	MP41000	26, 30, 308
FS79320	46	GS62830	23	MP39310	45	MP41002	30
FS79330	882-885	GS62840	24	MP39312	45	MP41010	26, 29
FS79340	882-885	GS62850	24	MP39320	45	MP41012	29
FS79360	OBSOLETE	GS62860	24	MP39322	45	MP41020	26, 27
FS79370	46	GS62870	24	MP39340	45	MP41022	27
FS79380	882-885	GS62880	24	MP39342	45	MP41030	26, 28
FS79390	882-885	GS62890	24	MP39350	46	MP41040	26, 27
FS79470	46	GS62900	24	MP39352	46	MP41042	27
FS79480	47	GS62910	24	MP39360	45	MP41070-2	30, 308
FS79490	47	GS62920	24	MP39362	45	MP41072-2	30
FS79500	47	GSS62600	24	MP39370	882-885	MP41080	26, 29
FS79510	47	GSS62610	24	MP39372	882-885	MP41082	29
FS79520	47	GSS62630	24	MP39380	44	MP41090	26, 30
FS79530	47	GSS62640	24	MP39382	44	MP41400	52
FS79540	47	GSS62670	24	MP39390	44	MP42402	60
FS79550	47	GSS62680	24	MP39390B	44	MP49410	60
FS79560	47	GSS62700	24	MP39392	44	MP49412	60
FS79570	47	GSS62710	24	MP39392B	44	MP49430	60
FS79580	47	GSS62720	24	MP39400	45	MP49432	60
FS79590	47	GSS62740	24	MP39402	45	MP49500	59
FS79600	46	GSS62750	24	MP39410	45	MP49510	882-885
FS79630	46	GSS62760	24	MP39412	45	MP49520	882-885
FS79680	47	GSS62770	24	MP39420	45	MP49550	59
FS79690	47	GSS62780	24	MP39422	45	MP50560	60
FS79800	882-885	GSS62790	24	MP39510	44	MP50562	60
FS79810	882-885	GSS62800	24	MP39512	44	MP51010	25, 399
FS79820	46	GSS62820	24	MP39520	44	MP51012	25, 399
FS79830	882-885	GSS62830	24	MP39522	44	MP51020	25, 411
FS79850	882-885	MB10463	882-885	MP39530	44	MP51022	25, 411
FS79870	46	MC33502	52	MP39532	44	MP51030	25, 411
FS79890	882-885	MC45110	882-885	MP39540	44	MP51032	25, 411
FS79900	882-885	MP21460	45	MP39542	44	MP51040	25, 411
FS79910	882-885	MP21462	45	MP39570	44	MP51042	25, 411
FS79920	882-885	MP28850	32	MP39572	44	MP51050	25, 411
FS79930	882-885	MP28860	32, 411	MP39580	44	MP51052	25, 411
				MP39582	44	MP51090	25, 31, 308

SIERRA #	PAGE #	SIERRA #	PAGE #	SIERRA #	PAGE #	SIERRA #	PAGE #
SIERRA SWITCH & ELECTRICAL							
MP51090	25, 31, 308	RK19440	s/s to RK19440-1	RK19942	Obsolete	TC51000	53
MP51092	25, 31, 308	RK19440-1	38	RK21420	40	TC51100	53
MP51092	25, 31, 308	RK19442	Obsolete	RK21430	40	TC51200	53
MP52000	25, 31, 308	RK19450	s/s to RK19450-1	RK21880	40	TC51300	54
MP52000	25, 31, 308	RK19450-1	38	RK21890	40	TC52000	53
MP52002	25, 31, 308	RK19452	Obsolete	RK21920	882-885	TC52100	53
MP52002	25, 31, 308	RK19460	s/s to RK19460-1	RK22070	40	TG19520	33, 41
MP59012	34	RK19460-1	38	RK22100	36	TG19522	41
MP59032	34	RK19462	Obsolete	RK22110	36	TG19530	33, 41
MP59042	34	RK19480	RK19480-1	RK22120	37	TG19532	41
MP59062	882-885	RK19482	Obsolete	RK22130	37	TG19540	33, 42
MP59102	34	RK19490	RK19490-1	RK22140	37	TG19542	42
MP59112	882-885	RK19492	OBSOLETE	RK22150	37	TG19550	33, 42
MP59122	34	RK19500A	33	RK22160	38	TG19552	42
MP59132	34	RK19500C	882-885	RK22170	38	TG19560	33, 42
MP59162	34	RK19500G	882-885	RK22180	35	TG19562	42
MP78372	34	RK19500K	33, 39	RK22190	35	TG21000	882-885
MP78710	33, 34	RK19500R	882-885	RK22200	35	TG21002	882-885
MP78712	34	RK19510A	33	RK22290	35	TG21020-1	42
MP78720	33, 34	RK19510C	882-885	RK40100	33, 39	TG21022-1	42
MP78722	34	RK19510G	882-885	RK40102	39	TG21030-1	882-885
MP78730	33, 34	RK19510K	33, 39	RK40110	33, 39	TG21032-1	882-885
MP78732	34	RK19510R	882-885	RK40112	39	TG21040	42
MP78740	33, 34	RK19520AC	882-885	RK40120	33, 39	TG21042	42
MP78750	882-885	RK19520AG	882-885	RK40122	39	TG21050-1	42
MP78752	882-885	RK19520GC	882-885	RK40130	33, 39	TG21052-1	42
MP78760	882-885	RK19520K	33, 39	RK40132	39	TG21070	42
MP78762	882-885	RK19520RC	882-885	RK40140	33, 38	TG21072	42
MP78790	882-885	RK19530AC	882-885	RK40140W	33, 39	TG21080	42
MP78792	882-885	RK19530AG	882-885	RK40142	38	TG21082	42
MP78800	33, 34	RK19530GC	882-885	RK40142W	39	TG21130	43
MP78802	34	RK19530K	33, 39	RK40150	33, 38	TG21132	43
MP78820	33, 34	RK19530RC	882-885	RK40150W	33, 39	TG21140	43
MP78822	34	RK19540	RK19540-1	RK40152	38	TG21142	43
MP78830	33, 34	RK19542	OBSOLETE	RK40152W	39	TG21160	882-885
MP78860	34	RK19550	s/s to RK19550-1	RK40170	33, 38	TG21162	882-885
MP78870	34	RK19550-1	38	RK40170W	33, 39	TG21360	43
MP78872	34	RK19552	Obsolete	RK40172	38	TG21362	43
MP78880	34	RK19560S	s/s to RK19560-1	RK40172W	39	TG21390	43
MP78882	34	RK19570	33, 38	RK40350	33, 38	TG21392	43
MP78910	34	RK19572	38	RK40352	38	TG21500	43
MP78912	34	RK19580K	33, 40	RK40360	33, 38	TG21502	43
MP78942	34	RK19630	40	RK40362	38	TG21590	43
MP78950	34	RK19632	40	RK40370	33, 39	TG21592	43
MP78952	34	RK19640	40	RK40372	39	TG21600	43
MP78960	34	RK19642	40	RK40380	33, 39	TG21602	43
MP78962	34	RK19650	882-885	RK40382	39	TG22000	33, 42
MP79730	34	RK19660	882-885	RK40390	33, 39	TG22002	42
MP79732	34	RK19680	33, 36	RK40392	39	TG22010	33, 42
MP79740	34	RK19680TP	33, 36	RK40400	33, 39	TG22012	42
MP79742	34	RK19690	33, 36	RK40402	39	TG22020	33, 42
MP79760	34	RK19690TP	36	RK40470	33, 38	TG22022	42
MP79762	34	RK19700	33, 37	RK40472	38	TG22030	33, 42
N-186913	50	RK19700TP	33, 37	RK40480	33, 38	TG22032	42
OP22891	18, 52	RK19702	Obsolete	RK40482	38	TG22040	33, 42
OP22900	18, 52	RK19710TP	33, 36	TC42834	54	TG22042	42
OP24331	882-885	RK19720	33, 36	TC42884	53	TG23000	42
OP72533	18	RK19730TP	33, 37	TC42894	54	TG23010	42
PD49600	882-885	RK19740	33, 37	TC42904	54	TG23020	42
PD49620	882-885	RK19750TP	33, 36	TC42914	54	TG23030	42
PD49650	882-885	RK19760	33, 36	TC42984	53	TG23040	42
PD49670	882-885	RK19770TP	33, 37	TC43084	54	TG40000	42
PD49680	882-885	RK19780	33, 37	TC43094	54	TG40002	42
RK19210	35	RK19792	OBSOLETE	TC43354	54	TG40010	33, 41
RK19220	35	RK19800	33, 36	TC43364	882-885	TG40012	41
RK19230	35	RK19802	Obsolete	TC43504	54	TG40020-1	33, 41
RK19240	35	RK19810TP	33, 37	TC43604	54	TG4002252	41
RK19310	35	RK19820	33, 37	TC43614	54	TG40030-1	33, 41
RK19320	35	RK19830TP	33, 37	TC43624	54	TG4003252	41
RK19400	RK19400-1	RK19840	33, 37	TC43634	54	TG40040-1	33, 41
RK19400-1	38	RK19850TP	33, 36	TC43654	53	TG4004252	41
RK19400S	RK19400-1	RK19860	33, 36	TC43674	53	TG40050-1	33, 41
RK19402	Obsolete	RK19870TP	33, 36	TC43724	53	TG4005252	41
RK19410	RK19410-1	RK19880	33, 36	TC43744	53	TG40060	33, 41
RK19410-1	38	RK19890TP	33, 37	TC43754	53	TG40062	41
RK19410-RED	38	RK19910	33, 37	TC43844	53	TG40070	33, 41
RK19410S	RK19410-1	RK19912	Obsolete	TC43904	54	TG40072	41
RK19412	Obsolete	RK19920	s/s RK19920-1	TC43924	53	TG40080	33, 41
RK19420	RK19420-1	RK19920-1	38	TC43944	54	TG40082	41
RK19420-1	38	RK19922	Obsolete	TC44054	53	TG40090	33, 41
RK19420S	RK19420-1	RK19930	38	TC44094	53	TG40092	41
RK19422	Obsolete	RK19930	s/s RK19930-1	TC44224	53	TG40160-1	33, 41
RK19430	RK19430-1	RK19932	Obsolete	TC44254	53	TG4016252	41
RK19430-1	38	RK19940	s/s to RK19940-1	TC44984	54	TG40300	33, 41
RK19432	Obsolete	RK19940-1	38	TC50000	54	TG40302	41

SIERRA #	PAGE #	SIERRA #	PAGE #	SIERRA #	PAGE #	SIERRA #	PAGE #
SIERRA SWITCH & ELECTRICAL							
TG40310	33, 41	UN19690	56	UN22120	43	WH10230	55
TG40312	41	UN19700	40	UN22122	43	WH10240	55
TG40320	33, 41	UN19710	40	UN22150	43	WH10300	54
TG40322	41	UN19720	40	UN22152	43	WH10310	54
TG40330	33, 41	UN19730	40	UN22160	43	WH10320	55
TG40332	41	UN19740	40	UN22162	43	WH10350	53
TG40340	33, 41	UN19750	40	UN22190	44	WH10470	55
TG40342	41	UN21280	44	UN22192	44	WH10480	55
TG40450-1	33, 41	UN21282	44	UN42000	46	WH10490	55
TG4045252	41	UN21290	44	UN42002	46	WH10500	55
TG40460-1	33, 41	UN21292	44	UN77310	56	WH10520	55
TG4046252	41	UN21320	44	WH10003	53	WH10530	55
TG40490	33, 41	UN21322	44	WH10040	55	WH10540	55
TG40492	41	UN22100	43	WH10160	55	WH10550	55
TS25101	18, 52	UN22102	43	WH10180	53	WH10600	55
UN12140	26, 27	UN22110	43	WH10200	Obsolete	WH10610	55
UN12142	27	UN22112	43	WH10220	55		

SHIELDS							
18-4456	99	N-184456	99	SERIES 149	68, 76, 87	SERIES 291	98
18-4457	99	N-184457	99	SERIES 150	76	SERIES 309	309
18-4458	99	N-184458	99	SERIES 151	102	SERIES 315	79
18-7307	99	N18NEO60	102	SERIES 160	69	SERIES 331	135, 136, 228
18-7308	99	N316NEO60	102	SERIES 162	77	SERIES 337	80, 135
18-7309	99	N38NEO60	102	SERIES 163	77	SERIES 350	81
18-7310	99	SERIES 101	85	SERIES 164	78	SERIES 351	81
18-7311	99	SERIES 105	85	SERIES 168	78	SERIES 355	82
18-7312	99	SERIES 120	65	SERIES 200	70, 90	SERIES 365	82
18-7313	99	SERIES 123	65	SERIES 202	71, 91	SERIES 368	83
18-7314	99	SERIES 126	101	SERIES 220	97	SERIES 369	83
18-7315	99	SERIES 128	101	SERIES 220S	95	SERIES 400	88
18-7316	99	SERIES 130	65	SERIES 221	97	SERIES 402	88
18-7317	99	SERIES 135	69	SERIES 245	97	SERIES 420	88
18-800-1120	85	SERIES 140	66	SERIES 245S	96	SERIES 450	89
18-801-1120	85	SERIES 141	67, 75	SERIES 250	72, 92	SERIES 460	89
18-802-1120	85	SERIES 142	66	SERIES 252	73, 93	SERIES 500	100
18-803-1120	85	SERIES 144	86	SERIES 262	74, 94	SERIES 502	100
18-806-1120	85	SERIES 145	Obsolete	SERIES 272	95	SERIES 600	100
18-9761	101	SERIES 146	67, 86	SERIES 274	95	SERIES 601	100
18-9883	101	SERIES 147	66	SERIES 290	98	SERIES 700	100
18-J-VISE	100	SERIES 148	68, 75, 87	SERIES 290S	96	SERIES 720	99
N14NEO60	102						

SIERRA #	O.E.M.	O.E. #	PAGE #	SIERRA #	O.E.M.	O.E. #	PAGE #
----------	--------	--------	--------	----------	--------	--------	--------

GENERATOR PARTS							
23-0400	Northern Lights		106	23-3300	Onan	132-0349	105
23-0800	Westerbeke	42260	108, 115, 117	23-3301	Westerbeke	11907	105, 114, 116
23-0801	Westerbeke	46124	108, 115, 117	23-3302	Westerbeke	33112	105, 114, 116
23-0802	Westerbeke	34196	108, 115, 117	23-3303	Kohler	229826	105, 116, 118, 120, 122
23-0803	Westerbeke	33417	108, 117	23-3304	Kohler	229955	105
23-0804	Westerbeke	33373	108, 115	23-3305	Westerbeke	32620	105, 114, 116, 122
23-0805	Westerbeke	40434	108, 117	23-3306	Westerbeke	46622	106, 114, 116
23-0806	Westerbeke	24323	108, 115	23-3307	Westerbeke	34440	106, 114
23-0807	Westerbeke	33966	108, 115	23-3308	Kohler	352122	106, 120
23-0808	Westerbeke	37922	108, 115, 117	23-3309	Onan	132-0436	106
23-0809	Kohler	267718	108, 121	23-3310	Onan	541-1519	106
23-0810	Kohler	229432	108, 119	23-3311	Fischer Panda	J009-46840	106
23-0811	Kohler	249865	108, 119, 121	23-3312	Fischer Panda	J009-1027B-1	106
23-0812	Kohler	229433	109, 119, 121	23-3313	Westerbeke	33104	106, 114
23-0813	Kohler	229963	109, 117, 119, 121, 123	23-3314	Kohler / Sherwood	8000K	106, 120
23-0814	Kohler	352031	109, 121	23-3314	Kohler / Sherwood	500190G	106, 120
23-0830	Northern Lights	11-10015	109	23-3314	Kohler / Sherwood	359978	106, 120
23-1000	Westerbeke	24353	104, 115	23-3315	Northern Lights	25-12009	106, 124
23-1100	Kohler	267709	103	23-3600	Westerbeke	26488	107, 114, 116
23-1101	Westerbeke	39705	103, 115, 117, 121	23-3601	Westerbeke	35736	107, 114, 116
23-1102	Northern Lights	24-22009	103	23-3602	Westerbeke	37387	107, 114, 116
23-1103	Northern Lights	24-28003	103	23-3603	Westerbeke	39378	107, 114, 116
23-1104	Fischer Panda	IC78.460.000B	103, 123, 125	23-3604	Westerbeke	46097	107
23-1105	Fischer Panda	IC78.460.000A	103, 123	23-3605	Westerbeke	24690	107, 114, 116
23-1130	Kohler	278857	103, 117, 119	23-3606	Onan	309-0130	107
23-2000	Sherwood	10077K	105, 114, 116, 122	23-3607	Kohler	352018	107, 120
23-2001	Johnson Pump	09-808B-1	105, 114, 116, 122	23-3608	Kohler	249930	107, 120, 122
23-2002	Kohler	229826	105, 116, 118, 120, 122	23-3609	Kohler	252896	107, 118
23-2002	Sherwood	09000K	105, 116, 118, 120, 122	23-3610	Kohler	267717	108, 120
23-2003	Kohler	250872	105	23-3650	Westerbeke	24688 & 24323	109, 115
23-2003	Jabsco	22799-0001	105	23-3651	Westerbeke	35736 & 34196	109, 115, 117
23-2004	Kohler	359978	105, 120	23-3652	Westerbeke	35736 & 33417	109, 117
23-2005	Northern Lights	25-12009	105, 124	23-3653	Westerbeke	24688 & 34196	109, 115
23-2700	Westerbeke	40859	110	23-3654	Westerbeke	39378 & 42260	109, 115, 117
23-2701		34113	110	23-3655	Westerbeke	39378 & 46124	109, 115, 117
23-2702	Westerbeke	35608	110	23-3656	Westerbeke	46097 & 33417	109, 117
23-2703	Westerbeke	46592	110	23-3657	Westerbeke	24690 & 33417	109, 117
23-2800		34093	111	23-3658	Westerbeke	24688 & 33966	110, 115
23-2801		35610	111	23-3659	Westerbeke	37387 & 37922	110, 115, 117
23-2802	Westerbeke	40860	111	23-3660	Westerbeke		110, 115
23-2803	Westerbeke	43050	111	23-3661	Westerbeke		110, 117
23-2804		42201	111	23-3662	Westerbeke		110, 117

SIERRA #	O.E.M.	O.E. #	PAGE #	SIERRA #	O.E.M.	O.E. #	PAGE #
GENERATOR PARTS							
23-3663	Kohler		110, 121	23-7740	Kohler	252898	103, 118, 120
23-3664	Kohler		110, 121, 123	23-7750	Onan	149-0428	104
23-3665	Kohler		110, 119	23-7751	Kohler	229715	103, 116, 118, 124
23-3666	Kohler		110, 121	23-7760	Onan	149-2106	104
23-4000	Westerbeke	39181	113	23-7760	Onan	A026K278	104
23-4001	Westerbeke	11672	113	23-7761	Kohler	GM32359	104
23-4002	Westerbeke	30592	113	23-7762	Kohler	26987	104, 120, 122
23-4003	Westerbeke	45232	113	23-7764	Westerbeke	24363	104, 114
23-4004	Westerbeke	30475	113	23-7770	Westerbeke	30200	104, 114, 116
23-4005	Westerbeke	13810	106	23-7770	Westerbeke	47060	104, 114, 116
23-4006	Westerbeke	31152	107	23-7771	Kohler	249433	104, 120, 122
23-4007	Westerbeke	30376	107	23-7780	Kohler	GM34570	104
23-4500	Westerbeke	43060	111	23-7800	Westerbeke	36918	111
23-4501	Westerbeke	46596	111	23-7801	Westerbeke	35595	111, 115, 117, 125
23-5600	Westerbeke	30593	113, 114	23-7802	Westerbeke	48076	111, 115
23-5601	Westerbeke	34552	113, 114, 116	23-7803	Kohler	326817	111, 121, 123
23-5800	Westerbeke	24639	113, 115	23-7804	Onan	185-7444	111
23-5840	Westerbeke	35109	104	23-7820	Kohler	279449	111, 123
23-5880	Westerbeke	24132	104, 115, 117	23-7821	Kohler	359771	112, 121
23-5900	Westerbeke	30594	113, 114	23-7822	Kohler	229678	112, 117, 119
23-6400	Westerbeke	11885	113	23-7823	Kohler	267714	112, 121
23-6400	Kohler	260085	113	23-7824	Kohler	GM47465	112
23-6401	Onan	130-4434	113, 123	23-7825	Westerbeke	35828	112, 115
23-6402	Onan	130-6228	113, 123	23-7826	Westerbeke	40154	112, 115
23-7200	Westerbeke	36450	103, 117	23-7840	Onan	122-0810	112
23-7201	Westerbeke	38100	103, 115, 117	23-7841	Onan	122-0185	112, 123
23-7202	Kohler	GM24510	103	23-7842	Onan	185-5835	112
23-7720	Westerbeke	35920	104, 114, 116				19, 112
23-7720	Onan	149-1445	104				19, 112

SIERRA

4700			478	99026			882-885
4701			478	99027			882-885
4702			478	99029			882-885
4703			478	99030			882-885
4704			478	99031			882-885
4705			478	1525607	OMC	317201	166
4710			478	1525607	OMC	508235	166
4711			478	1525607	MERCURY MARINE	92-34227 1	166
4712			478	1525607	MERCURY MARINE	92-802881A-1	166
4713			478	16-331-0386	OMC	333341	135, 136, 228
4714			478	16-331-0566	OMC	125115	135, 136, 228
4715			478	18-0020	YAMAHA	67C-W0001-21-00	466
4720			478	18-0021	YAMAHA	688-W0001-22-00	466
4721			478	18-0022	YAMAHA	689-W0001-23-00	466
4722			478	18-0023	YAMAHA	689-W0001-C2-00	466
4723			478	18-0024	YAMAHA	698-W0001-21-00	466
4724			478	18-0025	YAMAHA	69G-W0001-20-00	466
4725			478	18-0026	YAMAHA	6A1-W0001-22-00	467
4730			478	18-0027	YAMAHA	6A1-W0001-23-00	467
4731			478	18-0028	YAMAHA	6E0-W0001-C1-00	467
4732			478	18-0029	YAMAHA	6G1-W0001-C1-00	467
4733			478	18-0030	YAMAHA	6L2-W0001-C3-00	467
4734			478	18-0031	YAMAHA	6N0-W0001-C0-00	467
4735			478	18-0032	VOLVO	847741	152, 581, 848
22355	OMC	390905	166	18-0033	VOLVO	478736	152
22423	OMC	324073	166	18-0034	VOLVO	477556	152, 581, 848
22423	OMC	327361	166	18-0035	VOLVO	3582732	152, 581, 848
22423	YAMAHA	90790-74001-00	166	18-0036	VOLVO	3582733	152, 581, 848
22423	MERCURY MARINE	92-12564-1	166	18-01000			175
22423	MERCURY MARINE	92-12564 2	166	18-0101	MERCURY MARINE	27-76952	356, 359
37394			166	18-0102	OMC	323469	250, 259
37467			166	18-0103	MERCURY MARINE	27-796501	362
37477	OMC	500421	166	18-0104	OMC	907764	784, 786
37478	OMC	388517	166	18-0105	MERCURY MARINE	27-85489-2	357, 360
37478	OMC	500422	166	18-0106	OMC	324323	251, 259
37478	MERCURY MARINE	92-809819	166	18-0107	MERCURY MARINE	27-85498-1	356, 360
37479	OMC	500423	166	18-0108	OMC	324449	236, 263, 289
37479	MERCURY MARINE	92-809820	166	18-0110	OMC	324670	262
37509	OMC	384884	166	18-01100			175
37509	MERCURY MARINE	92-59327-1	166	18-0111	MERCURY MARINE	27-89657	687, 691
37534	MERCURY MARINE	92-41669-1	167	18-0112	OMC	324717	251, 260
37534	MERCURY MARINE	92-823506 1	167	18-0113	MERCURY MARINE	27-856705	691
37566			166	18-0113	MERCURY MARINE	27-97542	687, 691
37643			166	18-0114	OMC	907761	196, 772, 777, 784, 786
37701			166				196, 772, 777, 784, 786
38653	OMC	384848	166	18-0115	CHRYSLER FORCE	27-F307279-2	196, 198
49409			478	18-0116			165
49410			478	18-0117	OMC	317955	259
49411			478	18-0118	OMC	325092	249-252, 257
56507	OMC	910048	167	18-0119	CHRYSLER FORCE	27-F85154-1	197
79040	OMC	390928	166	18-0120	OMC	325211	250, 259
99006			882-885	18-01200			175
99010			882-885	18-01202			175
99014			882-885	18-0122	OMC	325260	251, 258
99019			882-885	18-0124	OMC	325537	233, 262, 267, 290
99023			882-885	18-0126	OMC	326264	251, 259
99025			882-885	18-0128	OMC	326468	250, 252, 260

1 This product is priced per piece. To order, priced per package, please add -9 to the part number
 2 Items ending in "D" are display packaged - regular number is non-display
 3 For discount shop pack of 10, please add -10 to the part number

SIERRA #	O.E.M.	O.E. #	PAGE #	SIERRA #	O.E.M.	O.E. #	PAGE #
SIERRA							
18-0129	MERCURY MARINE	27-657443	360	1 18-0203	MERCURY MARINE	12-35935	695
18-0130	OMC	332266	252, 253, 258	18-02060	OMC	911680	791, 792
18-01301			175	18-02061	OMC	911681	791, 792
18-01302			175	18-02062	OMC	911662	791, 792
18-01308			175	18-02063	OMC	911663	791, 792
18-0131	MERCURY MARINE	27-695252	360	18-02064	OMC	911664	791, 792
18-01311			175	18-02065	OMC	911665	791, 792
18-01312			175	18-02066	OMC	911666	791, 792
18-01313			175	18-02067	OMC	911667	791, 792
18-01314			175	18-0207	OMC	911668	791, 792
18-0133	MERCURY MARINE	27-73665	356, 360	18-0208	MERCURY MARINE	23-1761515	882-885
1 18-0134	OMC	327707	249-251, 257	18-0209	OMC	911671	791
18-0135	MERCURY MARINE	27-78246	354, 355, 358, 362	18-0209	OMC	911669	791, 792
18-0135	MERCURY MARINE	27-782461	354, 355, 358, 362	18-0209	OMC	911670	791, 792
18-0136	OMC	328283	250, 252, 260	18-0209	OMC	911672	791, 792
18-0137	MERCURY MARINE	27-85492-2	355, 356, 360	18-0209	OMC	911673	791, 792
18-0138	OMC	328590	251, 252, 260	18-0209	OMC	911674	791, 792
18-0139	MERCURY MARINE	27-884511	362	18-0209	OMC	911675	791, 792
18-0140	OMC	328604	251, 258	18-0209	OMC	911676	791, 792
18-01402			175	18-0209	OMC	911677	791, 792
18-01404			175	18-0210	MERCURY MARINE	23-1761516	882-885
18-01406			175	18-0211	OMC	911671	791
18-01408			176	18-0211	OMC	911669	791, 792
18-0141	CHRYSLER FORCE	27-F85762	195-197	18-0211	OMC	911670	791, 792
18-01416			176	18-0211	OMC	911672	791, 792
18-01418			176	18-0211	OMC	911673	791, 792
18-0142	OMC	328622	251-253, 258	18-0211	OMC	911674	791, 792
18-01422			176	18-0211	OMC	911675	791, 792
1 18-0144	OMC	328626	252, 258	18-0211	OMC	911676	791, 792
18-0146			842	18-0211	OMC	911678	791, 792
18-0147	MERCURY MARINE	27-56880	693	18-0212	MERCURY MARINE	23-1761517	882-885
18-0147	OMC	3852824	787	18-0214	MERCURY MARINE	23-1761518	882-885
18-0147	VOLVO	3852824	857	18-0218	MERCURY MARINE	23-1761520	882-885
18-0148	OMC	329718	250, 251, 258	18-0222	MERCURY MARINE	23-1761522	882-885
18-0150	OMC	329975	Obsolete	18-0224	MERCURY MARINE	23-1761523	882-885
18-01500			176	18-0226	MERCURY MARINE	23-1761524	882-885
18-0151	MERCURY MARINE	27-76636	361	18-0227	OMC	911678	791, 792
1 18-0152	CHRYSLER FORCE	27-F481836	197	18-0229	OMC	911679	791, 792
18-0153	OMC	357159	783	18-0232	MERCURY MARINE	27-81031M	361
18-0153	OMC	393159	783	18-0232	YAMAHA	655-12414-A1-00	442, 452
18-0153	OMC	458625	783	18-0239	YAMAHA	688-44315-A0-00	452
18-0153	MERCURY MARINE	27-85817A1	685, 687	18-0240	YAMAHA	688-44316-A0-00	453
1 18-0154	CHRYSLER FORCE	27-F40279-1	196, 198, 250	18-0242	YAMAHA	663-13622-00-00	882-885
18-0155	OMC	330412	251-253, 262	18-0244	YAMAHA	6E5-44315-A0-00	469
18-0157	OMC	330698	250, 252, 258	18-0246	YAMAHA	663-14483-A0-00	882-885
18-0158	MERCURY MARINE	27-70905	687, 691	18-0247	YAMAHA	663-41114-A0-00	882-885
18-0159	OMC	330909	250, 258	18-0248	HONDA	17151-ZW5-00	206
18-01600			176	18-0250	YAMAHA	664-41114-A0-00	442, 452
18-01602			176	18-0252	VOLVO	876314	852
18-0161	OMC	331532	253, 258	18-0256	YAMAHA	97095-08045-00	427, 459
18-0163			844	18-0265	YAMAHA	93101-28M16-00	463, 465,
1 18-0164	VOLVO	3852096	855				468, 469
1 18-0164	YAMAHA	YSC-13080-00-0C	866	18-0266	YAMAHA	93101-30M17-00	463, 465,
1 18-0164	OMC	311069	784, 785				468, 469
1 18-0166	OMC	911705	788	18-0267	MERCURY MARINE	26-82257M	386, 388
18-01701			176	18-0267	YAMAHA	93106-09014-00	461, 467-469
18-01703			176	18-0275	YAMAHA	93210-97M55-00	465, 468, 469
18-01705			177	18-0292	MERCURY MARINE	27-81417M	342, 363, 386
18-01707			177	18-0292	YAMAHA	663-44315-A0-00	453
18-0172	MERCURY MARINE	26-97530	738	1 18-0294	MERCURY MARINE	27-81421M	363, 386
18-0173	OMC	313283	293	1 18-0294	YAMAHA	663-44324-A0-00	433, 453,
18-0174	OMC	326716	293				459, 467, 468
18-0175	MERCURY MARINE	25-26543	739	18-0296	MERCURY MARINE	26-82233M	386, 388
18-0176	HONDA	19242-ZV5-000	205	18-0296	MERCURY MARINE	26-83406M	386, 388
18-0179	RACOR	RK22244	127	18-0296	YAMAHA	93101-22067-00	457, 459, 467-469
1 18-0182	MERCURY MARINE	27-62386	335, 353-355,	18-0297	MERCURY MARINE	26-82234M	386, 388
			357, 358, 363	18-0297	YAMAHA	93101-23070-00	459, 467-469
1 18-0182	OMC	310058	261	18-0298	YAMAHA	93210-41042-00	459, 467-469
18-0183			534, 552, 563, 669, 691	18-0299	YAMAHA	93210-66M98-00	459, 467-469
18-0183	PLEASURECRAFT	RM0007	550, 552, 561	18-0300	HONDA	17105-ZY6-000	206
18-0183	MERCURY MARINE	27-73866	563, 659, 669, 691	18-0305	CRUSADER	96108	523, 527, 531, 534
18-0183	OMC	908717	777	18-0306	CRUSADER	96216	535
18-0183	VOLVO	3852455	855	18-0307	VOLVO	861250	856
18-0183	VOLVO	3853742	855	18-0308	CRUSADER	96331	882-885
18-0183	OMC	3852455	777	18-0309	CRUSADER	96562	523, 527, 531, 534
18-0183	OMC	3853742	777	18-0310	VOLVO	861251	856
18-0183	OMC	916262	777	18-0311	CRUSADER	97686	535
18-0184	VOLVO	804190	860	18-0311	MERCURY MARINE	27-11988	692
1 18-0185	MERCURY MARINE	27-91892	685, 687, 693	18-0311	OMC	3854942	787
18-0188	OMC	909748	263	18-0311	VOLVO	3854942	856
18-0190	OMC	912157	788	18-0313	OMC	352165	262
18-0191	YAMAHA		439	18-0314	CHRYSLER FORCE	27-828316	197
18-0192	YAMAHA		439	18-0314	CHRYSLER FORCE	27-F178168	197
18-0194	OMC	317230	882-885	18-0314	CHRYSLER FORCE	F178168	197
18-0195	OMC	314731	296	1 18-0315	CHRYSLER FORCE	27-F440906	195, 197
18-0196	OMC	332514	882-885	18-0318	MERCURY MARINE	12-815472	695
18-0197	OMC	333725	269, 279	18-0319	MERCURY MARINE	27-828553	362
18-0198	OMC	324766	271, 273, 279, 796	18-0320	MERCURY MARINE	27-13937-6	353, 354, 360
18-0200	OMC	327656	273, 275, 279	18-03200			176
18-0201	OMC	333771	269, 279	18-03206			176
2 18-0202-9	MERCURY MARINE	8227731	380	18-03208			176

1 This product is priced per piece. To order, priced per package, please add -9 to the part number

2 Items ending in "D" are display packaged - regular number is non-display

3 For discount shop pack of 10, please add -10 to the part number

SIERRA #	O.E.M.	O.E. #	PAGE #	SIERRA #	O.E.M.	O.E. #	PAGE #
SIERRA							
1	18-0322	MERCURY MARINE	27-14247	694	18-0410	OMC	3854406 783
1	18-0322	MERCURY MARINE	27-881715	694	18-0410	VOLVO	3853912 853
1	18-0322	OMC	3852656	788	18-0410	VOLVO	3853913 853
1	18-0322	VOLVO	3852656	858	18-0410	VOLVO	3854406 853
	18-0323	MERCURY MARINE	27-14318-2	363	18-0411	MERCURY MARINE	27-90458A1 688
	18-0323	MERCURY MARINE	27-14318 3	363	18-0411	OMC	357159 783
	18-0324	MERCURY MARINE	27-15172-3	353	18-0411	OMC	458625 783
	18-0324	MERCURY MARINE	27-151724	359	18-0411	OMC	508876 783
	18-0327	MERCURY MARINE	27-33956	688, 693	18-0411	OMC	14079398 576, 577, 688, 783
	18-0327	OMC	3853342	787	1 18-0412	OMC	337068 253, 261
	18-0327	VOLVO	3853342	856	1 18-0415	CHRYSLER FORCE	27-F523031 198
1	18-0328	MERCURY MARINE	27-34208	692	1 18-0416	CHRYSLER FORCE	27-828316 193, 198
	18-0329	MERCURY MARINE	27-34209	693	1 18-0416	CHRYSLER FORCE	27-F178168 193, 198
	18-0329			570, 693, 788	1 18-0416	CHRYSLER FORCE	F178168 193, 198
	18-0333	MERCURY MARINE	27-39401	362	1 18-0417	CHRYSLER FORCE	27-F84031 198
	18-0334	MERCURY MARINE	27-39402	362	18-0418	OMC	909613 787
	18-0336	MERCURY MARINE	27-41670-3	362	18-0418	VOLVO	3852472 855
	18-0336	MERCURY MARINE	27-41670-5	362	18-0418	CRUSADER	96653 534, 563, 669, 691, 787
	18-0337			842			
	18-0339	MERCURY MARINE	27-43006-2	353, 354, 363	18-0418	MERCURY MARINE	27-46820 563, 651, 669, 684, 685, 691
	18-0340	MERCURY MARINE	27-49949	687			
	18-0340	OMC	508713	783	18-0422	MERCURY MARINE	391-5076 882-885
	18-03400			176	18-0424	OMC	315578 258
	18-03404			176	18-0426	OMC	305196 261
	18-0341	MERCURY MARINE	27-430086	362	18-0430	OMC	912477 786
	18-0342	MERCURY MARINE	27-476441	694	18-0431	OMC	912471 786
	18-0345	MERCURY MARINE	27-822189	364	18-0434	OMC	909758 785
	18-0346	MERCURY MARINE	27-49936	692	18-0435	OMC	908765 785
	18-0346	OMC	3930912	787	18-0437	OMC	334353 257
	18-0347	MERCURY MARINE	27-52145	692	1 18-0440	OMC	915719 787
	18-0347	OMC	912981	787	1 18-0441	OMC	329076 261
	18-0347	OMC	913277	787	1 18-0445	OMC	323312 262
	18-0347	OMC	3852693	787	1 18-0446	OMC	323311 262
	18-0347	VOLVO	3852693	856	18-04550		177
	18-0348	MERCURY MARINE	27-52550	687	18-0459	SUZUKI	17472-95200 403, 404, 408
	18-0348	OMC	508871	783	18-0460	SUZUKI	17472-95310 403, 404, 408
	18-0348	OMC	3931593	783	18-04600		177
	18-0349	MERCURY MARINE	27-54506	690	18-0461	SUZUKI	17472-96301 403, 404, 408
	18-0352	MERCURY MARINE	27-56173	692	18-0462	MERCURY MARINE	27-48399 690
	18-0352	OMC	913758	787	18-0463	MERCURY MARINE	27-814210 690
	18-0352	VOLVO	3852818	856	1 18-0464	MERCURY MARINE	27-49121 692
	18-0353	MERCURY MARINE	27-58764	669	1 18-0464	OMC	912768 787
	18-0354	MERCURY MARINE	27-60715	689	18-0465	MERCURY MARINE	27-65184 686
	18-0356	MERCURY MARINE	27-64692	661, 685, 689	18-0465	OMC	352670 783
	18-0357	MERCURY MARINE	27-65577	689	18-0466	MERCURY MARINE	27-14901A1 687
	18-0359	MERCURY MARINE	27-672751	360	18-0466	OMC	393061 783
	18-0360	MERCURY MARINE	27-70142	690	18-0466	OMC	3921473 783
	18-03600			177	18-0466	OMC	3923440 783
	18-03602			177	18-0467	MERCURY MARINE	27-41610 690
	18-03606			177	18-0468	MERCURY MARINE	27-811572 692
	18-03608			177	18-0468	OMC	912954 788
	18-0363	MERCURY MARINE	27-73398	882-885	18-0468	OMC	915326 788
	18-0365	MERCURY MARINE	27-75450	691	18-0468	OMC	3852654 788
	18-0368			834	18-0468	OMC	3853512 788
	18-0369	MERCURY MARINE	27-75909	362	18-0468	VOLVO	3852654 857
	18-0371	MERCURY MARINE	27-78409	360	18-0468	VOLVO	3853512 857
	18-0372	MERCURY MARINE	27-78410	361	18-0470		488, 489, 491
	18-0373	MERCURY MARINE	27-78411	360	18-0471		503, 507
	18-0376			844	18-0472		501, 505-507
	18-0377			844	18-0474		503, 506, 507
	18-0378	MERCURY MARINE	27-823142	362	18-0475		525, 529, 531, 534
	18-0378	MERCURY MARINE	27-823142 2	362	1 18-0476		491, 842
	18-0380	MERCURY MARINE	27-83940M	882-885	1 18-0476	BARR	01-0105 491, 842
	18-0382	HONDA	17109-XY6-00	206	1 18-0477-9	SUZUKI	17472-98503 404
	18-0384	MERCURY MARINE	27-892211	359	18-0478	SUZUKI	17472-93911 404
	18-0385	MERCURY MARINE	27-89937	362	18-0479	SUZUKI	17472-92D10 404
	18-0386	MERCURY MARINE	27-94914	630, 693	18-0480	SUZUKI	17472-98611 404
	18-0388	MERCURY MARINE	27-988231	694	18-0483	YAMAHA	63D-44316-00-00 452
	18-0389	MERCURY MARINE	27-99960	691	18-0487	MERCURY MARINE	27-8243261 688
	18-0390	HONDA	17105-ZY3-004	206	18-0488	MERCURY MARINE	27-807473A1 688
	18-0396	HONDA	17109-ZY3-004	206	18-0489	VOLVO	876384 852
	18-0397	OMC	318917	261	18-0490	OMC/Bombardier	335523 255
1	18-0398	MERCURY MARINE	27-530451	690	18-0491	OMC/Bombardier	346007 255
1	18-0398	VOLVO	835417	855	18-0492	OMC/Bombardier	340919 255
	18-0401	OMC	913393	786	18-0498	VOLVO	3580309 853
	18-0403	MERCURY MARINE	27-805722A1	684	1 18-0499	CHRYSLER INBOARD	10612 498
	18-0404	MERCURY MARINE	27-805403A1	684	18-0500	CHRYSLER FORCE	26-817472 199, 200
	18-0405	MERCURY MARINE	27-14247-1	687	18-05002		882-885
	18-0405	MERCURY MARINE	27-883964	687	18-0501	CHRYSLER FORCE	26-819394 200
	18-0405	OMC	912955	783	18-0502	CHRYSLER FORCE	26-819396 199, 200
	18-0405	OMC	3852655	783	18-0503	CHRYSLER FORCE	26-F40307-2 199, 200
	18-0405	VOLVO	3852655	856	18-0512	CHRYSLER FORCE	26-F84307-1 199, 200
	18-0406	YAMAHA	60X-43315-A0-00	445	18-0514	MERCURY MARINE	26-25329 365
	18-0407	MERCURY MARINE	27-64798	688	18-0515	MERCURY MARINE	26-30530 388, 738
	18-0407	OMC	508872	783	18-0516	MERCURY MARINE	26-30913 388, 738
	18-0410	MERCURY MARINE	27-75648	688	18-0517	MERCURY MARINE	26-32911 388, 738
	18-0410	OMC	986103	783	18-0518	MERCURY MARINE	26-34217 388, 683, 685, 686
	18-0410	OMC	986104	783	18-0518	OMC	914323 789
	18-0410	OMC	988162	783	18-0518	OMC	3853132 789
	18-0410	OMC	3853912	783	18-0518	OMC	3854956 789
	18-0410	OMC	3853913	783	18-0518	VOLVO	914323 851

1 This product is priced per piece. To order, priced per package, please add -9 to the part number
 2 Items ending in "D" are display packaged - regular number is non-display
 3 For discount shop pack of 10, please add -10 to the part number

SIERRA #	O.E.M.	O.E. #	PAGE #	SIERRA #	O.E.M.	O.E. #	PAGE #
SIERRA							
18-0518	VOLVO	3853132	851	18-0624	MERCURY MARINE	27-188891	882-885
18-0518	VOLVO	3854956	851	18-0626	OMC	334043	257
18-0519	MERCURY MARINE	26-14240	738	18-0628	OMC	341501	882-885
18-0519	OMC	3852657	782	18-0633	MERCURY MARINE	27-192061	359
18-0519	VOLVO	912957	851, 852	18-0641	MERCURY MARINE	27-828292	358, 359
18-0519	VOLVO	3852657	851, 852	18-0642	MERCURY MARINE	27-190503	361
18-0521	MERCURY MARINE	26-36557	365	18-0643	MERCURY MARINE	27-183076	362
18-0522	HONDA	91254-ZW1-003	207	18-0643	MERCURY MARINE	27-18307-1	358, 362
18-0522	MERCURY MARINE	26-43036	198, 371, 383, 388, 738	18-0644	MERCURY MARINE	27-146972	360
18-0523	MERCURY MARINE	26-43993	388, 738	18-0645	MERCURY MARINE	27-167371	360
18-0525	MERCURY MARINE	26-45587	388, 738	18-0646	MERCURY MARINE	27-813859	358, 360
18-0526	MERCURY MARINE	26-48443	388, 738	18-0647	OMC	986658	799
18-0527	MERCURY MARINE	26-56397	388, 738	18-0648			844
18-0528	MERCURY MARINE	26-56868	683	18-0649	MERCURY MARINE	27-858935	362
18-0528	OMC	913745	782	18-0650	SUZUKI	56132-95J00	407
18-0528	VOLVO	3852805	851	18-0651	SUZUKI	17472-98J00	407
18-0529	MERCURY MARINE	26-62818	388, 738	18-0652	OMC	914723	799
18-0531	MERCURY MARINE	26-72785	388, 738	18-0653	OMC	308825	799
18-0537	MERCURY MARINE	26-85107	388, 738	18-0654	OMC	914743	799
18-0539	MERCURY MARINE	37721	355, 365, 369	18-0655	OMC	914736	799
18-0540	OMC	320936	263	18-0656	YAMAHA	69J-45123-00-00	445
18-0542	OMC	321831	293, 806	18-0663			353, 443
18-0543	OMC	321895	293, 806	18-0664	MERCURY MARINE	27-17467	692
18-0544	SUZUKI	09282-24004	409	18-0664	OMC	913270	787
18-0545	SUZUKI	09289-10002	409	18-0664	OMC	3852687	787
18-0546	SUZUKI	09282-30007	409	18-0664	VOLVO	3852687	856
18-0548	OMC	909515	787	18-0665			538
18-0549	OMC	909829	789	18-0667	MERCURY MARINE	27-995061	690
18-0549	VOLVO	3852476	861	18-0670	MERCURY MARINE	27-430075	362
18-0550	OMC	909830	789	18-0672	MERCURY MARINE	27-860231	670
18-05501			882-885	18-0672	MERCURY MARINE	27-8637251	670
18-05502			882-885	18-0673	OMC	910113	786
18-05503			882-885	18-0675	OMC	321932	240, 261
18-05504			882-885	18-0676	PLEASURECRAFT	RM0099	552
18-0551	SUZUKI	09283-10011	409	18-0677	PLEASURECRAFT	RM0022	550, 552
18-0554	MERCURY MARINE	26-84813M	386, 388	18-0679	OMC	311145	262
18-0554	YAMAHA	93101-20M07-00	457, 467-469	18-0680	MERCURY MARINE	27-815528	691
18-0557	MERCURY MARINE	888909A1	375	18-0680	OMC	914578	787
18-0558	VOLVO	851407	864	18-0680	OMC	3853256	671, 691, 787
18-0559	OMC	332585	293, 806	18-0680	VOLVO	3853256	855
18-0560	MERCURY MARINE	26-896600	388	18-0681	MERCURY MARINE	12-32834	695
18-0563	MERCURY MARINE	26-36556	365, 736	18-0685	MERCURY MARINE	27-73666	689
18-0564	MERCURY MARINE	26-888483	388	18-0690	OMC/Bombardier	347205	260
18-0568-9	MERCURY MARINE	23-43045	366	18-0691	OMC/Bombardier		260
18-0569	SUZUKI	09284-08003	409	18-0692	OMC/Bombardier	339601	260
18-0570	YAMAHA	93102-23096-00	442, 469	18-0693	OMC/Bombardier	336227	260
18-0577	MERCURY MARINE	66081A2	699, 701, 715	18-0694	OMC/Bombardier	336226	260
18-0578	MERCURY MARINE	26-67388	683, 738	18-0695	OMC/Bombardier	336389	260
18-0579	CHRYSLER FORCE	26-41131	388	18-0696	OMC/Bombardier	336388	260
18-0579	MERCURY MARINE	26-41131	388	18-0710	YAMAHA	68V14984-00	418
18-0580	CHRYSLER FORCE	26-41132	388	18-0711	YAMAHA	66K-14984-00	418
18-0580	MERCURY MARINE	26-41132	388	18-0712	YAMAHA	63P-14984-00	418
18-0581	MERCURY MARINE	26-41365	386, 388	18-0713	YAMAHA	6P2-14984-00	418
18-0583	HONDA	91251-ZW1-003	207	18-0714	YAMAHA	6AW-14984-00	418
18-0583	CHRYSLER FORCE	26-43035	388	18-0715	YAMAHA	65L-14984-00	418
18-0583	MERCURY MARINE	26-43035	388	18-0737	HONDA	16176-POA-004	206
18-0584	CHRYSLER FORCE	26-F346118	199, 200	18-0739	YAMAHA	689-45113-A1-00	442, 452
18-0584	CHRYSLER FORCE	26-66022	199, 200	18-0740	MERCURY MARINE	27-805396	882-885
18-0584	MERCURY MARINE	26-66022	199, 200	18-07400			177
18-0585	MERCURY MARINE	26-821928	386, 388	18-0743	YAMAHA	6L2-41112-A1-00	442, 452
18-0586	CHRYSLER FORCE	26-99325	198-200, 383, 386, 388	18-0744	YAMAHA	6L2-41114-A1-00	442, 452
18-0586	MERCURY MARINE	26-99325	198-200, 383, 386, 388	18-0753	YAMAHA	6G1-44315-A0-00	452
18-0587	YAMAHA	93101-25M03-00	461, 469	18-0754	YAMAHA	68D-E2414-A0-00	452
18-0588	YAMAHA	93102-25M28-00	882-885	18-0755	YAMAHA	90430-14228-00	445
18-0590			844	18-0755	YAMAHA	904-30142-28-00	445
18-0592	CHRYSLER FORCE	26-F318307	199, 200	18-0755	YAMAHA	90430-14M09-00	445
18-0593	CHRYSLER FORCE	26-F901307-2	199, 200	18-0756-1	YAMAHA	6H3-44315-A0-00	433, 453, 468
18-0595	MERCURY MARINE	26-66303	383, 388	18-0757	YAMAHA	6H3-44324-A0-00	433, 453, 468
18-0601			523, 533	18-0761	SUZUKI	17472-91J00	404
18-0602			527, 533	18-0765	YAMAHA	6L2-14384-00-00	442, 451
18-0603			778	18-0767	YAMAHA	688-11193-01-00	441, 442, 452
18-0604			778	18-0768	YAMAHA	682-44315-A0-00	453
18-0605	YAMAHA	67F-41138-00-00	445	18-0769	YAMAHA	648-14384-01-00	882-885
18-0606			844	18-0775	YAMAHA	648-14198-A0-00	442, 451
18-0607	CHRYSLER INBOARD	3745217	507	18-0778	SUZUKI	17472-93J00	404
18-0608	CHRYSLER INBOARD	3745209	882-885	18-0779	YAMAHA	6G5-11193-A0-00	452
18-0609	CHRYSLER INBOARD	4273129	498	18-0781	YAMAHA	6E5-11193-A0-00	452
18-0611	MERCURY MARINE	27-75483	688	18-0782	YAMAHA	6E5-11381-A1-00	452
18-0612	MERCURY MARINE	809910	675	18-0785	YAMAHA	6E5-14198-A1-00	451
18-0613	MERCURY MARINE	93476	675	18-0786	YAMAHA	6E5-14384-02-00	451
18-0614	MERCURY MARINE	845668T	675	18-0791	MERCURY MARINE	27-880729	362
18-0615	MERCURY MARINE	93477T	675	18-0792	SUZUKI	13119-91J00	404
18-0616	MERCURY MARINE	14244T	675	18-0793	SUZUKI	17582-93J00	404
18-0617	YAMAHA	67F-45127-00-00	445	18-0794	SUZUKI	17685-97J00	404
18-0618	YAMAHA	68V-45123-00-00	445	18-0795	SUZUKI	17685-98J00	404
18-0619	YAMAHA	69J-41138-00-00	445	18-0796	SUZUKI	17685-99E00	404
18-0622	CHRYSLER FORCE	27-19701	365	18-0797	SUZUKI	17685-87D10	404
18-0622	MERCURY MARINE	27-19701	365	18-0798	YAMAHA	6H4-41114-A0-00	452
				18-0799	YAMAHA	6E5-41112-A1-00	452
				18-0807-1	YAMAHA	6K7-13645-A1-00	451
				18-0808	YAMAHA	6G5-11382-A1-00	452

1 This product is priced per piece. To order, priced per package, please add -9 to the part number

2 Items ending in "D" are display packaged - regular number is non-display

3 For discount shop pack of 10, please add -10 to the part number

SIERRA #	O.E.M.	O.E. #	PAGE #	SIERRA #	O.E.M.	O.E. #	PAGE #
SIERRA							
18-0809	YAMAHA	6G5-13645-A1-00	451	18-0894	MERCURY MARINE	27-558101	693
18-0812	YAMAHA	6G5-41112-A1-00	452	18-0897	MERCURY MARINE	27-41813	670
18-0813	YAMAHA	6G5-45113-A0-00	452	18-0898	PLEASURECRAFT	RM0017	552
18-0815	YAMAHA	6H4-11193-A1-00	452	18-0898	MERCURY MARINE	27-56859	882-885
18-0823	YAMAHA	6E5-13645-A1-00	452	18-09002			177
18-0826	YAMAHA	90430-14115-00-00	442, 453	18-09006			177
18-0829	YAMAHA	61A-12414-A0-00	436, 452	18-0903	YAMAHA	YSG-38600-39-G0	866
18-0829	YAMAHA	6J8-12414-A0-00	436, 452	18-0903	MERCURY MARINE	27-49110	688, 693
18-0835	MERCURY MARINE	27-824853	363	18-0903	OMC	3853361	787
18-0835	YAMAHA	62Y-12414-00-00	452	18-0903	VOLVO	3853361	856
18-0836	YAMAHA	682-12414-A1-00	452	18-0904	MERCURY MARINE	27-60317	357, 362
18-0840-1	YAMAHA	676-14984-00-00	441, 442, 451	18-0905	YAMAHA	YSG-14090-90-8G	467, 468, 866
18-0844	YAMAHA	688-12414-A1-00	436, 441, 442, 452	18-0905	MERCURY MARINE	27-49955	685, 694, 844
18-0846	YAMAHA	688-14198-A1-00	Obsolete	18-0911	OMC	911698	787, 791
18-0847	YAMAHA	688-41112-A0-00	441, 442, 452	18-0912	MERCURY MARINE	27-661021	362
18-0849	YAMAHA	650-24431-A0-00	445	18-0913	OMC	909902	264, 804
18-0850	OMC	303615	250-252, 257	18-0914	MERCURY MARINE	27-66847	357, 363
18-0851	OMC	329826	250, 262	18-0915	CHRYSLER FORCE	27-F406406	195, 197
18-0854	YAMAHA	64D-14384-01-00	445	18-0916	MERCURY MARINE	27-8052151	693
18-0854	CHRYSLER FORCE	27-F476067	195, 196, 198	18-0917	OMC	311508	264, 804
18-0855	CHRYSLER FORCE	27-F85168-2	197	18-0918	MERCURY MARINE	27-695242	360
18-0857	CHRYSLER FORCE	27-F85472-2	Obsolete	18-09200			882-885
18-0858	MERCURY MARINE	25-54029	353, 354, 358, 391, 739	18-09202			175
18-0860	MERCURY MARINE	25-62700	739	18-0922	MERCURY MARINE	27-703351	361
18-0861	CHRYSLER FORCE	27-F85748-2	195-197	18-0923	OMC	313244	789
18-0863	CHRYSLER FORCE	27-F93472-1	882-885	18-0926	MERCURY MARINE	27-73645	356, 361
18-0864	MERCURY MARINE	26-90925	683, 687	18-0927	OMC	393561	251, 259
18-0866	MERCURY MARINE	27-12775-2	360	18-0928	MERCURY MARINE	27-73814	685, 687, 691
18-0868	OMC	985630	783	18-0929	OMC	313416	261
18-0868	CHRIS-CRAFT	16.50-00232	491, 571-574, 685, 686, 688, 783, 853	18-0932	MERCURY MARINE	27-768621	239, 249, 261, 770, 785, 845, 846, 855, 361
18-0868	MERCURY MARINE	27-17145	685, 686, 688	18-0933	OMC	314115	249, 258
18-0868	OMC	3854269	783	18-0934-1	MERCURY MARINE	27-78069	363
18-0868	VOLVO	3854269	853	18-0935	OMC	314322	249, 258
18-0869	CHRYSLER FORCE	27-F40223	195-197	18-0936	MERCURY MARINE	27-78690	354, 355, 358, 363
18-0870	MERCURY MARINE	27-279361	361	18-0937	OMC	315055	785
18-0871	OMC	175158	222	18-0939	OMC	315189	788
18-0872	MERCURY MARINE	27-33395	670	18-0940	MERCURY MARINE	27-854882	361
18-0873	CHRYSLER FORCE	27-F97067	196, 198	18-09400			176
18-0874	MERCURY MARINE	27-344863	690	18-0941	OMC	315538	250, 252, 261
18-0874	OMC	312780	785	18-0942	MERCURY MARINE	27-854913	361
18-0874	YAMAHA	YSG-10108-44-5G	866	18-0942	MERCURY MARINE	27-85491-2	356, 361
18-0874	CHRIS-CRAFT	16.50-00162	491, 570-575, 687, 690, 785, 858, 866	18-0943-1	OMC	909786	777
18-0874	OMC	3852109	785	18-0943-1	OMC	3850496	777
18-0874	VOLVO	3852109	858	18-0944	MERCURY MARINE	27-854961	361
18-0875			521, 535, 549, 552	18-0945	OMC	336430	251, 259
18-0876	OMC	312800	785	18-0946	MERCURY MARINE	27-856730	361
18-0876	YAMAHA	YSG-10108-43-8G	866	18-0946	MERCURY MARINE	27-85653-1	357, 361
18-0876	CHRIS-CRAFT	16.50-05756	491, 571-574, 685, 689, 785, 855, 866	18-0947	OMC	909529	787
18-0876	MERCURY MARINE	27-34898	685, 689	18-0948	MERCURY MARINE	27-87707	688, 690
18-0876	OMC	3852113	785	18-0949	OMC	316499	263
18-0876	VOLVO	3852113	855	18-0949	MERCURY MARINE	316499	263
18-0878	PLEASURECRAFT	RM0003	552	18-0950	MERCURY MARINE	27-88046	687, 694
18-0879	MERCURY MARINE	27-385011	362	18-0951	OMC	317305	249, 250, 258
18-0880	OMC	911878	788	18-0952	MERCURY MARINE	27-88907	354, 355, 363
18-0881	MERCURY MARINE	27-18272	670	18-0953	OMC	317951	249, 250, 262
18-0882	OMC	304764	262	18-0954	MERCURY MARINE	27-92720	687, 691
18-0885	MERCURY MARINE	27-48042	670	18-0955	OMC	318156	249, 259
18-0887	OMC	912988	788	18-0956	CHRYSLER INBOARD	118-614	507
18-0887	OMC	913275	788	18-0956	OMC	912405	786
18-0887	YAMAHA	YSG-14096-15-6G	866	18-0956	MERCURY MARINE	27-68715	687, 692
18-0887	MERCURY MARINE	27-49953	688, 692	18-0957	OMC	318373	249, 260
18-0887	OMC	3852691	788	18-0958	CHRYSLER FORCE	27-F372154-1	197
18-0887	VOLVO	3852691	857	18-0959	OMC	318924	251, 258
18-0889	PLEASURECRAFT	3705042	552	18-0960	CHRYSLER FORCE	27-F85906	195-197
18-0889	VOLVO	3852095	855	18-09602			177
18-0889	YAMAHA	YSG-10114-14-1G	866	18-09606			177
18-0889	CHRIS-CRAFT	16.50-00074	491, 552, 570-576, 685, 687-689, 855, 866	18-0961	OMC	318932	251, 257
18-0889	MERCURY MARINE	27-34213	685, 687-689	18-0962	CHRYSLER FORCE	27-F40154-4	196, 197
18-0891	OMC	909835	788	18-0963	OMC	335633	250, 252, 259
18-0891	YAMAHA	YSG-37545-87-G0	866	18-0965	OMC	333879	253, 260
18-0891	CHRIS-CRAFT	16.50-00078	491, 571-574, 685, 693, 788, 856, 866	18-0967	OMC	319332	251, 261
18-0891	MERCURY MARINE	27-34897	685, 693	18-0969	OMC	319586	234, 262, 290
18-0891	OMC	3852477	788	18-0970	MERCURY MARINE	27-987691	360
18-0891	VOLVO	3852477	856	18-0971	OMC	319661	251, 261
18-0892	OMC	322411	261	18-0973	OMC	315052	259
18-0893	MERCURY MARINE	27-35380	685, 693	18-0975	OMC	333008	250, 252, 258
18-0893	OMC	3850595	788	18-0976	CRUSADER	20129	535
18-0893	VOLVO	3850595	857	18-0976	MERCURY MARINE	27-14250	685, 692
18-0894	MERCURY MARINE	27-55810	693	18-0977	OMC	332369	261
				18-0978	OMC	331598	251, 253, 258
				18-0979	OMC	321183	250, 251, 258
				18-0980	OMC	3935449	788
				18-0980	MERCURY MARINE	27-54529	688, 692
				18-0981	OMC	321479	251, 259
				18-0983	OMC	321497	250, 252, 258
				18-0985	OMC	321722	250, 258
				18-0987	OMC	332319	252, 253, 259
				18-0988	MERCURY MARINE	27-628601	363
				18-0989	OMC	321794	250, 252, 258

1 This product is priced per piece. To order, priced per package, please add -9 to the part number
 2 Items ending in "D" are display packaged - regular number is non-display
 3 For discount shop pack of 10, please add -10 to the part number

SIERRA #	O.E.M.	O.E. #	PAGE #	SIERRA #	O.E.M.	O.E. #	PAGE #	
SIERRA								
1	18-0991	OMC	321907	249-251, 259	18-1189	MERCURY MARINE	31-815480	882-885
	18-0993	OMC	437228	222	18-1190	MERCURY MARINE	30-20839T	374
1	18-0994	MERCURY MARINE	27-70143-1	685, 687, 690	18-1191	MERCURY MARINE	12-12577	371, 374
	18-0995	OMC	323222	250, 251, 260	18-1192	MERCURY MARINE	31-88903T	882-885
	18-0999-9	OMC	323459	259	18-1193	MERCURY MARINE	31-33138A1	725
	18-1074	OMC	3850426	793, 794	18-1194	MERCURY MARINE	31-17514A1	350
	18-1074	VOLVO	3850426	793, 794	18-1194	MERCURY MARINE	31-M8004528	350-352
	18-1076	Volvo	3888916	863	18-1195	MERCURY MARINE	31-43012A1	350
	18-1079	YAMAHA	6A1-44325-00-00	453	18-1196	MERCURY MARINE	31-74248T	350
	18-1095	MERCURY MARINE	31-21700	369	18-1197	MERCURY MARINE	31-828439A2	374, 725
	18-1096	MERCURY MARINE	31-21739	Obsolete	18-1198	MERCURY MARINE	31-812768	Obsolete
	18-1097	MERCURY MARINE	31-41326	Obsolete	1	18-1199		57
	18-1099	OMC	982422	799	1	18-1202	OMC	329830
	18-1100			57	1	18-1204	MERCURY MARINE	27-96429
	18-1105			57	1	18-1204	OMC	912164
	18-1106			57	1	18-1205	OMC	329828
	18-1107			57, 375, 376		18-1207	OMC	329833
	18-1109			57	1	18-1210	MERCURY MARINE	27-39923
	18-1110			57		18-1211	MERCURY MARINE	26-58203
	18-1111	MERCURY MARINE	31-62799A1	882-885		18-1211	OMC	473424
	18-1112	MERCURY MARINE	31-12576	371, 374				570, 571, 573, 576, 577, 683, 782, 851, 852
	18-1113	MERCURY MARINE	31-12578T	374		18-1212	OMC	326926
	18-1113	MERCURY MARINE	31-12578	371, 374		18-1213	MERCURY MARINE	26-59341
	18-1115	MERCURY MARINE	31-32898	374		18-1213	MERCURY MARINE	26-79223
	18-1115	MERCURY MARINE	31-32898T	374		18-1213	MERCURY MARINE	26-97335
	18-1117	OMC	387817	279		18-1213	OMC	912989
	18-1117	MERCURY MARINE	31-42647A1	374		18-1213	OMC	914817
	18-1118	MERCURY MARINE	31-42677A1	371, 374		18-1213	OMC	3853341
	18-1120	MERCURY MARINE	31-35246	882-885		18-1213	VOLVO	3853341
	18-1121	MERCURY MARINE	31-69220	374		18-1218	OMC	315868
	18-1121	MERCURY MARINE	31-69220T	374		18-1219	OMC	320880
	18-1122	MERCURY MARINE	31-73363T	374				238, 240, 241, 252, 253, 263
	18-1122	MERCURY MARINE	31-73363	373, 374		18-1221	OMC	330273
	18-1126	MERCURY MARINE	31-54036A1	882-885	1	18-1222	OMC	394408
	18-1127	MERCURY MARINE	31-54038A1	725		18-1224	OMC	315869
	18-1129	MERCURY MARINE	31-86748A1	725		18-1228	OMC	311364
	18-1131	MERCURY MARINE	74313A4	682		18-1229	OMC	304784
	18-1137	MERCURY MARINE	15103A3	882-885		18-1230	OMC	3853827
	18-1142	MERCURY MARINE	31-32573A1	724		18-1230	VOLVO	3853827
	18-1143	MERCURY MARINE	31-36387A1	374		18-1230	MERCURY MARINE	26-56866
	18-1144	MERCURY MARINE	31-48939A2	374		18-1231	MERCURY MARINE	27-818188-1
	18-1147	MERCURY MARINE	74313A1	Obsolete		18-1231	OMC	3854095
	18-1148	MERCURY MARINE	68704A1	679		18-1231	VOLVO	3854095
	18-1150	MERCURY MARINE	31-92366A1	725		18-1232	MERCURY MARINE	27-811566
	18-1151	MERCURY MARINE	30-20066	304		18-1232	OMC	3853510
	18-1152	MERCURY MARINE	30-23679	304		18-1232	VOLVO	3853510
	18-1153	MERCURY MARINE	30-63326	350, 374, 725		18-1233	MERCURY MARINE	26-8219471
	18-1153	MERCURY MARINE	30-63326T	374, 725		18-1233	OMC	3860095
	18-1154	MERCURY MARINE	30-63742T	374		18-1234	MERCURY MARINE	26-811554
	18-1154	OMC	377139	279		18-1234	OMC	3853528
	18-1154	MERCURY MARINE	30-63742	350, 374		18-1234	VOLVO	3853528
	18-1155	MERCURY MARINE	30-88957T	374		18-1235		851, 852, 882-885
	18-1155	MERCURY MARINE	30-88957A1	374, 726		18-1236	OMC	309243
	18-1156	HONDA	91051-ZW1-003	206		18-1237	MERCURY MARINE	27-138651
	18-1156	MERCURY MARINE	31-30894A1	374, 725		18-1237	OMC	3856138
	18-1157	HONDA	91057-ZW1-003	206		18-1237	VOLVO	3856138
	18-1157	MERCURY MARINE	31-30895	371, 374		18-1238	MERCURY MARINE	24-824326
	18-1157	MERCURY MARINE	31-30895T	374, 725		18-1238	OMC	3850379
	18-1158	HONDA	91053-ZW1-003	206		18-1238	VOLVO	3850379
	18-1158	MERCURY MARINE	31-30956T	374		18-1238	OMC	912979
	18-1158	OMC	387247	280		18-1238	VOLVO	912979
	18-1158	MERCURY MARINE	31-30956	374		18-1239	MERCURY MARINE	27-810846T
	18-1159	MERCURY MARINE	31-35928T1	374		18-1239	OMC	914820
	18-1159	MERCURY MARINE	31-35928A1	374		18-1239	VOLVO	3853343
	18-1160	MERCURY MARINE	31-35988A12	726		18-1240	MERCURY MARINE	12708
	18-1160	MERCURY MARINE	31-35988A2	699, 701, 711, 712, 726		18-1241		257
	18-1161	OMC	983891	280		18-1243	OMC	317245
	18-1161	MERCURY MARINE	31-35990A1	711		18-1254	Mercury Marine	27-75611A03
	18-1162	MERCURY MARINE	31-38356A1	374		18-1255		570, 577
	18-1163	MERCURY MARINE	31-48941A1	882-885		18-1256		574, 575, 577
	18-1164	MERCURY MARINE	31-53079A1	373, 375, 705, 725		18-1257		574, 577
	18-1165	MERCURY MARINE	31-61100A1	699, 701, 711, 712, 725		18-1258		575, 577
	18-1166	MERCURY MARINE	31-78172A1	373, 375		18-1259		574, 575, 577
	18-1170	MERCURY MARINE	31-812767A1	375		18-1261		575, 577
	18-1170	OMC	983892	791, 795		18-1263		572, 574, 577
	18-1171	OMC	983878	791, 795		18-1264		570, 577
	18-1172	OMC	983877	791, 795		18-1265		571, 573, 577
	18-1173	MERCURY MARINE	31-828437A2	725		18-1266		571-573, 577
	18-1175			57		18-1267		572-574, 577
	18-1176			57		18-1268		572, 573, 577
	18-1177			57		18-1269		576, 577
	18-1178			57		18-1270		571, 577
	18-1179	MERCURY MARINE	31-32575A1	725		18-1271		570, 576
	18-1179	MERCURY MARINE	31-32575T1	725		18-1273		576, 577
	18-1180	MERCURY MARINE	31-54042T	882-885		18-1274		570, 576
	18-1182	MERCURY MARINE	31-30894A5	725		18-1275		571, 577
	18-1183	MERCURY MARINE	31-87156	882-885		18-1276		570, 576
	18-1186	MERCURY MARINE	29-88258	350		18-1277		570, 576
	18-1186	MERCURY MARINE	12-88263	350		18-1278		571, 577
	18-1186	MERCURY MARINE				18-1279	OMC	317624
								882-885

1 This product is priced per piece. To order, priced per package, please add -9 to the part number

2 Items ending in "D" are display packaged - regular number is non-display

3 For discount shop pack of 10, please add -10 to the part number

SIERRA #	O.E.M.	O.E. #	PAGE #	SIERRA #	O.E.M.	O.E. #	PAGE #
SIERRA							
18-1280	OMC	317763	264, 792	18-1400	VOLVO	3856127	676, 781, 850
18-1281	OMC	351271	882-885	18-1401	MERCURY MARINE	56153	676
18-1282	OMC	398602	32, 215	18-1401	OMC	985316	676, 781
18-1283	OMC	335818	882-885	18-1401	OMC	3853847	676, 781
18-1284	OMC	335819	882-885	18-1401	VOLVO	985316	676, 781, 850
18-1285	OMC	335403	260	18-1401	VOLVO	3853847	676, 781, 850
18-1286	OMC	336232	248	18-1402	MERCURY MARINE	72638	676
18-1287	OMC	392475	267, 284, 286	18-1402	OMC	502036	676, 781
18-1288	OMC	328313	267, 284, 286, 287	18-1402	OMC	3854033	676, 781
18-1289	OMC	327655	882-885	18-1402	VOLVO	502036	676, 781, 850
18-1290	OMC	337020	267, 284-286	18-1402	VOLVO	3854033	676, 781, 850
18-1291			284, 286, 287	18-1410	YAMAHA	93310-32337-00	439
18-1292			284, 287	18-1411	YAMAHA	93310-620V5-00	439
18-1293			284, 286	18-1412	SUZUKI	09263-20051	405
18-1296	OMC	386014	245	18-1414	SUZUKI	09263-14022	405
18-1296	OMC	3855270	245	18-1415	SUZUKI	09263-18016	405
18-1299	OMC	433503	280	18-1416	SUZUKI	09263-27005	405
18-1300			679-682, 782, 851	18-1417	SUZUKI	09263-20072	405
18-1300	MERCURY MARINE	23-818465	679	18-1476			847
18-1308			679	18-1477			847
18-1308	MERCURY MARINE	23-85701	679	18-1478	VOLVO	1218674	847
18-1309			679	18-1479	VOLVO	461511	847
18-1309	MERCURY MARINE	23-85704	679	18-1500	OMC	337778	285, 799
18-1311			679, 680, 782, 851	18-1501	VOLVO	3852023	861
18-1311	MERCURY MARINE	23-801793	679	18-1501	OMC	160084	275, 796, 861
18-1314	MERCURY MARINE	23-818477	882-885	18-1505	OMC	318940	264
18-1315			679	18-1506	OMC	394411	239
18-1315	MERCURY MARINE	23-818473	679	18-1507	OMC	335981	239
18-1316			679, 680, 782, 851	18-1508	MERCURY MARINE	25-8071341	363
18-1316	MERCURY MARINE	23-818471	679	18-15100	MERCURY MARINE	57-863876 3	649
18-1317			679, 680, 782, 851	18-15101	MERCURY MARINE	57-863876 4	649
18-1317	MERCURY MARINE	23-818469	679	18-15102	MERCURY MARINE	57-863876 6	649
18-1320	MERCURY MARINE	23-801803	882-885	18-15103	MERCURY MARINE	57-865615007	649
18-1327			679, 680, 782, 851	18-15103	MERCURY MARINE	57-863876 7	649
18-1327	MERCURY MARINE	23-11992	679	18-15104	MERCURY MARINE	57-863876 8	649
18-1329	MERCURY MARINE	23-85677	679	18-15105	MERCURY MARINE	57-865615009	649
18-1333			679	18-15105	MERCURY MARINE	57-863876 9	649
18-1333	MERCURY MARINE	23-85691	679	18-15106	YAMAHA	YSC-13260-60-0C	866
18-1334			679	18-15107	YAMAHA	YSC-13260-70-0C	866
18-1334	MERCURY MARINE	23-85726	679	18-15108	YAMAHA	YSC-22260-10-0C	866
18-1337			679, 680, 782, 851	18-15109	YAMAHA	YSC-22260-00-0C	866
18-1337	MERCURY MARINE	23-811858	679	18-15110	YAMAHA	YSC-10260-10-0C	866
18-1339			679, 680, 782, 851	18-15111	YAMAHA	YSC-10260-00-0C	866
18-1339	MERCURY MARINE	23-43293	679	18-15112	MERCURY MARINE	57-8077554	649
18-1340	MERCURY MARINE	23-67484	882-885	18-15113	MERCURY MARINE	57-8077555	882-885
18-1341			679	18-15114	MERCURY MARINE	57-861049	649
18-1341	MERCURY MARINE	23-85705	679	18-15115	MERCURY MARINE	57-861757	649
18-1342	MERCURY MARINE	10-93886	Obsolete	18-15116	MERCURY MARINE	57-861758	649
18-1343	OMC	333957	269, 285, 799	18-15117	MERCURY MARINE	57-861759	882-885
18-1344			280, 285	18-15119	MERCURY MARINE	57-863876 1	649
18-1345	MERCURY MARINE	30-67923T	350	18-15120	MERCURY MARINE	57-863876 2	882-885
18-1346	MERCURY MARINE	30-43011T	350	18-15121	MERCURY MARINE	57-865615005	649
18-1347	MERCURY MARINE	31-88269T	882-885	18-15122	MERCURY MARINE	57-865615010	649
18-1350	OMC	379504	280	18-15123	MERCURY MARINE	57-864639	649
18-1351	OMC	382407	280	18-15124	MERCURY MARINE	57-881754	882-885
18-1353	OMC	387041	244	18-15125	MERCURY MARINE	57-817113	649
18-1354	OMC	386764	269, 280, 281	18-15128	MERCURY MARINE	57-880566014	317
18-1355	OMC	386765	269, 280, 281	18-15129	MERCURY MARINE	17-828507 1	317
18-1356	MERCURY MARINE	31-54928	724	18-15290	MERCURY MARINE	57-13457	645
18-1356	OMC	382343	280	18-15290	MERCURY MARINE	57-13457T	645
18-1357	OMC	384195	795	18-15290			645
18-1358	OMC	389039	795	18-15300	MERCURY MARINE	57-49756	645
18-1360	OMC	396041	244	18-15300			645
18-1361	OMC	387787	245	18-15325	MERCURY MARINE	57-77274A1	645
18-1362	OMC	310433	Obsolete	18-15325	VOLVO	958303	837
18-1362			Obsolete	18-15325			645
18-1363	OMC	397537	269, 280, 281	18-15330	VOLVO	960324	Obsolete
18-1364	OMC	397538	269, 280, 281	18-15345	MERCURY MARINE	57-74271T	645
18-1365	OMC	387656	795	18-15345			645
18-1366	OMC	382408	795	18-15370	MERCURY MARINE	57-65607T	645
18-1367	OMC	385068	280	18-15370			645, 646, 771, 837
18-1368	OMC	398901	269, 280, 281	18-15370	OMC	910414	771
18-1369	OMC	432264	269, 280, 281	18-15380			645, 771, 837
18-1370	OMC	389042	280	18-15390	MERCURY MARINE	57-52692	645
18-1371	OMC	385043	280	18-15390	VOLVO	958310	837
18-1374	OMC	395627	245	18-15390			645, 771, 837
18-1376	OMC	434844	245	18-15400	MERCURY MARINE	57-32850	645
18-1377	OMC	320499	245	18-15400	MERCURY MARINE	57-69143T	645
18-1378	OMC	388344	245	18-15400	OMC	311606	771
18-1386			245	18-15400			645
18-1389			243, 245, 246, 248	18-15405	MERCURY MARINE	57-76269	645
18-1391	OMC	330854	245	18-15405	VOLVO	958311	837
18-1393	OMC	393896	245	18-15405			645
18-1394	OMC	389613	Obsolete	18-15410	MERCURY MARINE	57-49043A1	645
18-1395	OMC	385503	245	18-15410	MERCURY MARINE	57-64032A1	645
18-1396	OMC	390641	245	18-15410	MERCURY MARINE	57-98043	645
18-1397	MERCURY MARINE	30-41341	882-885	18-15410	VOLVO	950813	837
18-1398	MERCURY MARINE	30-72961	350	18-15410			645, 646, 771, 837
18-1399	CHRYSLER FORCE	30-F286028	882-885	18-15415	MERCURY MARINE	57-36356	645
18-1400	MERCURY MARINE	17340	676	18-15415	OMC	910343	771
18-1400	OMC	3856127	676, 781	18-15415	VOLVO	958357	837

1 This product is priced per piece. To order, priced per package, please add -9 to the part number
 2 Items ending in "D" are display packaged - regular number is non-display
 3 For discount shop pack of 10, please add -10 to the part number

SIERRA #	O.E.M.	O.E. #	PAGE #	SIERRA #	O.E.M.	O.E. #	PAGE #
SIERRA							
18-15430	MERCURY MARINE	57-49211	645	18-1730	MERCURY MARINE	43585	337
18-15430	VOLVO	841821	837	18-1732	OMC	338504	282, 796
18-15430			645, 771, 837	18-1734	OMC	334742	239
18-15435	MERCURY MARINE	57-64416	645	18-1736	MERCURY MARINE	45-43031A1	371, 378
18-15435	OMC	912509	771	18-1737	MERCURY MARINE	45-440001	378
18-15435	VOLVO	958314	837	18-1750			882-885
18-15435	VOLVO	958359	837	18-1752	OMC	394462	244
18-15435	VOLVO	966382	837	18-1753	OMC	395861	244
18-15435	VOLVO	958359-2	837	18-1755	YAMAHA	650-11651-04-00	439
18-15440	MERCURY MARINE	57-45856	645	18-1755K	YAMAHA	650-11651-04-00	439
18-15440	MERCURY MARINE	57-49213A1	645	18-1756	YAMAHA	688-11650-03-00	439
18-15440	OMC	311046	771	18-1757	SUZUKI	12161-93902	405
18-15440			645	18-17570			882-885
18-15450	OMC	914787	771	18-1757K	SUZUKI	12161-93902	405
18-15450	VOLVO	960336	837	18-1758	SUZUKI	12161-96300	405
18-15450	VOLVO	3858462	837	18-1759	SUZUKI	12161-94400	405
18-15450			645, 771, 837	18-1759K	SUZUKI	12161-94400	405
18-15455	OMC	908929	771	18-18000	MERCURY MARINE	57-892318	317
18-15455	VOLVO	3852464	837	18-18100	MERCURY MARINE	57-828507Q4	317
18-15455			645, 771, 837	18-1830	Yamaha	663-44366-00	428
18-15460	MERCURY MARINE	57-48120A1	645	18-1831	Yamaha	682-44366-00	428
18-15460	OMC	310953	771	18-1832	Yamaha	682-44367-00	428
18-15460	OMC	909971	771	18-1833	Yamaha	647-44366-00	429
18-15460	VOLVO	829207	837	18-1834	Yamaha	682-44365-00	429
18-15460	VOLVO	950818	837	18-1848	VOLVO	3857656	840
18-15470	MERCURY MARINE	57-78200A1	645	18-1876	OMC	980617	776
18-15470			645, 647, 648, 771, 837	18-1898	MARINE POWER	0991-110	489, 506, 530, 557, 562, 664, 775, 840
18-15480	MERCURY MARINE	57-48122	645	18-1898	BARR	CHVA-1-84	489, 506, 530, 557, 562, 664, 775, 840
18-15480			645				550, 551
18-15490	MERCURY MARINE	57-816295T	645	18-1899	PLEASURECRAFT	RO29001	775
18-15495	MERCURY MARINE	57-91035A1	645	18-1901	OMC	984054	775
18-15495	VOLVO	958320	837	18-1902	OMC	912441	775
18-15495			645	18-1903	OMC	912442	775
18-1550	MERCURY MARINE	43-881260A3	378	18-1904	OMC	980959	775
18-15500	MERCURY MARINE	57-96834T	645	18-1905	MERCURY MARINE	90880	666
18-15500	OMC	909818	771	18-1906	MERCURY MARINE	61851	667
18-15500	OMC	912418	771	18-1907	BARR	20-0100	489, 506, 532, 539, 557, 559, 561, 562, 667, 776, 841
18-15500	VOLVO	952141	837				489, 506, 532, 559, 561, 562, 667, 776, 841
18-15500	MERCURY MARINE	57-96834Q	645				489, 506, 532, 667, 776, 841
18-1551	MERCURY MARINE	43-803615T2	378	18-1907	INDMAR	53-2009	489, 506, 532, 559, 561, 562, 667, 776, 841
18-15520	MERCURY MARINE	57-33170	645	18-1907	INDMAR	53-2018	489, 506, 532, 559, 561, 562, 667, 776, 841
18-15520	MERCURY MARINE	57-37619T	645	18-1907	BARR	20-0102	489, 506, 532, 667, 776, 841
18-15520	OMC	912714	771				776, 841
18-15520	MERCURY MARINE	57-33170Q	645				667
18-15520			645				667
18-15525			882-885				667
18-15550	MERCURY MARINE	57-13458T	645	18-1908	MERCURY MARINE	93322	667
18-15550			645, 647, 648, 771, 837	18-1908K	MERCURY MARINE	807476A6	667
18-1560	MERCURY MARINE	43-850036T	378	18-1908K	MERCURY MARINE	93320A5	667
18-1562	MERCURY MARINE	52-850048T	378	18-1909-1	VOLVO	3857944-7	776
18-1564	MERCURY MARINE	43-803615T2	378	18-1909-1	OMC	3857944	776
18-1565	MERCURY MARINE	52-859340T	378, 379	18-1909-1	OMC	913784	776
18-1566	MERCURY MARINE	43-828175A1	378, 379	18-1909-1	OMC	3855270	776
18-1567	MERCURY MARINE	43567T1	373, 375	18-1909-1	VOLVO	3863061	841
18-1598	OMC	341013	791, 792	18-1909-1	VOLVO	3855270-9	841
18-1599	OMC	123018	791, 792	18-1909-1	OMC	3850456	776
18-1600	OMC	983825	791, 797	18-1910	MERCURY MARINE	861493A07	635
18-1601	OMC	983826	791, 797	18-1911			503, 506-508
18-1602	OMC	984012	791, 797	18-1913	CHRYSLER INBOARD	2469639	501, 507, 508
18-1650	Universal		135	18-1913	CHRYSLER INBOARD	2847405	501, 507, 508
18-1651	Universal		135	18-1914	CHRIS-CRAFT	7056	488-491
18-1652	Universal		135	18-1914	CHRIS-CRAFT	7686	488-491
18-1653	Universal		135	18-1915	CHRYSLER INBOARD	3619659	503, 506-508
18-1655	Universal		135	18-1915	CHRYSLER INBOARD	E7081M	503, 506
18-1656	Universal		135	18-1916	CRUSADER	97169	523, 527, 531, 532
18-1701	OMC	911693	796	18-1917	CRUSADER	97296	523, 527, 534
18-1702	OMC	438039	798	18-1918	CRUSADER	97386	523, 527, 531, 532
18-1702	OMC	5000074	798	18-1919	CRUSADER	97387	523, 527, 531
18-1703	OMC	434400	798	18-1921	OMC	909863	776
18-1703	OMC	435096	798	18-1922	OMC	987784	776
18-1703	OMC	438040	798	18-1924	CRUSADER	97624	523, 527, 531
18-1703	OMC	5000363	798	18-1925	CRUSADER	96120	527, 530-532
18-1703	OMC	5004257	798	18-1925	CRUSADER	97752	527, 530-532
18-1704	OMC	331980	882-885	18-1926	CRUSADER	96121	527, 530-532
18-1705	MERCURY MARINE	77123	714	18-1926	CRUSADER	97753	527, 530-532
18-1706	MERCURY MARINE	10-86801	714	18-1927	CRUSADER	97772	523, 527, 531, 533
18-1709	MERCURY MARINE	862129A1	712	18-1928	CRUSADER	97924	523, 527, 531, 532, 534
18-1710	MERCURY MARINE	862209	717	18-1929	CRUSADER	97114	523, 527, 530-534, 563, 669
18-1711	MERCURY MARINE	862132T	713	18-1929	CRUSADER	97992	523, 527, 530-534, 563, 669
18-1712	OMC	980014	882-885				840
18-1713	OMC	3852563	791, 792	18-1930-1	VOLVO	855387	840
18-1714	OMC	313448	271, 273, 275, 799	18-1930-1	VOLVO	834438-4	840
18-1718			288, 792	18-1931-1	VOLVO	835804	840
18-1721	OMC	433067	269, 282	18-1931-1	VOLVO	856883	840
18-1722	OMC	438399	282	18-1932	VOLVO	856894	840
18-1723	OMC	346004	282	18-1933	CRUSADER	97115	523, 527, 530-534, 563, 669
18-1725	OMC	436834	283	18-1933	CRUSADER	97993	523, 527, 530-534, 563, 669
18-1726	OMC	328743	882-885	18-1934	CRUSADER	98068	523, 527, 531, 532
18-1727	VOLVO	803762	848	18-1935-1	VOLVO	856891	841
18-1728	MERCURY MARINE	816607	717	18-1935-1	VOLVO	855384-4	838, 841
18-1729	OMC	434588	285	18-1936	VOLVO	857037	840

1 This product is priced per piece. To order, priced per package, please add -9 to the part number

2 Items ending in "D" are display packaged - regular number is non-display

3 For discount shop pack of 10, please add -10 to the part number

SIERRA #	O.E.M.	O.E. #	PAGE #	SIERRA #	O.E.M.	O.E. #	PAGE #
SIERRA							
18-19360			842	18-2002	MERCURY MARINE	26-76868	198, 371, 373, 383, 385, 388, 703, 705, 735-738
18-1937	MERCURY MARINE	98562A6	666	18-2002	OMC	320862	293, 806
18-1938	CRUSADER	RO29015	531	18-2003	MERCURY MARINE	26-68493	738
18-1938	CRUSADER	98126	525, 529, 531, 533, 534, 563, 669	18-2003	MERCURY MARINE	26-823894	388, 736
18-1939	BARR	20-0100	489, 506, 532, 539, 557, 559, 561, 562, 667, 776, 841	18-2004	MERCURY MARINE	26-20070	738
18-1939	MARINE POWER	0992-593	489, 506, 532, 557, 559, 561, 667, 776, 841	18-2005	JABSCO	92700-0060	474
18-1940	CHRYSLER INBOARD	3675826	501, 503, 505-508	18-2005	OMC	313284	293
18-1940	CHRYSLER INBOARD	4142322	501, 503, 505-508	18-2006	MERCURY MARINE	26-33467	738
18-1941	CHRYSLER INBOARD	2846106	501, 505-508	18-2007	MERCURY MARINE	26-94038	388, 738
18-1942	CHRYSLER INBOARD	24695566	507	18-2008	MERCURY MARINE	26-56788	388, 738
18-1942	CHRYSLER INBOARD	3675826	501, 505-508	18-2009	MERCURY MARINE	26-89236	388, 705, 707, 738
18-1944	CHRYSLER INBOARD	2847404	503, 505, 506, 508	18-2009	MERCURY MARINE	26-89236	388, 738
18-1944	CHRYSLER INBOARD	2847623	503, 505, 506, 508	18-2010	MERCURY MARINE	26-892361	388, 738
18-1944	CHRYSLER INBOARD	3745639	503, 505, 506, 508	18-2010	MERCURY MARINE	26-96063	388
18-1944	CHRYSLER INBOARD	E9923M	503, 506	18-2011	MERCURY MARINE	26-90562	369, 385, 388, 738
18-1945	CHRYSLER INBOARD	2846689	501, 506-508	18-2012	OMC	310599	293, 806
18-1946	CHRYSLER INBOARD	3527794	501, 507, 508	18-2013	MERCURY MARINE	26-16977	738
18-1948	CHRYSLER INBOARD	E9234M	503, 507	18-2014	MERCURY MARINE	26-89238	388
18-1949			489, 532, 557, 559, 561, 562, 667, 841	18-2015	MERCURY MARINE	26-23517	388, 738
18-1950-1	MERCURY MARINE	77234A2	664	18-2016	OMC	313992	293, 806
18-1951-1	MERCURY MARINE	77235A2	664	18-2016	MERCURY MARINE	26-41953	388, 738
18-1951-1	MERCURY MARINE	77235A8	664	18-2017	MERCURY MARINE	26-32121	388, 738
18-1952-1	MERCURY MARINE	99746A17	664	18-2018	OMC	305987	293
18-1952-1	MERCURY MARINE	99746A8	655, 664	18-2019	MERCURY MARINE	26-26805	383, 388, 738
18-1953-2	MERCURY MARINE	87114A19	664	18-2019	MERCURY MARINE	26-27163	388, 738
18-1953-2	MERCURY MARINE	860246A10	664	18-2020	OMC	310649	293, 806
18-1954-1	MERCURY MARINE	95862A5	664	18-2021	OMC	302564	293
18-1955-1	MERCURY MARINE	96705A1	665	18-2022	OMC	303345	290, 293, 806
18-1956-1	MERCURY MARINE	99798A18	665	18-2023	OMC	313282	236, 290, 293, 294, 806
18-1956-1	MERCURY MARINE	806867A 8	665	18-2024	OMC	314167	290, 293, 806
18-1957-1	MERCURY MARINE	89011A8	665	18-2025	OMC	318972	293
18-1957-1	MERCURY MARINE	807078A 6	665	18-2026	OMC	321453	293, 806
18-1958-1	MERCURY MARINE	65604A4	665	18-2026	MERCURY MARINE	26-16977	738
18-1958-1	MERCURY MARINE	65604A12	665	18-2027	OMC	321459	289-291, 293, 294, 806
18-1960-1	MERCURY MARINE	58759A10	665	18-2028	OMC	321480	289, 293, 294, 806
18-1960-1	MERCURY MARINE	58759A14	665	18-2029	OMC	321481	289, 293, 294, 806
18-1962-1	MERCURY MARINE	65603A12	665	18-2030	OMC	321786	293
18-1962-1	MERCURY MARINE	65603A4	665	18-2031	OMC	321787	289, 290, 293, 294, 806
18-1964	BARR	CHV-1-83	882-885	18-2032	OMC	321788	290, 293, 294, 806
18-1970-1	MERCURY MARINE	98504A3	651, 655, 663, 666	18-2033	OMC	321928	293
18-1971	MERCURY MARINE	76351A2	666	18-2034	OMC	324639	293, 806
18-1972	MERCURY MARINE	76325A2	666	18-2035	OMC	327031	290, 293, 806
18-1973	MERCURY MARINE	55538A2	666	18-2039	VOLVO	804695	864
18-1974-1	MERCURY MARINE	98502A2	666	18-2040	VOLVO	853670	864
18-1975-1	MERCURY MARINE	12076A2	667	18-2041	VOLVO	897426	864
18-1976-1	MERCURY MARINE	44354A3	651, 655, 663, 667	18-2043	VOLVO	958838	864
18-1976-1	MERCURY MARINE	807914A1	655, 663, 667	18-2044	VOLVO	833996	864
18-1977-1	MERCURY MARINE	47441A1	634	18-2045	VOLVO	827247	864
18-1978	MERCURY MARINE	76771A3	666	18-2046	VOLVO	946242	864
18-1978	MERCURY MARINE	76771A2	666	18-2047	VOLVO	958860	864
18-1982	CRUSADER	98125	525, 530-532, 534, 563, 669	18-2048	MERCURY MARINE	26-24590	388, 738
18-1983	CRUSADER	98243	529-532, 534	18-2049	MERCURY MARINE	26-32511	738
18-1984	CRUSADER	98128	525, 529, 532	18-2050	MERCURY MARINE	26-55682	388, 738
18-1985	MERCURY MARINE	93322	667	18-2051	MERCURY MARINE	26-69188	388, 738
18-1986-1	OMC	3852374	775	18-2052	MERCURY MARINE	26-69189	388, 738
18-1986-1	VOLVO	3847501	840	18-2053	HONDA	91255-ZW1-003	207
18-1986-1	VOLVO	3852374-2	840	18-2054	MERCURY MARINE	26-70081	198, 371, 373, 383, 385, 388, 738
18-1986-1	OMC	3857723	775	18-2054	HONDA	91253-ZW1-003	207
18-1986-1	VOLVO	3857723	840	18-2054	MERCURY MARINE	26-76384	388
18-1987-1			665	18-2054	MERCURY MARINE	26-816464	198, 383, 385, 388, 738
18-1989	MERCURY MARINE	87290A4	566, 635	18-2055	MERCURY MARINE	26-79831	369, 385, 388, 738
18-1989	MERCURY MARINE	861006A	566, 635-639	18-2056	MERCURY MARINE	26-66302	388, 701, 735, 736
18-1989K			566, 635	18-2056	MERCURY MARINE	26-965031	388, 738
18-1990	MERCURY MARINE	73813A1	667	18-2056	MERCURY MARINE	26-96503	738
18-1991			489, 531, 551, 666, 776, 841	18-2057	VOLVO	181620	864
18-1992-1			489, 531, 551, 666, 776, 841	18-2057	OMC	313353	293, 806
18-1993	MERCURY MARINE	78984A01	635	18-2059	OMC	321466	806
18-1993	MERCURY MARINE	861493A3	635	18-2060	OMC	321467	806
18-1994	MERCURY MARINE	87290A4	566, 635	18-2061	OMC	329922	293
18-1995	MERCURY MARINE	47638	668	18-2062	OMC	329923	293
18-1996	PLEASURECRAFT	RO28001	550, 551	18-2063	OMC	330327	289, 293-295, 806
18-1997-1	BARR	CHV-1-83	489, 506, 530, 539, 551, 559, 562, 664, 775, 840	18-2064	OMC	332205	806
18-1998-1	BARR	FM-1-83	489, 530, 551, 561, 562, 664, 775	18-2065	OMC	332261	293
18-1999	BARR	20-0082	489, 530, 539, 551, 557, 559, 561, 562, 666, 776, 841	18-2066	OMC	911019	293, 806
18-2000	OMC	309989	293, 806	18-2067	OMC	911685	293
18-2001	OMC	330137	293, 806	18-2068	OMC	911701	293
18-2002	HONDA	91252-ZW1-003	207	18-2068	OMC	916058	293
				18-2068	OMC	915702	293
				18-2068	OMC	3853655	293
				18-2071	OMC	981195	293, 806
				18-2072	OMC	981196	293, 806
				18-2073	OMC	981268	293, 806
				18-2074	OMC	322575	250-253, 293, 295, 806
				18-2074	OMC	339620	250-253, 293, 295, 806
				18-2075	OMC	332942	251-253, 293, 295, 806
				18-2076	MERCURY MARINE	26-12224	388, 738
				18-2077	MERCURY MARINE	26-14077	388, 738
				18-2079	YAMAHA	93101-22M15-00	441, 469
				18-2081	YAMAHA		

1 This product is priced per piece. To order, priced per package, please add -9 to the part number

2 Items ending in "D" are display packaged - regular number is non-display

3 For discount shop pack of 10, please add -10 to the part number

SIERRA #	O.E.M.	O.E. #	PAGE #	SIERRA #	O.E.M.	O.E. #	PAGE #
SIERRA							
18-2082	YAMAHA			18-2163E-9			715
18-2083	YAMAHA			18-2165	MERCURY MARINE	59369	377, 728
18-2085	YAMAHA	93102-35M13-00	441, 469	18-2166	MERCURY MARINE	44-860308	722
18-2087	YAMAHA	93102-40M36-00	882-885	18-2166	MERCURY MARINE	44-66060	722
18-2088	YAMAHA	93102-40M38-00	882-885	18-2166	MERCURY MARINE	44-66060-3	722
18-2091	YAMAHA	93104-22M07-00	882-885	18-2166	MERCURY MARINE	44-824110	722
18-2093	OMC	398051	282	18-2167	MERCURY MARINE	45-41939A1	723
18-2094	MERCURY MARINE	26-88416	694	18-2169	MERCURY MARINE	45589A3	715
18-2097	MERCURY MARINE	805536A2	713	18-2170	MERCURY MARINE	10-45590	715
18-2100	MERCURY MARINE	30-60794A4	714, 716	18-2171	MERCURY MARINE	76850A2	720
18-2100	OMC	983937	793	18-2172	MERCURY MARINE	14505A2	720
18-2100	VOLVO	3853807	860	18-2173	MERCURY MARINE	59826A3	720
18-21001	MERCURY MARINE	30-879194A02	713	18-2174	MERCURY MARINE	758321	713
18-21005	MERCURY MARINE	30-562540A3	714	18-2174	MERCURY MARINE	75832A3	713
18-21005K			714	18-2174	MERCURY MARINE	75832T1	713
18-21006	MERCURY MARINE	30-879194A01	713	18-2174	OMC	915717	793
18-2100K			714	18-2174	OMC	3850812	793
18-2101	MERCURY MARINE	30-36418	714	18-2174	VOLVO	3850812	860
18-2103	PLEASURECRAFT	RO85035	553	18-2175	MERCURY MARINE	18643A7	719
18-2103	MERCURY MARINE	32-86036	729	18-21751	OMC	983902	794
18-2103	MERCURY MARINE	32-86036Q	729	18-21751	OMC	986338	794
18-2104	MERCURY MARINE	75832T	713	18-21751	OMC	3853962	794
18-2104	OMC	915716	791	18-21751	VOLVO	3853962-3	858
18-2104	VOLVO	853255	860	18-21752-1	OMC	984290	794
18-2104	VOLVO	897707	860	18-21752-1	OMC	986120	794
18-2104	MERCURY MARINE	75832A2	699, 701, 713	18-21752-1	OMC	3853917	794
18-2104	OMC	912214	791, 793	18-21752-1	OMC	3858437	794
18-2105	MERCURY MARINE	32-45973	729	18-21752-1	VOLVO	3858437-1	858
18-2106	MERCURY MARINE	32-45974	729	18-21753	OMC	3853862	794
18-2107	MERCURY MARINE	32-55816	729	18-21753	VOLVO	985727	858
18-2108	MERCURY MARINE	32-59841	729	18-21753	VOLVO	3853862-5	858
18-2109	MERCURY MARINE	32-59842	729	18-21754	OMC	984537	794
18-2110	MERCURY MARINE	32-88005	381	18-21754	OMC	986232	794
18-2111	MERCURY MARINE	32-88006	381	18-21755	OMC	984629	794
18-2112	MERCURY MARINE	32-87234	730	18-2176	OMC	908063	794, 795
18-2113	MERCURY MARINE	32-87235	730	18-2177	OMC	908069	794, 795
18-2114	MERCURY MARINE	32-864960	730	18-2178			794
18-2114	MERCURY MARINE	32-99902-1	730	18-2179	MERCURY MARINE	45-55796	714
18-2115	MERCURY MARINE	32-864959	730	18-2180	MERCURY MARINE	45-42634	723
18-2115	MERCURY MARINE	32-99903-1	730	18-2183	OMC	909121	796
18-2116	MERCURY MARINE	32-99904	730	18-2184	OMC	908087	797
18-2125	MERCURY MARINE	46020T	699, 701, 712	18-2185	OMC	909753	797
18-2126	MERCURY MARINE	32-52951A1	730	18-2186	OMC	982424	797
18-2128	MERCURY MARINE	39383T	699, 701, 713	18-2187	OMC	391472	283
18-2128	MERCURY MARINE	39383 1	713	18-2187	OMC	395209	283
18-2128	OMC	912213	699, 713, 794, 860	18-2187	OMC	395209	283
18-2128	OMC	3850813	699, 713, 794, 860	18-2189	MERCURY MARINE	38399A2	718
18-2128	VOLVO	912213	699, 713, 794, 860	18-2190	MERCURY MARINE	19543A10	718
18-2128	VOLVO	3850813	699, 713, 794, 860	18-2190	MERCURY MARINE	19543A4	718, 719
18-2130	MERCURY MARINE	76865	724	18-2190E	MERCURY MARINE	19543A10	718
18-2136	MERCURY MARINE	32-864589	730	18-2190E	MERCURY MARINE	19543A4	718, 719
18-2136	MERCURY MARINE	32-99902	730	18-2191	MERCURY MARINE	73020A14	723
18-2137	MERCURY MARINE	32-864588	730	18-2192	OMC	379628	757
18-2137	MERCURY MARINE	32-99903	730	18-2193	MERCURY MARINE	99297A1	695
18-2138	VOLVO	3852544	861	18-2194	VOLVO	851452	858
18-2138	OMC	911787	802, 805, 861	18-2194	VOLVO	854040	858
18-2140			695	18-2195	MERCURY MARINE	12632A7	719
18-2141	MERCURY MARINE	10-97934A1	695	18-2196	MERCURY MARINE	19755A4	723
18-2142	MERCURY MARINE	45706A14	732	18-2199	VOLVO	832675	858
18-2143	MERCURY MARINE	78249	353	18-2200	MERCURY MARINE	43-96084A4	721
18-2144	MERCURY MARINE	78687	353	18-2201	MERCURY MARINE	43-18410A2	710
18-2144	MERCURY MARINE	78687T	353	18-2201	MERCURY MARINE	43-18411A2	710
18-2145	MERCURY MARINE	815471	718	18-2202	MERCURY MARINE	52-853594T	722
18-2145	MERCURY MARINE	815471A3	718, 719	18-2202	MERCURY MARINE	52-66063	722
18-2145	MERCURY MARINE	815471A6	718, 719	18-2203	MERCURY MARINE	43-45814A5	711
18-2145E	MERCURY MARINE	815471	718	18-2204	MERCURY MARINE	43-75325A3	711
18-2145E	MERCURY MARINE	815471A6	718	18-2205	MERCURY MARINE	43-55778A3	711
18-2145E	MERCURY MARINE	815471A3	718, 719	18-2206-1	MERCURY MARINE	43-828073A1	721
18-2146	MERCURY MARINE	59830A7	712	18-2206-1	MERCURY MARINE	43-878087A2	721
18-2146	MERCURY MARINE	59830A1	699, 701, 712	18-2206-1	MERCURY MARINE	43-828072A2	721
18-2146	OMC	912212	791, 793	18-2207	OMC	397338	271, 284, 286
18-2146	OMC	3850815	793	18-2208	OMC	318304	271, 284, 286
18-2146	VOLVO	3850815	860	18-2209	OMC	318303	271, 284, 286
18-2148	MERCURY MARINE	77442A1	732	18-2210			284, 286
18-2149	MERCURY MARINE	43433	718, 719	18-2216	OMC	337774	284
18-2150	MERCURY MARINE	774811	724	18-2216	OMC	334516	284
18-2151	MERCURY MARINE	17-45738	733	18-2216	OMC	336562	284
18-2152	MERCURY MARINE	17-45735	733	18-2216	OMC	337772	284
18-2153	VOLVO	814301	861	18-2216	OMC	910995	284
18-2154	MERCURY MARINE	23-30617A2	724	18-2217			284, 286, 287, 797
18-2155	MERCURY MARINE	23-77631A2	377	18-2218	OMC	989966	284
18-2156	OMC	980183	800	18-2218	OMC	434063	797
18-2157	MERCURY MARINE	41951A1	718	18-2218	OMC	436746	284
18-2157	MERCURY MARINE	19543A4	718, 719	18-2218	OMC	985050	284
18-2158			718	18-2219	OMC	333077	797
18-2159	MERCURY MARINE	66069A2	718	18-2219	OMC	317838	284
18-2160	MERCURY MARINE	32-38377	718	18-2219	OMC	340490	284
18-2161	MERCURY MARINE	45518A2	715, 716	18-2220	OMC	323664	797
18-2162	MERCURY MARINE	33981T	715, 719	18-2220	OMC	320630	284
18-2162E			715	18-2221			284, 286, 287
18-2163	MERCURY MARINE	10-31700	715, 719	18-2224	OMC	320166	288

1 This product is priced per piece. To order, priced per package, please add -9 to the part number

2 Items ending in "D" are display packaged - regular number is non-display

3 For discount shop pack of 10, please add -10 to the part number

SIERRA #	O.E.M.	O.E. #	PAGE #	SIERRA #	O.E.M.	O.E. #	PAGE #
SIERRA							
18-2225	OMC	320167	288	18-2349	MERCURY MARINE	23-67370	694
18-2226	OMC	320168	288	18-2353	MERCURY MARINE	23-815921A21	724
18-2227	OMC	320169	288	18-2354	MERCURY MARINE	821759A4	724
18-2228	OMC	320170	288	18-2355	OMC	386659	283
18-2229	OMC	323362	273, 275, 288, 792	18-2357	MERCURY MARINE	17-30632	371, 705, 707, 722
18-2230	OMC	323361	273, 275, 288, 792	18-2358	MERCURY MARINE	43-803102T1	710
18-2231	OMC	314745	273, 275, 288, 792	18-2359			378, 723
18-2232	OMC	323889	271, 288	18-2359	MERCURY MARINE	11-35921	378, 723
18-2233	OMC	323890	271, 288	18-2359	MERCURY MARINE	12-92721	378, 723
18-2234	OMC	317232	271, 288	18-2360	MERCURY MARINE	43-828072A3	721
18-2236	MERCURY MARINE	52-822539T	378	18-2361	MERCURY MARINE	10-30206	695
18-2236	MERCURY MARINE	52-822539	371, 378	18-2363	MERCURY MARINE	43-803118T1	710
18-2239	MERCURY MARINE	44-94148	373, 378	18-2364	MERCURY MARINE	43-803119T1	710
18-2243	OMC	316506	267, 269, 286, 796	18-2365	MERCURY MARINE	43-803120T1	710
18-2244	MERCURY MARINE	10-79953Q 2	377	18-2366	VOLVO	876279	860
18-2244	MERCURY MARINE	10-79953A2	377	18-2367	VOLVO	943414	848
18-22441-9			377, 728	18-2368	MERCURY MARINE	43-803071T1	722
18-2245-1	OMC	987661	794	18-2369	MERCURY MARINE	43-803069T1	722
18-2246	OMC	987678	794	18-2370	CHRYSLER FORCE	19291A3	198, 375
18-2247	YAMAHA	679-45611-01-00	453	18-2370	MERCURY MARINE	19291A3	198, 375
18-2248	MERCURY MARINE	73723A1	718, 719	18-2371	YAMAHA	90340-08002-00	453
18-2250	OMC	387879	283	18-2371	YAMAHA	90340-08M04-00	453
18-2251	OMC	433017	283, 286, 287, 797, 798	18-23711-9	YAMAHA	90340-08002-00	453
18-2251	OMC	435022	283, 286, 287, 797, 798	18-23711-9	YAMAHA	90340-08M04-00	453
18-2251	OMC	436740	283, 286, 287, 797, 798	18-2372	MERCURY MARINE	88035	731
18-2252	OMC	387818	797	18-2373	MERCURY MARINE	806191T	731
18-2252	OMC	436888	273, 283, 286, 287, 797, 798	18-2374	YAMAHA	688-45341-10-00	453
				18-2374	YAMAHA	688-45341-00-00	453
18-2254	MERCURY MARINE	44-860308	722	18-23741-9	YAMAHA	688-45341-10-00	453
18-2256	MERCURY MARINE	43-803116T1	711	18-23741-9	YAMAHA	688-45341-00-00	453
18-2257	MERCURY MARINE	43-803112T1	712	18-2375			198, 371, 373, 377, 707, 728
18-2258	MERCURY MARINE	43-803114T1	712	18-2375	MERCURY MARINE	22-67892A1	377, 728
18-2259	MERCURY MARINE	43-803101T1	712	18-2375	MERCURY MARINE	10-14834A1	377, 728
18-2260	MERCURY MARINE	44-17915	378	18-23751-9			198, 377, 728
18-2261	MERCURY MARINE	45-816919	723	18-23751-9	MERCURY MARINE	10-14834A1	377, 728
18-2277	OMC	335722	282, 283	18-23751-9	MERCURY MARINE	22-67892A1	377, 728
18-2279	OMC	335679	282	18-23751-9	MERCURY MARINE	818763A10	724
18-2282	MERCURY MARINE	15-32563A1	708	18-2377	OMC	316563	273, 275, 276, 289
18-2283	MERCURY MARINE	15-45691A1	708	18-2378	OMC	318544	789
18-2284	MERCURY MARINE	15-31535A1	708	18-2378	OMC	318544	277, 789
18-2285	MERCURY MARINE	15-47397A1	373, 708	18-2379	OMC	320041	271, 276
18-2286	MERCURY MARINE	19755A2	723	18-2379	OMC	31490-30030-00	455
18-2287	OMC	319895	285	18-2380	YAMAHA	94998A4	714
18-2288	OMC	397541	283	18-2381	MERCURY MARINE	94998A2	714
18-2288	OMC	439138	269, 283, 286	18-2381	MERCURY MARINE	828692A1	714
18-2289	OMC	433570	285	18-2382	MERCURY MARINE	914716	797
18-2290			285, 287	18-2383	OMC	915272	797
18-2291	MERCURY MARINE	25-60342A2	732	18-2383	OMC	6E5-45611-01-00	453
18-2292	MERCURY MARINE	15-35980A1	708	18-2385	YAMAHA	307551	277
18-2293	MERCURY MARINE	15-36178A1	708	18-2387	OMC	307551	277
18-2294	MERCURY MARINE	15-42637A1	708	18-23871-9	OMC	307551	277
18-2295	MERCURY MARINE	15-57007A1	373, 708	18-2388	YAMAHA	688-45611-00-00	453
18-2296	MERCURY MARINE	15-71013	708	18-2389	OMC	314832	233, 263
18-2298	MERCURY MARINE	14-18323	380, 731	18-2391	OMC	321692	239-241, 263
18-2299	MERCURY MARINE	14-79447	380, 724	18-2392	OMC	327035	232, 236, 263
18-2303	MERCURY MARINE	10-20518	719	18-2393			733
18-2308	OMC	332491	269, 285, 286	18-2394			733
18-2309	OMC	332489	269, 285, 286	18-2395	MERCURY MARINE	17-815953	733
18-2310	OMC	397627	269, 285, 286	18-2396	MERCURY MARINE	17-44166	733
18-2315			285, 286	18-2397	MERCURY MARINE	17-44167A1	733
18-2316	MERCURY MARINE	12-77674	695	18-2398	OMC	320311	269, 286
18-2320	MERCURY MARINE	815919A1	724	18-2399	OMC	324369	271, 273, 275, 286, 800
18-2321	MERCURY MARINE	12632A6	720	18-2400	MERCURY MARINE	1623-815822A53	708
18-2322	MERCURY MARINE	621041	715	18-2401	MERCURY MARINE	1623-8951A27	710
18-2323	MERCURY MARINE	18643A5	720	18-2402	MERCURY MARINE	1623-5356A4	882-885
18-2324	MERCURY MARINE	45-557961	714	18-2404	MERCURY MARINE	43-803079T1	722
18-2325	OMC	435760	882-885	18-2405	MERCURY MARINE	43-803091T1	722
18-2326	OMC	436232	282	18-2406	MERCURY MARINE	43-878087A2	721
18-2327	OMC	436234	282	18-2407	MERCURY MARINE	43-878087A4	722
18-2328	OMC	435761	882-885	18-2408	MERCURY MARINE	43-828073A1	721
18-2330	OMC	436235	282	18-2409	MERCURY MARINE	43-92320T	721
18-2331	MERCURY MARINE	45-853648	723	18-2410	MERCURY MARINE	43-96084A7	721
18-2334			478	18-2411	MERCURY MARINE	1547-861063A4	708
18-2336	MERCURY MARINE	23-90203	733	18-2412	MERCURY MARINE	18311A17	720
18-2337	VOLVO	3850814	860	18-2412	MERCURY MARINE	861523A9	720
18-2337	OMC	3850814	792	18-2413	MERCURY MARINE	69354A2	720
18-2338	OMC	983880	791, 793	18-2414	MERCURY MARINE	97432A2	720
18-2339	OMC	3852384	793	18-2415	MERCURY MARINE	1623-815822A36	707
18-2339	VOLVO	3852384	860	18-2416	MERCURY MARINE	1547-861063A12	709
18-2340	MERCURY MARINE	12-31266	695	18-2417	MERCURY MARINE	1547-861063A10	709
18-2341-1	MERCURY MARINE	23-815950	733	18-2418	MERCURY MARINE	1547-861063A8	709
18-2341-1	MERCURY MARINE	23-8159501	733	18-2419	MERCURY MARINE	1547-861063A6	709
18-2341-1-9	MERCURY MARINE	23-815950	733	18-2420	MERCURY MARINE	14034A3	732
18-2341-1-9	MERCURY MARINE	23-8159501	733	18-2421	MERCURY MARINE	14035A3	732
18-2342	MERCURY MARINE	681001	723	18-2422	MERCURY MARINE	815935A7	732
18-2343	MERCURY MARINE	12-92721	695	18-2423	MERCURY MARINE	815954A7	732, 733
18-2344	MERCURY MARINE	11-45812	Obsolete	18-2424	MERCURY MARINE	98703A26	732
18-2345	MERCURY MARINE	53-815949	733	18-2425	MERCURY MARINE	98704A17	732
18-2346	MERCURY MARINE	824519	723	18-2425	MERCURY MARINE	98704A26	732
18-2348	MERCURY MARINE	24-30893	371, 703, 705, 707, 722	18-2426	MERCURY MARINE	98703A3	732

1 This product is priced per piece. To order, priced per package, please add -9 to the part number
 2 Items ending in "D" are display packaged - regular number is non-display
 3 For discount shop pack of 10, please add -10 to the part number

SIERRA #	O.E.M.	O.E. #	PAGE #	SIERRA #	O.E.M.	O.E. #	PAGE #
SIERRA							
18-2427	MERCURY MARINE	98704A3	732	18-2549	OMC	321435	259
18-2428	MERCURY MARINE	87399A2	732	18-2550	OMC	323214	250, 251, 260
18-2429	MERCURY MARINE	87399A3	732	18-2552	MERCURY MARINE	27-331792	690
18-2430	MERCURY MARINE	26-830749	365	18-2553	MERCURY MARINE	27-47510	634, 685, 686, 690
18-24301-9	MERCURY MARINE	26-830749	365	18-2554	MERCURY MARINE	27-41812	634, 685, 686, 690
18-2432	VOLVO	873228	858	18-2554	MERCURY MARINE	27-90556	634, 690
18-2433	VOLVO	873229	858	18-2555	MERCURY MARINE	27-896561	690
18-2434	MARINE POWER	0100-000	476	18-2556	MERCURY MARINE	27-35996A1	696
18-2434	VOLVO	3857846-4	476	18-2556	MERCURY MARINE	27-35996	693
18-2434	CRUSADER	96938	476, 517, 553, 601	18-2557	OMC	338484	231
18-2434	PLEASURECRAFT	R142006	476, 553	18-2557	OMC	324701	231
18-2434	MERCURY MARINE	814309A1	476, 601	18-2558	MERCURY MARINE	27-19204-2	363
18-2435	MERCURY MARINE	32-861127	730	18-2559	MERCURY MARINE	27-19202	363
18-2435	MERCURY MARINE	32-95858	730	18-2559	MERCURY MARINE	27-42206	363
18-2436	MERCURY MARINE	32-861128	730	18-2560	MERCURY MARINE	12-86645	365
18-2436	MERCURY MARINE	32-95859	730	18-2560	MERCURY MARINE	12-86645 1	365
18-2438	OMC	986145	882-885	18-2561	MERCURY MARINE	27-85087	193, 338, 363
18-2443	MERCURY MARINE	1623-8951A43	709	18-2562	MERCURY MARINE	27-993261	363
18-2446	Mercury / BRP		158	18-2563	HONDA	19232-ZW1-003	205
18-2447			158	18-2563	MERCURY MARINE	27-430341	363
18-2450	MERCURY MARINE	1547-9412A20	709	18-2564	HONDA	19234-ZW1-003	205
18-2451	MERCURY MARINE	1547-9412A21	709	18-2564	MERCURY MARINE	27-430331	363, 371, 693
18-2452	MERCURY MARINE	1547-9412A22	709	18-2565	HONDA	19242-ZW1-003	205
18-2453	MERCURY MARINE	1547-9412A23	709	18-2565	MERCURY MARINE	27-430472	363, 371, 694
18-2461	MERCURY MARINE	17-44166T1	731	18-2566	MERCURY MARINE	27-817277	364
18-2462	MERCURY MARINE	17-14873A1	731	18-2568	MERCURY MARINE	27-25848	360
18-2463	MERCURY MARINE	17-14872A1	732	18-2569	MERCURY MARINE	27-25849	360
18-2464	MERCURY MARINE	56-864641A24	732	18-2570	MERCURY MARINE	27-25851	360
18-2464	MERCURY MARINE	17-815953T1	732	18-2571	MERCURY MARINE	27-31402	356, 359
18-2465-9	MERCURY MARINE	19-14842	731	18-2572	MERCURY MARINE	27-63309	359
18-2466-9	MERCURY MARINE	19-815951	731	18-2573	MERCURY MARINE	27-721421	361
18-2470	Honda	16221-ZV4-610	206	18-2574	MERCURY MARINE	27-854952	361
18-2471	Honda	16221-ZW9-000	206	18-2575	MERCURY MARINE	1399-99	360
18-2472	Honda	16221-ZW1-000	206	18-2579	OMC	338882	257
18-2473	Honda	16201-881-850	206	18-2582	OMC	338813	257
18-2480	Honda	16010-ZV4-005	205	18-2583	VOLVO	3888821	864
18-2481	Honda	16010-ZW9-003	205	18-2584	VOLVO	3888822	864
18-2482	Honda	16010-881-003	205	18-2585	OMC	393942	216
18-2495	HONDA	19232-ZV4-610	205	18-2586	VOLVO	3850594	863
18-2496	HONDA	19233-ZV5-000	205	18-2587	MERCURY MARINE	99356A2	477
18-2499	HONDA	19234-ZY3-000	205	18-2588			477
18-2500	MERCURY MARINE	27-85493	356, 361	18-2589			476
18-25001	MERCURY MARINE	27-14765	692	18-2590	BORG-WARNER	A4876HA	477
18-25002	MERCURY MARINE	27-811588	692	18-2591			477
18-2501	MERCURY MARINE	27-935361	360	18-2592	YAMAHA	6E5-14384-03-00	451
18-2502	MERCURY MARINE	27-904841	361	18-2593	MERCURY MARINE	27-194541	364
18-2503	MERCURY MARINE	27-99177-1	354, 355, 363	18-2595	OMC	982132	293
18-2503	MERCURY MARINE	27-991772	354, 355, 363	18-2596	VOLVO	875422	852
18-2504	MERCURY MARINE	27-88449	357, 361	18-2597			864
18-2505	MERCURY MARINE	27-961711	361	18-2598	VOLVO	3855275	863
18-2506-1	MERCURY MARINE	27-99176-3	354, 355, 358, 363	18-2599	MERCURY MARINE	26-816575A2	342, 383, 384, 632, 707, 715
18-2506-1	MERCURY MARINE	27-991764	354, 363				719
18-2506-1-9	MERCURY MARINE	27-991764	363	18-2600			716
18-2506-1-9	MERCURY MARINE	27-99176-3	354, 355, 358, 363	18-2601-1	MERCURY MARINE	30-803097T1	716
18-2507	MERCURY MARINE	27-85487	356, 361	18-2602	YAMAHA	97080-08045-00	427, 463, 465
18-2508-1	MERCURY MARINE	27-997761	363	18-2603	MERCURY MARINE	19543T1	719
18-2509	MERCURY MARINE	27-67751	355, 358, 359	18-2603E	MERCURY MARINE	19543T1	719
18-2510	MERCURY MARINE	27-967611	360	18-2604	MERCURY MARINE	815471T1	719
18-2511	MERCURY MARINE	27-99173-2	354, 355, 358, 363	18-2604E	MERCURY MARINE	815471T1	719
18-2512	MERCURY MARINE	27-60286	357, 360	18-2605	YAMAHA	90119-08M87-00	427
18-2513	MERCURY MARINE	27-11338	354, 355, 358, 360	18-2606	YAMAHA	90119-08M13-00	427
18-2514	MERCURY MARINE	27-53650	356, 360	18-2607	YAMAHA	97095-06040-00	427
18-2515	MERCURY MARINE	27-53862	357	18-2608	HONDA	19232-881-850	205
18-2516	MERCURY MARINE	16755	693	18-2609	HONDA	19234-881-850	205
18-2518	VOLVO	430017	882-885	18-2610	MERCURY MARINE	27-812775-4	354, 362
18-2519	VOLVO	831622	857	18-2611	MERCURY MARINE	27-812775-5	354, 362
18-2524	HONDA	19232-ZV1-A10	205	18-2613	OMC	508105	784
18-2525	VOLVO	430018	857	18-2614	MERCURY MARINE	27-64818A1	696
18-25250	VOLVO	3863085	857	18-2614	MERCURY MARINE	27-64818Q4	696
18-25251	VOLVO	853868	857	18-2614	MERCURY MARINE	27-64818T1	696
18-2526	VOLVO	430172	857	18-2615	MERCURY MARINE	16755Q1	696
18-2527	VOLVO	831617	857	18-2615	MERCURY MARINE	16755T1	696
18-2528	VOLVO	831891	857	18-2615	MERCURY MARINE	16755A1	696
18-2529	VOLVO	831892	857	18-2617	MERCURY MARINE	27-35996A1	696
18-2530	VOLVO	1336255	857	18-2619-1	MERCURY MARINE	27-94996Q2	696
18-2530	VOLVO	3547991	857	18-2619-1	MERCURY MARINE	27-94996T2	696
18-2531	VOLVO	834476	882-885	18-2619-1	MERCURY MARINE	27-64818A3	696
18-2532	OMC	305762	263	18-2620	MERCURY MARINE	27-54014A1	696
18-2533	OMC	911797	794	18-2620	MERCURY MARINE	27-54014Q1	696
18-2534	CHRYSLER FORCE	F184122-1	198	18-2621	MERCURY MARINE	27-139581	360
18-2534	OMC	309044	263	18-2622	MERCURY MARINE	23-805041A2	715
18-2536	OMC	321120	231	18-2623	OMC	439141	289
18-2537	OMC	324937	263	18-2624	CHRYSLER FORCE	26-85090A2	198, 383
18-2539	OMC	328753	233, 262, 267, 290	18-2624	MERCURY MARINE	26-85090A2	198, 383
18-2541	OMC	911704	262	18-2625	VOLVO	875192	864
18-2543	OMC	318609	249, 250, 261	18-2626	CHRYSLER FORCE	26-43035A4	198, 383
18-2544	OMC	321028	250, 251, 261	18-2626	MERCURY MARINE	26-43035A4	198, 383
18-2545	OMC	321182	250, 259	18-2627	MERCURY MARINE	26-66303A1	383
18-2546	OMC	321184	240, 250, 251, 262	18-2628	MERCURY MARINE	26-77066A1	384
18-2547	OMC	322858	250, 251, 262	18-2629	CHRYSLER FORCE	26-85090A1	199, 384
18-2548	OMC	332108	239, 249, 250, 262	18-2629	MERCURY MARINE	26-85090A1	199, 384

1 This product is priced per piece. To order, priced per package, please add -9 to the part number

2 Items ending in "D" are display packaged - regular number is non-display

3 For discount shop pack of 10, please add -10 to the part number

SIERRA #	O.E.M.	O.E. #	PAGE #	SIERRA #	O.E.M.	O.E. #	PAGE #
SIERRA							
18-2630	CHRYSLER FORCE	FK1060	199	18-2727	MERCURY MARINE	60930	629
18-2631	CHRYSLER FORCE	FK1061	199	18-2728	MERCURY MARINE	26-421021	365
18-2632	CHRYSLER FORCE	FK1063-2	199	18-2729	MERCURY MARINE	27-8128672	360
18-2633	CHRYSLER FORCE	FK1127	199	18-2731	MERCURY MARINE	26-81607M	882-885
18-2635	CHRYSLER FORCE	26-814669A2	199, 384	18-2732	MERCURY MARINE	807166A3	629
18-2635	MERCURY MARINE	26-814669A2	199, 384	18-2733	MERCURY MARINE	99370A2	629
18-2636	CHRYSLER FORCE	26-820645A1	199	18-2735	MERCURY MARINE	27-190506	362
18-2637-1	CHRYSLER FORCE	FK1064	199	18-2736	MERCURY MARINE	27-863895	358
18-2638	CHRYSLER FORCE	FK1065	199	18-2737	MERCURY MARINE	27-850283	882-885
18-2639	CHRYSLER FORCE	FK1068	199	18-2739	MERCURY MARINE	27-832933-5	362
18-2640	CHRYSLER FORCE	FK1203-1	199	18-2740	MERCURY MARINE	27-430057	361
18-2641	MERCURY MARINE	808500	616	18-2741	MERCURY MARINE	27-43004-7	362
18-2642	MERCURY MARINE	26-816575A5	384	18-2742	MERCURY MARINE	85552	198, 383, 384
18-2643	MERCURY MARINE	26-16709A2	735	18-2743	MERCURY MARINE	27-94996Q2	696
18-2644	MERCURY MARINE	26-88397A1	736	18-2743	MERCURY MARINE	27-94996-2	693
18-2645	MERCURY MARINE	26-76868A2	736	18-2744	VOLVO	875826	859
18-2646-1	MERCURY MARINE	26-816575A3	385, 707, 735	18-2744	VOLVO	876294	859
18-2648	MERCURY MARINE	26-32511A1	736	18-2745	OMC	912374	794
18-2649	MERCURY MARINE	25-87400A2	732	18-2746	MERCURY MARINE	32-14358T	717
18-2652	MERCURY MARINE	26-33144A2	722, 736	18-2747	MERCURY MARINE	816431A1	716, 717
18-2653	MERCURY MARINE	26-55682A1	385	18-2748	MERCURY MARINE	32-44348T	661, 717
18-2654	MERCURY MARINE	26-79831A1	369, 385	18-2749	MERCURY MARINE	27-8128671	360
18-2655	MERCURY MARINE	26-89238A2	385	18-2750	MERCURY MARINE	18654A1	716, 717
18-2656	OMC	396350	289	18-2750	MERCURY MARINE	32734A3	716, 717
18-2657	OMC	396352	289	18-2751	MERCURY MARINE	60932A4	716, 717
18-2658	OMC	396351	267, 290, 292	18-2752	MERCURY MARINE	36223A2	717
18-2659	OMC	396355	290	18-2753-2	MERCURY MARINE	74639A2	717
18-2660	OMC	396349	271, 290, 292	18-2753-2	MERCURY MARINE	74639	717
18-2663	OMC	981797	803	18-2755	VOLVO	875827	859
18-2664	OMC	982947	803	18-2756	MERCURY MARINE	86840A05	717
18-2665	OMC	982946	803	18-2756	MERCURY MARINE	86840A3	716, 717
18-2666	OMC	981799	803	18-2757	VOLVO	875828	859
18-2667	OMC	982949	804	18-2757	VOLVO	876633	859
18-2669	OMC	981801	804	18-2758	VOLVO	875848	859
18-2670	OMC	982948	804	18-2758	VOLVO	876631	859
18-2671	OMC	985612	804	18-2759	MERCURY MARINE	53114A1	717
18-2672	OMC	439967	805	18-2760	MERCURY MARINE	78458A1	716, 717
18-2672	OMC	984458	805	18-2761	MERCURY MARINE	32-90949T	717
18-2672	OMC	985613	805	18-2762	MERCURY MARINE	70981A3	717
18-2673	OMC	984459	805	18-2763	OMC	911826	792
18-2673	OMC	986364	805	18-2764	OMC	914036	793
18-2673	OMC	987603	805	18-2765	OMC	983973	793
18-2674	OMC	985518	805	18-2765	OMC	987467	793
18-2674	OMC	986423	805	18-2765	OMC	3854127	793
18-2679			290, 292	18-2765	VOLVO	3854127	794
18-2680			290, 292	18-2766	VOLVO	834751	859
18-2681			290, 292	18-2767	OMC	313080	794
18-2682			290, 292	18-2768	OMC	909527	794
18-2683			290, 292	18-2769	OMC	332000	234, 235, 263, 273
18-2684			290, 292	18-2770	MERCURY MARINE	32-807458T	717
18-2685			290, 292	18-2771			793
18-2686			291, 292	18-2772-1			793, 859
18-2687			291, 292	18-2773	YAMAHA	663-45331-00-94	454
18-2688			291, 292	18-2774	VOLVO	875847	844
18-2689			291, 292	18-2775	VOLVO	875822	844
18-2690			291, 292	18-2776	VOLVO	832831	844
18-2691			291, 292	18-2777	VOLVO	854031	844
18-2692			291, 292	18-2778	VOLVO	832846	844
18-2694	OMC	433550	269, 291, 292	18-2779	OMC	3852696	777
18-2697-1	CHRYSLER FORCE	26-41365A3	199, 386	18-2779	VOLVO	3852696	834
18-2697-1	MERCURY MARINE	26-41365A3	199, 386	18-2780-1	VOLVO	3852741	834
18-2698			801	18-2780-1	VOLVO	3863450	834
18-2699			784, 852	18-2780-1	VOLVO	3863450	834
18-2700	MERCURY MARINE	896173A01	382	18-2780-1	OMC	3852741	834
18-2701	MERCURY MARINE	23-89574	733	18-2781	OMC	3852742	777
18-2701-04	MERCURY MARINE	23-89574	733	18-2781	VOLVO	3852742	834
18-2702-04	MERCURY MARINE	23-99291	733	18-2782	YAMAHA	688-45331-00-94	454, 461
18-2702-04	MERCURY MARINE	23-99291T	733	18-2783	OMC	986629	805
18-2702-1	MERCURY MARINE	23-99291	733	18-2785	YAMAHA	689-W0001-21-00	467
18-2702-1	MERCURY MARINE	23-99291T	733	18-2785	YAMAHA	689-W0001-C1-00	467
18-2702-1	PLEASURECRAFT	RO94020A	553, 733	18-2785	MERCURY MARINE	27-41899M	386, 387
18-2703	OMC	314008	263	18-2787	YAMAHA	698-W0001-20-00	467
18-2704	OMC	320943	263	18-2787	YAMAHA	698-W0001-C0-00	467
18-2705	OMC	315748	232-235,	18-2787	MERCURY MARINE	27-92648M	386, 387
			263, 271, 291	18-2788	YAMAHA	6H3-W0001-21-00	468
18-2706	OMC	321008	234, 235, 263,	18-2788	YAMAHA	6H3-W0001-C1-00	468
			271, 273, 275	18-2789	YAMAHA	6J8-W0001-21-00	468
18-2707	MERCURY MARINE	97351	724	18-2789	YAMAHA	6J8-W0001-C2-00	468
18-2708	OMC	333758	235, 263, 291	18-2791	OMC	987251	805
18-2709	OMC	336530	262	18-2791	OMC	3850597	805, 864
18-2710	MERCURY MARINE	27-414172	360	18-2791	VOLVO	3850597	805, 864
18-2712	MERCURY MARINE	27-414181	360	18-2792	YAMAHA	6H4-W0001-21-00	468
18-2713	MERCURY MARINE	27-433374	362	18-2792	YAMAHA	6H4-W0001-20-00	459, 468
18-2714	MERCURY MARINE	27-41499-5	362	18-2793	VOLVO	875550	848
18-2715	MERCURY MARINE	24-17997A1	701, 715, 735, 736	18-2794-1	YAMAHA	6E5-W0001-F1-00	468
18-2716	MERCURY MARINE	27-414991	362	18-2794-1	YAMAHA	6F3-W0001-21-00	468
18-2717	MERCURY MARINE	27-41475-8	362	18-2794-1	YAMAHA	6F3-W0001-C1-00	468
18-2721	MERCURY MARINE	27-827284	354, 360	18-2794-1	YAMAHA	6G5-W0001-C1-00	468
18-2724	MERCURY MARINE	43713	715	18-2794-1	YAMAHA	6E5-W0001-51-00	463, 468
18-2725	MERCURY MARINE	26-830749A01	386	18-2794-1	YAMAHA	6G5-W0001-21-00	465, 468
18-2726	VOLVO	876392	863	18-2798	YAMAHA	688-W0001-C0-00	468

1 This product is priced per piece. To order, priced per package, please add -9 to the part number
 2 Items ending in "D" are display packaged - regular number is non-display
 3 For discount shop pack of 10, please add -10 to the part number

SIERRA #	O.E.M.	O.E. #	PAGE #	SIERRA #	O.E.M.	O.E. #	PAGE #
SIERRA							
18-2798	YAMAHA	688-W0001-20-00	461, 468	18-2870	OMC	305176	259
18-2799	YAMAHA	61A-W0001-21-00	468	18-2871	OMC	304762	260
18-2799	YAMAHA	61A-W0001-C1-00	468	18-2872	OMC	318334	261
18-2800	MERCURY MARINE	27-757911	359	18-2873	OMC	318335	249, 250, 261
18-2801	MERCURY MARINE	27-32438	364	18-2874	OMC	314876	262
18-2802	MERCURY MARINE	27-481641	359	18-2875	OMC	908013	778
18-2803	MERCURY MARINE	27-904301	359	18-2875	VOLVO	3850495	842
18-2803	MERCURY MARINE	27-90430	355, 359	18-2875	OMC	3850495	778
18-2804	MERCURY MARINE	27-733771	359	18-2876	OMC	307133	249-251, 261
18-2805	MERCURY MARINE	27-85490-2	357, 361	18-2877	OMC	314421	260
18-2806	MERCURY MARINE	27-65788	361	18-2878	OMC	319710	260
18-2807	MERCURY MARINE	27-981853	361	18-2879	OMC	331363	251, 258
18-2808	MERCURY MARINE	27-96278	355, 361	18-2879	OMC	338876	251, 258
18-2809	MERCURY MARINE	27-437792	361	18-2880	OMC	304023	262
18-2810	MERCURY MARINE	27-437772	362	18-2881	OMC	125530	264
18-2811	VOLVO	461618	853	18-2881	OMC	332403	264
18-2812	VOLVO	430107	853	18-2883-1	OMC	907775	786
18-2813	VOLVO	876302	852	18-2884	OMC	313782	254
18-2814	VOLVO	876306	852	18-2885	OMC	303438	254
18-2815	MERCURY MARINE	27-814703	693	18-2886	OMC	203171	260
18-2815	OMC	913276	788	18-2887	OMC	302557	264
18-2815	OMC	3852692	788	18-2888	OMC	332010	254
18-2815	VOLVO	3852692	855	18-2889	OMC	302675	258
18-2816	VOLVO	876337	853	18-2890	OMC	331203	257
18-2817	VOLVO	876359	853	18-2890	OMC	338886	257
18-2818	VOLVO	876433	853	18-2891	OMC	303339	236, 263, 290
18-2819	MERCURY MARINE	27-39915	670	18-2892	OMC	303355	258
18-2820	MERCURY MARINE	27-64818	693	18-2893	OMC	303750	257
18-2820	MERCURY MARINE	27-64818Q4	696	18-2894	OMC	304314	260
18-2823	MERCURY MARINE	27-32769	364	18-2896	MERCURY MARINE	27-52546	670
18-2823	MERCURY MARINE	27-19553	364	18-2896	OMC	311068	778
18-2824	MERCURY MARINE	27-19551	364	18-2898	OMC	309956	260
18-2824	MERCURY MARINE	27-32770	364	18-2900	OMC	332694	258
18-2825	MERCURY MARINE	27-32771	364	18-2900	OMC	338879	258
18-2826	MERCURY MARINE	27-85610-1	364	18-2901	OMC	313065	260
18-2826	MERCURY MARINE	27-856704	364	18-2902	OMC	909314	778
18-2827	MERCURY MARINE	27-39623	339, 342, 364, 383	18-2902	VOLVO	3852468	843
18-2828	MERCURY MARINE	27-39625	339, 342, 364, 383	18-2903	OMC	332696	257
18-2830	OMC	907932	786	18-2903	OMC	338880	257
18-2830	MERCURY MARINE	27-46401	670	18-2904	OMC	319348	261
18-2831	MERCURY MARINE	27-475901	690	18-2905	OMC	329920	251, 261
18-2832	MERCURY MARINE	27-480431	670	18-2906	OMC	333418	257
18-2833	MERCURY MARINE	27-997772	670	18-2907	OMC	325721	251, 261
18-2834	MERCURY MARINE	27-60208	634, 690	18-2908	OMC	331499	257
18-2835	MERCURY MARINE	27-692381	363	18-2908	OMC	338878	257
18-2836	MERCURY MARINE	27-78035	361	18-2909	CRUSADER	97498	534
18-2837	MERCURY MARINE	27-41382	362	18-2909	OMC	915025	787
18-2838	MERCURY MARINE	27-552791	361	18-2909	VOLVO	856116	855
18-2839	MERCURY MARINE	27-854972	361	18-2909	VOLVO	3853412	855
18-2840	MERCURY MARINE	27-35982	693	18-2909	YAMAHA	YSC-12190-00-AC	866
18-2841	MERCURY MARINE	27-77417	338, 340, 341, 356, 357, 364, 385	18-2909			534, 539, 670, 692, 787
18-2841	MERCURY MARINE	27-19552	364	18-2909	MERCURY MARINE	27-99757	684, 692
18-2843	MERCURY MARINE	27-74830	634, 687, 690	18-2910	MERCURY MARINE	1399-5207	882-885
18-2844	MERCURY MARINE	27-488181	690	18-2911	OMC	910236	788
18-2845	CRUSADER	91351	535	18-2912	OMC	908079	786
18-2845	OMC	912965	787	18-2912	MERCURY MARINE	27-53354	670
18-2845	CHRIS-CRAFT	16.11-01236	491, 535, 571-573, 685, 686, 692, 787	18-2913	OMC	331916	249, 250, 260
18-2845	MERCURY MARINE	27-11999	686, 692	18-2914	MERCURY MARINE	27-856081	365
18-2846	MERCURY MARINE	27-47257	363	18-2915	MERCURY MARINE	27-85609-1	365
18-2847	MERCURY MARINE	27-54014	693	18-2915	MERCURY MARINE	27-858524	365, 694
18-2848	MERCURY MARINE	27-524572	690	18-2916	OMC	911702	769, 788, 791
18-2849	MERCURY MARINE	27-818832	670	18-2917	MERCURY MARINE	27-530451	690
18-2849	MERCURY MARINE	27-87105-1	670	18-2917	OMC	312797	785
18-2849	MERCURY MARINE	27-863726	670	18-2917	GM	3701777	785
18-2850	OMC	908935	778	18-2918	OMC	911836	784, 789
18-2851	OMC	313368	788	18-2918	OMC	915840	789
18-2852	OMC	330621	251, 260	18-2919	MERCURY MARINE	27-426311	365, 694
18-2853	OMC	318925	251, 259	18-2922	VOLVO	418870	855
18-2854			491, 842	18-2922	VOLVO	1378911	855
18-2854	BARR	01-0107	491, 842	18-2923	VOLVO	419678	856
18-2855	OMC	314082	262, 271, 290, 291	18-2924	VOLVO	430039	856
18-2856	OMC	319665	261	18-2925	VOLVO	461092	855
18-2857	OMC	319771	249-251, 258	18-2925	VOLVO	1378913	855
18-2857	OMC	386573	249-251, 258	18-2926	VOLVO	463587	856
18-2858	OMC	314809	769, 770, 784, 785	18-2926	VOLVO	1378864	856
18-2858	VOLVO	3852127	769, 770, 784, 785, 845, 846, 855	18-2927	VOLVO	463999	856
18-2859	OMC	311131	786	18-2927	VOLVO	1378909	856
18-2860	OMC	311130	786	18-2928	VOLVO	824633	855
18-2861	OMC	311121	778	18-2928	VOLVO	856044	855
18-2862	OMC	321573	251, 259	18-2929	VOLVO	856028	858
18-2862	OMC	326260	251, 259	18-2930	VOLVO	1266796	855
18-2863	OMC	308799	788	18-2930	VOLVO	1378879	855
18-2864	OMC	321727	249, 250, 260	18-2933	VOLVO	416033	855
18-2865	OMC	313763	249, 250, 260	18-2933	VOLVO	1317466	855
18-2866	OMC	317914	249, 250, 259	18-2934	VOLVO	829714	857
18-2867	OMC	319174	249, 250, 259	18-2935	VOLVO	418411	857
18-2868	OMC	310137	260	18-2936	VOLVO	418445	857
18-2869	OMC	305312	263	18-2937	VOLVO	418412	857
				18-2938	OMC	331917	249, 250, 260
				18-2939	VOLVO	814356	858

1 This product is priced per piece. To order, priced per package, please add -9 to the part number
 2 Items ending in "D" are display packaged - regular number is non-display
 3 For discount shop pack of 10, please add -10 to the part number

SIERRA #	O.E.M.	O.E. #	PAGE #	SIERRA #	O.E.M.	O.E. #	PAGE #
SIERRA							
18-2941	CHRYSLER INBOARD	2469559	501, 505-508	18-3017	CHRYSLER FORCE	47-89984T4	193, 336, 628
18-2941	CHRYSLER INBOARD	2847480	501, 505-508	18-3017	MERCURY MARINE	47-89984T4	193, 336, 628
18-2943	MERCURY MARINE	27-443284	361	18-3017	MERCURY MARINE	47-89984	336, 339, 340, 628,
18-2944	MERCURY MARINE	26-45577	694				630-633, 703, 705, 737
18-2945			206, 277	18-3017	MERCURY MARINE	47-30221	336, 628
18-2945	MERCURY MARINE	12-19183	365	18-3017	MERCURY MARINE	47-65960	336, 628
18-2945	MERCURY MARINE	12-19183 2	365	18-3020	JABSCO	1210-0003	474
18-2945	MERCURY MARINE	12-20260	365	18-3020	JOHNSON PUMP	09-1027B-9	475
18-2945	OMC	307552	789	18-3021	JABSCO	4598-0001	474
18-29451-9			206, 277, 694, 858	18-3021	OVERDORFER	6603	476
18-2946	MERCURY MARINE	27-52364	689	18-3023	SUZUKI	17461-90J00	402
18-2946	MERCURY MARINE	27-81084	689	18-3023	SUZUKI	17461-90J01	402
18-2946	CHRIS-CRAFT	16.50-00204	491, 570,	18-3023	SUZUKI	17461-94500	402
			689, 785, 853	18-3023	SUZUKI	17461-94501	402
18-2946	OMC	908611	785	18-3023	SUZUKI	17461-94502	402
18-2946	OMC	3853336	785	18-3023	SUZUKI	17461-94503	402
18-2946	VOLVO	908611	853	18-3023	SUZUKI	17461-94504	402
18-2946	VOLVO	3853336	853	18-3023	SUZUKI	17461-94505	402
18-2947	OMC	310913	769, 786	18-3023	SUZUKI	17461-94506	402
18-2948	MERCURY MARINE	12-49221-1	365	18-3023	SUZUKI	17461-94510	402
18-2948	MERCURY MARINE	12-49221	365, 694	18-3023	SUZUKI	17461-94511	402
18-2949	VOLVO	835966	856	18-3023	SUZUKI	17461-94520	402
18-2949	VOLVO	856034	856	18-3030	CHRYSLER FORCE	47-803630T	193
18-2949	BARR	CHV-47-000	491, 534, 552,	18-3030	CHRYSLER FORCE	F523065	193
			559, 563, 671,	18-3030	CHRYSLER FORCE	F523065-1	193
			778, 843	18-3031	HONDA	19210-ZY3-003	203
18-2949	CRUSADER	96306	491, 534, 552, 563,	18-3035	SUZUKI	17461-93J00	402
			671, 778	18-3036	VOLVO	875808-8	473
18-2950	OMC	309612	254	18-3036	JABSCO	673-0003	473, 836
18-2951	OMC	304720	254	18-3036	JOHNSON PUMP	09-1026B-9	474, 836
18-2952	OMC	203034	254	18-3037	VOLVO	875660	835
18-2954	OMC	319633	254	18-3037	VOLVO	875736	835
18-2956	OMC	318358	250, 254, 256	18-3037	VOLVO	2430184	835
18-2957	OMC	307069	254	18-3037	JABSCO	836-0003	473, 835
18-2958	OMC	315539	254	18-3037	JOHNSON PUMP	09-1029B-9	474, 835
18-2959	OMC	306048	254	18-3038	JABSCO	17937-0003	473
18-2960	OMC	313413	250, 254, 256	18-3038	JABSCO	920-0003	473
18-2961	OMC	329103	254	18-3038	JOHNSON PUMP	09-1028B-9	475
18-2962	OMC	322332	254	18-3038	VOLVO	877061-2	835
18-2963	OMC	330818	251, 254, 256	18-3038	VOLVO	3841697	835
18-2964	OMC	320745	250, 255, 256	18-3039	MERCURY MARINE	47-89981	336, 339, 341
18-2964	OMC	335360	250, 255, 256	18-3040	YAMAHA	63V-44352-01-00	426
18-2965	VOLVO	419310	853	18-3042	YAMAHA	67F-44352-00-00	426
18-2965	VOLVO	419763-8	853	18-3043	OMC	389642	229
18-2966	VOLVO	462623	854	18-3044	OMC	385072	229
18-2968	VOLVO	1378645	854	18-3046	CRUSADER	1003062	520
18-2970	VOLVO	1378646	854	18-3046	JABSCO	18838-0001	473, 835, 865
18-2971	VOLVO	835908-5	843	18-3046	SHERWOOD PUMP	9959K	475, 498
18-2971	VOLVO	856039-3	838, 839, 843	18-3046	VOLVO	3854286	835
18-2972	VOLVO	1378870	856	18-3047	VOLVO	835874	835
18-2974	VOLVO	418265	882-885	18-3047			473
18-2975	VOLVO	418754	882-885	18-3047	JABSCO	18948-0001	473, 835
18-2979	VOLVO	1378906	857	18-3047	SHERWOOD PUMP	10615K	475, 835
18-2980	VOLVO	875401	853	18-3049	SUZUKI	17461-87E11	402
18-2980	VOLVO	876356	853	18-3049	SUZUKI	17461-87E12	402
18-2982	VOLVO	875569	853	18-3050	OMC	386084	230
18-2982	VOLVO	876358	853	18-3051	OMC	395289	230
18-2983	VOLVO	875400	853	18-3052	MERCURY MARINE	47-89982	336, 339, 342
18-2983	VOLVO	876342	853	18-3053	OMC	396725	230
18-2989	VOLVO	824677	855	18-3054	MERCURY MARINE	47-89980	336
18-2990	VOLVO	832669	858	18-3055	OMC	389589	230
18-2991	VOLVO	855383	840, 843, 856	18-3056	HONDA	19210-ZW1-003	204
18-2991	VOLVO	855967	840, 843, 856	18-3056	MERCURY MARINE	47-43026-T2	336
18-2993	VOLVO	1378491	857	18-3056	CHRYSLER FORCE	47-43026-2	193, 336, 628,
18-2994	VOLVO	430020	858				630, 632, 707
18-2995	VOLVO	856037	855	18-3056	MERCURY MARINE	47-43026-2	193, 336, 628,
18-2996	OMC	911823	784, 789				630, 632, 707
18-2996	OMC	3852560	789	18-3057	CHRYSLER FORCE	47-85089-3	193, 336, 338
18-2996	VOLVO	3852560	858	18-3057	MERCURY MARINE	47-85089-3	193, 336, 338
18-2998	VOLVO	876300	853	18-3058	OMC	983895	768, 769
18-3000	SUZUKI	17461-92D02	402	18-3059	OMC	435748	230
18-3001	OMC	277181	229	18-3059	OMC	5001593	230
18-3001	OMC	434424	229	18-3059	OMC	435821	230
18-3002	OMC	775518	229	18-3059	OMC	397131	230
18-3002	OMC	375638	229	18-3059	OMC	395864	230
18-3003	OMC	775519	229	18-3060	CRUSADER	22212	520
18-3003	OMC	377178	229	18-3060	CRUSADER	1003026	520
18-3005	OMC	377992	229	18-3060	PLEASURECRAFT	RP061015	549
18-3006	OMC	378891	229	18-3060	JABSCO	18838-0001	473, 835, 865
18-3006	OMC	775521	229	18-3060	SHERWOOD PUMP	9959	476
18-3007	MERCURY MARINE	47-89983T	336	18-3060	OVERDORFER	132-0317	476, 835, 865
18-3007	MERCURY MARINE	47-89983	336, 338, 340,	18-3060	OMC	3854286	835
			341, 369, 628	18-3060	VOLVO	835512	835
18-3008	MERCURY MARINE	47-20813	336	18-3060	VOLVO	3854286	835
18-3012	MERCURY MARINE	47-22748	336, 342	18-3061	OVERDORFER	8922	475
18-3013	MERCURY MARINE	26-821309	337	18-3061	CRUSADER	20300	520
18-3014	MERCURY MARINE	26-821310	337	18-3061	PLEASURECRAFT	RP061017	549
18-3015	OMC	433935	229	18-3061	VOLVO	835874	835
18-3016-1	MERCURY MARINE	47-862232A2	628	18-3061	JABSCO	18948-0001	473, 835
18-3017	CHRYSLER FORCE	47-803631T	193	18-3061	CRUSADER	20310	520
18-3017	CHRYSLER FORCE	47-F694065	193	18-3061	SHERWOOD PUMP	10615	476

1 This product is priced per piece. To order, priced per package, please add -9 to the part number

2 Items ending in "D" are display packaged - regular number is non-display

3 For discount shop pack of 10, please add -10 to the part number

SIERRA #	O.E.M.	O.E. #	PAGE #	SIERRA #	O.E.M.	O.E. #	PAGE #
SIERRA							
18-3062	CHRYSLER FORCE	47-42038-2	193, 336	18-3094	SUZUKI	17461-94701	402
18-3062	MERCURY MARINE	47-42038-2	193, 336	18-3094	SUZUKI	17461-94700	402, 403
18-3063	MERCURY MARINE	47-95611M	336	18-3095	SUZUKI	17461-95301	402
18-3063	YAMAHA	662-44352-01-00	426	18-3095	SUZUKI	17461-95302	402
18-3065	YAMAHA	6L2-44352-00-00	426, 433	18-3095	SUZUKI	17461-95300	402, 403
18-3066	MERCURY MARINE	47-11590M	336	18-3096	SUZUKI	17461-96301	402
18-3066	YAMAHA	6G1-44352-00-00	426	18-3096	SUZUKI	17461-96312	402
18-3067	MERCURY MARINE	47-84797M	336, 342	18-3096	SUZUKI	17461-96311	402, 403
18-3067	YAMAHA	689-44352-02-00	426, 433, 457	18-3097	SUZUKI	17461-98501	402
18-3068	YAMAHA	6H4-44352-00-00	426, 433	18-3097	SUZUKI	17461-98502	402
18-3068	YAMAHA	6H4-44352-02-00	426, 433, 459	18-3097	SUZUKI	17461-98503	402
18-3069	YAMAHA	697-44352-00-00	426	18-3098	MERCURY MARINE	47-161543	337
18-3069	MERCURY MARINE	47-81423M	336, 342	18-3099	OMC	5033112	230
18-3069	MERCURY MARINE	47-97108M	336, 342	18-3099	SUZUKI	17461-93901	402
18-3069	YAMAHA	6H3-44352-00-00	426, 432, 433	18-3099	SUZUKI	17461-93902	402
18-3070	YAMAHA	688-44352-03-00	426, 461	18-3099	SUZUKI	17491-93903	230
18-3071	YAMAHA	6E5-44352-01-00	426	18-3100	HONDA	19210-ZW9-003	204
18-3071	YAMAHA	6E5-44352-00-00	426, 463, 465	18-3100	HONDA	19210-ZW9-013	204
18-3072	MERCURY MARINE	47-80395M	336	18-3102	OMC	305303	230
18-3072	YAMAHA	646-44352-01-00	426	18-3103	OMC	303069	230
18-3073	MERCURY MARINE	47-96305M	336	18-3104	OMC	437059	230
18-3073	YAMAHA	6E0-44352-00-00	426	18-3104	OMC	432941	230
18-3074	MERCURY MARINE	47-84027T	336	18-3106	VOLVO	806256	834
18-3074	MERCURY MARINE	47-84027M	336, 341	18-3106	VOLVO	831009	834
18-3074	YAMAHA	682-44352-01-00	426, 431	18-3107	MERCURY MARINE	32768	337
18-3075	JABSCO	124310-46090	473	18-3107	MERCURY MARINE	54705	337
18-3075	JABSCO	14510-46090	473	18-3108	OMC	308928	231
18-3075	VOLVO	875575	835	18-3109	MERCURY MARINE	23-29804	337
18-3075	JABSCO	2877-0001	473, 835	18-3109	MERCURY MARINE	23-29804T	337
18-3075	JABSCO	4568-0001	473, 835	18-3110	MERCURY MARINE	26-38970	337
18-3075	JOHNSON PUMP	09-801B	474, 835	18-3111	OMC	907774	768, 769
18-3075	JOHNSON PUMP	B6620	475, 835	18-3113	MERCURY MARINE	70977	337
18-3076	VOLVO	833995	835	18-3114	MERCURY MARINE	48752	337
18-3076	VOLVO	875583	835	18-3114	MERCURY MARINE	48752T	337
18-3076	JOHNSON PUMP	09-45589	475, 835	18-3115	MERCURY MARINE	48753	337
18-3076	JABSCO	22405-0001	473, 835	18-3116	MERCURY MARINE	46-96148T	337
18-3076	JOHNSON PUMP	09-808B	475, 835	18-3116	MERCURY MARINE	46-96148A1	337
18-3077	JABSCO	920-0001	473	18-3117	MERCURY MARINE	32435	337
18-3077	CUMMINS	650607	474	18-3118	MERCURY MARINE	46-77822A1	337
18-3077	YANMAR	127610-42200	474	18-3119	OMC	983298	768, 769
18-3077	SHERWOOD PUMP	18200	475	18-3121	OMC	911703	769, 791
18-3077	OBERDORFER	C7441	475	18-3122	HONDA	19231-ZW1-003	204
18-3077	VOLVO	877061-2	835	18-3122	MERCURY MARINE	817276 1	337
18-3077	JOHNSON PUMP	09-102B	473	18-3122	MERCURY MARINE	817276	193, 337
18-3077	VOLVO	3841697	835	18-3125	JABSCO	3101-0000	474
18-30777	VOLVO	3841697	836	18-3125	JOHNSON PUMP	3298-0000	475
18-3078	CUMMINS	160596	473	18-3126	OMC	321940	231
18-3078	CUMMINS	166758	473	18-3127	OMC	319275	230
18-3078	CUMMINS	556540	473	18-3129	OMC	435673	231
18-3078	CUMMINS	556850	473	18-3133	OMC	331979	232-236, 257, 271, 803
18-3078	CUMMINS	21601R	473	18-3135	OMC	306643	792
18-3078	JABSCO	836-0001	473	18-3136	OMC	323626	232-236, 257, 275
18-3078	JOHNSON PUMP	09-1029B	474	18-3138	OMC	334897	231
18-3078	OBERDORFER	7054	475	18-3139	MERCURY MARINE	46895	337
18-3078	VOLVO	875660	835	18-3140	SHERWOOD PUMP	10931	476
18-3078	VOLVO	875736	835	18-3140	CRUSADER	20502	520
18-3078	VOLVO	2430184	835	18-3141	OMC	313176	769
18-3079	YANMAR	104211-42070	474	18-3142	YAMAHA	68T-44323-00-00	428
18-3079	VOLVO	3586498	835	18-3142	YAMAHA	67F-44323-00-00	428
18-3079	VOLVO	875807-0	835	18-3143	YAMAHA	911844	769, 791
18-3079	SHERWOOD PUMP	9979K	835	18-3145	OMC	817275T4	630
18-3079	JABSCO	4528-0001	473, 835	18-3147	MERCURY MARINE	46-84277M	341
18-3079	JOHNSON PUMP	09-806B	474, 835	18-3148	MERCURY MARINE	46-84277T	341
18-3080	JOHNSON PUMP	09-1026B	474	18-3148	MERCURY MARINE	682-W0078-A1-00	431
18-3080	VOLVO	875808	836	18-3148	YAMAHA	46-42040A5	338, 386
18-3080	JOHNSON PUMP	09-1026B-1	836	18-3149-1	MERCURY MARINE	46-807151A14	630
18-3080	JABSCO	673-0001	473, 836	18-3150	MERCURY MARINE	816597	337
18-3080	JOHNSON PUMP	09-1026B-9	474, 836	18-3151	MERCURY MARINE	908158	234, 236, 257, 271, 803
18-3081	VOLVO	3858256	836	18-3153	OMC	826763A	882-885
18-3081	VOLVO	875811-2	836	18-3154	MERCURY MARINE	47-72774A89	630
18-3081	JABSCO	1210-0001	473, 836	18-3160	MERCURY MARINE	46-862914A13	630
18-3081	JOHNSON PUMP	09-1027B	474, 836	18-3162	YAMAHA	67F-44322-00-00	426
18-3081	VOLVO	3862281	836	18-3163	YAMAHA	6L5-44323-00-00	428
18-3082	OMC	382547	230	18-3164	YAMAHA	6L5-44322-00-00	426
18-3083	OMC	777213	230	18-3166	YAMAHA	6E0-44366-00-00	429
18-3083	OMC	377230	230	18-3167	YAMAHA	275595	882-885
18-3084	CHRYSLER FORCE	47-F40065-2	193	18-3168	CRUSADER	20309	521
18-3085	CHRYSLER FORCE	47-F84065	193	18-3168	CHRYSLER INBOARD	10927	476, 498, 521
18-3086	OMC	777130	768	18-3168	SHERWOOD PUMP	10927	476, 498, 521
18-3086	OMC	379475	768, 769	18-3169	SHERWOOD PUMP	12322	476
18-3087	MERCURY MARINE	47-59362T	628	18-3169	SHERWOOD PUMP	12859	476
18-3087	MERCURY MARINE	47-59362	628, 630	18-3169	SHERWOOD PUMP	40057	521
18-3088	YAMAHA	6F5-44352-00-00	426	18-3170	YAMAHA	6E5-44311-00-00	427, 432, 463, 465
18-3089	JOHNSON PUMP	09-45825	475, 836	18-3171	YAMAHA	688-44311-01-00	427, 461
18-3090	OMC	387361	230	18-3173	YAMAHA	61A-44311-00-00	427
18-3090	OMC	763735	230	18-3175	VOLVO	858467	834
18-3091	OMC	389576	230	18-3176	YAMAHA	68T-44366-00-00	429
18-3092	SUZUKI	17461-93001	402	18-3178	OMC	318995	231
18-3092	SUZUKI	17461-93003	402				
18-3092	SUZUKI	17461-93004	402				

1 This product is priced per piece. To order, priced per package, please add -9 to the part number

2 Items ending in "D" are display packaged - regular number is non-display

3 For discount shop pack of 10, please add -10 to the part number

SIERRA #	O.E.M.	O.E. #	PAGE #	SIERRA #	O.E.M.	O.E. #	PAGE #
SIERRA							
18-3179	OMC	324097	230	18-3267	SUZUKI	17400-98J00	404
18-3180	OMC	435390	231	18-3268	HONDA	90752-ZV4-650	204
18-3182	OMC	317841	230	18-3269	HONDA	90752-ZV7-000	204
18-3185	YAMAHA	61N-44311-01-00	427	18-3270	HONDA	90752-ZV5-003	204
18-3186	YAMAHA	63D-44323-00-00	428	18-3271	HONDA	90752-ZW1-B02	204
18-3187	HONDA	06192-ZW1-305	204	18-3273	HONDA	90752-ZY3-003	204
18-3188	SUZUKI	17471-98503	402	18-3274	VOLVO	808007	835
18-3189	SUZUKI	17471-87D01	402	18-3275	JABSCO	17935-0001	473
18-3190	SUZUKI	17471-93902	403	18-3275	JOHNSON PUMP	09-819B	474
18-3191	SUZUKI	17471-94501	403	18-3275	VOLVO	877066	835
18-3192	SUZUKI	17471-87E01	403	18-3276-1	VOLVO	3862567	835
18-3193	SUZUKI	17471-92D10	403	18-3276-1	VOLVO	21213660	835
18-3194	YAMAHA	61N-44323-00-00	427, 434	18-3277	YANMAR	192470-42530	835
18-3195	YAMAHA	63V-44323-00-00	428	18-3277	YANMAR	192470-42532	835
18-3196	YAMAHA	66T-44323-00-00	428	18-3277	JOHNSON PUMP	09-102BB	835
18-3197	MERCURY MARINE	10-76156	373, 629, 695, 703, 705	18-3277	VOLVO	3862281	835
18-3198	MERCURY MARINE	934241	724	18-3278	HONDA	06192-ZV1-C00	204
18-3199	MERCURY MARINE	934231	724	18-3279	HONDA	06192-881-C00	204
18-3200	CHRYSLER FORCE	F697140	200	18-3280	HONDA	06192-ZV4-000	204
18-3200	HONDA	90508-ZW1-003	207	18-3281	HONDA	06192-ZV7-000	205
18-3200	PLEASURECRAFT	R096117	553	18-3282	HONDA	06192-ZV5-003	205
18-3200	MERCURY MARINE	14-31210	381	18-3283	HONDA	06192-ZW1-000	205
18-3200	MERCURY MARINE	14-816629	381, 728	18-3284	HONDA	06192-ZY6-000	205
18-3201			231	18-3285	HONDA	06192-ZY3-000	205
18-3202			231	18-3286			769
18-3203			231	18-3287	VOLVO	876120	835
18-3204	MERCURY MARINE	14-76281	369, 381	18-3288	HONDA	91252-ZV1-003	206
18-3205	VOLVO	875574	836	18-32882	VOLVO	3852315	864
18-3206	OMC	984744	768, 791	18-3289	MERCURY MARINE	26-864319	694
18-3207	MERCURY MARINE	47-89983Q1	338	18-3290	OMC	321886	228
18-3207	MERCURY MARINE	47-89983T2	338	18-3291	SUZUKI	09420-05006	402
18-3208	VOLVO	875584	836	18-3292	SUZUKI	17462-93990	402
18-3209	VOLVO	875383	836	18-3293	MERCURY MARINE	28-43037	337
18-3210			231	18-3294	MERCURY MARINE	28-81603M	337
18-3211			232, 238	18-3295	OMC	330619	231
18-3212-1	OMC	984461	769	18-3296	SUZUKI	09420-05005	402
18-3214			338	18-3297	YAMAHA	90280-03M03-00	427
18-3214	MERCURY MARINE	47-43026T11	338	18-3299	OMC	331107	231
18-3214	MERCURY MARINE	47-43026T6	338	18-3300	MERCURY MARINE	28-83444M	337
18-3214	MERCURY MARINE	47-43026T8	338	18-3300	YAMAHA	90280-04M00-00	427, 432
18-3215	MERCURY MARINE	47-85089T7	338	18-3301	YAMAHA	90280-04M04-00	427, 431, 461
18-3215			193, 194, 338, 344	18-3302	YAMAHA	90280-04M05-00	427, 431, 432, 463, 465
18-3216	MERCURY MARINE	47-59362A4	630	18-3303	JOHNSON PUMP	01-42401	475
18-3217			339, 345, 346, 630, 631	18-3304	JABSCO	6760-0001	473
18-3219	MERCURY MARINE	42724A3	715	18-3304	JOHNSON PUMP	09-802-B	538
18-3220	MERCURY MARINE	32-54236	629, 699	18-3305	MERCURY MARINE	28-81912M	337
18-3221	MERCURY MARINE	32-860220	629, 701	18-3305	YAMAHA	90280-03024-00	427, 459
18-3222	MERCURY MARINE	23-816583	629	18-3306	JABSCO	13554-0001	473
18-3223-9			490, 508, 533, 552, 629	18-3306	JOHNSON PUMP	09-812B	474
18-3226	MERCURY MARINE	10-30720	629, 633, 703, 705	18-3306	YANMAR	119773-42600-01	473
18-3227	MERCURY MARINE	17-35973	337	18-3309			630
18-3229	MERCURY MARINE	10-28668	629, 699, 701, 715	18-3310	YAMAHA	6G5-W0078-01-00	431
18-3230	MERCURY MARINE	10-816601	695	18-3311	YAMAHA	6G5-W0078-A1-00	431
18-3231	MERCURY MARINE	10-98794	695	18-3312	YAMAHA	6N6-W0078-00-00	431
18-3232	MERCURY MARINE	19-47579	733	18-3313	YAMAHA	6N6-W0078-01-00	431
18-3233	MERCURY MARINE	16-49545	882-885	18-3314			340
18-3236	MERCURY MARINE	23-32632	695	18-3315-2	OMC	435929	236
18-3237			630	18-3315-2	OMC	5001595	236
18-3238	OMC	388891	231	18-3316	MERCURY MARINE	46-78400A2	340
18-3239			339, 343, 344	18-3317	MERCURY MARINE	46-96148A8	340, 631
18-3240			193, 194	18-3318	MERCURY MARINE	47-59362Q08	630
18-3242	SUZUKI	17400-96350	403	18-3319	MERCURY MARINE	46-42579A4	340
18-3242	SUZUKI	17400-96351	403	18-3320			631
18-3243	SUZUKI	17400-94700	403	18-3321			631
18-3244	SUZUKI	17400-95550	403	18-3322	MERCURY MARINE	46-77516A3	340
18-3245	HONDA	19210-881-A01	204	18-3323	MERCURY MARINE	46-73640A2	341
18-3245	HONDA	19210-881-A02	204	18-3324	MERCURY MARINE	46-77177A3	341
18-3246	HONDA	19210-ZV4-013	204	18-3325	OMC	387326	232
18-3247	HONDA	19210-ZV4-651	204	18-3326	OMC	300611	231
18-3248	HONDA	19210-ZV5-003	204	18-3327	OMC	386697	232
18-3249	HONDA	19210-ZV7-003	204	18-3327	OMC	394711	232
18-3250	HONDA	19210-ZW1-B04	204	18-3327	OMC	391698	232, 237
18-3251			193, 194	18-3328	YAMAHA	646-44322-00-00	428
18-3252	MERCURY MARINE	47-89982T1	339	18-3329	OMC	302497	296
18-3253	SUZUKI	17400-87D11	403	18-3332	OMC	304026	263
18-3254	SUZUKI	17400-87E03	403	18-3333	YAMAHA	61A-44322-00-00	427
18-3255	SUZUKI	17400-92D01	403	18-3336	OMC	384087	231
18-3256	SUZUKI	17400-93951	403	18-3337	OMC	315837	232-235, 263
18-3257	SUZUKI	17400-94611	403	18-3343	OMC	320981	231
18-3258	SUZUKI	17400-90J11	403	18-3344	YAMAHA	6E5-44323-00-00	428
18-3259	SUZUKI	17400-98551	403	18-3345	YAMAHA	6G5-44323-00-00	428, 463, 465
18-3260	SUZUKI	17400-98652	403	18-3346	OMC	435027	230
18-3261	VOLVO	875769	836	18-3348	OMC	984461	769, 791
18-3262	VOLVO	875759	836	18-3349			769
18-3263	VOLVO	875698	836	18-3350	MERCURY MARINE	94576	629, 630
18-3264	SUZUKI	17400-93-J00	403	18-3351	MERCURY MARINE	94916	629, 630
18-3265	MERCURY MARINE	47-43026Q06	339	18-3352	OMC	325398	882-885
18-3266	SUZUKI	17400-98661	404	18-3356	YAMAHA	63V-44301-00-00	427
				18-3357	YAMAHA	646-44323-00-00	428
				18-3358	OMC	328751	231

1 This product is priced per piece. To order, priced per package, please add -9 to the part number
 2 Items ending in "D" are display packaged - regular number is non-display
 3 For discount shop pack of 10, please add -10 to the part number

SIERRA #	O.E.M.	O.E. #	PAGE #	SIERRA #	O.E.M.	O.E. #	PAGE #
SIERRA							
18-3359	OMC	328755	230	18-3436	YAMAHA	663-44323-00-00	428, 432, 433, 459
18-3360	OMC	329390	233, 236, 261, 289	18-3440	YAMAHA	66T-W0078-00-00	433
18-3363	OMC	330560	231	18-3442	YAMAHA	68V-W0078-00-00	429
18-3365	OMC	909533	233-236, 257	18-3443	YAMAHA	61N-44322-01-00	427
18-3366	OMC	390286	230	18-3444	YAMAHA	63V-44322-00-00	427
18-3367	OMC	393632	231	18-3445	MERCURY MARINE	46-812966A7	338
18-3368	OMC	396809	230	18-3446	MERCURY MARINE	46-70941A3	341
18-3369	OMC	319126	232-236, 257, 269, 273, 275	18-3447	MERCURY MARINE	46-46893A6	342
18-3370	YAMAHA	302325	257	18-3448	MERCURY MARINE	46-48744A3	342
18-3370	YAMAHA	692-W0078-01-00	431	18-3449	YAMAHA	63D-44322-00-00	427
18-3370	YAMAHA	692-W0078-00-00	431, 461	18-3450	YAMAHA	68T-W0078-00-00	430
18-3371	YAMAHA	692-W0078-A0-00	431	18-3451	YAMAHA	67F-W0078-00-00	430
18-3372	YAMAHA	6E5-W0078-01-00	431	18-3452	OMC	5006511	232
18-3373	YAMAHA	6E5-W0078-A1-00	432	18-3453	OMC	438592	232
18-3374	YAMAHA	6F5-W0078-00-00	432	18-3454	OMC	340619	231
18-3375			432, 434	18-3455	OMC	6G1-44322-00-00	427
18-3376	OMC	384956	232	18-3456	YAMAHA	6G1-W0078-A1	430
18-3377	OMC	382468	232	18-3460	YAMAHA	6N0-W0078-A0-00	430
18-3378	OMC	391635	233	18-3460	YAMAHA	6H3-W0078-00-00	433
18-3379	OMC	390381	233	18-3461	YAMAHA	6H3-W0078-A0-00	433
18-3380	OMC	390770	233	18-3462	YAMAHA	6A1-W0078-02-00	430
18-3381	OMC	393509	233	18-3463	YAMAHA	6A1-W0078-01-00	430
18-3382	OMC	393630	233, 237, 267	18-3464	YAMAHA	6H3-W0078-01-00	430
18-3383	OMC	395270	233	18-3465	YAMAHA	6H3-W0078-02-00	430
18-3384	OMC	386124	233	18-3466	YAMAHA	6H3-W0078-01-00	430
18-3385	OMC	396932	234	18-3466	YAMAHA	6H3-W0078-02-00	430
18-3386	OMC	983218	769	18-3466	YAMAHA	17411-93901	404
18-3387	OMC	432956	234	18-3480	Suzuki	17411-94421	404
18-3388	OMC	389143	234	18-3481	Suzuki	15170-93911	399
18-3389	OMC	436957	234	18-3495	Suzuki	15170-94320	399
18-3390	OMC	395060	234	18-3496	Suzuki	5033372	224
18-3391	OMC	395072	234	18-3497	OMC	15170-91J00	399
18-3392	OMC	434421	235, 238, 273, 275	18-3497	SUZUKI	5036216	224
18-3393	OMC	395073	235	18-3498	OMC	15170-94J00	399
18-3394	OMC	433548	235, 237, 269	18-3498	SUZUKI	15170-94JOV	399
18-3395	YAMAHA	61A-W0078-01-00	432	18-3499	SUZUKI	5030699	224
18-3396	YAMAHA	61A-W0078-A2-00	432	18-3499	OMC	15170-99E00	399
18-3396	YAMAHA	61A-W0078-A3-00	432	18-3500	OMC	434137	239
18-3397	YAMAHA	679-W0078-00-00	432	18-3501	OMC	435957	224
18-3397	YAMAHA	679-W0078-A0-00	432	18-3502	OMC	912614	769
18-3398	YAMAHA	6F5-W0078-A0-00	432	18-3504	VOLVO	3588475	835
18-3399	OMC	396933	235	18-3505	YAMAHA	63V-44365-10-00	429
18-3400	OMC	391698	236, 237	18-3506	MERCURY MARINE	46-879194401	628
18-3401	OMC	395271	236	18-3507	MERCURY MARINE	46-60366A1	340
18-3402	OMC	382296	236	18-3510	JOHNSON PUMP	09-45589	475
18-3403	OMC	388644	236	18-3515	YAMAHA	6P2-W0078-00-00	429
18-3404	SUZUKI	09420-04009	402	18-3516	YAMAHA	60X-W0078-00-00	429
18-3405	OMC	435959	231	18-3517	MERCURY MARINE	46-96148A5	339, 340, 630, 631
18-3406	MERCURY MARINE	817275A08	339	18-3517	MERCURY MARINE	46-60367A1	340, 631
18-3407	MERCURY MARINE	817275A09	339	18-3517	MERCURY MARINE	46-96148A8	340, 631
18-3408	YAMAHA	6H4-W0078-A0-00	433	18-3518	YAMAHA	6P2-44323-00-00	427
18-3408	YAMAHA	6H4-W0078-00-00	433, 459	18-3519	YAMAHA	61A-44322-02-00	427
18-3409	YAMAHA	67F-W0078-00-00	430	18-3520	YAMAHA	60X-44323-00-00	427
18-3410	YAMAHA	68T-W0078-00-00	430	18-3521	YAMAHA	68V-44323-00-00	427
18-3411	YAMAHA	682-W0078-A1-00	431	18-3522	Yamaha	60X-W0078-00 + 61A-44311-01	430
18-3412	YAMAHA	63V-W0078-01-00	433	18-3523	Yamaha	68V-W0078-00 + 61A-44311-01	430
18-3413	YAMAHA	66T-W0078-00-00	433	18-3527	FORCE	F664068	193
18-3414	MERCURY MARINE	46-96146A5	338, 340	18-3530-1	MERCURY MARINE	860256A4	635
18-3415	YAMAHA	63D-W0078-01-00	433	18-3531	MERCURY MARINE	861188A1	635
18-3416	MERCURY MARINE	46-96146A6	338, 340, 373	18-3532	MERCURY MARINE	55331A5	635
18-3417	MERCURY MARINE	46-57234A1	629, 631, 633, 705	18-3534	MERCURY MARINE	850055001	335
18-3419	MERCURY MARINE	46-42579A3	338, 340	18-3535	MERCURY MARINE	885599004	335
18-3420	MERCURY MARINE	46-44292A3	629, 631, 632, 703	18-3536	MERCURY MARINE	833072003	335
18-3421	MERCURY MARINE	46-48748A1	629, 631	18-3537	MERCURY MARINE	833072004	335
18-3422	MERCURY MARINE	46-77516A1	338, 340	18-3538	VOLVO	3831424	845
18-3423	MERCURY MARINE	46-73640A1	338, 341	18-3539	VOLVO	3831426	844
18-3424	MERCURY MARINE	46-77177A1	338, 341, 369	18-3540	YAMAHA	6E5-12411-30-00	436
18-3425	MERCURY MARINE	84188T	342	18-3541	YAMAHA	66M-12411-01-00	436
18-3425	YAMAHA	663-W0078-00-00	432	18-3543	OMC	378065	239
18-3425	YAMAHA	663-W0078-A0-00	432	18-3543	OMC	508626	239
18-3425	MERCURY MARINE	84188M	342	18-3543	OMC	5005440	239
18-3426	MERCURY MARINE	97793T	342	18-3543	OMC	393659	239-241
18-3426	YAMAHA	689-W0078-04-00	433	18-3543	OMC	434841	239-241
18-3426	YAMAHA	689-W0078-A4-00	433	18-3544	OMC	435491	239
18-3426	MERCURY MARINE	42431M	342	18-3545	OMC	437090	239
18-3426	MERCURY MARINE	97793M	342	18-3546	OMC	5001036	239
18-3427	YAMAHA	689-W0078-A6-00	457	18-3549	MERCURY MARINE	14586	336, 344, 634
18-3427	MERCURY MARINE	95611M	342	18-3550	MERCURY MARINE	59078	634
18-3428-1	YAMAHA	6H3-W0078-00-00	433	18-3551	CHRYSLER INBOARD	4142885	498
18-3428-1	YAMAHA	6H3-W0078-A0-00	433	18-3551	CRUSADER	96319	521
18-3429	YAMAHA	6H4-W0078-A0-00	433	18-3551	PLEASURECRAFT	RO26002E	549
18-3429	YAMAHA	6H4-W0078-00-00	433, 459	18-3551	MERCURY MARINE	59137	634
18-3430	YAMAHA	6J8-W0078-A1-00	433	18-3551	MERCURY MARINE	807252T1	634
18-3431	YAMAHA	6L2-W0078-00-00	433	18-3552	CRUSADER	96358	521
18-3432	YAMAHA	61N-W0078-11-00	430	18-3552	MERCURY MARINE	76270	634
18-3433	YAMAHA	63V-W0078-01-00	433	18-3552	MERCURY MARINE	76270T	634
18-3434	YAMAHA	63D-W0078-01-00	433	18-3553	MERCURY MARINE	75692	335, 336, 344, 345
18-3435			337	18-3554	OMC	383307	769
18-3435	YAMAHA	663-44322-00-00	427, 432, 433, 459	18-3555	MERCURY MARINE	99155A1	634
18-3436			337	18-3556	CHRYSLER FORCE	F97068-2	193

1 This product is priced per piece. To order, priced per package, please add -9 to the part number
 2 Items ending in "D" are display packaged - regular number is non-display
 3 For discount shop pack of 10, please add -10 to the part number

SIERRA #	O.E.M.	O.E. #	PAGE #	SIERRA #	O.E.M.	O.E. #	PAGE #
SIERRA							
18-3557	CHRYSLER FORCE	F335068	193	18-3593	MERCURY MARINE	884727	628
18-3557	OMC	382385	239	18-3597			165
18-3557	OMC	396987	239	18-3599	MERCURY MARINE	811841	628
18-3557	MERCURY MARINE	47594	634	18-3599	MERCURY MARINE	850399	628
18-3557	VOLVO	21148403	844	18-3599	MERCURY MARINE	8503991	628
18-3558	OMC	982554	769, 770	18-3599	VOLVO	3851982	834
18-3558	OMC	3853799	769, 770	18-3599	VOLVO	3853850	834
18-3558	VOLVO	3853799	769, 770	18-3600	MERCURY MARINE	46-72774A32	630
18-3559	CHRYSLER FORCE	F528068	193	18-3601	MERCURY MARINE	32-32461	643, 645
18-3560	OMC	384719	239	18-3602	MERCURY MARINE	32-4172533	643
18-3561	OMC	436195	239	18-3603	MERCURY MARINE	32-43437	643, 645
18-3562	OMC	321222	238, 240, 241	18-3605			335
18-3563	OMC	321027	238, 240, 241	18-3606			335
18-3564	OMC	318395	238, 240, 241	18-3607	MERCURY MARINE	893409	382
18-3565	OMC	321220	239-241	18-3608			436
18-3566	OMC	331894	239	18-3609			436
18-3567	OMC	321221	238, 240, 241, 636	18-3610	OMC	911752	791, 799
18-3568	MERCURY MARINE	99155T1	634	18-3611			436
18-3569	MERCURY MARINE	803061T1	335	18-3615	VOLVO	3587597	845
18-3570			342, 631	18-3617			845, 846
18-3571	MERCURY MARINE	817275A1	341, 346	18-3618			845, 846
18-3572	MERCURY MARINE	817275A2	341, 342, 371	18-3619			845, 846
18-3573	MERCURY MARINE	883925	628	18-3620			845, 846
18-3574	MERCURY MARINE	850454	628	18-3621			845, 846
18-3574	MERCURY MARINE	850454 1	628, 767	18-3622	YAMAHA	6H3-12411-11-00	436
18-3574	OMC	3855991	768	18-3623	YAMAHA	6E5-12411-02-00	436
18-3575	MERCURY MARINE	65142A1	628	18-3624	YAMAHA	69M-12411-01-00	436
18-3575	OMC	380640	767	18-3625	YAMAHA	6F5-12411-03-00	436
18-3575	OMC	984360	767	18-3626			845, 846
18-3575	OMC	986779	767	18-3627	HONDA	19300-881-761	203
18-3575	OMC	3854017	768	18-3628	HONDA	19300-ZW9-003	203
18-3575	VOLVO	3854017	834	18-3629	HONDA	19300-881-741	203
18-3577	CRUSADER	30103	521	18-3630	HONDA	19300-ZV5-043	203
18-3577	PLEASURECRAFT	RA057019	549	18-3644			634
18-3577	MERCURY MARINE	8504541	628	18-3645	CHRYSLER INBOARD	2463441	498
18-3577	OMC	983296	767	18-3646	MERCURY MARINE	807252Q3	634
18-3577	OMC	986074	767	18-3647	MERCURY MARINE	807252Q5	634
18-3577	OMC	987447	767	18-3648			634, 636, 637, 639
18-3577	OMC	3854118	767	18-3649	CRUSADER	97895	521
18-3577	GM	6269358	767	18-3649	MERCURY MARINE	807252-2	634
18-3577	VOLVO	856609	834	18-3650			634
18-3577	CRUSADER	17670	521, 549, 628, 767, 768, 834	18-3651			634
18-3577	CRUSADER	67859	521, 549, 628, 767, 768, 834	18-3652			634
18-3577	CRUSADER	811573	521, 549, 628, 767, 768, 834	18-3653			769, 770
18-3577	MERCURY MARINE	17670	521, 549, 628, 767, 768, 834	18-3654	VOLVO	875779	844
18-3577	MERCURY MARINE	67859	521, 549, 628, 767, 768, 834	18-3656	VOLVO	875781	845
18-3577	MERCURY MARINE	811573	521, 549, 628, 767, 768, 834	18-3656	VOLVO	876097	845
18-3577	VOLVO	3855991	834	18-3658	VOLVO	875784	845
18-3578	OMC	984876	767	18-3658	VOLVO	877349	845
18-3581	CHRYSLER INBOARD	3004886	498	18-3659	VOLVO	875785	845
18-3581	CHRYSLER INBOARD	3619542	498	18-3660	VOLVO	875787	845
18-3581	CHRYSLER INBOARD	3745985	498	18-3660	VOLVO	3831425	845
18-3581	CHRYSLER INBOARD	4417905	498	18-3662	VOLVO	875794	845
18-3582	CHRYSLER INBOARD	3619859	498	18-3662	VOLVO	876305	845
18-3583	CRUSADER	20318	521	18-3663	VOLVO	875791	845
18-3583	CRUSADER	7142520	521	18-3664	VOLVO	875795	845
18-3583	PLEASURECRAFT	RA057018	549	18-3665	VOLVO	875796	845
18-3583	MERCURY MARINE	17437	628	18-3666	VOLVO	875796	845
18-3583	MERCURY MARINE	60658	628	18-3667			634
18-3583	MERCURY MARINE	8503991	628	18-3668			634
18-3583	OMC	382218	767	18-3669			239, 241
18-3583	OMC	980477	767	18-3670			770, 845, 846
18-3583	OMC	985429	767	18-3671	CRUSADER	97361	521
18-3583	VOLVO	835390	834	18-3671	PLEASURECRAFT	RP026002E	549
18-3583	VOLVO	856364	834	18-3672			241, 335
18-3583			486, 521, 549, 628, 767, 768, 834	18-3673			239, 241
18-3583	OMC	3853850	768	18-3674			239, 241
18-3583	VOLVO	3853850	834	18-3675	MERCURY MARINE	27-8503181	361
18-3584	PLEASURECRAFT	RA057004	549	18-3676	VOLVO	3853983	845, 846
18-3584	MERCURY MARINE	883885	628	18-3676	VOLVO		770, 845, 846
18-3584	MERCURY MARINE	71683A1	628	18-3677	VOLVO	3856961	845, 846
18-3584	OMC	982515	767	18-3677			770, 845, 846
18-3584	OMC	982517	767	18-3700	CHRYSLER FORCE	F7000	200
18-3584			521, 549, 628, 767, 768, 834	18-3700	HONDA	90301-ZW1-003	207
18-3584	OMC	3853796	768	18-3700	PLEASURECRAFT	R017066	553
18-3584	VOLVO	3853796	834	18-3700	MERCURY MARINE	11-52707	381
18-3586	JOHNSON PUMP	10-24228-1	475	18-3701			381
18-3586	PLEASURECRAFT	RA057023	549	18-3701	MERCURY MARINE	11-52707Q1	381
18-3586	VOLVO	841640	834	18-3701	MERCURY MARINE	11-52707A1	381, 728
18-3586	INDMAR	665011	475, 538, 549, 834	18-3701	MERCURY MARINE	11-69578A1	381
18-3587	JOHNSON PUMP	10-24232-1	475	18-3702	MERCURY MARINE	11-69578Q1	369, 381
18-3587	INDMAR	685001	538	18-3702	MERCURY MARINE	11-69578T1	369, 381
18-3587	PLEASURECRAFT	RA057024	549	18-3703	MERCURY MARINE	11-88228	381
				18-3704	MERCURY MARINE	11-69578	381
				18-3705	OMC	314503	800
				18-3706	OMC	318971	277, 278
				18-3707	OMC	318991	277
				18-3708-1	VOLVO	3850984	861
				18-3708-1	OMC	398042	277
				18-3709	Yamaha	647-45616-02	454
				18-3710	SUZUKI	09141-14008	407

1 This product is priced per piece. To order, priced per package, please add -9 to the part number

2 Items ending in "D" are display packaged - regular number is non-display

3 For discount shop pack of 10, please add -10 to the part number

SIERRA #	O.E.M.	O.E. #	PAGE #	SIERRA #	O.E.M.	O.E. #	PAGE #
SIERRA							
18-3712	MERCURY MARINE	12-45810	699, 701, 714	18-3804	MERCURY MARINE	27-84733M	358
18-3713	MERCURY MARINE	11-22339	699, 701, 714	18-3804	YAMAHA	689-11181-02-00	443
18-3714	MERCURY MARINE	12-31211A2	380, 724	18-3804	MERCURY MARINE	27-19138	358, 443, 444
18-3715	OMC	175266	277	18-3804	YAMAHA	689-W0001-A1-00	358, 443, 444
18-3715			277-279, 800, 801	18-3805	YAMAHA	688-11181-A1-00	443
18-3716	OMC	175267	800	18-3805	YAMAHA	688-11181-02-00	441-443
18-3717	OMC	175268	277	18-3806	SUZUKI	11141-98401	405
18-3719	OMC	314730	795	18-3807	SUZUKI	11141-98101	405
18-3719	MERCURY MARINE	11-35921	378, 723	18-3808	SUZUKI	11141-93901	405
18-3720	MERCURY MARINE	11-34932	380, 731	18-3809	SUZUKI	11141-96303	405
18-3721	MERCURY MARINE	11-859116	695	18-3810	SUZUKI	11141-94401	405
18-3721	MERCURY MARINE	11-34933	369, 373, 380, 731	18-3813	SUZUKI	11141-95305	405
18-3721	MERCURY MARINE	11-13439-1	695	18-3814	SUZUKI	11141-95505	406
18-3722	VOLVO	3852005	861	18-3816	SUZUKI	11141-98504	406
18-3722	MERCURY MARINE	11-20361	373, 380, 705, 731	18-3816	SUZUKI	11141-98522	406
18-3722	MERCURY MARINE	11-35888	380, 633, 705, 731	18-3817	SUZUKI	11141-92D01	406
18-3722	OMC	121731	802	18-3819	SUZUKI	11141-95D90	406
18-3723	MERCURY MARINE	11-45592	380, 731	18-3820	SUZUKI	11141-94701	406
18-3725	OMC	908064	794, 795	18-3820	SUZUKI	11141-94702	406
18-3726	SUZUKI	09141-18005	407	18-3822	SUZUKI	11141-87E90	406
18-3726	YAMAHA	90171-18M04-00	463, 465	18-3823	SUZUKI	11141-94506	406
18-3728	MERCURY MARINE	11-863332	695	18-3824	SUZUKI	11141-94600	406
18-3728	MERCURY MARINE	11-99298	695	18-3825	SUZUKI	11141-87D90	406
18-3729	MERCURY MARINE	10-97934	695	18-3827	MERCURY MARINE	27-8254821	358
18-3730	VOLVO	3852648-9	860	18-3827	YAMAHA	6G8-11181-00-00	443
18-3730	OMC	3852648	791, 800	18-3827	YAMAHA	6G8-11181-A1-00	443
18-3731	OMC	907866	795	18-3828	MERCURY MARINE	27-18937	358
18-3732	YAMAHA	95307-16900-00	454	18-3828	MERCURY MARINE	27-18937M	358
18-3732	YAMAHA	90171-16011-00	454, 461	18-3828	MERCURY MARINE	27-83899M	358
18-3733			800, 861	18-3828	MERCURY MARINE	27-98990M	358
18-3734			478	18-3828	YAMAHA	6E7-11181-00-00	443
18-3735	OMC	5030087	277	18-3828	YAMAHA	6E7-11181-A1-00	443
18-3735	SUZUKI	09204-03003	407	18-3829	YAMAHA	6J8-11181-00-00	443
18-3735	SUZUKI	09204-03004	407	18-3829	YAMAHA	6J8-11181-A1-00	443, 444
18-3735	YAMAHA	91490-40030-00	455, 461,	18-3830	YAMAHA	6H4-11181-A1-00	443
			463, 465	18-3830	YAMAHA	6H4-11181-00-00	441-443
18-3736			478	18-3831	YAMAHA	6H3-11181-01-00	443
18-3737	SUZUKI	09204-02004	407	18-3831	YAMAHA	6H3-11181-A1-00	443
18-3739			478	18-3832	YAMAHA	6E5-11181-A1-00	443
18-3740	OMC	302804	277	18-3832	YAMAHA	6E5-11181-02-00	441, 443
18-3741	OMC	309955	800	18-3834	VOLVO	833453	854
18-3742	OMC	314502	800	18-3836	OMC	329836	252, 255, 256
18-3743	OMC	320785	277	18-3837	OMC	328623	251, 255, 256
18-3744	OMC	552906	277	18-3838	OMC	331211	255
18-3744	VOLVO	3852255	861	18-3839	OMC	333670	253, 255, 256
18-3745	VOLVO	17253-6	861	18-3839	OMC	334726	253, 255, 256
18-3746			57	18-3841-2	OMC	203130	255
18-3747			57	18-3842	VOLVO	833274	854
18-3748	YAMAHA	91490-30045-00	455	18-3843	VOLVO	859155	854
18-3748			57, 455	18-3844	MERCURY MARINE	27-803508	358
18-3749	MERCURY MARINE	816685	715	18-3845	MERCURY MARINE	27-825032	358
18-3750	MERCURY MARINE	52699	882-885	18-3847	YAMAHA	6L2-11181-A2-00	443
18-3751	MERCURY MARINE	79448	380, 724	18-3847	YAMAHA	6L2-11181-A1-00	442, 443
18-3752	MERCURY MARINE	8168112	715	18-3848	YAMAHA	697-11181-A0-00	443
18-3752	MERCURY MARINE	816811-1	699, 701, 715	18-3848	YAMAHA	697-11181-A1-00	443
18-3754	MERCURY MARINE	43436	719	18-3849	YAMAHA	695-11181-A1-00	443
18-3755			728	18-3849	YAMAHA	695-11181-A0-00	442, 443
18-3756			728	18-3851	CHRYSLER FORCE	27-F286529-3	196
18-3759	MERCURY MARINE	35915	723	18-3852	CHRYSLER FORCE	27-F513529	196
18-3760	MERCURY MARINE	23-806036A1	715	18-3853	CHRYSLER FORCE	27-F691529-1	196
18-3763	OMC	322941	273, 275, 792	18-3854	CHRYSLER FORCE	27-F658529	196
18-3765	OMC	331880	882-885	18-3855	CHRYSLER FORCE	27-820438	196
18-3766	OMC	334163	271, 273,	18-3856	CHRYSLER FORCE	27-F201529-1	196
			275, 285, 799	18-3857	CHRYSLER FORCE	27-824615	197
18-3767	OMC	389455	275, 798	18-3857	CHRYSLER FORCE	27-824615-2	197
18-3768	OMC	911751	277, 791, 799	18-3857	CHRYSLER FORCE	27-F476529-4	197
18-3769	OMC	911753	791, 795	18-3857	CHRYSLER FORCE	F476529	197
18-3770	OMC	911937	791, 793	18-3857	CHRYSLER FORCE	F476529-1	197
18-3773	Yamaha	90171-10M01	454	18-3857	CHRYSLER FORCE	F476529-2	197
18-3774	SUZUKI	57630-94500	407	18-3858	CHRYSLER FORCE	27-F694529-1	197
18-3775	SUZUKI	57630-92E00	407	18-3859	CHRYSLER FORCE	27-819138-2	882-885
18-3777	SUZUKI	57630-94300	407	18-3860	CHRYSLER INBOARD	4142880	498
18-3778	SUZUKI	57630-96300	407	18-3861	MERCURY MARINE	27-18785-1	358
18-3781	YAMAHA	6H1-W4599-00-00	455	18-3862	MERCURY MARINE	27-41246-1	354, 355, 358
18-3782	YAMAHA	6G5-W4599-00-00	455	18-3863	MERCURY MARINE	27-96542-1	355, 358
18-3783	MERCURY MARINE	11-859131	728	18-3864	MERCURY MARINE	27-822844-1	358
18-3784	MERCURY MARINE	805100	728	18-3866	OMC	340115	252, 255, 256
18-3785	MERCURY MARINE	11-826711 27	728	18-3867	VOLVO	859647	854
18-3786	MERCURY MARINE	11-862907	728	18-3868	VOLVO	3583786	854
18-3787	MERCURY MARINE	805101T	728	18-3869	VOLVO	3854202	854
18-3788-9	MERCURY MARINE	14-34817	728	18-3870	VOLVO	876303	852
18-3795	SUZUKI	57633-87D30	882-885	18-3871	MERCURY MARINE	27-18786-1	358
18-3798	SUZUKI	57633-94500	882-885	18-3872	MERCURY MARINE	27-41245-3	358
18-3799	SUZUKI	57633-96300	882-885	18-3873	VOLVO	3853587	854
18-3800	OMC	325273	255	18-3874	CRUSADER	31137	535
18-3801	OMC	325647	251, 255, 256	18-3874	MERCURY MARINE	27-811546	689
18-3801	OMC	335361	251, 255, 256	18-3874	OMC	3853511	785
18-3802	OMC	327795	250, 252, 255, 256	18-3876	CRUSADER	7057500	535
18-3802	OMC	335359	250, 252, 255, 256	18-3876	GM	6269577	553
18-3803	OMC	329419	251, 255, 256	18-3876	OMC	914971	785
18-3804	MERCURY MARINE	27-19138M	358	18-3876	OMC	3853380	785

1 This product is priced per piece. To order, priced per package, please add -9 to the part number

2 Items ending in "D" are display packaged - regular number is non-display

3 For discount shop pack of 10, please add -10 to the part number

SIERRA #	O.E.M.	O.E. #	PAGE #	SIERRA #	O.E.M.	O.E. #	PAGE #
SIERRA							
18-3876	VOLVO	914971	785	18-3933	OMC	386280	242
18-3876	VOLVO	3853380	785	18-3934	YAMAHA	6E5-11610-03-00	438
18-3876	CHRIS-CRAFT	16.50-00250	491, 535, 553, 571-574, 685, 686, 689, 785, 854	18-3937	MERCURY MARINE	39-17464	676
18-3876	VOLVO	841207	491, 535, 553, 571-574, 685, 686, 689, 785, 854	18-3937	OMC	328506	781
18-3876	VOLVO	856474	491, 535, 553, 571-574, 685, 686, 689, 785, 854	18-3937	OMC	914555	781
18-3876	MERCURY MARINE	27-75611	685, 686, 689	18-3937	OMC	985083	781
18-3877	CRUSADER	30266	535	18-3937	OMC	986336	781
18-3877	MERCURY MARINE	27-13687	689	18-3937	OMC	3853268	781
18-3877	OMC	914849	785	18-3937	VOLVO	3853268	850
18-3877	CHRIS-CRAFT	16.50-00259	491, 535, 574, 686, 689, 785	18-3937	OMC	3853960	781
18-3878	CHRYSLER INBOARD	4417375	498	18-3937	VOLVO	3853960	850
18-3878	OMC	912766	785	18-3937	GM	14089025	781, 850
18-3878	MERCURY MARINE	27-13709T	687, 689	18-3938	MERCURY MARINE	39-17465	676
18-3879	CRUSADER	33408	535	18-3938	OMC	328516	781
18-3879	MERCURY MARINE	27-11986	689	18-3938	VOLVO	328516	850
18-3879	MERCURY MARINE	27-816460	689	18-3938	OMC	914557	781
18-3879	OMC	912227	785	18-3938	VOLVO	914557	850
18-3879	OMC	914930	785	18-3938	GM	14089026	781, 850
18-3879	OMC	3854299	785	18-3939	MERCURY MARINE	39-66217	676
18-3879	VOLVO	912227	854	18-3939	OMC	914556	781
18-3879	VOLVO	914930	854	18-3939	VOLVO	914556	850
18-3879	VOLVO	3854299	854	18-3939	OMC	3854252	781
18-3880	MERCURY MARINE	27-34273	689	18-3939	VOLVO	3854252	781
18-3880	MERCURY MARINE	27-810841	689	18-3940	MERCURY MARINE	39-67127	676
18-3880	OMC	311210	785	18-3940	OMC	328536	781
18-3881	MERCURY MARINE	27-47453	689	18-3940	CRUSADER	30184	882-885
18-3881	OMC	908237	785	18-3941	CRUSADER	30185	Obsolete
18-3881	MERCURY MARINE	27-72622	570, 689, 785	18-3942	MERCURY MARINE	39-67132	676
18-3883	PLEASURECRAFT	RM0032	553	18-3944	MERCURY MARINE	39-75609	676
18-3883	MERCURY MARINE	27-75647	689	18-3944	OMC	370409	781
18-3883	OMC	3853732	785	18-3944	VOLVO	370409	850
18-3883	VOLVO	3853732	854	18-3944	VOLVO	370409	850
18-3887	CRUSADER	31136	535	18-3947	OMC	439538	882-885
18-3887	MERCURY MARINE	27-850470	689	18-3948	SUZUKI	12140-93121	405
18-3887	OMC	915325	785	18-3949	OMC	436251	Obsolete
18-3887	VOLVO	3853511	854	18-3950	OMC	436251	Obsolete
18-3888			864	18-3950	SUZUKI	12410-96351-050	405
18-3889			844	18-39540	SUZUKI	12140-94400	405
18-3890			844	18-3960	YAMAHA	6H4-11610-00-00	438
18-3891	YAMAHA	61A-11181-A0-00	443	18-3961	YAMAHA	6H4-11610-10-00	882-885
18-3891	YAMAHA	61A-11181-A1-00	443	18-3962	YAMAHA	6H4-11610-20-00	882-885
18-3892	YAMAHA	676-11181-A0-00	443	18-3963	YAMAHA	6K5-11601-02-00	438
18-3892	YAMAHA	676-11181-A1-00	443	18-3966	MERCURY MARINE	39-18653A12	347, 349
18-3893			863	18-3967	MERCURY MARINE	39-18653A1	347, 349
18-3894	YAMAHA	6G5-11181-00-00	443	18-3968	MERCURY MARINE	39-18653A2	347, 349
18-3894	YAMAHA	6G5-11181-A0-00	441, 443	18-3969	YAMAHA	688-11603-A0-00	438
18-3895	OMC	332816	255	18-3970	YAMAHA	688-11604-00-00	Obsolete
18-3896	OMC	332817	255	18-3972	OMC	390082	242
18-3897	OMC	332818	882-885	18-3974	OMC	431844	882-885
18-3898	OMC	332819	255	18-3975	OMC	431870	242
18-3899	OMC	327674	261	18-3976	MERCURY MARINE	39-15320M	347
18-3901	OMC	436254	242	18-3976	YAMAHA	682-11610-01-00	438
18-39010	CHRYSLER FORCE	39-817869A1	195	18-3977	YAMAHA	682-11610-11-00	438
18-39010	CHRYSLER FORCE	FA663260	195	18-3977	MERCURY MARINE	39-18939M	882-885
18-3902	MERCURY MARINE	39-78816A12	349	18-3978	MERCURY MARINE	39-15322M	882-885
18-3903	MERCURY MARINE	39-27841A12	349	18-3979	MERCURY MARINE	39-96170A12	347
18-3904	OMC	394930	242	18-3980	MERCURY MARINE	39-96170A3	Obsolete
18-3905	OMC	396504	242	18-3981	MERCURY MARINE	39-96170A4	882-885
18-3906	OMC	385662	242	18-3982	MERCURY MARINE	39-822321A12	347, 349
18-3906	OMC	396503	242	18-3984	MERCURY MARINE	39-822321A2	882-885
18-3907	OMC	390509	242	18-3985	MERCURY MARINE	39-81095M	882-885
18-3908	OMC	390510	242	18-3986	MERCURY MARINE	39-81096M	882-885
18-3910	OMC	396377	242	18-3987	MERCURY MARINE	39-81097M	Obsolete
18-3911	OMC	396378	242	18-3988	MERCURY MARINE	39-81260M	Obsolete
18-3912	OMC	396379	242	18-3989	MERCURY MARINE	39-81261M	Obsolete
18-3913	OMC	391170	242	18-3990	MERCURY MARINE	39-81262M	Obsolete
18-3913	OMC	434107	242	18-3991	MERCURY MARINE	39-83195M	Obsolete
18-3914			242, 243	18-3992	MERCURY MARINE	39-83196M	882-885
18-3915	OMC	391416	242	18-3993	MERCURY MARINE	39-83197M	Obsolete
18-3915	OMC	434109	242	18-3994	MERCURY MARINE	39-92625M	Obsolete
18-3916	MERCURY MARINE	39-78811A12	347, 349	18-3995	MERCURY MARINE	39-92626M	Obsolete
18-3917	MERCURY MARINE	39-88392A12	347, 349	18-3996	MERCURY MARINE	39-92627M	Obsolete
18-3918	MERCURY MARINE	39-817096A6	347, 349	18-3998	CHRYSLER FORCE	39-820457A2	195
18-3919	MERCURY MARINE	39-817096A16	347, 349	18-3999	CHRYSLER FORCE	39-820641A1	882-885
18-3920	MERCURY MARINE	39-817096A26	347, 349	18-4000	CHRYSLER FORCE	39-818129A2	882-885
18-3921	MERCURY MARINE	39-93481A12	349	18-4005	VOLVO	833950	848
18-3922	MERCURY MARINE	39-78918A4	349	18-4007	VOLVO	845261	841
18-3923	MERCURY MARINE	39-85636A4	349	18-4008	MERCURY MARINE	60207	668
18-3924	MERCURY MARINE	39-18487A12	349	18-4009	OMC	910384	776
18-3925	MERCURY MARINE	39-815267A4	349	18-4009	MERCURY MARINE	60252A2	653, 657, 659, 661, 668
18-3927	MERCURY MARINE	39-813011A12	349	18-4010	MERCURY MARINE	765-7442T32	Obsolete
18-3928	MERCURY MARINE	39-74381A1	676	18-40110	SUZUKI	12110-94400	405
18-3931	OMC	386279	242	18-4013	MERCURY MARINE	765-7443A11	349
18-39320	YAMAHA	6R5-11603-00	438	18-4014	MERCURY MARINE	765-7446A11	882-885
				18-40140	SUZUKI	12110-93120	405
				18-4017	MERCURY MARINE	783-9613A2	347
				18-4018	MERCURY MARINE	783-9613A3	347
				18-4019	MERCURY MARINE	39-19721A6	347, 349
				18-4020	MERCURY MARINE	39-19721A1	882-885
				18-4021	MERCURY MARINE	39-19721A2	882-885
				18-4022	MERCURY MARINE	26-75988	683

1 This product is priced per piece. To order, priced per package, please add -9 to the part number
 2 Items ending in "D" are display packaged - regular number is non-display
 3 For discount shop pack of 10, please add -10 to the part number

SIERRA #	O.E.M.	O.E. #	PAGE #	SIERRA #	O.E.M.	O.E. #	PAGE #
SIERRA							
18-4023	MERCURY MARINE	26-75413	683	18-4135	MERCURY MARINE	761-7982M	347
18-4024	MERCURY MARINE	26-97664	683	18-4135	MERCURY MARINE	761-7982T	347
18-4024	OMC	914445	789	18-4135	YAMAHA	6E7-11631-00-97	438
18-4024	OMC	3853226	789	18-4136	YAMAHA	6E7-11635-00-00	438
18-4024	VOLVO	914445	851	18-4136	MERCURY MARINE	761-8022M	882-885
18-4024	VOLVO	3853226	851	18-4138	MERCURY MARINE	761-8484M	347
18-4029	VOLVO	463377	847	18-4138	YAMAHA	689-11631-00-95	438
18-4031	VOLVO	1306630	851	18-4141	YAMAHA	6H4-11631-00-96	438
18-4035	MERCURY MARINE	29-20046T	Obsolete	18-4142	YAMAHA	6H4-11635-01-00	438
18-4036	MERCURY MARINE	29-47270	350	18-4143	YAMAHA	6H4-11636-00-00	438
18-4037	MERCURY MARINE	29-71422	350	18-4144	YAMAHA	61N-11631-00-95	882-885
18-4038	MERCURY MARINE	31-62596A1	350	18-4145	YAMAHA	61N-11635-00-00	882-885
18-4039	MERCURY MARINE	31-17514A2	350	18-4146	YAMAHA	61N-11636-00-00	438
18-4040	OMC	387139	245	18-4148-1	OMC	394488	244
18-4040	OMC	387142	245	18-4148-1	OMC	5004705	244
18-4044	VOLVO	834548	847	18-4150	VOLVO	812994	844
18-4044	VOLVO	966694-2	837, 847	18-4156	MERCURY MARINE	776-9096A1	882-885
18-4046	VOLVO	958498	812, 813, 837, 847	18-4157	YAMAHA	6R5-11650-10-00	439
18-4046	VOLVO	966857	812, 813, 837, 847	18-4160	MERCURY MARINE	733-3818	676
18-4050	MERCURY MARINE	39-827179A12	349	18-4160	OMC	915236	781
18-4051	MERCURY MARINE	39-826293A12	882-885	18-4160	VOLVO	915236	781, 850
18-4052	MERCURY MARINE	39-826297A12	882-885	18-4160	OMC	3853477	781, 850
18-4056	OMC	436243	Obsolete	18-4160	VOLVO	3853477	781, 850
18-4058			244	18-4161	MERCURY MARINE	733-3819	676
18-4060	OMC	439521	Obsolete	18-4161	MERCURY MARINE	733-803850T	676
18-4061	OMC	387660	242	18-4161	OMC	914816	781, 850
18-4062	OMC	387661	242	18-4161	VOLVO	914816	781, 850
18-4063	OMC	394461	242	18-4161	OMC	3853340	781, 850
18-4063	OMC	437409	242, 243	18-4161	VOLVO	3853340	781, 850
18-4064	OMC	398483	242	18-4164	MERCURY MARINE	735-6371	676
18-4065	OMC	432072	242	18-4164	MERCURY MARINE	735-850098	676
18-4065	OMC	432969	242	18-4164	MERCURY MARINE	735-9687	676
18-4066	OMC	432073	242	18-4164	OMC	3911023	781, 850
18-4066	OMC	432970	242	18-4164	VOLVO	3911023	781, 850
18-4067	OMC	432077	242	18-4164	GM	14077949	781, 850
18-4067	OMC	433003	242	18-4165	OMC	439515	882-885
18-4068	OMC	432078	242	18-4173	MERCURY MARINE	735-6370	676
18-4068	OMC	433004	242	18-4173	MERCURY MARINE	735-808674	676
18-4069	OMC	432803	242	18-4173	MERCURY MARINE	735-850097	676
18-4075	OMC	308186	244	18-4173	MERCURY MARINE	735-9686	676
18-4076	OMC	330081	244	18-4173	OMC	3911020	781, 850
18-4077	YAMAHA	93310-730V8-00	439	18-4173	VOLVO	3911020	781, 850
18-4078	YAMAHA	93310-836V2-00	439	18-4173	GM	14077948	781, 850
18-4079	OMC	436859	242	18-4178	MERCURY MARINE	735-9715	676
18-4080	YAMAHA	6R5-11642-11-93	438	18-4180	MERCURY MARINE	736-2343	676
18-4081	YAMAHA	6R5-11631-11-93	438	18-4181	MERCURY MARINE	735-6538	882-885
18-4082	YAMAHA	6R5-11645-11-00	438	18-4183			677, 781, 850
18-4083	YAMAHA	6R5-11635-11-00	438	18-4188			677, 678, 781, 850
18-4084	YAMAHA	6R5-11646-11-00	438	18-4190	OMC	436860	242
18-4085	YAMAHA	6R5-11636-11-00	438	18-4194	OMC	3852350	800, 861
18-4086	OMC	439516	242	18-4194	VOLVO	3852350	800, 861
18-4087	OMC	439517	882-885	18-4195	OMC	439015	242
18-4088	OMC	436353	244	18-4197	OMC	334665	882-885
18-4089			882-885	18-4200	VOLVO	477024	848
18-4090	OMC	436354	882-885	18-4201	VOLVO	192212	848
18-4091	YAMAHA	6H3-11631-01-96	438	18-4204	VOLVO	826341	860
18-4093	YAMAHA	6H3-11636-01-00	438	18-4204	VOLVO	876278	860
18-4096	YAMAHA	6K5-11636-03-00	882-885	18-4205	VOLVO	832820	860
18-4097	YAMAHA	6H1-11631-03-95	438	18-4206	VOLVO	832570	860
18-4099	YAMAHA	6H1-11636-03-00	438	18-4208	VOLVO	839423	860
18-4100	OMC	396585	242	18-4209	VOLVO	839534	860
18-4100	OMC	396588	242	18-4210	VOLVO	850785	860
18-4101	OMC	391653	242	18-4210	VOLVO	854045	860
18-4102	OMC	393612	242	18-4211	VOLVO	850888	860
18-4103	OMC	396587	243	18-4212	VOLVO	850889	861
18-4104	OMC	396583	242	18-4213	VOLVO	851261	861
18-4105	OMC	396581	242	18-4213	VOLVO	854047	861
18-4107	OMC	392621	242	18-4214	PLEASURECRAFT	RO96081	553
18-4109	MERCURY MARINE	759-80661A7	676	18-4214	VOLVO	897367	861
18-4109	MERCURY MARINE	778-9441A3	676	18-4215	VOLVO	941816	861
18-4110			242-244	18-4216	VOLVO	807036	843
18-4111			242-244	18-4217	VOLVO	82744	843
18-4112			242-244	18-4218	MERCURY MARINE	22-16951A1	671
18-4113			242-244	18-4218	MERCURY MARINE	22-16951T1	671
18-4114	OMC	387285	242	18-4218	MERCURY MARINE	22-87238	671
18-4115			242, 243	18-4218	OMC	379957	776
18-4117			242, 243	18-4218	VOLVO	82745	843
18-4118			677, 678	18-4218	MERCURY MARINE	22-16951Q1	490, 508, 533, 552, 671, 776, 843
18-4120	OMC	393271	242				
18-4120	OMC	393924	242	18-4218			490, 508, 533, 552, 671, 776, 843
18-4122	OMC	393566	243				
18-4123	OMC	392455	242	18-4219	VOLVO	829592	843
18-4124	OMC	387284	242	18-4220	MERCURY MARINE	12-835467 1	382
18-4125	OMC	391798	Obsolete	18-4220	PLEASURECRAFT	RO96116	553
18-4128	YAMAHA	6G5-11642-00-93	438	18-4220	MERCURY MARINE	13171	382
18-4129	YAMAHA	6G5-11631-00-93	438	18-4220	MERCURY MARINE	77987	382
18-4130			438, 439	18-4221	MERCURY MARINE	75282A1	382
18-4131			882-885	18-4221	MERCURY MARINE	13191A1	371, 382
18-4133	YAMAHA	6G5-11636-00-00	882-885	18-4222	OMC	318841	800
18-4134	MERCURY MARINE	759-80661A8	676	18-4222	OMC	127084	800
18-4134	MERCURY MARINE	778-9441A5	676	18-4223	OMC	333592	277

1 This product is priced per piece. To order, priced per package, please add -9 to the part number

2 Items ending in "D" are display packaged - regular number is non-display

3 For discount shop pack of 10, please add -10 to the part number

SIERRA #	O.E.M.	O.E. #	PAGE #	SIERRA #	O.E.M.	O.E. #	PAGE #
SIERRA							
18-4224	MERCURY MARINE	22-806926A1	671	18-4321	OMC	398047	252
18-4226	MERCURY MARINE	22-806608A1	671	18-4322	OMC	432570	252
18-4227	MERCURY MARINE	22-806926	671	18-4323	OMC	436891	253
18-4228	OMC	315810	800	18-4325	MERCURY MARINE	27-85491A90	355
18-4229	OMC	319890	277	18-4326	MERCURY MARINE	27-43779A87	353
18-4230	OMC	320305	277	18-4329			248
18-4231	OMC	320570	277	18-4330			248
18-4232	OMC	323943	277	18-4331			248
18-4233	MERCURY MARINE	73345A1	369, 382	18-4332			248
18-4234	VOLVO	832965	860	18-4334	MERCURY MARINE	27-41499A87	353, 359
18-4236	VOLVO	941907	844	18-4336	MERCURY MARINE	27-43004A99	353, 359
18-4238	VOLVO	943218	861	18-4337	MERCURY MARINE	27-812867A97	354, 359
18-4239	VOLVO	897873	861	18-4338	MERCURY MARINE	27-814754A00	882-885
18-4241	VOLVO	951924	861	18-4339	MERCURY MARINE	27-14697A87	354, 359
18-4245	VOLVO	463902	848	18-4340	MERCURY MARINE	27-13461A99	354, 359
18-4246	VOLVO	463903-5	848	18-4341	VOLVO	876380	852
18-4247	VOLVO	463904	848	18-4342	VOLVO	876376	852
18-4248	OMC	311598	789	18-4346	CHRYSLER INBOARD	3745220	501, 505, 507
18-42481-9	OMC	311598	276, 789	18-4347-1			684
18-4249	OMC	318544	277	18-4348			684
18-4250	OMC	911820	789	18-4349			576, 577, 684
18-4251	OMC	908062	794, 795	18-4351	MERCURY MARINE	27-64203A75	356
18-4252	MERCURY MARINE	24-46312	733	18-4352	MERCURY MARINE	27-69524A75	359
18-4253-9	OMC	336982	269, 276, 789	18-4353	MERCURY MARINE	27-72486A32	356
18-42531-9	OMC	336982	276, 789	18-4354	MERCURY MARINE	27-73645A87	356
18-4254	VOLVO	814219	861	18-4355	MERCURY MARINE	27-78028A78	357
18-4255	OMC	307551	277	18-4356	MERCURY MARINE	27-85653A87	357
18-4256			135	18-4357	MERCURY MARINE	27-88449A32	357
18-4257			490, 508, 533, 552, 668, 776, 843	18-4359	MERCURY MARINE	27-815791A92	358
18-4258	MERCURY MARINE	22-41622	668	18-4360			501, 505-507
18-4258			490, 508, 525, 529, 533, 552, 557, 559, 561, 563, 667, 668, 776, 843	18-4361			501, 505-508
18-4258	MERCURY MARINE	22-33198A1	563, 668	18-4362	BARR	MC20-60426P	668
18-4259	VOLVO	804261	857	18-4363	BARR	FM-1-83-P	490, 532, 551, 561, 562, 668, 777
18-4261	MERCURY MARINE	19643	366	18-4364	BARR	20-0082-P	490, 508, 532, 539, 551, 557, 559, 561, 562, 668, 776, 777, 841
18-4263	MERCURY MARINE	22-32802	668	18-4365	MERCURY MARINE	27-801855	686
18-4263	MERCURY MARINE	22-328022	668	18-4366	MERCURY MARINE	27-72479A5	687, 688
18-4263			490, 508, 533, 552, 667, 668, 776, 843	18-4367	MERCURY MARINE	27-99777A1	684
18-4264	MERCURY MARINE	22-32803	668	18-4369			784
18-4264			84, 135, 332, 421, 490, 508, 533, 552, 625, 668, 765, 776, 843	18-4370			784
18-4265	MERCURY MARINE	22-428611	668	18-4371			784
18-4267	MERCURY MARINE	12-29395	695	18-4373			784
18-4270	MERCURY MARINE	12-36001	373, 632, 633, 695, 703, 705	18-4374			784
18-4272	MERCURY MARINE	19-32652	695	18-4375	MERCURY MARINE	27-34213A2	688
18-4273	MERCURY MARINE	19-42682	695	18-4376	MERCURY MARINE	27-34895A2	685
18-4274	YAMAHA	688-45997-01-00	453	18-4377	MERCURY MARINE	27-42457A1	688
18-4275	MERCURY MARINE	12-29245	366	18-4378	MERCURY MARINE	27-54529A1	688
18-4276	OMC	324334	236, 257	18-4380	MERCURY MARINE	27-68714A6	688
18-4277	OMC	324430	882-885	18-4381	MERCURY MARINE	27-43186A1	687
18-4280	OMC	327861	242	18-4382	MERCURY MARINE	27-74830A3	687
18-42850	SUZUKI	12151-94400	405	18-4383			685
18-42860	SUZUKI	12151-93100	405	18-4384			685
18-4287			882-885	18-4385			686
18-42870	SUZUKI	12151-92502	405	18-4386			685
18-4288	MERCURY MARINE	23-807073	733	18-4387	MERCURY MARINE	27-801853	686
18-4289	MERCURY MARINE	53-805272	733	18-4388	MERCURY MARINE	27-11977A88	686
18-4290	OMC	317831	242	18-4388	MERCURY MARINE	27-11977A92	686
18-4292	OMC	326765	242	18-4389	MERCURY MARINE	27-47453A1	686
18-4294	MERCURY MARINE	40-52035	347	18-4391	MERCURY MARINE	27-64763A2	686
18-42940-9	SUZUKI	09381-14001	405	18-4392	MERCURY MARINE	27-75611A2	686
18-4295	MERCURY MARINE	53-29641	724	18-4394	MERCURY MARINE	27-33395A2	684
18-42950-9	SUZUKI	09381-18002	405	18-4395	MERCURY MARINE	27-35898A4	685
18-4296	MERCURY MARINE	35983	699, 701, 715	18-4396	MERCURY MARINE	27-46401A1	685
18-42960-9	SUZUKI	09381-20003	405	18-4397	MERCURY MARINE	27-46820A1	685
18-4300	OMC	385416	249	18-4398	MERCURY MARINE	27-53354A1	685
18-4301	OMC	388602	249	18-4399	MERCURY MARINE	27-54566A1	685
18-4302	OMC	390078	250	18-4400	YAMAHA	61A-W0001-01-00	441
18-4303-1	OMC	389556	250	18-4400	YAMAHA	61A-W0001-A1-00	441
18-4303-1	OMC	391300	250	18-4402	OMC/Bombardier	437779	253
18-4304-1	OMC	391988	250	18-4403	YAMAHA	6F3-W0001-04-00	441
18-4305	OMC	393433	250	18-4403	YAMAHA	6F3-W0001-A4-00	441
18-4306	OMC	394546	251	18-4404	YAMAHA	6G5-W0001-03-00	441
18-4307	OMC	392567	251	18-4404	YAMAHA	6G5-W0001-A3-00	441
18-4307	OMC	392615	251	18-4405	YAMAHA	6H1-W0001-00-00	441
18-4307	OMC	433941	251	18-4405	YAMAHA	6H1-W0001-01-00	441
18-4309	OMC	394885	251	18-4405	YAMAHA	6H1-W0001-A0-00	441
18-4309	OMC	434381	251	18-4406	OMC/Bombardier	437155	253
18-4310	OMC	396750	251	18-4407	YAMAHA	6H4-W0001-01-00	441
18-4312			195, 196	18-4407	YAMAHA	6H4-W0001-A1-00	441
18-4313			196	18-4408	CRUSADER	33393	534
18-4314			196	18-4408	MERCURY MARINE	27-11977	684
18-4317	MERCURY MARINE	27-90484A88	355	18-4408	OMC	912978	784
18-4318	OMC	390076	252	18-4408	VOLVO	3850379	842
18-4319	MERCURY MARINE	27-11338A88	355	18-4409	YAMAHA	6H4-W0001-03-00	441
18-4319	MERCURY MARINE	27-89221A88	355	18-4409	YAMAHA	6H4-W0001-04-00	441
				18-4410	YAMAHA	6K7-W0001-04-00	882-885
				18-4411	YAMAHA	6N6-W0001-03-00	441
				18-4411	YAMAHA	6N6-W0001-A3-00	441
				18-4412	YAMAHA	6R3-W0001-03-00	441

1 This product is priced per piece. To order, priced per package, please add -9 to the part number
 2 Items ending in "D" are display packaged - regular number is non-display
 3 For discount shop pack of 10, please add -10 to the part number

SIERRA #	O.E.M.	O.E. #	PAGE #	SIERRA #	O.E.M.	O.E. #	PAGE #
SIERRA							
18-4412	YAMAHA	6R3-W0001-A3-00	441	18-4502			566, 675, 780, 849
18-4413	YAMAHA	6R6-W0001-01-00	442	18-4503			566
18-4415	YAMAHA	688-W0001-00-00	442	18-4504			567
18-4415	YAMAHA	688-W0001-A0-00	442	18-4505	MERCURY MARINE	774-9137A12	347
18-4417	YAMAHA	695-W0001-01-00	442	18-4505	MERCURY MARINE	776-8896A3	347
18-4417	YAMAHA	695-W0001-02-00	442	18-4506			567
18-4417	YAMAHA	695-W0001-A2-00	442	18-4507			567
18-4418	YAMAHA	697-W0001-00-00	442	18-4508			567
18-4418	YAMAHA	697-W0001-A0-00	442, 444	18-4511			568
18-4419	YAMAHA	6H4-W0001-02-00	442	18-4512			568
18-4419	YAMAHA	6H4-W0001-A2-00	442	18-4513			568
18-4420	OMC/Bombardier	439202	253	18-4514			568
18-4421	OMC/Bombardier	5000400	253	18-4515	MERCURY MARINE	774-9137A10	347
18-4422	YAMAHA	6L2-W0001-01-00	442	18-4516			568
18-4422	YAMAHA	6L2-W0001-02-00	442	18-4517			568
18-4422	YAMAHA	6L2-W0001-A2-00	442	18-4518			568
18-4427	YAMAHA	6H3-W0001-A0-00	443	18-4519			568
18-4428	OMC/Bombardier	437725	253	18-4520	MERCURY MARINE	774-9137A13	347
18-4429	OMC/Bombardier		253	18-4520	MERCURY MARINE	776-8897A2	347
18-4431	OMC	913783	786	18-4521			568
18-4431	VOLVO	3850496	786, 858	18-4522			568
18-4442	MERCURY MARINE	91-57797A3	721	18-4523			568
18-4442			172	18-4530	MERCURY MARINE	774-9137A11	347
18-4444			200, 381, 553,	18-4530	MERCURY MARINE	774-9096A1	348, 677
			729, 800	18-4535	MERCURY MARINE	774-9137A14	347
18-4444	MERCURY MARINE	91-95830A1	381, 729	18-4535	MERCURY MARINE	776-8898A2	347
18-4446			200, 381, 553, 729	18-4540			348, 349
18-4454			173	18-4560	MERCURY MARINE	765-7443A2	349
18-4455			173	18-4560	MERCURY MARINE	765-7443A12	348, 349
18-4456	MERCURY MARINE	34765A2	737	18-4565	MERCURY MARINE	766-8667A36	882-885
18-4456			99, 487, 498,	18-4565	MERCURY MARINE	766-8667A43	882-885
			521, 553, 737	18-4575			349
18-4456	MERCURY MARINE	34765A1	99, 737	18-4580			882-885
18-4457			99, 487, 498,	18-4620	MERCURY MARINE	780-9229A7	347
			521, 553, 737	18-4621	MERCURY MARINE	780-9229A10	347
18-4457	MERCURY MARINE	12644A1	99, 737	18-4622	MERCURY MARINE	780-9229A11	347
18-4458			99, 487, 498,	18-4623	MERCURY MARINE	777-815965T4	347
			521, 553, 737	18-4624	MERCURY MARINE	777-815965A5	347
18-4459	MERCURY MARINE	91-859046Q4	729	18-4625	MERCURY MARINE	777-815965A6	347
18-4459	MERCURY MARINE	91-821887A-1	381, 729	18-4626	MERCURY MARINE	2704-826191T4	347
18-4461			490, 501, 503, 505, 508,	18-4627	MERCURY MARINE	2704-821896A3	347
			523, 525, 527, 529,	18-4628	MERCURY MARINE	2704-821896A4	347
			533, 550, 553, 557,	18-4629	CHRYSLER FORCE	700-834794T3	195
			559, 561, 563, 651,	18-4630	CHRYSLER FORCE	700-834794A4	195
			655, 663, 671,	18-4631	CHRYSLER FORCE	700-834794A5	195
			774, 776, 843	18-4632	CHRYSLER FORCE	700-834800A4	195
18-4461	MERCURY MARINE	22-807155	563, 671	18-4633	CHRYSLER FORCE	700-834800A5	195
18-4462			330, 425	18-4634	CHRYSLER FORCE	700-834800A6	195
18-4463	VOLVO	833188	847	18-4635	MERCURY MARINE	785-9737T9	349
18-4464	VOLVO	829620	847	18-4636	MERCURY MARINE	785-9738T9	349
18-4465	VOLVO	3582609	847	18-4637	MERCURY MARINE	785-9737A10	349
18-4466	VOLVO	838637	847	18-4638	MERCURY MARINE	785-9738T10	349
18-4467	VOLVO	1542472	847	18-4639	MERCURY MARINE	700-858294T1	882-885
18-4468	VOLVO	419734	847	18-4640	MERCURY MARINE	700-858295T1	882-885
18-4469	VOLVO	1542389	847	18-4641	MERCURY MARINE	700-878571A2	882-885
18-4470	VOLVO	419735	847	18-4642	MERCURY MARINE	700-878572A2	882-885
18-4471	VOLVO	838638	847	18-4643	MERCURY MARINE	700-878573A2	882-885
18-4472	VOLVO	1218630	847	18-4644	MERCURY MARINE	700-878574A2	882-885
18-4473	VOLVO	419653	847	18-4697			843
18-4473	VOLVO	35882561	847	18-4698	MERCURY MARINE	27-81987M	366
18-4474	VOLVO	419652	847	18-4698	YAMAHA	90430-08020-00	453
18-4474	VOLVO	3582606	847	18-46981-9	MERCURY MARINE	27-81987M	366
18-4484	OMC	985080	780	18-46981-9	YAMAHA	90430-08020-00	453
18-4484			567, 675, 780, 849	18-4699			843
18-4485	MERCURY MARINE	938-883490 1	567, 675, 780, 849	18-4712			244, 246
18-4485			567, 675, 780, 849	18-4726			569
18-4486	MERCURY MARINE	938-803860T	567, 675	18-4727			569
18-4486	MERCURY MARINE	938-883297 1	567, 675, 780, 849	18-4728			569
18-4486			567, 675, 780, 849	18-4729			569
18-4489	MERCURY MARINE	936-5544	567, 675	18-4730			569
18-4489	MERCURY MARINE	936-810840	567, 675	18-4731			569
18-4489	MERCURY MARINE	936-986767	567, 675, 780, 849	18-4732			569
18-4489			567, 675, 780, 849	18-4733			569
18-4491	MERCURY MARINE	938-827178 1	568, 675, 780, 849	18-4734			569
18-4491			568, 675, 780, 849	18-4735			569
18-4492	MERCURY MARINE	35329	567, 676	18-4736			569
18-4495	MERCURY MARINE	949-4057	568, 675	18-4737			569
18-4495	MERCURY MARINE	949-5798	568, 675	18-4749-9	OMC	3852568	791, 792
18-4495	OMC	986086	568, 675, 780, 849	18-4750	OMC	983967	791, 799
18-4495	OMC	988163	568, 675, 780, 849	18-4800	OMC	5004632	276
18-4495	OMC	3854339	568, 675, 780, 849	18-4801	OMC	5000356	276
18-4495	VOLVO	3854339	568, 675, 780, 849	18-4802	OMC	5005401	276
18-4495	VOLVO	3853894	568, 675, 780, 849	18-4804	OMC	984770	792
18-4496	MERCURY MARINE	949-5913	Obsolete	18-4804	OMC	986381	792
18-4496	MERCURY MARINE	949-6560	Obsolete	18-4805	OMC	984771	792
18-4496	OMC	986085	Obsolete	18-4805	OMC	986382	792
18-4496	OMC	987970	Obsolete	18-4806	OMC	984765	792
18-4496	OMC	3858868	Obsolete	18-4806	OMC	986380	792
18-4496	VOLVO	3854214	Obsolete	18-4807	OMC	439476	280, 285
18-4496	VOLVO	3858867	Obsolete	18-4818	OMC	397087	285
18-4501			568, 675, 780, 849	18-4826	OMC	331999	276

1 This product is priced per piece. To order, priced per package, please add -9 to the part number
 2 Items ending in "D" are display packaged - regular number is non-display
 3 For discount shop pack of 10, please add -10 to the part number

SIERRA #	O.E.M.	O.E. #	PAGE #	SIERRA #	O.E.M.	O.E. #	PAGE #
SIERRA							
18-4828	OMC	911750	791, 799	18-5169	CHRYSLER FORCE	F12042-1	185
18-4830	MERCURY MARINE	1667-9011G59	379	18-5169	MERCURY MARINE	394-1130A1	302, 303
18-4832	MERCURY MARINE	1647-9148T93	379	18-5170	OMC	583740	210
18-4833	OMC	915720	768	18-5172	OMC	581786	210
18-4835	OMC	912029	791, 795	18-5176	OMC	582366	210
18-4837	OMC	911734	768, 791	18-5176	OMC	583737	210
18-4840	OMC	435277	276	18-5176	OMC	584561	210
18-4841	OMC	435276	276	18-5178	MERCURY MARINE	398-173	303
18-4842	OMC	435280	882-885	18-5179	OMC	582508	210
18-4843	OMC	435279	276	18-5180	MERCURY MARINE	392-825101T	303
18-4850	MERCURY MARINE	1667-9011R6	379	18-5181	OMC	582995	210, 303
18-4851	MERCURY MARINE	1647-9148R84	379	18-5181	OMC	584477	210, 303
18-4858-9	MERCURY MARINE	12-45176	365	18-5181	MERCURY MARINE	802371A1	303
18-4901			173, 264	18-5182	MERCURY MARINE	823033	303
18-4904			173, 264	18-5183	Yamaha	63V-85520-00	307, 410
18-4911	OMC	772577	263	18-5185	MERCURY MARINE	16064A1	303
18-4911	OMC	322236	173, 264	18-5185		815113T02	303, 304
18-4913	OMC	772578	264	18-5186	CHRYSLER FORCE	339-7370B13	185
18-4913	OMC	316705	173, 264	18-5186	CHRYSLER FORCE	339-832757B4	185
18-4914	OMC	772579	264	18-5186	MERCURY MARINE	339-832757A4	303
18-4914	OMC	316706	173, 264	18-5186	CHRYSLER FORCE	339-7370A13	185, 303
18-4915	MERCURY MARINE	50-12066A9	366	18-5186	MERCURY MARINE	339-7370A13	185, 303
18-4915	MERCURY MARINE	50-12066Q9	366	18-5187	MERCURY MARINE	339-85699A1	303
18-500-1212			100	18-5192	OMC	582091	210
18-500-1238			100	18-5193	OMC	582382	210
18-500-1414			100	18-5194	OMC	582160	210
18-500-1418			100	18-5194	OMC	584632	210
18-500-3812			882-885	18-5195	Yamaha	689-81311-40	410
18-500-3814			100	18-5196	OMC	502880	210
18-500-3818			100	18-5196	OMC	581407	210
18-500-3838			100	18-5199	OMC	580321	209
18-500-5614			100	18-5200	OMC	580256	743
18-500-5618			100	18-5205	OMC	581419	209
18-500-5834			Obsolete	18-5206	MERCURY MARINE	398-693	302, 303
18-500-5838			100	18-5207	MERCURY MARINE	398-713	303
18-5001	OMC	172525	743	18-52104			164
18-5002	OMC	172523	209	18-52204			164
18-5003	OMC	172806	209	18-5224			187, 201, 215, 308, 394, 397, 411, 481, 495, 515, 545, 598, 752, 821
18-5006	OMC	172522	209				
18-5007			302, 305				
18-5011	OMC	172521	209	18-5224	OMC	510364	752
18-5012			302, 305	18-5224	MERCURY MARINE	20121	308
18-5013			185, 186	18-5225			187, 201, 215, 300, 308, 394, 397, 411, 481, 495, 515, 545, 598, 751, 821
18-502-1234			100				
18-502-1278			100				
18-502-1412			100	18-5225	MERCURY MARINE	84-813706A26	187, 201, 215, 300, 308, 394, 397, 411, 481, 495, 515, 545, 598, 751, 821
18-502-1476			100				
18-502-3834			882-885				
18-502-3858			100				
18-502-5612			100				
18-502-5658			100	18-5225	MERCURY MARINE	84-99215A26	187, 201, 215, 300, 308, 394, 397, 411, 481, 495, 515, 545, 598, 751, 821
18-5021	MERCURY MARINE	805629	668				
18-5102	CHRYSLER INBOARD	3656017	494				
18-5103	CHRYSLER INBOARD	3780600	494				
18-5105	CHRYSLER INBOARD	3874020	494				
18-5107-1	CRUSADER	7243110	516	18-5226	OMC	510883	215
18-5107-1	MERCURY MARINE	811637001	588	18-5226	OMC	772584	215
18-5107-1	OMC	3854003	744	18-5226			187, 201, 215, 300, 308, 394, 397, 411, 481, 495, 515, 545, 598, 752, 821
18-5107-1	VOLVO	3854003	744				
18-5108	MERCURY MARINE	811639	588				
18-5108	OMC	986642	743				
18-5108			516, 588, 744, 817	18-5227-1	MERCURY MARINE	84-813715A1	307
18-5108	MERCURY MARINE	811639T	516, 588, 744, 817	18-5228-1	MERCURY MARINE	84-813715A1	307
18-5108	OMC	3854001	744	18-5228-1			187, 307
18-5108	VOLVO	3854001	744	18-5229-9-1			187, 215, 307
18-5110	YAMAHA	6E5-85570-11-00	410	18-5230-9-1			187, 215, 307
18-5111	YAMAHA	697-85570-11-00	410	18-5231-1	OMC	582365	215
18-5112	YAMAHA	680-85570-09-00	410	18-5238	CHRYSLER FORCE	F12139-1	Obsolete
18-5112	YAMAHA	6E7-85570-19-00	410	18-5241	CHRYSLER FORCE	F12181-1	185
18-5116-1	MERCURY MARINE	87-861780A2	588	18-5241	MCCULLOCH	38850115	300
18-5116-1	MERCURY MARINE	87-861780Q4	588	18-5243	MERCURY MARINE	888731	586
18-5117	GM	10482803	588	18-5243	MERCURY MARINE	898253T23	586
18-5128	YAMAHA	6R3-85570-01-00	410	18-5244	PLEASURECRAFT	RA108009	542
18-5130	Yamaha	688-85540-16	410	18-5244	MERCURY MARINE	884792	586
18-5131	Mercury	43077T	410	18-5244	MERCURY MARINE	898253T22	542, 586, 594, 595
18-5131	Yamaha	695-85540-12	410	18-5245	PLEASURECRAFT	R103011	541
18-5132	Yamaha	63V-85540-01	410	18-5245	MERCURY MARINE	884790	586
18-5139	MERCURY MARINE	336-4318A2	302	18-5245	MERCURY MARINE	898253013	586
18-5140	MERCURY MARINE	398-2202	303	18-5246	MERCURY MARINE	898253T28	584
18-5141	OMC	581207	209	18-5247	MERCURY MARINE	898253T29	584
18-5148	MERCURY MARINE	394-1100A3	302, 303	18-5248	OMC	3854217	744
18-5149	CHRYSLER FORCE	F12044	185	18-5248	VOLVO	3854217	744
18-5150	CHRYSLER FORCE	817764A2	185	18-5250	MERCURY MARINE	34235Q1	584
18-5150	CHRYSLER FORCE	FA305310-2	185	18-5250	MERCURY MARINE	34235T1	584
18-5153	MCCULLOCH	1340135	300	18-5250	OMC	175257	479, 509, 584, 593, 742, 750
18-5153	MCCULLOCH	36550135	300				
18-5153	MCCULLOCH	75101A	300	18-5250			479, 509, 584, 593, 742, 750
18-5153	MERCURY MARINE	398-174	302, 303				
18-5156	OMC	580148	209	18-5251	OMC	173619	742
18-5157	OMC	580290	743	18-5251			479, 483, 492, 509
18-5163	OMC	581130	210				

1 This product is priced per piece. To order, priced per package, please add -9 to the part number
 2 Items ending in "D" are display packaged - regular number is non-display
 3 For discount shop pack of 10, please add -10 to the part number

SIERRA #	O.E.M.	O.E. #	PAGE #	SIERRA #	O.E.M.	O.E. #	PAGE #
SIERRA							
18-5252			479, 509, 517, 584, 593, 594, 742, 750	18-5310			480, 492, 512
18-5253			584	18-5310	CRUSADER	12525	480
18-5254			584	18-5310	MERCURY MARINE	33700	585
18-5255			479, 484, 492, 509, 540, 545	18-5310	OMC	380543	743
18-5256	OMC	172531	742	18-5311	MERCURY MARINE	34235T	585
18-5256			479, 510	18-5311	CHRIS-CRAFT	16.69-00049	480, 492, 512
18-5257			811, 815	18-5311			480, 492, 512
18-5258	OMC	173690	742	18-5311	MERCURY MARINE	34235	585
18-5258	OMC	987925	742	18-5311	OMC	380538	743
			479, 492, 495, 510, 517, 584, 593, 595, 742, 750, 751	18-5312	MALLORY	YL554CV	543, 592, 749
18-5259			479, 484, 492, 495, 510, 517	18-5312	OMC	981080	749
18-5260	OMC	173829	742	18-5313	CRUSADER	37061	515
18-5260			479, 484, 492, 495, 510, 517	18-5313	MERCURY MARINE	17177A1	592
18-5264			812, 813, 815	18-5313	OMC	985560	749
18-5265			815	18-5313	MALLORY	YL624AV	592
18-5266			565	18-5313	MALLORY	YL624MW	483, 515, 543, 749
18-5267			584	18-5314	CHRIS-CRAFT	16.69-00039	480
18-5268			479, 536, 584, 742	18-5314	CHRYSLER INBOARD	2421820	492
18-5269			479, 510, 584, 742	18-5314	MERCURY MARINE	391-898253004	585
18-5270			510, 517, 584, 594, 742, 750	18-5314	VOLVO	835304	815
18-5271			479, 510	18-5314	CRUSADER	20117	480
18-5272			479, 510	18-5314	PLEASURECRAFT	R114001	540, 541
18-5273	MERCURY MARINE	805759Q3	585	18-5314	PLEASURECRAFT	R114004	540, 541
18-5273	MERCURY MARINE	805759T3	585	18-5314	MERCURY MARINE	391-5090	585
18-5274			585, 593	18-5314	OMC	382135	743
18-5275			479, 484, 510, 517	18-5315	MERCURY MARINE	87581	592
18-5276			536, 541, 585, 743	18-5315	MALLORY	YL673AV	592, 749
18-5277			479, 484, 511, 517	18-5317			541, 545, 584, 586, 593-596
18-5278	MERCURY MARINE	850484T3	585	18-5317	MERCURY MARINE	64850	586
18-5278			536, 541, 585, 743	18-5317	MERCURY MARINE	87-71831	586
18-5279			511, 536, 743	18-5318	CRUSADER	3000124	511
18-5280	MERCURY MARINE	811635Q2	585	18-5318	MERCURY MARINE	898253007	586
18-5280			511, 536, 585, 593, 743, 865	18-5318	MERCURY MARINE	58033	586
18-5281	MERCURY MARINE	808483Q2	585	18-5319	VOLVO	243801	815
18-5281			511, 536, 541, 585, 594-596	18-5338	CHRIS-CRAFT	16.69-00040	480
18-5282			585, 594, 596	18-5338			492
18-5283			536, 585, 743, 750	18-5338	MERCURY MARINE	391-898253001	586
18-5284			811, 815	18-5338	VOLVO	835308-8	815
18-5285			564, 588, 589, 746	18-5338	CRUSADER	12530	480
18-5286			564	18-5338	PLEASURECRAFT	R115001	540, 541
18-5287-1			745	18-5338	MERCURY MARINE	391-5092	584-586
18-5288			564	18-5338	OMC	382136	743
18-5289			482, 514, 543, 589	18-5342	VOLVO	243653	815
18-5290			482, 514, 543, 589	18-5344			480, 492, 512
18-5291	MERCURY MARINE	808483K2	584	18-5344	CRUSADER	12526	480
18-5292			819	18-5344	MERCURY MARINE	33706	586
18-5293-1			745	18-5344	OMC	382125	743
18-5294			482, 514, 543, 589	18-5345	CHRIS-CRAFT	16.69-00050	480
18-5295			482, 514, 543, 589	18-5345	CHRYSLER INBOARD	2098058	492
18-5296-2			482, 514, 543, 589	18-5345	CHRYSLER INBOARD	2279949	492
18-5297			588, 589, 593, 747, 750	18-5345	MERCURY MARINE	898253003	586
18-5298			482, 514, 543, 589	18-5345	VOLVO	835704	815
18-5299			482, 514, 543, 589	18-5345			480, 511, 541, 743, 815
18-5300			480, 492, 512, 541, 586	18-5345	CRUSADER	41057	480
18-5301			480, 493, 511, 512, 541, 585, 744, 816, 865	18-5345	CRUSADER	705787	480
18-5302			481, 493, 511, 512, 541, 585, 744, 816, 865	18-5345	PLEASURECRAFT	R115002	540, 541
18-5303	CHRYSLER INBOARD	2421173	492	18-5345	MERCURY MARINE	33662	586
18-5303	CHRYSLER INBOARD	2808870	492	18-5345	OMC	380537	743
18-5303	MERCURY MARINE	392-898253005	585	18-5346	CHRIS-CRAFT	1869704	480
18-5303	OMC	987136	743	18-5346			480, 484, 541, 545, 584, 586
18-5303	OMC	987894	743	18-5346	MERCURY MARINE	58034	586
18-5303	VOLVO	835705	815	18-5346	MERCURY MARINE	81-64851	586
18-5303	VOLVO	855846-2	815	18-5347	CHRYSLER INBOARD	1818757	492
18-5303			536, 585	18-5347	CHRYSLER INBOARD	3420600	492
18-5303	CRUSADER	41058	479	18-5347	MERCURY MARINE	392-898253002	586
18-5303	PLEASURECRAFT	R114002	540, 541	18-5347	OMC	987895	743
18-5303	OMC	980893	743	18-5347	MERCURY MARINE	392-6324	584-586
18-5305	VOLVO	243460	815	18-5347	OMC	980894	743
18-5305	VOLVO	243799	815	18-5348	VOLVO	834560	815
18-5305	VOLVO	1306169	815	18-5349	VOLVO	841262	815
18-5306	VOLVO	240149	815	18-5350	MERCURY MARINE	888751A03	591
18-5307	CHRYSLER INBOARD	1274092	492	18-5351	MERCURY MARINE	884794A02	591
18-5307	CHRYSLER INBOARD	2084074	492	18-5352			480
18-5307	CHRYSLER INBOARD	2421178	492	18-5352	CHRYSLER INBOARD	4142817	492
18-5307	CRUSADER	705788	511	18-5352	MERCURY MARINE	392-9766Q1	586
			479, 484, 492, 495, 511, 517, 554	18-5352	VOLVO	841070	816
18-5309	PLEASURECRAFT	RA107001	543	18-5352	CRUSADER	41076	480
18-5309	MALLORY	YL512CV	515, 543, 592, 749	18-5352	MERCURY MARINE	392-9766	511, 585, 586, 743
18-5309	OMC	980902	749	18-5352	PLEASURECRAFT	RA108003	540, 542
18-5310	VOLVO	818701-5	815	18-5352	OMC	984401	744
				18-5353	MERCURY MARINE	392-9086T	587
				18-5353	VOLVO	841926	816
				18-5353	CRUSADER	41069	512
				18-5353			512
				18-5353	MERCURY MARINE	392-9086	587
				18-5353	OMC	984398	744
				18-5354	CRUSADER	38070	512
				18-5354	MERCURY MARINE	808483T3	587

1 This product is priced per piece. To order, priced per package, please add -9 to the part number
 2 Items ending in "D" are display packaged - regular number is non-display
 3 For discount shop pack of 10, please add -10 to the part number

SIERRA #	O.E.M.	O.E. #	PAGE #	SIERRA #	O.E.M.	O.E. #	PAGE #
SIERRA							
18-5354	OMC	3854548	743	18-5405	MERCURY MARINE	898253010	586
18-5354	VOLVO	3854548-9	816	18-5405	OMC	3854549	744
18-5354			512	18-5405	VOLVO	3854549-7	815
18-5354	MERCURY MARINE	808483	587	18-5405	MERCURY MARINE	808484 1	512
18-5356	VOLVO	243797	816	18-5406	MERCURY MARINE	898253011	586
18-5357	VOLVO	870690	816	18-5406	VOLVO	3854261	815
18-5358	VOLVO	841263	816	18-5406	OMC	986651	743
18-5359			480, 484, 542, 545, 554	18-5406			743
18-5361	MERCURY MARINE	811635T3	587	18-5406	MERCURY MARINE	811636 1	743
18-5361	VOLVO	3854260	816	18-5406	MERCURY MARINE	811636	586
18-5361			512	18-5407	CHRYSLER INBOARD	1658535	492
18-5361	OMC	986643	744	18-5407	MERCURY MARINE	392-6326T	586
18-5361	MERCURY MARINE	811635	587	18-5407			480, 492, 512
18-5362	MERCURY MARINE	850484	587	18-5407	CRUSADER	41059	480
18-5362	MERCURY MARINE	850484T	587	18-5407	PLEASURECRAFT	R103003	540, 541
18-5362	MERCURY MARINE	850484T2	587	18-5407	MERCURY MARINE	392-6326	584-586
18-5362	OMC	3854331	744	18-5407	OMC	980892	743
18-5362	VOLVO	3854331-0	816	18-5408	MERCURY MARINE	850485	586
18-5362			512, 587, 744, 816	18-5408	MERCURY MARINE	898253012	586
18-5369	CHRYSLER INBOARD	4142408	492	18-5408	OMC	3854311	744
18-5369	MERCURY MARINE	392-6318T	587	18-5408	VOLVO	3854311-2	816
18-5369	VOLVO	835702	816	18-5408			512, 587, 744, 816
18-5369			480, 492, 512	18-5408	MERCURY MARINE	850485 1	512, 587, 744, 816
18-5369	CRUSADER	41052	512	18-5411	CRUSADER	1003318	512
18-5369	PLEASURECRAFT	RA108002	541, 542	18-5411	CHRIS-CRAFT	16.69-00042	480, 492, 512
18-5369	MERCURY MARINE	392-6318	587	18-5411	CRUSADER	12531	480
18-5369	OMC	982336	744	18-5411	OMC	982342	744
18-5375	VOLVO	841244	816	18-5411	VOLVO	841243	812
18-5375	CHRIS-CRAFT	16.69-00100	480, 492, 512	18-5413	OMC	987986	744
18-5375	CHRIS-CRAFT	F16900165	480, 492, 512	18-5413			744
18-5375	CRUSADER	12532	480	18-5418	MERCURY MARINE	898253008	586
18-5375	CRUSADER	1003317	480	18-5418	CHRIS-CRAFT	16.69-00051	480, 492, 512
18-5375	OMC	382133	744	18-5418			480, 492, 512
18-5376	CHRIS-CRAFT	16.69-00148	480	18-5418	MERCURY MARINE	58217	586
18-5376			492	18-5418	OMC	384735	744
18-5376	MERCURY MARINE	391-5075Q1	587	18-5419	OMC	380542	744
18-5376	CRUSADER	20222	480	18-5419	VOLVO	818525-8	816
18-5376	PLEASURECRAFT	R108001	540, 542	18-5419			480, 484, 554, 744, 750, 816
18-5376	MERCURY MARINE	391-5075	587				
18-5376	OMC	982209	744	18-5420	CRUSADER	3000122	512
18-5384	CRUSADER	12528	513	18-5420	MERCURY MARINE	65864	586
18-5384	MERCURY MARINE	33708	587	18-5420	MERCURY MARINE	78016	586
18-5384	OMC	383587	744	18-5425	VOLVO	834975	812, 813, 815, 816
18-5385	MERCURY MARINE	393-9459Q1	587	18-5427	CRUSADER	705786	512
18-5385	CHRIS-CRAFT	16.69-00052	480, 492, 512	18-5427	CHRIS-CRAFT	16.69-0022	480, 484, 512, 517, 554
18-5385			480, 492, 512	18-5427			480, 484, 512, 517, 554
18-5385	MERCURY MARINE	393-9459	587	18-5428			811, 812, 815, 816
18-5385	OMC	380541	744	18-5429	VOLVO	243903	492
18-5386	MERCURY MARINE	33765T	587	18-5429	CHRYSLER INBOARD	2098611	480, 492, 512
18-5386			480, 492, 512	18-5429			480, 492, 512
18-5386	OMC	980152	744	18-5430	CHRYSLER INBOARD	868095	492
18-5389	CRUSADER	3000121	512	18-5430			492, 495, 554
18-5389	MERCURY MARINE	393-4988T2	587	18-5431	MERCURY MARINE	13524A5	586
18-5389			513, 542, 587	18-5431	MERCURY MARINE	13524T1	586
18-5389	MERCURY MARINE	393-4988T	587	18-5432	MERCURY MARINE	13524A6	586
18-5393	VOLVO	241669	816	18-5433	CRUSADER	37068	516
18-5394	VOLVO	243658	882-885	18-5433	DELCO	1115202	588
18-5395	MERCURY MARINE	805759T1	587	18-5433	OMC	915735	744
18-5395	MERCURY MARINE	16457A4	587	18-5433	MERCURY MARINE	38547	303, 588
18-5395	MERCURY MARINE	805759T	587	18-5433	MERCURY MARINE	32193A2	303, 588
18-5396	MERCURY MARINE	13753A2	587	18-5433	MERCURY MARINE	392-806529A1	303, 588
18-5396	MERCURY MARINE	815407A2	587	18-5433	MERCURY MARINE	898253T24	303, 588
18-5397			587, 591, 592, 744, 748-750	18-5433			303, 516, 546, 554, 588, 745
18-5399	CRUSADER	41061	512	18-5434	CHRYSLER INBOARD	201522	494
18-5399	MERCURY MARINE	392-6329	587	18-5434	CHRYSLER INBOARD	2495531	494
18-5399	OMC	910169	785	18-5434	CRUSADER	41080	516
18-5402	MERCURY MARINE	898253009	586	18-5434	PLEASURECRAFT	R117001	546
18-5403	MERCURY MARINE	392-9089T	586	18-5434	VOLVO	835998	817
18-5403	VOLVO	841907	815				483, 494, 516, 537, 545, 546, 817
18-5403	VOLVO	855845	815				
18-5403	VOLVO	3853801	815	18-5435	CHRYSLER INBOARD	200691	494
18-5403			536, 585	18-5435	CRUSADER	41080	516
18-5403	CRUSADER	41074	480	18-5435			483, 494, 516, 545, 546
18-5403	CRUSADER	41089	480	18-5436	VOLVO	35254	817
18-5403	MERCURY MARINE	392-9089	511, 585, 586, 743	18-5436			516, 545, 546, 817
18-5403	PLEASURECRAFT	R103004	540, 541	18-5437	OMC	378231	745
18-5403	MERCURY MARINE	392-9767	586	18-5437	OMC	383444	745
18-5403	OMC	982880	743	18-5438	CRUSADER	37068	516
18-5404-1	CHRIS-CRAFT	16.69-00149	480	18-5438	MERCURY MARINE	392-7803A4	588
18-5404-1	CHRYSLER INBOARD	868096	492	18-5438	MERCURY MARINE	392-805570A2	588
18-5404-1	MERCURY MARINE	391-7057T	586	18-5442	MERCURY MARINE	806673T	588
18-5404-1	MERCURY MARINE	391-898253029	586	18-5442	MERCURY MARINE	806673T1	588, 594, 595
18-5404-1			815	18-5443	CRUSADER	7243200	516
18-5404-1	CRUSADER	20223	480	18-5443	MERCURY MARINE	817378	588
18-5404-1	PLEASURECRAFT	R103001	540, 541	18-5443	MERCURY MARINE	817378T	588
18-5404-1	MERCURY MARINE	391-7057	584-586	18-5443	MERCURY MARINE	898253T27	588
18-5404-1	MERCURY MARINE	391-5088	586	18-5443	OMC	3854002	745
18-5404-1	OMC	982211	743	18-5443	VOLVO	3854002-7	817
18-5405	CRUSADER	38071	512	18-5450	CHRYSLER INBOARD	4106140	494
18-5405	MERCURY MARINE	808484	586	18-5450	PLEASURECRAFT	R119001	546

1 This product is priced per piece. To order, priced per package, please add -9 to the part number

2 Items ending in "D" are display packaged - regular number is non-display

3 For discount shop pack of 10, please add -10 to the part number

SIERRA #	O.E.M.	O.E. #	PAGE #	SIERRA #	O.E.M.	O.E. #	PAGE #
SIERRA							
18-5450			483, 494, 516, 537, 545, 546	18-5606	MERCURY MARINE	50-60315	318, 320, 321
18-5451	CHRYSLER INBOARD	3874767	494	18-5608	MERCURY MARINE	50-44414	319, 321
18-5464			483, 516, 546, 588, 744, 817	18-5608	MERCURY MARINE	50-44415	319, 321
18-5465	MerCruiser	8M0054588	588	18-5608	MERCURY MARINE	50-77141	319, 321
18-5466			482, 514, 543, 589	18-5608	MERCURY MARINE	50-79472	319, 321
18-5469			543, 589	18-5608	MERCURY MARINE	50-79472 1	319, 321
18-5470	MERCURY MARINE	805185A37	591	18-5609	MERCURY MARINE	50-86976	317, 319, 321
18-5471	MERCURY MARINE	805185A36	591	18-5610	MERCURY MARINE	50-66015-1	321
18-5472			564	18-5610	MERCURY MARINE	50-66015 3	319, 321
18-5473			565	18-5611	MERCURY MARINE	50-90983T1	319
18-5474			565	18-5611	MERCURY MARINE	50-90983A1	320
18-5475	MERCURY MARINE	817377	591	18-5612	OMC	432925	219
18-5475			591, 818	18-5612	OMC	586286	219
18-5476	MERCURY MARINE	907964A1	591, 593, 748	18-5612	OMC	586287	219
18-5476			591, 593, 748	18-5613	CHRYSLER FORCE	490955	188, 189
18-5477			479, 510	18-5613	CHRYSLER FORCE	50-898265002	188
18-5478			479, 510	18-5613	CHRYSLER FORCE	61-6955	188
18-5479			543, 564	18-5613	CHRYSLER FORCE	480955	188, 189
18-5480			483, 516, 537, 544, 564, 590, 749, 818	18-5613	CHRYSLER FORCE	FK616955	188, 189
18-5481			590, 747	18-5617	OMC	586274	219
18-5482			590, 747	18-5618	CHRYSLER FORCE	50-819968-2	188, 189
18-5483			565	18-5619	OMC	391511	219
18-5484-1	MALLORY	YLE624AV	493, 516, 544, 591, 749, 818	18-5619	OMC	396235	219
18-5485	CHRIS-CRAFT	YLE624BV	483, 493, 516, 544, 591, 749, 818	18-5619	OMC	397023	219
18-5486	MALLORY	YLM673AV	591, 748, 750	18-5619	OMC	584799	219
18-5487	MALLORY	YLM676AV	748	18-5619	OMC	586731	219
18-5488	MALLORY	YLM554CV	591, 593, 748, 750	18-5620	MERCURY MARINE	50-818445-2	319, 321
18-5489	MALLORY	YLM554CV	748	18-5620	MERCURY MARINE	50-818445-3	319, 321
18-5489			544, 592, 595, 748, 750	18-5620	MERCURY MARINE	50-8184455	319, 321
18-5493			882-885	18-5621	MERCURY MARINE	50-822462T1	319
18-5494-1			592	18-5621	MERCURY MARINE	50-822462	319, 320
18-5494-1	MALLORY	YLM624AV	748, 818	18-5622	CHRYSLER FORCE	50-820193	188, 189
18-5495-1			515, 544, 592, 748	18-5622	CHRYSLER FORCE	50-820193T1	188, 189
18-5495-1	MALLORY	YLM512CV	544, 545, 592, 748, 750	18-5624	OMC	583482	220
18-5496-1			748, 750	18-5624	OMC	585056	220
18-5496-1	MALLORY	YLM567CV	592, 748	18-5627	OMC	583473	220
18-5497-1	MERCURY MARINE	YLM579AV	592	18-5627	OMC	585459	220
18-5497-1			493, 495, 592	18-5627	OMC	585059	220, 221
18-5498-1			515, 544, 592, 749, 818	18-5628	OMC	393570	220
18-5498-1	MALLORY	YLM624BV	592, 749, 818	18-5628	OMC	585060	220
18-5511	MERCURY MARINE	45876-20	308	18-5628	OMC	386591	220
18-5511	MERCURY MARINE	84-822253A20	308	18-5629	OMC	392133	220
18-5511	MERCURY MARINE	84-822253T20	308	18-5629	OMC	585061	220
18-55500	Yanmar	728170-92600	580	18-5629	OMC	384163	220
18-55501	Yanmar	18-55501	580	18-5630	OMC	387684	220
18-55502	Yanmar	728271-92605	580	18-5630	OMC	389275	220
18-55503	Yanmar	728374-92605	580	18-5630	OMC	585063	220
18-55600	Yanmar	128170-01331	580	18-5631	OMC	584818	220
18-55601	Yanmar	128171-01911	580	18-5631	OMC	586277	220, 221
18-55602	Yanmar	128271-01911	580	18-5632	OMC	584980	220
18-55603	Yanmar	128374-01911	580	18-5632	OMC	586284	220, 221
18-5600	OMC	387094	219	18-5632	OMC	385529	220
18-5600	OMC	395207	219	18-5634	OMC	389954	220
18-5600	OMC	585062	219	18-5634	OMC	585051	220
18-5600	OMC	586288	219	18-5634	OMC	585057	220
18-56000	Yanmar	128170-11310	580	18-5635	OMC	384777	220
18-56001			395	18-5635	OMC	386657	220
18-56002	NISSAN/TOHATSU	3C8-75014-0	395	18-5635	OMC	391735	220
18-56002	YAMAHA	689-81840-11-00	413	18-5635	OMC	585050	220
18-56004	YAMAHA	663-81840-11-00	413	18-5635	OMC	585058	220
18-56005	YAMAHA	6E5-81840-10-00	413	18-5635	OMC	586281	220, 221
18-56006	YAMAHA	6N7-81840-00-00	413	18-5636	MERCURY MARINE	50-57867	319
18-56007	YAMAHA	61A-81840-00-00	414	18-5636	MERCURY MARINE	50-58788A3	319
18-56008	SUZUKI	31173-95310	398	18-5636	MERCURY MARINE	50-57465A1	319, 321
18-56009	SUZUKI	31173-99E00	399	18-5636	MERCURY MARINE	50-64975	319, 321
18-5601	MERCURY MARINE	50-38890A1	318, 320	18-5636	MERCURY MARINE	50-72467	319, 321
18-5601	MERCURY MARINE	50-55601	318, 320	18-5640	OMC	387094	219
18-5601	MERCURY MARINE	50-55601A2	318, 320	18-5640	OMC	395207	219
18-5602	MERCURY MARINE	50-67341	318, 321	18-5640	OMC	585062	219
18-5603	INDMAR	573001	537	18-5640	OMC	586288	219
18-5603	MARINE POWER	0170-000	539	18-5641	MERCURY MARINE	50-38890A1	318, 320
18-5603	PLEASURECRAFT	RA122009	546	18-5641	MERCURY MARINE	50-55601	318, 320
18-5603	MERCURY MARINE	50-808011A4	598	18-5641	MERCURY MARINE	50-55601A2	318, 320
18-5604	MERCURY MARINE	50-66015	318, 321	18-5642	MERCURY MARINE	50-66015T1	318
18-5604	MERCURY MARINE	50-66015T1	318, 321	18-5642	MERCURY MARINE	50-66015	318, 321
18-5604	MERCURY MARINE	50-65436	318, 321	18-5642	MERCURY MARINE	50-65436	318
18-5605	MERCURY MARINE	50-73521T	318	18-5642	MERCURY MARINE	50-79472 1	319
18-5605	MERCURY MARINE	50-73521	318, 320	18-5643	MERCURY MARINE	50-44414	319
18-5606	MERCURY MARINE	50-44369	318	18-5643	MERCURY MARINE	50-44415	319
18-5606	MERCURY MARINE	50-44369A1	318, 320, 321	18-5643	MERCURY MARINE	50-77141	319
18-5606	MERCURY MARINE	50-44369A1	318, 320, 321	18-5643	MERCURY MARINE	50-79472	319
				18-5644	CHRYSLER FORCE	490955	s/s to 18-5613
				18-5644	CHRYSLER FORCE	61-6955	s/s to 18-5613
				18-5644	CHRYSLER FORCE	480955	s/s to 18-5613
				18-5644	CHRYSLER FORCE	FK616955	s/s to 18-5613
				18-5645	OMC	386591	220
				18-5645	OMC	392133	220
				18-5645	OMC	585061	220
				18-5646	OMC	384163	220
				18-5646	OMC	387684	220
				18-5646	OMC	389275	220

1 This product is priced per piece. To order, priced per package, please add -9 to the part number

2 Items ending in "D" are display packaged - regular number is non-display

3 For discount shop pack of 10, please add -10 to the part number

SIERRA #	O.E.M.	O.E. #	PAGE #	SIERRA #	O.E.M.	O.E. #	PAGE #
SIERRA							
18-5646	OMC	585063	220	18-5755	OMC	581397	212
18-5647	OMC	385529	s/s to 18-5634	18-5756	OMC	582056	212
18-5647	OMC	389954	s/s to 18-5634	18-5757	OMC	582057	212
18-5647	OMC	585051	s/s to 18-5634	18-5758	OMC	582452	212
18-5647	OMC	585057	s/s to 18-5634	18-5758	OMC	582453	212
18-5648	OMC	384777	220	18-5758	OMC	583380	212
18-5648	OMC	386657	220	18-5759	OMC	582125	212
18-5648	OMC	391735	220	18-5760	OMC	582138	212
18-5648	OMC	585050	220	18-5760	OMC	582400	212
18-5648	OMC	585058	220	18-5760	OMC	582556	212
18-5648	OMC	586281	220	18-5760	OMC	582642	212
18-5649	MERCURY MARINE	50-57867	319	18-5761	OMC	583114	212
18-5649	MERCURY MARINE	50-58788A3	319	18-5762	OMC	582115	212
18-5649	MERCURY MARINE	50-57465A1	319	18-5763	OMC	582285	212
18-5649	MERCURY MARINE	50-64975	319	18-5763	OMC	583170	212
18-5649	MERCURY MARINE	50-72467	319	18-5764	OMC	582261	212
18-5650	MERCURY MARINE	57380	320	18-5765	OMC	396141	212
18-5655	CHRYSLER FORCE	F15150	189	18-5766	OMC	583748	212
18-5655	OMC	321648	189, 220, 221	18-5767	OMC	584783	212
18-5656	MERCURY MARINE	68575	320, 321	18-5768	OMC	584908	213
18-5657	VOLVO	855798	821	18-5768	OMC	5001344	213
18-5658	MERCURY MARINE	86177	320, 321	18-5770	OMC	584028	213
18-5658	MERCURY MARINE	86177 1	320, 321	18-5771	OMC	584032	213
18-56601		104211-49160	580	18-5772	OMC	584041	213
18-56602		128170-42090	580	18-5773	OMC	584642	213
18-5661	VOLVO	855389	882-885	18-5774	OMC	585145	213
18-5671	OMC	384781	220, 221	18-5775	MERCURY MARINE	332-7778A12	185, 186, 303, 306, 307
18-5673	CHRYSLER FORCE	819222	189	18-5775	CHRYSLER FORCE	332-7778A6	185, 303
18-5673	CHRYSLER FORCE	F15100	189	18-5775	CHRYSLER FORCE	332-7778A9	185, 303
18-5673	CHRYSLER FORCE	F15110	189	18-5775	MERCURY MARINE	332-7778A6	185, 303
18-5674	OMC	387683	221, 320, 321	18-5775	MERCURY MARINE	332-7778A9	185, 303
18-5674	MERCURY MARINE	13310T1	320, 321	18-5775	MERCURY MARINE	332-7778A9	185, 303
18-5674	MERCURY MARINE	75660	221, 320, 321	18-5776	MERCURY MARINE	339-7452A3	303
18-5677	CHRYSLER FORCE	811902	189	18-5777	MERCURY MARINE	339-7452A15	304
18-5678	OMC	585269	221	18-5777	MERCURY MARINE	339-7452A19	304-307
18-5679	OMC	585267	221	18-5778	MERCURY MARINE	339-7452A14	304
18-5697	CHRYSLER FORCE	F15164	189	18-5778	MERCURY MARINE	339-7452A21	304-307
18-5697	OMC	385952	221	18-5780	OMC	585189	213
18-5697	MERCURY MARINE	75384	320	18-5781	OMC	586661	213
18-5700	VOLVO	3858081	825	18-5782	OMC	582705	213
18-5700	VOLVO	3858809	825	18-5783	OMC	582811	213
18-5704	VOLVO	876037	825	18-5784	OMC	583110	213
18-5705	VOLVO	876039	825	18-5785	OMC	585261	213
18-5705	OMC	582472	217	18-5786	MERCURY MARINE	332-4911A2	304
18-5705	OMC	584416	217	18-5787	MERCURY MARINE	332-4911A8	304
18-5705	OMC	586224	217	18-5788	MERCURY MARINE	339-6222A8	304
18-5707	MERCURY MARINE	816770	313	18-5790	CHRYSLER FORCE	18495A26	185, 304
18-5707	MERCURY MARINE	62351A1	313	18-5790	MERCURY MARINE	18495A26	185, 304
18-5707	MERCURY MARINE	62351A2	313	18-5791	MERCURY MARINE	19052A8	304
18-5707	MERCURY MARINE	816770T	313	18-5792	MERCURY MARINE	16061T	304
18-5708	OMC	582399	218	18-5793	MERCURY MARINE	823034T	304
18-5708	OMC	583408	218	18-5794	OMC	583896	213
18-5709	OMC	581778	218	18-5794	OMC	584329	213
18-5710	CHRYSLER INBOARD	2098300	496	18-5794	OMC	584331	213
18-5710	CHRYSLER INBOARD	2847527	496	18-5794	OMC	584489	213
18-5710	PRESTOLITE	VSH-6201JY	484, 496, 518	18-5795	MERCURY MARINE	96455A11	311
18-5711	OMC	383440	757	18-5796	MERCURY MARINE	96455A15	311
18-5711	PRESTOLITE	VSH-6201 AFY	757	18-5797	MERCURY MARINE	96455A8	311
18-5712	CHRIS-CRAFT	16.60-00031	484, 485	18-5798	MERCURY MARINE	96455A9	311
18-5712	PRESTOLITE	VSH-6201ACY	484, 485	18-5801	PLEASURECRAFT	R130001	547
18-5717	CRUSADER	42001	517	18-5801	MERCURY MARINE	89-76416A1	601
18-5717	CRUSADER	707125	517	18-5801	OMC	985064	755
18-5717	MERCURY MARINE	33270	601	18-5802	MERCURY MARINE	65057A1	313, 601
18-5717	OMC	1984462	755	18-5802	MERCURY MARINE	65057T1	313, 601
18-5717			601	18-5803	CHRYSLER FORCE	F177917	185
18-5723	CHRYSLER INBOARD	2095946	496	18-5803	OMC	979774	755
18-5727	PLEASURECRAFT	R098002	547	18-5804	MERCURY MARINE	13037	601
18-5727	PRESTOLITE	VSH-6201ADY	547	18-5804			555, 601
18-5729	MERCURY MARINE	87-18211	314	18-5806	VOLVO	834520	825
18-5737	MERCURY MARINE	87-19761	314	18-5806	BOSCH	0331-302-050	825
18-5740	MERCURY MARINE	42785	605	18-5806	BOSCH	0331-302-081	825
18-5741	MERCURY MARINE	815279-1	313	18-5806	BOSCH	0331-302-085	825
18-5741	MERCURY MARINE	815279A2	313	18-5806	BOSCH	0331-302-581	825
18-5742	CHRYSLER FORCE	815279-2	187	18-5806	BOSCH	0331-302-585	825
18-5743	MERCURY MARINE	815279-3	313	18-5807	PRESTOLITE	SAW4206	217, 755
18-5743	MERCURY MARINE	815279-5	313	18-5807	OMC	378444	217, 218, 755, 756
18-5743	MERCURY MARINE	883072T	313	18-5808	MERCURY MARINE	47886	313
18-5744	CHRYSLER FORCE	815279-4	187	18-5808	MERCURY MARINE	47886T	313
18-5745	VOLVO	3287677	817	18-5808	OMC	395419	217
18-5746	Yamaha	6H3-85510-A1	412	18-5808	OMC	582708	217
18-5750			187, 201, 215, 308, 394, 397, 411, 481, 495, 515, 545, 598, 752, 821	18-5810			313, 602
18-5750	OMC	580339	752	18-5811	VOLVO	3859054	825
18-5750	OMC	581027	752	18-5811	MERCURY MARINE	809463A1	313, 602
18-5752			187, 201, 215, 308, 394, 397, 411, 481, 495, 515, 545, 598, 752, 821	18-5811	OMC	3850216	755
18-5753	OMC	581731	212	18-5811	VOLVO	3850216	825
18-5754	OMC	581726	212	18-5812	OMC	985063	755
				18-5813	OMC	584128	217
				18-5814	OMC	172869	217
				18-5814	OMC	581528	217
				18-5815	MERCURY MARINE	89-68258A4	313, 602
				18-5815	MERCURY MARINE	89-76545	313, 602

1 This product is priced per piece. To order, priced per package, please add -9 to the part number
 2 Items ending in "D" are display packaged - regular number is non-display
 3 For discount shop pack of 10, please add -10 to the part number

SIERRA #	O.E.M.	O.E. #	PAGE #	SIERRA #	O.E.M.	O.E. #	PAGE #
SIERRA							
18-5815	MERCURY MARINE	89-853654A1	313, 602	18-5873	MERCURY MARINE	398-832075A6	185, 310
18-5816	MERCURY MARINE	89-96054T	313	18-5874	MERCURY MARINE	398-832075A14	311
18-5816	MERCURY MARINE	89-91975	313, 602	18-5874	MERCURY MARINE	398-832075A20	310-312
18-5816	MERCURY MARINE	89-96054	313, 602	18-5875	MERCURY MARINE	398-9610A5	311
18-5817	MERCURY MARINE	89-96158T	313	18-5876	MERCURY MARINE	398-9610A19	311
18-5817	MERCURY MARINE	89-96158	313, 602	18-5877	OMC	584643	216
18-5818	MERCURY MARINE	89-818864	313	18-5878	OMC	584981	216
18-5818	MERCURY MARINE	89-818864T	313	18-5879	YAMAHA	688-81941-00-00	411
18-5819	MERCURY MARINE	89-818997A1	313	18-5879	YAMAHA	688-81950-10-00	411
18-5819	MERCURY MARINE	89-818997T1	313	18-5881	CHRYSLER FORCE	332-5772A7	185, 304
18-5819	YAMAHA	65W-81941-00-00	411	18-5881	MERCURY MARINE	332-5772A7	185, 304
18-5820	MERCURY MARINE	89-818999A2	313, 602	18-5882	VOLVO	3884950	823
18-5820	MERCURY MARINE	89-825842A1	313, 602	18-5883	OMC	584488	213
18-5820	MERCURY MARINE	89-850188T1	313, 602	18-5884	OMC	586343	214
18-5821	MERCURY MARINE	825096T01	313	18-5885	OMC	583865	213
18-5821	MERCURY MARINE	89-825096T	313	18-5886	OMC	436367	214
18-5821	YAMAHA	6G1-81941-10-00	411	18-5886	OMC	584122	214
18-5822	MERCURY MARINE	54293A13	313	18-5887	OMC	584985	214
18-5823	OMC	584580	217	18-5888	OMC	987738	745
18-5825	OMC	395204	218	18-5889	OMC	987739	745
18-5826	OMC	584890	218	18-5890	OMC	987740	745
18-5827	OMC	584476	218	18-5891	OMC	583605	214
18-5827	OMC	585001	218	18-5892	OMC	582262	214
18-5828	OMC	439561	218	18-5893	OMC	583476	214
18-5828	OMC	585219	218	18-5893	OMC	584037	214
18-5829	OMC	586048	218	18-5893	OMC	586217	214
18-5830	OMC	586075	218	18-5893	OMC	586667	214
18-5831	OMC	584641	218	18-5896	MERCURY MARINE	12415	18, 336
18-5831	OMC	585995	218	18-5896			18, 336
18-5831	OMC	586271	218	18-5897			18, 640
18-5832	OMC	583266	218	18-5897	MERCURY MARINE	806490T	640
18-5832	OMC	583689	218	18-5897	MERCURY MARINE	97257A1	640
18-5832	OMC	584424	218	18-5897	OMC	980613	769
18-5832	OMC	586000	218	18-5897	VOLVO	3853787	833
18-5833	OMC	586774	217	18-5898	MERCURY MARINE	97258A1	640
18-5834	CHRYSLER FORCE	89-817109A2	185, 314	18-5898	CRUSADER	700427	521
18-5834	MERCURY MARINE	89-817109A2	185, 314	18-5898			18, 521, 640, 769
18-5835	CHRYSLER FORCE	89-803822T	185	18-5898	OMC	171960	18, 521, 640, 769
18-5835	CHRYSLER FORCE	89-817109A3	185	18-5899			18, 521, 549, 640
18-5835	CHRYSLER FORCE	89-F460917-1	185	18-5899	PLEASURECRAFT	RO20001	549
18-5835	CHRYSLER FORCE	F460917-1	185	18-5899	MERCURY MARINE	90806	640
18-5836	MERCURY MARINE	25661 1	314	18-5899	VOLVO	3857532	833
18-5836	MERCURY MARINE	25661 T1	314	18-5899	CRUSADER	700425	521
18-5836	MERCURY MARINE	25661	314	18-5899	MERCURY MARINE	815425T	18, 640
18-5837	MERCURY MARINE	89-18080	601	18-5899	OMC	982650	769
18-5837	MERCURY MARINE	89-99253	601	18-5900	CHRIS-CRAFT	16.61-00042	484
18-5837	OMC	985799	755	18-5900	MERCURY MARINE	50-17251A3	598
18-5837	OMC	986620	755	18-5900	MERCURY MARINE	50-76965A4	598
18-5837	VOLVO	3853869	825	18-5900	MERCURY MARINE	50-77328A3	598
18-5837	VOLVO	3853998	825	18-5900	MERCURY MARINE	50-99417A2	598
18-5838	MERCURY MARINE	33261	601	18-5900	MERCURY MARINE	50-99419A3	598
18-5838	MERCURY MARINE	89902	601	18-5900	OMC	981078	753
18-5838	DELCO	1114356	755	18-5900	OMC	982121	753
18-5838	DELCO	1114458	755	18-5900	OMC	983444	753
18-5838			601	18-5900	OMC	983790	753
18-5840	PRESTOLITE	SAW4201	484, 496, 517	18-5900	OMC	985966	753
18-5840	PRESTOLITE	15-79	484, 496, 517, 601	18-5900	VOLVO	834893	821
18-5840	PRESTOLITE	SAW4207	484, 496, 517, 601	18-5900	VOLVO	855326	821
18-5840	PRESTOLITE	SAW4210	484, 496, 517, 601	18-5901	CRUSADER	42090	517
18-5840			55, 484, 485, 496, 517, 518, 555, 601	18-5901	PLEASURECRAFT	RA122008	546
18-5841	CHRYSLER INBOARD	1692658	496	18-5901	MERCURY MARINE	50-72550A2	599
18-5849	MERCURY MARINE	828151	314	18-5901	MERCURY MARINE	50-79604A3	599
18-5849	MERCURY MARINE	828151A1	314	18-5901	MERCURY MARINE	50-97499A2	599
18-5849	MERCURY MARINE	882751A1	314	18-5901	OMC	981289	753
18-5849	MERCURY MARINE	882751A2	314	18-5901	OMC	982202	753
18-5850	MERCURY MARINE	882751A04	314	18-5901	MERCURY MARINE	50-97499R4	517, 546, 599, 605-607, 753, 754
18-5852	MERCURY MARINE	821509	314	18-5902	CRUSADER	42091	517
18-5852	MERCURY MARINE	853292	314	18-5902	PLEASURECRAFT	RA122009	546
18-5852	MERCURY MARINE	821509T1	314	18-5902	MERCURY MARINE	50-76965A3	599
18-5853	YAMAHA	61A-81941-00-00	411	18-5902	MERCURY MARINE	50-808011A1	599
18-5853	YAMAHA	6E5-81941-11-00	411	18-5902	OMC	981288	754
18-5853	YAMAHA	6E581941-00-00	411	18-5902	OMC	982195	754
18-5853	YAMAHA	6E581941-10-00	411	18-5902	OMC	984982	754
18-5854	MERCURY MARINE	398-5454A17	311	18-5902	OMC	986007	754
18-5856	MERCURY MARINE	398-5255	311	18-5903	PLEASURECRAFT	RA122001	547
18-5857	MERCURY MARINE	398-5454A7	311	18-5903	MERCURY MARINE	50-12872	601
18-5859	MERCURY MARINE	398-5454A26	311	18-5903	MERCURY MARINE	50-56886	601
18-5860	MERCURY MARINE	398-5454A35	311	18-5903	MERCURY MARINE	50-69865A1	601
18-5863	MERCURY MARINE	86617A17	310	18-5903	OMC	980803	754
18-5864	MERCURY MARINE	86617A20	310	18-5903	OMC	981821	754
18-5865	MERCURY MARINE	398-5704A7	310	18-5903	VOLVO	841066-4	821
18-5866	MERCURY MARINE	76314A3	310	18-5905	MERCURY MARINE	50-12177A2	599
18-5867	MERCURY MARINE	398-9873A4	310	18-5905	MERCURY MARINE	50-99418A2	599
18-5870	CHRYSLER FORCE	398-832075A4	185	18-5905	OMC	984456	754
18-5870	MERCURY MARINE	398-832075A4	185	18-5905	OMC	986505	754
18-5870	MERCURY MARINE	398-832075A21	185, 310, 312	18-5906	VOLVO	840808	822
18-5871	MERCURY MARINE	398-5454A32	310	18-5907	CRUSADER	42090	517
18-5872	MERCURY MARINE	398-6231A10	603	18-5907	PLEASURECRAFT	RA122008	546
18-5873	CHRYSLER FORCE	398-832075A6	185, 310	18-5907	MERCURY MARINE	50-72550A2	599

1 This product is priced per piece. To order, priced per package, please add -9 to the part number

2 Items ending in "D" are display packaged - regular number is non-display

3 For discount shop pack of 10, please add -10 to the part number

SIERRA #	O.E.M.	O.E. #	PAGE #	SIERRA #	O.E.M.	O.E. #	PAGE #
SIERRA							
18-5907	MERCURY MARINE	50-79604A3	599	18-5957	PLEASURECRAFT	RA097006	547
18-5907	MERCURY MARINE	50-97499A2	599	18-5957	MERCURY MARINE	78477	604
18-5907	OMC	981289	753	18-5957	MERCURY MARINE	78403A2	604
18-5907	OMC	982202	753	18-5957	MERCURY MARINE	92497A3	604
18-5907	MERCURY MARINE	50-97499R4	517, 546, 599, 605-607, 753	18-5957	OMC	982364	757
18-5908	CRUSADER	42091	517	18-5957	OMC	983424	757
18-5908	PLEASURECRAFT	RA122009	546	18-5957	OMC	983836	757
18-5908	MERCURY MARINE	50-76965A3	599	18-5957	OMC	985466	757
18-5908	MERCURY MARINE	50-808011A1	599	18-5957	OMC	986008	757
18-5908	OMC	981288	754	18-5957	VOLVO	3860769	822
18-5908	OMC	982195	754	18-5959	VOLVO	826495	822
18-5908	OMC	984982	754	18-5959	VOLVO	834609	822
18-5908	OMC	986007	754	18-5959	VOLVO	834963	822
18-5910	MERCURY MARINE	50-12177A2	599	18-5959	VOLVO	841762	822
18-5910	MERCURY MARINE	50-99418A2	599	18-5959	VOLVO	841765	822
18-5910	OMC	984456	754	18-5959	VOLVO	841766	822
18-5910	OMC	986505	754	18-5959	VALEO	A13N1M	822
18-5911	MERCURY MARINE	50-17251A3	598	18-5959	VALEO	A13N147M	823, 824
18-5911	MERCURY MARINE	50-76965A4	598	18-5959	VALEO	A13N148M	823, 824
18-5911	MERCURY MARINE	50-77328A3	598	18-5959	VALEO	A13N2M	823, 824
18-5911	MERCURY MARINE	50-99417A2	598	18-5960	MERCURY MARINE	807653T	604
18-5911	MERCURY MARINE	50-99419A3	598	18-5961			487, 508, 518, 549
18-5911	OMC	981078	753	18-5962			487, 508, 518, 549
18-5911	OMC	982121	753	18-59640	Prestolite		865
18-5911	OMC	983444	753	18-5965	MERCURY MARINE	805884T	604
18-5911	OMC	983790	753	18-5965	MERCURY MARINE	817119A1	604
18-5911	OMC	985966	753	18-5965	MERCURY MARINE	817119A4	604
18-5911	VOLVO	834893	821	18-5966	MERCURY MARINE	12449A1	604
18-5911	VOLVO	855326	821	18-5966	MERCURY MARINE	817119A4	604
18-5911	CHRIS-CRAFT	16.61-00042	484, 598, 605-607, 753, 821	18-5967	MERCURY MARINE	807652T	604
18-5913	MERCURY MARINE	50-863007A1	598	18-5968			605
18-5913	MERCURY MARINE	50-812428A3	599	18-59700	Volvo	3803227	822, 823
18-5913	MERCURY MARINE	50-812604A2	599	18-59700	Volvo	3803227-2	822, 823
18-5913	MERCURY MARINE	50-822330A2	599	18-59700	Volvo	834625-6	822, 823
18-5913	MERCURY MARINE	50-864340A2	599	18-59700	Volvo	841378-3	822, 823
18-5913	VOLVO	3587625	822	18-59700	Volvo	841380	822, 823
18-5913	VOLVO	3853982	822	18-59700	Volvo	841762	822, 823
18-5913	VOLVO	3856004	822	18-59700	Volvo	841763	822, 823
18-5913	VOLVO	3860764	822	18-59700	Volvo	841765	822, 823
18-5913	VOLVO	3885317	822	18-59700	Volvo	841766	822, 823
18-5913	OMC	3854751	754	18-5978	MOTOROLA	510-802	882-885
18-5913	VOLVO	3854751	822	18-5978	MERCURY MARINE	47487T	882-885
18-5916			882-885	18-5979	VOLVO	3860082	822
18-5917	OMC	984628	754	18-5982	Cummins	216040	578
18-5919	MERCURY MARINE	50-806963A4	599	18-5982	Cummins	3604234RX	578
18-5919	MERCURY MARINE	50-806965A2	599	18-5982	Cummins	862030T	604
18-5919	MERCURY MARINE	50-806965A4	599	18-5984	INDMAR	575011	537
18-5919	OMC	988217	753	18-5984	PLEASURECRAFT	RA097007B	547
18-5919	VOLVO	3856003	822	18-600-1212			100
18-5920	PLEASURECRAFT	RA122001	547	18-600-1414			100
18-5920	OMC	987811	547, 753, 822, 824	18-600-1418			100
18-5920	PLEASURECRAFT	RK122014	547, 753, 822, 824	18-600-3814			100
18-5920	OMC	3854190	753	18-600-3818			100
18-5920	VOLVO	3854190	822	18-600-3838			100
18-5923			598, 601, 753, 821	18-600-5614			100
18-5927			753, 821	18-600-5618			100
18-5929	MERCURY MARINE	892940T	317	18-6000	VOLVO	832598	862
18-5939	VOLVO	872235	823	18-6000	VOLVO	873179	862
18-5939	VOLVO	873770	823	18-6000A	VOLVO	832598	862
18-5939	VALEO	2541451	823	18-6000A	VOLVO	873179	862
18-5939	VOLVO	3803260	823	18-6001	VOLVO	838929	862
18-5939	VALEO	A13N234	823	18-6004	VOLVO	852835	862
18-5943	VALEO	541663	823	18-6004	VOLVO	873178	862
18-5943	VOLVO	872926	823	18-6004A	VOLVO	852835	862
18-5943	VOLVO	3803227	823	18-6004A	VOLVO	873178	862
18-5943	VALEO	A13N259	823	18-6005	VOLVO	875805	862
18-5945			604	18-6009	VOLVO	875815	862
18-5946			604	18-6009A	VOLVO	875815	862
18-5949			605	18-601-3814			100
18-5950	MERCURY MARINE	69729	604	18-6010	VOLVO	875821	862
18-5951	PLEASURECRAFT	RA097002	547	18-6010A	VOLVO	875821	862
18-5951	PLEASURECRAFT	RA097003	547	18-6011	HONDA	41107-ZW1-003ZA	207
18-5951	PLEASURECRAFT	RA097006	547	18-6011	MERCURY MARINE	31640Q4	382
18-5951	MERCURY MARINE	78477	604	18-6011	MERCURY MARINE	31640T6	207, 382, 734
18-5951	MERCURY MARINE	78403A2	604	18-6011	MERCURY MARINE	31640A1	382
18-5951	MERCURY MARINE	92497A3	604	18-6011	MERCURY MARINE	31640	382
18-5951	OMC	982364	757	18-6011A	HONDA	41107-ZW1-003ZA	207
18-5951	OMC	983424	757	18-6011A	MERCURY MARINE	31640Q4	382
18-5951	OMC	983836	757	18-6011A	MERCURY MARINE	31640T6	207, 382, 734
18-5951	OMC	985466	757	18-6011A	MERCURY MARINE	31640A1	382
18-5951	OMC	986008	757	18-6012	MERCURY MARINE	34127A1	734
18-5951	VOLVO	3867069	823	18-6012	MERCURY MARINE	34127T2	734
18-5953-1			605	18-6013	MERCURY MARINE	34762A1	734
18-5954	CHRYSLER INBOARD	3527501	496	18-6014	MERCURY MARINE	822777Q1	382
18-5954	CHRYSLER INBOARD	3527502	496	18-6014	MERCURY MARINE	46399A1	382, 734
18-5954	CHRYSLER INBOARD	3744870	496	18-6014	MERCURY MARINE	822777A1	382, 734
18-5956	MERCURY MARINE	69729	604	18-6014A	MERCURY MARINE	822777Q1	382
18-5957	PLEASURECRAFT	RA097002	547	18-6014A	MERCURY MARINE	46399A1	382, 734
18-5957	PLEASURECRAFT	RA097003	547	18-6014A	MERCURY MARINE	822777A1	382, 734
				18-6015-9	MERCURY MARINE	55989A3	734

1 This product is priced per piece. To order, priced per package, please add -9 to the part number
 2 Items ending in "D" are display packaged - regular number is non-display
 3 For discount shop pack of 10, please add -10 to the part number

SIERRA #	O.E.M.	O.E. #	PAGE #	SIERRA #	O.E.M.	O.E. #	PAGE #
SIERRA							
18-6015-9	MERCURY MARINE	55989Q9	734	18-6089	MERCURY MARINE	806190Q1	735
18-6015-9	MERCURY MARINE	55989T9	734	18-6089	MERCURY MARINE	806190T1	735
18-60151-9	MERCURY MARINE	55989A3	734	18-6090	YAMAHA	6G5-45251-01-00	454
18-60151-9	MERCURY MARINE	55989Q9	734	18-6091	YAMAHA	6H1-45251-02-00	454
18-60151-9	MERCURY MARINE	55989T9	734	18-6092	MERCURY MARINE	806190	735
18-6015A-9	MERCURY MARINE	55989A3	734	18-6092	MERCURY MARINE	806190A1	735
18-6015A-9	MERCURY MARINE	55989Q9	734	18-6092	MERCURY MARINE	806190Q1	735
18-6015A-9	MERCURY MARINE	55989T9	734	18-6092	MERCURY MARINE	806190T1	735
18-6016	MERCURY MARINE	76214Q5	382	18-6092A	MERCURY MARINE	806190	735
18-6016	MERCURY MARINE	76214T3	382	18-6092A	MERCURY MARINE	806190A1	735
18-6016	MERCURY MARINE	76214	382, 383, 707, 734	18-6092A	MERCURY MARINE	806190Q1	735
18-60161	MERCURY MARINE	76214Q5	382	18-6092A	MERCURY MARINE	806190T1	735
18-60161	MERCURY MARINE	76214T3	382	18-6093	MERCURY MARINE	806105A1	707
18-60161	MERCURY MARINE	76214	382, 734	18-6093	MERCURY MARINE	806105	735
18-6016A	MERCURY MARINE	76214Q5	382	18-6093	MERCURY MARINE	806105Q1	735
18-6016A	MERCURY MARINE	76214T3	382	18-6093	MERCURY MARINE	806105T1	735
18-6016A	MERCURY MARINE	76214	382, 734	18-6093A	MERCURY MARINE	806105A1	707
18-6017	OMC	123009	289	18-6093A	MERCURY MARINE	806105	735
18-6017	OMC	173029	289	18-6093A	MERCURY MARINE	806105Q1	735
18-6017A	OMC	123009	289	18-6093A	MERCURY MARINE	806105T1	735
18-6017A	OMC	173029	289	18-6094	MERCURY MARINE	821630	735
18-6018	OMC	327606	289	18-6094	MERCURY MARINE	821630A1	735
18-6019	OMC	982277	801	18-6094	MERCURY MARINE	821630Q1	735
18-6019	OMC	982438	801	18-6094	MERCURY MARINE	821630T1	735
18-6020	OMC	976669	289, 801	18-6094A	MERCURY MARINE	821630	735
18-6021	VOLVO	838928	863	18-6094A	MERCURY MARINE	821630A1	735
18-6024	OMC	436745	271, 273, 275, 289, 801	18-6094A	MERCURY MARINE	821630Q1	735
18-6024	OMC	393023	271, 273, 275, 289, 801	18-6094A	MERCURY MARINE	821630T1	735
18-6024A	OMC	436745	289, 801	18-6095	OMC	431708	289, 802
18-6024A	OMC	393023	289, 801	18-6095A	OMC	431708	289, 802
18-6025	HONDA	41107-ZV5-00	207	18-6096	YAMAHA	664-45371-01-00	454, 457, 459
18-6025	OMC	398331	207, 289, 801	18-6097	YAMAHA	6E5-45371-01-00	454, 463
18-6025	OMC	433458	207, 289, 801	18-6098	SUZUKI	55125-96310	407
18-6026	OMC	392462	289	18-6099	MERCURY MARINE	821629A1	701
18-6027	OMC	392123	289, 802	18-6099	MERCURY MARINE	821629	735
18-6028	OMC	3853818	802	18-6099	MERCURY MARINE	821629Q1	735
18-6028	OMC	3855412	802	18-6100	OMC	123009	289
18-6028	VOLVO	3855411	862	18-6100	OMC	173029	289
18-6028	OMC	984513	802, 862	18-6101	OMC	983494	802
18-6028	VOLVO	984513	802, 862	18-6102	OMC	3853818	802
18-6028A	OMC	3853818	802	18-6102	OMC	3855412	802
18-6028A	OMC	3855412	802	18-6102	VOLVO	3855412	802
18-6028A	VOLVO	3863193	862	18-6102	OMC	984513	802, 862
18-6028A	OMC	984513	802, 862	18-6103	OMC	984547	802
18-6029	OMC	397768	802	18-6103A	OMC	984547	802
18-6032	SUZUKI	55320-95310	407	18-6104	VOLVO	832598	862
18-6033	SUZUKI	55125-87D00	407	18-6104	VOLVO	873179	862
18-6034	YAMAHA	6K1-45371-00-00	454	18-6105	VOLVO	852835	862
18-6034A	YAMAHA	6K1-45371-00-00	882-885	18-6105	VOLVO	873178	862
18-6035	YAMAHA	6J9-45371-01-00	454, 465	18-6106	VOLVO	875821	862
18-6040			882-885	18-6107			477
18-6041-1			477	18-6108			882-885
18-6043-1			477	18-6109			882-885
18-6045			477	18-6111	YAMAHA	688-45371-02-00	454
18-6046			477	18-6112	YAMAHA	6J9-45371-01-00	454, 465
18-6047			477	18-6114	MERCURY MARINE	806189	735
18-6050			477	18-6114	MERCURY MARINE	806189A1	735
18-6052			477	18-6114	MERCURY MARINE	806189Q1	735
18-6053			477	18-6114	MERCURY MARINE	806189T1	735
18-6059			477	18-6115	OMC	433580	289
18-6060			477	18-6117A	MERCURY MARINE	806188A1	734
18-6062			477	18-6117A	MERCURY MARINE	806188A2	734
18-6063			882-885	18-6117M	MERCURY MARINE	806188A1	734
18-6066	MERCURY MARINE	43994A2	734	18-6117M	MERCURY MARINE	806188A2	734
18-6066	MERCURY MARINE	821631Q1	734	18-6117Z	MERCURY MARINE	806188A1	734
18-6066A	MERCURY MARINE	43994A2	734	18-6117Z	MERCURY MARINE	806188A2	734
18-6066A	MERCURY MARINE	821631Q1	734	18-6118A	YAMAHA	68V-11325-01-00	454
18-6067	MERCURY MARINE	806189	735	18-6119A	YAMAHA	61A-45371-00-00	454
18-6067	MERCURY MARINE	806189A1	735	18-6119Z	YAMAHA	61A-45371-00-00	454
18-6067	MERCURY MARINE	806189Q1	735	18-6120A	YAMAHA	61N-45251-01-00	454
18-6067	MERCURY MARINE	806189T1	735	18-6120Z	YAMAHA	61N-45251-01-00	454
18-6067A	MERCURY MARINE	806189	735	18-6121A	YAMAHA	6K1-45371-02-00	454
18-6067A	MERCURY MARINE	806189A1	735	18-6121Z	YAMAHA	6K1-45371-02-00	454
18-6067A	MERCURY MARINE	806189Q1	735	18-6122A	YAMAHA	69L-45371-00-00	454
18-6067A	MERCURY MARINE	806189T1	735	18-6122Z	YAMAHA	69L-45371-00-00	454
18-6068	HONDA	41109-ZW1-003	207	18-6123Z	VOLVO	873395	862
18-6068	MERCURY MARINE	826134Q	207, 382, 735	18-6124Z	VOLVO	872793	862
18-6068	MERCURY MARINE	826134	207, 382, 735	18-6125A	VOLVO	3586461	862
18-6070	YAMAHA	688-45371-02-00	454	18-6125M	VOLVO	3855610	862
18-6079	MERCURY MARINE	806105A1	707	18-6125Z	VOLVO	3854130	862
18-6079	MERCURY MARINE	806105	735	18-6126A	VOLVO	3888816	862
18-6079	MERCURY MARINE	806105Q1	735	18-6126M	VOLVO	3888818	862
18-6079	MERCURY MARINE	806105T1	735	18-6126Z	VOLVO	3888817	862
18-6080	MERCURY MARINE	821629A1	701	18-6127A	VOLVO	3888813	862
18-6080	MERCURY MARINE	821629	735	18-6127M	VOLVO	3888815	862
18-6080	MERCURY MARINE	821629Q1	735	18-6127Z	VOLVO	3888814	862
18-6080A	MERCURY MARINE	821629A1	701	18-6128A	Volvo		863
18-6080A	MERCURY MARINE	821629	735	18-6128M	Volvo		863
18-6080A	MERCURY MARINE	821629Q1	735	18-6128Z	Volvo		863
18-6089	MERCURY MARINE	806190	735	18-6129A	Volvo		863
18-6089	MERCURY MARINE	806190A1	735	18-6129M	Volvo		863

1 This product is priced per piece. To order, priced per package, please add -9 to the part number

2 Items ending in "D" are display packaged - regular number is non-display

3 For discount shop pack of 10, please add -10 to the part number

SIERRA #	O.E.M.	O.E. #	PAGE #	SIERRA #	O.E.M.	O.E. #	PAGE #
SIERRA							
18-6129Z	Volvo		863	18-6271	VOLVO	241812	825
18-6130	Volvo		863	18-6271	VOLVO	870670	825
18-6131	Volvo		863	18-6271	VOLVO	876038	825
18-6132A	Yamaha		454	18-6271	VOLVO	6643474	825
18-6132M	Yamaha		454	18-6273-1	MERCURY MARINE	99186	309
18-6133A	Yamaha		454	18-6273-1	MERCURY MARINE	99186-1	309
18-6133M	Yamaha		454	18-6273-1	MERCURY MARINE	99186T	309
18-6134			477	18-6274	VOLVO	852928	826
18-6135			477	18-6274	VOLVO	3857265	826
18-6136			477	18-6274	PRESTOLITE	HYK4001	826
18-6137			477	18-6274	MERCURY MARINE	14336A20	310, 603
18-6140	Universal	301068	478	18-6275	MERCURY MARINE	50-807904A1	598
18-6141	Universal	301069	478	18-6275	MERCURY MARINE	50-863007A1	598
18-6150A	MERCURY MARINE	888756Q02	735	18-6275	VOLVO	3857747	822
18-6150M	MERCURY MARINE	888756Q02	735	18-6275	VOLVO	3860566	822
18-6150Z	MERCURY MARINE	888756Q02	735	18-6276	OMC	984536	753
18-6154A			734	18-6276	OMC	988013	753
18-6154M			734	18-6277	OMC	435548	216
18-6154Z			734	18-6279	CHRYSLER FORCE	820545	188
18-6155Z			802	18-6279	CHRYSLER FORCE	F694541-1	188
18-6156A			382	18-6280	OMC	437801	216
18-6156M			382	18-6281	OMC	438786	216
18-6157A			382	18-6281	OMC	439937	216
18-6157M			382	18-6281	OMC	5005254	216
18-6158A	MERCURY MARINE	888756Q01	734	18-6282	MERCURY MARINE	50-8329972	318
18-6158M	MERCURY MARINE	888755Q01	734	18-6283	MERCURY MARINE	50-8331535	318
18-6158Z			734	18-6284			882-885
18-6159A	MERCURY MARINE	888758Q01	734	18-6285	OMC	433226	216
18-6159M	MERCURY MARINE	888757Q01	734	18-6286	CHRYSLER FORCE	827675A1	188
18-6159Z			734	18-6287			555, 599,
18-6160A	MERCURY MARINE	888761Q01	734				753, 754, 822
18-6160M	MERCURY MARINE	888760Q01	734	18-6288	INDMAR	575010	537
18-6160Z			734	18-6288	PLEASURECRAFT	RA097007B	547
18-6200	Yanmar	27210-200200	580	18-6291	OMC	3854194	755
18-6201	Yanmar	27210-200300	580	18-6291	VOLVO	3854194-2	825
18-6240	MERCURY MARINE	821630	735	18-6292	VOLVO	872241	822
18-6240	MERCURY MARINE	821630A1	735	18-6293	MERCURY MARINE	862031T	604
18-6240	MERCURY MARINE	821630Q1	735	18-6298	MERCURY MARINE	863077T	604
18-6240	MERCURY MARINE	821630T1	735	18-6299	MARINE POWER	402001	539
18-6241	HONDA	41107-ZW1-003ZA	207	18-6350	MERCURY MARINE	43-853640A2	711
18-6241	MERCURY MARINE	31640Q4	382	18-6350K	MERCURY MARINE	43-803104T1	710
18-6241	MERCURY MARINE	31640T6	207, 382, 734	18-6351	MERCURY MARINE	43-853641A2	711
18-6241	MERCURY MARINE	31640A1	382	18-6351K	MERCURY MARINE	43-803103T1	710
18-6241	MERCURY MARINE	31640	207, 382, 734	18-6352	MERCURY MARINE	43-853642A2	711
18-6242-9	MERCURY MARINE	55989A3	734	18-6352K	MERCURY MARINE	43-803106T1	710
18-6242-9	MERCURY MARINE	55989Q9	734	18-6353	MERCURY MARINE	43-853643A2	711
18-6242-9	MERCURY MARINE	55989T9	734	18-6353K	MERCURY MARINE	43-803105T1	710
18-6243	MERCURY MARINE	43994A2	734	18-6399	OMC	984264	791, 793
18-6243	MERCURY MARINE	821631Q1	734	18-6400	MERCURY MARINE	12784	712
18-6244	MERCURY MARINE	76214Q5	382	18-6401	MERCURY MARINE	12784A10	713
18-6244	MERCURY MARINE	76214T3	382	18-6401	MERCURY MARINE	864244A2	713
18-6244	MERCURY MARINE	76214	382, 734	18-6402	MERCURY MARINE	864281A2	713
18-6245	MERCURY MARINE	10-32470	383	18-6403	MERCURY MARINE	864282T	712
18-6246	YAMAHA	90105-10M00-00	454	18-6403	MERCURY MARINE	865492T	712
18-6249	MERCURY MARINE	43396A2	383	18-6405	MERCURY MARINE	864281A01	712
18-6249	MERCURY MARINE	818298A1	383	18-6405	MERCURY MARINE	865491A01	712
18-6249	MERCURY MARINE	818298Q1	383	18-6406	MERCURY MARINE	865493A01	713
18-6249A	MERCURY MARINE	43396A2	383	18-6406	MERCURY MARINE	865496A01	713
18-6249A	MERCURY MARINE	818298A1	383	18-6410	YAMAHA	689-81800-11	412
18-6249A	MERCURY MARINE	818298Q1	383	18-6410	YAMAHA	689-81800-12	412
18-6250			220, 320	18-6410	YAMAHA	689-81800-13-00	412, 413
18-6251			220, 320	18-6411	YAMAHA	6H3-81800-10	412
18-6252			216	18-6411	YAMAHA	6H3-81800-11-00	412, 413
18-6253			603	18-6412	YAMAHA	99999-03249-00	412
18-6254	MERCURY MARINE	392-2940	603	18-6412	YAMAHA	697-81800-12	412, 413
18-6255	MERCURY MARINE	392-8989	603	18-6413	YAMAHA	6E5-81800-11-00	412, 413
18-6256	MERCURY MARINE	392-2529	603	18-6413	YAMAHA	6E5-81800-12-00	412, 413
18-6257	OMC	982957	757	18-6414	SUZUKI	31100-95600	398
18-6257	OMC	983195	757	18-6415	YAMAHA	6N7-81800-10-00	412
18-6258	HONDA	36120-ZV5-821	201	18-6416	SUZUKI	31100-94610	397
18-6259	YAMAHA	6H1-43880-00-00	415	18-6417	SUZUKI	31100-92E00	397
18-6260			757	18-6418	NISSAN/TOHATSU	353-76010-4	394
18-6261	OMC	987774	757	18-6419	SUZUKI	31100-89J00	398
18-6261	OMC	3854182	757	18-6420	YAMAHA	6L2-81800-20-00	412
18-6261	OMC	3854809	757	18-6421	YAMAHA	6F5-81800-11	412
18-6261	OMC	3856600	757	18-6421	YAMAHA	6J4-81800-01-00	412
18-6261	OMC	3860171	757	18-6422	YAMAHA	6H4-81800-12-00	412
18-6261	VOLVO	3856600-6	822	18-6423	YAMAHA	688-81800-12-00	412
18-6261	OMC	3857561	757	18-6425	MERCURY MARINE	50-804312T1	318
18-6261	VOLVO	3857561	823	18-6425	YAMAHA	67F-81800-02-00	412
18-6263	UNIVERSAL	288182	555	18-6426	YAMAHA	68F-81800-01-00	412
18-6263	UNIVERSAL	288759	555	18-6427	YAMAHA	68V-81800-01-00	412
18-6264			882-885	18-6429	SUZUKI	31100-94702	398
18-6265	VOLVO	3857813	882-885	18-6430	NISSAN/TOHATSU	B29A-90500A	394
18-6266	VOLVO	872300	825	18-6431	NISSAN/TOHATSU	346-76010-0A0	394
18-6266	VOLVO	876040	825	18-6432	NISSAN/TOHATSU	3C8-76010-1	394
18-6268	VOLVO	841177	825	18-6433	HONDA	31200-ZV5-013	201
18-6268	VOLVO	872272	825	18-6434	OMC	386430	219
18-6270	OMC	984536	753	18-6435	MERCURY MARINE	50-859377T	317
18-6270	OMC	988013	753	18-6435	MERCURY MARINE	50-884044T	317
18-6270			496, 753	18-6435	MERCURY MARINE	50-888161T	317

1 This product is priced per piece. To order, priced per package, please add -9 to the part number
 2 Items ending in "D" are display packaged - regular number is non-display
 3 For discount shop pack of 10, please add -10 to the part number

SIERRA #	O.E.M.	O.E. #	PAGE #	SIERRA #	O.E.M.	O.E. #	PAGE #
SIERRA							
18-6436	MERCURY MARINE	50-834749	318	18-6763	MERCURY MARINE	92975A28	309
18-6436	MERCURY MARINE	50-859171T	318	18-6763	MERCURY MARINE	67914A2	603
18-6437	MERCURY MARINE	50-830308T	318	18-6763	MERCURY MARINE	92975A6	603
18-6437	MERCURY MARINE	50-859169T	318	18-6763	MERCURY MARINE	92975A32	603
18-6437	MERCURY MARINE	50-888151T	318	18-6763	MERCURY MARINE	79271A4	603
18-6438	MERCURY MARINE	50-854636T	318	18-6764	OMC	982069	758
18-6438	MERCURY MARINE	50-859170T	318	18-6764	OMC	982073	758
18-6438	MERCURY MARINE	50-884045T	318	18-6764	OMC	983318	758
18-6438	MERCURY MARINE	50-888160T	318	18-6765	MERCURY MARINE	823653A5	309
18-6439	CHRYSLER FORCE	50-803903T	188	18-6765	MERCURY MARINE	823653A9	309
18-6439	CHRYSLER FORCE	50-F575955	188, 189	18-6765	MERCURY MARINE	92459A4	309
18-6440	MERCURY MARINE	50-853329T	318	18-6767-1	OMC	172850	216
18-6440	MERCURY MARINE	50-892339T	318	18-6767-1	OMC	173564	216
18-6441	CHRYSLER FORCE	50-803900T	188	18-6767-1	OMC	173596	216
18-6441	CHRYSLER FORCE	50-F514955	188, 189	18-6768	MERCURY MARINE	93247A7	603
18-6443	PLEASURECRAFT	RA122019	546	18-6769-1	MERCURY MARINE	14336A8	603
18-6449	MERCURY MARINE	821663A1	Obsolete	18-6769-1	MERCURY MARINE	88183A5	603
18-6449	MERCURY MARINE	821663A1	Obsolete	18-6770	VOLVO	854346	826
18-6450	MARINE POWER	000E-05157	539	18-6771	MERCURY MARINE	18525A1	308, 603
18-6450	PLEASURECRAFT	RA0970007	539, 547	18-6772	MERCURY MARINE	17649	603
18-6450	PLEASURECRAFT	RA970007	539, 547	18-6772	MERCURY MARINE	17649T	603
18-6451	INDMAR	575014	537	18-6772	MERCURY MARINE	891736T	603
18-6452	PLEASURECRAFT	RA097009	547	18-6773	MERCURY MARINE	828708	309
18-6453	PLEASURECRAFT	RA097007C	547	18-6773	MERCURY MARINE	878265A4	309
18-6454	MERCURY MARINE	875285T1	317	18-6774	MERCURY MARINE	811628	309
18-6454	MERCURY MARINE	881248T02	317	18-6774	MERCURY MARINE	828708A1	309
18-6454	MERCURY MARINE	889955T01	317	18-6774	MERCURY MARINE	878265A6	309
18-6455	MERCURY MARINE	875286A1	317	18-6775	MERCURY MARINE	811673 1	188, 309
18-6455	MERCURY MARINE	875286T	317	18-6775	CHRYSLER FORCE	824051	188, 309
18-6455	MERCURY MARINE	881247A1	317	18-6777	MERCURY MARINE	854472A2	309
18-6456	VOLVO	855507	859	18-6777	CHRYSLER FORCE	818903A1	188, 309
18-6457	MERCURY MARINE	807757T	628	18-6777	CHRYSLER FORCE	819479A1	188, 309
18-6500	MERCURY MARINE	84-881262A2	317	18-6777	CHRYSLER FORCE	819480A1	188, 309
18-6501	OMC	307573	264	18-6777	CHRYSLER FORCE	822870A1	188, 309
18-6501	OMC	395460	264	18-6777	CHRYSLER FORCE	19217A1	188, 309
18-6503	OMC	318944	264	18-6777	CHRYSLER FORCE	19217A5	188, 309
18-6506	MERCURY MARINE	24-29340A1	366	18-6777	CHRYSLER FORCE	819762A4	188, 309
18-6506	MERCURY MARINE	24-29340T1	366	18-6777	CHRYSLER FORCE	819762A7	188, 309
18-6509	OMC	326877	264	18-6777	CHRYSLER FORCE	81977A8	188, 309
18-6511	OMC	312932	264	18-6777	CHRYSLER FORCE	81977A9	188, 309
18-6512	OMC	330525	264	18-6777	CHRYSLER FORCE	830250A3	188, 309
18-6513	OMC	203698	264	18-6777	CHRYSLER FORCE	830250T3	188, 309
18-6522	OMC	323653	264	18-6777	CHRYSLER FORCE	832021A1	188, 309
18-6522	OMC	338534	264	18-6777	CHRYSLER FORCE	832021A2	188, 309
18-6523			860	18-6777	CHRYSLER FORCE	832021T2	188, 309
18-6525	OMC	397003	288	18-6777	CHRYSLER FORCE	832021T4	188, 309
18-6526	OMC	397004	288	18-6777	CHRYSLER FORCE	855654A1	188, 309
18-6527	OMC	395911	288	18-6777	CHRYSLER FORCE	855654T2	188, 309
18-6528	OMC	396161	288	18-6777	MERCURY MARINE	818903A1	188, 309
18-6528	OMC	5000581	288	18-6777	MERCURY MARINE	819479A1	188, 309
18-6600	CHRYSLER INBOARD	2600402	505, 506	18-6777	MERCURY MARINE	819480A1	188, 309
18-6601	CHRYSLER INBOARD	0009231E	507	18-6777	MERCURY MARINE	819762A4-A7	188, 309
18-6749	MERCURY MARINE	42419A1	602	18-6777	MERCURY MARINE	81977A8-A9	188, 309
18-6749	MERCURY MARINE	862548A1	602	18-6777	MERCURY MARINE	822870A1	188, 309
18-6750	MERCURY MARINE	42419A1	602	18-6777	MERCURY MARINE	19217A1	188, 309
18-6750	MERCURY MARINE	862548A1	602	18-6777	MERCURY MARINE	19217A5	188, 309
18-6751	MERCURY MARINE	811618	308	18-6777	MERCURY MARINE	830250A3	188, 309
18-6751	MERCURY MARINE	811618A1	308	18-6777	MERCURY MARINE	830250T3	188, 309
18-6751	MERCURY MARINE	812843A1	308	18-6777	MERCURY MARINE	832021A1	188, 309
18-6751	MERCURY MARINE	813442A1	308	18-6777	MERCURY MARINE	832021A2	188, 309
18-6751	MERCURY MARINE	813442A2	308	18-6777	MERCURY MARINE	832021T2	188, 309
18-6751	MERCURY MARINE	893929A01	308	18-6777	MERCURY MARINE	832021T4	188, 309
18-6751	MERCURY MARINE	99660A1	308	18-6777	MERCURY MARINE	854472A3	188, 309
18-6752	MERCURY MARINE	14336A9	602	18-6777	MERCURY MARINE	854472A4	188, 309
18-6752	MERCURY MARINE	88183A12	602	18-6777	MERCURY MARINE	855654A1	188, 309
18-6753	MERCURY MARINE	14336A9	602	18-6777	MERCURY MARINE	855654T2	188, 309
18-6753	MERCURY MARINE	88183A12	602	18-6778	MERCURY MARINE	883166A2	603
18-6754	OMC	382138	757	18-6779	OMC	986280	758
18-6754	PRESTOLITE	ETK 4001	757	18-6779	OMC	3853945	758
18-6754	PRESTOLITE	ETK 4101	757	18-6779	VOLVO	986280	826
18-6754	PRESTOLITE	ETK 4102	757	18-6779	VOLVO	3853945	826
18-6755	OMC	982058	757	18-6780	OMC	438529	216
18-6755	OMC	982706	757	18-6780	OMC	438531	216
18-6755	PRESTOLITE	EVD 4001	757	18-6781	YAMAHA	6H1-43880-02-00	415
18-6755	PRESTOLITE	EVD 4002	757	18-6782	YAMAHA	61A-43880-02-00	415
18-6756			216	18-6782	YAMAHA	61A-43880-01-00	415
18-6757			309	18-6783	YAMAHA	64E-43880-00-00	415
18-6758	VOLVO	850834	826	18-6783	YAMAHA	64E-43880-01-00	415
18-6758	ELECTROLUX	5024/120	826	18-6784	MERCURY MARINE	824051	310
18-6759	OMC	391264	216	18-6785	SUZUKI	38100-87000-01T	399
18-6759	OMC	393988	216	18-6785	SUZUKI	38100-87E10-0ED	399
18-6759	OMC	394176	216	18-6785	SUZUKI	38100-87E20-0ED	399
18-6759	OMC	985237	216	18-6786-1			399
18-6760	YAMAHA	6G5-43880-02-00	415	18-6786-1	SUZUKI	38100-87D10-0ED	399
18-6761	OMC	387277	216	18-6786-1	SUZUKI	38100-87D10-01T	399
18-6761	OMC	582048	216	18-6786-1	SUZUKI	38100-87D10-35J	399
18-6761	OMC	582155	216	18-6786-1	SUZUKI	38100-92E00-0ED	399
18-6761	OMC	584107	216	18-6787	YAMAHA	67F-43880-00-00	415
18-6762	CHRYSLER FORCE	455541	188, 216	18-6788	YAMAHA	6H5-43880-02-00	415
18-6762	CHRYSLER FORCE	449541-3	188	18-6789	YAMAHA	62X-43880-09-00	415
18-6762	OMC	172543	216	18-6790	VOLVO	839430	826

1 This product is priced per piece. To order, priced per package, please add -9 to the part number

2 Items ending in "D" are display packaged - regular number is non-display

3 For discount shop pack of 10, please add -10 to the part number

SIERRA #	O.E.M.	O.E. #	PAGE #	SIERRA #	O.E.M.	O.E. #	PAGE #
SIERRA							
18-6790	ELECTROLUX	KS3448/290	826	18-6839	Volvo	5003564	822
18-6791	VOLVO	850046	826	18-6839	Volvo	5003564-1	822
18-6791	VOLVO	852520	826	18-6840	Mercury	50-897755T	317
18-6792	VOLVO	854329	826	18-6840	Mercury	897755T	317
18-6792	VOLVO	897720	826	18-6841	Mercuriser	56045	604, 757
18-6793	HONDA	36120-ZV5-822	201	18-6841	Mercuriser	59755	604, 757
18-6793	SUZUKI	38100-87J11	399	18-6841	Mercuriser	69729	604, 757
18-6793	SUZUKI	38100-87J20	399	18-6841	OMC	988247	604, 757
18-6798	YAMAHA	60V-43880-00-00	414	18-6841	OMC	983836	604, 757
18-6798	YAMAHA	69J-43880-00-00	414	18-6842	Mercuriser	56045	604, 757
18-6799	MERCURY MARINE	93247A7	603	18-6842	Mercuriser	59755	604, 757
18-6800	MERCURY MARINE	855998A09	309	18-6842	Mercuriser	69729	604, 757
18-6801	OMC	5005113	217	18-6842	OMC	983424	604, 757
18-6802	OMC	5005114	217	18-6842	OMC	983836	604, 757
18-6803	OMC	5005115	217	18-6842	OMC	983247	604, 757
18-6803	OMC	5007662	217	18-6843	Mando	A000B0341	865
18-6804	VOLVO	3861575	826	18-6843	Yamaha	19-1400-10	865
18-6805	VOLVO	3858071	826	18-6843	Mando	TA000B0341	865
18-6806	VOLVO	3587079	826	18-6844	Mercuriser	834832	604
18-6806	VOLVO	3857489	826	18-6844	Mercuriser	834832T2	604
18-6806	VOLVO	3860879	826	18-6844	Denso	101211-3460	604
18-6811	Yamaha	62X-43880-00-00	413	18-6844	Mercuriser	857006A3	604
18-6811	Yamaha	62X-43880-01-00	413	18-6845	Volvo	3862613	823
18-6812	Yamaha	62X-43880-00-00	413	18-6845	Volvo	3862665	823
18-6812	Yamaha	62X-43880-01-00	413	18-6845	Volvo	3884950	823
18-6812	Yamaha	62X-43880-09-00	413	18-6846	Volvo Penta	1502272	578, 823
18-6813	Mercuriser	14336A6	603	18-6846	Volvo Penta	3803270-2	578, 823
18-6813	Mercuriser	14336A8	603	18-6846	Volvo Penta	5001677	578, 823
18-6813	Mercuriser	14336A9	603	18-6846	Volvo Penta	845940	578, 823
18-6813	Mercuriser	14336A15	603	18-6846	Volvo Penta	72021	578, 823
18-6813	Mercuriser	14336A20	603	18-6846	Volvo Penta	872022	578, 823
18-6813	Mercuriser	88183A5	603	18-6846	Volvo Penta	872757	578, 823
18-6813	Mercuriser	88183A8	603	18-6846	Volvo Penta	873635	578, 823
18-6813	Mercuriser	88183A12	603	18-6846	Volvo Penta	873757	578, 823
18-6813	Mercuriser	865380A13	603	18-6846	Volvo Penta	873757-9	578, 823
18-6813	Mercuriser	865380A25	603	18-6846	Volvo Penta	873771,	578, 823
18-6814	OMC	984356	758	18-6847	Volvo	3862613	823
18-6815	Johnson/Evinrude	5005831	216	18-6847	Volvo	2655301	823
18-6816	OMC	172588	758	18-6848	Volvo	3862612	824
18-6816	OMC	173944	758	18-6848	Volvo	2656299	824
18-6817	Volvo Penta	854525-3	826	18-6848	Valeo	A0002655299	824
18-6818	Power Pole	PUMP SPN-F	60	18-6849	Yanmar	119773-77200	578
18-6819	Power Pole	PUMP PRO-F	60	18-6849	Denso	101211-9940	578
18-6821	Yamaha	688-43880-11-00	413	18-6850	Universal	Universal	56
18-6821	Yamaha	6E5-43880-01-00	413	18-6851	Universal	Universal	56
18-6821	Yamaha	6E5-43880-02-00	413	18-6852	Universal	Universal	56
18-6822	Volvo Penta	852928,	826	18-6853	Universal	Universal	56
18-6822	Volvo Penta	820545	826	18-6854	Universal	Universal	56
18-6822	OMC	382715	826	18-6855	Universal	Universal	56
18-6822	OMC	172543	826	18-6856	Universal	Universal	56
18-6823	Universal	Universal	201, 216, 394, 399, 413, 603, 758, 826	18-6857	Yamaha PWC	63M-81960-00-00	471
18-6824	Mercuriser	50-60594A	600	18-6858	Yamaha PWC	6H2-81960-00-00	471
18-6824	Mercuriser	50-60594A1	600	18-6859	Sea-Do	278-001-376	470
18-6824	Mercuriser	50-60594T01	600	18-6859	Sea-Do	278-001-802	470
18-6825	Mercury	50-86976	319	18-6860	Sea-Do		470
18-6826	Johnson/Evinrude	586768	220	18-6861	Yamaha	61A-81800-01-00	413
18-6827	Suzuki	31100-94600	398	18-6861	Yamaha	69L-81800-00-00	413
18-6827	Suzuki	31100-94601	398	18-6861	Yamaha	69L-81800-00-00	413
18-6827	Suzuki	31100-94610	398	18-6861	Hitachi	S114-559B	413
18-6828	Mercury	50-41583	319	18-6862	Yamaha	6M6-81800-10-00	470
18-6829	Mercury	50-852570	319	18-6863	OMC	584605, 586275	220
18-6829	Mercury	50-852570T	319	18-6864	Mercury	50-819271	319
18-6829	Mercury	50-857065	319	18-6864	Mercury	50-820193A1	319
18-6829	Mercury	50-859168	319	18-6865	Honda	Universal	201, 216, 394, 399, 413
18-6829	Mercury	50-859168T	319	18-6865	OMC	5005114	201, 216, 394, 399, 413
18-6829	Mercury	859168	319	18-6865	Suzuki	48600-94511-0ED	399
18-6829	Mercury	859168T	319	18-6865	Tohatsu	Universal	201, 216, 394, 399, 413
18-6831	Suzuki	31100-90J00	398				
18-6831	Hitachi	S114-837	398				
18-6831	Hitachi	S114-837A	398	18-6865	Yamaha	Universal	201, 216, 394, 399, 413
18-6832	Yamaha	60V-81800-00-00	412				
18-6832	Yamaha	60X-81800-00-00	412	18-6866	Sea-Do	278-000-576	470
18-6833	Yamaha	69J-81800-00-00	412	18-6866	Sea-Do	278-000-577	470
18-6834	GM Engines	Universal	517, 565, 600, 753, 822, 865	18-6866	Sea-Do	278-001-038	470
18-6835	GM Engines	Universal	484, 496, 517, 537, 600, 753, 822, 865	18-6866	Sea-Do	278-001-301	470
18-6836	Yamaha	6C5-43880-00-00	413	18-6867	Sea-Do	278-000-484	470
18-6837	Honda	36120-ZV5-822	201, 399	18-6867	Sea-Do	278-000-485	470
18-6837	Suzuki	38100-87J11	201, 399	18-6867	Sea-Do	278-001-300	470
18-6837	Suzuki	38100-87J20	201, 399	18-6867	Sea-Do	278-001-935	470
18-6838	Volvo	3586765	826	18-6867	Denso	228000-4550	470
18-6838	Volvo	852928	826	18-6868	Sea-Do	278-000-186	470, 472
18-6838	Volvo	872449	826	18-6868	Sea-Do	278-000-311	470, 472
18-6838	Volvo	873051	826	18-6868	Sea-Do	278-000-316	470, 472
18-6839	Volvo	1357199	822	18-6868	Denso	995435	470, 472
18-6839	Volvo	1357199-7	822	18-6868	Denso	128000-4861	470, 472
18-6839	Volvo	3523301	822	18-6868	Denso	128000-4862	470, 472
18-6839	Volvo	3523301-4	822	18-6868	Denso	128000-4863	470, 472
18-6839	Volvo		822	18-6868	Denso	128000-4864	470, 472
18-6839	Volvo		822	18-6868	Denso	128000-4860	470

1 This product is priced per piece. To order, priced per package, please add -9 to the part number
 2 Items ending in "D" are display packaged - regular number is non-display
 3 For discount shop pack of 10, please add -10 to the part number

SIERRA #	O.E.M.	O.E. #	PAGE #	SIERRA #	O.E.M.	O.E. #	PAGE #
SIERRA							
18-6869	Sea-Doo	278-001-497	470	18-6936	Yanmar	114399-77010	579
18-6869	Sea-Doo	278-001-936	470, 472	18-6937	Yanmar	128170-77010	579
18-6870	Mercury	50-805833	578, 600	18-6937	Yanmar	128170-77010D	579
18-6870	Mercury	50-805833T	578, 600	18-6937	Hitachi	S114-303	579
18-6871	Sea-Doo	278-001-292	471, 472	18-6937	Hitachi	S114-303A	579
18-6872	Volvo	233991	578, 822	18-6938	Yanmar	119773-77010	579
18-6872	Volvo	240501	578, 822	18-6939	Yanmar	121254-77010	579
18-6872	Volvo	837924	578, 822	18-6939	Yanmar	121254-77011	579
18-6872	Volvo	842775	578, 822	18-6939	Yanmar	121254-77012	579
18-6872	Volvo	843511	578, 822	18-6939	Yanmar	121254-77019	579
18-6872	Volvo	847306-8	578, 822	18-6939	Yanmar	129429-77010	579
18-6872	Volvo	881681	578, 822	18-6939	Yanmar	129429-77011	579
18-6873	Kawasaki	21163-3715	470	18-6940	Mercury	50-825991A2	320
18-6873	Kawasaki	21163-3719	470, 472	18-6941	Suzuki	31100-93J00	398
18-6873	Denso	428000-0081	470	18-6941	Suzuki	31100-96J00	398
18-6874	Sea-Doo	278-001-581	471	18-6941	Suzuki	31100-96J01	398
18-6875	Kawasaki PWC	21174-3703	471	18-6942	Yamaha	69W-81800-00-00	413
18-6876	Sea-Doo	278-001-554	471	18-6942	Hitachi	S114-682	413
18-6877	Honda PWC	31200-HW1-671	470	18-6943	Mercury	50-893894	320
18-6878	Sea-Doo	278-000-123	471	18-6943	Yamaha	66M-81800-01-00	320, 413
18-6879	Sea-Doo	278-001-239	471	18-6943	Yamaha	66M-81800-02-00	320, 413
18-6880	Yanmar	129573-77010	578	18-6944	Bosch	0-001-109-035	579
18-6880	Yanmar	171008-77010	578	18-6944	Caterpillar	163-3361	579
18-6880	Hitachi	S114-257	578	18-6944	Perkins	185086600	579
18-6880	Hitachi	S114-257G	578	18-6944	Volvo	21323043	579
18-6880	Hitachi	S114-483	578	18-6944	Volvo	3583555	579
18-6880	Hitachi	S114-483A	578	18-6945	Johnson	5036972	220, 398
18-6881	Volvo	852928	826	18-6945	Suzuki	31100-95J00	398
18-6881	Volvo	872449	826	18-6945	Suzuki	31100-95J01	220, 398
18-6881	Prestolite	873051	826	18-6946	Mercuriser	50-8m8021116	600
18-6904	Kawasaki	21163-3720	471	18-6947	Mercuriser	50-805991	579, 600
18-6904	Kawasaki	21163-3720	471	18-6948	Mercury	882571	579, 600
18-6905	Sea-Doo	290-888-993	470	18-6949	Mercuriser	50-831001961	579, 600
18-6905	Sea-Doo	290-888-999	470, 472	18-6949	Mercuriser	50-831001562	579, 600
18-6905	Sea-Doo	420-888-9933	470	18-6950	OMC	982019	758
18-6905	Sea-Doo	420-888-994	470, 472	18-6951	VOLVO	851120	825
18-6905	Sea-Doo	420-888-996	470, 472	18-6952	Cummins	214169	578
18-6906	Yamaha PWC	64X-81800-00-00	470	18-6952	Cummins	3603853RX	578
18-6907	Yamaha PWC	6D3-81800-00-00	470	18-6952	Cummins	3920618	578
18-6908	Yamaha PWC	63M-81800-00-00	471	18-6952	Delco	10459244	578
18-6909	Yamaha PWC	65S-81800-00-00	471	18-6952	Delco	1100077	578
18-6919	Arctic Cat PWC	3008-093	471	18-6952	Delco	1100093	578
18-6919	Arctic Cat PWC	3008-327	471, 472	18-6952	Delco	1100211	578
18-6919	Arctic Cat PWC	3008-462	471	18-6952	Delco	1100274	578
18-6919	Arctic Cat PWC	3008-536	471	18-6952	Delco	1105474	578
18-6921	Yamaha PWC	60E-81800-00-00	471	18-6952	Delco	1105475	578
18-6925	Yanmar	128270-77200	578	18-6952	Delco	1105476	578
18-6925	Hitachi	LR135-105	578	18-6953	Volvo	3803645	578, 824
18-6926	Yanmar	119836-77200	578	18-6953	Volvo	8602629	578, 824
18-6926	Yanmar	119836-77200-2	578	18-6953	Volvo	8602710	578, 824
18-6926	Yanmar	119836-77200-3	578	18-6953	Volvo	8602714	578, 824
18-6926	Yanmar	129612-77230	578	18-6953	Volvo	8676496	578, 824
18-6927	Yanmar	119573-77200	578	18-6953	Volvo	8676498	578, 824
18-6927	Yanmar	119573-77201	578	18-6953	Volvo	8676499	578, 824
18-6927	Yanmar	129470-77200	578	18-6954	Mercury	50-831001671	579
18-6928	Yanmar	128170-77200	578	18-6954	Mercury	50-831001672	579
18-6928	Yanmar	128170-77201	578	18-6954	Mercury	50-831002050	579
18-6928	Yanmar	128170-77202	578	18-6954	Mercury	672, 50-831002051	579
18-6928	Hitachi	LR135-74	578	18-6954	Mercury	672, 50-831002052	579
18-6928	Hitachi	LR135-74B	578	18-6955	Caterpillar	10-258	578, 824
18-6929	Yanmar	119573-77200	578	18-6955	Caterpillar	3001117	578, 824
18-6929	Yanmar	119573-77201	578	18-6955	Prestolite	110-258	578, 824
18-6929	Hitachi	129470-77200	578	18-6955	Prestolite	110-258A	578, 824
18-6929	Hitachi	LR180-03A	578	18-6955	Volvo	849748-9	578, 824
18-6929	Hitachi	LR180-03B	578	18-6956	Volvo	6209190	822
18-6929	Hitachi	LR180-03C	578	18-6957	Mercuriser	50-801333980	579, 600
18-6930	Yanmar	104211-77010	578	18-6957	Mercuriser	50-854178	579, 600
18-6930	Yanmar	104211-77011	578	18-6957	Mercuriser	50-855507	579, 600
18-6931	Yanmar	119209-77010	579	18-6958	Volvo	847308-4	579, 822
18-6931	Yanmar	121120-77010	579	18-6958	Volvo	881682	579, 822
18-6931	Yanmar	121120-77011	579	18-6958	Volvo	870998	579, 822
18-6931	Yanmar	121120-77012	579	18-6959	Honda	31200-ZY6-003	201
18-6931	Yanmar	124520-77011	579	18-6959	Honda	31200-ZY9-003	201
18-6931	Yanmar	124520-77010	579	18-6959	Honda	31200-ZY9A-0031	201
18-6932	Yanmar	121370-77010	579	18-6960	Mercuriser	821663	605
18-6932	Yanmar	129698-77010	579	18-6960	Mercuriser	821663-1	605
18-6932	Yanmar	129242-77010	579	18-6960	Mercuriser	821663A1	605
18-6934	Yanmar	123500-77010,	579	18-6960	Denso	101211-3021	605
18-6934	Yanmar	124610-77010	579	18-6960	Denso	101211-3020	605
18-6934	Yanmar	124610-77019	579	18-7000	VOLVO	841292	828
18-6934	Yanmar	424610-77010	579	18-7000	VOLVO	856471	828
18-6934	Hitachi	S13-68	579	18-7000	VOLVO	856472	828
18-6934	Hitachi	S13-68A	579	18-7000	VOLVO	841836-0	828
18-6934	Hitachi	S13-68C	579	18-7001	VOLVO	841293-4	828
18-6934	Hitachi	S13-86	579	18-7002	YAMAHA	6E5-W0093-06-00	415
18-6935	Yanmar	119225-77010	579	18-70021			644
18-6935	Yanmar	119225-77011	579	18-7004	MERCURY MARINE	1395-6200	321
18-6935	Yanmar	119226-77010	579	18-7005	MERCURY MARINE	1395-6452	321
18-6936	Yanmar	114361-77011	579	18-7006-1	MERCURY MARINE	879194024	321
18-6936	Yanmar	114362-77010	579	18-7006-1	MERCURY MARINE	1399-1717	321
18-6936	Yanma	114362-77011	579	18-7006-1	MERCURY MARINE	1399-2015	321

1 This product is priced per piece. To order, priced per package, please add -9 to the part number

2 Items ending in "D" are display packaged - regular number is non-display

3 For discount shop pack of 10, please add -10 to the part number

SIERRA #	O.E.M.	O.E. #	PAGE #	SIERRA #	O.E.M.	O.E. #	PAGE #
SIERRA							
18-7006-1	MERCURY MARINE	1399-3523	321	18-7070	MERCURY MARINE	1397-2637	615
18-7006-1	MERCURY MARINE	1395-4808	321	18-7070	MERCURY MARINE	1397-3464	615
18-7006-1	MERCURY MARINE	1395-879194024	321	18-7070	MERCURY MARINE	1397-7542	615
18-7007	MERCURY MARINE	1399-5135	322	18-7070	MERCURY MARINE	1397-7543	615
18-7007	MERCURY MARINE	1399-5198	322	18-7070	MERCURY MARINE	1397-8872	615
18-7008			148, 827, 828	18-7070	OMC	383615	760
18-7010	OMC	382050	222	18-7070	OMC	982384	760
18-7010	OMC	382051	222	18-7070			760
18-7010	OMC	382054	222	18-70704	MERCURY MARINE	32-89653	645
18-7013			322	18-70704	VOLVO	838513	837
18-7017	PLEASURECRAFT	RN0118-1	548	18-70704	VOLVO	856306	837
18-7017	PLEASURECRAFT	RN0120-1	548	18-70704			644, 645, 770, 837
18-7017	OMC	985052	760	18-7071	MERCURY MARINE	1397-3458	615
18-7018	OMC	981790	760	18-7071	OMC	380186	760
18-7018	OMC	982352	760	18-7071			147, 148, 555, 615, 617, 618, 760, 762
18-7019			147, 148, 485, 486, 518, 519	18-7072	MERCURY MARINE	1397-3306	616
18-7021				18-7072	MERCURY MARINE	1397-4329	616
18-7022			146, 485, 486, 518, 519	18-7072	MERCURY MARINE	1397-5635	616
18-7023			146, 485, 486	18-7072	MERCURY MARINE	1397-6638	616
18-7024	OMC	382052	222	18-7072	MERCURY MARINE	823426A1	616
18-7024	OMC	382053	222	18-7072	OMC	384743	760
18-7024	OMC	385356	222	18-7072	OMC	979659	760
18-7025			146, 485, 486	18-7072	VOLVO	855889	828
18-7026	OMC	382057	222	18-7072			616
18-7033	CHRYSLER FORCE	FK10003	189	18-7073	Yamaha	6E8-14390-12	417
18-7033	CHRYSLER FORCE	FK10026	189	18-7075	MERCURY MARINE	1397-5830	615
18-7033	CHRYSLER FORCE	FK10053	189	18-7075	MERCURY MARINE	1397-5831	615
18-7033	CHRYSLER FORCE	FK10102-1	189	18-7075	MERCURY MARINE	1397-7099	615
18-7037	CHRYSLER FORCE	FK10004	189	18-7075	MERCURY MARINE	1397-8760	615
18-7037	CHRYSLER FORCE	FK10005	189	18-7076	MERCURY MARINE	1397-6367	616
18-7037	CHRYSLER FORCE	FK10007	189	18-7076	MERCURY MARINE	1397-6367A1	147, 148, 613, 616, 618
18-7037	CHRYSLER FORCE	FK10008	189	18-7077	MERCURY MARINE	1397-8952	616
18-7037	CHRYSLER FORCE	FK10027	189	18-7077	MERCURY MARINE	823426A1	616
18-7037	CHRYSLER FORCE	FK10057	189	18-7078	MERCURY MARINE	1397-2605	616
18-7037	CHRYSLER FORCE	FK10108	189	18-7078			147, 148, 518, 519, 616, 618
18-7037	CHRYSLER FORCE	FRK739	189				
18-7038	OMC	379312	222	18-7079	Yamaha	626-14390-90	417
18-7038	OMC	387262	222	18-7080	MERCURY MARINE	1398-3089	616
18-7038	OMC	396520	222	18-7080	OMC	979719	760
18-7039			146	18-7081	PLEASURECRAFT	RN0116	548
18-7040			147, 148, 827, 828	18-7081	PLEASURECRAFT	RN0116-2	548
18-7041	CHRYSLER FORCE	F016311	189	18-7081	MERCURY MARINE	1396-4656	616
18-7042	OMC	392061	222	18-7081	OMC	982537	760
18-7042	OMC	396701	222	18-7081	OMC	983538	146, 147, 548, 613, 616, 760
18-7042	OMC	398729	222				
18-7043	OMC	382045	222	18-7083	Mercury	858763	331
18-7043	OMC	382046	222	18-7085	VOLVO	875407	828
18-7043	OMC	382047	222	18-7086	OMC	984487	760
18-7043	OMC	382049	222	18-7086	VOLVO	841994	828
18-7043	OMC	383052	222	18-7086			147, 148, 518, 519, 760, 762, 763, 827, 828
18-7043	OMC	383067	222				
18-7043	OMC	398532	222	18-7089			146, 497
18-7043	OMC	439071	222	18-7091			146, 497
18-7044			222	18-70924			644
18-7046	OMC	390055	222	18-70925	MERCURY MARINE	32-160211	643
18-7046	OMC	392550	222	18-70926	MERCURY MARINE	32-73796	643, 645
18-7046	OMC	398526	222	18-70927	MERCURY MARINE	32-73795	643, 645
18-7046	OMC	434888	222	18-70928	MERCURY MARINE	32-71613	644, 645
18-7046	OMC	435443	222	18-70929	MERCURY MARINE	32-73794	644, 645
18-7046	OMC	439076	222	18-7093	OMC	378895	222
18-7047	Honda	16011-ZV4-005	203	18-7093	OMC	396521	222
18-7048	Honda	16011-881-741	203	18-7093	OMC	678882	222
18-7049	Yamaha	6L2-14392-00	417, 418	18-70930	MERCURY MARINE	32-52481	644, 645
18-7050	Honda		203	18-70931	MERCURY MARINE	32-96879	644, 645
18-7051	Honda		203	18-70932	MERCURY MARINE	32-871171	644
18-7052	Honda		203	18-70933	MERCURY MARINE	32-861634	642, 645
18-7053	Honda		203	18-70934	MERCURY MARINE	32-897181	642
18-7054	Yamaha	6G1-14546-01	417, 418	18-70935	MERCURY MARINE	32-806856	642, 645
18-7055	Yamaha	6E5-14546-00	417	18-70936	OMC	340975	249
18-7056	Yamaha	6H3-14590-00	417-419	18-70937	OMC	340976	249
18-7057	CHRYSLER FORCE	F010790	189	18-70938	MERCURY MARINE	32-8066351	642
18-7057	MERCURY MARINE	1395-9258	323	18-70939	MERCURY MARINE	32-8066361	642
18-7057	MERCURY MARINE	1399-1138	323	18-7094	OMC	379313	222
18-7057	MERCURY MARINE	1399-1473	323	18-7094	OMC	396522	222
18-7057	MERCURY MARINE	1395-9258 1	323	18-70940	MERCURY MARINE	32-860144	643, 645
18-7058	Yamaha	63V-W0093-00	415, 418	18-70941	MERCURY MARINE	32-807697	643, 645
18-7059	Yamaha	677-W0093-04	415, 418	18-70942	MERCURY MARINE	32-897301	643
18-7060	Yamaha	692-14590-00	417-419	18-70943	MERCURY MARINE	32-897491	643
18-7061	MERCURY MARINE	1395-8318	323	18-70944	MERCURY MARINE	32-861590A05	641
18-7061	MERCURY MARINE	1395-83181	323	18-70945	MERCURY MARINE	32-862139	641
18-7062	MERCURY MARINE	1395-95951	323	18-70946	MERCURY MARINE	32-8066362	642
18-7063	Yamaha	6L2-14385-00	417	18-70947	MERCURY MARINE	32-862124	642
18-7064	Yamaha	63V-14985-00	417	18-70948	MERCURY MARINE	32-808033	641
18-7065	Yamaha	647-14385-00	417	18-70949	MERCURY MARINE	32-807407	641
18-7066	Yamaha	648-14385-00	417	18-7095			146
18-7067	Yamaha	6G1-14985-00	417	18-7095			146
18-7068	Yamaha	6E5-14385-01	417	18-7095	CRUSADER	45334	518
18-7069	Yamaha	6E5-14385-02	417	18-7095	MERCURY MARINE	1397-7539	616
18-7070	MERCURY MARINE	1397-2072	615	18-7095	MERCURY MARINE	1397-7540	616

1 This product is priced per piece. To order, priced per package, please add -9 to the part number
 2 Items ending in "D" are display packaged - regular number is non-display
 3 For discount shop pack of 10, please add -10 to the part number

SIERRA #	O.E.M.	O.E. #	PAGE #	SIERRA #	O.E.M.	O.E. #	PAGE #
SIERRA							
18-7095	MERCURY MARINE	1397-7544	616	18-7135	VOLVO	3852089	864
18-7095	MERCURY MARINE	1397-8535	616	18-7135	MERCURY MARINE	25-35276	198, 383, 384, 391, 739
18-7095	MERCURY MARINE	1397-9723	616	18-7135	OMC	310584	296
18-7095	OMC	383918	760	18-7137	OMC	318372	296
18-7095	OMC	983864	760	18-7138	OMC	318717	296
18-7095	VOLVO	834985-4	827	18-7139	OMC	319085	808
18-70950	MERCURY MARINE	32-807661	642	18-7140	SUZUKI	09280-75002	409
18-70951	MERCURY MARINE	32-860205	641	18-7140	OMC	320303	296
18-70952	MERCURY MARINE	32-887952	641	18-7141	VOLVO	3852165	864
18-70953	MERCURY MARINE	32-8080441	641	18-7141	OMC	321117	296
18-70954	MERCURY MARINE	32-8600891	641	18-7142	OMC	322119	289, 296, 299, 803, 805, 808-810
18-70955	MERCURY MARINE	32-16011	641	18-7143	VOLVO	3852169	864
18-70956	MERCURY MARINE	32-16012	641	18-7143	OMC	331188	808
18-70957	MERCURY MARINE	32-41642A3	642	18-7143	OMC	322501	296
18-70958	MERCURY MARINE	32-96246A4	642	18-7143	MERCURY MARINE	25-65936	357, 391, 739
18-7096	PLEASURECRAFT	RN0118	548	18-7144	OMC	326849	296
18-7096	PLEASURECRAFT	RN0120	548	18-7144	OMC	333572	296
18-7096	MERCURY MARINE	1396-5222	616	18-7145	OMC	25-64068	357, 391, 739
18-7096	MERCURY MARINE	1396-5238	616	18-7145	MERCURY MARINE	25-64068	357, 391, 739
18-7096	OMC	982539	761	18-7146	OMC	554545	296
18-7096	OMC	85R-4541	761	18-7146	MERCURY MARINE	25-47632	391, 739
18-7097	MERCURY MARINE	3302-804845	616	18-7149	VOLVO	955989	864
18-7097	MERCURY MARINE	3302-9437	616	18-7150	OMC	303598	296
18-7098-1	MERCURY MARINE	3302-804844002	616	18-7150	OMC	331380	296
18-7099	VOLVO	824803	828	18-7150	OMC	334913	296
18-7099	VOLVO	856470	828	18-7151	MERCURY MARINE	25-20081	355, 356, 391, 739
18-7100	CHRYSLER FORCE	25-85594	291	18-7152	OMC	307082	296
18-7100	MERCURY MARINE	25-85594	291	18-7152	MERCURY MARINE	25-20863	354, 391, 739
18-7100	OMC	301877	296	18-7153	MERCURY MARINE	25-21836	391
18-7101	OMC	305739	296	18-7153	OMC	911851	296
18-7102	VOLVO	3852073	864	18-7153	OMC	3852565	296
18-7102	OMC	307450	296	18-7154	VOLVO	949656	864
18-7102	MERCURY MARINE	25-62706	391, 735	18-7155	OMC	305270	296
18-7103	OMC	308624	296	18-7155	MERCURY MARINE	25-26855	739
18-7103	MERCURY MARINE	25-29845	739	18-7156	OMC	309731	296
18-7104	OMC	308627	289, 296, 298, 808, 809	18-7156	MERCURY MARINE	25-29439	384, 391, 739
18-7105	OMC	311338	296	18-7157	MERCURY MARINE	25-29976	739
18-7105	MERCURY MARINE	25-62705	353, 354, 391, 696, 735, 739	18-7157	OMC	310967	231
18-7106	OMC	307583	222	18-7158	OMC	310585	296
18-7107	OMC	313175	296	18-7158	MERCURY MARINE	25-30613	739
18-7107	MERCURY MARINE	25-67202	391, 739	18-7159	MERCURY MARINE	25-31534	739
18-7108	OMC	338518	296	18-7160	MERCURY MARINE	25-31986	739
18-7108	OMC	313893	296	18-7161	MERCURY MARINE	25-32546	739
18-7109	OMC	317178	296	18-7162	MERCURY MARINE	25-33145	808
18-7110	OMC	335523	255	18-7162	VOLVO	3852044	864
18-7111	OMC	301824	296	18-7162	OMC	302337	296
18-7112	OMC	302493	296	18-7163	MERCURY MARINE	25-33465	383, 391, 630, 736, 739
18-7113-9	MERCURY MARINE	25-897536	335	18-7164	OMC	302537	296
18-7114	OMC	302540	296	18-7164	MERCURY MARINE	25-33466	391
18-7114	MERCURY MARINE	25-23145	391, 739	18-7165	OMC	304174	296
18-7115	OMC	302588	296	18-7165	MERCURY MARINE	25-32509	391, 739
18-7115	MERCURY MARINE	25-26722	739	18-7165	MERCURY MARINE	25-45253	391, 739
18-7116	VOLVO	3852045	864	18-7166	MERCURY MARINE	25-45254	391, 739
18-7116	MERCURY MARINE	25-62704	199, 384	18-7167	OMC	310414	296
18-7116	OMC	303067	296	18-7167	MERCURY MARINE	25-97386	371, 391, 735, 739
18-7117	OMC	303360	296	18-7168	VOLVO	3852033	864
18-7117	MERCURY MARINE	25-35027	739	18-7168	MERCURY MARINE	25-48171	391
18-7118	OMC	305242	296	18-7168	OMC	202893	296
18-7118	SUZUKI	09280-08008	408, 409	18-7169	CHRYSLER FORCE	25-F24278	199, 200
18-7119	YAMAHA	93210-33M85-00	469	18-7169	OMC	911686	296
18-7120	OMC	332598	808	18-7169	MERCURY MARINE	25-70937	739
18-7120	CHRYSLER FORCE	25-F498618	199, 200	18-7170	OMC	307239	296
18-7120	OMC	307853	808	18-7170	MERCURY MARINE	25-33504	739
18-7120	MERCURY MARINE	25-38933	739	18-7171	MERCURY MARINE	25-30529	384, 391, 739
18-7121	OMC	308621	296	18-7172	OMC	553126	296
18-7121	MERCURY MARINE	25-35029	739	18-7172	MERCURY MARINE	25-31305	391, 739
18-71218	MERCURY MARINE	32-48132	645	18-7173	MERCURY MARINE	25-30224	391
18-7122	VOLVO	925095	644, 645, 770, 837	18-7173	OMC	310327	296
18-7123	OMC	308876	864	18-7174	OMC	326649	808
18-7124			296	18-7174	OMC	910582	296
18-7125			391	18-7174	MERCURY MARINE	25-45711	739
18-7126	OMC	313340	296	18-7175	MERCURY MARINE	25-62817	739
18-7127	CHRYSLER FORCE	25-F84305	199, 200	18-7176	CHRYSLER FORCE	25-F74305	199, 200
18-7127	MERCURY MARINE	25-F84305	739	18-7176	MERCURY MARINE	25-90011	391
18-7127	OMC	313446	296	18-7177	MERCURY MARINE	25-53421	391, 739
18-7128	OMC	313754	296	18-7178	VOLVO	125017	864
18-7129	OMC	314491	296	18-7178	OMC	320140	296
18-7130	OMC	314728	296	18-7179	VOLVO	925054	882-885
18-7133	OMC	305123	296	18-7180	VOLVO	925055	864
18-7133	OMC	322119	275, 289, 296, 297, 808, 809	18-7180	OMC	303347	296
18-71337	MERCURY MARINE	32-33189	645	18-7180	MERCURY MARINE	25-26802	383, 384, 391, 739
18-71337	MERCURY MARINE	32-87108	645	18-7181	VOLVO	925091	864
18-71337	OMC	312781	771	18-7182	VOLVO	925092	864
18-7134	CHRYSLER FORCE	25-F40342	199, 200	18-7183	VOLVO	925093	864
18-7134	MERCURY MARINE	25-F40342	739	18-7184	VOLVO	925256	864
18-7134	OMC	303059	296	18-7186	VOLVO	925259	864
			644, 645, 770, 771, 837	18-7187	VOLVO	925261	864
			199, 200	18-7188	VOLVO	955983	864
			739	18-7188	MERCURY MARINE	25-805726	383, 391, 739
			296	18-7190	VOLVO	925065	864
				18-7192	VOLVO	955995	864

1 This product is priced per piece. To order, priced per package, please add -9 to the part number

2 Items ending in "D" are display packaged - regular number is non-display

3 For discount shop pack of 10, please add -10 to the part number

SIERRA #	O.E.M.	O.E. #	PAGE #	SIERRA #	O.E.M.	O.E. #	PAGE #
SIERRA							
18-7193	VOLVO	955974	864	18-7247	OMC	435442	222
18-7194	VOLVO	956000	864	18-7247	OMC	438996	222
18-7195	MERCURY MARINE	25-8M0027717	882-885	18-7247	OMC	436853	222, 223
18-7198	HONDA	91353-ZW1-003	207	18-7248	OMC	437327	222
18-7198	MERCURY MARINE	25-45710	198, 353, 354, 371, 383, 391, 696, 735, 739	18-7248	OMC	439078	222
				18-7248	OMC	439079	222
				18-7249	MERCURY MARINE	19273	323
18-7198	OMC	308626	296	18-7254	CHRYSLER FORCE	3745414	139, 141, 498
18-7200	CRUSADER	45303	519	18-7254	CHRYSLER INBOARD	3745414	139, 141, 498
18-7200	MERCURY MARINE	1397-2060	616	18-7255	CHRYSLER FORCE	3745415	139, 141, 498
18-7200	OMC	381389	763	18-7255	CHRYSLER INBOARD	3745415	139, 141, 498
18-7200	VOLVO	841634-9	828	18-7256			139, 141, 519, 621, 622, 763
18-7200			616				
18-72000	MERCURY MARINE	1395-9594	323	18-7256	CRUSADER	32722	139, 621
18-7201	MERCURY MARINE	1397-3327	617	18-7256	MERCURY MARINE	32722	139, 621
18-7201	MERCURY MARINE	1397-8546	617	18-7258	GM	6414989	139
18-7201	MERCURY MARINE	1397-8959	617	18-7258	OMC	380986	139, 141
18-7201	OMC	383087	763	18-7260			139, 141, 486, 519
18-7201	OMC	983871	763	18-7264	CHRYSLER FORCE	1736073	139, 141, 498
18-7201			762	18-7264	CHRYSLER FORCE	2279913	139, 141, 498
18-7202	MERCURY MARINE	1397-5837	617	18-7264	CHRYSLER INBOARD	1736073	139, 141, 498
18-7202	MERCURY MARINE	3302-9031	617	18-7264	CHRYSLER INBOARD	2279913	139, 141, 498
18-7202			519, 617	18-7265	CHRIS-CRAFT	16.83-08758	139, 141, 486, 763
18-7208	MERCURY MARINE	1395-8673	323	18-7265			139, 141, 486, 763
18-7208	MERCURY MARINE	1395-8983	323	18-7265	CHRIS-CRAFT	FI8308762	139, 486
18-7209	MERCURY MARINE	1395-9293	323	18-7266			139, 141, 621
18-7210	OMC	382363	222	18-7267	MERCURY MARINE	62092T	139
18-7211-1	MERCURY MARINE	1395-8112231	322	18-7267			139, 141, 519, 549, 621-623, 763
18-7212	MERCURY MARINE	1395-97611	322				
18-7213	MERCURY MARINE	8107492	322	18-7267	MERCURY MARINE	62092	139, 621
18-7214	MERCURY MARINE	8107493	322	18-7267	OMC	982063	139, 141
18-7215	MERCURY MARINE	1395-9024	322	18-7268			139, 141, 519, 763, 764, 829
18-7216	MERCURY MARINE	809449A1	322				
18-7217			Obsolete	18-7268	OMC	981650	139, 141
18-7219	OMC	431897	222	18-7268	VOLVO	3855276	139, 141
18-7219	OMC	439073	222	18-7270	CRUSADER	21140	139, 621
18-7220	OMC	435676	222	18-7271	CRUSADER	21141	141
18-7220	OMC	435677	222	18-7272			139, 141, 486, 520
18-7220	OMC	435678	222	18-7272	CRUSADER	97039	139, 621
18-7220	OMC	435752	222	18-7274	OMC	509409	139
18-7221	OMC	435677	222	18-7274	MERCURY MARINE	86246T	139
18-7222	OMC	392061	222	18-7274	MERCURY MARINE	86246	139, 621
18-7222	OMC	396701	222	18-7275	OMC	509410	139
18-7222	OMC	398729	222	18-7275	MERCURY MARINE	86247T	139
18-7223	OMC	391305	222	18-7275	MERCURY MARINE	86247	139, 621
18-7223	OMC	391937	222	18-7278	OMC	509395	139
18-7223	OMC	398452	222				139, 141, 486, 621, 622, 624, 627, 764
18-7223	OMC	398453	222				
18-7223	OMC	439072	222	18-7278	MERCURY MARINE	86234A05	139, 621
18-7226	MERCURY MARINE	1395-9650	322	18-7278	MERCURY MARINE	86234A4	139, 621
18-7227	PLEASURECRAFT	RN0067	547	18-7278	OMC	982240	139, 141
18-7227	MERCURY MARINE	1396-4148	617	18-7278	OMC	985602	139, 141
18-7228	MERCURY MARINE	805016A1	620	18-7278	OMC	985603	139, 141
18-7228	MERCURY MARINE	85784A1	620	18-7281	VOLVO	826493	139, 141
18-7229	MERCURY MARINE	85785-2	620	18-7282	OMC	509407	139
18-7229	MERCURY MARINE	85785T	620	18-7282	MERCURY MARINE	42725A3	139, 621
18-7229	OMC	981566	763	18-7283	OMC	509404	139
18-7229	OMC	986865	763	18-7283	MERCURY MARINE	97401A8	139
18-7229	VOLVO	3854026	829	18-7283	MERCURY MARINE	861678A1	139, 621
18-7230	CHRYSLER INBOARD	4142886	498	18-7283	MERCURY MARINE	97401A2	139, 621
18-7230	MERCURY MARINE	41639	620	18-7284	OMC	509408	140
18-7230	MERCURY MARINE	41639A-1	620	18-7284	MERCURY MARINE	41141A2	140, 621
18-7231	CRUSADER	97214	519	18-7284	MERCURY MARINE	862077A1	140, 621
18-7231	CRUSADER	97595	519	18-7286	VOLVO	841161	140, 829
18-7231	MERCURY MARINE	85785A2	620	18-7288-1	MERCURY MARINE	812454A1	140, 621
18-7232	CRUSADER	33628	519, 565, 620	18-7288-1	MERCURY MARINE	862048A1	140, 621
18-7232	MERCURY MARINE	57882	519, 565, 620	OMC	982997	140, 141, 764	
18-7232	MERCURY MARINE	57882T	565, 620	18-7290	NISSAN/TOHATSU	345-87122-0	396
18-7233	MERCURY MARINE	1395-7824	323	18-7290	YAMAHA	696-W0093-02-00	415
18-7234	MERCURY MARINE	805016A1	620	18-7290	MERCURY MARINE	84419M	322
18-7235	OMC	986783	761	18-7291	NISSAN/TOHATSU	346-87122-0	396
18-7236	OMC	986782	761	18-7291	YAMAHA	6H1-W0093-01-00	416
18-7237	OMC	986784	762	18-7291	MERCURY MARINE	84475M	322
18-7237	OMC	986799	762	18-7293	YAMAHA	6A1-W0093-01-00	416
18-7237			146, 761, 762, 828	18-7293	MERCURY MARINE	92520M	322
18-7238	OMC	986796	762	18-7295	MERCURY MARINE	1395-9022	323
18-7238	VOLVO	3854020	828	18-7296	OMC	315232	222
18-7239	OMC	986800	762	18-7300			859
18-7241	OMC	986804	762	18-7306	VOLVO	853548	859
18-7241	VOLVO	3855017	828	18-7307			99, 719, 792
18-7242	OMC	987313	762	18-7308			99, 719, 792
18-7242	VOLVO	3854105	828	18-7309			99, 719, 792
18-7243	OMC	987315	762	18-7310			99, 716, 719, 792
18-7244	OMC	987317	762	18-7311			99, 719, 792
18-7244	VOLVO	3854106	828	18-7312			99, 716, 719, 792
18-7245	OMC	987319	762	18-7313			99, 719, 792
18-7245	VOLVO	3854107	828	18-7314	MERCURY MARINE	54-32533	719
18-7246	OMC	987438	762	18-7314	VOLVO	3852604	859
18-7246	OMC	987440	762	18-7314			99, 719, 792, 859
18-7246	OMC	987485	762	18-7315	VOLVO	853012	859
18-7246	VOLVO	3854116	828				

1 This product is priced per piece. To order, priced per package, please add -9 to the part number
 2 Items ending in "D" are display packaged - regular number is non-display
 3 For discount shop pack of 10, please add -10 to the part number

SIERRA #	O.E.M.	O.E. #	PAGE #	SIERRA #	O.E.M.	O.E. #	PAGE #
SIERRA							
18-7315			99, 716, 719, 792, 793, 859	18-7408	OMC	911718	296
18-7316	MERCURY MARINE	54-31765	719	18-7409	OMC	911871	296
18-7316	MERCURY MARINE	54-815504372	719	18-7410	MERCURY MARINE	25-36390	882-885
18-7316			99, 717, 719, 792	18-7411	OMC	321921	296
18-7317			99, 719, 792	18-7411	MERCURY MARINE	25-35480	739
18-7321	MERCURY MARINE	54-38863	716, 718	18-7413	MERCURY MARINE	25-62702	391
18-7326	MERCURY MARINE	805656A2	140, 621	18-7413	OMC	303191	296
18-7326	OMC	3850809	140, 621, 764, 829	18-7414	MERCURY MARINE	25-823683	391
18-7326	OMC	3854620	140, 621, 764, 829	18-7414	MERCURY MARINE	25-64067	353, 354, 357, 391, 739
18-7326	OMC	3857986	140, 621, 764, 829	18-7415	MERCURY MARINE	25-64966	357, 391, 739
18-7326	OMC	3858261	140, 621, 764, 829	18-7416	OMC	329380	251, 296, 808
18-7326	VOLVO	3850809	140, 621, 764, 829	18-7417	OMC	329381	251, 296, 808
18-7326	VOLVO	3854620	140, 621, 764, 829	18-7418	OMC	326741	251-253, 296, 808
18-7326	VOLVO	3857986	140, 621, 764, 829	18-7419	MERCURY MARINE	25-69202	391
18-7326	VOLVO	3858261	140, 621, 764, 829	18-7420	MERCURY MARINE	25-25439	391
18-7330	OMC	988037	140, 764, 829	18-7421	MERCURY MARINE	25-20415	391
18-7330	OMC	3854280	140, 764, 829	18-7426	MERCURY MARINE	25-30271	391
18-7330	VOLVO	988037	140, 764, 829	18-7428	OMC	307103	262
18-7330	VOLVO	3854280	140, 764, 829	18-7432	YAMAHA	93210-32738-00	469
18-7330	OMC	3855958	140, 764, 829	18-7435	YAMAHA	93210-42159-00	882-885
18-7330	OMC	3857650	140, 764, 829	18-7436	YAMAHA	93210-46044-00	469
18-7330	VOLVO	3855958	140, 764, 829	18-7440-1	OMC	301967	808
18-7330	VOLVO	3857650	140, 764, 829	18-7440-1	MERCURY MARINE	25-36318	391
18-7331	OMC	3857985	140, 764, 829	18-7442	YAMAHA	93210-74M35-00	441, 469
18-7331	OMC	3858714	140, 764, 829	18-7444	YAMAHA	93211-04384-00	441, 469
18-7331	OMC	3850810	140, 764, 829	18-7445	MERCURY MARINE	25-55801	739
18-7331	VOLVO	3850810	140, 764, 829	18-7449	MERCURY MARINE	25-97387	739
18-7331	VOLVO	3857985	140, 764, 829	18-7457	CHRYSLER FORCE	25-F45530	200
18-7331	VOLVO	3858714	140, 764, 829	18-7457	OMC	319662	296
18-7332			140	18-7459	MERCURY MARINE	25-20826	391, 739
18-7333			140	18-7461	OMC	308458	296
18-7334	YAMAHA	663-24410-00-00	419	18-7463	YAMAHA	93210-19123-00	469
18-7334	YAMAHA	692-24410-00-00	419	18-7464	MERCURY MARINE	25-39695	391, 739
18-7334	YAMAHA	6A0-24410-00-00	419	18-7467	MERCURY MARINE	25-54030	391, 739
18-7334	YAMAHA	6A0-24410-01-00	419	18-7468	YAMAHA	6G5-43864-00-00	469
18-7334	YAMAHA	6A0-24410-02-00	419	18-7469	YAMAHA	64E-43869-00-00	469
18-7334	YAMAHA	6A0-24410-03-00	419	18-7470	YAMAHA	65W-43865-00-00	469
18-7334	YAMAHA	6A0-24410-04-00	419	18-7472	MERCURY MARINE	25-88198	882-885
18-7334	YAMAHA	6A0-24410-05-00	419	18-7474	MERCURY MARINE	25-94288	391, 739
18-7340	Yamaha	68V-13907-03	419	18-7475	OMC	332584	296
18-7341	Yamaha	66K-13907-00	419	18-7477	OMC	909048	296
18-7342	Yamaha	68F-13907-01	419	18-7480	PLEASURECRAFT	RO47111	549
18-7343	Yamaha	60V-13907-00	419	18-7481	OMC	324981	234, 235, 262, 269, 271, 291
18-7349	YAMAHA	6E5-24410-00-00	419	18-7483	YAMAHA	93210-37M67-00	469
18-7349	YAMAHA	6E5-24410-01-00	419	18-7484	YAMAHA	65W-43871-00-00	415
18-7349	YAMAHA	6E5-24410-02-00	419	18-7485	YAMAHA	93210-86M38-00	469
18-7349	YAMAHA	6E5-24410-03-00	419	18-7486	YAMAHA		
18-7349	YAMAHA	6E5-24410-04-00	419	18-7487	YAMAHA		
18-7349	YAMAHA	6E5-24410-10-00	419	18-7488	YAMAHA	6P3-24564-00-00	423
18-7350	OMC	391638	224	18-7489			566
18-7350	OMC	395091	224	18-7490	OMC	305146	882-885
18-7350	OMC	397274	224	18-7492	VOLVO	3854161	816
18-7350	OMC	397839	224	18-7493	MERCURY MARINE	392889925	588
18-7351	OMC	438562	224	18-7493	VOLVO	3859078	817
18-7352	OMC	382354	224	18-7494	HONDA	30520-PNA-007	201
18-7352	OMC	385781	224	18-7508	MERCURY MARINE	16792A39	676
18-7352	OMC	388268	224	18-7510	OMC	321163	216, 296, 808
18-7352	OMC	394543	224	18-7510	OMC	910305	771
18-7352	OMC	395713	224	18-7510	OMC	912424	771
18-7352	OMC	398338	224	18-7510	OMC	913488	771
18-7352	OMC	398387	224	18-7510	OMC		644
18-7352	OMC	432451	224	18-7512	CHRYSLER INBOARD	7087-OR	508
18-7352	OMC	433387	224	18-75125	OMC	912793	771
18-7352	OMC	438556	224	18-75125	VOLVO	826423	837
18-7353	OMC	433386	224	18-75125	VOLVO	845792	837
18-7353	OMC	438555	224	18-75125	MERCURY MARINE	32-12817	644
18-7354	MERCURY MARINE	1395-8506	321	18-75125	MERCURY MARINE	32-12818	644
18-7355	MERCURY MARINE	1395-811691 2	321, 326	18-75125	MERCURY MARINE	32-53461-70	644
18-7356	MERCURY MARINE	1395-811691 3	321, 326	18-75125	MERCURY MARINE	32-88795	644
18-7373N	Mer cruiser	3310-864941A01	142, 611, 613	18-75125	MERCURY MARINE	32-92837	644
18-7380	Mercury	809569	617	18-7513	VOLVO	3862500	833
18-7381	Mercury	16253	617	18-7599			882-885
18-7382	Mercury	804184	617	18-7600	CRUSADER	47002	518
18-7388	Yamaha	6G1-24411-00	419	18-7600	MERCURY MARINE	805218T	608
18-7389	Yamaha	6E0-24411-00	419	18-7601	OMC	3854158	758
18-7390	Yamaha	63V-24411-00	419	18-7601	VOLVO	3854158	833
18-7391	Yamaha	692-24411-00	419	18-7602	OMC	3854159	Obsolete
18-7392	Yamaha	67E-14985-01	418	18-7602	VOLVO	3854159	833
18-7393	Yamaha	6E7-14385-00	418	18-7602	VOLVO	3854159	833
18-7394	RACOR	RK10012	127	18-7603-1	MERCURY MARINE	1376-5659A1	142, 144, 611, 613, 614
18-7400	MERCURY MARINE	25-818573	358	18-7603-1	ROCHESTER	7044185	142, 144, 611, 613, 614
18-7400	OMC	908194	296	18-7603-1	MERCURY MARINE	1347-818622 1	142, 144, 611, 613, 614
18-7401	OMC	908383	296	18-7603-1	MERCURY MARINE	1347-818622	142, 611, 614
18-7403	OMC	909316	296	18-7603-1	MERCURY MARINE	1347-804623R02	142, 144, 611
18-7404	OMC	909747	296	18-7604-1	MERCURY MARINE	3304-9354A2	142, 144, 611
18-7406	VOLVO	3852523	864	18-7605-1	ROCHESTER	17057285	143
18-7406	OMC	911311	296				
18-7407	OMC	911700	296				
18-7407	VOLVO	3852531	296				
18-7407	OMC	3852531	296				

1 This product is priced per piece. To order, priced per package, please add -9 to the part number
 2 Items ending in "D" are display packaged - regular number is non-display
 3 For discount shop pack of 10, please add -10 to the part number

SIERRA #	O.E.M.	O.E. #	PAGE #	SIERRA #	O.E.M.	O.E. #	PAGE #
SIERRA							
18-7605-1	MERCURY MARINE	1347-804623R02	143-145, 611, 613, 759, 760	18-7615-1	MERCURY MARINE	1347-816373A4	142-145, 611, 612, 614, 759
18-7605-1	ROCHESTER	17057283	143-145, 611, 613, 759, 760	18-7615-1	MERCURY MARINE	1347-804624 R02	143, 145
18-7605-1	ROCHESTER	17059291	143-145, 611, 613, 759, 760	18-7615-1	OMC	981359	145
18-7605-1	ROCHESTER	17059292	143-145, 611, 613, 759, 760	18-7615-1	OMC	981428	145
18-7605-1	ROCHESTER	17080565	143-145, 611, 613, 759, 760	18-7615-1	OMC	981564	145
18-7605-1	ROCHESTER	17080564	143-145, 611, 613, 759, 760	18-7615-1	OMC	981705	145
18-7605-1	MERCURY MARINE	1347-804623A1	143, 611	18-7615-1	OMC	981803	145
18-7605-1	MERCURY MARINE	1347-9661A3	143, 144, 147, 611, 613, 618, 619	18-7615-1	OMC	982223	145
18-7605-1	OMC	382821	145	18-7615-1	OMC	983855	145
18-7605-1	OMC	383766	145	18-7615-1	OMC	985822	145
18-7605-1	OMC	384194	145	18-7615N	MerCruiser		142, 145, 611, 759
18-7606	YAMAHA	MAR-10171-30-00	425	18-7616-1	MERCURY MARINE	1347-8288A1	143, 144, 147, 612, 614, 619
18-7607-1	ROCHESTER	17082403	143, 518	18-7616-1	ROCHESTER	17057287	143, 144, 612, 614, 615
18-7608-1	ROCHESTER	7040089	143	18-7616-1	ROCHESTER	17059287	143, 144, 612, 614, 615
18-7608-1	ROCHESTER	17059052	143-145, 611-613, 759, 760	18-7616-1	ROCHESTER	17059290	143, 144, 612, 614, 615
18-7608-1	ROCHESTER	7040080	143-145, 611-613, 759, 760	18-7616-1	ROCHESTER	17080560	143, 144, 612, 614, 615
18-7608-1	ROCHESTER	7043184	143-145, 611-613, 759, 760	18-7616-1	MERCURY MARINE	1347-804626 R02	143, 144, 612, 614, 615
18-7608-1	ROCHESTER	7040083	143-145, 611-613, 759, 760	18-7616-1	ROCHESTER	1708563	143, 145
18-7608-1	ROCHESTER	7042183	143-145, 611-613, 759, 760	18-7617-1	ROCHESTER	17059280	143, 144, 612, 614
18-7608-1	ROCHESTER	7043183	143-145, 611-613, 759, 760	18-7617-1	MERCURY MARINE	1347-804625 R02	143, 144, 612, 614
18-7608-1	MERCURY MARINE	1347-818620	143, 144, 611, 613	18-7617-1	MERCURY MARINE	1347-804625 R1	143, 144, 612, 614
18-7608-1	ROCHESTER	17059057	143-145, 611-613, 759, 760	18-7617-1	MERCURY MARINE	1347-9863A3	143, 144, 612, 614
18-7608-1	MERCURY MARINE	1347-818620R02	143, 611-613	18-7618-1	ROCHESTER	17080561	143, 144, 612-614
18-7608-1	MERCURY MARINE	1347-818620 1	143-145, 611-613, 759, 760	18-7618-1	ROCHESTER	17080562	143, 144, 612-614
18-7608-1	OMC	381868	145	18-7618-1	ROCHESTER	17059289	143, 144, 612-614
18-7608-1	OMC	980528	145	18-7618-1	ROCHESTER	7044291	143, 144, 612-614
18-7608-1	OMC	982217	145	18-7618-1	MERCURY MARINE	1347-804624 R02	143, 144, 612-614
18-7608-1	OMC	982219	145	18-7618-1	MERCURY MARINE	1347-804624 R1	143, 144, 612-614
18-7609-1	ROCHESTER	17059054	143-145, 611, 612, 759, 760	18-7618-1	MERCURY MARINE	1347-8289A1	143, 144, 612-614
18-7609-1	ROCHESTER	7036543	143-145, 611, 612, 759, 760	18-7619-1	ROCHESTER	17059298	143-145, 612, 613
18-7609-1	ROCHESTER	7040082	143-145, 611, 612, 759, 760	18-7619-1	ROCHESTER	17081299	143-145, 612, 613
18-7609-1	ROCHESTER	7041369	143-145, 611, 612, 759, 760	18-7619-1	ROCHESTER	17083522	143-145, 612, 613
18-7609-1	ROCHESTER	7043182	143-145, 611, 612, 759, 760	18-7619-1	MERCURY MARINE	1347-9142A2	143-145, 612, 613
18-7609-1	ROCHESTER	7044182	143-145, 611, 612, 759, 760	18-7619-1	ROCHESTER	17059283	143-145, 612, 613
18-7609-1	MERCURY MARINE	1347-818619	143, 144, 611	18-7619-1	MERCURY MARINE	1347-8460A3	143-145, 612, 613
18-7609-1	MERCURY MARINE	1347-818619 1	143-145, 611, 612, 759, 760	18-7627			147, 612, 618
18-7609-1	MERCURY MARINE	1347-818619 1R02	143-145, 611, 612, 759, 760	18-7630	CRUSADER	47032	142, 566, 611, 758, 827
18-7609-1	OMC	381494	145	18-7630	MERCURY MARINE	805226A1	608
18-7609-1	OMC	382733	145	18-7632	CRUSADER	47033	518
18-7609-1	OMC	772831	145	18-7632	MERCURY MARINE	805224A1	608
18-7609-1	OMC	980530	145	18-7633	MERCURY MARINE	805320A03	732
18-7609-1	OMC	982217	145	18-7634	OMC	9484748	802
18-7609-1	OMC	984180	145	18-7635			142, 759
18-7610-1	ROCHESTER	17081060	143, 144, 611, 612	18-7636			142, 759
18-7610-1	MERCURY MARINE	1347-818621 1	143, 144, 611, 612	18-7637			142, 565, 759
18-7610-1	MERCURY MARINE	1347-818621 1R02	143, 144, 611, 612	18-7638			142, 565, 759
18-7610-1	MERCURY MARINE	1347-818621	143, 611	18-7639	MERCURY MARINE	3310-864943A01	143, 611, 614
18-7611-2	MERCURY MARINE	3310-807312A1	143, 144, 611, 614	18-7640			142, 611, 759
18-7611-2	MERCURY MARINE	3310-807312 R02	143, 144, 611, 614	18-7641	VOLVO	3856393	827
18-7613-1	MERCURY MARINE	3310-806969A1	143, 144, 612, 614, 615	18-7641	VOLVO	841047-4	827
18-7613-1	MERCURY MARINE	3310-806969 R01	143, 144, 612, 614, 615	18-7641	VOLVO	841313-0	827
18-7615-1	ROCHESTER	17080561	143, 145	18-7642	VOLVO	3863130	817
18-7615-1	ROCHESTER	17057298	143, 145	18-7643	VOLVO	3859082	817
18-7615-1	ROCHESTER	17059288	143, 145	18-7646	PLEASURECRAFT	R020035A	548
18-7615-1	ROCHESTER	17059280	143, 145	18-7646	MERCURY MARINE	892615002	608
18-7615-1	ROCHESTER	17085013	143, 145	18-7647	VOLVO	872066	833
18-7615-1	MERCURY MARINE	1347-804624R1	143, 145	18-7648	PLEASURECRAFT	R117012	546
				18-7648	MERCURY MARINE	392881732	588
				18-7648	VOLVO	3861267	817
				18-7650	OMC	987995	758
				18-7651	MERCURY MARINE	12026	608
				18-7652	MERCURY MARINE	805227A1	608
				18-7655	YAMAHA	67H8592A0100	425
				18-7656	YAMAHA	68F8592A0000	425
				18-7657	HONDA	35655-ZY3-013	202
				18-7658	HONDA	35655-ZY9-013	202
				18-7659	HONDA	35655-ZY6-013	202
				18-7660	MERCURY MARINE	881731	608
				18-7662	MERCURY MARINE	885174	608
				18-7663	MERCURY MARINE	802630T01	608
				18-7664	MERCURY MARINE	809066	617
				18-7665	MERCURY MARINE	70125A 1	617
				18-7666	MERCURY MARINE	1397-8582	617
				18-7667	MERCURY MARINE	71464A01	617
				18-7668	MERCURY MARINE	854445	608

1 This product is priced per piece. To order, priced per package, please add -9 to the part number
 2 Items ending in "D" are display packaged - regular number is non-display
 3 For discount shop pack of 10, please add -10 to the part number

SIERRA #	O.E.M.	O.E. #	PAGE #	SIERRA #	O.E.M.	O.E. #	PAGE #
SIERRA							
18-7677	PLEASURECRAFT	R020027	548	18-7755	SUZUKI	13910-95D00	400
18-7677	MERCURY MARINE	806612T	608	18-7756	YAMAHA	64D-W0093-00-00	416
18-7677	OMC	3850357	758	18-7757	MERCURY MARINE	803148	588
18-7677	VOLVO	3850357	833	18-7757	VOLVO	3855296	817
18-7679	OMC	3854905	758	18-7758	MERCURY MARINE	35-877761K01	153, 353
18-7679	VOLVO	3854905	833	18-7758	MERCURY MARINE	35-877761Q01	153, 353
18-7682	MERCURY MARINE	849934	608	18-7759	YAMAHA	6K7-W0093-09-00	416
18-7683	MERCURY MARINE	849899	608	18-7761			221, 399
18-7684	MERCURY MARINE	864856A1	608	18-7765	NISSAN/TOHATSU	369-87122-1	396
18-7684	OMC	3850396	758	18-7765	YAMAHA	6G1-W0093-00-00	416
18-7684	VOLVO	3850396	833	18-7765	MERCURY MARINE	11502M	323
18-7685	VOLVO	3858941	833	18-7766	YAMAHA	6H3-W0093-02-00	416
18-7685	MERCURY MARINE	852956A1	608, 609	18-7767	YAMAHA	6H4-W0093-01-00	416
18-7686	MERCURY MARINE	849896	608, 610	18-7768	YAMAHA	6H4-W0093-03-00	417
18-7688	MERCURY MARINE	885176	609	18-7769	YAMAHA	6E7-W0093-04-00	417
18-7689	OMC	3855182	758	18-7769	MERCURY MARINE	814481M	323
18-7689	VOLVO	3855182	833	18-7770	YAMAHA	689-W0093-02-00	417
18-7690			609	18-7770	MERCURY MARINE	84456M	323
18-7691			609	18-7772	YAMAHA	61A-W0093-01-00	417
18-7692			609	18-7773	OMC	5032424	222
18-7693			609	18-7773	SUZUKI	13910-89J01	399
18-7694			609	18-7774			84, 128
18-7695			609	18-7775			84, 126
18-7696			609	18-7775-1			126, 225, 332, 421, 625, 765, 830
18-7697	PLEASURECRAFT	R084003	548				84, 126
18-7697	MERCURY MARINE	803149	608	18-7776			126, 225, 332, 421, 625, 765, 830
18-7698	MERCURY MARINE	881693002	609	18-7776-1			84, 126
18-7700	MERCURY MARINE	853678T	608				126, 225, 332, 421, 625, 765, 830
18-7700	VOLVO	3857487	833	18-7777			84, 126, 225, 332, 421, 624
18-7701	MERCURY MARINE	862998	608				126, 421
18-7702	MERCURY MARINE	805223T	640	18-7777	YAMAHA	MAR-FLTHD-SS-12	126, 225, 332, 421, 625, 765, 830
18-7702	VOLVO	3854527	833	18-7777-1			126, 225, 332, 421, 625, 765, 830
18-7703	MERCURY MARINE	805544T	608				126, 421
18-7703	OMC	3854512	758	18-7777-1	YAMAHA	ABB-SPRTR-HD-SS	128, 831, 832
18-7703	VOLVO	3854512	833	18-7778	VOLVO	3850861	423
18-7704	VOLVO	3855194	833	18-7780	YAMAHA	6F5-24563-00-00	423
18-7705	VOLVO	3843751	833	18-7781	YAMAHA	61N-24563-00-00	423
18-7706	VOLVO	3858979	817	18-7782	YAMAHA	61A-24563-00-00	423
18-7708	VOLVO	3808516	817	18-7783	VOLVO	273663	829
18-7709	VOLVO	3840335	832	18-7784	MERCURY MARINE	35-11004A1	627
18-7710	YAMAHA	68T-24251-00-00	423	18-7784	MERCURY MARINE	35-803897Q1	627
18-7711	SUZUKI	15410-96J00	400	18-7785	HONDA	16010-ST5-993	202
18-7712	MERCURY MARINE	35-16248	334	18-7786	HONDA	16900-SA5-004	202
18-7712	NISSAN/TOHATSU	369022300M	395	18-7787			419
18-7713	MERCURY MARINE	35-80365M	334	18-7788			419
18-7713	YAMAHA	646-24251-02-00	423	18-7789	OMC	502906	128, 227, 766, 831
18-7714	MERCURY MARINE	35-877565T1	334	18-7789	VOLVO	3852413	128, 227, 766, 831
18-7716	OMC	5032323	227	18-7789	VOLVO	3851218-2	128, 831
18-7716	SUZUKI	15410-87J10	400	18-7790			130, 565
18-7717	MERCURY MARINE	35-93568	627	18-7791			130
18-7717			520, 627, 767, 833	18-7792	OMC	910641	766
18-7718	MERCURY MARINE	35-879885T	334	18-7792	OMC	3855104	766
18-7719	OMC	5032238	227	18-7792	VOLVO	3855104	833
18-7719	SUZUKI	15410-98500	400	18-7796	OMC	335334	224
18-7720	HONDA	16900-SR3-004	202	18-7797			420
18-7721	MERCURY MARINE	35-864572	627	18-7798			420
18-7722	OMC	5005266	227	18-7799			420
18-7723			130	18-7800	OMC	433519	224
18-7724			130	18-7800	OMC	438616	224
18-7725			146, 497, 518, 519	18-7801	OMC	379777	224
18-7726			146, 497	18-7802	MERCURY MARINE	35-87946A3	334
18-7727			146, 147, 761, 763	18-7802	MERCURY MARINE	35-87946Q3	335
18-7728			146, 616, 619	18-7802	MERCURY MARINE	35-87946Q4	334, 335
18-7729			146, 147, 761, 763	18-7804	MERCURY MARINE	23014A1	327, 356
18-7730			147, 761, 763	18-7805	CHRYSLER FORCE	F2A24747-1	189
18-7732	ZENITH	K-2035	148, 485, 486	18-7806-1			189-191, 327, 328
18-7732	ZENITH	K-2036	148, 485, 486	18-7807	MERCURY MARINE	55278A1	327, 356, 357
18-7732			148, 485, 486	18-7808	MERCURY MARINE	55278A5	327, 356
18-7735	SUZUKI	15410-94400	400	18-7809	MERCURY MARINE	55278A4	327, 357
18-7736	YAMAHA	67D-W0093-00-00	416	18-7810	MERCURY MARINE	90363A1	327
18-7737	YAMAHA	61N-W0093-00-00	416	18-7811	MERCURY MARINE	89031A1	327
18-7738	MERCURY MARINE	802706A1	322	18-7812	MERCURY MARINE	89031A2	327, 355
18-7738	YAMAHA	66M-W0093-01-00	416	18-7813	MERCURY MARINE	66599A3	327
18-7739	YAMAHA	6L2-W0093-00-00	416	18-7813	MERCURY MARINE	89031A3	327, 357
18-7740	YAMAHA	6E9-W0093-02-00	416	18-7814	MERCURY MARINE	89031A4	327
18-7741	YAMAHA	6E9-W0093-03-00	416	18-7815	MERCURY MARINE	1399-5137	327
18-7742	YAMAHA	6H0-W0093-00-00	416	18-7817	CHRYSLER FORCE	21-42990A10	358
18-7743	MERCURY MARINE	804346T1	322	18-7817	MERCURY MARINE	21-42990A7	358
18-7743	YAMAHA	67F-W0093-00-00	416	18-7817	CHRYSLER FORCE	21-42990A8	189
18-7744	YAMAHA	6N6-W0093-02-00	416	18-7817	MERCURY MARINE	21-42990A8	327
18-7746	MERCURY MARINE	823427A1	616	18-7817	CHRYSLER FORCE	21-42990A7	189
18-7747	YAMAHA	6G5-W0093-08-00	416	18-7817	MERCURY MARINE	21-42990A7	327
18-7748	MERCURY MARINE	809064	616	18-7817	CHRYSLER FORCE	21-857005A1	189, 327, 353, 354
18-7749	MERCURY MARINE	809065	616	18-7817	MERCURY MARINE	21-857005A1	189, 327, 353, 354
18-7749	MERCURY MARINE	823728	616	18-7817	CHRYSLER FORCE	21-42990A9	355-357
18-7749	MERCURY MARINE	835076	616	18-7817	MERCURY MARINE	21-42990A9	355-357
18-7750-1	MERCURY MARINE	1395-8236354	323	18-7818-1	MERCURY MARINE	42909A3	327
18-7751	MERCURY MARINE	13220	565, 614, 615	18-7818-1	MERCURY MARINE	42909A4	327
18-7752	SUZUKI	13910-87D00	400	18-7820	OMC	393103	224
18-7753	SUZUKI	13910-94400	400	18-7821	OMC	395867	224
18-7754	SUZUKI	13910-94701	400	18-7821	OMC	398514	224

1 This product is priced per piece. To order, priced per package, please add -9 to the part number
 2 Items ending in "D" are display packaged - regular number is non-display
 3 For discount shop pack of 10, please add -10 to the part number

SIERRA #	O.E.M.	O.E. #	PAGE #	SIERRA #	O.E.M.	O.E. #	PAGE #
SIERRA							
18-7822	OMC	432962	224	18-7857-1	A.C. DELCO	GF-61P	130
18-7823	OMC	393088	224	18-7858	VOLVO	858201	129
18-7824	MERCURY MARINE	35-866340Q02	s/s to 18-7824-1	18-7859	MERCURY MARINE	3302-9033	627
18-7824	CHRIS-CRAFT	16.81-08746	553	18-7859	MERCURY MARINE	35-53336	627
18-7824	MERCURY MARINE	54111	675	18-7859	MERCURY MARINE	35-53336Q	627
18-7824	MERCURY MARINE	35-866340Q03	675	18-7859	OMC	908034	767
18-7824	MERCURY MARINE	35-866340K01	675	18-7859	VOLVO	835576	832
18-7824	YAMAHA	YSC-13231-20-0C	866	18-7860	MERCURY MARINE	35-49088A2	627
18-7824	CRUSADER	201104	153	18-7860	MERCURY MARINE	35-49088Q2	627
18-7824	OMC	173232	153	18-7860	OMC	312456	767
18-7824	PLEASURECRAFT	R077002	153, 553, 565	18-7860	CHRIS-CRAFT	381690	767
18-7824	INDMAR	50-1001	153, 565	18-7860	CHRIS-CRAFT	16.83-90006	487, 622, 627, 767
18-7824	MERCURY MARINE	32716	153, 675	18-7861	OMC	981911	767
18-7824	MERCURY MARINE	35-802885Q	153, 675	18-7862	CRUSADER	91606	520
18-7824	OMC	502902	153	18-7862	OMC	982230	767
18-7824	VOLVO	835440	153	18-7862	VOLVO	841162	832
18-7824	YAMAHA	YSC-10231-20-0C	153, 565, 866	18-7865	YAMAHA	MAR-MINIF-IL-TR	84, 128
18-7824	MERCURY MARINE	14957	153	18-7865			84, 128
18-7824-1	MERCURY MARINE	35-866340Q02	153	18-7866			84, 126
18-7824C			565	18-7866	YAMAHA	MAR-FUELF-IL-TR	126, 422, 566
18-7826	OMC	305185	227	18-7869	MERCURY MARINE	1397-8545	627
18-7828-1			130, 335	18-7869	MERCURY MARINE	1397-8767	627
18-7829	MERCURY MARINE	35-816296T	335	18-7871	MERCURY MARINE	35-805809T	156
18-7829	MERCURY MARINE	35-816296Q	130, 335	18-7871	MERCURY MARINE	35-805809	152, 581, 675
18-7829			130, 335	18-7873	MERCURY MARINE	35-808275	129, 627
18-7829	MERCURY MARINE	35-16494	130, 335	18-7874	CUMMINS	299670	882-885
18-7829	MERCURY MARINE	35-816296	130, 335	18-7875	YAMAHA	YSC-16231-20-0C	153
18-7829	MERCURY MARINE	35-816296K03	130, 335	18-7875	CHRYSLER INBOARD	1851658	153, 155-158, 491, 498, 535, 553, 675, 780, 812, 813, 866
18-7829	MERCURY MARINE	35-816296-1	335				
18-7830	YAMAHA	65W-24251-10-00	423	18-7875	CRUSADER	9002514	153
18-7830	OMC	398327	130, 335	18-7875	CHRIS-CRAFT	16.81-06536	153
18-7830	MERCURY MARINE	35-816296Q2	130, 335	18-7875	OMC	173231	153
18-7830	MERCURY MARINE	35-816296-T1	130, 335	18-7875	MERCURY MARINE	35-802886Q	153, 156, 675
18-7830			130, 335	18-7875	PLEASURECRAFT	R077001	153, 553
18-7830	MERCURY MARINE	35-16494-1	130, 335	18-7875	YAMAHA	YSC-10231-20-0C	153, 565, 866
18-7831			130, 335	18-7875	MERCURY MARINE	60565	153
18-7831	MERCURY MARINE	802128A1	130, 335	18-7875	OMC	502900	153
18-7832	MERCURY MARINE	1399-3938	334	18-7876	MERCURY MARINE	35-16595T1	153
18-7833	YAMAHA	6G1-24471-00-00	420	18-7876	MERCURY MARINE	35-16595Q	156
18-7833	MERCURY MARINE	11497M	327	18-7876	MERCURY MARINE	32-802885Q	675
18-7834	YAMAHA	6E0-24471-00-00	420	18-7876	CRUSADER	201104	153
18-7834	MERCURY MARINE	91748M	327	18-7876	YAMAHA	YSC-14231-20-0C	153, 866
18-7837	YAMAHA	677-24411-02-00	420	18-7876			153, 675
18-7837	MERCURY MARINE	84262M	327	18-7876	OMC	173233	153
18-7838	YAMAHA	677-24471-01-00	420	18-7876	OMC	502901	153, 780
18-7838	MERCURY MARINE	84265M	327	18-7876	YAMAHA	YSC-10231-20-0C	153, 565, 866
18-7839	YAMAHA	648-24411-00-00	420	18-7876	MERCURY MARINE	14957	153
18-7839	MERCURY MARINE	80606M	327	18-7876	MERCURY MARINE	52731	153
18-7840	YAMAHA	663-24411-00-00	420	18-7876	VOLVO	3850559	153
18-7840	MERCURY MARINE	84141M	327	18-7878-1	CHRYSLER INBOARD	3549957	153, 155, 498
18-7841	YAMAHA	6J8-24471-00-00	420	18-7878-1	CHRYSLER INBOARD	L-19	153, 155, 498
18-7842	YAMAHA	6E5-24471-00-00	420	18-7878-1	MERCURY MARINE	803470Q	153
18-7843	YAMAHA	6E5-24411-00-00	420	18-7878-1			153
18-7844			84, 126	18-7878-1	OMC	502904	153, 780
18-7844	MERCURY MARINE	35-802893Q	126, 334, 565, 626	18-7878-1	CHRYSLER INBOARD	L-1008	153, 498
18-7844	MERCURY MARINE	35-807172	126, 334, 626	18-7878-1	MERCURY MARINE	803470	153
18-7845			84, 126, 227, 334, 422, 626	18-7878-1	VOLVO	430143	153
18-7845	MERCURY MARINE	35-802893Q	126, 334, 565, 626	18-7878-1	VOLVO	1266286	153
18-7845	MERCURY MARINE	35-807172	126, 334, 626	18-7878-1	VOLVO	3517857	153
18-7845	YAMAHA	ABB-FUELF-IL-TR	126, 422, 565	18-7879	CHRYSLER FORCE	L-319	153, 155, 498
18-7846	CRUSADER	98041	520	18-7879	MERCURY MARINE	32-883702K	153, 675
18-7846			128, 227, 520, 766, 831	18-7879	MERCURY MARINE	32-883702Q	153, 675
18-7846	OMC	502905	128, 227, 520, 766, 831	18-7879	OMC	173834	153, 780
18-7847			327	18-7879	MERCURY MARINE	41815	153
18-7848-1			126, 225, 332, 421, 625, 765, 830	18-7879	MERCURY MARINE	35-802884Q	153, 675
18-7848-1	MERCURY MARINE	35-802893Q4	126, 225, 332, 421, 625, 765, 830	18-7879	OMC	502903	153
18-7848-1	MERCURY MARINE	35-60494A4	126, 332, 625	18-7879	VOLVO	841750	153
18-7848-1	MERCURY MARINE	35-802893A4	126, 332, 625	18-7880	CATERPILLAR	1R-0658	152, 155, 581, 848
18-7848-2			127, 225	18-7880	VOLVO	466634	152, 155, 581, 848
18-7852-1	CRUSADER	22687	520	18-7884	UNIVERSAL	299381	152
18-7852-1			126, 225, 300, 332, 421, 520, 625, 765, 830	18-7884	VOLVO	834337	152, 157, 158, 581, 814, 848
18-7852-1	YAMAHA	MAR-SEPAR-AT-OR	126, 421	18-7886	PERKINS	2654402	152, 157, 581
18-7852-2			127, 225	18-7887	PERKINS	2654347	Obsolete
18-7853-1	MERCURY MARINE	89876A3	126, 332, 624	18-7887	PERKINS	2654407	Obsolete
18-7853-1	YAMAHA	MAR-FLTHD-AL-12	126, 421	18-7888	VOLVO	826648	834
18-7853-1			84, 126	18-7888	VOLVO	862293	834
18-7854	OMC	311684	766	18-7890	VOLVO	463505	848
18-7854	OMC	984491	766	18-7890	VOLVO	876185	848
18-7854	ROCHESTER	17078904	766	18-7891			158
18-7855	MERCURY MARINE	1397-2150	627	18-7892			158
18-7855	OMC	910139	766	18-7894			882-885
18-7855	OMC	983870	766	18-7895	OMC	778888	153, 155, 157, 249
18-7855	ROCHESTER	17068453	766	18-7895	OMC	5035703	153, 155, 157, 249
18-7856-1	A.C. DELCO	GF-61	130	18-7895	SUZUKI	16510-93J00	153, 157
				18-7896	OMC	778886	153, 155,
							157, 249, 406
				18-7896	OMC	5033539	153, 155,
							157, 249, 406
				18-7896	SUZUKI	16510-61A20-MHL	153, 406

1 This product is priced per piece. To order, priced per package, please add -9 to the part number
 2 Items ending in "D" are display packaged - regular number is non-display
 3 For discount shop pack of 10, please add -10 to the part number

SIERRA #	O.E.M.	O.E. #	PAGE #	SIERRA #	O.E.M.	O.E. #	PAGE #
SIERRA							
18-7897	OMC	778887	153, 155, 157, 249, 406	18-7942	VOLVO	3825133	129, 832
18-7897	OMC	5033919	153, 155, 157, 249, 406	18-7943			128, 227, 626, 766
18-7897	SUZUKI	16510-82703	153, 157, 406	18-7944	MERCURY MARINE	35-802893Q	126, 334, 565, 626
18-7899	DETROIT DIESEL	25010495	152, 155, 581	18-7944	MERCURY MARINE	35-807172	126, 334, 626
18-79007	VOLVO	3825038		18-7945	MERCURY MARINE	35-802893Q	126, 334, 565, 626
18-7901	MERCURY MARINE	825467T1	153, 156	18-7945	MERCURY MARINE	35-807172	126, 334, 626
18-7901	YAMAHA	6G8-13440-00-00	153, 158, 440	18-7945	YAMAHA	ABB-FUELF-IL-TR	126, 422, 565
18-7901	MERCURY MARINE	825467A1	153, 353	18-7945C			565
18-7902	YAMAHA	3FV-13440-00-00	153, 158, 440	18-7946	OMC	502905	128, 227, 766, 831
18-7903	OMC	763364	154, 155, 157, 249, 406	18-7946			128, 227, 766, 831
18-7903	OMC	5033102	154, 155, 157, 249, 406	18-7947	HONDA	17670-ZW1-030GH	129, 202
18-7903	SUZUKI	16510-05240	154, 157, 406	18-7947	SUZUKI	99105-20006	129, 400
18-7905	SUZUKI	16510-96J00	154, 157, 406	18-7947	RACOR	S3240	129, 422, 626, 766, 832
18-7906-1	MERCURY MARINE	35-822626Q15	353	18-7948	HONDA	17670-ZW1-801AH	129, 202
18-7906-1	MERCURY MARINE	35-822626T7	154, 156, 353	18-7948	RACOR	S3227	129, 334, 422, 626, 766, 832
18-7906-1	YAMAHA	69J-13440-00-00	154, 158, 440	18-7948	MERCURY MARINE	35-886638	129, 334, 626
18-7907	VOLVO	858488	848	18-7948	SUZUKI	99105-20005	129, 400
18-7908	VOLVO	3582358	848	18-7949	RACOR	S3232	129, 422, 626, 766, 832
18-7909	HONDA	15400-PLM-A01PE	154, 155, 207	18-7950	CHRYSLER FORCE	25-45258	199, 200
18-7909	HONDA	15400-POH-305	154, 207	18-7951	CHRYSLER FORCE	25-88657	127, 226
18-7909	HONDA	15400-POH-305PE	154, 207	18-7952	CHRYSLER FORCE	5035974	199, 200
18-7909	HONDA	15400-ZJI-004	154, 207	18-7953	OMC	15410-87J30	427
18-7910	WESTERBEKE	30220	152, 158, 581	18-7953	SUZUKI	15410-87J30	427
18-7910	YANMAR	124450-35100	152, 158, 581	18-7954	YAMAHA	N26-13440-00-00	154, 158, 439, 440
18-7911-1	HONDA	15400-PFB-007	154, 155, 207	18-7955	YAMAHA	68F-24563-10-00	423
18-7911-1	NISSAN/TOHATSU	3R0076150M	154, 156, 396	18-7956	CHRYSLER FORCE	25-85549	291
18-7911-1	YAMAHA	5GH-13440-00-00	154, 158	18-7956	MERCURY MARINE	25-85549	291
18-7913	MERCURY MARINE	35-822626Q1	154, 156, 353	18-7958	CRUSADER	47047	520
18-7913	HONDA	15400-PFB-014	154, 155, 207	18-7958	MERCURY MARINE	25-47254	354, 356, 357, 391
18-7913	MERCURY MARINE	35-822626Q03	154-156, 207, 353	18-7961	MERCURY MARINE	25-97386	371, 391, 735, 739
18-7914	MERCURY MARINE	35-822626Q04	156	18-7961	MERCURY MARINE	331353	263
18-7914	MERCURY MARINE	35-822626Q2	154, 156, 353	18-7964	OMC	331353	263
18-7915-1	OMC	778885	154, 155, 249, 406	18-7964	MERCURY MARINE	35-815419	627
18-7915-1	OMC	5031411	154, 155, 249, 406	18-7964			487, 497, 520, 548, 627, 767, 833
18-7915-1	SUZUKI	16510-87J00	154, 157, 406	18-7965-1			128
18-7916	OMC	434839	154, 155, 249	18-7965-1	YAMAHA	MAR-MINIF-LT-AS	128, 422
18-7917	YANMAR	124450-35110	152, 158, 581	18-7966-1	YAMAHA	MAR-SEPAR-AT-OR	126, 333, 625
18-7917	YANMAR	124550-35110	152, 158, 581	18-7966-1	MERCURY MARINE	35-18458Q3	126, 334
18-7917	YANMAR	171056-35110	152, 158, 581	18-7968	MERCURY MARINE	35-18458Q4	126, 334
18-7917	YANMAR	171056-35111	152, 158, 581	18-7969			129, 334, 626
18-7918	MERCURY MARINE	35-883701K01	154, 156, 353	18-7970	CERLIST DIESEL	1512903	129
18-7918	MERCURY MARINE	35-877769K01	154, 353	18-7970	VOLVO	3827069	154, 157, 158, 848
18-7919	RACOR	S3213	127, 227, 334, 422, 626, 627, 766, 832	18-7974	CRUSADER	23250	520
18-7919	MERCURY MARINE	35-809097	127, 334, 626, 627	18-7976	PLEASURECRAFT	47047	520, 548
18-7919	YAMAHA	MAR-24563-00-00	127, 422	18-7976	MERCURY MARINE	35-866171A01	627
18-7920	RACOR	S3214	128, 227, 334, 422, 626, 766, 832	18-7977	OMC	433190	227
18-7920	OMC	771839	128, 227, 334, 422, 626, 766, 832	18-7979	MERCURY MARINE	881540	334
18-7920	MERCURY MARINE	35-809099	128, 334, 626	18-7979	YAMAHA	68V-24563-00-00	423
18-7921	MERCURY MARINE	35-896546T	154, 156, 353	18-7979	YAMAHA	6D8-WS24A-00-00	423
18-7921	MERCURY MARINE	35-877767K01	154, 353	18-79799	YAMAHA	6P3-WS24A-00-00	423
18-7922	SUZUKI	99105-20004-BWL	127-129, 226, 227, 333, 334, 400, 422, 766	18-79809	YAMAHA	6P3-WS24A-00-00	423
18-7922			127, 227	18-7981	MERCURY MARINE	35-884380T	334
18-7924	YAMAHA	MAR-10171-00-10	127, 422	18-7981	MERCURY MARINE	35-8M0020349	334
18-7924			127, 227	18-7982-1			126, 333, 625
18-7925	WESTERBEKE	21235	152, 158, 581	18-7982-2			127, 226
18-7926	VOLVO	423135	152	18-7983-1	MERCURY MARINE	35-802893Q4	126, 333, 625
18-7926	VOLVO	4785974	152	18-7983-1	MERCURY MARINE	35-60494A4	126, 332, 625
18-7927	CATERPILLAR	1R-0714	152, 155, 581	18-7983-1	MERCURY MARINE	35-802893A4	126, 332, 625
18-7928	RACOR	B32013	84, 127, 227, 334, 422	18-7983-2			127, 226
18-7928			84, 127	18-7984-1	YAMAHA	MAR-SPRTR-HD-SS	126, 333, 625
18-7928			84, 127	18-7985-1			126, 333, 625
18-7929	MERCURY MARINE	35-809100	84, 127, 227, 334, 422, 626, 766, 832	18-7986-1			126, 333, 625
18-7929	RACOR	B32020MAM	84, 127, 227, 334, 422, 626, 766, 832	18-7987	RACOR	RK10222	128, 129, 400
18-7929			84, 127	18-7987	SUZUKI	99105-20006-BWL	129, 400
18-7929	OMC	173326	128, 766	18-7988			128, 129
18-7930	DETROIT DIESEL	5574508	129	18-7988	OMC	502906	128, 227, 766, 831
18-7932			127, 226	18-7989	VOLVO	3852413	128, 227, 766, 831
18-7934	CERLIST DIESEL	1512904	129	18-7989	VOLVO	3862228	128, 227, 766, 831
18-7935	FRAM	CCS 1136	129	18-7989	VOLVO	3851218-2	128, 831
18-7936	MERCURY MARINE	35-888289T2	334	18-7990-1			128, 831
18-7936	SUZUKI	15412-93J00	400	18-7990	YAMAHA	66K-13915-00-00	424
18-7937			127, 226	18-79901	YAMAHA	65L-13915-00-00	424
18-7938			127, 226	18-79902	YAMAHA	63P-13915-00-00	424
18-7939	GENERAC	10257778	129, 420	18-79903	YAMAHA	68V-13915-00-00	424
18-7940	VOLVO	838593	129, 832	18-79904	YAMAHA	68F-13915-00-00	424
18-7940	VOLVO	860874	129, 832	18-79905	YAMAHA	69J-24501-10-00	423
18-7940	VOLVO	3588378	129, 832	18-79906			128
18-7941			128, 227, 766	18-79907	Yamaha	60V-24251-01-00	424
18-7942	VOLVO	466987	129, 832	18-7991-1			128, 831
				18-79910	Yamaha	61N-24560-10	424

1 This product is priced per piece. To order, priced per package, please add -9 to the part number

2 Items ending in "D" are display packaged - regular number is non-display

3 For discount shop pack of 10, please add -10 to the part number

SIERRA #	O.E.M.	O.E. #	PAGE #	SIERRA #	O.E.M.	O.E. #	PAGE #
SIERRA							
18-7994			129, 334	18-80409	SUZUKI	65720-94401	401
18-79950	Yamaha		424	18-80411			100, 135
18-79951	Yamaha		424	18-80410	MERCURY MARINE	22-13563T3	331
18-79952	Yamaha		424	18-80410	NISSAN/TOHATSU	394-70250-0	396
18-79953	Yamaha		425	18-80412	MERCURY MARINE	22-816856T2	331
18-79960	Yanmar	104500-55710	129, 580	18-80413	YAMAHA	6Y1-24305-04	425
18-7997	MERCURY MARINE	35-853333T	335	18-80414	YAMAHA	6G1-24305-04	425
18-79970	Yamaha	6BG-13915-00	423	18-80414	YAMAHA	6G1-24305-05-00	425
18-79971	Yamaha	68F-13440-00	439	18-80415	YAMAHA	6E5-24305-05	425
18-79972	Yamaha	67F-14371-01	424	18-80415	YAMAHA	6Y2-24305-05	425
18-79973	Yamaha	6C5-13915-00	424	18-80417	NISSAN/TOHATSU	394-70260-0	396
18-79974	Yamaha	6J8-13411-00	439	18-80418	SUZUKI	65750-94404	401
18-79975	Yamaha	6E5-13411-00	439	18-80419	SUZUKI	65750-87J10	401
18-79976	Yamaha	61A-13411-00	439	18-80419	SUZUKI	65750-87J11	401
18-79977	Yamaha	6L5-24251-00	424	18-8042			100, 135
18-7998	MERCURY MARINE	35-893318T01	335	18-80420	HONDA	17650-921-003ZB	203
18-7999	MERCURY MARINE	35-896247	335	18-80425	SUZUKI	65720-986B0	401
18-8002EP-1			84, 130	18-8043			100, 135
18-8002S			136	18-8044			100, 135
18-8003	VOLVO	8692305	154, 848	18-8045			135
18-8004EP-1			84, 130	18-8046			135
18-8004EP-1	OMC	174511	84, 130	18-8047			135
18-8004EP-1	MERCURY MARINE	89396A38	130, 136, 330	18-8048			136, 229
18-8004EP-1	MERCURY MARINE	89396Q38	130, 136, 330	18-8050			136, 229
18-8004S	OMC	174511	136, 138	18-8051	OMC	322656	136, 229
18-8004S	MERCURY MARINE	89396A38	130, 136, 330	18-8052	OMC	122838	136, 229
18-8004S	MERCURY MARINE	89396Q38	130, 136, 330	18-8054	MERCURY MARINE	22-63186	135, 330
18-8005EP-1	MERCURY MARINE	13330Q5	330	18-8054			100, 135, 330
18-8005EP-1	OMC	174512	84, 130	18-8055	YAMAHA	ABA-FLINE-BA-RB	425
18-8005EP-1	MERCURY MARINE	13330A3	130, 136, 330	18-8055	OMC	173311	100, 135, 228, 330, 425, 767
18-8005EP-1	MERCURY MARINE	13330Q	130, 136, 330	18-8055	MERCURY MARINE	22-63187	135, 330
18-8005EP-1			84, 130	18-8055			100, 135, 228, 330, 425, 767
18-8005S	OMC	174512	136	18-8056	OMC	174508	228
18-8005S	MERCURY MARINE	13330A3	130, 136, 330	18-8056	OMC	775640	228
18-8005S	MERCURY MARINE	13330Q	130, 136, 330	18-8056	CHRYSLER FORCE	197787-3	192
18-8009EP-1	OMC	398549	131, 228	18-8062	SUZUKI	65750-98505	402
18-8009S	OMC	398549	137	18-8062	SUZUKI	502867	228
18-8010EP-1			132, 329	18-8063	OMC	772681	228
18-8010S			137	18-8063	OMC		228
18-8011EP-1	CHRYSLER FORCE	FS409752	131, 192	18-8063			135
18-8012EP-1	MERCURY MARINE	32-858114K08	132, 329	18-8067			132, 137, 329-331
18-8012EP-1	MERCURY MARINE	32-858114Q08	132, 329	18-8069	MERCURY MARINE	22831A3	331
18-8013EP-1			134, 300	18-8069	MERCURY MARINE	22831Q3	331
18-8013S			138	18-8070	MERCURY MARINE	30185A3	331
18-8014EP-1	OMC	174509	132, 228	18-8070	MERCURY MARINE	30185Q3	331
18-8014S	OMC	174509	137	18-8070	MERCURY MARINE	30185Q3	331
18-8015EP-1			134, 300	18-8071	SUZUKI	99105-00192	402
18-8015S			138	18-8071			131, 133, 192, 401, 402
18-8016EP-1	MERCURY MARINE	32-858109K12	133, 330	18-8072	OMC	174177	228, 767
18-8016EP-1	MERCURY MARINE	32-858109Q12	133, 330	18-8073			100, 132, 133, 135, 329, 330
18-8016S	MERCURY MARINE	32-858109K12	137	18-8074			100, 329, 330, 767
18-8016S	MERCURY MARINE	32-858109Q12	137	18-8074	OMC	173312	100, 135
18-8017EP-1	YAMAHA	6YL-24306-60-00	134, 425	18-8074	OMC	173312	100, 135
18-8017S	YAMAHA	6YL-24306-60-00	138	18-8075	MERCURY MARINE	22-14213M	331
18-8018EP-1	SUZUKI	65700-95513	133, 401	18-8075	MERCURY MARINE	22-14213Q	331
18-8019EP-1			133, 401	18-8076	MERCURY MARINE	22-13563A3	331
18-8020	MERCURY MARINE	54-41582-7	135	18-8076	MERCURY MARINE	22-13563Q3	331
18-8020			135, 229, 396, 767, 834	18-8077-1			134, 138, 331, 425
18-8020	VOLVO	3852170	135, 229, 396, 767, 834	18-8078	SUZUKI	65740-95500	402
18-8020	OMC	322652	135, 229, 396, 767, 834	18-8078	SUZUKI	99105-00193	402
18-8021			135, 229, 396, 767, 834	18-8078			133, 134, 395, 396, 401, 402
18-8021	VOLVO	3852529	135, 229, 396, 767, 834	18-8079	NISSAN/TOHATSU	3B2-70281-0	396
18-8021	OMC	911616	135, 229, 396, 767, 834	18-8079	SUZUKI	65750-95510	402
18-8023EP-1	MERCURY MARINE	32-857103K12	133, 330	18-8079	SUZUKI	65750-95500	396, 402
18-8023EP-1	MERCURY MARINE	32-857103Q12	133, 330	18-8082			132, 137, 329-331
18-8024EP-1	MERCURY MARINE	32-858104K08	132, 329	18-8083			132, 137, 329, 331
18-8024EP-1	MERCURY MARINE	32-858104Q08	132, 329	18-8084	MERCURY MARINE	30185A3	331
18-8025EP-1	MERCURY MARINE	32-858105K08	132, 330	18-8084	MERCURY MARINE	30185Q3	331
18-8025EP-1	MERCURY MARINE	32-858105Q08	132, 330	18-8085			331
18-8027EP-1			133, 395	18-8087	SUZUKI	65720-94411	402
18-8032EP-1			134, 300	18-8088	NISSAN/TOHATSU	345-70250-0	396
18-8032S			138	18-8089	NISSAN/TOHATSU	3B2-70260-0	133, 395, 396
18-8034	OMC	329654	135, 229, 767, 834	18-8090			402
18-8034	VOLVO	3852196	135, 229, 767, 834	18-8091	MERCURY MARINE	22-13563Q7	331
18-8035EP-1	SUZUKI	65700-87J10	134, 401	18-8091	MERCURY MARINE	22-13563T7	331
18-8040	YAMAHA	ABA-FBARB-90-DG	425	18-8092	OMC	176445	228
18-80400	HONDA	16977-ZV5-A00	203	18-8092	OMC	775641	228
18-80401			131, 136, 202, 203	18-8093			135
18-80402			133, 137, 330, 331	18-8094			135
18-80403			131, 136, 202, 203	18-8095			135
18-80404			134, 401, 402	18-81042EP-1	HONDA	17700-ZW9-010	131, 136, 202
18-80405			134, 401, 402	18-81042EP-1	HONDA	17700-ZW9-020	131, 136, 202
18-80406	HONDA	16977-ZV5-900	203	18-81042S	HONDA	17700-ZW9-010	131, 136, 202
18-80407	HONDA	17710-ZW9-033	203	18-81042S	HONDA	17700-ZW9-020	131, 136, 202
18-80408	HONDA	17650-ZW9-003	203	18-8108			135
				18-8109			135
				18-8110			135
				18-8111	MERCURY MARINE	22-36382	668

1 This product is priced per piece. To order, priced per package, please add -9 to the part number
 2 Items ending in "D" are display packaged - regular number is non-display
 3 For discount shop pack of 10, please add -10 to the part number

SIERRA #	O.E.M.	O.E. #	PAGE #	SIERRA #	O.E.M.	O.E. #	PAGE #
SIERRA							
18-8112	CRUSADER	97854	523, 525, 527, 529, 532	18-8373	SUZUKI	25700-90J01	408
18-8114			144	18-8374	SUZUKI	25700-92J00	408
18-8115			144	18-8375			409
18-8124	VOLVO	829913	129, 832	18-8377			409
18-8125	VOLVO	3583443	129, 832	18-8378			409
18-8126	VOLVO	861477	129, 832	18-8380	SUZUKI	25700-93J00	407
18-8149	VOLVO	3847644	128, 832	18-8381	SUZUKI	25700-99E00	407
18-8150			135	18-8382	MERCURY MARINE	26-816575A4	386
18-8150-10			135	18-8383	OMC	5000309	292
18-8151			135	18-8384	OMC	5006373	292
18-8151-10			135	18-8385	SUZUKI	25700-95J00	409
18-8152			135	18-8386	SUZUKI	25700-98J00	409
18-8152-10			135	18-8400-9	YAMAHA	90119-08M15-00	427
18-8200	OMC	322653	135, 229, 767, 834	18-8402	MERCURY MARINE	10-8053432	601
18-8200	VOLVO	3852171	135, 229, 767, 834	18-8403	MERCURY MARINE	10-8053433	601
18-8201	OMC	124249	135, 229, 767, 834	18-8404-1	MERCURY MARINE	10-8083434	601
18-8201			135, 229, 767, 834	18-8410	MERCURY MARINE	10-43749	668
18-8202	OMC	322654	135, 229, 767, 834	18-8411	MERCURY MARINE	10-44387	668
18-8202	VOLVO	3852172	135, 229, 767, 834	18-8500			668
18-8203	VOLVO	329653	135, 229, 767, 834	18-8501			503, 507, 508
18-8203	OMC	329653	135, 229, 767, 834	18-8502			842
18-8204	VOLVO	324825	135, 229, 767, 834	18-8503			550, 551
18-8204	OMC	324825	135, 229, 767, 834	18-8504			550-552
18-8205	MERCURY MARINE	30-803098T1	716	18-8505			668
18-8206	MERCURY MARINE	30-803099T1	s/s to 18-8206-1	18-8506			501, 505-508
18-8206-1	MERCURY MARINE	30-803099T1	716	18-8507			842
18-8207	MERCURY MARINE	43-803068T1	882-885	18-8508			668
18-8208	MERCURY MARINE	31-803090T1	736	18-8509			Obsolete
18-8212	MERCURY MARINE	30-803100T1	716	18-8510			841-843
18-8213	Mer cruiser	30-803097T1	716	18-8511			838, 840, 842, 843
18-8215			538, 539, 553	18-8512			653, 657, 659, 661, 668
18-8216	MERCURY MARINE	22-36305	671	18-8514			668
18-8216			538, 539, 553	18-8515			523, 527, 531, 532
18-8217	Mer cruiser	30-803098T1	716	18-8516			488-490
18-8218	Mer cruiser	30-803099T1	716	18-8517			503, 506, 508
18-8219	Mer cruiser	30-803100T1	716	18-8518			503, 505, 506, 508
18-8220	MERCURY MARINE	88-79023A91	605	18-8519			523, 527, 531, 532
18-8225	HONDA	16910-GB2-005	202	18-8520			668
18-8226	HONDA	16910-ZV4-015	202	18-8521			527, 530, 532
18-8227	MERCURY MARINE	73873A1	676	18-8523			523, 527, 531, 533
18-8297	MERCURY MARINE	861578	676	18-8524			523, 530, 533
18-8298	HONDA	91252-935-004	206	18-8526			501, 505, 508
18-8299	HONDA	91356-ZY3-003	206	18-8527			501, 505, 508
18-8300	OMC	341280	289, 293	18-8529			669
18-8301	OMC	341281	289, 293	18-8530			669
18-8304	OMC	321830	279, 293, 294	18-8531			669
18-8305	MERCURY MARINE	26-814754	354, 358, 366	18-8532			669
18-8307	OMC	331103	250, 293-295	18-8533			669
18-8308	MERCURY MARINE	26-30696	388	18-8534			773, 776, 777, 779
18-8309	MERCURY MARINE	18717	366	18-8535			777
18-8310	MERCURY MARINE	26-30900	388	18-8536	MARINE POWER	0994-000	539
18-8311			713	18-8536			490, 508, 529, 533, 539,
18-8312			713				552, 559, 563,
18-8313			713				669, 777, 842
18-8321	SUZUKI	09282-24003	Obsolete	18-8538			490, 508, 533,
18-8325	OMC	342786	271, 293				552, 561,
18-8326	OMC	342787	271, 293				563, 669, 777, 842
18-8331	SUZUKI	09168-10022	407, 408	18-8539			840, 842, 843
18-8334	SUZUKI	25223-94400	407, 408	18-8540			Obsolete
18-8335	SUZUKI	25700-87D00	408	18-8545			882-885
18-8337	OMC	5031456	292	18-8547			525, 529, 531, 533
18-8337	SUZUKI	25700-94400	408	18-8548			669
18-8338	SUZUKI	25700-94500	408	18-8549			669
18-8339	SUZUKI	25700-94700	408	18-8551			669
18-8340	SUZUKI	25700-95500	408	18-8553			773, 777
18-8341	SUZUKI	25700-95D00	408	18-8554			651, 655, 657,
18-8345	SUZUKI	09289-22007	408, 409				659, 663, 669
18-8347	CHRYSLER FORCE	26-816464-1	200	18-8555			669
18-8349	OMC	911795	293, 806	18-8556			669
18-8349	OMC	3852548	293, 806	18-8700	Yamaha	5GH-13440-20	154, 439
18-8350	OMC	328603	293	18-8800-1	MERCURY MARINE	84-813720A5	597
18-8351	OMC	321504	293	18-8800-1			150, 151, 481,
18-8352	OMC	332253	257				593, 597, 752
18-8353	OMC	320961	263	18-8800-1	MERCURY MARINE	84-816761Q5	150, 151, 597
18-8354	CHRYSLER FORCE	26-828627	200	18-8800-1	OMC	503748	752
18-8355			248	18-8801-1	MERCURY MARINE	84-813720A7	597
18-8357	VOLVO	875741	864	18-8801-1			150, 151, 514,
18-8358	VOLVO	876267	864				544, 593,
18-8359	VOLVO	876268	864				597, 752, 820
18-8360			801	18-8801-1	MERCURY MARINE	84-816761Q7	150, 597
18-8361	VOLVO	576266-8	864	18-8801-1	OMC	503750	752
18-8362-1			207	18-8801-1	VOLVO	876532-3	752
18-8363			207	18-8802-1	OMC	503752	151
18-8365			207	18-8802-1	OMC	503755	151
18-8366			207	18-8802-1	MERCURY MARINE	84-813720A12	597
18-8367	OMC	334950	293	18-8802-1	VOLVO	8757166	820
18-8368	VOLVO	813967	860	18-8802-1	MERCURY MARINE	84-816761Q12	151, 597
18-8369	OMC	914488	789, 791	18-8803-2	MERCURY MARINE	84-813720A10	597
18-8370			737	18-8803-2	MERCURY MARINE	84-813720A9	597
18-8371			737	18-8803-2	MERCURY MARINE	84-816761A9	597
18-8372	OMC	323582	264				

1 This product is priced per piece. To order, priced per package, please add -9 to the part number

2 Items ending in "D" are display packaged - regular number is non-display

3 For discount shop pack of 10, please add -10 to the part number

SIERRA #	O.E.M.	O.E. #	PAGE #	SIERRA #	O.E.M.	O.E. #	PAGE #
SIERRA							
18-8803-2	OMC	503752	753	18-8910	YAMAHA	68T-44352-00-00	426
18-8803-2	OMC	503755	753	18-8911	Yamaha	6L5-44352-00	426
18-8803-2			753	18-8920	NISSAN/TOHATSU	3B2-50021-1	396
18-8803-2	MERCURY MARINE	84-816761Q10	150, 151, 597	18-8921	NISSAN/TOHATSU	334-65021-0	396
18-8803-2	MERCURY MARINE	84-816761Q9	150, 151, 597	18-8922	NISSAN/TOHATSU	3C8-65021-2	396
18-8804-1	MERCURY MARINE	84-813720A2	597	18-8923	NISSAN/TOHATSU	345-65021-0	396
18-8804-1	MERCURY MARINE	84-813720A3	597	18-8924	NISSAN/TOHATSU	3B7-65021-2	396
18-8804-1	MERCURY MARINE	84-813720A4	597	18-8924	NISSAN/TOHATSU	3C7-65021-1	396
18-8804-1	MERCURY MARINE	84-816761A4	597	18-8925	Yamaha	6AW-44352-00-00	426
18-8804-1	MERCURY MARINE	84-816761Q3	150, 151, 597	18-8926	Crusader	RP061022	520
18-8804-1	MERCURY MARINE	84-816761Q4	150, 151, 597	18-8950	Yanmar	12423-42092	580
18-8804-1	MERCURY MARINE	84-816608Q61	150, 151, 597	18-8951	Yanmar	128176-42071	580
18-8805-1			151, 752	18-8997			167
18-8806-1			151, 752	18-8998			167
18-8807-1	OMC	503747	752	18-8999			167
18-8808-2	MERCURY MARINE	84-813720A6	597	18-9009			167
18-8808-2	MERCURY MARINE	84-816761Q6	150, 151, 597	18-9010	MERCURY MARINE	44357Q2	167
18-8809-1	MERCURY MARINE	84-813720A8	597	18-9010	MERCURY MARINE	44357A2	167, 382, 731
18-8809-1	MERCURY MARINE	84-816761A8	597	18-9010	MERCURY MARINE	73971A2	167, 382, 731
18-8809-1	MERCURY MARINE	84-816761Q8	150, 597	18-9013	OMC	174275	164
18-8810-1	MERCURY MARINE	84-813720A11	597	18-9013	OMC	175068	164
18-8810-1	OMC	503751	752	18-9013	OMC	775613	164
18-8810-1			150, 151, 514, 544, 593, 597, 752, 865	18-9013	MERCURY MARINE	92-78383A12	164
18-8810-1	MERCURY MARINE	84-816761Q16	150, 151, 597	18-9013	MERCURY MARINE	92-817529A12	164
18-8811-1	MERCURY MARINE	84-813720A13	597	18-9019-1			Obsolete
18-8811-1			150, 593, 597, 752	18-9020			167
18-8811-1	MERCURY MARINE	84-816761Q13	150, 597	18-9022-1			882-885
18-8811-1	OMC	503749	752	18-9023			167
18-8813-1	VOLVO	875571	151, 820	18-9024	OMC	174275	164
18-8814-1	OMC	503749	752	18-9024	OMC	175068	164
18-8815-1	OMC	582365	215	18-9024	OMC	775613	164
18-8816-1	OMC	582365	215	18-9024	MERCURY MARINE	92-78383A12	164
18-8817-1			150, 481	18-9024	MERCURY MARINE	92-817529A12	164
18-8818-1	OMC	582365	215	18-9031	MERCURY MARINE	92-86166	166, 718
18-8819-1			187, 307	18-9032			882-885
18-8820-1	OMC	503754	752	18-9065	OMC	174275	164
18-8820-1			150, 514, 544, 752, 865	18-9065	OMC	175068	164
18-8821-1	MERCURY MARINE	84-813720A3	597	18-9065	OMC	775613	164
18-8821-1	MERCURY MARINE	84-813720A4	597	18-9065	MERCURY MARINE	92-78383A12	164
18-8821-1	MERCURY MARINE	84-816761A17	597	18-9065	MERCURY MARINE	92-817529A12	164
18-8821-1	MERCURY MARINE	84-816761A4	597	18-9068			164
18-8821-1	MERCURY MARINE	84-816761Q3	150, 151, 597	18-9068			164
18-8821-1	MERCURY MARINE	84-816761Q4	150, 151, 597	18-9069			164
18-8821-1	MERCURY MARINE	84-816761Q17	150, 151, 597	18-9075	MERCURY MARINE	23-888690	382
18-8822-1	MERCURY MARINE	84-816608Q81	150, 597	18-9075	YAMAHA	61A-45538-00-00	429
18-8823-1	VOLVO	8757166	820	18-9076	MERCURY MARINE	23-888690-1	382, 429
18-8823-1	OMC	503752	752	18-9076	YAMAHA	61A-44527-00-00	382, 429
18-8823-1	OMC	503755	752	18-9077	MERCURY MARINE	13-888363-2	382
18-8823-1			151, 481, 544, 752, 820	18-9077	YAMAHA	90206-22M19	429
18-8824-1	MERCURY MARINE	84-816608Q78	151	18-9078	MERCURY MARINE	12-855682-2	382
18-8824-1			150, 151, 514, 544, 595, 597	18-9078	YAMAHA	90201-22M01	429
18-8825-1			752	18-9079	Yamaha		382, 429
18-8826-1			493	18-9080	OMC	174275	164
18-8827-1			493	18-9080	OMC	175068	164
18-8828-1	MERCURY MARINE	84-863656A1	151, 597	18-9080	OMC	775613	164
18-8829-1	MERCURY MARINE	84-863656A2	597	18-9080	MERCURY MARINE	92-78383A12	164
18-8830-1	MERCURY MARINE	84-816608Q80	597	18-9080	MERCURY MARINE	92-817529A12	164
18-8832-1	MERCURY MARINE	84-816608K68	150, 151, 597	18-9096	VOLVO	3847547	859
18-8833-1	MERCURY MARINE	84-816761K14	151, 597	18-9098	OMC	174448	800, 859
18-8834-1	MERCURY MARINE	84-816608Q83	150, 597	18-9098	VOLVO	174448	800, 859
18-8835-1	MERCURY MARINE	84-816608Q82	151, 597	18-9099	MERCURY MARINE	817019A1	731
18-8836-1	MERCURY MARINE	84-816608Q71	150, 597	18-9099	MERCURY MARINE	817019Q2	731
18-8837-1	MERCURY MARINE	84-847701A7	597	18-9125	OMC	787145	167, 229
18-8837-1	MERCURY MARINE	84-847701Q7	150, 151	18-9125	OETIKER	787133	167, 229
18-8838-1			151, 514, 596, 597, 752	18-9125	OMC	787133	167, 229
18-8838-1	MERCURY MARINE	84-881698	151, 597	18-9126-9	OMC	346930	167, 229
18-8839-1			215	18-9126-9	OETIKER	16700004	167, 229
18-8840-1			215	18-9127-9	OMC	348838	167, 229
18-8841-1	OMC	503749	752	18-9127-9	OETIKER	16700006	167, 229
18-8842-1	OMC	503753	752	18-9128-9	OMC	349516	167, 229
18-8843-1	OMC	503756	752	18-9128-9	OETIKER	16700007	167, 229
18-8844-1	Crusader		514	18-9129-9	OMC	347107	167, 229
18-8860	MERCURY MARINE	861677T	621	18-9129-9	OETIKER	16700010	167, 229
18-8861	MERCURY MARINE	861156A02	620	18-9130-9	OMC	347108	167, 229
18-8862	MERCURY MARINE	861156A03	620	18-9130-9	OETIKER	16700011	167, 229
18-8863	MERCURY MARINE	861156A04	620	18-9131-9	OMC	346931	167, 229
18-8864	MERCURY MARINE	866169T01	620	18-9131-9	OETIKER	16700012	167, 229
18-8865	MERCURY MARINE	866170A01	620	18-9132-9	OMC	346785	167, 229
18-8866	MERCURY MARINE	899106T10	327	18-9132-9	OETIKER	16700013	167, 229
18-8867	MERCURY MARINE	861155A6	620	18-9133-9	OMC	346786	167, 229, 426
18-8868	MERCURY MARINE	861155A3	621	18-9133-9	OETIKER	16700016	167, 229, 426
18-8900	CHRYSLER FORCE	47-19453	193, 337	18-9133-9	YAMAHA	YB-6AW04-1	426
18-8900	MERCURY MARINE	47-19453	193, 337	18-9134-9	OMC	348839	167, 229
18-8901	CHRYSLER FORCE	47-F462065	193	18-9134-9	OETIKER	16700017	167, 229
18-8903	CHRYSLER FORCE	47-F436065-2	193	18-9135-9	OMC	346151	167, 229
				18-9135-9	OETIKER	16700024	167, 229
				18-9136-9	OMC	346152	167, 229
				18-9136-9	OETIKER	16700031	167, 229
				18-9137-9	OMC	346153	167, 229
				18-9137-9	OETIKER	16700037	167, 229
				18-9138-9	OMC	349759	167, 229
				18-9138-9	OETIKER	16700040	167, 229

1 This product is priced per piece. To order, priced per package, please add -9 to the part number
 2 Items ending in "D" are display packaged - regular number is non-display
 3 For discount shop pack of 10, please add -10 to the part number

SIERRA #	O.E.M.	O.E. #	PAGE #	SIERRA #	O.E.M.	O.E. #	PAGE #
SIERRA							
18-9139-9	OMC	349729	167, 229	18-9650-2			163
18-9139-9	OETIKER	16700053	167, 229	18-9650-2P			163
18-9140-9	OMC	346150	167, 229	18-9650-5			163, 165
18-9140-9	OETIKER	16700020	167, 229	18-9650-5P			163
18-9141	OMC	787145	167, 229	18-9650-7			163
18-9141	OETIKER	14100082	167, 229	18-9650-7P			163
18-9145	YAMAHA	YB-6AW04-A	167, 426	18-9680-2	VOLVO	1141679	163
18-9146-9	YAMAHA	YB-6AW04-3	167, 426	18-9680-5	VOLVO	1141681	163
18-9200	MERCURY MARINE	92-81639A4	163	18-9680-7	VOLVO	1141682	163
18-9200	MERCURY MARINE	92-816391A4	721	18-9690-2			162
18-9218	MERCURY MARINE	814819A2	713	18-9690-3			162
18-9219	OMC	335677	282	18-9700-2			163
18-9400-2	MERCURY MARINE	92-802837Q1	161	18-9700-4			163
18-9400-2			112, 161	18-9710-0			163
18-9400-4	MERCURY MARINE	92-857389A1	161	18-9710-1			163
18-9400-7	MERCURY MARINE	92-802841A1	161	18-9730-1			163
18-9410-2	VOLVO	3842343	112, 162	18-9750-0			164
18-9410-2			112, 162	18-9751-0			164
18-9410-4	VOLVO	3842344	162	18-9751-2			164
18-9410-7	VOLVO	3858061	162	18-9775			164
18-9420-2	MERCURY MARINE	92-802833Q1	161	18-9776			164
18-9420-2			112, 159, 161	18-9777			164
18-9420-3	MERCURY MARINE	92-802835Q1	161	18-9778			165
18-9420-7	MERCURY MARINE	92-802836A1	161	18-9780			165
18-9440-2	MERCURY MARINE	92-883724K01	161	18-9781			165
18-9440-2P	MERCURY MARINE	92-883724K01	161	18-9782			165
18-9440-3	MERCURY MARINE	92-883723K01	162	18-9783			165
18-9440-4	MERCURY MARINE	92-883725K01	161	18-9784			165
18-9440-4P	MERCURY MARINE	92-883725K01	161	18-9785			165
18-9440-7	MERCURY MARINE	92-858057K01	161	18-9786			163, 165
18-9440-8	MERCURY MARINE	92-883722K01	162	18-9787			165
18-9494			159	18-9788			165
18-9495			159	18-9789			165
18-9496			159	18-9790			165
18-9497			159	18-9791			Obsolote
18-9498			159	18-9793			Obsolote
18-9499			159	18-9794			165
18-9500-1			159	18-9795			165
18-9500-2			159	18-9800			172
18-9500-2P			159	18-9801			172
18-9500-3			159	18-9801	MERCURY MARINE	91-99750A1	172, 310
18-9500-3P			159	18-9802			172
18-9500-4			159	18-9802	MERCURY MARINE	91-99379	172, 310
18-9500-4P			159	18-9803	MERCURY MARINE	91-36235	721
18-9500-7			159	18-9803	MERCURY MARINE	91-17256	168, 173
18-9500-7P			159	18-9804			165
18-9530-3	OMC	764354	159	18-9805	MERCURY MARINE	12-34961	882-885
18-9530-3	MERCURY MARINE	92-858037K01	159	18-9806E	MERCURY MARINE	91-12037	168, 173
18-9530-3	YAMAHA	LUB-2STRK-M1-4	159	18-9806E			168, 718, 719
18-9530-3P			159	18-9807	MERCURY MARINE	91-12427	168, 173
18-9530-6			159	18-9808	MERCURY MARINE	91-15755T	168, 169
18-9530-7	OMC	777228	159	18-9809	MERCURY MARINE	91-17257	168, 173
18-9530-7	MERCURY MARINE	92-858039K01	159	18-9810	MERCURY MARINE	91-17262A1	168, 173
18-9530-7	YAMAHA	LUB-2STRK-M1-55	159	18-9812	MERCURY MARINE	91-17275A1	168, 173
18-9540-2			159	18-9813	MERCURY MARINE	91-17302	168, 173
18-9540-3	OMC	764357	159	18-9814	MERCURY MARINE	91-29310	168, 169
18-9540-3P			159	18-9815	MERCURY MARINE	91-37324	169, 172
18-9540-7	OMC	777120	159	18-9816	MERCURY MARINE	91-30366T1	169, 172
18-9550-0			164	18-9817	MERCURY MARINE	91-31107T	168
18-9550-3			164	18-9818	MERCURY MARINE	91-31108T	168
18-9551-2	SUZUKI	990C0-10W40-1QT	160	18-9819	MERCURY MARINE	91-31229	169, 172
18-9551-3	SUZUKI	990C0-10W40-1GL	160	18-9820	MERCURY MARINE	91-31229A7	169, 173
18-9551-6			160	18-9821	MERCURY MARINE	91-32325T	169
18-9551-7			160	18-9822	MERCURY MARINE	91-32336	169, 172
18-9552-3	MERCURY MARINE	92-858084K01	160	18-9823	MERCURY MARINE	91-33489	169, 173
18-9552-6			160	18-9824	MERCURY MARINE	91-33491	169, 173
18-9552-8			160	18-9825	MERCURY MARINE	91-33492T	169
18-9553-2	VOLVO	40005011	112, 160	18-9826	MERCURY MARINE	91-33493T	169
18-9553-2			112, 160	18-9827	MERCURY MARINE	91-34379T	169
18-9553-3	VOLVO	40005012	160	18-9828	MERCURY MARINE	91-36379	169, 172
18-9553-3	MERCURY MARINE	92-858042K01	160	18-9829	MERCURY MARINE	91-36569	169
18-9553-3	MERCURY MARINE	92-858042Q01	160	18-9829	MERCURY MARINE	91-36569T	169
18-9553-5	VOLVO	40005013	160	18-9830	MERCURY MARINE	91-36571	169
18-9553-6			160	18-9830	MERCURY MARINE	91-36571T	169
18-9553-7	VOLVO	40005014	160	18-9831	MERCURY MARINE	91-36577	169, 173
18-9570-0			164	18-9832	MERCURY MARINE	91-37292	169, 172
18-9580-3			164	18-9833	MERCURY MARINE	91-37311	169, 173
18-9600-0			163	18-9834	MERCURY MARINE	91-37312	169, 173
18-9600-2			163	18-9835	MERCURY MARINE	91-37323	169
18-9600-2P			163	18-9836	MERCURY MARINE	91-37350	169
18-9600-5			163, 165	18-9837	MERCURY MARINE	91-38628T	169
18-9600-5P			163	18-9838	MERCURY MARINE	91-38756	170, 173
18-9600-7			163	18-9839	MERCURY MARINE	91-38918T	170
18-9600-7P			163	18-9840	MERCURY MARINE	91-38919	170, 173
18-9600-9			163	18-9841	MERCURY MARINE	91-42840T	170
18-9620-0			163	18-9842	MERCURY MARINE	91-43506T	170
18-9620-2			163	18-9843	MERCURY MARINE	91-43559	170, 173
18-9620-2P			163	18-9844	MERCURY MARINE	91-43579	170, 173
18-9620-5			163, 165	18-9845	MERCURY MARINE	91-43591T	170
18-9620-5P			163	18-9846	MERCURY MARINE	91-44110	170, 173
18-9650-0			163	18-9847	MERCURY MARINE	91-45497A1	170, 173

1 This product is priced per piece. To order, priced per package, please add -9 to the part number
 2 Items ending in "D" are display packaged - regular number is non-display
 3 For discount shop pack of 10, please add -10 to the part number

SIERRA #	O.E.M.	O.E. #	PAGE #	SIERRA #	O.E.M.	O.E. #	PAGE #
SIERRA							
18-9848	MERCURY MARINE	91-52393	169, 173	18-99061	YAMAHA	63D-W0001-00	440
18-9849	MERCURY MARINE	91-52394	169, 172	18-99062	YAMAHA	68F-11181-00	443
18-9850	MERCURY MARINE	91-53459	170, 173	18-99063	YAMAHA	63V-45315-A0	447
18-9851	MERCURY MARINE	91-55916	170, 173	18-99064	YAMAHA	64E-13645-A0	448
18-9852	MERCURY MARINE	91-55918	170, 173	18-99065	YAMAHA	650-24431-00	882-885
18-9853	MERCURY MARINE	91-56048001	170	18-99066	YAMAHA	65L-13645-00	448
18-9853	MERCURY MARINE	91-56048T	170	18-99067	YAMAHA	65L-13646-00	448
18-9854	MERCURY MARINE	91-56775T	171	18-99068	YAMAHA	65W-11169-00	448
18-9855	MERCURY MARINE	91-60523	171, 173	18-99069	YAMAHA	65W-11351-00	448
18-9856	MERCURY MARINE	91-60526T	171	18-99070	YAMAHA	65W-11356-00	448
18-9857	MERCURY MARINE	91-61067A3	171, 173	18-99071	YAMAHA	65W-14457-10	448
18-9858	MERCURY MARINE	91-61069T	171	18-99072	YAMAHA	65W-41114-00	448
18-9859	MERCURY MARINE	91-63616	171, 173	18-99073	YAMAHA	65W-W0001-00	440
18-9860	MERCURY MARINE	91-63638T	171	18-99074	YAMAHA	66M-11351-10	448
18-9861	MERCURY MARINE	91-78310	171, 173	18-99075	YAMAHA	66M-11356-00	448
18-9862	MERCURY MARINE	91-87119	172	18-99076	YAMAHA	66M-13329-10	448
18-9863	MERCURY MARINE	91-89865	171, 173	18-99078	YAMAHA	66M-41138-00	448
18-9864	MERCURY MARINE	91-43578A1	170, 173	18-99079	YAMAHA	66M-45115-00	448
18-9865	MERCURY MARINE	91-90774	172, 173	18-99080	YAMAHA	676-13646-A0	448
18-9866	MERCURY MARINE	91-89897	171, 173	18-99081	YAMAHA	676-41112-A0	448
18-9868	MERCURY MARINE	91-61077	171, 173	18-99082	YAMAHA	676-44315-A1	448
18-9869	MERCURY MARINE	91-817570T	171	18-99083	YAMAHA	676-44324-A0	448
18-9870	MERCURY MARINE	91-818162	171, 173	18-99084	YAMAHA	676-45127-00	448
18-9871	MERCURY MARINE	91-818169T	171	18-99085	YAMAHA	676-45128-00	448
18-9872	MERCURY MARINE	91-821571A1	171, 173	18-99086	YAMAHA	679-44316-A0	448
18-9873	MERCURY MARINE	91-813653	172	18-99087	YAMAHA	679-45315-A0	448
18-9874	MERCURY MARINE	91-14311A2	168, 173	18-99088	YAMAHA	67C-11356-00	448
18-9875	MERCURY MARINE	91-90244A1	172, 173	18-99089	YAMAHA	67C-41114-00	449
18-9876	OMC	349957	168, 792	18-99091	YAMAHA	67C-45113-00	449
18-9880			173	18-99092	YAMAHA	67C-W0001-00	440
18-9884	RACOR	RK22628	127, 129, 130	18-99093	YAMAHA	67C-W0001-20	440
18-9885	OMC	328360	169	18-99094	YAMAHA	67F-11181-02	443
18-9886	OMC	328361	169	18-99095	YAMAHA	682-11351-A0	449
18-9887	OMC	328363	169	18-99096	YAMAHA	682-41112-A1	449
18-9888	OMC	328364	169	18-99097	YAMAHA	682-W0001-06	440
18-9889	OMC	328365	169	18-99098	YAMAHA	688-13621-A1	449
18-9890	OMC	328366	169	18-99099	YAMAHA	68F-11193-01	449
18-9891	OMC	328367	169	18-99100	YAMAHA	68F-11381-00	449
18-9892	OMC	341440	169	18-99101	YAMAHA	68F-41114-00	449
18-9893	OMC	393185	Obsolete	18-99102	YAMAHA	68F-45113-00	449
18-9894	OMC	393279		18-99103	YAMAHA	68F-W0001-01	440
18-99000	YAMAHA	61A-41134-A0	445	18-99104	YAMAHA	6A0-W0001-21	440
18-99001	YAMAHA	61A-45114-A0	445	18-99105	YAMAHA	6E5-13621-A1	449
18-99002	YAMAHA	62Y-41133-00	445	18-99106	YAMAHA	6E9-11193-A0	449
18-99003	YAMAHA	62Y-41134-01	445	18-99107	YAMAHA	6E9-41114-A0	449
18-99004	YAMAHA	63D-45114-A0	445	18-99108	YAMAHA	6G1-11193-A1	449
18-99005	YAMAHA	63D-45123-00	445	18-99109	YAMAHA	6G1-13621-A1	449
18-99006	YAMAHA	63V-41133-A1	445	18-99110	YAMAHA	6G1-13645-A1	449
18-99008	YAMAHA	64J-41133-10	446	18-99111	YAMAHA	6G1-14198-A1	449
18-99009	YAMAHA	663-45123-00	446	18-99112	YAMAHA	6G1-41112-A1	449
18-99010	YAMAHA	664-41134-A0	446	18-99113	YAMAHA	6G1-41114-A0	449
18-99012	YAMAHA	66M-41133-00	446	18-99114	YAMAHA	6G1-41133-A0	449
18-99013	YAMAHA	66M-45113-00	446	18-99115	YAMAHA	6G1-45113-A1	449
18-99014	YAMAHA	676-41133-A0	446	18-99116	YAMAHA	6G1-45315-A0	449
18-99015	YAMAHA	676-45114-A0	446	18-99117	YAMAHA	6G1-W0001-A2	440
18-99016	YAMAHA	67C-41133-00	446	18-99118	YAMAHA	6G5-14483-A1	449
18-99017	YAMAHA	67C-45123-00	446	18-99119	YAMAHA	6G8-11351-A0	449
18-99018	YAMAHA	67F-41133-A1	446	18-99120	YAMAHA	6G8-12414-A0	449
18-99019	YAMAHA	67F-41134-A0	446	18-99121	YAMAHA	6G8-13646-A0	450
18-99020	YAMAHA	67F-45123-00	446	18-99122	YAMAHA	6G8-14198-A0	450
18-99021	YAMAHA	682-41133-A0	446	18-99123	YAMAHA	6G8-15374-00	450
18-99022	YAMAHA	682-45113-A1	446	18-99124	YAMAHA	6H3-12414-A1	450
18-99023	YAMAHA	688-41133-00	446	18-99125	YAMAHA	6H3-13622-00	450
18-99024	YAMAHA	688-41134-A0	446	18-99126	YAMAHA	6H3-14198-01	450
18-99025	YAMAHA	688-45114-A1	446	18-99128	YAMAHA	6H3-41112-A0	450
18-99026	YAMAHA	688-45123-00	446	18-99129	YAMAHA	6H3-41114-A0	450
18-99027	YAMAHA	68T-13475-00	446	18-99130	YAMAHA	6H3-45113-A0	450
18-99028	YAMAHA	68V-15312-00	446	18-99132	YAMAHA	6H4-13621-A1	450
18-99030	YAMAHA	697-45114-A0	447	18-99133	YAMAHA	6H4-14198-01	450
18-99032	YAMAHA	69J-41134-A0	447	18-99134	YAMAHA	6H4-15369-A1	450
18-99033	YAMAHA	69J-41135-A0	447	18-99135	YAMAHA	6H4-41112-A0	450
18-99034	YAMAHA	69J-41136-A0	447	18-99136	YAMAHA	6K7-13686-A1	450
18-99037	YAMAHA	6E5-41134-A0	447	18-99137	YAMAHA	6L2-41133-A2	450
18-99038	YAMAHA	6E5-41135-A0	447	18-99138	YAMAHA	6L2-45315-A0	450
18-99039	YAMAHA	6G5-41134-A1	447	18-99139	YAMAHA	6OV-13646-00	450
18-99040	YAMAHA	6G5-45114-A1	447	18-99140	Yamaha	63V-11181-A2	450
18-99045	YAMAHA	6G8-45113-A1	447	18-99141	Yamaha	6H3-11193-A1	450
18-99046	YAMAHA	6H3-45114-A1	447	18-99142	Yamaha	6E9-12414-A1	450
18-99047	YAMAHA	6H3-45123-00	447	18-99143	Yamaha	6H3-13621-A1	450
18-99048	YAMAHA	60V-11181-00	443	18-99144	Yamaha	6E7-14227-00	450
18-99049	YAMAHA	60V-13621-A0	447	18-99145	Yamaha	677-14198-A1	450
18-99050	YAMAHA	60V-13645-00	447	18-99146	Yamaha	677-14384-01	418
18-99051	YAMAHA	61A-11193-A1	447	18-99147	Yamaha	6G1-24431-01	450
18-99052	YAMAHA	61A-11381-A0	447	18-99148	Yamaha	688-41114-A0	450
18-99053	YAMAHA	61A-13621-A0	447	18-99149	Yamaha	663-44316-A0	451
18-99054	YAMAHA	61A-13645-00	447	18-99150	Yamaha	63V-45113-A1	451
18-99055	YAMAHA	61A-13646-00	447	18-99151	Yamaha	688-45113-A0	451
18-99056	YAMAHA	61A-45113-A0	447	18-99152	Yamaha	683-45315-A0	451
18-99057	YAMAHA	61T-11193-A1	447	18-99175	Yamaha	63V-W0001-01	442
18-99059	YAMAHA	63D-11193-A0	443	18-99176	Yamaha	6H3-W0001-02	442
18-99060	YAMAHA	63D-11181-A1	443	18-ADA500			180

1 This product is priced per piece. To order, priced per package, please add -9 to the part number
 2 Items ending in "D" are display packaged - regular number is non-display
 3 For discount shop pack of 10, please add -10 to the part number

SIERRA #	O.E.M.	O.E. #	PAGE #	SIERRA #	O.E.M.	O.E. #	PAGE #
SIERRA							
18-ADA501			180	18-SD119			180
18-ADA502			180	18-SD120	Volvo		180
18-ADA503			181	18-SD202			180
18-ADA504			181	18-SD405			184
18-ADA505			181	18-SD406			184
18-ADA506			181	18-SD407			184
18-ADA507			181	18-SD413			184
18-ADA508			181	35-SS600			174
18-ADA510			181	35-SS605			174
18-ADA512			181	35-SS610			174
18-ADC152			182	35-SS615			174
18-ADC153			182	35-SS620			174
18-ADC199			184	35-SS625			174
18-ADC300			182	35-SS630			174
18-ADC300E			182	35-SS635			174
18-ADC400			182	35-SS645			174
18-ADC401			182	35-SS650			174
18-ADC402			182	35-SS655	Volvo		174
18-ADC403			183	35-SS660			174
18-ADC404			183	35-SS665			174
18-ADC406			183	35-SS670	Johnson/Evinrude		174
18-ADC407			183	35-SS680	Johnson/Evinrude		174
18-ADC408			183	35-SS685	Honda		174
18-ADC409			182	35-SS690	Yamaha		174
18-ADC410			183	35-SS695			174
18-ADC412			182	35-SS700			174
18-ADC414			183	35-SS715	Mercury		174
18-ADC415			183	35-SSKIT1			174
18-ADC416			183	56966P			19, 112
18-ADC417			183	56967P			19, 112
18-ADC418			183	BC88523			56
18-ADC419			183	BC88533			56
18-ADC420			184	BC88543			56
18-ADC421			184	BC88553			56
18-ADC422			184	BC88563			56
18-ADC423			184	BC88573			56
18-ADC424			184	BC88583			56
18-ADC425			184	BC88593			56
18-ADC450			182	MP28860	YAMAHA	682-82556-00-00	32, 411
18-SD100			180	MP28870	OMC	585134	32, 215
18-SD102			179	MP28880	OMC	432230	32, 215, 751
18-SD103			179	MP28890	OMC	176288	32, 215, 751
18-SD104			179	MP39100	OMC	386545	215
18-SD105			179	MP39160			45, 411
18-SD106			179	MP39760	OMC	393301	215
18-SD107			179	MP39760	OMC	508180	215
18-SD108			179	MP39830	OMC	386545	215
18-SD109			179	MP41000	MERCURY MARINE	87-88107	308
18-SD110			179	MP41070-2	MERCURY MARINE	87-17009A2	308
18-SD111			184	MP51010	SUZUKI	37110-99-E00	25, 399
18-SD111			184	MP51012	SUZUKI	37110-99-E00	25, 399
18-SD112			184	MP51020	YAMAHA	703-82510-12-00	25, 411
18-SD112			184	MP51022	YAMAHA	703-82510-12-00	25, 411
18-SD113			184	MP51030	YAMAHA	61B-82510-01-00	25, 411
18-SD113			184	MP51032	YAMAHA	61B-82510-01-00	25, 411
18-SD114			184	MP51040	YAMAHA	703-82510-43-00	25, 411
18-SD114			184	MP51042	YAMAHA	703-82510-43-00	25, 411
18-SD115			184	MP51050	YAMAHA	6K1-82510-06-00	25, 411
18-SD115			184	MP51052	YAMAHA	6K1-82510-06-00	25, 411
18-SD116			184	MP51090	MERCURY MARINE	87-17009A5	25, 308
18-SD116			184	MP51092	MERCURY MARINE	87-17009A5	25, 308
18-SD117			184	MP52000	MERCURY MARINE	87-88107A5	25, 308
18-SD117			184	MP52002	MERCURY MARINE	87-88107A5	25, 308
18-SD118			180				

INTERCHANGE GUIDE — Part Number to Page Number



1 This product is priced per piece. To order, priced per package, please add -9 to the part number
 2 Items ending in "D" are display packaged - regular number is non-display
 3 For discount shop pack of 10, please add -10 to the part number

PREMIUM BLEND TC-W3			
Part No.	Description		
18-9500-1	Pint (12 per case) (473ml)		
18-9500-2	Quart (12 per case) (946ml)		
18-9500-2P	84 case pallet (Qt.)		
18-9500-3	Gallon (6 per case) (3.78L)		
18-9500-3P	36 case pallet (Ga.)		
18-9500-4	2.5 Gallon (2 per case) (9.46L)		
18-9500-4P	42 case pallet (2.5 Ga.)		
18-9500-7	55 Gallons (208L)		
18-9500-7P	4 - 55 Gallon drum pallet		

DIRECT INJECTION, TC-W3			
Part No.	Description	OE	OE No.
18-9530-3	Gallon (3.78L)	Mercury Optimax Yamaha HPDI BRP Ficht, DI	92-858037K01 LUB-2STRK-M1-4 764354
18-9530-3P	36 Case Pallet (Gal)		
18-9530-6	16 Gallon (61L)		
18-9530-7	55 Gallon Drum	Mercury Optimax Yamaha HPDI BRP Ficht, DI	92-858039K01 LUB-2STRK-M1-55 777228

FULL SYNTHETIC TC-W3 2-STROKE OUTBOARD			
Part No.	Description	OE	OE No.
18-9540-2	Quart (964ml)	BRP E-Tec/Universal	—
18-9540-3	Gallon (3.78L)	BRP E-Tec/Universal	764357
18-9540-3P	36 Case Pallet (Gal)		
18-9540-7	55 Gal. Drum	BRP E-Tec/Universal	777120

SIERRA 25W-50 MARINE ENGINE OIL			
Part No.	Mercury No.	Description	Case Qty.
18-9552-3	92-858084K01	4 Liter (4.2224 qt.)	6
18-9552-8	—	1 Liter (1.0556 qt.)	12
18-9552-6	—	16 Gallon (61L)	

SIERRA 10W-40 FC-W MARINE ENGINE OIL			
Part No.	Suzuki No.	Description	Case Qty.
18-9551-2	990C0-10W40-1QT	Quart (946ml)	12
18-9551-3	990C0-10W40-1GL	Gallon (3.785L)	6
18-9551-6		16 Gallon (61L)	
18-9551-7		55 Gallon (208L)	

15W-40 DIESEL ENGINE OIL				
Part No.	Mercury No.	Volvo No.	Description	Case Qty.
18-9553-2	—	40005011	Quart (946ml)	12
18-9553-3		40005012	Gallon (3.785L)	6
18-9553-5	—	40005013	5 Gallon (18.95L)	
18-9553-6	—	—	16 Gallon (61L)	
18-9553-7	—	40005014	55 Gallon (208L)	

SIERRA 10W30 4 STROKE MARINE OUTBOARD ENGINE OIL			
Part No.	Mercury No.	Description	Case Qty.
18-9420-2	92-802833Q1	Quart (946ml)	12
18-9420-3	92-802835Q1	Gallon (3.785L)	6
18-9420-7	92-802836A1	55 Gallon (208L)	

SIERRA 25W40 4 STROKE MARINE STERN DRIVE ENGINE OIL			
Part No.	Mercuriser No.	Description	Case Qty.
18-9400-2	92-802837Q1	Quart (946ml)	12
18-9400-4	92-857389A1	5 Quart (4.7 L)	4
18-9400-7	92-802841A1	55 Gallon (208L)	

SYNTHETIC BLEND MERCUISER STERNDRIEVE ENGINE OIL			
Part No.	Mercuriser No.	Description	Case Qty.
18-9440-2	92-883724K01	Quart (946ml)	12
18-9440-2P	92-883724K01	84 Case Pallet (Qt.)	12
18-9440-4	92-883725K01	5 Quart (4.7 L)	4
18-9440-4P	92-883725K01	36 Case Pallet (5Qt.)	4
18-9440-7	92-858057K01	55 Gallon (208L)	

SYNTHETIC BLEND 4-STROKE OUTBOARD OIL 25W40			
Part No.	Mercury No.	Description	Case Qty.
18-9440-3	92-883723K01	4 Liter (4.2224 qt.)	6
18-9440-8	92-883722K01	1 Liter (1.0556 qt.)	12

FULL SYNTHETIC ENGINE OIL SAE 30			
Part No.	Volvo No.	Description	Case Qty.
18-9410-2	3842343	1 Quart (946ml)	12
18-9410-4	3842344*	5 Quarts (4.7L)	4
18-9410-7	3858061	55 Gallon (208L)	

* Convenient 5 qt Container

10W30 SYNTHETIC MARINE ENGINE LUBRICANT			
Part No.	Volvo No.	Description	Case Qty.
18-9690-2	—	1 Quart (946ml)	12
18-9690-3	—	1 Gallon	6

NMMA FC-W Certified for use in 4 stroke OB and stern drive applications

All listed oil capacities are approximate amounts only and may or may not include the oil filter capacity. ALWAYS follow proper crankcase drain and fill procedures. Check engine dipstick for proper crankcase oil level.

OIL FILTER QUICK-REFERENCE GUIDE



Albin

Model	Year	Oil Filter	Replaces	Crankcase Capacity	Recommended Oil
AD-21		18-7878-1	3875827	See Owners Manual	See Owners Manual

B & W Lathrop

Model	Year	Oil Filter	Replaces	Crankcase Capacity	Recommended Oil
130155		18-7875		See Owners Manual	See Owners Manual

Caterpillar

Model	Year	Oil Filter	Replaces	Crankcase Capacity	Recommended Oil
3304, 3306, D330		18-7880	1R-0658	See Owners Manual	See Owners Manual
3116, 3116TA, 3208, 3208T, 3208TA		18-7927	1R-0714	See Owners Manual	See Owners Manual

Chris-Craft

Model	Year	Oil Filter	Replaces	Crankcase Capacity	Recommended Oil
307G, 305K,307K		18-7824	16.81-08746	See Owners Manual	See Owners Manual

Chrysler

Model	Year	Oil Filter	Replaces	Crankcase Capacity	Recommended Oil
(Chrysler-Volvo) 100, 110, 120, 130, 165, 170		18-7878-1 ①		See Owners Manual	See Owners Manual
125, 150, 155, 175, Fury 190, 195, 200, 210,225, 235, 250, 260, 280, 300, 330, 335, 375, 525, CM6-55, CMC-55NA, M-170A, M-225A, M-225D, M-273A, M-273B, M-273BO/D, LM-318, LM-318A, LM-318B, M-318B, M-318C, M-383B, M-413B, M-413D, M-413E, M-440B, M-440D, Model 340,M-80, M-81, Super Crown 145, 150, Imperial 290, 325, Jet II, Jet III, Jet IV, Super Bee, Super Bee II,Super Bee III, V-8 Engines 1962-on V-6 GM 3.7L, 5.2L		18-7875	1851658	See Owners Manual	See Owners Manual
		18-7875	1851658	See Owners Manual	See Owners Manual
		18-7875	1851658	See Owners Manual	See Owners Manual
		18-7875	1851658	See Owners Manual	See Owners Manual
		18-7875	1851658	See Owners Manual	See Owners Manual
		18-7875	1851658	See Owners Manual	See Owners Manual
		18-7875	1851658	See Owners Manual	See Owners Manual
		18-7875	1851658	See Owners Manual	See Owners Manual
		18-7875	1851658	See Owners Manual	See Owners Manual
		18-7875	1851658	See Owners Manual	See Owners Manual
		18-7875	1851658	See Owners Manual	See Owners Manual
		18-7875	1851658	See Owners Manual	See Owners Manual
		18-7875	1851658	See Owners Manual	See Owners Manual
		18-7875	1851658	See Owners Manual	See Owners Manual
		18-7875	1851658	See Owners Manual	See Owners Manual
		18-7875	1851658	See Owners Manual	See Owners Manual
		18-7879	L-319	See Owners Manual	See Owners Manual
		18-7878-1	3549957, L-19, L1008	See Owners Manual	See Owners Manual

Commander

Model	Year	Oil Filter	Replaces	Crankcase Capacity	Recommended Oil
225, 340 Clevor		18-7875		See Owners Manual	See Owners Manual

Crusader

Model	Year	Oil Filter	Replaces	Crankcase Capacity	Recommended Oil
150, 160,165, CH185, 210, CH220, CH270, 350, CH350		18-7824	201104	See Owners Manual	See Owners Manual
SS330		18-7876 (Long), 18-7824 (Short)	201104	See Owners Manual	See Owners Manual
220 Conqueror,255 Conqueror, 255 Conqueror Jet, 250 (71), 300 Scorpion, 460		18-7875	9002514	See Owners Manual	See Owners Manual
220, 300, 320,325		18-7878-1		See Owners Manual	See Owners Manual
5.0L Carbureted (Classic)	1999 - 2008	18-7875	22679	See Owners Manual	API 15W-40 SM or Higher
5.7L Carbureted (Classic)	1999 - 2010	18-7875	22679	See Owners Manual	API 15W-40 SM or Higher
5.0L MPI (Captains Choice)	2004 - 2010	18-7875	22679	5.67L / 6.0 Qt.	API 15W-40 SM or Higher
5.7L MPI (Captains Choice)	2005 - 2010	18-7875	22679	5.67L / 6.0 Qt.	API 15W-40 SM or Higher
6.0L MPI (Captains Choice)	2006 - 2010	18-7875	22679	4.75L / 5.0 Qt.	API 15W-40 SM or Higher
7.4L MPI (Captains Choice)	All	18-7875	22679	See Owners Manual	API 15W-40 SM or Higher
8.1L MPI (Captains Choice)	2001 - 2010	18-7875	22679	6.65 L / 7.0 Qt.	API 15W-40 SM or Higher
8.1L MPI HO (Captains Choice)	2009 - 2010	18-7875	22679	6.65 L / 7.0 Qt.	API 15W-40 SM or Higher

All listed oil capacities are approximate amounts only and may or may not include the oil filter capacity.
ALWAYS follow proper crankcase drain and fill procedures. Check engine dipstick for proper crankcase oil level.

Detroit Diesel

Model	Year	Oil Filter	Replaces	Crankcase Capacity	Recommended Oil
2-71 (142), 3-71 (213), 4-53 (212), 4-71 (284), 6V-53 (318), 6-71 (426), 6-71E (426), 671N (426), 6-71T (426), 6V-71 (426), 6V-71T (426), 6V-92 (552), 6V-92T (522), 8V-71 (568), 8V-71T (568), 8V-92 (736), 8V-92T (736), 12V-71 (1788), 12V-71T (1788), 12V-149 (1788), 16V-71 (1136), 16V-71T (1136), 16V-92 (1472), 16V-92T (1472), 16V-149 (2384) Series		18-7899	25010495	See Owners Manual	See Owners Manual

Evinrude/Johnson

Model	Year	Oil Filter	Replaces	Crankcase Capacity	Recommended Oil
4hp.	2003 - 2005	----	5033378	700 ml. / 23.6 oz.	10W40 Synthetic Blend FC-W
5hp.	2000 - 2001	----	449534	798 ml. / 27.0 oz.	10W40 Synthetic Blend FC-W
5hp.	2003 - 2005	----	449534	700 ml. / 23.6 oz.	10W40 Synthetic Blend FC-W
6hp.	1997 - 2004	----	449534	798 ml. / 27.0 oz.	10W40 Synthetic Blend FC-W
8hp.	1996 - 2004	----	449534	1000 ml. / 33.8 oz.	10W40 Synthetic Blend FC-W
9.9hp.	1997 - 1998	----	449534	1000 ml. / 33.8 oz.	10W40 Synthetic Blend FC-W
9.9-15 hp.(OMC Built; 305cc)	1995 - 2001	18-7916	434839	1272 ml. / 43 oz.	10W40 Synthetic Blend FC-W
9.9-15 hp.(302cc)	2002 - 2006	18-7903	5033102	1.1 L / 1.2 Qt.	10W40 Synthetic Blend FC-W
25-30 hp.	2003 - 2006	18-7915-1	778885 434839	3.2 L / 3.4 Qt.	10W40 Synthetic Blend FC-W
40-50 hp.	1999 - 2001	18-7915-1	778885 434839	2.4 L / 2.5 Qt.	10W40 Synthetic Blend FC-W
60-70 hp.	1998 - 2002	18-7915-1	778885 434839	4.5 L / 4.8 Qt.	10W40 Synthetic Blend FC-W
90-115 EFI	2003 - 2005	18-7896	778886 5033539	5.7 L / 6.0 Qt.	25W-40 Synthetic Blend FC-W
140 EFI	2003 - 2005	18-7897	778887 503919	5.7 L / 6.0 Qt.	25W-40 Synthetic Blend FC-W
200-225	2004 - 2005	18-7895	778888 5035703	8.2 L / 8.7 Qt.	25W-40 Synthetic Blend FC-W

Fischer Panda

Model	Year	Oil Filter	Replaces	Crankcase Capacity	Recommended Oil
PMS 8 Mini		23-7804	SE15853-99170	2.5L / 2.64 Qt.	15W-40 API CF or Higher
PMS 8 DP		23-7804	SE15853-99170	2.5L / 2.64 Qt.	15W-40 API CF or Higher
PMS 4200		23-7804	SE15853-99170	1L / 1.05 Qt.	15W-40 API CF or Higher
PMS 6500		23-7804	SE15853-99170	2.5L / 2.64 Qt.	15W-40 API CF or Higher
PMS 12 DP		23-7804	SE15853-99170	3.8L / 4.0 Qt.	15W-40 API CF or Higher
PMS 12 Mini		23-7804	SE15853-99170	3.8L / 4.0 Qt.	15W-40 API CF or Higher
PMS 16 DP		23-7842		See Owners Manual	15W-40 API CF or Higher
PMS 22		23-7842		See Owners Manual	15W-40 API CF or Higher

Flagship

Model	Year	Oil Filter	Replaces	Crankcase Capacity	Recommended Oil
150FA, 220FF, 250FA, 400FA,		18-7824		See Owners Manual	See Owners Manual

All listed oil capacities are approximate amounts only and may or may not include the oil filter capacity.
ALWAYS follow proper crankcase drain and fill procedures. Check engine dipstick for proper crankcase oil level.

OIL FILTER QUICK-REFERENCE GUIDE



Flagship Continued

Model	Year	Oil Filter	Replaces	Crankcase Capacity	Recommended Oil
425FAJ, 650FAJ, 950FAJ		18-7824		See Owners Manual	See Owners Manual
292, 300, 307, 327, 350, 482		18-7824 (Short) 18-7876 (Long)		See Owners Manual	See Owners Manual

Ford

Model	Year	Oil Filter	Replaces	Crankcase Capacity	Recommended Oil
CSG850M WSG858M,LSG875M,		18-7875		See Owners Manual	See Owners Manual
SSD-655,-655M, -655MT, (5.5 Liter),		18-7875		See Owners Manual	See Owners Manual
140(2.3L) FOUR, 170, 200 Six, 240 Six,		18-7875		See Owners Manual	See Owners Manual
300 Six, 302 (5.0L),351 (5.8L),		18-7875		See Owners Manual	See Owners Manual
460 (7.5L),2711E, 2712E, 2713E,		18-7875		See Owners Manual	See Owners Manual
2714E, 2715E (diesel)		18-7875		See Owners Manual	See Owners Manual
254 (DSD-442 4.2 Liter), 362		18-7875		See Owners Manual	See Owners Manual
(DSD-659 5.9 Liter)		18-7875		See Owners Manual	See Owners Manual
91—V4, 104 V4, 380 (DSD-662 6.2 Liter)		18-7878-1		See Owners Manual	See Owners Manual

GM

Model	Year	Oil Filter	Replaces	Crankcase Capacity	Recommended Oil
IL6-194	1962 - 1967	18-7876		See Owners Manual	See Owners Manual
IL6-230	1963 - 1968	18-7876		See Owners Manual	See Owners Manual
267	1979 - 1981	18-7876		See Owners Manual	See Owners Manual
305	1976 - 1987	18-7876		See Owners Manual	See Owners Manual
307	1970 - 1973	18-7876		See Owners Manual	See Owners Manual
350	1970 - 1987	18-7876		See Owners Manual	See Owners Manual
366	1970 - 1987	18-7876		See Owners Manual	See Owners Manual
400	1971 - 1972	18-7876		See Owners Manual	See Owners Manual
400	1975 - 1983	18-7876		See Owners Manual	See Owners Manual
454	1973 - 1987	18-7876		See Owners Manual	See Owners Manual
400	1974 - 1977	18-7824		See Owners Manual	See Owners Manual

Greenwich

Model	Year	Oil Filter	Replaces	Crankcase Capacity	Recommended Oil
Porpoise (w/IH V8-275B)		18-7875		See Owners Manual	See Owners Manual

Honda

Model	Year	Oil Filter	Replaces	Crankcase Capacity	Recommended Oil
BF2A	All	----	----	0.40 L / 0.42 Qt.	10W-30 FC-W
BF2D	All	----	----	0.25 L / 0.26 Qt.	10W-30 FC-W
BF5	All	----	----	0.55 L / 0.58 Qt.	10W-30 FC-W
BF75 (7.5hp)	All	----	----	0.76 L / 0.80 Qt.	10W-30 FC-W
BF8 / BFP8	2001 - Current	18-7913	15400-PFB-014		
			15400-PFB-004	0.76 L / 0.80 Qt.	10W-30 FC-W
BF9.9 / BFP9.9	2001 - Current	18-7913	15400-PFB-014		
			15400-PFB-004	1.1L / 1.2 Qt.	10W-30 FC-W
BF100 (10 hp.)		----	----	0.76 L / 0.80 Qt.	10W-40 FC-W
BF15 / BFP15	2003 - Current	18-7913	15400-PFB-014		
			15400-PFB-004	1.1L / 1.2 Qt.	10W-30 FC-W
BF20	2003 - Current	18-7913	15400-PFB-014		
			15400-PFB-004	1 L / 1.1 Qt.	10W-30 FC-W
BF25	1998 & Earlier	18-7913	15400-PFB-014		
			15400-PFB-004		
			15400-PM3-004		
			15400-PJ7-015	1.6L / 1.7 Qt.	10W-30 FC-W
BF25 (Up to serial number 1003206)	1999 - 2005	18-7911-1	15400-PFB-007	1.6L / 1.7 Qt.	10W-30 FC-W
BF25 (Starting serial number 1003207)	2005 - Current	18-7913	15400-PFB-014	1.6L / 1.7 Qt.	5W-30 FC-W

All listed oil capacities are approximate amounts only and may or may not include the oil filter capacity.
ALWAYS follow proper crankcase drain and fill procedures. Check engine dipstick for proper crankcase oil level.

Honda

Model	Year	Oil Filter	Replaces	Crankcase Capacity	Recommended Oil
BF30	1998 & Earlier	18-7913	15400-PFB-014 15400-PFB-004 15400-PM3-004 15400-PJ7-015	1.6L / 1.7 Qt.	10W-30 FC-W
BF30 (Up to serial number 1005016)	1999 - 2005	18-7911-1	15400-PFB-007	1.6L / 1.7 Qt.	10W-30 FC-W
BF30 (Starting serial number 1005017)	2005 - Current	18-7913	15400-PFB-014	1.6L / 1.7 Qt.	5W-30 FC-W
BF35	1997	18-7913	15400-PFB-014 15400-PFB-004 15400-PM3-004 15400-PJ7-015	2.4L / 2.5 Qt.	10W-30 FC-W
BF40	1998 & Earlier	18-7913	15400-PFB-014 15400-PFB-004	2.4L / 2.5 Qt.	10W-30 FC-W
BF40 (Up to serial number 3007642)	1999 - 2005	18-7911-1	15400-PFB-007	2.4L / 2.5 Qt.	10W-30 FC-W
BF40 (Starting serial number 3007643)	2005 - Current	18-7913	15400-PFB-014	2.0L / 2.1 Qt.	5W-30 FC-W
BF45	1997	18-7913	15400-PFB-014 15400-PFB-004 15400-PM3-004 15400-PJ7-015	2.4L / 2.5 Qt.	10W-30 FC-W
BF50	1998 & Earlier	18-7913	15400-PFB-014 15400-PFB-004 15400-PM3-004 15400-PJ7-015	2.4L / 2.5 Qt.	10W-30 FC-W
BF50 (Up to serial number 3014456)	1999 - 2005	18-7911-1	15400-PFB-007	2.4L / 2.5 Qt.	10W-30 FC-W
BF50 (Starting serial number 301457)	2005 - Current	18-7913	15400-PFB-014	2.0L / 2.1 Qt.	5W-30 FC-W
BF60 / BFP60	All	18-7913	15400-PFB-014 15400-PFB-004	2.6L / 2.7 Qt.	10W-30 FC-W
BF75	1997 - Current	18-7909	15400-PLM-A01PE 15400-POH-305PE 15400-ZJ1-004	4.2L / 4.4 Qt.	10W-30 FC-W
BF90	1997 - Current	18-7909	15400-PLM-A01PE 15400-POH-305PE 15400-ZJ1-004	4.2L / 4.4 Qt.	10W-30 FC-W
BF115	1999 - 2009	18-7909	15400-PLM-A01PE 15400-POH-305PE 15400-ZJ1-004	5.6L / 5.9 Qt.	10W-30 FC-W
BF115	2010 - Current	18-7909	15400-PLM-A01PE 15400-POH-305PE 15400-ZJ1-004	6.5L / 6.9Qt.	10W-30 FC-W
BF130	1999 - 2004	18-7909	15400-PLM-A01PE 15400-POH-305PE 15400-ZJ1-004	5.6L / 5.9 Qt.	10W-30 FC-W
BF135	2004 - Current	18-7909	15400-PLM-A01PE 15400-POH-305PE 15400-ZJ1-004	6.5L / 6.9Qt.	10W-30 FC-W
BF150	2004 - Current	18-7909	15400-PLM-A01PE 15400-POH-305PE 15400-ZJ1-004	6.5L / 6.9Qt.	10W-30 FC-W
BF200	2002 - Current	18-7909	15400-PLM-A01PE 15400-POH-305PE 15400-ZJ1-004	7.6L / 8.0 Qt.	10W-30 FC-W
BF225	2002 - Current	18-7909	15400-PLM-A01PE 15400-POH-305PE 15400-ZJ1-004	7.6L / 8.0 Qt.	10W-30 FC-W

All listed oil capacities are approximate amounts only and may or may not include the oil filter capacity.
ALWAYS follow proper crankcase drain and fill procedures. Check engine dipstick for proper crankcase oil level.

OIL FILTER QUICK-REFERENCE GUIDE



Hydro-Marine

Model	Year	Oil Filter	Replaces	Crankcase Capacity	Recommended Oil
All Models (Knecht FO335/1)		18-7875		See Owners Manual	See Owners Manual

Indmar

Model	Year	Oil Filter	Replaces	Crankcase Capacity	Recommended Oil
200, 225, 250 275 (SP), 300 (SP), 350-2, 350-4, 350(SP), 454-2, 454-4, 400 (SP)	1993 & OLDER	18-7875			
		18-7824 (Short) 18-7876 (Long)		See Owners Manual	See Owners Manual
454 Carb	2003 - 2006	18-7824	501001	6.62L / 7.0 Qt.	15W-40 API SL/SJ/C14/ C14Plus
5.7 HO	2007 - 2009	18-7824	501001	See Owners Manual	15W-40 API SL/SJ/C14/ C14Plus
5.7 Vortec	2007 - 2012	18-7824	501001	5.25L / 5.5 Qt.	15W-40 API SL/SJ/C14/ C14Plus
5.7L MPFI	2007 - 2012	18-7824	501001	5.25L / 5.5 Qt.	15W-40 API SL/SJ/C14/ C14Plus
502 Carb	2003 - 2006	18-7824	501001	6.62L / 7.0 Qt.	15W-40 API SL/SJ/C14/ C14Plus
6.0 PFI	2003 - 2006	18-7824	501001	See Owners Manual	15W-40 API SL/SJ/C14/ C14Plus
8.1L Vortec (Remote Oil Filter)	2007 - 2009	18-7824	501001	9.5L / 10 Qt.	15W-40 API SL/SJ/C14/ C14Plus
Assault 310, 325, 340, 385	2003 - 2007	18-7824	501001	See Owners Manual	15W-40 API SL/SJ/C14/ C14Plus
Malibu 350 Vortec Carbureted	2003 - 2005	18-7824	501001	5.25L / 5.5 Qt.	15W-40 API SL/SJ/C14/ C14Plus
Malibu Anniversary Edition LS6	2007	18-7824	501001	5.25L / 5.5 Qt.	15W-40 API SL/SJ/C14/ C14Plus
Malibu Hammerhead	2003 - 2007	18-7824	501001	5.25L / 5.5 Qt.	15W-40 API SL/SJ/C14/ C14Plus
Malibu LC2	2003 - 2006	18-7824	501001	See Owners Manual	15W-40 API SL/SJ/C14/ C14Plus
Malibu LS1	2003 - 2006	18-7824	501001	5.25L / 5.5 Qt.	15W-40 API SL/SJ/C14/ C14Plus
Malibu Monsoon	2003 - 2007	18-7824	501001	See Owners Manual	15W-40 API SL/SJ/C14/ C14Plus
MasterCraft 5.7L LCR	2007 - 2009	18-7824	501001	See Owners Manual	15W-40 API SL/SJ/C14/ C14Plus
MasterCraft 6.0L (LY5, LY6)	2007 - 2009	18-7824	501001	5.25L / 5.5 Qt.	15W-40 API SL/SJ/C14/ C14Plus
MasterCraft LQ9	2003 - 2006	18-7824	501001	5.25L / 5.5 Qt.	15W-40 API SL/SJ/C14/ C14Plus
MasterCraft MCX C14Plus	2003 - 2007	18-7824	501001	See Owners Manual	15W-40 API SL/SJ/C14/ C14Plus
MasterCraft RTP-1	2003 - 2007	18-7824	501001	6.62L / 7.0 Qt.	15W-40 API SL/SJ/C14/ C14Plus

Interceptor

Model	Year	Oil Filter	Replaces	Crankcase Capacity	Recommended Oil
IV4-80, OV4-80, OV6-100 (Taurus), 80, 85, 100, 110, 120, 140, 190, 200, 210, Interceptor 160, Interceptor 165	1960 & UP	18-7878-1		See Owners Manual	See Owners Manual

All listed oil capacities are approximate amounts only and may or may not include the oil filter capacity.
ALWAYS follow proper crankcase drain and fill procedures. Check engine dipstick for proper crankcase oil level.

Kohler

Model	Cylinders	Year	Oil Filter	Replaces	Crankcase Capacity	Recommended Oil
4CZ	2	ALL	23-7823	267714	1.4L / 1.48 Qt.	10W-40
4EF	2	ALL	23-7821	359771	1.36L / 1.44 Qt.	
4ESZ	2	ALL	23-7823	267714	Refer to Owners Manual	10W-40
5E	2	ALL	23-7821	359771	1.36L / 1.44 Qt.	
6.5CZ	2	ALL	23-7823	267714	1.4L / 1.48 Qt.	10W-40
6.5ESZ	2	ALL	23-7823	267714	Refer to Owners Manual	10W-40
7.3E	2	ALL	23-7821	359771	1.36L / 1.44 Qt.	10W-40
10EOZ	3	ALL	23-7824	GM47465 252834	5.2L / 5.5 Qt.	15W-40 API CI-4, CI-4 Plus
10EOZD	3	ALL	23-7824 (Variation 1)	GM47465 252834	3.6L / 3.8 Qt.	15W-40 API CI-4, CI-4 Plus
13.5CCOZ	3	ALL	23-7824	GM47465 252834	5.8L / 6.1 Qt.	15W-40 API CI-4, CI-4 Plus
13EOZ	3	ALL	23-7824	GM47465 252834	4.7L / 5.0 Qt.	15W-40 API CI-4, CI-4 Plus
13EOZD	3	ALL	23-7824	GM47465 252834	4.7L / 5.0 Qt.	15W-40 API CI-4, CI-4 Plus
14CCOZ	3	ALL	23-7824	GM47465 252834	Refer to Owners Manual	15W-40 API CI-4, CI-4 Plus
14EOZ	3	ALL	23-7824	GM47465 252834	4.7L / 5.0 Qt.	15W-40 API CI-4, CI-4 Plus
14EOZD	3	ALL	23-7824	GM47465 252834	4.7L / 5.0 Qt.	15W-40 API CI-4, CI-4 Plus
15.5EOZ	3	ALL	23-7824	GM47465 252834	4.7L / 5.0 Qt.	15W-40 API CI-4, CI-4 Plus
15.5EOZD	3	ALL	23-7824	GM47465 252834	4.7L / 5.0 Qt.	15W-40 API CI-4, CI-4 Plus
5CCOZ	3	ALL	23-7822	229678	Refer to Owners Manual	Refer to Owners Manual
5EOZ	3	ALL	23-7822	229678	3.0L / 3.2 Qt.	15W-40 API CI-4, CI-4 Plus
8EOZ	3	ALL	23-7822	229678	2.3L / 2.4 Qt.	15W-40 API CI-4, CI-4 Plus
9CCOZ	3	ALL	23-7824	GM47465 252835	Refer to Owners Manual	Refer to Owners Manual
9EOZ	3	ALL	23-7824	GM47465 252835	Refer to Owners Manual	15W-40 API CI-4, CI-4 Plus
9EOZD	3	ALL	23-7824 (Variation 1)	GM47465 252835	3.6L / 3.8 Qt.	15W-40 API CI-4, CI-4 Plus
10E	4	ALL	23-7803		3.25L / 3.50 Qt.	10W-40
12.5E	4	ALL	23-7803	326817	3.25L / 3.50 Qt.	10W-40
15C	4	ALL	23-7820	279449	4.7L / 5.0 Qt.	10W-40
16CF	4	ALL	23-7820	279449	Refer to Owners Manual	Refer to Owners Manual
18.5CCOZ	4	ALL	23-7824	GM47465 252834	5.8L / 6.1 Qt.	Refer to Owners Manual
20C	4	ALL	23-7820	279449	4.7L / 5.0 Qt.	10W-40
20EOZ	4	ALL	23-7824	GM47465 252834	5.8L / 6.1 Qt.	15W-40 API CI-4, CI-4 Plus
20EOZD	4	ALL	23-7824	GM47465 252834	5.8L / 6.1 Qt.	15W-40 API CI-4, CI-4 Plus
23EOZ	4	ALL	23-7824	GM47465 252834	5.8L / 6.1 Qt.	15W-40 API CI-4, CI-4 Plus
23EOZD	4	ALL	23-7824	GM47465 252834	5.8L / 6.1 Qt.	15W-40 API CI-4, CI-4 Plus
24CCOZ	4	ALL	23-7824	GM47465 252834	5.8L / 6.1 Qt.	Refer to Owners Manual

All listed oil capacities are approximate amounts only and may or may not include the oil filter capacity.
ALWAYS follow proper crankcase drain and fill procedures. Check engine dipstick for proper crankcase oil level.

OIL FILTER QUICK-REFERENCE GUIDE



Kohler Continued

Model	Cylinders	Year	Oil Filter	Replaces	Crankcase Capacity	Recommended Oil
24EOZ	4	ALL	23-7824	GM47465 252834	5.8L / 6.1 Qt.	15W-40 API CI-4, CI-4 Plus
24EOZD	4	ALL	23-7824	GM47465 252834	5.8L / 6.1 Qt.	15W-40 API CI-4, CI-4 Plus
28EOZ	4	ALL	23-7824	GM47465 252834	10.2L / 10.78 Qt.	15W-40 API CI-4, CI-4 Plus
28EOZD	4	ALL	23-7824	GM47465 252834	10.2L / 10.78 Qt.	15W-40 API CI-4, CI-4 Plus
32EOZ	4	ALL	23-7824	GM47465 252834	10.2L / 10.78 Qt.	15W-40 API CI-4, CI-4 Plus
32EOZD	4	ALL	23-7824	GM47465 252835	10.2L / 10.78 Qt.	15W-40 API CI-4, CI-4 Plus
8E	4	ALL	23-7803	326817	3.25L / 3.50 Qt.	10W-40

Lehman

Model	Oil Filter	Replaces	Crankcase Capacity	Recommended Oil
Models (w/Ford 242), (w/Ford 254), (w/Ford 363), (w/Ford 380), (Lehman 2N50)	18-7875		See Owners Manual	See Owners Manual

Mercury

Model	Cylinders	CID / Litre	Year	Oil Filter	Replaces	Crankcase Capacity	Recommended Oil
ALL CYLINDER BLOCKS MANUFACTURED BY GENERAL MOTORS (GM) UNLESS NOTED IN MODEL COLUMN							
Vazer	4	1.6L	2007 - 2010	18-7824	35-866340K01	4.02L / 4.25 Qt.	25W-40 FC-W
Vazer	4	1.6L	2011 - Current	18-7824	35-866340K01	4.02L / 4.25 Qt.	20W-40 Synthetic Catalyst (1)
60 (Renault)	4	68 / 1.1L	1965 - 1968	-----	38463	2.6L / 2.75 Qt.	See Owners Manual
80 (Renault)	4	80 / 1.3L	1966 - 1969	-----	-----	4.7L / 5.0 Qt.	See Owners Manual
90 (Renault)	4	96 / 1.6L	1970 - 1972	-----	-----	4.7L / 5.0 Qt.	See Owners Manual
110	4	153 / 2.5L	1963 - 1966	18-7824	35-866340K01	3.8L / 4.0 Qt.	See Owners Manual
120	4	153 / 2.5L	1964 - 1986	18-7824	35-866340K01	3.8L / 4.0 Qt.	25W-40 FC-W
140	4	181 / 3.0L	1968 - 1986	18-7824	35-866340K01	3.8L / 4.0 Qt.	25W-40 FC-W
165	4	224 / 3.7L	1987	18-7824	35-866340K01	5.2L / 5.5 Qt.	25W-40 FC-W
170	4	224 / 3.7L	1985 - 1986	18-7824	35-866340K01	5.2L / 5.5 Qt.	25W-40 FC-W
180	4	224 / 3.7L	1987	18-7824	35-866340K01	6.1L / 6.5 Qt.	25W-40 FC-W
190	4	224 / 3.7L	1985 - 1986	18-7824	35-866340K01	6.1L / 6.5 Qt.	25W-40 FC-W
2.5L	4	153 / 2.5L	1987 - 1989	18-7824	35-866340K01	3.8L / 4.0 Qt.	25W-40 FC-W
3.0L / LX	4	181 / 3.0L	1987 - 2010	18-7824	35-866340K01	3.8L / 4.0 Qt.	25W-40 FC-W
3.0L MPI EC (Catalyzed)	4	182 / 3.0L	2011 - Current	18-7824	35-866340K01	3.8L / 4.0 Qt.	20W-40 Synthetic Catalyst (1)
3.7L	4	224 / 3.7L	1988 - 1989	18-7824	35-866340K01	5.2L / 5.5 Qt.	25W-40 FC-W
3.7LX	4	224 / 3.7L	1983 - 1989	18-7824	35-866340K01	6.1L / 6.5 Qt.	25W-40 FC-W
470	4	224 / 3.7L	1976 - 1984	18-7824	35-866340K01	5.2L / 5.5 Qt.	25W-40 FC-W
485	4	224 / 3.7L	1980 - 1982	18-7824	35-866340K01	5.4L / 5.75 Qt.	25W-40 FC-W
488	4	224 / 3.7L	1983 - 1984	18-7824	35-866340K01	6.1L / 6.5 Qt.	25W-40 FC-W
140	6 IL	194 / 3.2L	1963	18-7876	35-99894	4.7L / 5.0 Qt.	25W-40 FC-W
150	6 IL	230 / 3.8L	1964 - 1966	18-7876	35-99894	4.7L / 5.0 Qt.	25W-40 FC-W
160	6 IL	250 / 4.1L	1967 - 1969	18-7876	35-99894	4.7L / 5.0 Qt.	25W-40 FC-W
165	6 IL	250 / 4.1L	1970 - 1981	18-7876	35-99894	4.7L / 5.0 Qt.	25W-40 FC-W
175	V6	262 / 4.3L	1987	18-7879*	35-883702	4.3L / 4.5 Qt.	25W-40 FC-W
185	V6	262 / 4.3L	1985 - 1987	18-7879*	35-883702	4.3L / 4.5 Qt.	25W-40 FC-W
200	6 IL	292 / 4.8L	1969	18-7876	35-99894	5.7L / 6.0 Qt.	25W-40 FC-W
205	V6	262 / 4.3L	1985 - 1987	18-7879*	35-883702	4.3L / 4.5 Qt.	25W-40 FC-W
262 Mag EFI	V6	263 / 4.3L	1996 - 1997	18-7879*	35-883702	4.3L / 4.5 Qt.	25W-40 FC-W

Continued Next Page

All listed oil capacities are approximate amounts only and may or may not include the oil filter capacity.
ALWAYS follow proper crankcase drain and fill procedures. Check engine dipstick for proper crankcase oil level.



OIL FILTER QUICK-REFERENCE GUIDE

MerCruiser - Continued

Model	Cylinders	CID / Litre	Year	Oil Filter	Replaces	Crankcase Capacity	Recommended Oil
4.3L / LX / LH / LXH	V6	264 / 4.3L	1988 - 2001	18-7879*	35-883702	4.3L / 4.5 Qt.	25W-40 FC-W
4.3L	V6	265 / 4.3L	2002 - 2010	18-7879*	35-883702	4.3L / 4.5 Qt.	25W-40 FC-W
4.3L EFI	V6	266 / 4.3L	1998 - 2001	18-7879*	35-883702	4.3L / 4.5 Qt.	25W-40 FC-W
4.3L MPI	V6	267 / 4.3L	2002 - 2010	18-7879*	35-883702	3.8L / 4.0 Qt.	25W-40 FC-W
4.3L MPI (Catalyzed)	V6	268 / 4.3L	2011 - Current	18-7824	35-866340K01	3.8L / 4.0 Qt.	20W-40 Synthetic Catalyst (1)

*NOTE: V6 engines equipped with the oil filter relocation option will use filter 18-7824.

190	V8	283 / 4.6L	1963 - 1964	18-7824	35-866340K01	4.7L / 5.0 Qt.	25W-40 FC-W
198	V8	305 / 5.0L	1977 - 1988	18-7876	35-99894	5.7L / 6.0 Qt.	25W-40 FC-W
200	V8	305 / 5.0L	1985 - 1987	18-7824	35-866340K01	4.7L / 5.0 Qt.	25W-40 FC-W
215 (Ford)	V8	302 / 5.0L	1970 - 1972	18-7875	35-802886	6.6L / 7.0 Qt.	25W-40 FC-W
225 (Ford)	V8	302 / 5.0L	1973 - 1974	18-7875	35-802886	5.7L / 6.0 Qt.	25W-40 FC-W
225	V8	327 / 5.4L	1963 - 1966	18-7824	35-866340K01	4.7L / 5.0 Qt.	25W-40 FC-W
225	V8	327 / 5.4L	1967 - 1969	18-7824	35-866340K01	6.6L / 7.0 Qt.	25W-40 FC-W
228	V8	305 / 5.0L	1977 - 1978	18-7824	35-866340K01	4.7L / 5.0 Qt.	25W-40 FC-W
230	V8	305 / 5.0L	1985 - 1987	18-7824	35-866340K01	5.2L / 5.5 Qt.	25W-40 FC-W
233 (Ford)	V8	351 / 5.8L	1975 - 1977	18-7875	35-802886	4.7L / 5.0 Qt.	25W-40 FC-W
233 (Ford) Inboard	V8	351 / 5.8L	1973 - 1976	18-7875	35-802886	6.6L / 7.0 Qt.	25W-40 FC-W
250	V8	327 / 5.4L	1969	18-7876	35-99894	6.6L / 7.0 Qt.	25W-40 FC-W
250	V8	327 / 5.4L	1968	18-7876	35-99894	5.7L / 6 Qt.	25W-40 FC-W
250	V8	350 / 5.7L	1975 - 1977	18-7876	35-99894	4.7L / 5.0 Qt.	25W-40 FC-W
255	V8	350 / 5.7L	1975 - 1977	18-7876	35-99894	4.7L / 5.0 Qt.	25W-40 FC-W
255 (Ford)	V8	351 / 5.8L	1973 - 1974	18-7875	35-802886	4.7L / 5.0 Qt.	25W-40 FC-W
255 (Ford) Inboard	V8	351 / 5.8L	1973 - 1976	18-7875	35-802886	6.6L / 7.0 Qt.	25W-40 FC-W
260	V8	350 / 5.7L	1975 - 1987	18-7824	35-866340K01	5.2L / 5.5 Qt.	25W-40 FC-W
270	V8	350 / 5.7L	1969 - 1972	18-7876	35-99894	6.6L / 7.0 Qt.	25W-40 FC-W
280 TRS	V8	350 / 5.7L	1975 - 1976	18-7876	35-99894	6.0L / 6.5 Qt.	25W-40 FC-W
300 Tempest	V8	350 / 5.7L	1985 - 1986	18-7876	35-99894	6.0L / 6.5 Qt.	25W-40 FC-W
320 EFI	V8	350 / 5.7L	1987 - 1989	18-7824	35-866340K01	6.0L / 6.5 Qt.	25W-40 FC-W
325	V8	427 / 7.0L	1969 - 1972	18-7876	35-99894	7.6L / 8.0 Qt.	25W-40 FC-W
325 Inboard	V8	427 / 7.0L	1968 - 1974	18-7824	35-866340K01	6.6L / 7.0 Qt.	25W-40 FC-W
330	V8	454 / 7.4L	1977 - 1981	18-7876	35-99894	5.7L / 6.0 Qt.	25W-40 FC-W
330	V8	454 / 7.4L	1982 - 1987	18-7824	35-866340K01	6.6L / 7.0 Qt.	25W-40 FC-W
350 Mag.	V8	350 / 5.7L	1986 - 1997	18-7824	35-866340K01	5.2L / 5.5 Qt.	25W-40 FC-W
350 Mag. EFI	V8	350 / 5.7L	1996 - 1997	18-7824	35-866340K01	5.2L / 5.5 Qt.	25W-40 FC-W
350 Mag. MPI	V8	350 / 5.7L	1996 - 2001	18-7824	35-866340K01	5.2L / 5.5 Qt.	25W-40 FC-W
350 Mag. MPI	V8	350 / 5.7L	2002 - 2010	18-7824	35-866340K01	4.25L / 4.5 Qt.	25W-40 FC-W
350 Mag. MPI (Catalyzed)	V8	350 / 5.7L	2011 - Current	18-7824	35-866340K01	4.25L / 4.5 Qt.	20W-40 Synthetic Catalyst (1)
370 TRS	V8	454 / 7.4L	1978 - 1987	18-7824	35-866340K01	5.7L / 6.0 Qt.	25W-40 FC-W
377 Scorpion	V8	377 / 6.2L	1997 - 2010	18-7824	35-866340K01	4.7L / 5.0 Qt.	25W-40 FC-W
390	V8	482 / 7.9L	1969 - 1970	18-7876	35-99894	7.6L / 8.0 Qt.	25W-40 FC-W
390 Inboard	V8	482 / 7.9L	1969 - 1970	18-7876	35-99894	6.6L / 7.0 Qt.	25W-40 FC-W
400 TRS	V8	454 / 7.4L	1978 - 1987	18-7824	35-866340K01	6.6L / 7.0 Qt.	25W-40 FC-W
420	V8	454 / 7.4L	1987 - 1989	18-7824	35-866340K01	5.7L / 6.0 Qt.	25W-40 FC-W
425	V8	454 / 7.4L	1990 - 1993	18-7824	35-866340K01	7.6L / 8.0 Qt.	25W-40 FC-W
440 TRS Cyclone	V8	454 / 7.4L	1983 - 1986	18-7876	35-99894	6.6L / 7.0 Qt.	25W-40 FC-W
450	V8	454 / 7.4L	1995 - 1996	18-7876	35-99894	7.6L / 8.0 Qt.	25W-40 FC-W
454 Mag. Alpha	V8	454 / 7.4L	1986 - 1988	18-7824	35-866340K01	6.6L / 7.0 Qt.	25W-40 FC-W
454 Mag.	V8	454 / 7.4L	1989 - 1991	18-7824	35-866340K01	7.6L / 8.0 Qt.	25W-40 FC-W
454 Mag.	V8	454 / 7.4L	1992 - 1997	18-7824	35-866340K01	6.6L / 7.0 Qt.	25W-40 FC-W
454 Mag. EFI	V8	454 / 7.4L	1994 - 1996	18-7824	35-866340K01	6.6L / 7.0 Qt.	25W-40 FC-W
454 Mag. MPI	V8	454 / 7.4L	1996 - 2001	18-7824	35-866340K01	6.6L / 7.0 Qt.	25W-40 FC-W
460 TRS	V8	482 / 7.9L	1983 - 1986	18-7876	35-99894	9.4L / 10 Qt.	25W-40 FC-W
465	V8	502 / 8.2L	1990 - 1994	18-7824	35-866340K01	7.6L / 8.0 Qt.	25W-40 FC-W
496 Mag.	V8	496 / 8.1L	2001 - 2010	18-7824	35-866340K01	8.5L / 9.0 Qt.	25W-40 FC-W

All listed oil capacities are approximate amounts only and may or may not include the oil filter capacity.
 ALWAYS follow proper crankcase drain and fill procedures. Check engine dipstick for proper crankcase oil level.

OIL FILTER QUICK-REFERENCE GUIDE



MerCruiser - Continued

Model	Cylinders	CID / Litre	Year	Oil Filter	Replaces	Crankcase Capacity	Recommended Oil
496 Mag. HO	V8	496 / 8.1L	2001 - 2010	18-7824	35-866340K01	8.5L / 9.0 Qt.	25W-40 FC-W
496 Mag. (Catalyzed)	V8	496 / 8.1L	2011 - Current	18-7824	35-866340K01	8.5L / 9.0 Qt.	20W-40 Synthetic Catalyst (1)
496 Mag. HO (Catalyzed)	V8	496 / 8.1L	2011 - Current	18-7824	35-866340K01	8.5L / 9.0 Qt.	20W-40 Synthetic Catalyst (1)
5.0L	V8	305 / 5.0L	1988 - 1995	18-7824	35-866340K01	4.7L / 5.0 Qt.	25W-40 FC-W
5.0L	V8	305 / 5.0L	1998 - 2002	18-7824	35-866340K01	5.2L / 5.5 Qt.	25W-40 FC-W
5.0L	V8	305 / 5.0L	2003 - 2010	18-7824	35-866340K01	4.25L / 4.5 Qt.	25W-40 FC-W
5.0LX	V8	305 / 5.0L	1988 - 1995	18-7824	35-866340K01	5.2L / 5.5 Qt.	25W-40 FC-W
5.0 EFI	V8	305 / 5.0L	1998 - 2001	18-7824	35-866340K01	5.2L / 5.5 Qt.	25W-40 FC-W
5.0 MPI	V8	305 / 5.0L	2002 - 2010	18-7824	35-866340K01	4.25L / 4.5 Qt.	25W-40 FC-W
5.0 MPI (Catalyzed)	V8	305 / 5.0L	2011 - Current	18-7824	35-866340K01	4.25L / 4.5 Qt.	20W-40 Synthetic Catalyst (1)
5.7L	V8	350 / 5.7L	1978 - 2002	18-7824	35-866340K01	5.2L / 5.5 Qt.	25W-40 FC-W
5.7L	V8	350 / 5.7L	2003 - 2010	18-7824	35-866340K01	4.25L / 4.5 Qt.	25W-40 FC-W
5.7LX	V8	350 / 5.7L	1996 - 1997	18-7824	35-866340K01	5.2L / 5.5 Qt.	25W-40 FC-W
5.7 EFI	V8	350 / 5.7L	1995 - 2001	18-7824	35-866340K01	5.2L / 5.5 Qt.	25W-40 FC-W
500	V8	502 / 8.2L	1994 - 1999	18-7824	35-866340K01	7.6L / 8.0 Qt.	25W-40 FC-W
500 EFI	V8	502 / 8.2L	1999 - 2005	18-7824	35-866340K01	6.6L / 7.0 Qt.	25W-40 FC-W
502 Mag.	V8	502 / 8.2L	1990 - 1993	18-7824	35-866340K01	7.6L / 8.0 Qt.	25W-40 FC-W
502 Mag. EFI	V8	502 / 8.2L	1993 - 1995	18-7824	35-866340K01	6.6L / 7.0 Qt.	25W-40 FC-W
502 Mag. MPI	V8	502 / 8.2L	1996 - 2001	18-7824	35-866340K01	6.6L / 7.0 Qt.	25W-40 FC-W
6.2 MPI (up to 0M299999)	V8	377 / 6.2L	2000 - 2002	18-7824	35-866340K01	5.2L / 5.5 Qt.	25W-40 FC-W
6.2MPI (0M300000 and up)	V8	377 / 6.2L	2002 - 2010	18-7824	35-866340K01	4.25L / 4.5 Qt.	25W-40 FC-W
6.2 Black Scorpion (up to 0M391599)	V8	377 / 6.2L	2001 - 2003	18-7824	35-866340K01	5.2L / 5.5 Qt.	25W-40 FC-W
6.2 Black Scorpion (0M391750 and up)	V8	377 / 6.2L	2003 - 2010	18-7824	35-866340K01	4.25L / 4.5 Qt.	25W-40 FC-W
7.4L	V8	454 / 7.4L	1988 - 1991	18-7824	35-866340K01	7.6L / 8.0 Qt.	25W-40 FC-W
7.4L with Borg Warner	V8	454 / 7.4L	1981 - 1992	18-7824	35-866340K01	6.6L / 7.0 Qt.	25W-40 FC-W
7.4L with Hurth	V8	454 / 7.4L	1988 - 1992	18-7824	35-866340K01	7.6L / 8.0 Qt.	25W-40 FC-W
7.4L	V8	454 / 7.4L	1992 - 1997	18-7824	35-866340K01	6.6L / 7.0 Qt.	25W-40 FC-W
7.4LX TBI	V8	454 / 7.4L	1996 - 1997	18-7824	35-866340K01	6.6L / 7.0 Qt.	25W-40 FC-W
7.4LX MPI	V8	454 / 7.4L	1996 - 1997	18-7824	35-866340K01	6.6L / 7.0 Qt.	25W-40 FC-W
7.4L MPI	V8	454 / 7.4L	1998 - 2001	18-7824	35-866340K01	6.6L / 7.0 Qt.	25W-40 FC-W
8.1L	V8	496 / 8.1L	2001 - 2010	18-7824	35-866340K01	8.5L / 9.0 Qt.	25W-40 FC-W
8.1L (Catalyzed)	V8	496 / 8.1L	2011 - Current	18-7824	35-866340K01	8.5L / 9.0 Qt.	20W-40 Synthetic Catalyst (1)
8.1L HO	V8	496 / 8.1L	2001 - 2010	18-7824	35-866340K01	8.5L / 9.0 Qt.	25W-40 FC-W
8.1L HO (Catalyzed)	V8	496 / 8.1L	2011 - Current	18-7824	35-866340K01	8.5L / 9.0 Qt.	20W-40 Synthetic Catalyst (1)
8.2L	V8	502 / 8.2L	1992 - 1996	18-7824	35-866340K01	7.6L / 8.0 Qt.	25W-40 FC-W
8.2L MPI	V8	502 / 8.2L	1996 - 2001	18-7824	35-866340K01	6.6L / 7.0 Qt.	25W-40 FC-W
888 (Ford)	V8	302 / 5.0L	1971 - 1977	18-7875	35-802886	5.7L / 6.0 Qt.	25W-40 FC-W
898	V8	305 / 5.0L	1977 - 1984	18-7876	35-99894	4.7L / 5.0 Qt.	25W-40 FC-W

Mercury Outboard

Model	Year	Oil Filter	Replaces	Crankcase Capacity	Recommended Oil
2.5HP / 3.5HP	2006 - 2011	-----		0.30 L / 0.31 Qt.	10W-30 FC-W
4HP / 5HP / 6 HP	1999 - 2011	-----		0.45L / 0.48 Qt.	10W-30 FC-W
8HP (232cc)	1995-2000	18-7901	825467T1, A1	1.0L / 1.05 Qt.	10W-30 FC-W
8HP (323cc)	2001-2004	18-7913	35-822626Q1, Q3, K03	1.0L / 1.05 Qt.	10W-30 FC-W
8HP (209cc)	2005-2011	-----	35-895152, 35-895152002	0.80L / 0.85 Qt.	10W-30 FC-W
9.9HP (232cc)	1995-1998	18-7901	825467T1, A1	1.0L / 1.05 Qt.	10W-30 FC-W
9.9HP (323cc)	1999-2004	18-7913	35-822626Q1, Q3, K03	1.0L / 1.05 Qt.	10W-30 FC-W
9.9HP (209cc)	2005-2011	-----	35-895152, 35-895152002	0.80L / 0.85 Qt.	10W-30 FC-W
15HP (323cc)	1998-2008	18-7913	35-822626Q1, Q3, K03	1.0L / 1.05 Qt.	10W-30 FC-W

Continued Next Page

All listed oil capacities are approximate amounts only and may or may not include the oil filter capacity.
ALWAYS follow proper crankcase drain and fill procedures. Check engine dipstick for proper crankcase oil level.



OIL FILTER QUICK-REFERENCE GUIDE

Mercury Outboard - Continued

Model	Year	Oil Filter	Replaces	Crankcase Capacity	Recommended Oil
15HP (351cc)	2008-2011	18-7913	35-822626Q1, Q3, K03	1.0L / 1.05 Qt.	10W-30 FC-W
20HP (351cc)	2008-2011	18-7913	35-822626Q1, Q3, K03	1.0L / 1.05 Qt.	10W-30 FC-W
25HP (OT800999 and lower)	1998-2006	18-7914	35-822626Q2, Q04, K04	3.0L / 3.17 Qt.	10W-30 FC-W
25HP (OT801000 and up)	2006-2011	18-7913	35-822626Q1, Q3, K03	1.8L / 1.90 Qt.	10W-30 FC-W
30HP (OT800999 and lower)	1999-2006	18-7914	35-822626Q2, Q04, K04	3.0L / 3.17 Qt.	10W-30 FC-W
30HP (OT801000 and up)	2006-2011	18-7913	35-822626Q1, Q3, K03	1.8L / 1.90 Qt.	10W-30 FC-W
40HP (3 cyl)	1999-2011	18-7914	35-822626Q2, Q04, K04	3.0L / 3.17 Qt.	10W-30 FC-W
40HP (4 cyl)	2001-2011	18-7914	35-822626Q2, Q04, K04	3.0L / 3.17 Qt.	10W-30 FC-W
50HP (996cc)	2001-2011	18-7914	35-822626Q2, Q04, K04	3.0L / 3.17 Qt.	10W-30 FC-W
50HP (935cc)	1995-2000	18-7914	35-822626Q2, Q04, K04	3.0L / 3.17 Qt.	10W-30 FC-W
60HP	2001-2011	18-7914	35-822626Q2, Q04, K04	3.0L / 3.17 Qt.	10W-30 FC-W
75HP Carbureted	2000-2005	18-7914	35-822626Q2, Q04, K04	5.0L / 5.28 Qt.	10W-30 FC-W
75HP EFI (1B366822 & Below)	1999-2006	18-7914	35-822626Q2, Q04, K04	4.5L / 4.80 Qt.	10W-30 FC-W
75HP EFI (1B366822 & Above)	2006-2011	18-7758	35-877761K01	5.0L / 5.28 Qt.	10W-30 FC-W
80HP	2006-UP	18-7914	35-822626Q2, Q04, K04	4.5L / 4.80 Qt.	10W-30 FC-W
90HP Carbureted	2000-2005	18-7914	35-822626Q2, Q04, K04	5.0L / 5.28 Qt.	10W-30 FC-W
90HP EFI (1B366822 & Below)	1999-2006	18-7914	35-822626Q2, Q04, K04	4.5L / 4.80 Qt.	10W-30 FC-W
90HP EFI (1B366822 & Above)	2006-2011	18-7758	35-877761K01	5.0L / 5.28 Qt.	10W-30 FC-W
115HP EFI (1B366822 & Below)	2001-2006	18-7914	35-822626Q2, Q04, K04	5.0L / 5.28 Qt.	10W-30 FC-W
115HP EFI (1B366822 & Above)	2006-2011	18-7758	35-877761K01	5.0L / 5.28 Qt.	10W-30 FC-W
135 Verado L4	2006-2011	18-7921	35-877767K01	6.0L / 6.34 Qt.	25W-40 Synthetic Blend FC-W
150 Verado L4	2006-2011	18-7921	35-877767K01	6.0L / 6.34 Qt.	25W-40 Synthetic Blend FC-W
175 Verado L4	2006-2011	18-7921	35-877767K01	6.0L / 6.34 Qt.	25W-40 Synthetic Blend FC-W
200 Verado L4	2007-2011	18-7921	35-877767K01	6.0L / 6.34 Qt.	25W-40 Synthetic Blend FC-W
200 Verado L6	2005-2011	18-7918	35-877769K01	7.0L / 7.40 Qt.	25W-50 Synthetic Blend FC-W
225HP EFI	2003-2006	18-7906-1	35-822626T7, Q15	6.0L / 6.34 Qt.	10W-30 FC-W
225 Verado L6	2005-2011	18-7918	35-877769K01	7.0L / 7.40 Qt.	25W-50 Synthetic Blend FC-W
250 Verado L6	2005-2011	18-7918	35-877769K01	7.0L / 7.40 Qt.	25W-50 Synthetic Blend FC-W
275 Verado L6	2005-2011	18-7918	35-877769K01	7.0L / 7.40 Qt.	25W-50 Synthetic Blend FC-W
300 Verado L6	2007-2011	18-7918	35-877769K01	7.0L / 7.40 Qt.	25W-50 Synthetic Blend FC-W

Mohawk

Model	Year	Oil Filter	Replaces	Crankcase Capacity	Recommended Oil
V8-302, V8-351		18-7875		See Owners Manual	See Owners Manual

Nissan Tohatsu

Model	Year	Oil Filter	Replaces	Crankcase Capacity	Recommended Oil
F2	2006	----	----	300 ml. / 10 oz.	10W-40 FC-W
F2.5	2006 - Current	----	----	300 ml. / 10 oz.	10W-40 FC-W
F3.5	2006 - Current	----	----	300 ml. / 10 oz.	10W-40 FC-W
F4	1999 - Current	----	3H6-07413-0	450 ml. / 16 oz.	10W-40 FC-W
F5	1998 - Current	----	3H6-07413-0	450 ml. / 16 oz.	10W-40 FC-W
F6	2002 - Current	----	3H6-07413-0	450 ml. / 16 oz.	10W-40 FC-W
F8	2003 - Current	----	3V1-07410-1	800 ml. / 27 oz.	10W-40 FC-W
F9.8	2003 - Current	----	3V1-07410-1	800 ml. / 27 oz.	10W-40 FC-W
F9.9	2000 - 2008	18-7911-1	3R007-6150M 3RO-07615-0	1.0L / 1.06 Qt.	10W-40 FC-W
F15	2000 - Current	18-7911-1	3R007-6150M 3RO-07615-0	1.0L / 1.06 Qt.	10W-40 FC-W
F18	2001 - 2006	18-7911-1	3R007-6150M 3RO-07615-0	1.0L / 1.06 Qt.	10W-40 FC-W
F20	2008 - Current	18-7911-1	3R007-6150M 3RO-07615-0	1.0L / 1.06 Qt.	10W-40 FC-W
F25	2002 - Current	18-7911-1	3R007-6150M 3RO-07615-0	1.8L / 1.9 Qt.	10W-40 FC-W
F30	2002 - Current	18-7911-1	3R007-6150M 3RO-07615-0	1.8L / 1.9 Qt.	10W-40 FC-W

All listed oil capacities are approximate amounts only and may or may not include the oil filter capacity.
ALWAYS follow proper crankcase drain and fill procedures. Check engine dipstick for proper crankcase oil level.

OIL FILTER QUICK-REFERENCE GUIDE



Northern Lights

Model	Year	Oil Filter	Replaces	Crankcase Capacity	Recommended Oil
M753		23-7801	140516190	3.5L / 3.7 Qt.	15W-40 API CF or Higher
M753G		23-7801	140516190	3.5L / 3.7 Qt.	15W-40 API CF or Higher
M753K		23-7801	140516190	3.5L / 3.7 Qt.	15W-40 API CF or Higher
M753W		23-7801	140516190	3.5L / 3.7 Qt.	15W-40 API CF or Higher
M753w2		23-7801	140516190	3.5L / 3.7 Qt.	15W-40 API CF or Higher
M773L		23-7801	140516190	4.0L / 4.2 Qt.	15W-40 API CF or Higher
M773LW2		23-7801	140516190	4.9L / 4.75 Qt.	15W-40 API CF or Higher
M773LW3: 9/7Kw		23-7801	140516190	4.9L / 4.75 Qt.	15W-40 API CF or Higher
M843		23-7801	140516190	5.5L / 5.8 Qt.	15W-40 API CF or Higher
M843N		23-7801	140516190	5.5L / 5.8 Qt.	15W-40 API CF or Higher
M843NK		23-7801	140516190	5.5L / 5.8 Qt.	15W-40 API CF or Higher
M843NK2		23-7801	140516190	5.5L / 5.8 Qt.	15W-40 API CF or Higher
M843NW		23-7801	140516190	5.5L / 5.8 Qt.	15W-40 API CF or Higher
M843NW2		23-7801	140516190	5.5L / 5.8 Qt.	15W-40 API CF or Higher
M844		23-7801	140516190	8.2L / 8.66 Qt.	15W-40 API CF or Higher
M844K		23-7801	140516190	8.2L / 8.66 Qt.	15W-40 API CF or Higher
M844L		23-7801	140516190	8.2L / 8.66 Qt.	15W-40 API CF or Higher
M844LK		23-7801	140516190	8.2L / 8.66 Qt.	15W-40 API CF or Higher
M844LW		23-7801	140516190	8.2L / 8.66 Qt.	15W-40 API CF or Higher
M844LW2		23-7801	140516190	8.2L / 8.66 Qt.	15W-40 API CF or Higher
M844W		23-7801	140516190	8.2L / 8.66 Qt.	15W-40 API CF or Higher
M844W2		23-7801	140516190	8.2L / 8.66 Qt.	15W-40 API CF or Higher
M844W3: 16/12KW		23-7801	140516190	8.2L / 8.66 Qt.	15W-40 API CF or Higher
M844LW3: 20/16Kw		23-7801	140516190	8.2L / 8.66 Qt.	15W-40 API CF or Higher
M844NK2		23-7801	140516190	8.2L / 8.66 Qt.	15W-40 API CF or Higher
M844LK2		23-7801	140516190	8.2L / 8.66 Qt.	15W-40 API CF or Higher
M844NW2		23-7801	140516190	8.2L / 8.66 Qt.	15W-40 API CF or Higher
M844NW3		23-7801	140516190	8.2L / 8.66 Qt.	15W-40 API CF or Higher
ML844		23-7801	140516190	8.2L / 8.66 Qt.	15W-40 API CF or Higher
ML844K		23-7801	140516190	8.2L / 8.66 Qt.	15W-40 API CF or Higher
ML844L		23-7801	140516190	8.2L / 8.66 Qt.	15W-40 API CF or Higher
ML844LK		23-7801	140516190	8.2L / 8.66 Qt.	15W-40 API CF or Higher
M864K		23-7801	140516190	7.4L / 7.8 Qt.	15W-40 API CF or Higher
M864W		23-7801	140516190	7.4L / 7.8 Qt.	15W-40 API CF or Higher
M864W3: 25/20Kw		23-7801	140516190	7.4L / 7.8 Qt.	15W-40 API CF or Higher
M16C		23-7801	140516190	Refer to Owners Manual	15W-40 API CF or Higher
M20CL		23-7801	140516190	8.2L / 8.66 Qt.	15W-40 API CF or Higher
M20CR		23-7801	140516190	8.2L / 8.66 Qt.	15W-40 API CF or Higher

OMC

Model	Cylinders	Year	Oil Filter	Replaces	Crankcase Capacity	Recommended Oil
100	4	1972 - 1973	18-7824	502902	3.3L / 3.5 Qt.	25W-40 FC-W
120	4	1965 - 1981	18-7824	502902	3.3L / 3.5 Qt.	25W-40 FC-W
140	4	1973 - 1981	18-7824	502902	3.3L / 3.5 Qt.	25W-40 FC-W
2.3L (Ford)	4	1987 - 1990	18-7875	502900	3.8L / 4.0 Qt.	25W-40 FC-W
2.5L	4	1982 - 1986	18-7824	502902	3.3L / 3.5 Qt.	25W-40 FC-W
3.0L / GL / GS	4	1982 - 1998	18-7824	502902	3.8L / 4.0 Qt.	25W-40 FC-W
165	6	1972 - 1976	18-7876	502901	3.8L / 4.0 Qt.	25W-40 FC-W
3.8L	6	1981 - 1985	18-7879	502903	3.8L / 4.0 Qt.	25W-40 FC-W
4.3L	6	1985 - 1998	18-7879	502903	3.8L / 4.0 Qt.	25W-40 FC-W
4.3 HO (Remote Oil Filter)	6	1989 - 1991	18-7876	502901	4.0L / 4.5 Qt.	25W-40 FC-W
175 (Ford)	8	1975 - 1977	18-7875	502900	4.7L / 5.0 Qt.	25W-40 FC-W
185 (Ford)	8	1978 - 1980	18-7875	502900	3.8L / 4.0 Qt.	25W-40 FC-W
190 (Ford)	8	1974 - 1977	18-7875	502900	4.7L / 5.0 Qt.	25W-40 FC-W

Continued Next Page

All listed oil capacities are approximate amounts only and may or may not include the oil filter capacity.
ALWAYS follow proper crankcase drain and fill procedures. Check engine dipstick for proper crankcase oil level.

OMC - Continued

Model	Cylinders	Year	Oil Filter	Replaces	Crankcase Capacity	Recommended Oil
200	8	1978 - 1981	18-7876	502901	3.8L / 4.0 Qt.	25W-40 FC-W
225	8	1972 - 1978	18-7876	502901	4.7L / 5.0 Qt.	25W-40 FC-W
230	8	1978 - 1981	18-7876	502901	4.7L / 5.0 Qt.	25W-40 FC-W
235	8	1971 - 1977	18-7876	502901	4.7L / 5.0 Qt.	25W-40 FC-W
245	8	1972 - 1975	18-7876	502901	4.7L / 5.0 Qt.	25W-40 FC-W
250 (Ford)	8	1979	18-7875	502900	4.7L / 5.0 Qt.	25W-40 FC-W
260	8	1978 - 1981	18-7876	502901	4.7L / 5.0 Qt.	25W-40 FC-W
262 King Cobra	8	1989	18-7876	502901	3.8L / 4.0 Qt.	25W-40 FC-W
350 King Cobra	8	1986 - 1989	18-7876	502901	4.7L / 5.0 Qt.	25W-40 FC-W
351 EFI	8	1994 - 1995	18-7875	502900	3.8L / 4.0 Qt.	25W-40 FC-W
351 King	8	1992	18-7875	502900	4.7L / 5.0 Qt.	25W-40 FC-W
351 King	8	1993	18-7875	502900	3.8L / 4.0 Qt.	25W-40 FC-W
454 HO	8	1991 - 1993	18-7876	502901	5.7L / 6.0 Qt.	25W-40 FC-W
454 King Cobra	8	1989 - 1990	18-7876	502901	5.7L / 6.0 Qt.	25W-40 FC-W
460 King Cobra	8	1986 - 1989	18-7878-1	502904	5.7L / 6.0 Qt.	25W-40 FC-W
5.0L	8	1986-1996, 1998	18-7876	502901	4.7L / 5.0 Qt.	25W-40 FC-W
5.0L EFI (Ford)	8	1993 - 1996	18-7875	502900	4.7L / 5.0 Qt.	25W-40 FC-W
502 King Cobra (8.2L)	8	1992 - 1993	18-7876	502901	5.7L / 6.0 Qt.	25W-40 FC-W
5.7L	8	1982 - 1985	18-7876	502901	5.7L / 6.0 Qt.	25W-40 FC-W
5.7L / GL / Gi	8	1986 - 1998	18-7876	502901	4.7L / 5.0 Qt.	25W-40 FC-W
5.8L (Ford)	8	1989 - 1991	18-7875	502900	4.7L / 5.0 Qt.	25W-40 FC-W
5.8L (Ford) / FL / EFI	8	1992 - 1995	18-7875	502900	3.8L / 4.0 Qt.	25W-40 FC-W
5.8L HO EFI	8	1995	18-7875	502900	3.8L / 4.0 Qt.	25W-40 FC-W
7.4L / GL	8	1988, 1991-1998	18-7876	502901	5.7L / 6.0 Qt.	25W-40 FC-W
7.4L Gi	8	1996 - 1998	18-7876	502901	7.6L / 8.0 Qt.	25W-40 FC-W
7.5L (Ford)	8	1987 - 1990	18-7878-1	502904	4.7L / 5.0 Qt.	25W-40 FC-W
8.2L	8	1984 - 1985	18-7876	502901	5.7L / 6.0 Qt.	25W-40 FC-W
8.2L GSi	8	1998	18-7876	502901	7.6L / 8.0 Qt.	25W-40 FC-W

Onan

Model	Year	Oil Filter	Replaces	Crankcase Capacity	Recommended Oil
MDKAU		23-7804	185-744	2.1L / 2.2 Qt.	15W-40 API CF or Higher
MDKAV		23-7842	185-5835	4.0L / 4.2 Qt.	15W-40 API CF or Higher
MDKBG		23-7842	185-5835	4.0L / 4.2 Qt.	15W-40 API CF or Higher
MDKAW (Spacesaver)		23-7842	185-5835	4.3L / 4.5 Qt.	15W-40 API CF or Higher
MDKAZ		23-7842	185-5835	4.3L / 4.5 Qt.	15W-40 API CF or Higher
MDKBD		23-7840	122-0810	7.6L / 8.0 Qt.	15W-40 API CF or Higher
MDKBE		23-7840	122-0810	7.6L / 8.0 Qt.	15W-40 API CF or Higher
MDKBF		23-7840	122-0810	12L / 12.7 Qt.	15W-40 API CF or Higher
MDKBD (w/ Isolated Ground)		23-7840	122-0810	7.6L / 8.0 Qt.	15W-40 API CF or Higher
MDKBE (w/ Isolated Ground)		23-7840	122-0810	7.6L / 8.0 Qt.	15W-40 API CF or Higher
MDKBF (w/ Isolated Ground)		23-7840	122-0810	12L / 12.7 Qt.	15W-40 API CF or Higher
MDKBH		23-7804	185-744	2.1L / 2.2 Qt.	15W-40 API CF or Higher
MDJB		23-7841	122-0185	3.3L / 3.5 Qt.	15W-40 API CF or Higher
MDJC		23-7841	122-0185	6.2L / 6.5 Qt.	15W-40 API CF or Higher
MDJE		23-7841	122-0185	3.3L / 3.5 Qt.	15W-40 API CF or Higher
MDJF		23-7841	122-0185	6.2L / 6.5 Qt.	15W-40 API CF or Higher
MJA		23-7841	122-0185	Refer to Owners Manual	15W-40 API CF or Higher
MJB		23-7841	122-0185	Refer to Owners Manual	15W-40 API CF or Higher
MJC		23-7841	122-0185	Refer to Owners Manual	15W-40 API CF or Higher
MDKAD/E/F		23-7840	122-0810	7.6L / 8.0 Qt.	15W-40 API CF or Higher
MDKAL/A/B		23-7842	185-5835	4.0L / 4.2 Qt.	15W-40 API CF or Higher

All listed oil capacities are approximate amounts only and may or may not include the oil filter capacity.
ALWAYS follow proper crankcase drain and fill procedures. Check engine dipstick for proper crankcase oil level.

OIL FILTER QUICK-REFERENCE GUIDE



PCM Pleasurecraft

Model	Year	Oil Filter	Replaces	Crankcase Capacity	Recommended Oil
200		18-7875	R077001	Refer to Owners Manual	Refer to Owners Manual
220		18-7875	R077001	Refer to Owners Manual	Refer to Owners Manual
8200		18-7875	R077001	Refer to Owners Manual	Refer to Owners Manual
8240		18-7875	R077001	Refer to Owners Manual	Refer to Owners Manual
230		18-7824	R077002	Refer to Owners Manual	Refer to Owners Manual
280		18-7824	R077002	Refer to Owners Manual	Refer to Owners Manual
300		18-7824	R077002	Refer to Owners Manual	Refer to Owners Manual
350		18-7824	R077002	Refer to Owners Manual	Refer to Owners Manual
5.0L MPI (Remote Oil Filter)	2007 & Older	18-7875	R077001	3.8L / 4.0 Qt.	15W-40 API SL or Higher
5.7L MPI (Remote Oil Filter)	2007 & Older	18-7875	R077001	3.8L / 4.0 Qt.	15W-40 API SL or Higher
6.0L MPI (Remote Oil Filter)	2007 & Older	18-7875	R077001	4.75L / 5.0 Qt.	15W-40 API SL or Higher
5.0L MPI (Serial 473065 & UP) (Remote Oil Filter)	2007 - 2009	18-7875	R077001	3.8L / 4.0 Qt.	15W-40 API SL or Higher
EX 343 (Serial 473065 & UP) (Remote Oil Filter)	2007 - 2012	18-7875	R077001	3.8L / 4.0 Qt.	15W-40 API SL or Higher
ZR6 390 (Serial 470365 & UP) (Remote Oil Filter)	2007	18-7875	R077001	4.75L / 5.0 Qt.	15W-40 API SL or Higher
5.0L Pro Sport Catanium™ CES (Remote Oil Filter)	2008 - 2010	18-7875	R077001	4.5L / 4.75 Qt.	15W-40 API SM or Higher
5.7L EX343 Catanium™ CES (Remote Oil Filter)	2008 - 2012	18-7875	R077001	4.5L / 4.75 Qt.	15W-40 API SM or Higher
6.0L ZR-409 Catanium™ CES (Remote Oil Filter)	2009 - 2012	18-7875	R077001	4.75L / 5.0 Qt.	15W-40 API SM or Higher
6.0L MPI - ZR409 (Remote Oil Filter)	2009 - 2012	18-7875	R077001	4.75L / 5.0 Qt.	15W-40 API SM or Higher
HO303 MPI	2011 - 2012	18-7875	R077001	3.8L / 4.0 Qt. (Starting Amount)	15W-40 API SM or Higher
HO303 Catanium™ CES	2011 - 2012	18-7875	R077001	3.8L / 4.0 Qt. (Starting Amount)	15W-40 API SM or Higher
ZR450 Catanium™ CES	2011 - 2012	18-7875	R077001	3.8L / 4.0 Qt. (Starting Amount)	15W-40 API SM or Higher
ZR550 6.2L MPI	2011 - 2012	18-7875	R077001	3.8L / 4.0 Qt. (Starting Amount)	5W-30 Full Synthetic

Suzuki

Model	Year	Oil Filter	Replaces	Crankcase Capacity	Recommended Oil
DF9.9-DF15 (9.9 hp. serial 110001 and below)	1996 - 2010	18-7903	16510-05240 16510-45H10	1.0 L / 1.1 Qt.	10W-40 Synthetic Blend FC-W
DF25	2000 - 2006	18-7915-1	16510-87J00	3.0 L / 3.2 Qt.	10W-40 Synthetic Blend FC-W
DF25 V-Twin	2006 - 2010	18-7915-1	16510-87J00	1.5L / 1.6 Qt.	10W-40 Synthetic Blend FC-W
DF30	2000 - 2007	18-7915-1	16510-87J00	3.0 L / 3.2 Qt.	10W-40 Synthetic Blend FC-W
DF40-DF50	1999 - 2010	18-7915-1	16510-87J00	2.2 L / 2.3 Qt.	10W-40 Synthetic Blend FC-W
DF60-DF70	1998 - 2009	18-7915-1	16510-87J00	4.5 L / 4.8 Qt.	10W-40 Synthetic Blend FC-W
DF60A	2010	18-7915-1	16510-87J00	2.7 L / 3.0 Qt.	10W-40 Synthetic Blend FC-W
DF70A	2009 - 2010	18-7896	16510-61A20-MHL	4.2 L / 4.0 Qt.	10W-40 Synthetic Blend FC-W
DF80A	2009 - 2010	18-7896	16510-61A20-MHL	4.2 L / 4.0 Qt.	10W-40 Synthetic Blend FC-W
DF90A	2009 - 2010	18-7896	16510-61A20-MHL	4.2 L / 4.0 Qt.	10W-40 Synthetic Blend FC-W
DF90	2001 - 2008	18-7896	16510-61A20-MHL	5.5 L / 5.8 Qt.	10W-40 Synthetic Blend FC-W
DF115	2001 - 2010	18-7896	16510-61A20-MHL	5.5 L / 5.8 Qt.	10W-40 Synthetic Blend FC-W
DF140	2002 - 2010	18-7897	16510-82703	5.5 L / 5.8 Qt.	10W-40 Synthetic Blend FC-W
DF150-DF175	2006 - 2010	18-7905	16510-96J00	8.0 L / 8.5 Qt.	10W-40 Synthetic Blend FC-W
DF200 / DF225 / DF250	2004 - 2010	18-7905	16510-96J00	8.0 L / 8.5 Qt.	10W-40 Synthetic Blend FC-W
DF300	2007 - 2010	18-7905	16510-96J00	8.0 L / 8.5 Qt.	10W-40 Synthetic Blend FC-W

Volvo Gasoline

Model	Cylinders	Year	Oil Filter	Replaces	Crankcase Capacity	Recommended Oil
230 A/B	4	1989 - 1993	18-7878-1	3517857	4.5L / 4.75 Qt.	10W-40 FC-W
250 A/B	4	1989 - 1993	18-7878-1	3517857	4.5L / 4.75 Qt.	10W-40 FC-W
251A	4	1989 - 1992	18-7878-1	3517857	4.5L / 4.75 Qt.	10W-40 FC-W
3.0L	4	1993 - Current	18-7824	835440	3.8L / 4.0 Qt.	Synthetic SAE 30 (1)
AQ100	4	1961 - 1963	18-7878-1	3517857	3.8L / 4.0 Qt.	10W-40 FC-W
AQ110	4	1963 - 1966	18-7878-1	3517857	3.8L / 4.0 Qt.	10W-40 FC-W
AQ115 A/B	4	1969 - 1975	18-7878-1	3517857	3.8L / 4.0 Qt.	10W-40 FC-W
AQ120 A/B	4	1966 - 1980	18-7878-1	3517857	3.8L / 4.0 Qt.	10W-40 FC-W
AQ125 A/B	4	1981 - 1985	18-7878-1	3517857	4.2L / 4.5 Qt.	10W-40 FC-W
AQ130 A/B/C/D	4	1968 - 1977	18-7878-1	3517857	3.8L / 4.0 Qt.	10W-40 FC-W

All listed oil capacities are approximate amounts only and may or may not include the oil filter capacity.
ALWAYS follow proper crankcase drain and fill procedures. Check engine dipstick for proper crankcase oil level.

Continued Next Page



OIL FILTER QUICK-REFERENCE GUIDE

CAPACITY CHARTS

Volvo Gasoline - Continued

Model	Cylinders	Year	Oil Filter	Replaces	Crankcase Capacity	Recommended Oil
AQ131 A/B/C/D	4	1985 - 1989	18-7878-1	3517857	3.8L / 4.0 Qt.	10W-40 FC-W
AQ140A	4	1975 - 1979	18-7878-1	3517857	3.8L / 4.0 Qt.	10W-40 FC-W
AQ145 A/B	4	1979 - 1985	18-7878-1	3517857	4.2L / 4.5 Qt.	10W-40 FC-W
AQ151 A/B/C	4	1985 - 1989	18-7878-1	3517857	3.8L / 4.0 Qt.	10W-40 FC-W
AQ170 A/B/C	4	1969 - 1980	18-7878-1	3517857	3.8L / 4.0 Qt.	10W-40 FC-W
AQ171 A/C	4	1986 - 1989	18-7878-1	3517857	3.8L / 4.0 Qt.	10W-40 FC-W
AQ60F	4	1962 - 1968	18-7878-1	3517857	Check Owners Manual	10W-40 FC-W
AQ90	4	1962 - 1964	18-7878-1	3517857	3.8L / 4.0 Qt.	10W-40 FC-W
AQ95 /A	4	1964 - 1966	18-7878-1	3517857	3.8L / 4.0 Qt.	10W-40 FC-W
BB100	4	1963 - 1969	18-7878-1	3517857	Check Owners Manual	10W-40 FC-W
BB115 A/B/C	4	1969 - 1977	18-7878-1	3517857	Check Owners Manual	10W-40 FC-W
BB140A	4	1975 - 1979	18-7878-1	3517857	Check Owners Manual	10W-40 FC-W
BB145A	4	1979 - 1985	18-7878-1	3517857	Check Owners Manual	10W-40 FC-W
BB165A	4	1965 - 1969	18-7878-1	3517857	Check Owners Manual	10W-40 FC-W
BB170 A/B/C	4	1969 - 1978	18-7878-1	3517857	Check Owners Manual	10W-40 FC-W
BB30	4	1963 - 1969	18-7878-1	3517857	Check Owners Manual	10W-40 FC-W
MB10A	4	1971 - 1977	18-7878-1	3517857	Check Owners Manual	10W-40 FC-W
MB20 A/B/C	4	1969 - 1980	18-7878-1	3517857	Check Owners Manual	10W-40 FC-W
4.3L	V6	1993 - 2006	18-7879	841750	4.2L / 4.5 Qt.	Synthetic SAE 30 (1)
4.3L	V6	2007 - Current	18-8003	8692305	4.7L / 5.0 Qt.	Synthetic SAE 30 (1)
430 A/B	V6	1990 - 1992	18-7879	841750	4.2L / 4.5 Qt.	10W-40 FC-W
431 A/B	V6	1989 - 1992	18-7879	841750	4.2L / 4.5 Qt.	10W-40 FC-W
432A/B	V6	1992 - 1998	18-7879	841750	4.2L / 4.5 Qt.	10W-40 FC-W
434A/B	V6	1992 - 1997	18-7879	841750	4.2L / 4.5 Qt.	10W-40 FC-W
AQ175A	V6	1981 - 1985	18-7879	841750	6.0L / 6.5 Qt	10W-40 FC-W
AQ205A	V6	1988 - 1989	18-7879	841750	6.0L / 6.5 Qt	10W-40 FC-W
5.0L (Ford)	V8	1993 - 1999	18-7875	835779	5.7L / 6.0 Qt.	Synthetic SAE 30 (1)
5.0L (GM)	V8	1997 - 2006	18-7824	835440	5.7L / 6.0 Qt.	Synthetic SAE 30 (1)
5.0L (GM)	V8	2007 - Current	18-8003	8692305	5.2L / 5.5 Qt.	Synthetic SAE 30 (1)
5.7L	V8	1993 - 2006	18-7824	835440	5.7L / 6.0 Qt.	Synthetic SAE 30 (1)
5.7L	V8	2007 - Current	18-8003	8692305	5.2L / 5.5 Qt.	Synthetic SAE 30 (1)
5.8L	V8	1993 - 1996	18-7875	835779	5.7L / 6.0 Qt.	Synthetic SAE 30 (1)
500 A/B	V8	1989 - 1993	18-7824	835440	5.7L / 6.0 Qt.	10W-40 FC-W
501 A/B	V8	1989 - 1993	18-7824	835440	5.7L / 6.0 Qt.	10W-40 FC-W
570 A/MS4A	V8	1989 - 1993	18-7824	835440	5.7L / 6.0 Qt.	10W-40 FC-W
571A	V8	1989 - 1992	18-7824	835440	5.7L / 6.0 Qt.	10W-40 FC-W
572A	V8	1991 - 1993	18-7824	835440	5.7L / 6.0 Qt.	10W-40 FC-W
7.4L	V8	1993 - 2000	18-7876	3850559	6.6L / 7.0 Qt.	Synthetic SAE 30 (1)
740 A/B	V8	1992 - 1993	18-7876	3850559	6.6L / 7.0 Qt.	10W-40 FC-W
8.1L	V8	1999 - 2006	18-7824	835440	8.0L / 8.5 Qt.	Synthetic SAE 30 (1)
8.1L	V8	2007 - Current	18-8003	8692305	8.0L / 8.5 Qt.	Synthetic SAE 30 (1)
8.2L	V8	1993 - 2000	18-7876	3850559	6.6L / 7.0 Qt.	Synthetic SAE 30 (1)
AQ190A	V8	1976 - 1977	18-7875	835779	4.0L / 4.2 Qt.	10W-40 FC-W
AQ211A	V8	1986 - 1989	18-7824	835440	4.0L / 4.2 Qt.	10W-40 FC-W
AQ225 B/C/D/E/F	V8	1973 - 1976	18-7824	835440	4.4L / 4.7 Qt.	10W-40 FC-W
AQ231A	V8	1986 - 1989	18-7824	835440	4.4L / 4.7 Qt.	10W-40 FC-W
AQ231B	V8	1987 - 1989	18-7824	835440	4.4L / 4.7 Qt.	10W-40 FC-W
AQ240A	V8	1976 - 1977	18-7875	835779	4.4L / 4.7 Qt.	10W-40 FC-W
AQ255 A/B	V8	1977 - 1978	18-7824	835440	5.7L / 6.0 Qt.	10W-40 FC-W
AQ260 A/B	V8	1979 - 1986	18-7824	835440	5.7L / 6.0 Qt.	10W-40 FC-W
AQ271 A/B/C/D	V8	1986 - 1989	18-7824	835440	5.4L / 5.7 Qt.	10W-40 FC-W
AQ280A	V8	1978 - 1979	18-7824	835440	5.4L / 5.7 Qt.	10W-40 FC-W
AQ290A	V8	1979 - 1985	18-7824	835440	5.4L / 5.7 Qt.	10W-40 FC-W
AQ311 A/B	V8	1986 - 1987	18-7824	835440	5.4L / 5.7 Qt.	10W-40 FC-W
BB225 A/B/C	V8	1973 - 1977	18-7824	835440	4.4L / 4.7 Qt.	10W-40 FC-W

All listed oil capacities are approximate amounts only and may or may not include the oil filter capacity. ALWAYS follow proper crankcase drain and fill procedures. Check engine dipstick for proper crankcase oil level.

OIL FILTER QUICK-REFERENCE GUIDE



Volvo Gasoline - Continued

Model	Cylinders	Year	Oil Filter	Replaces	Crankcase Capacity	Recommended Oil
BB231A	V8	1987	18-7824	835440	4.4L / 4.7 Qt.	10W-40 FC-W
BB260 A/B/C	V8	1978 - 1987	18-7824	835440	5.7L / 6.0 Qt.	10W-40 FC-W
BB261A	V8	1988 - 1989	18-7824	835440	5.7L / 6.0 Qt.	10W-40 FC-W

Volvo Diesel

Model	Cylinders	Year	Oil Filter	Replaces	Crankcase Capacity See Notes	Recommended Oil
2001 / B	1	1984 - 1993	18-7884	834337	1.4L / 1.5 Qt.	15W-40 VDS-2 or VDS-3 / API CI-4 or higher
MD1B	1	1970 - 1973	18-7884	834337	1.5L / 1.8 Qt.	15W-40 VDS-2 or VDS-3 / API CI-4 or higher
MD5A / B / C	1	1975 - 1982	18-7884	834337	2.0L / 2.10 Qt.	15W-40 VDS-2 or VDS-3 / API CI-4 or higher
2002 / B	2	1983 - 1993	18-7884	834337	2.75L / 2.9 Qt.	15W-40 VDS-2 or VDS-3 / API CI-4 or higher
AQD2B	2	1972 - 1975	18-7884	834337	See Owners Manual	15W-40 VDS-2 or VDS-3 / API CI-4 or higher
MD11C / D	2	1975 - 1983	18-7884	834337	2.6L / 2.7 Qt.	15W-40 VDS-2 or VDS-3 / API CI-4 or higher
MD2	2	1964 - 1967	18-7884	834337	See Owners Manual	15W-40 VDS-2 or VDS-3 / API CI-4 or higher
MD2B	2	1970 - 1975	18-7884	834337	2.6L / 2.7 Qt.	15W-40 VDS-2 or VDS-3 / API CI-4 or higher
MD6A / B	2	1971 - 1976	18-7884	834337	2.8L / 2.9 Qt.	15W-40 VDS-2 or VDS-3 / API CI-4 or higher
MD7A / B	2	1976 - 1983	18-7884	834337	2.8L / 2.9 Qt.	15W-40 VDS-2 or VDS-3 / API CI-4 or higher
2003 / B / TB	3	1983 - 1993	18-7884	834337	4.1L / 4.3 Qt.	15W-40 VDS-2 or VDS-3 / API CI-4 or higher
MD17C / D	3	1975 - 1984	18-7884	834337	4.2L / 4.4 Qt.	15W-40 VDS-2 or VDS-3 / API CI-4 or higher
MD3B	3	1971 - 1975	18-7884	834337	4.8L / 5.8 Qt.	15W-40 VDS-2 or VDS-3 / API CI-4 or higher
AD31A / L-A / P-A / D / X	4	1986 - 2004	18-7878-1	3517857	8.5L / 9.0 Qt.	15W-40 VDS-2 or VDS-3 / API CI-4 or higher
AQAD30A	4	1983 - 1986	18-7878-1	3517857	8.5L / 9.0 Qt.	15W-40 VDS-2 or VDS-3 / API CI-4 or higher
AQAD31A	4	1986 - 1989	18-7878-1	3517857	8.5L / 9.0 Qt.	15W-40 VDS-2 or VDS-3 / API CI-4 or higher
AQD21A / B	4	1969 - 1981	18-7974	3827069	5.5L / 5.8 Qt.	15W-40 VDS-2 or VDS-3 / API CI-4 or higher
D4-180iB / C / D / E	4	2005 - Current	18-0035	3582732 Full Flow	12.5L / 13.2 Qt.	15W-40 VDS-2 or VDS-3 / API CI-4 or higher
D4-180iB / C / D / E	4	2005 - Current	18-0036	3582732 Bypass	12.5L / 13.2 Qt.	15W-40 VDS-2 or VDS-3 / API CI-4 or higher
D4-210A-A / A-B	4	2003 - 2006	18-0035	3582732 Full Flow	12.5L / 13.2 Qt.	15W-40 VDS-2 or VDS-3 / API CI-4 or higher
D4-210A-A / B	4	2003 - 2006	18-0036	3582732 Bypass	12.5L / 13.2 Qt.	15W-40 VDS-2 or VDS-3 / API CI-4 or higher
D4-210i-A / B	4	2003 - 2006	18-0035	3582732 Full Flow	12.5L / 13.2 Qt.	15W-40 VDS-2 or VDS-3 / API CI-4 or higher
D4-210i-A / B	4	2003 - 2006	18-0036	3582732 Bypass	12.5L / 13.2 Qt.	15W-40 VDS-2 or VDS-3 / API CI-4 or higher
D4-225A-B	4	2005 - 2008	18-0035	3582732 Full Flow	12.5L / 13.2 Qt.	15W-40 VDS-2 or VDS-3 / API CI-4 or higher
D4-225A-B	4	2005 - 2008	18-0036	3582732 Bypass	12.5L / 13.2 Qt.	15W-40 VDS-2 or VDS-3 / API CI-4 or higher
D4-225i-B	4	2005 - 2008	18-0035	3582732 Full Flow	12.5L / 13.2 Qt.	15W-40 VDS-2 or VDS-3 / API CI-4 or higher
D4-225i-B	4	2005 - 2008	18-0036	3582732 Bypass	12.5L / 13.2 Qt.	15W-40 VDS-2 or VDS-3 / API CI-4 or higher
D4-260A-A / A-B / D-B	4	2004 - 2008	18-0036	3582732 Bypass	12.5L / 13.2 Qt.	15W-40 VDS-2 or VDS-3 / API CI-4 or higher
D4-260A-A / A-B / D-B(IPS)	4	2004 - 2008	18-0035	3582732 Full Flow	12.5L / 13.2 Qt.	15W-40 VDS-2 or VDS-3 / API CI-4 or higher
D4-260i-A / B	4	2004 - 2008	18-0035	3582732 Full Flow	12.5L / 13.2 Qt.	15W-40 VDS-2 or VDS-3 / API CI-4 or higher
D4-260i-A / B	4	2004 - 2008	18-0036	3582732 Bypass	12.5L / 13.2 Qt.	15W-40 VDS-2 or VDS-3 / API CI-4 or higher
D4-300A-A / A-E / D-A	4	2007 - Current	18-0035	3582732 Full Flow	12.5L / 13.2 Qt.	15W-40 VDS-2 or VDS-3 / API CI-4 or higher
D4-300A-A / A-E / D-A	4	2007 - Current	18-0036	3582732 Bypass	12.5L / 13.2 Qt.	15W-40 VDS-2 or VDS-3 / API CI-4 or higher
D4-300i-A / C / D	4	2007 - 2010	18-0035	3582732 Full Flow	12.5L / 13.2 Qt.	15W-40 VDS-2 or VDS-3 / API CI-4 or higher
D4-300i-A / C / D	4	2007 - 2010	18-0036	3582732 Bypass	12.5L / 13.2 Qt.	15W-40 VDS-2 or VDS-3 / API CI-4 or higher
KAD32P	4	1997 - 2005	18-7926		8.5L / 9.0 Qt.	15W-40 VDS-2 or VDS-3 / API CI-4 or higher
MD21A / B	4	1969 - 1981	18-7974	3827069	5.5L / 5.8 Qt.	15W-40 VDS-2 or VDS-3 / API CI-4 or higher
MD30A	4	1983 - 1986	18-7878-1	3517857	8.5L / 9.0 Qt.	15W-40 VDS-2 or VDS-3 / API CI-4 or higher
MD31A	4	1986 - 1994	18-7878-1	3517857	8.5L / 9.0 Qt.	15W-40 VDS-2 or VDS-3 / API CI-4 or higher
TAMD30A	4	1983 - 1986	18-7878-1	3517857	8.5L / 9.0 Qt.	15W-40 VDS-2 or VDS-3 / API CI-4 or higher
TAMD31B / D / PL	4	1989 - 2003	18-7878-1	3517857	8.5L / 9.0 Qt.	15W-40 VDS-2 or VDS-3 / API CI-4 or higher
TMD30A	4	1983 - 1986	18-7878-1	3517857	8.5L / 9.0 Qt.	15W-40 VDS-2 or VDS-3 / API CI-4 or higher
TMD31A / B / D	4	1986 - 1994	18-7878-1	3517857	8.5L / 9.0 Qt.	15W-40 VDS-2 or VDS-3 / API CI-4 or higher
TMD31L-A	4	1994 - 1997	18-7878-1	3517857	8.5L / 9.0 Qt.	15W-40 VDS-2 or VDS-3 / API CI-4 or higher
D3-110i-A / B / C	5	2004 - 2006	18-8003	8692305	5.65L / 6.0 Qt.	15W-40 VDS-2 or VDS-3 / API CI-4 or higher
D3-130A-A / A-B	5	2005 - 2006	18-8003	8692305	5.65L / 6.0 Qt.	15W-40 VDS-2 or VDS-3 / API CI-4 or higher
D3-130i-A / B / C	5	2004 - 2006	18-8003	8692305	5.65L / 6.0 Qt.	15W-40 VDS-2 or VDS-3 / API CI-4 or higher
D3-160A-A / A-B / A-C	5	2004 - 2006	18-8003	8692305	5.65L / 6.0 Qt.	15W-40 VDS-2 or VDS-3 / API CI-4 or higher

All listed oil capacities are approximate amounts only and may or may not include the oil filter capacity.
 ALWAYS follow proper crankcase drain and fill procedures. Check engine dipstick for proper crankcase oil level.

Continued Next Page



OIL FILTER QUICK-REFERENCE GUIDE

Volvo Diesel - Continued

Model	Cylinders	Year	Oil Filter	Replaces	Crankcase Capacity See Notes	Recommended Oil
D3-160i-A / B / C	5	2004 - 2006	18-8003	8692305	5.65L / 6.0 Qt.	15W-40 VDS-2 or VDS-3 / API CI-4 or higher
D3-190A-B	5	2005 - 2007	18-8003	8692305	5.65L / 6.0 Qt.	15W-40 VDS-2 or VDS-3 / API CI-4 or higher
D3-190i-B / C	5	2005 - Current	18-8003	8692305	5.65L / 6.0 Qt.	15W-40 VDS-2 or VDS-3 / API CI-4 or higher
AQD70B / C	6	1972 - 1978	18-7926	423135	20L / 5.28 Gal.	15W-40 VDS-2 or VDS-3 / API CI-4 or higher
D11A-A / B / C / D	6	2007 - Current	18-0033	478736	38L / 10 Gal.	15W-40 VDS-2 or VDS-3 / API CI-4 or higher
D11A-A / B / C / D	6	2007 - Current	18-0034	477556	38L / 10 Gal.	15W-40 VDS-2 or VDS-3 / API CI-4 or higher
D11A-C (IPS) / D11A-D (IPS)	6	2009 - Current	18-0033	478736	38L / 10 Gal.	15W-40 VDS-2 or VDS-3 / API CI-4 or higher
D11A-C (IPS) / D11A-D (IPS)	6	2009 - Current	18-0034	477556	38L / 10 Gal.	15W-40 VDS-2 or VDS-3 / API CI-4 or higher
D12D-AMP / B / C / E / F / G / H	6	1999 - 2009	18-0033	478736	44L / 11.62 Gal.	15W-40 VDS-2 or VDS-3 / API CI-4 or higher
D12D-AMG / EMG (Gen Set)	6	2002 - 2008	18-0034	477556	44L / 11.62 Gal.	15W-40 VDS-2 or VDS-3 / API CI-4 or higher
D12D-AMH / B / C / E / G	6	2002 - 2008	18-0033	478736	44L / 11.62 Gal.	15W-40 VDS-2 or VDS-3 / API CI-4 or higher
D13AMP / B / C / G / H	6	2009 - Current	18-0033	478736	45L / 11.89 Gal.	15W-40 VDS-2 or VDS-3 / API CI-4 or higher
D13AMP / B / C / G / H	6	2009 - Current	18-0034	477556	45L / 11.89 Gal.	15W-40 VDS-2 or VDS-3 / API CI-4 or higher
D16C-AMG / B / C (Gen Set)	6	2006 - 2009	18-0034	477556	49L / 13 Gal.	15W-40 VDS-2 or VDS-3 / API CI-4 or higher
D16C-AMH / B / C	6	2006 - 2009	18-0033	478736	49L / 13 Gal.	15W-40 VDS-2 or VDS-3 / API CI-4 or higher
D6-280A-A / A-B / A-C / A-D	6	2004 - 2010	18-0035	3582732 Full Flow	20L / 5.28 Gal.	15W-40 VDS-2 or VDS-3 / API CI-4 or higher
D6-280i-A / B	6	2004 - 2008	18-0035	3582732 Full Flow	20L / 5.28 Gal.	15W-40 VDS-2 or VDS-3 / API CI-4 or higher
D6-280i-A / B	6	2004 - 2008	18-0036	3582733 Bypass	20L / 5.28 Gal.	15W-40 VDS-2 or VDS-3 / API CI-4 or higher
D6-310i-A / B / C / D	6	2003 - 2010	18-0035	3582732 Full Flow	20L / 5.28 Gal.	15W-40 VDS-2 or VDS-3 / API CI-4 or higher
D6-310i-A / B / C / D	6	2003 - 2010	18-0036	3582733 Bypass	20L / 5.28 Gal.	15W-40 VDS-2 or VDS-3 / API CI-4 or higher
D6-330A-B / D-B	6	2004 - 2008	18-0035	3582732 Full Flow	20L / 5.28 Gal.	15W-40 VDS-2 or VDS-3 / API CI-4 or higher
D6-330A-B / D-B	6	2004 - 2008	18-0036	3582733 Bypass	20L / 5.28 Gal.	15W-40 VDS-2 or VDS-3 / API CI-4 or higher
D6--330i-B / C / D	6	2007 - 2010	18-0035	3582732 Full Flow	20L / 5.28 Gal.	15W-40 VDS-2 or VDS-3 / API CI-4 or higher
D6--330i-B / C / D	6	2007 - 2010	18-0036	3582733 Bypass	20L / 5.28 Gal.	15W-40 VDS-2 or VDS-3 / API CI-4 or higher
D6-370A-B / A-C / A-D / D-B / D-C / D-D	6	2007 - 2010	18-0035	3582732 Full Flow	20L / 5.28 Gal.	15W-40 VDS-2 or VDS-3 / API CI-4 or higher
D6-370A-B / A-C / A-D / D-B / D-C / D-D	6	2007 - 2010	18-0036	3582733 Bypass	20L / 5.28 Gal.	15W-40 VDS-2 or VDS-3 / API CI-4 or higher
D6-400A-E	6	2011 - Current	18-0035	3582732 Full Flow	20L / 5.28 Gal.	15W-40 VDS-2 or VDS-3 / API CI-4 or higher
D6-400A-E	6	2011 - Current	18-0036	3582733 Bypass	20L / 5.28 Gal.	15W-40 VDS-2 or VDS-3 / API CI-4 or higher
D6-435D-C / D-D / D-E	6	2006 - Current	18-0035	3582732 Full Flow	20L / 5.28 Gal.	15W-40 VDS-2 or VDS-3 / API CI-4 or higher
D6-435D-C / D-D / D-E	6	2006 - Current	18-0036	3582733 Bypass	20L / 5.28 Gal.	15W-40 VDS-2 or VDS-3 / API CI-4 or higher
D6-435i-A / C / D / E	6	2006 - Current	18-0035	3582732 Full Flow	20L / 5.28 Gal.	15W-40 VDS-2 or VDS-3 / API CI-4 or higher
D6-435i-A / C / D / E	6	2006 - Current	18-0036	3582733 Bypass	20L / 5.28 Gal.	15W-40 VDS-2 or VDS-3 / API CI-4 or higher
D9A2A	6	2004 - 2006	18-0033	478736	31L / 32.75 Qt.	15W-40 VDS-2 or VDS-3 / API CI-4 or higher
D9A2A MG (Gen Set)	6	2004 - Current	18-0033	478736	31L / 32.75 Qt.	15W-40 VDS-2 or VDS-3 / API CI-4 or higher
KAD300-A	6	2001 - 2005	18-7926		11L / 11.6 Qt.	15W-40 VDS-2 or VDS-3 / API CI-4 or higher
KAD42B/P/PA	6	1993 - 1997	18-7926		10.5L / 11.0 Qt.	15W-40 VDS-2 or VDS-3 / API CI-4 or higher
KAD43P-A	6	1997 - 2005	18-7926		10.5L / 11.0 Qt.	15W-40 VDS-2 or VDS-3 / API CI-4 or higher
KAD44P-A/B/C	6	1997 - 2004	18-7926		11L / 11.6 Qt.	15W-40 VDS-2 or VDS-3 / API CI-4 or higher
KAMD300-A	6	2001 - 2004	18-7926		11L / 11.6 Qt.	15W-40 VDS-2 or VDS-3 / API CI-4 or higher
KAMD42A/B/P/PA	6	1991 - 1997	18-7926		10.5L / 11.0 Qt.	15W-40 VDS-2 or VDS-3 / API CI-4 or higher
KAMD43P-A	6	1997 - 2005	18-7926		10.5L / 11.0 Qt.	15W-40 VDS-2 or VDS-3 / API CI-4 or higher
KAMD44P-B/C	6	1999 - 2004	18-7926		11L / 11.6 Qt.	15W-40 VDS-2 or VDS-3 / API CI-4 or higher
MD100A/B	6	1965 - 1984	18-7926		50L / 13.21 Gal.	15W-40 VDS-2 or VDS-3 / API CI-4 or higher
MD120A/B	6	1970 - 1980	18-7926		50L / 13.21 Gal.	15W-40 VDS-2 or VDS-3 / API CI-4 or higher
MD32A	6	1970 - 1977	18-7974	3827069	8L / 8.4 Qt.	15W-40 VDS-2 or VDS-3 / API CI-4 or higher
MD70B	6	1970 - 1978	18-7926		15L / 16 Qt.	15W-40 VDS-2 or VDS-3 / API CI-4 or higher
TAMD102A (Long Filter)	6	1991 - 2000	18-0033	478736	50L / 13.21 Gal.	15W-40 VDS-2 or VDS-3 / API CI-4 or higher
TAMD102A / D (Short Filter)	6	1991 - 2000	18-0032	847741	50L / 13.21 Gal.	15W-40 VDS-2 or VDS-3 / API CI-4 or higher
TAMD103A-A (Long Filter)	6	2000 - 2004	18-0033	478736	50L / 13.2 Gal.	15W-40 VDS-2 or VDS-3 / API CI-4 or higher
TAMD103A-A, AUX (Short Filter)	6	2000 - 2004	18-0032	847741	50L / 13.2 Gal.	15W-40 VDS-2 or VDS-3 / API CI-4 or higher
TAMD120A / B	6	1972 - 1983	18-7926		50L / 13.2 Gal.	15W-40 VDS-2 or VDS-3 / API CI-4 or higher

All listed oil capacities are approximate amounts only and may or may not include the oil filter capacity.
ALWAYS follow proper crankcase drain and fill procedures. Check engine dipstick for proper crankcase oil level.

OIL FILTER QUICK-REFERENCE GUIDE



Volvo Diesel - Continued

Model	Cylinders	Year	Oil Filter	Replaces	Crankcase Capacity See Notes	Recommended Oil
TAMD122D	6	1989 - 1996	18-0032	847741	50L / 13.2 Gal.	15W-40 VDS-2 or VDS-3 / API CI-4 or higher
TAMD122P-A, B, C	6	1995 - 2002	18-0033	478736	50L / 13.2 Gal.	15W-40 VDS-2 or VDS-3 / API CI-4 or higher
TAMD162A / B / C	6	1988 - 1996	18-0033	478736	73L / 19.3 Gal.	15W-40 VDS-2 or VDS-3 / API CI-4 or higher
TAMD162C-C	6	1999 - 2001	18-0033	478736	Refer to Owners Manual	15W-40 VDS-2 or VDS-3 / API CI-4 or higher
TAMD163A-A / PA	6	1994 - 2001	18-0033	478736	73L / 19.3 Gal.	15W-40 VDS-2 or VDS-3 / API CI-4 or higher
TAMD165A-A / C-A / P-A	6	2002 - 2005	18-0033	478736	73L / 19.3 Gal.	15W-40 VDS-2 or VDS-3 / API CI-4 or higher
TAMD40A / B	6	1980 - 1986	18-7926	423135	10.5L / 11.0 Qt.	15W-40 VDS-2 or VDS-3 / API CI-4 or higher
TAMD41A/B/D	6	1986 - 1994	18-7926	423135	10.5L / 11.0 Qt.	15W-40 VDS-2 or VDS-3 / API CI-4 or higher
TAMD42 B/WJ-A	6	1993 - 2003	18-7926	423135	10.5L / 11.0 Qt.	15W-40 VDS-2 or VDS-3 / API CI-4 or higher
TAMD60A/B/C	6	1976 - 1987	18-7926	423135	20L / 5.28 Gal.	15W-40 VDS-2 or VDS-3 / API CI-4 or higher
TAMD61A	6	1986 - 1999	18-0032	847741	20L / 5.28 Gal.	15W-40 VDS-2 or VDS-3 / API CI-4 or higher
TAMD62A	6	1992 - 1994	18-0032	847741	20L / 5.28 Gal.	15W-40 VDS-2 or VDS-3 / API CI-4 or higher
TAMD63LA, 63PA	6	1994 - 2005	18-7974	3827069	20L / 5.28 Gal.	15W-40 VDS-2 or VDS-3 / API CI-4 or higher
TAMD63P-A	6	1994 - 2005	18-0032	847741	20L / 5.28 Gal.	15W-40 VDS-2 or VDS-3 / API CI-4 or higher
TAMD70B/C	6	1970 - 1978	18-7926	423135	20L / 5.28 Gal.	15W-40 VDS-2 or VDS-3 / API CI-4 or higher
TAMD71A	6	1986 - 1994	18-0032	847741	20L / 5.28 Gal.	15W-40 VDS-2 or VDS-3 / API CI-4 or higher
TAMD71B	6	1989 - 2000	18-1974	3827069	20L / 5.28 Gal.	15W-40 VDS-2 or VDS-3 / API CI-4 or higher
TAMD72A	6	1991 - 1994	18-0032	847741	20L / 5.28 Gal.	15W-40 VDS-2 or VDS-3 / API CI-4 or higher
TAMD72P-A	6	1995 - 1997	18-0032	847741	27L / 7.1 Gal.	15W-40 VDS-2 or VDS-3 / API CI-4 or higher
TAMD72WJ-A	6	1993 - 1997	18-0032	847741	20L / 5.28 Gal.	15W-40 VDS-2 or VDS-3 / API CI-4 or higher
TAMD73P-A/WJ-A	6	1997 - 1999	18-7926	423135	28L / 7.4 Gal.	15W-40 VDS-2 or VDS-3 / API CI-4 or higher
TAMD74A	6	2000 - 2001	18-0032	847741	29L / 7.7 Gal.	15W-40 VDS-2 or VDS-3 / API CI-4 or higher
TAMD74A-A / A-B / P-B	6	2000 - 2005	18-7926		24L / 6.3 Gal.	15W-40 VDS-2 or VDS-3 / API CI-4 or higher
TAMD74C-A, B	6	2000 - 2001	18-0032	847741	25L / 6.6 Gal.	15W-40 VDS-2 or VDS-3 / API CI-4 or higher
TAMD74L-A, B	6	2000 - 2005	18-0032	847741	25L / 6.6 Gal.	15W-40 VDS-2 or VDS-3 / API CI-4 or higher
TAMD74P-A, B	6	1998 - 2005	18-0032	847741	25L / 6.6 Gal.	15W-40 VDS-2 or VDS-3 / API CI-4 or higher
TAMD75P-A	6	1998 - 2005	18-7926		24L / 6.3 Gal.	15W-40 VDS-2 or VDS-3 / API CI-4 or higher
THAMD70B/C	6	1972 - 1979	18-7926		24L / 6.3 Gal.	15W-40 VDS-2 or VDS-3 / API CI-4 or higher
TMD100A	6	1965 - 1983	18-7926		50L / 13.2 Gal.	15W-40 VDS-2 or VDS-3 / API CI-4 or higher
TMD102A	6	1988 - 2000	18-0033	478736	50L / 13.2 Gal.	15W-40 VDS-2 or VDS-3 / API CI-4 or higher
TMD120A/B	6	1970 - 1983	18-7878-1	3517857	50L / 13.2 Gal.	15W-40 VDS-2 or VDS-3 / API CI-4 or higher
TMD41B	6	1989 - 1993	18-7926		8.5L / 9 Qt.	15W-40 VDS-2 or VDS-3 / API CI-4 or higher
TMD41L-A	6	1994 - 1997	18-7926		10.5L / 11.0 Qt.	15W-40 VDS-2 or VDS-3 / API CI-4 or higher
TMD70B/C	6	1972 - 1985	18-0032	847741	20L / 5.28 Gal.	15W-40 VDS-2 or VDS-3 / API CI-4 or higher

Westerbeke

Model	Cylinders	Year	Oil Filter	Replaces	Crankcase Capacity	Recommended Oil
Propulsion Engines						
11A One	1	2001 - Current	23-7800	036918	1.6L / 1.7 Qt.	SAE 10W-30
12B Two	2	1983 - 1992	23-7800	036918	2.8L / 3.0 Qt.	SAE 10W-30
12C Two	2	1992 - Current	23-7800	036918	2.8L / 3.0 Qt.	SAE 10W-30
12D Two	2	Current	23-7800	036918	2.8L / 3.0 Qt.	15W-40 API CI-4, CI-4 Plus, CJ-4
20B Two	2	1987 - Current	23-7800	036918	2.8L / 3.0 Qt.	15W-40 API CI-4, CI-4 Plus, CJ-4
W13	2	1980 - 1984	23-7800	036918	2.8L / 3.0 Qt.	SAE 10W-30
W13A	2	1984 - 1988	23-7800	036918	2.8L / 3.0 Qt.	SAE 10W-30
30B Three	3	1987 - Current	23-7800	036918	2.8L / 3.0 Qt.	15W-40 API CI-4, CI-4 Plus, CJ-4
30C Three	3	Current	23-7800	036918	2.8L / 3.0 Qt.	15W-40 API CI-4, CI-4 Plus, CJ-4
35B Three	3	1987 - 2000	23-7800	036918	4.5L / 4.75 Qt.	SAE 10W-30
35C Three	3	2000 - 2002	23-7800	036918	4.5L / 4.75 Qt.	15W-40 API CI-4, CI-4 Plus, CJ-4
35D Three	3	2002 - Current	23-7800	036918	4.5L / 4.75 Qt.	15W-40 API CI-4, CI-4 Plus, CJ-4
35E Three	3	Current	23-7800	036918	4.5L / 4.75 Qt.	15W-40 API CI-4, CI-4 Plus, CJ-4
W18	3	1985 - 1989	23-7800	036918	3.78L / 4.0 Qt.	SAE 10W-30
W21	3	1980 - 1984	23-7800	036918	3.78L / 4.0 Qt.	SAE 10W-30
W21A	3	1984 - 1987	23-7800	036918	3.78L / 4.0 Qt.	SAE 10W-30

All listed oil capacities are approximate amounts only and may or may not include the oil filter capacity.
ALWAYS follow proper crankcase drain and fill procedures. Check engine dipstick for proper crankcase oil level.

Continued Next Page



OIL FILTER QUICK-REFERENCE GUIDE

Westerbeke - Continued

Model	Cylinders	Year	Oil Filter	Replaces	Crankcase Capacity	Recommended Oil
38B Four	4	1987 - 2001	23-7825	035828	4.5L / 4.75 Qt.	SAE 10W-30
42B Four	4	1987 - 1999	23-7825	035828	4.5L / 4.75 Qt.	SAE 10W-30
44A Four	4	1999 - 2002	23-7800	036918	4.5L / 4.75 Qt.	15W-40 API CI-4, CI-4 Plus, CJ-4
44B Four	4	2002 - Current	23-7800	036918	4.5L / 4.75 Qt.	15W-40 API CI-4, CI-4 Plus, CJ-4
44C Four	4	Current	23-7800	036918	4.5L / 4.75 Qt.	15W-40 API CI-4, CI-4 Plus, CJ-4
55A Four	4	1995 - 2002	23-7825	035828	5.0L / 5.28 Qt.	SAE 30 CF
55B Four	4	2002 - 2005	23-7800	036918	7.6L / 8.0 Qt.	SAE 30 CF
55C Four	4	2005 - Current	23-7800	036918	7.6L / 8.0 Qt.	SAE 30 CF
55D Four	4	Current	23-7800	036918	7.6L / 8.0 Qt.	SAE 30 CF
63B Four	4	1990 - 1994	23-7825	035828	11.3L / 12 Qt.	15W-40 API CI-4, CI-4 Plus, CJ-4
63C Four	4	1994 - 2000	23-7825	035828	11.3L / 12 Qt.	15W-40 API CI-4, CI-4 Plus, CJ-4
63D Four	4	2001 - 2003	23-7825	035828	5.0L / 5.28 Qt.	15W-40 API CI-4, CI-4 Plus, CJ-4
64A Four	4	2003 - Current	23-7826	040154	6.15L / 6.5 Qt.	15W-40 API CI-4, CI-4 Plus, CJ-4
71B Four	4	1991 - 1994	23-7825	035828	11.3L / 12 Qt.	15W-40 API CI-4, CI-4 Plus, CJ-4
71C Four	4	1994 - Current	23-7826	040154	11.3L / 12 Qt.	15W-40 API CI-4, CI-4 Plus, CJ-4
82B Four	4	1991 - Current	23-7826	040154	11.3L / 12 Qt.	15W-40 API CI-4, CI-4 Plus, CJ-4
90A Four	4	1999 - Current	23-7826	040154	6.0L / 6.3 Qt.	15W-40 API CI-4, CI-4 Plus, CJ-4
W27	4	1980 - 1984	23-7800	036918	3.78L / 4.0 Qt.	SAE 10W-30
W27A	4	1984 - 1988	23-7800	036918	3.78L / 4.0 Qt.	SAE 10W-30
W33	4	1980 - 1984	23-7825	035828	3.78L / 4.0 Qt.	SAE 10W-30
W33A	4	1984 - 1988	23-7825	035828	3.78L / 4.0 Qt.	SAE 10W-30
W41G	4	1986 - 1993	23-7800	036918	-	-
W46	4	1985 - 1990	23-7825	035828	6.15L / 6.5 Qt.	SAE 10W-30
W70	4	1982 - 1991	23-7826	040154	6.15L / 6.5 Qt.	SAE 10W-30
W70G	4	1988 - 2001	23-7800	036918	-	-
W70GA	4	2003 - Current	23-7800	036918	-	-
108B Six	6	1991 - 1994	23-7826	040154	11.3L / 12 Qt.	15W-40 API CI-4, CI-4 Plus, CJ-4
108C Six	6	1994 - Current	23-7826	040154	11.3L / 12 Qt.	15W-40 API CI-4, CI-4 Plus, CJ-4
W100	6	1982 - 1991	23-7826	040154	11.3L / 12 Qt.	-

Westerbeke

Model	Cylinders	Year	Oil Filter	Replaces	Crankcase Capacity	Recommended Oil
Gen Set (All models are 60hz. USA / North American)						
10.0 BTD	3	1984 - 2000	23-7800	036918	3.3 Qt.	15W-40 API CI-4, CI-4 Plus, CJ-4
10.0 BTDA	3	2000 - Current	23-7800	036918	3.8L / 4.0 Qt.	15W-40 API CI-4, CI-4 Plus, CJ-4
10.0 EDT D-NET	3	-	23-7800	036918	3.8L / 4.0 Qt.	15W-40 API CI-4, CI-4 Plus, CJ-4
10.0 SBEG Low-CO	4	2005 - Current	23-7800	036918	3.5 Qt.	SAE 10W-30
11.0 TWG	4	1984 - 1987	23-7800	036918	-	SAE 10W-30
11.0 WMD	4	1980 - 1987	23-7800	036918	6.15 Qt.	15W-40 API CI-4, CI-4 Plus, CJ-4
11.5 BTD	3	-	23-7800	036918	4.7L / 5.0 Qt.	15W-40 API CI-4, CI-4 Plus, CJ-4
11.5 EDT D-NET	3	-	23-7800	036918	4.7L / 5.0 Qt.	15W-40 API CI-4, CI-4 Plus, CJ-4
12.06 EDT D-NET	3	-	23-7800	036918	4.7L / 5.0 Qt.	15W-40 API CI-4, CI-4 Plus, CJ-4
12.5 BEG	4	2002 - Current	23-7800	036918	3.5 Qt.	SAE 10W-30
12.5 BTDB	4	-	23-7800	036918	5.2L / 5.5 Qt.	15W-40 API CI-4, CI-4 Plus, CJ-4
12.5 BTG	4	1987 - 2001	23-7800	036918	3.8L / 4.0 Qt.	SAE 10W-30
12.5 BTGA	4	2001 - 2002	23-7800	036918	-	SAE 10W-30
12.5 EDT D-NET	4	-	23-7800	036918	5.2L / 5.5 Qt.	15W-40 API CI-4, CI-4 Plus, CJ-4
12.5 SBEG Low-CO	4	2005 - Current	23-7800	036918	3.5 Qt.	SAE 10W-30
12.6 BTD	3	2002 - Current	23-7800	036918	3.8L / 4.0 Qt.	15W-40 API CI-4, CI-4 Plus, CJ-4
14.0 SBEG Low-CO	4	2005 - Current	23-7800	036918	3.5 Qt.	SAE 10W-30
15.0 BEG	4	2002 - Current	23-7800	036918	3.5 Qt.	SAE 10W-30
15.0 BTDC	4	2000 - Current	23-7800	036918	5.2L / 5.5 Qt.	15W-40 API CI-4, CI-4 Plus, CJ-4
15.0 BTG	4	1987 - 2001	23-7800	036918	3.8L / 4.0 Qt.	SAE 10W-30
15.0 EDT D-NET	4	-	23-7800	036918	5.2L / 5.5 Qt.	15W-40 API CI-4, CI-4 Plus, CJ-4
20.0 BEG	4	1995 - 2004	23-7800	036918	4.5 Qt.	SAE 10W-30

All listed oil capacities are approximate amounts only and may or may not include the oil filter capacity. ALWAYS follow proper crankcase drain and fill procedures. Check engine dipstick for proper crankcase oil level.

OIL FILTER QUICK-REFERENCE GUIDE



Westerbeke - Continued

Model	Cylinders	Year	Oil Filter	Replaces	Crankcase Capacity	Recommended Oil
20.0 BEGA	4	2004 - Current	23-7800	036918	-	SAE 10W-30
20.0 SBEG Low-CO	4	2005 - Current	23-7800	036918	4.5 Qt.	SAE 10W-30
20.0 SBEGA Low-CO	4	-	23-7800	036918	-	SAE 10W-30
22.5 SBEG Low-CO	4	2005 - Current	23-7800	036918	-	SAE 10W-30
22.5 SBEGA Low-CO	4	-	23-7800	036918	4.5 Qt.	SAE 10W-30
25.0 BEG	4	1999 - 2004	23-7800	036918	4.5 Qt.	SAE 10W-30
3.0 WMD	2	1982 - 1988	23-7800	036918	2.0 Qt.	15W-40 API CI-4, CI-4 Plus, CJ-4
4.0 BCD (60 Hz.) ONLY	3	2002 - Current	23-7800	036918	3.05L / 3.2 Qt.	15W-40 API CI-4, CI-4 Plus, CJ-4
4.0 BCDA 60Hz. ONLY	3	2008 - Current	23-7800	036918	3.05L / 3.2 Qt.	15W-40 API CI-4, CI-4 Plus, CJ-4
4.4 BCD	2	1986 - 1989	23-7800	036918	2.4L / 2.5 Qt.	15W-40 API CI-4, CI-4 Plus, CJ-4
4.4 WMD	2	1980 - 1986	23-7800	036918	2.4L / 2.5 Qt.	15W-40 API CI-4, CI-4 Plus, CJ-4
4.5 BCG	3	1988 - 1997	23-7800	036918	2.8L / 3.0 Qt.	SAE 10W-30
4.5 BCGA	3	1997	23-7800	036918	2.4L / 2.5 Qt.	SAE 10W-30
4.5 BCGB	3	1999 - 2002	23-7800	036918	2.4L / 2.5 Qt.	SAE 10W-30
4.5 BCGTC	3	1997 - 2002	23-7800	036918	2.6L / 2.7 Qt.	SAE 10W-30
4.5 BCGTE	3	1997 - 2001	23-7800	036918	2.6L / 2.7 Qt.	SAE 10W-30
5.0 BCD	3	1989 - 1996	23-7800	036918	3.0L / 3.2 Qt.	15W-40 API CI-4, CI-4 Plus, CJ-4
5.0 BCDA	3	1996	23-7800	036918	3.0L / 3.2 Qt.	15W-40 API CI-4, CI-4 Plus, CJ-4
5.0 BCDB(60Hz)	3	1996 - Current	23-7800	036918	3.0L / 3.2 Qt.	15W-40 API CI-4, CI-4 Plus, CJ-4
5.0 BCG low profile	3	2002 - Current	23-7800	036918	2.4L / 2.5 Qt.	SAE 40 SJ
5.0 BCGA	3	2002	23-7800	036918	2.4L / 2.5 Qt.	SAE 40 SJ
5.0 SBCG Low-CO	3	2005 - Current	23-7800	036918	2.8L / 3.0 Qt.	SAE 40 SJ
5.5 BCD	3	-	23-7800	036918	3.0L / 3.2 Qt.	15W-40 API CI-4, CI-4 Plus, CJ-4
5.5 EDC D-NET	3	-	23-7800	036918	3.6L / 3.8 Qt.	15W-40 API CI-4, CI-4 Plus, CJ-4
6.0 BCD	3	1986 - 1989	23-7800	036918	3.0L / 3.2 Qt.	15W-40 API CI-4, CI-4 Plus, CJ-4
6.0 WMD	3	-	23-7800	036918	3.0L / 3.2 Qt.	15W-40 API CI-4, CI-4 Plus, CJ-4
6.5 SBCG Low-CO	3	2005 - Current	23-7800	036918	2.8L / 3.0 Qt.	SAE 40 SJ
6.5 TWG	4	1984 - 1987	23-7800	036918	3.0L / 3.2 Qt.	SAE 10W-30
7.0 BCG / BCGA	3	1989 - 1997	23-7800	036918	2.8L / 3.0 Qt.	SAE 10W-30
7.0 BCGB	3	1999 - 2002	23-7800	036918	2.4L / 2.5 Qt.	SAE 10W-30
7.0 BCGC Low Profile	3	2002 - 2004	23-7800	036918	2.4L / 2.5 Qt.	SAE 40 SJ
7.0 BCGD Low Profile	3	2004 - Current	23-7800	036918	2.4L / 2.5 Qt.	SAE 40 SJ
7.2 BCGTC	3	1997 - 2002	23-7800	036918	2.6L / 2.7 Qt.	SAE 10W-30
7.2 BCGTE	3	1997 - 2001	23-7800	036918	2.6L / 2.7 Qt.	SAE 10W-30
7.6 BTD	3	1993 - Current	23-7800	036918	3.6L / 3.8 Qt.	15W-40 API CI-4, CI-4 Plus, CJ-4
7.6 EDT D-NET	3	-	23-7800	036918	3.6L / 3.8 Qt.	15W-40 API CI-4, CI-4 Plus, CJ-4
7.7 WMD	3	1980 - 1984	23-7800	036918	3.0L / 3.2 Qt.	15W-40 API CI-4, CI-4 Plus, CJ-4
8.0 BCDT	2	2002 - 2004	23-7800	036918	2.9L / 3.1 Qt.	15W-40 API CI-4, CI-4 Plus, CJ-4
8.0 BTD	3	1984 - 2000	23-7800	036918	3.0L / 3.2 Qt.	15W-40 API CI-4, CI-4 Plus, CJ-4
8.0 BTDA	3	2000 - Current	23-7800	036918	3.0L / 3.2 Qt.	15W-40 API CI-4, CI-4 Plus, CJ-4
8.0 EDT D-NET	3	-	23-7800	036918	3.8L / 4.0 Qt.	15W-40 API CI-4, CI-4 Plus, CJ-4
8.0 SGEG Low-CO	4	2005 - Current	23-7800	036918	3.3L / 3.5 Qt.	SAE 10W-30
8.0 TWG	4	1983 - 1987	23-7800	036918	3.0L / 3.2 Qt.	SAE 10W-30
8.0 WMD	3	1980 - 1984	23-7800	036918	3.0L / 3.2 Qt.	15W-40 API CI-4, CI-4 Plus, CJ-4
8.5 BTG	4	1987 - 1993	23-7800	036918	3.7L / 3.9 Qt.	SAE 10W-30
8.5 BTGA	4	1993 - 2002	23-7800	036918	3.8L / 4.0 Qt.	SAE 10W-30
9.6 BCGTC	3	1997 - 2002	23-7800	036918	2.6L / 2.7 Qt.	SAE 10W-30
9.6 BCGTE	3	-	23-7800	036918	2.6L / 2.7 Qt.	SAE 10W-30
11.0 BTD	4	1987 - 2001	23-7825	035828	4.0L / 4.2 Qt.	15W-40 API CI-4, CI-4 Plus, CJ-4
12.5 BTDA	4	1988 - 2000	23-7825	035828	4.5L / 4.7 Qt.	15W-40 API CI-4, CI-4 Plus, CJ-4
12.5 WMD	4	1980 - 1987	23-7825	035828	4.5L / 4.7 Qt.	15W-40 API CI-4, CI-4 Plus, CJ-4
15.0 BTD	4	1987 - 1990	23-7825	035828	6.6L / 7.0 Qt.	15W-40 API CI-4, CI-4 Plus, CJ-4
15.0 BTDA	4	1990 - 1994	23-7825	035828	5.0L / 5.3 Qt.	15W-40 API CI-4, CI-4 Plus, CJ-4
15.0 BTDB	4	1994 - 2000	23-7825	035828	5.0L / 5.3 Qt.	15W-40 API CI-4, CI-4 Plus, CJ-4
20.0 BED	4	1990 - 1995	23-7825	035828	6.15L / 6.5 Qt.	15W-40 API CI-4, CI-4 Plus, CJ-4

All listed oil capacities are approximate amounts only and may or may not include the oil filter capacity. ALWAYS follow proper crankcase drain and fill procedures. Check engine dipstick for proper crankcase oil level.

Continued Next Page

Westerbeke - Continued

Model	Cylinders	Year	Oil Filter	Replaces	Crankcase Capacity	Recommended Oil
25.0 BED PTO	4	1992 - Current	23-7826	040154	6.15L / 6.5 Qt.	15W-40 API CI-4, CI-4 Plus, CJ-4
25.0 WTA	4	1982 - 1985	23-7826	040154	6.0L / 6.3 Qt.	15W-40 API CI-4, CI-4 Plus, CJ-4
32.0 BED	6	1993 - 1994	23-7826	040154	Refer to Owners Manual	15W-40 API CI-4, CI-4 Plus, CJ-4
32.0 BEDA	4	1994 - Current	23-7826	040154	6.0L / 6.3 Qt.	15W-40 API CI-4, CI-4 Plus, CJ-4
32.0 BEDB	6	1994	23-7826	040154	11.3L / 12 Qt.	15W-40 API CI-4, CI-4 Plus, CJ-4
20.0 BEDA	4	1995 - Current	23-7826	040154	6.15L / 6.5 Qt.	15W-40 API CI-4, CI-4 Plus, CJ-4
25.0 BED	4	1992 - Current	23-7826	040154	6.15L / 6.5 Qt.	15W-40 API CI-4, CI-4 Plus, CJ-4

Yamaha

Model	Year	Oil Filter	Replaces	Crankcase Capacity	Recommended Oil
F2.5	2003 - 2011	----		0.35 L / 0.35 Qt.	10W-30 FC-W
F4	1999 - 2011	----		0.50 L / 0.53 Qt.	10W-30 FC-W
F6, F/T8	2001 - 2011	----		0.80 L / 0.84 Qt.	10W-30 FC-W
T9.9 (Model 6G8)	1991 - 04/2005	18-7901	6G8-13440-00-00	1.0 L / 1.06 Qt.	10W-30 FC-W
F9.9 (Model 6G8)	1990 - 04/2005	18-7901	6G8-13440-00-00	1.0 L / 1.06 Qt.	10W-30 FC-W
T9.9 (Model 66R)	2005 - 04/2006	18-7911-1	5GH-13440-00-00	0.80 L / 0.84 Qt.	10W-30 FC-W
F9.9 (Model 66R)	2005 - 04/2006	18-7911-1	5GH-13440-00-00	0.80 L / 0.84 Qt.	10W-30 FC-W
F15	1998 - 1999	18-7902	3FV-13440-10-00	1.0 L / 1.06 Qt.	10W-30 FC-W
F15	2000 - 2006	18-7911-1	5GH-13440-00-00	1.8 L / 1.9 Qt.	10W-30 FC-W
F15C	2007 - 2012	18-8700	5GH-13440-20-00	1.8 L / 1.9 Qt.	10W-30 FC-W
F20	2007 - 2012	18-8700	5GH-13440-20-00	1.8 L / 1.9 Qt.	10W-30 FC-W
F25	1998 - 1999	18-7902	3FV-13440-10-00	1.7 L / 1.8 Qt.	10W-30 FC-W
F25 / T25	2000 - 04/2006	18-7911-1	5GH-13440-00-00	1.7 L / 1.8 Qt.	10W-30 FC-W
F25	2009 - Current	18-8700	5GH-13440-20-00	1.7 L / 1.8 Qt.	10W-30 FC-W
F30	2001 - 2006	18-7911-1	5GH-13440-00-00	2.0 L / 2.1 Qt.	10W-30 FC-W
F40	1999 - 2000	18-7902	3FV-13440-10-00	2.0 L / 2.1 Qt.	10W-30 FC-W
F40 / F40B (International)	2001 - 2008	18-7911-1	5GH-13440-00-00	2.0 L / 2.1 Qt.	10W-30 FC-W
F40A	2001 - Current	18-8700	5GH-13440-20-00	2.0 L / 2.1 Qt.	10W-30 FC-W
T50	1996 - 1999	18-7902	3FV-13440-10-00	2.0 L / 2.1 Qt.	10W-30 FC-W
T50	2000 - 2004	18-7911-1	5GH-13440-00-00	2.0 L / 2.1 Qt.	10W-30 FC-W
T50	2005 - Current	18-8700	5GH-13440-20-00	2.0 L / 2.1 Qt.	10W-30 FC-W
F50	1995 - 1999	18-7902	3FV-13440-10-00	2.0 L / 2.1 Qt.	10W-30 FC-W
F50	1999 - 2004	18-7911-1	5GH-13440-00-00	2.0 L / 2.1 Qt.	10W-30 FC-W
F50	2005 - Current	18-8700	5GH-13440-20-00	2.0 L / 2.1 Qt.	10W-30 FC-W
T60	1999 - 2004	18-7911-1	5GH-13440-00-00	2.0 L / 2.1 Qt.	10W-30 FC-W
T60	2005 - Current	18-8700	5GH-13440-20-00	2.0 L / 2.1 Qt.	10W-30 FC-W
F60	1999 - 2004	18-7911-1	5GH-13440-00-00	2.0 L / 2.1 Qt.	10W-30 FC-W
F60	2005 - Current	18-8700	5GH-13440-20-00	2.0 L / 2.1 Qt.	10W-30 FC-W
F70	All Years	18-8700	5GH-13440-20-00	2.0 L / 2.1 Qt.	10W-30 FC-W
F75	All Years	18-7911-1	5GH-13440-00-00	4.3 L / 4.5 Qt.	10W-30 FC-W
F80	1999	18-7902	3FV-13440-10-00	4.3 L / 4.5 Qt.	10W-30 FC-W
F80	2000 - Current	18-7911-1	5GH-13440-00-00	4.3 L / 4.5 Qt.	10W-30 FC-W
F90	All Years	18-7911-1	5GH-13440-00-00	4.3 L / 4.5 Qt.	10W-30 FC-W
F100	1999	18-7902	3FV-13440-10-00	4.3 L / 4.5 Qt.	10W-30 FC-W
F100	2000 - Current	18-7911-1	5GH-13440-00-00	4.3 L / 4.5 Qt.	10W-30 FC-W
F115	All Years	18-7911-1	5GH-13440-00-00	4.3 L / 4.5 Qt.	10W-30 FC-W
F150	2004 - Current	18-7906-1	69J-13440-01-00	5.4 L / 5.7 Qt.	10W-30 FC-W
F200 (3.3L)	All Years	18-7906-1	69J-13440-01-00	5.8 L / 6.13 Qt.	10W-30 FC-W
F200 (4.2L SHO)	2009 - Current	18-7954	N26-13440-00-00	7.1L / 7.5 Qt.	5W-30 FC-W Full Synthetic
F225 (3.3L)	All Years	18-7906-1	69J-13440-01-00	5.8 L / 6.13 Qt.	10W-30 FC-W
F225 (4.2L)	2009 - Current	18-7954	N26-13440-00-00	7.1L / 7.5 Qt.	10W-30 FC-W
F250 (3.3L)	All Years	18-7906-1	69J-13440-01-00	5.8 L / 6.13 Qt.	10W-30 FC-W
F250 (4.2L)	2009 - Current	18-7954	N26-13440-00-00	7.1L / 7.5 Qt.	10W-30 FC-W
F300 (V8)	2007 - Current	18-7954	N26-13440-00-00	8.0 L / 8.45 Qt.	10W-30 FC-W
F350 (V8)	2007 - Current	18-7954	N26-13440-00-00	8.0 L / 8.45 Qt.	10W-30 FC-W

All listed oil capacities are approximate amounts only and may or may not include the oil filter capacity.
ALWAYS follow proper crankcase drain and fill procedures. Check engine dipstick for proper crankcase oil level.

OIL FILTER QUICK-REFERENCE GUIDE



Yanmar

Model	Cylinders	Year	Oil Filter	Replaces	Crankcase	Recommended Oil
1GM	1	1980 - 1983	18-7910 / 18-7910-1	124450-35100 119660-35150 119305-35151	1.6 Qt.	SAE 15W-40 CI-4 Refer to owners manual
1GM10	1	1983 - 2009	18-7910 / 18-7910-1	124450-35100 119660-35150 119305-35151	1.6 Qt.	SAE 15W-40 CI-4 Refer to owners manual
2GM	2	1980 - 1983	18-7910 / 18-7910-1	124450-35100 119660-35150 119305-35151	2.1 Qt.	SAE 15W-40 CI-4 Refer to owners manual
2GM20	2	1983 - 2005	18-7910 / 18-7910-1	124450-35100 119660-35150 119305-35151	2.1 Qt.	SAE 15W-40 CI-4 Refer to owners manual
2GM20-YEU (Serial No. Starts w/ E)	2	1997 - Current	18-7910 / 18-7910-1	119660-35150 119305-35151	2.1 Qt.	SAE 15W-40 CI-4 Refer to owners manual
2GM20F	2	1983 - 2005	18-7910 / 18-7910-1	124450-35100 119660-35150 119305-35151	2.1 Qt.	SAE 15W-40 CI-4 Refer to owners manual
2GMF	2	1980 - 1983	18-7910 / 18-7910-1	124450-35100 119660-35150 119305-35151	2.1 Qt.	SAE 15W-40 CI-4 Refer to owners manual
2QM15	2	1977 - 1980	18-7910 / 18-7910-1	124450-35100 119660-35150 119305-35151	2.1 Qt.	SAE 15W-40 CI-4 Refer to owners manual
2QM20 (Serial #81181 and Higher)	2	1975 - 1980	18-7917	124550-35110 124085-35113	2.1 Qt.	SAE 15W-40 CI-4 Refer to owners manual
2YM15	2	2004 - Current	18-7910 / 18-7910-1	119305-35151	2.1 Qt.	SAE 15W-40 CI-4 Refer to owners manual
3GM30	3	1983 - Current	18-7910 / 18-7910-1	124450-35100 119660-35150 119305-35151	2.7 Qt.	SAE 15W-40 CI-4 Refer to owners manual
3GM30-YEU (Serial No. Starts w/ E)	3	1997 - Current	18-7910 / 18-7910-1	119660-35150 119305-35151	2.7 Qt.	SAE 15W-40 CI-4 Refer to owners manual
3GM30F	3	1983 - 2005	18-7910 / 18-7910-1	124450-35100 119660-35150 119305-35151	2.7 Qt.	SAE 15W-40 CI-4 Refer to owners manual
3GM	3	1980 - 1983	18-7910 / 18-7910-1	124450-35100 119660-35150 119305-35151	2.7 Qt.	SAE 15W-40 CI-4 Refer to owners manual
3GMD	3	1980 - 1983	18-7910 / 18-7910-1	119660-35150 119305-35151	2.7 Qt.	SAE 15W-40 CI-4 Refer to owners manual
3GMF	3	1980 - 1983	18-7910 / 18-7910-1	124450-35100 119660-35150 119305-35151	2.7 Qt.	SAE 15W-40 CI-4 Refer to owners manual
3HM	3	1980 - 1983	18-7917	124550-35110 124085-35113		Refer to owners manual Refer to owners manual
3HM35	3	1983 - 1992	18-7917	124550-35110 124085-35113		SAE 15W-40 CI-4 Refer to owners manual
3HM35F	3	1983 - 1992	18-7917	124550-35110 124085-35113		SAE 15W-40 CI-4 Refer to owners manual
3HMF	3	1980 - 1983	18-7917	124550-35110 124085-35113		SAE 15W-40 CI-4 Refer to owners manual
3JH2TBE	3	1991-1999	18-7910 / 18-7910-1	119305-35151		SAE 15W-40 CI-4 Refer to owners manual
3JH2BE	3	1989-1999	18-7910 / 18-7910-1	119305-35151		SAE 15W-40 CI-4 Refer to owners manual
3JH2	3	1992-1999	18-7910 / 18-7910-1	119305-35151		SAE 15W-40 CI-4 Refer to owners manual
3JH3	3	1999 - 2004	18-7910 / 18-7910-1	119305-35150 119305-35151		SAE 15W-40 CI-4 Refer to owners manual

All listed oil capacities are approximate amounts only and may or may not include the oil filter capacity.
ALWAYS follow proper crankcase drain and fill procedures. Check engine dipstick for proper crankcase oil level.

Continued Next Page

Yanmar - Continued

Model	Cylinders	Year	Oil Filter	Replaces	Crankcase	Recommended Oil
3JH3E-YEU	3	2004 - Current	18-7910 / 18-7910-1	119305-35150 119305-35151	5.2 Qt.	SAE 15W-40 CI-4 Refer to owners manual
3JH4E (40hp.)	3	2004 - Current	18-7910 / 18-7910-1	119305-35150 119305-35151		SAE 15W-40 CI-4 Refer to owners manual
3QM30	3	1976 - 1980	18-7917	124550-35110 124085-35113		SAE 15W-40 CI-4 Refer to owners manual
3QM30F	3	1976 - 1980	18-7917	124550-35110 124085-35113		SAE 15W-40 CI-4 Refer to owners manual
3YM20	3	2004 - Current	18-7910 / 18-7910-1	119305-35151	2.6 Qt.	SAE 15W-40 CI-4 Refer to owners manual
3YM30	3	2004 - Current	18-7910 / 18-7910-1	119305-35151	2.6 Qt.	SAE 15W-40 CI-4 Refer to owners manual



All listed oil capacities are approximate amounts only and may or may not include the oil filter capacity. ALWAYS follow proper crankcase drain and fill procedures. Check engine dipstick for proper crankcase oil level.

Alpha Cross Reference

AC

PF1250	18-7758
PF1267	18-0034
PF454	18-7824
PF2	18-7875
PF1218	18-7876
PF13	18-7878-1
PF857F	18-7880
PF2210	18-7884
PF939	18-7886
PF881F	18-7887
SPF53	18-7897
PF911F	18-7899
PF1127	18-7910-1
PF1237*	18-7911-1
PF1237*	18-7913
PF2057	18-7914
PF1233	18-7916
PF60	18-7925
PF2207	18-7926
PF2203	18-7927
PF2257	18-8003
PF1127	23-7800

* Refer to Engine Mfg. Section

BALDWIN

B131	23-7801
B134	18-7871
B1400*	18-7902
B1400*	18-7911-1
B1400*	18-7913
B1402*	18-7909
B1402*	18-7914
B161-S	23-7842
B163	23-7841
B167	18-7926
B168	18-7917
B178	18-7925
B179*	18-7910-1
B179*	23-7800
B179*	23-7824
B2	18-7875
B202	23-7825
B233*	18-7878-1
B233*	23-7840
B33*	18-7916
B33*	23-7821
B35-S	18-7879
B360	18-7824
B37*	18-7895
B37*	18-7896
B43-S	18-7974
B6	18-7876
B7165	18-7884
B7333	18-7897
B75*	18-0032
B75*	18-7927
B76	18-7880
B7685	18-0034
B76-SS	18-0033
BT216	18-7886
BT223	18-7915-1
BT237	18-7887
P7417	18-8003

* Refer to Engine Mfg. Section

BRP

See Evinrude / Johnson / OMC

CATERPILLAR

1R-0658	18-7880
---------	---------

CHRYSLER INBOARD

1851658	18-7885
3549957	18-7878-1
L-1108	18-7878-1
L-19	18-7878-1
L-319	18-7879

CRUSADER

22679	18-7875
201101	18-7824
201104	18-7876

DETROIT DIESEL

25010495	18-7899
----------	---------

EVINRUDE / JOHNSON / OMC

173232	18-7824
173233	18-7876
173834	18-7879
434839	18-7916
502901	18-7876
502902	18-7824
502903	18-7879
502904	18-7878-1
763364	18-7903
778885	18-7915-1
778886	18-7896
778887	18-7897
5031411	18-7915-1
5033102	18-7903
5033539	18-7896
5033919	18-7897
5035703	18-7895

FRAM

CH9954	18-8003
P9407	18-0034
PH10809	23-7823
PH13	18-7876
PH16*	18-7878-1
PH16*	23-7841
PH2821A	18-7886
PH2870A	18-7925
PH2921	23-7825
PH2951*	18-7897
PH2951*	23-7801
PH30	18-7824
PH3306A	18-7926
PH3387A	18-7974
PH3545*	18-0032
PH3545*	18-7927
PH3593A*	18-7910-1
PH3593A*	23-7800
PH3612	18-7899
PH3614	18-7884
PH3766	18-7871
PH3980	18-7879
PH4386*	18-7895
PH4386*	18-7896
PH4967*	18-7897
PH4967*	18-7906-1
PH4967*	18-7916
PH4967*	23-7821
PH49A*	18-0033
PH49A*	18-7880
PH5	18-7876
PH5046	18-7917
PH6017A*	18-7902
PH6017A*	18-7909
PH6017A*	18-7911-1
PH6017A*	18-7913
PH6017A*	18-8700

PH6811	23-7842
PH7317	18-7914
PH7328	23-7841
PH7575*	18-7884
PH7575*	18-7915-1
PH8842	18-0033
PH8A	18-7875
PH9688	23-7842
PH977A	18-7887

* Refer to Engine Mfg. Section

HONDA

15400-PFB-007	18-7911-1
15400-PFB-014	18-7913
15400-PLM-A01PE	18-7909
15400-POH-305PE	18-7909
15400-POH-305PE	18-7909
15400-ZJ1-004	18-7909

INDMAR

501001	18-7824
50-1101	18-7824

KOHLER

229678	23-7822
252834	23-7824
267714	23-7823
279449	23-7820
326817	23-7803
359771	23-7821
GM47465	23-7824

LUBER-FINER

LFP2234	18-7926
LFP2274	18-7824
LFP3191	18-0033
LFP3191	18-7880
LFP5522	18-7917
LFP6007	18-0032
LFP8642	18-0034
LFP911	18-7899
P3986	18-8003
PH1218	18-7876
PH208	18-7910-1
PH253	18-7878-1
PH2801	23-7825
PH2808	23-7800
PH2808	23-7822
PH2808	23-7824
PH2835	18-7884
PH2835	18-7915-1
PH2840	18-7895
PH2840	18-7896
PH2840	18-7897
PH2840	18-7916
PH2840	23-7821
PH2867	18-7914
PH2876	18-7913
PH299	18-7887
PH4403	18-7886
PH47	18-7974
PH51A	18-7879
PH561	18-7925
PH7028	18-7911-1
PH820	18-7758
PH8A	18-7875

MALLORY

9-57800	18-7913
9-57801	18-7824
9-57802	18-7875
9-57803	18-7879

All listed oil capacities are approximate amounts only and may or may not include the oil filter capacity. ALWAYS follow proper crankcase drain and fill procedures. Check engine dipstick for proper crankcase oil level.

Alpha Cross Reference

MALLORY - Continued

9-57804	18-7911-1
9-57806	18-7878-1
9-57807	18-7903
9-57808	18-7906-1
9-57810	18-7910-1
9-57811	18-7876
9-57813	18-7916
9-57814	18-7896
9-57815	18-7897
9-57816	18-7918
9-57817	18-7915-1
9-57818	18-7895
9-57819	18-7905
9-57820	18-8003
9-57821	18-7921
9-57822	18-7758
9-57902	18-7871
9-57905	18-7926
9-57908	18-7974
9-57910	18-7880
9-57911	18-7884

MERCURY / QUICKSILVER

14957	18-7876
32717	18-7876
38463	18-7878-1
41815	18-7879
46692	18-7878-1
52731	18-7876
54111	18-7824
56874	18-7875
60565	18-7875
803470	18-7878-1
35-16595T1	18-7876
35-802884Q	18-7879
35-802885	18-7824
35-802885T	18-7824
35-802886Q	18-7875
35-805809	18-7871
35-822626Q03	18-7913
35-822626Q04	18-7914
35-822626Q1	18-7913
35-822626Q15	18-7906-1
35-822626Q2	18-7914
35-866340K01	18-7824
35-866340Q02	18-7824
35-866340Q03	18-7824
35-877761K01	18-7758
35-877761Q01	18-7758
35-877767K01	18-7921
35-877769K01	18-7918
35-883701K01	18-7918
35-883702Q	18-7879
35-896549T	18-7921
803470Q	18-7878-1

NAPA

1036	18-7879
1040	18-7974
1061	18-7876
1064	23-7822
1068	23-7840
1069	18-7824
1084	23-7841
1307	18-7878-1
1334	18-7910-1
1342	18-7925
1344	23-7842
1347	18-7917
1348	18-7915-1
1358	18-8700

NAPA - Continued

1365	18-7911-1
1394	18-7916
1660	18-0034
1773	18-7887
1791	18-0033
1798	18-0032
1806	18-7886
1820	18-7926
1970	18-7899
6644	23-7825
7000	18-7906-1
7145	18-7896
7186	18-8003
21036	18-7879
21061	18-7876
21069	18-7824
21334	23-7800
21342	18-7925
21348	18-7884
21358	18-7902
21394	23-7801
21515	18-7875
21521	18-7878-1
27145	18-7896
31358	18-8700
31515	18-7875

NISSAN / TOHATSU

3R0076150M	18-7911-1
------------	-----------

NORTHERN LIGHTS

140516190	23-7801
-----------	---------

ONAN

122-0185	23-7841
122-0810	23-7840
185-5835	23-7842
185-7444	23-7804

PCM / PLEASURECRAFT

R077001	18-7875
R077022	18-7824

PERKINS

2654347	18-7887
2654403	18-7886
2654407	18-7887

SUZUKI

16510-05240	18-7903
16510-61A20-MHL	18-7896
16510-82703	18-7897
16510-87J00	18-7915-1
16510-93J00	18-7895
16510-96J00	18-7905

UNIVERSAL

299381	18-7884
--------	---------

VOLVO PENTA

423135	18-7926
430143	18-7878-1
466634	18-7880
477556	18-0034
478736	18-0033
834337	18-7884
835440	18-7824
841750	18-7879
847741	18-0032
1266286	18-7878-1
3517857	18-7878-1

VOLVO PENTA - Continued

3582732	18-0035
3582733	18-0036
3827069	18-7974
3850559	18-7876
3852412	18-7824
4785974	18-7926
8692305	18-8003

WESTERBEKE

21235	18-7925
30220	18-7910-1
35595	23-7801
35828	23-7825
36918	23-7800
36920	23-7800
40154	23-7826
48076	23-7802

WIX

46644	23-7825
51036	18-7879
51040	18-7974
51061	18-7876
51064	23-7822
51068	23-7840
51069	18-7824
51084	23-7841
51215	23-7803
51307	18-7878-1
51334	18-7910-1
51342	18-7925
51344	23-7842
51347	18-7917
51348	18-7915-1
51358	18-7911-1
51365	18-7913
51365	23-7804
51394	18-7916
51452	18-7875
51459	18-7887
51630	18-7897
51660	18-0034
51791	18-0033
51798	18-0032
51806	18-7886
51820	18-7926
57000	18-7906-1
57145	18-7895
57145	18-7896
57186	18-8003
57356	18-7909
51742MP	18-7871

YAMAHA

3FV-13440-00-00	18-7902
5GH-13440-00-00	18-7911-1
5GH-13440-20-00	18-8700
69J-13440-01-00	18-7906-1
6G8-13440-00-00	18-7901
N26-13440-00-00	18-7954
YSC-10231-20-0C	18-7824
YSC-13231-20-0C	18-7824

YANMAR

119305-35151	18-7910-1
119660-35150	18-7910-1
124450-35100	18-7910-1
124550-35110	18-7917
171056-35111	18-7917

All listed oil capacities are approximate amounts only and may or may not include the oil filter capacity. ALWAYS follow proper crankcase drain and fill procedures. Check engine dipstick for proper crankcase oil level.

