



STAINLESS STEEL

marine accessories
industrial equipment
architecture · fasteners



2014/15



Marinetech

Herzlich willkommen bei einem der größten Anbieter Europas für rostfreies Boots- und Yachtzubehör und Edelstahlverbindungselemente.

Marinetech ist heute einer der größten Anbieter Europas für rostfreies Boots- und Yachtzubehör und Edelstahlverbindungselemente.

Aktuell beschäftigt das Unternehmen 35 Mitarbeiter. Auf 2000 Paletten- und 15000 Schüttenplätzen werden ständig über 4000 verschiedene Artikel vorgehalten. Hinzu kommen noch 25000 Befestigungsartikel aus dem externen Logistikzentrum.

Marinetech

Welcome to one of the largest providers of stainless steel boat and yacht accessories and stainless steel fasteners in Europe.

Today, Marinetech is one of the largest providers of stainless steel boat and yacht accessories and stainless steel fasteners in Europe.

The company currently employs 35 people. More than 4000 different items are continuously in stock on an area with space for 2000 pallets and 15000 chutes. Furthermore, there are 25000 fastening items in store at the external logistics centre.



Marinetech im Internet

Unser Service für Sie:

- alle Informationen
- alle Produkte
- alle News

30000 Produkte finden Sie in unserem neuen Onlinekatalog mit der Möglichkeit eigene Merkzettel zu erstellen und vieles mehr. In unserem Servicebereich finden Sie den kompletten Katalog zum herunterladen sowie einen FTP-Service.

Und wir halten Sie ständig auf dem Laufenden in unserem Newsbereich mit Neuprodukten, Sonderaktionen und Wissenswertem rund um Marinetech.

Wir freuen uns auf Ihren Besuch...

Marinetech online

Our service

- information
- products
- news

In our new online catalogue you will find 30000 products and have the option to create and save your own shopping list and more. In our service area you will find a downloadable version of our catalogue as well as an FTP service.

Additionally, in our news section we will keep you up to date about new products, special promotions and valuable information about Marinetech.

We look forward to your visit...

www.marinetech.de



Wir definieren Service neu

Service schreiben viele Unternehmen groß. Wir belegen diese Behauptung aber gerne mit Fakten.

Unser Sortiment

Wir bieten eines der größten Edelstahlsortimente Europas für den Yacht- und Bootszubehörbereich. Über 29000 Artikel haben wir derzeit ständig im Angebot. Und es wächst noch weiter.

Unsere Lieferquote

Eine große Auswahl ist nicht alles. Im Zeitalter der schlanken Produktion ist die ständige Lieferbarkeit der Artikel nicht weniger wichtig. Wir achten bei der Lagerhaltung darauf, dass wir alle Kundenanfragen direkt und schnell bedienen können. Und das mit Erfolg – unsere Lieferquote liegt über 98%.

Unsere Produktqualität

Unsere Kunden schätzen die hochwertige Qualität der angebotenen Produkte. Diesem Anspruch werden wir durch eine sorgfältige Auswahl unserer Lieferanten und die ständige Kontrolle von der Produktion bis zum Eingang in unserem Lager gerecht.

Unsere Zuverlässigkeit und Erfahrung

Nicht nur die hohe Lieferquote ist ein Garant für unsere Zuverlässigkeit sondern darüber hinaus auch die Organisation unserer Betriebsabläufe und nicht zuletzt auch die Erfahrung im Handel mit Edelstahlprodukten für den maritimen Bereich. Diese Erfahrung kommt uns insbesondere bei der Recherche nach neuen Produkten und der Bewertung und Auswahl von neuen Lieferanten zugute.

Unsere Kunden

Unser Kundenstamm ist vielfältig und umfasst Werften, Industrie und Handel. So unterschiedlich wie die Branchen sind, in denen unsere Kunden zu finden sind, so unterschiedlich auch ihre Anforderungen.

Diesen Anforderungen stellen wir uns mit größtmöglicher Flexibilität. Sollten wir Anfragen trotz unseres umfangreichen Sortiments nicht direkt bedienen können, erarbeiten wir mit unseren Kunden alternative Lösungen. Oder wir machen uns auf die Suche nach dem passenden Artikel.

Wie können wir Ihnen helfen?

We redefine service

Many companies advertise good service. We support our claim of great service with facts.

Our products

We offer one of Europe's largest selection of stainless steel yacht and boat accessories. We continuously have more than 29000 items in stock and our product range is still growing.

Our delivery rate

A large selection is not the only important factor. In the age of lean production, a constant availability of products is no less important. Our storage system allows serving all customer requests directly and quickly – our on time delivery rate is > 98%.

Our product quality

Our customers appreciate the high quality of our products. We attain these high standards of quality through careful selection of our suppliers and constant monitoring from production through receipt in our warehouse.

Our reliability and experience

In addition to our high on time delivery rate, our efficient operating procedures and extensive experience in the stainless steel product market for the maritime sector are a guarantee for our reliability.

We particularly benefit from this experience when researching new products and evaluating and selecting new suppliers.

Our customers

Our customer base is diverse and includes shipyards, industry and trade. The requirements of our customers are as diverse as the industries they work in.

We face these requirements with the greatest possible flexibility. If we cannot immediately fulfill requests despite our extensive selection, we work out alternative solutions in collaboration with our customers or go looking for the perfect item.

How may we help you?



Wir setzen auf Qualität

Die von uns vertriebenen Artikel unterliegen einer ständigen Qualitätskontrolle. Die Zusammensetzung des Edelstahl prüfen wir chargenmäßig bei allen Anlieferungen. Damit stellen wir fest, ob die Artikel den Spezifikationen der jeweiligen Edelnormen entsprechen.

Wir setzen zur RFA-Analyse das INNOV-X ALPHA der Firma Olympus ein. Hierbei handelt es sich um ein mobiles Prüfgerät, das mit Röntgenröhren arbeitet. Röntgenröhren sind seit Langem als die vielseitigsten, leistungsstärksten Anregungsquellen für RFA-Analysen anerkannt. Die INNOV-X-Systeme sind die ersten mobilen Prüfgeräte, die diese Technologie nutzen. Damit können nicht nur vielfältige Produkte, Materialien und Oberflächen untersucht werden. Die sogenannte SmartBeam-Technologie sorgt für niedrige Nachweisgrenzen verschiedener Beimengungen in Legierungen.

Auf Kundenwunsch und bei ausgewählten Produkten erfolgen spezielle Materialprüfungen extern im Labor der F+K mit Sitz in Wetter.

We focus on quality

The items we sell are subject to continuous quality control. We check the composition of the stainless steel per batch for all deliveries, and determine whether the items comply with the specifications of the respective stainless steel standards.

For XRF analysis we use the INNOV-X ALPHA by Olympus. This is a mobile testing device that uses X-ray tubes. For a long time, X-ray tubes have been recognized as the most versatile, most efficient excitation sources for XRF analyses. The INNOV-X systems are the first mobile testing devices to use this technology. This allows testing a variety of products, materials and surfaces. The so-called SmartBeam technology permits low detection limits for various additives in alloys.

Upon customer request and for selected products, special material tests are carried out externally in the laboratory of the F+K based in Wetter.



Our warehouse - your advantage

Our parent company has 4000 different items in store at any time. Additionally, there are 25000 fastening items in store at the external logistics centre. Overall, our selection includes approximately 30000 boat and yachting accessories as well as stainless steel components.

We use state-of-the-art logistics processes in our warehouses and keep the systems we use up to date. This helps us maintain our extraordinarily high delivery quota and short delivery times. Every step in the supply chain is transparent for us and our customers.

Every day hundreds of shipments leave our warehouse. We ship by forwarding company, parcel service or collection. Upon request we of course also offer express delivery or use courier services.

The shipping companies commissioned by us are carefully selected and well known for their reliability.

Unser Lager - Ihr Vorteil

In unserem Stammbetrieb halten wir ständig 4000 unterschiedliche Artikel vor. Hinzu kommt unser externes Logistikzentrum mit 25000 verschiedenen Befestigungselementen. Insgesamt umfasst unser Sortiment rund 30000 Artikel aus den Bereichen Boots- und Yachtbedarf sowie der Edelstahlverbindungen.























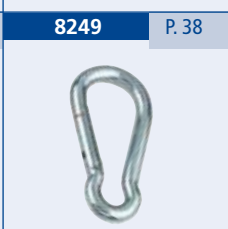
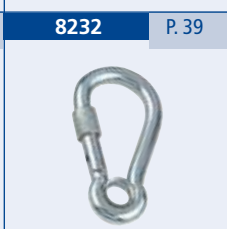





Wir halten die Logistikprozesse in unseren Lagern ständig auf der Höhe der Zeit und die eingesetzten Systeme immer aktuell. Damit können wir unsere äußerst hohe Lieferquote und auch kürzeste Lieferzeiten ermöglichen. Und jeder Schritt in der Logistikkette ist für uns und unsere Kunden nachvollziehbar.

Täglich verlassen mehrere Hundert Sendungen unsere Lager. Wir versenden per Spedition, Paketdienst oder Abholung. Auf Kundenwunsch bieten wir selbstverständlich auch Expressversand an oder setzen Botendienste ein.

Die von uns beauftragten Versandunternehmen sind sorgfältig ausgewählt und für ihre Zuverlässigkeit bekannt.



<p>Kapitel 1 / Chapter 1</p>	<p>pp. 32 - 52</p>	<p>Kapitel 2 / Chapter 2</p>	<p>pp. 53 - 73</p>
	<p>Schäkel, Karabinerhaken und Wirbel Shackles, spring hooks and swivels Manilles, mousquetons, emerillons</p>		<p>Spannschlösser, Terminals und Drahtseil Turnbuckles, terminals and wire ropes Tendeurs, ridoirs, embouts à sertir et câbles</p>
<p>Kapitel 3 / Chapter 3</p>	<p>pp. 74 - 84</p>	<p>Kapitel 4 / Chapter 4</p>	<p>pp. 85 - 133</p>
	<p>Architektur und Design Architecture and design Architecture et design</p>		<p>Relingbeschläge, Rohr und Zubehör Rail fittings, tubing and accessories Embases, platines, tubes et accessories</p>
<p>Kapitel 5 / Chapter 5</p>	<p>pp. 134 - 144</p>	<p>Kapitel 6 / Chapter 6</p>	<p>pp. 145 - 191</p>
	<p>Ketten und Verbinder Chains and connectors Chaînes, maillons rapides et jonctions</p>		<p>Scharniere, Griffe, Haken und Ringe Hinges, handles, hooks and rings Charnières, poignées, crochets et anneaux</p>
<p>Kapitel 7 / Chapter 7</p>	<p>pp. 192 - 224</p>	<p>Kapitel 8 / Chapter 8</p>	<p>pp. 225 - 295</p>
	<p>Klampen, Blöcke und Bolzen Cleats, blocks and bolts Taquets, poulies et cadènes</p>		<p>Yachtzubehör, Ausrüstung und Spezielles Yachting accessories, equipment and highlights Équipement et accessoires exclusifs pour yachts</p>
<p>Kapitel 9 / Chapter 9</p>	<p>pp. 296 - 302</p>	<p>Kapitel 10 / Chapter 10</p>	<p>pp. 303 - 311</p>
	<p>Werkzeug, Reparatur und Pflege Tools, repair and maintenance Outils de réparations et de maintenance</p>		<p>Fittinge und Muffen Fittings Vannes, embouts, passe-coques et crépines</p>
<p>Kapitel 11 / Chapter 11</p>	<p>pp. 312 - 355</p>	<p>Kapitel 12 / Chapter 12</p>	<p>pp. 356 - 379</p>
	<p>Beleuchtung und Elektrik Cabin lighting and electrical equipment Lampes de cabines - électricité</p>		<p>Schrauben in SB Packungen Screws in self-service packages Blister A2 - A4</p>
<p>Kapitel 13 / Chapter 13</p>	<p>pp. 380 - 403</p>	<p>Hinweis: Maßänderungen bei allen Artikeln vorbehalten! Bruchlasten sind ca. Angaben. Note: Measurements for all items under reserve. Breaking loads are approximate. Attention: Sous réserve de changement de dimension possible pour tous les articles. Les charges de rupture sont des données approximatives.</p>	
	<p>Schrauben in Großpackungen Screws in bulk packs Visserie en gros conditionnement</p>		

Kapitel 1 	P. 32	8971	P. 33	8287	P. 33	8969	P. 33	8970	P. 33	8258	P. 34
	8326	P. 34		8482	P. 34		8746	P. 34		814068	P. 35
	8222	P. 35		8259	P. 36		8331	P. 36		8296	P. 36
	8298	P. 37		8299	P. 37		8324	P. 37		8323	P. 38
	8977	P. 38		8249	P. 38		8250	P. 39		814594	P. 39
	8305	P. 40		8948	P. 40		8949	P. 40		8950	P. 40
	8954	P. 41		8955	P. 41		8956	P. 42		8957	P. 42
	8960	P. 43		8961	P. 43		8322	P. 43		8251	P. 43
	8293	P. 44		8294	P. 44		8293	P. 44		8293	P. 44

8257	P. 44	8303	P. 44	8534	P. 45	8416	P. 45	8338	P. 45	8262	P. 45
											
8252	P. 46	8288	P. 46	8290	P. 46	8289	P. 46	8661	P. 47	8533	P. 47
											
8254	P. 47	8255	P. 47	8256	P. 48	8535	P. 48	8364	P. 48	814105	P. 49
											
8485	P. 49	8488	P. 49	814387	P. 49	814656	P. 50	814668	P. 50	814669	P. 50
						 NEW		 NEW		 NEW	
814670	P. 50	814671	P. 51	814672	P. 51	814673	P. 51	814674	P. 51	8493	P. 52
 NEW		 NEW		 NEW		 NEW		 NEW			
8494	P. 52	8490	P. 52	8492	P. 52	8491	P. 52	Kapitel 2	P. 53	8245	P. 54
								 2			
8275	P. 54	8276	P. 55	814167	P. 55	8418	P. 56	8246	P. 56	8339	P. 56
											
814065	P. 57	814066	P. 57	8417	P. 58	8307	P. 58	8467	P. 59	814087	P. 59
											

814088	P. 59	8484	P. 60	8511	P. 60	8281	P. 60	8282	P. 61	8302	P. 61
											
8483	P. 61	8280	P. 62	814067	P. 62	8278	P. 62	8486	P. 62	8503	P. 63
											
8346	P. 63	8350	P. 63	8283	P. 63	814077	P. 64	8403	P. 64	8404	P. 64
											
8406	P. 64	8382	P. 65	8379	P. 65	8381	P. 65	814593	P. 66	8378	P. 66
						Weiß / White 		Transparent Transparency 			
8636	P. 66	8247	P. 67	8536	P. 67	814453	P. 67	8248	P. 68	814391	P. 68
											
8284	P. 68	8304	P. 68	8285	P. 69	8470	P. 69	8471	P. 69	8279	P. 70
											
814076	P. 71	8356	P. 71	8474	P. 71	814729	P. 71	8719	P. 72	8590	P. 72
						 NEW					
8273	P. 72	8431	P. 72	8383	P. 73	8358	P. 73	8504	P. 73	8505	P. 73
											

Kapitel 3	P. 74	8763	P. 75	8445	P. 75	8446	P. 75	8449	P. 75	8450	P. 76
											
8452	P. 76	8453	P. 76	8454	P. 76	8458	P. 77	8455	P. 77	8456	P. 77
											
8457	P. 77	8451	P. 78	8466	P. 78	8469	P. 78	8447	P. 78	8459	P. 81
											
8448	P. 81	8464	P. 81	8515	P. 81	8516	P. 82	8468	P. 82	8424	P. 82
											
814722	P. 82	814700	P. 83	814701	P. 83	8462	P. 83	8463	P. 83	8499	P. 84
											
8502	P. 84	Kapitel 4	P. 85	8762	P. 86	8292	P. 86	8532	P. 86	814642	P. 86
											
8531	P. 87	8546	P. 87	814316	P. 87	816304	P. 87	814305	P. 88	814306	P. 88
											
814307	P. 88	8201	P. 88	8202	P. 89	8203	P. 89	8204	P. 89	8325	P. 89
											













































814607	P. 91	8360	P. 91	8632	P. 91	8633	P. 91	8634	P. 92	8635	P. 92
8907	P. 92	8908	P. 92	8909	P. 93	8612	P. 93	8613	P. 93	8614	P. 93
8615	P. 94	8616	P. 94	8617	P. 94	8205	P. 94	8822	P. 95	814699	P. 95
8206	P. 95	8210	P. 95	8211	P. 97	8387	P. 97	8565	P. 97	8562	P. 97
8208	P. 98	8207	P. 98	814410	P. 98	8702	P. 99	814684	P. 99	814685	P. 99
814589	P. 100	814637	P. 100	814638	P. 100	8703	P. 101	8209	P. 101	8213	P. 101
8215	P. 101	8214	P. 102	8212	P. 102	8310	P. 102	8662	P. 102	8216	P. 103
8327	P. 103	8663	P. 103	8309	P. 103	8658	P. 104	8665	P. 104	8478	P. 104

814048	P. 104	8328	P. 105	8329	P. 105	8856	P. 105	8853	P. 105	8311	P. 106
											
8313	P. 106	8312	P. 106	814166	P. 106	8611	P. 107	8652	P. 107	8819	P. 107
											
8820	P. 107	814116	P. 108	8542	P. 108	814207	P. 108	8366	P. 108	8698	P. 109
											
8699	P. 109	8697	P. 109	8666	P. 109	8668	P. 110	8667	P. 110	8696	P. 110
											
8839	P. 110	814693	P. 111	814392	P. 111	814728	P. 111	814035	P. 111	814036	P. 111
		NEW 				NEW 					
814037	P. 112	814038	P. 112	814039	P. 112	814040	P. 112	814041	P. 113	814228	P. 113
											
814229	P. 113	814230	P. 113	814231	P. 114	814232	P. 114	814233	P. 114	814234	P. 114
											
814236	P. 115	814249	P. 115	814315	P. 115	814237	P. 115	814238	P. 116	814239	P. 116
											

814240	P. 116	814241	P. 116	814242	P. 117	814243	P. 117	814244	P. 117	814245	P. 117
											
814246	P. 118	814247	P. 118	814248	P. 118	814411	P. 118	814412	P. 119	814413	P. 119
											
814414	P. 119	814415	P. 119	814210	P. 120	8226	P. 120	8227	P. 120	8855	P. 120
											
814658	P. 121	8860	P. 121	8540	P. 121	8541	P. 121	814655	P. 122	8496	P. 122
 NEW								 NEW			
8543	P. 122	8764	P. 122	8497	P. 123	8831	P. 123	8829	P. 123	8823	P. 123
											
814106	P. 124	8824	P. 124	8814	P. 124	8223	P. 124	8224	P. 125	8225	P. 125
											
8266	P. 125	8264	P. 125	8265	P. 126	8365	P. 126	8397	P. 126	8396	P. 126
											
8353	P. 127	8368	P. 127	8972	P. 127	814657	P. 127	814117	P. 128	814118	P. 128
						 NEW					

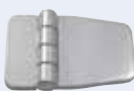
8344	P. 128	8354	P. 128	8357	P. 129	8263	P. 129	814100	P. 129	814601	P. 130
											
814115	P. 130	8439	P. 130	8440	P. 130	814595	P. 131	814721	P. 131	8507	P. 131
									NEW		
8442	P. 131	814189	P. 132	814190	P. 132	8587	P. 132	8586	P. 132	8603	P. 133
											
8604	P. 133	8720	P. 133	8472	P. 133	Kapitel 5	P. 134	8300	P. 135	8301	P. 135
											
8747	P. 135	8695	P. 136	8821	P. 136	814654	P. 136	8253	P. 136	8838	P. 137
							NEW				
8489	P. 137	8363	P. 137	8286	P. 137	8385	P. 138	8414	P. 138	8376	P. 138
											
8530	P. 138	8547	P. 139	814072	P. 139	8460	P. 139	814302	P. 139	8506	P. 140
											
8352	P. 140	8608	P. 140	814652	P. 140	814663	P. 141	8388	P. 141	8487	P. 141
					NEW		NEW				

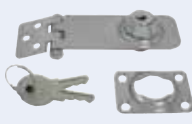
8560	P. 141	8595	P. 142	8566	P. 142	814091	P. 142	814084	P. 143	814386	P. 143
											
8551	P. 143	8308	P. 144	8889	P. 144	8890	P. 144	Kapitel 6	P. 145	8231	P. 146
											
8234	P. 146	8235	P. 146	8236	P. 146	8237	P. 147	8233	P. 147	8239	P. 147
											
8238	P. 147	8514	P. 148	8513	P. 148	814045	P. 148	8512	P. 148	814033	P. 149
											
8429	P. 149	8430	P. 149	8573	P. 149	8574	P. 150	8575	P. 150	8569	P. 150
											
814158	P. 150	814159	P. 151	814160	P. 151	814161	P. 151	814162	P. 151	814163	P. 152
											
814164	P. 152	814165	P. 152	8568	P. 152	8578	P. 153	8572	P. 153	8571	P. 153
											
8570	P. 151	8576	P. 152	8577	P. 152	8567	P. 152	8896	P. 152	8859	P. 155
											

8858	P. 155	8897	P. 155	8900	P. 155	8981	P. 156	8901	P. 156	8902	P. 156
											
8903	P. 156	8982	P. 157	8904	P. 157	8905	P. 157	8906	P. 157	8952	P. 158
											
8910	P. 158	8911	P. 158	8912	P.158	8913	P. 159	8914	P. 159	8915	P. 159
											
814125	P. 159	8917	P. 160	8918	P. 160	8919	P. 160	8920	P. 160	8921	P. 161
											
8922	P. 161	8923	P. 161	8924	P. 161	8925	P. 162	8926	P. 162	8927	P. 162
											
8928	P. 162	8929	P. 163	8930	P. 163	8931	P. 163	8932	P. 163	8933	P. 164
											
8670	P. 164	8671	P. 164	8678	P. 164	8676	P. 165	8677	P. 165	8675	P. 165
											
8674	P. 165	8321	P. 167	8428	P. 167	8588	P. 167	8854	P. 167	8519	P. 168
											

8518	P. 168	8717	P. 168	814666	P. 168	814667	P. 169	8818	P. 169	8834	P. 169
8648	P. 170	8649	P. 170	814060	P. 170	814726	P. 170	814731	P. 171	8650	P. 171
8384	P. 171	8892	P. 171	814064	P. 173	814650	P. 173	814691	P. 173	8413	P. 173
8862	P. 174	8427	P. 174	8318	P. 174	8241	P. 174	8242	P. 175	8243	P. 175
8589	P. 175	8527	P. 175	8348	P. 176	8347	P. 176	8361	P. 176	8399	P. 176
8400	P. 177	8401	P. 177	814081	P.177	814659	P.177	814660	P.178	814664	P.178
814665	P.178	814082	P. 178	814083	P. 179	8476	P. 179	8830	P. 179	814079	P. 179
814080	P. 180	8398	P. 180	814070	P. 180	8968	P. 180	8966	P. 181	8317	P. 181

8539	P. 181	8291	P. 181	814661	P. 182	8340	P. 182	8341	P. 182	814085	P. 182
8523	P. 183	814089	P. 183	8559	P. 183	8891	P. 183	8592	P. 184	8521	P. 184
8825	P. 184	814599	P. 184	8826	P. 185	814598	P. 185	814206	P. 185	814682	P. 185
8584	P. 186	8593	P. 186	8579	P. 186	814662	P. 186	8857	P. 187	8349	P. 187
8229	P. 187	8274	P. 188	8963	P. 188	8975	P. 188	8965	P. 188	8964	P. 189
814188	P. 189	8501	P. 189	814071	P. 189	8270	P. 190	8335	P. 190	8336	P. 190
814078	P. 190	814724	P. 191	814725	P. 191	814680	P. 191	Kapitel 7	P. 192	8217	P. 193
8218	P. 193	8221	P. 193	8680	P. 193	8529	P. 194	814303	P. 194	8827	P. 194

814218	P. 194	814639	P. 195	814640	P. 195	814641	P. 195	8508	P. 196	8557	P. 196
											
8885	P. 196	8886	P. 196	8517	P. 197	8367	P. 197	8973	P. 197	814137	P. 197
											
8219	P. 198	8220	P. 198	8865	P. 198	8840	P. 199	8391	P. 199	8407	P. 199
											
814608-01	P. 201	814608-02	P. 201	814608-03	P. 201	814609-01	P. 201	814609-02	P. 201	814609-03	P. 201
											
814609-04	P. 201	814609-05	P. 201	814609-06	P. 201	814609-07	P. 201	814609-08	P. 201	814609-09	P. 201
											
814609-10	P. 201	814609-11	P. 201	814610-01	P. 203	814610-02	P. 203	814610-03	P. 203	814610-04	P. 203
											
814610-05	P. 203	814610-06	P. 203	814610-07	P. 203	814610-08	P. 203	814610-09	P. 203	814610-10	P. 203
											
814610-11	P. 203	814610-12	P. 203	814613-01	P. 205	814613-02	P. 205	814613-03	P. 205	814613-04	P. 205
											

814613-05	P. 205	814613-06	P. 205	814613-07	P. 205	814613-08	P. 205	814613-09	P. 205	814613-10	P. 205
											
814613-11	P. 205	814613-12	P. 205	814613-13	P. 205	814613-14	P. 205	814613-15	P. 205	814613-16	P. 205
											
814613-17	P. 205	814614-01	P. 207	814614-02	P. 207	814614-03	P. 207	814614-04	P. 207	814614-05	P. 207
											
814614-06	P. 207	814614-07	P. 207	814614-08	P. 207	814614-09	P. 207	814614-10	P. 207	814614-11	P. 207
											
814614-12	P. 207	814614-13	P. 207	814614-14	P. 207	814614-15	P. 207	814615-01	P. 209	814615-02	P. 209
											
814615-03	P. 209	814615-04	P. 209	814615-05	P. 209	814615-06	P. 209	814615-07	P. 209	814615-08	P. 209
											
814615-09	P. 209	814615-10	P. 209	814615-11	P. 209	814615-12	P. 209	814615-13	P. 209	814615-14	P. 209
											
814611-01	P. 210	814611-02	P. 210	814611-03	P. 210	814611-04	P. 210	814616	P. 210	814612-01	P. 211
											

814612-02	P. 211	814612-03	P. 211	814617	P. 211	814618	P. 211	814619	P. 212	814620	P. 212
											
814621	P. 212	814623	P. 212	814633	P. 213	814634	P. 213	814635	P. 213	814716	P. 213
											NEW
814636	P. 214	814624	P. 214	814625	P. 214	814626	P. 214	814627	P. 215	814628	P. 215
											
814629	P. 215	814630	P. 215	814631	P. 216	814632	P. 216	8564	P. 216	8872	P. 216
											
8369	P. 217	8393	P. 217	8390	P. 217	8392	P. 217	8402	P. 218	8395	P. 218
											
8526	P. 218	8651	P. 218	814223	P. 219	8230	P. 219	8979	P. 219	814112	P. 219
											
8267	P. 220	814318	P. 220	814319	P. 220	8271	P. 220	8974	P. 221	814086	P. 221
											
8473	P. 221	8316	P. 222	8976	P. 222	814110	P. 222	814111	P. 222	8268	P. 223
											

814123	P. 223	8272	P. 223	814122	P. 223	8228	P. 224	8537	P. 224	8538	P. 224
											
8481	P. 224	Kapitel 8	P. 225	8465	P. 226	8553	P. 226	814690	P. 226	814689	P. 226
											
814695	P. 227	814696	P. 227	814736	P. 227	8524	P. 228	8624	P. 228	8631	P. 228
											
8528	P. 228	8475	P. 229	8942	P. 229	814718	P. 229	8660	P. 230	8887	P. 230
											
8867	P. 230	8868	P. 230	8437	P. 231	8869	P. 231	814044	P. 231	814270	P. 231
											
814271	P. 232	814272	P. 232	814273	P. 232	814274	P. 232	814275	P. 233	814277	P. 233
											
814278	P. 233	814279	P. 233	8443	P. 234	8585	P. 234	8618	P. 234	8607	P. 234
											
8641	P. 235	814602	P. 235	814603	P. 235	814604	P. 235	814119	P. 236	814132	P. 236
											

814298	P. 236	814291	P. 236	814292	P. 237	814293	P. 237	814294	P. 237	814300	P. 237
											
8582	P. 238	8581	P. 238	8609	P. 238	8580	P. 238	8461	P. 239	8422	P. 239
											
8444	P. 239	8438	P. 239	814133	P. 240	8653	P. 240	814717	P. 240	8654	P. 240
									NEW		
814114	P. 241	8355	P. 241	8525	P. 241	8599	P. 241	814217	P. 243	8556	P. 243
											
814653	P. 243	814681	P. 243	8370	P. 244	8371	P. 244	8372	P. 244	8373	P. 244
NEW 		NEW 									
8374	P. 245	814225	P. 245	814073	P. 245	814074	P. 245	8342	P. 246	8713	P. 246
											
8657	P. 246	8701	P. 246	814047	P. 247	8375	P. 247	8345	P. 247	8894	P. 247
											
8895	P. 248	8861	P. 248	8319	P. 248	8320	P. 248	814719	P. 249	814720	P. 249
								NEW 		NEW 	

814063	P. 249	814062	P. 249	8836	P. 250	8837	P. 250	8314	P. 250	8673	P. 251
											
814058	P. 251	8835	P. 251	814061	P. 251	814107	P. 252	814108	P. 252	814121	P. 252
											
814687	P. 252	8833	P. 253	8421	P. 253	8550	P. 253	8718	P. 253	814054	P. 254
											
8330	P. 254	8332	P. 254	814113	P. 254	8244	P. 255	814109	P. 255	814149	P. 255
											
814295	P. 255	814296	P. 256	814297	P. 256	8351	P. 256	8610	P. 256	8522	P. 257
											
814649	P. 257	8477	P. 257	814099	P. 257	8520	P. 259	8706	P. 259	8934	P. 259
											
814596	P. 259	814224	P. 260	8554	P. 260	8591	P. 260	814093	P. 260	8498	P. 261
											
8500	P. 261	814651	P. 261	8828	P. 261	814187	P. 263	8479	P. 263	8480	P. 263
											

814156	P. 263	8377	P. 264	814208	P. 264	814702	P. 264	814705	P. 265	814706	P. 265
							NEW		NEW		NEW
814707	P. 265	814708	P. 266	814709	P. 266	814710	P. 266	814711	P. 266	8441	P. 267
	NEW		NEW		NEW		NEW		NEW		
8704	P. 267	8710	P. 267	8711	P. 267	814136	P. 268	814135	P. 268	8832	P. 268
											
8935	P. 268	8936	P. 269	8937	P. 269	8938	P. 269	8939	P. 269	814597	P. 270
											
8940	P. 270	8941	P. 270	814457	P. 270	814458	P. 271	8866	P. 271	814075	P. 271
											
814280	P. 272	814281	P. 272	8707	P. 272	8708	P. 272	8700	P. 273	8669	P. 273
											
8596	P. 273	814120	P. 273	8880	P. 274	8881	P. 274	8882	P. 274	8883	P. 274
											
8884	P. 275	8943	P. 275	8944	P. 275	8945	P. 275	8946	P. 276	8947	P. 276
											

8847	P. 276	814301	P. 276	8848	P. 277	814092	P. 277	8998	P. 277	814126	P. 277
											
814127	P. 278	814688	P. 278	814043	P. 278	814029	P. 278	814030	P. 279	814031	P. 279
		 NEW									
814151	P. 279	814152	P. 279	814730	P. 280	814692	P. 280	814032	P. 280	814101	P. 280
				 NEW		 NEW					
814102	P. 281	814098	P. 281	814055	P. 281	814056	P. 281	814095	P. 282	814096	P. 282
											
814097	P. 282	814094	P. 282	814129	P. 283	814124	P. 283	814590	P. 283	814282	P. 283
											
814286	P. 284			814287	P. 284	814288	P. 286	814289	P. 286	814290	P. 286
											
814647	P. 286	814648	P. 287	814333	P. 287	814299	P. 287	814317	P. 287	8995/6	P. 288
 NEW		 NEW									
8997	P. 290	814335	P. 291	814309/10/11	P. 292	814644/45	P. 293	814644/45	P. 293	814265 - 69	P. 294
						 NEW		 NEW			

814712 P. 295 	814723 P. 295 	814713 P. 295 	814714 P. 295 	814715 P. 295 	Kapitel 9 P. 296 
814209 P. 297 	814733 P. 297 	814734 P. 297 	3016 P. 298 	814455 P. 298 	884456 P. 298 
814678 P. 299 	814679 P. 299 	814643 P. 300 	8993 P. 300 	8994 P. 300 	8637 P. 301 
814153 P. 301 	814154 P. 301 	814226 P. 301 	814227 P. 302 	814250 P. 302 	8415 P. 302 
8277 P. 302 	Kapitel 10 P. 303 	8748 P. 304 	8605 P. 304 	8620 P. 304 	8639 P. 304 
8749 P. 305 	8893 P. 305 	8621 P. 305 	8745 P. 305 	8638 P. 306 	8606 P. 306 
8623 P. 306 	8625 P. 306 	8624 P. 307 	8622 P. 307 	8640 P. 307 	8627 P. 307 
8626 P. 308 	8659 P. 308 	8761 P. 308 	814563 P. 308 	814564 P. 309 	814565 P. 309 

814566	P. 309	814567	P. 309	814568	P. 310	814569	P. 310	814572	P. 310	814573	P. 311
											
814574	P. 311	814576	P. 311	814577	P. 311	Kapitel 11	P. 312	8645	P. 314	8646	P. 314
											
8644	P. 314	8643	P. 314	814103	P. 315	814104	P. 315	814675	P. 315	814676	P. 315
									NEW		NEW
8692	P. 316	8594	P. 316	814148	P. 316	8841	P. 316	8842	P. 317	8843	P. 317
											
8844	P. 317	8845	P. 317	8738	P. 318	8736	P. 318	8741	P. 318	8740	P. 318
											
814199	P. 319	814200	P. 319	814204	P. 319	8758	P. 319	8694	P. 320	8693	P. 320
											
8739	P. 320	8759	P. 320	8742	P. 321	814205	P. 321	814051	P. 321	814259	P. 321
											
814262	P. 323	8655	P. 323	814251	P. 323	814252	P. 323	814253	P. 324	814332	P. 324
											

814698  NEW	P. 324	814203 	P. 324	814202 	P. 325	8760 	P. 325	8691 	P. 325	814191 	P. 325
8755 	P. 326	8737 	P. 326	814201 	P. 326	814219 	P. 326	814677  NEW	P. 327	814140 	P. 327
814141 	P. 327	814138 	P. 327	814144 	P. 328	814145 	P. 328	814257 	P. 328	814050 	P. 328
814049 	P. 329	814142 	P. 329	814146 	P. 329	814147 	P. 329	814261 	P. 330	814263 	P. 330
814322 	P. 330	814404 	P. 330	814388 	P. 331	814405 	P. 331	814406 	P. 331	814221 	P. 331
814254 	P. 332	814256 	P. 332	814324 	P. 332	814325 	P. 332	814323 	P. 333	814255 	P. 333
814258 	P. 333	814260 	P. 333	814326 	P. 334	814686  NEW	P. 334	814327 	P. 334	814321 	P. 334
814605 	P. 335	814683  NEW	P. 335	814320 	P. 335	8744 	P. 335	814193 	P. 336	814194 	P. 336

814195	P. 336	814196	P. 336	814197	P. 337	8898	P. 337	814735	P. 337	814600	P. 338
											
814157	P. 338	8743	P. 338	814328	P. 338	814329	P. 339	814330	P. 339	814331	P. 339
											
8544	P. 339	8687	P. 340	8685	P. 340	814198	P. 340	8756	P. 340	8686	P. 341
											
8688	P. 341	8689	P. 341	8757	P. 341	814052	P. 342	814053	P. 342	814402	P. 342
											
814403	P. 342	814090	P. 343	8725	P. 343	8899	P. 343	8724	P. 343	8723	P. 344
											
8722	P. 344	8734	P. 344	8733	P. 344	8732	P. 345	8730	P. 345	814407	P. 345
											
814408	P. 345	814409	P. 346	8681	P. 346	8683	P. 346	8684	P. 346	8682	P. 347
											
8729	P. 347	8728	P. 347	8716	P. 347	8731	P. 348	8509	P. 348	8510	P. 348
											

8672	P. 348	8583	P. 349	8712	P. 349	8714	P. 349	8705	P. 349	8726	P. 350
											
814059	P. 350	8721	P. 350	8690	P. 350	8727	P. 351	814393	P. 351	814394	P. 351
											
814395	P. 351	814192	P. 352	814042	P. 352	814308	P. 352	8735	P. 352	8874	P. 353
											
8875	P. 353	814334	P. 353	814220	P. 353	Blister	P. 354	Blisterwand	P. 355		
											
Kapitel 12	P. 356	P. 357 - 379			Kapitel 13	P. 380	P. 381 - 401				
12		A4 / A2				13		A4 / A2			
		Schrauben in SB-Verpackungen						Schrauben in Großpackungen			
		Screws in self-service packages						Screws in bulk packs			
1024/1025	P. 402	1026	P. 403	1027/1028	P. 403						
											

Kapitel 1

Chapter 1

Schäkel, Karabinerhaken und Wirbel
Shackles, spring hooks and swivel



Schäkel, Karabinerhaken und Wirbel

Shackles, spring hooks and swivels

Manilles, mousquetons, emerillons

1

1

Trailerhaken mit Wirbel / A4-AISI 316

Trailer hook with swivel / Croc de palau à gachette

8971

Bestell-Nr. Order no.	A	B	C	D	E	BL/Kg	Box	*€/Stück *€/piece
8971428	28	27	18	69	147	2000	1	20,00
8971436	36	36	33	97	193	3700	1	39,00

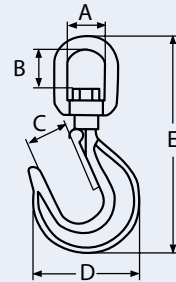

Trailerhaken / A4-AISI 316

Trailer hook / Croc de palan

8287

Bestell-Nr. Order no.	A	B	C	D	BL/Kg	Box	*€/Stück *€/piece
8287419	19	33,5	100	20,5	1500	5	6,90
8287428	28	44,5	115	23	1800	5	9,00

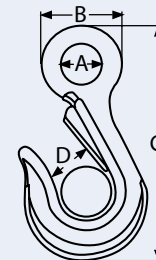

Rundschäkel, weite Form / A4-AISI 316

D-shackle, wide / Manille droite

8969

Bestell-Nr. Order no.	Ø	A	L	BL/Kg	Box	*€/Stück *€/piece
8969405	5	25	20	750	10	2,50
8969406	6	24	33	1350	10	2,80
8969408	8	26	31	2500	10	4,50
8969410	10	41	55	3350	5	7,40
8969412	12	50	66	4000	5	12,30

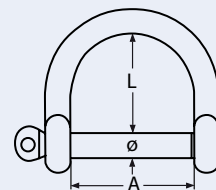

Rundschäkel geschweifte Form mit Innensechskant / A4-AISI 316

Bow shackle with hexagon socket / Manille droite forgée avec vis 6 pans creux

8970

Bestell-Nr. Order no.	Ø	A	L	R	BL/Kg	Box	*€/Stück *€/piece
8970405	5	11	25	17	1200	10	3,00
8970406	6	12	30	21	1700	10	3,10
8970408	8	16	44	28	2500	10	4,60
8970410	10	21	49	34	4300	5	6,70
8970412	12	25	57	42	6200	5	11,00
8970416	16	31	80	56	7000	5	23,00
8970419	19	36	96	66	14000	1	37,20

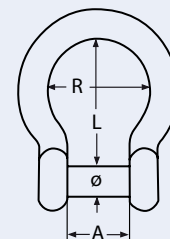

1

Schäkel, Karabinerhaken und Wirbel

Shackles, spring hooks and swivels

Manilles, mousquetons, emerillons

8258

Rundschäkel, kurze Form / A4-AISI 316

D-shackle, short / Manille droite, type court

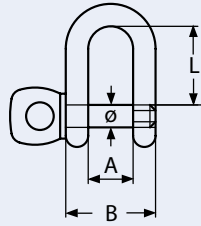

Bestell-Nr. Order no.	Ø	A	B	L	BL/Kg	Box	*€/Stück *€/piece
8258404	4	8	16	14	700	20	1,30
8258405	5	10	20	14,5	1000	20	1,40
8258406	6	12	24	21	1500	20	1,70
8258407	7	14	28	23,5	2200	10	2,40
8258408	8	16	32	28	3000	10	2,80
8258410	10	20	40	36	4500	10	4,70
8258412	12	24	48	44	7000	5	7,50
8258413	13	26	52	46,5	9000	5	11,00
8258416	16	32	64	56	10000	5	16,80
8258419	19	35	76	65,5	16000	1	29,90
8258422	22	44	88	74	20000	1	43,50
8258425	25	50	100	85,5	24000	1	55,10
8258432	32	64	128	108	31000	1	155,00

8326

Rundschäkel mit unverlierbarem Bolzen / A4-AISI 316

D-shackle with captive pin / Manille droite axe imperdable

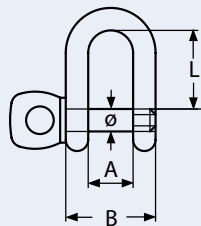

Bestell-Nr. Order no.	Ø	A	B	L	BL/Kg	Box	*€/Stück *€/piece
8326405	5	10	20	16,5	1100	10	2,40
8326406	6	12	24	21	1600	10	2,70
8326408	8	16	32	28	3200	10	3,50
8326410	10	20	40	34	4900	5	5,80
8326412	12	24	48	36	6600	5	9,00

8482

Rundschäkel mit Innensechskant / A4-AISI 316

D-shackle with hexagon socket / Manille droite avec vis six pans creux

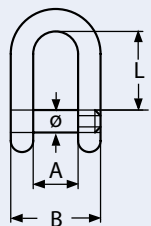

Bestell-Nr. Order no.	Ø	A	B	L	BL/Kg	Box	*€/Stück *€/piece
8482405	5	10	20	16,5	1000	10	3,30
8482406	6	12	24	18	1500	10	3,50
8482408	8	16	32	28	2200	10	4,10
8482410	10	20	40	35	3700	5	6,60
8482412	12	24	48	45	5400	5	9,90
8482414	14	28	56	49	6500	5	15,00
8482416	16	32	64	52	8800	5	19,50
8482419	19	38	76	63,5	16000	1	26,50
8482422	22	44	88	76	19000	1	46,50

8746

Rundschäkel, geschmiedet / A4-AISI 316

D-shackle, forged / Manille droite forgée

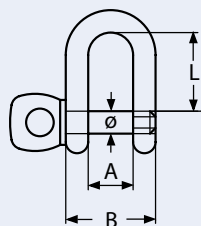

Bestell-Nr. Order no.	Ø	A	B	L	BL/Kg	Box	*€/Stück *€/piece
8746404	4	8	16	15	1080	10	1,70
8746405	5	10	20	17,5	1550	10	1,80
8746406	6	12	24	21	1860	10	2,20
8746408	8	16	32	29	4380	10	3,10
8746410	10	20	40	35	5800	5	5,20
8746412	12	24	48	43	8100	5	8,20

Schäkel, Karabinerhaken und Wirbel

Shackles, spring hooks and swivels

Manilles, mousquetons, emerillons

1

1

Rundschäkel mit Sicherungsbolzen, geschweift, geschmiedet / A4-AISI 316

Bow shackle with fastening bolt, forged / Manille lyre forgée avec boulon de sécurité

814068

Bestell-Nr. Order no.	Ø	B	A	L	BL/Kg	Box	*€/Stück *€/piece
8140684048	6,4	5	9,7	22	1320	10	2,80
8140684064	8	6	12	29	2000	10	3,50
814068408	9,5	8	13,5	31	3000	10	5,60
8140684095	11	10	17	36	4000	5	8,40
8140684127	16	12	21	48	8000	5	16,70
814068416	19	16	27	60	12000	5	35,20
814068419	22	20	32	71	16000	1	55,50
814068422	25	22	36	84	20000	1	83,00

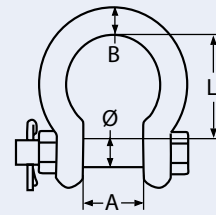

Besonders geeignet als Ankerschäkel - Suited as anchor shackle - Convient particulièrement comme manille d'ancre

Rundschäkel mit Sicherungsbolzen, geschmiedet / A4-AISI 316

D-shackle with fastening bolt, forged / Manille droite forgée avec boulon de sécurité

814069

Bestell-Nr. Order no.	Ø	B	A	L	BL/Kg	Box	*€/Stück *€/piece
8140694048	6,4	5	9,7	19	1320	10	2,70
8140694064	8	6	12	22	2000	10	3,30
814069408	9,5	8	13,5	26	3000	10	5,30
8140694095	11	10	17	32	4000	5	8,00
8140694127	16	12	21	41	8000	5	15,60
814069416	19	16	27	51	12000	5	33,80
814069419	22	20	32	60	16000	1	51,90
814069422	25	22	36	71	20000	1	67,00

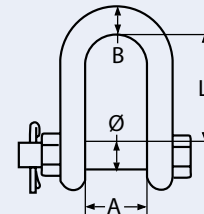

Besonders geeignet als Ankerschäkel - Suited as anchor shackle - Convient particulièrement comme manille d'ancre

Rundschäkel, geschweifte Form / A4-AISI 316

Bow shackle / Manille lyre

8260

Bestell-Nr. Order no.	Ø	A	R	L	BL/Kg	Box	*€/Stück *€/piece
8260404	4	8	14	14	800	20	1,50
8260405	5	10	17	17,5	1200	20	1,80
8260406	6	12	21	21	1900	20	2,00
8260408	8	16	28	28	2800	10	2,80
8260410	10	20	34	35	4300	10	4,60
8260412	12	24	42	42	6500	5	6,90
8260413	13	26	45	39	7500	5	9,50
8260416	16	32	56	56	12000	5	15,90
8260419	19	38	66	78,5	18200	1	38,10
8260422	22	44	75	77	21000	1	46,00

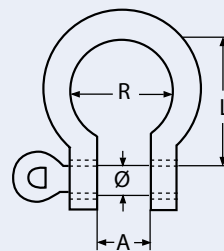

Rundschäkel mit unverlierbarem Bolzen, geschweifte Form / A4-AISI 316

Bow shackle, with captive pin / Manille lyre axe imperdable

8222

Bestell-Nr. Order no.	Ø	A	R	L	BL/Kg	Box	*€/Stück *€/piece
8222405	5	10	17	17,5	1300	10	2,70
8222406	6	12	21	21	1800	10	3,40
8222408	8	16	28	28	3500	10	4,00
8222410	10	20	34	35	5400	5	6,00

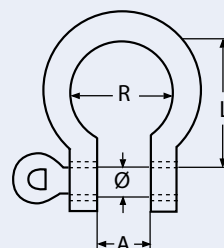

1

Schäkel, Karabinerhaken und Wirbel

Shackles, spring hooks and swivels

Manilles, mousquetons, emerillons

8259

Rundschäkel, lange Form / A4-AISI 316

Straight D-shackle, long / Manille droite, type long

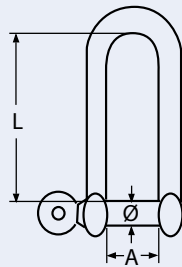

Bestell-Nr. Order no.	Ø	A	L	BL/Kg	Box	*€/Stück *€/piece
8259404	4	8,5	32	700	10	1,60
8259405	5	10	40	1000	10	2,20
8259406	6	12	48	1500	10	2,50
8259408	8	16	64	3200	10	3,60
8259410	10	20	80	4900	5	6,30
8259412	12	24	96	7000	5	11,00

8331

Rundschäkel, lange Form mit unverlierbarem Bolzen / A4-AISI 316

Straight D-shackle, long with captive pin / Manille droite axe imperdable, type long

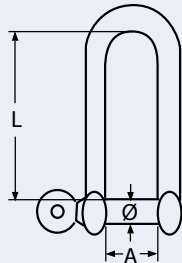

Bestell-Nr. Order no.	Ø	A	L	BL/Kg	Box	*€/Stück *€/piece
8331405	5	10	37,5	1100	10	3,40
8331406	6	12	43	1600	10	3,70
8331408	8	16	60	3200	10	4,70
8331410	10	20	75	4900	5	7,40
8331412	12	24	90	6600	5	11,90

8296

Rundschäkel, gedrehte Form / A4-AISI 316

Shackle, twisted / Manille type torsadée

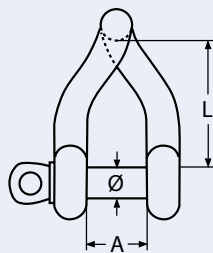

Bestell-Nr. Order no.	Ø	A	L	BL/Kg	Box	*€/Stück *€/piece
8296405	5	10	27	1200	10	2,10
8296406	6	12	30	1750	10	2,50
8296408	8	16	42	3000	10	3,60
8296410	10	20	55	5800	5	6,00
8296412	12	24	65	7000	5	10,30

8337

Flachschäkel, rund / A4-AISI 316

Flat shackle, semi-round / Manille plate, type semi rond

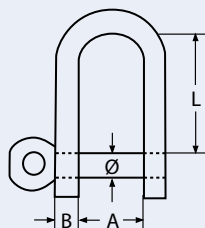

Bestell-Nr. Order no.	Ø	A	L	B	BL/Kg	Box	*€/Stück *€/piece
833745	5	12	18,5	2,6	400	10	2,10
833746	6	14	22	3,0	500	10	2,30
833748	8	18	28	3,7	900	10	3,50

Schäkel, Karabinerhaken und Wirbel

Shackles, spring hooks and swivels
Manilles, mousquetons, emerillons

1

1

Flachschäkel mit Bund, kurze Ausführung / A4-AISI 316

Flat shackle, short / Manille plate, type court

8297

Bestell-Nr. Order no.	Ø	A	L	BL/Kg	Box	*€/Stück *€/piece
829744	4	10	18	800	10	1,80
829745	5	12	20	1100	10	1,90
829746	6	16	24	2000	10	2,60

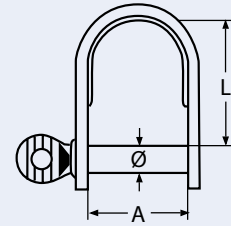

Flachschäkel mit Bund, lange Form / A4-AISI 316

Flat shackle, long / Manille plate, type long

8298

Bestell-Nr. Order no.	Ø	A	L	BL/Kg	Box	*€/Stück *€/piece
829844	4	12	24	800	10	2,00
829845	5	16	21	1100	10	2,30
829846	6	17	26	2000	10	3,50

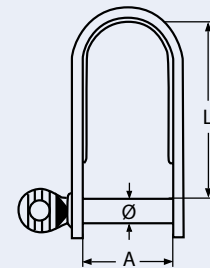

Flachschäkel mit Bund, gedrehte Form / A4-AISI 316

Flat shackle, twisted / Manille plate, type torsadée

8299

Bestell-Nr. Order no.	Ø	A	L	BL/Kg	Box	*€/Stück *€/piece
829944	4	11	24	800	10	2,90
829945	5	12	40	1400	10	3,40

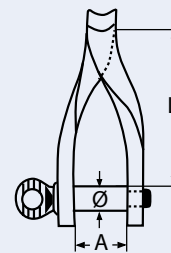

Schlüsselschäkel / A4-AISI 316

Key pin shackle / Manille rapide

8324

Bestell-Nr. Order no.	Ø	A	L	BL/Kg	Box	*€/Stück *€/piece
832445	5	13	40	954	10	3,60
832446	6	16	49	1363	10	4,70
832448	8	22	62	2271	10	7,40

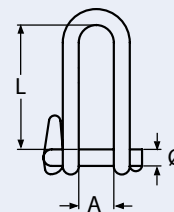

1

Schäkel, Karabinerhaken und Wirbel

Shackles, spring hooks and swivels

Manilles, mousquetons, emerillons

8323

Schlüsselschäkel mit Steg / A4-AISI 316

Key pin shackle with bar / Manille rapide à barette

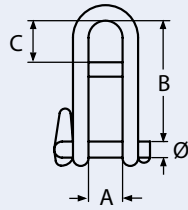

Bestell-Nr. Order no.	Ø	A	B	C	BL/Kg	Box	*€/Stück *€/piece
832345	5	13	38	12,5	954	10	3,80
832346	6	16	43	15,0	1363	10	5,10
832348	8	21,5	60	20,5	2272	10	7,50

814737

Aluschäkel / Alu

D-shackle alu / Manille droite en Alu

NEW

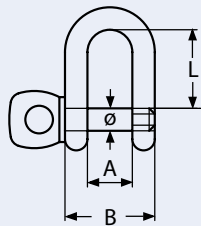
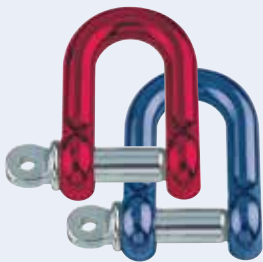

Bestell-Nr. Order no.	Ø	A	B	L	BL/Kg	Box	*€/Stück *€/piece
8147370058	5,8	12,6	24,2	22	700	10	1,70
8147370078	7,8	17	32,6	28,6	900	10	2,80
8147370098	9,8	20	39,6	35	1500	5	3,90
8147370118	11,8	25	48,6	45	2100	5	5,90

Farben: rot, blau, lila, gelb und grün gemischt.

Colours: red, blue, purple, yellow and green mixed up.

8306

Schäkelschlüssel / A2-AISI 304

Multi-purpose shackle key / Demanilleur-decapsuleur

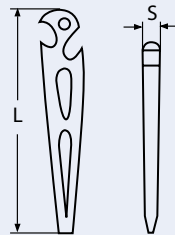

Bestell-Nr. Order no.	L	S	Box	*€/Stück *€/piece
83062100	100	2	5	2,50

8977

Schäkelschlüssel / A4-AISI 316

Multi-purpose shackle key / Demanilleur-decapsuleur

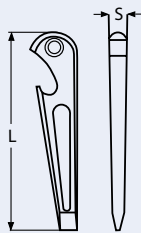

Bestell-Nr. Order no.	L	S	Box	*€/Stück *€/piece
8977405	86	5	10	2,00

8249

Karabinerhaken / A4-AISI 316

Spring hook / Mousqueton pompier

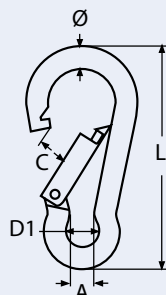

Bestell-Nr. Order no.	Ø	L	D1	A	C	BL/Kg	Box	*€/Stück *€/piece
8249403_30	3	30	5	4	5,5	500	10	1,30
8249404_40	4	40	9	5	7	590	10	1,60
8249405_50	5	50	10	6	8	760	10	1,70
8249406_60	6	60	11	8	9	900	10	1,80
8249407_70	7	70	13	8	9	1370	10	2,60
8249408_80	8	80	13	8	9	1500	10	3,50
8249410_100	10	100	16	10	12	1900	5	6,50
8249411_120	11	120	18	11	16	2050	5	9,40
8249412_140	12	140	20	13	19	2060	5	11,90

Schäkel, Karabinerhaken und Wirbel

Shackles, spring hooks and swivels

Manilles, mousquetons, emerillons

1

1

Karabinerhaken mit Kausche / A4-AISI 316

Spring hook with eyelet / Mousqueton pompier à œil

8250

Bestell-Nr. Order no.	Ø	L	D	A	C	BL/Kg	Box	*€/Stück *€/piece
8250404_40	4	40	4,5	5	7	600	10	1,80
8250405_50	5	50	7	6	8	800	10	2,00
8250406_60	6	60	7,5	8	9	850	10	2,30
8250407_70	7	70	9,5	8	9	1200	10	3,00
8250408_80	8	80	10,5	8	9	1200	10	3,30
8250410_100	10	100	14	10	12	1750	5	7,20
8250411_120	11	120	18	11	16	1850	5	9,00
8250412_140	12	140	18,5	13	19	1880	5	14,30

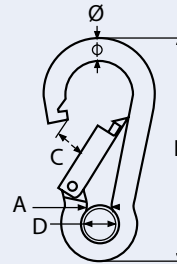

Karabinerhaken mit Sicherheitsmutter und Kausche / A4-AISI 316

Spring hook with lock nut and eyelet / Mousqueton pompier à œil avec vis de sécurité

8232

Bestell-Nr. Order no.	Ø	L	D	A	C	BL/Kg	Box	*€/Stück *€/piece
8232404_40	4	40	5	6,5	7	630	10	2,50
8232405_50	5	50	9	7,5	8	750	10	3,00
8232406_60	6	60	10	7,5	9	900	10	4,00
8232407_70	7	70	11	9	9	900	10	5,00
8232408_80	8	80	13	8	8	1400	10	6,00
8232410_100	10	100	16	10	10	2000	5	8,00
8232411_120	11	120	18	11	15	2100	5	11,00

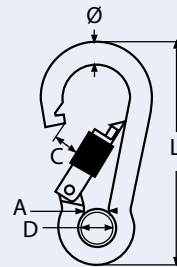

Karabinerhaken mit Sicherheitsmutter / A4-AISI 316

Spring hook with lock nut / Mousqueton pompier avec vis de sécurité

814594

Bestell-Nr. Order no.	Ø	L	D	A	C	BL/Kg	Box	*€/Stück *€/piece
814594404_40	4	40	5	5	7	650	10	1,70
814594405_50	5	50	9	6	8	880	10	1,80
814594406_60	6	60	10	8	9	880	10	2,50
814594407_70	7	70	11	8	9	900	10	3,40
814594408_80	8	80	13	8	8	1300	10	4,50
814594410_100	10	100	16	10	10	1700	5	8,50
814594411_120	11	120	18	11	15	1900	5	10,20

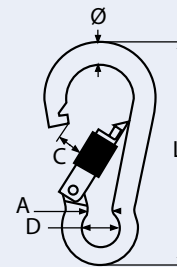

Bojen-Karabiner / A4-AISI 316

Buoy hook / Crochet d'amarage

8679

Bestell-Nr. Order no.	A	B	C	D	BL/Kg	Box	*€/Stück *€/piece
86794108_63	108	63	21	35	910	5	17,70

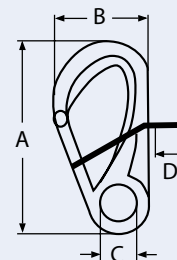

Öffnen und schließen nur mit dem Bootshaken
Open and close with boathook only

1

Schäkel, Karabinerhaken und Wirbel

Shackles, spring hooks and swivels

Manilles, mousquetons, emerillons

8305

Karabinerhaken mit Bügel / A4-AISI 316

Spring hook with bow / Mousqueton pompier ressort asymétrique

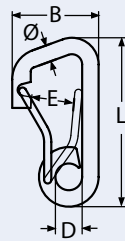

Bestell-Nr. Order no.	Ø	D	B	L	E	BL/Kg	Box	*€/Stück *€/piece
8305406	6	7	35	61	10	600	10	4,50
8305408	8	11	48	81	13	1600	10	6,30
8305410	10	13	58	102	15	2500	5	8,50
8305412	12	16	70	122	21	3000	5	12,00
8305416	16	25	97	165	27	3300	5	28,00

8948

Karabinerhaken mit Sicherheitsverschluss / A4-AISI 316

Spring lock hook with safety latch / Mousqueton pompier avec fermeture de sécurité

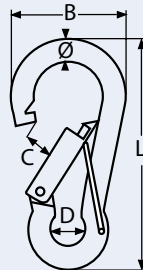

Bestell-Nr. Order no.	Ø	L	B	C	D	BL/Kg	Box	*€/Stück *€/piece
8948406_60	6	60	30	7,5	8,5	272	10	2,60
8948408_80	8	80	40	10	12	508	10	4,80
8948410_100	10	100	50	12	15	728	5	7,70

8949

Karabinerhaken mit Springverschluss / A4-AISI 316

Spring hook with self-lock nut / Mousqueton pompier ouverture extérieure avec fermeture automatique

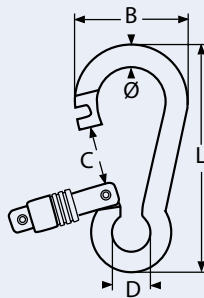

Bestell-Nr. Order no.	Ø	L	B	C	D	BL/Kg	Box	*€/Stück *€/piece
8949405_50	5	55	26	15	8	387	10	3,20
8949406_60	6	60	30	16	8,5	417	10	3,90
8949408_80	8	80	40	23	12	990	10	6,70
8949410_100	10	100	50	27	15	1300	5	10,60

8950

Karabinerhaken mit Springverschluss und Kausche / A4-AISI 316

Spring hook with eyelet and self-lock nut / **

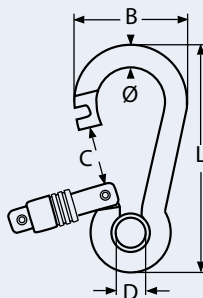

Bestell-Nr. Order no.	Ø	L	B	C	D	BL/Kg	Box	*€/Stück *€/piece
8950405_50	5	50	26	15	7,8	387	10	3,40
8950406_60	6	60	30	16	7,8	417	10	4,20
8950408_80	8	80	40	23	10,8	990	10	6,80
8950410_100	10	100	50	27	14,0	1300	5	10,80

**Mousqueton pompier à oeil ouverture extérieure avec fermeture automatique

Schäkel, Karabinerhaken und Wirbel

Shackles, spring hooks and swivels

Manilles, mousquetons, emerillons

1

1

Karabinerhaken asym. m. Sicherheitsmutter und Kausche / A4-AISI 316

Spring hook asymmetric with lock nut and eyelet / Mousqueton asymétrique à œil avec vis de sécurité

8951

Bestell-Nr. Order no.	Ø	L	B	C	D	BL/Kg	Box	*€/Stück *€/piece
8951406_60	6	60	35	9	8	456	10	2,90
8951408_80	8	80	46	12,5	11	728	10	5,00
8951410_100	10	100	60	16	14	1092	5	9,50
8951411_120	11	120	70	21,5	18	1260	5	12,10

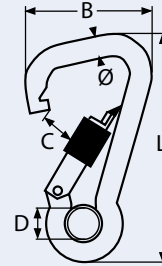

Karabinerhaken mit Sicherheitsmutter / A4-AISI 316

Spring hook with lock nut / Mousqueton asymétrique avec vis de sécurité

8953

Bestell-Nr. Order no.	Ø	L	B	C	BL/Kg	Box	*€/Stück *€/piece
8953411_120	11	120	70	24	1600	5	12,00

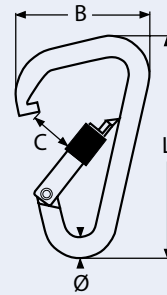

Karabinerhaken mit Sicherheitsmutter und Steg / A4-AISI 316

Spring hook with lock nut and bar / Mousqueton asymétrique à barette avec vis de sécurité

8954

Bestell-Nr. Order no.	Ø	L	B	C	BL/Kg	Box	*€/Stück *€/piece
8954411_120	11	120	70	24	1600	5	15,50

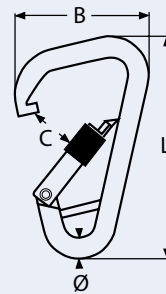

Karabinerhaken mit Sicherheitsmutter / A4-AISI 316

Spring hook with lock nut / Mousqueton - vis de sécurité

8955

Bestell-Nr. Order no.	Ø	L	B	C	BL/Kg	Box	*€/Stück *€/piece
8955410_115	10	115	60	19	2720	5	10,80

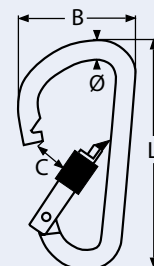

1

Schäkel, Karabinerhaken und Wirbel

Shackles, spring hooks and swivels

Manilles, mousquetons, emerillons

8956

Karabinerhaken mit Springverschluss und Steg / A4-AISI 316

Spring hook with self-locking sleeve and bar / Mousqueton a fermeture automatique avec barette

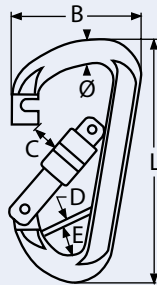

Bestell-Nr. Order no.	Ø	L	B	C	D	E	BL/Kg	Box	*€/Stück *€/piece
8956408_64	8	80	45	12	1,7	13	1330	10	7,90
8956410_80	10	100	55	14	2,0	16	2510	5	11,90

8957

Karabinerhaken mit Springverschluss / A4-AISI 316

Spring hook with self-locking sleeve / Mousqueton à fermeture automatique

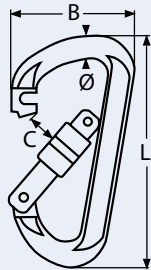

Bestell-Nr. Order no.	Ø	L	B	C	BL/Kg	Box	*€/Stück *€/piece
8957408_64	8	80	45	11,5	1590	10	7,90
8957410_80	10	100	55	14,0	1680	5	11,70

8958

Karabinerhaken mit Sicherheitsmutter / A4-AISI 316

Spring hook with lock nut / Mousqueton avec vis de sécurité

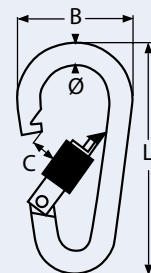

Bestell-Nr. Order no.	Ø	L	B	C	BL/Kg	Box	*€/Stück *€/piece
8958406_60	6	60	30	8,5	272	10	2,90
8958408_80	8	80	40	10	508	10	5,20
8958410_100	10	100	50	12	728	5	8,20
8958411_120	11	120	60	17	816	5	10,80

8959

Karabinerhaken mit Sicherheitsmutter / A4-AISI 316

Spring hook with lock nut / Mousqueton ouverture extérieure avec vis de sécurité

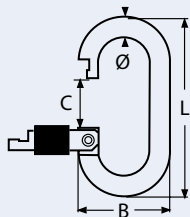

Bestell-Nr. Order no.	Ø	L	B	C	BL/Kg	Box	*€/Stück *€/piece
8959406_55	6	52	27	14	440	10	4,00
8959408_70	8	70	35	18	905	10	6,00

Schäkel, Karabinerhaken und Wirbel

Shackles, spring hooks and swivels

Manilles, mousquetons, emerillons

1

1

Karabinerhaken mit Springverschluss / A4-AISI 316

Spring hook opening with self-locking nut / Mousqueton ouverture extérieure avec fermeture automatique

8960

Bestell-Nr. Order no.	Ø	L	B	C	BL/Kg	Box	*€/Stück *€/piece
8960405_70	5	70	25	15	370	10	3,40
8960406_80	6	80	30	16	440	10	4,40
8960408_90	8	90	35	23	905	10	6,10
8960410_110	10	110	40	27	1395	5	11,00

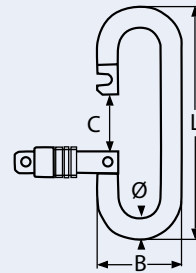

Karabinerhaken mit Schraubverbinder / A4-AISI 316

Spring hook with screw connector / Mousqueton avec vis de raccord

8961

Bestell-Nr. Order no.	Ø	B	L	C	D	BL/Kg	Box	*€/Stück *€/piece
8961404_61	4	32	61	11	19	850	10	2,90
8961405_70	5	37	70	13	22	1350	10	3,60
8961406_82	6	42	82	14	25	2000	10	4,00
8961408_100	8	53	100	17	31	3300	10	7,40
8961410_118	10	63	118	20	36	5500	5	12,00
8961412_144	12	76	144	23	43	7500	5	18,60

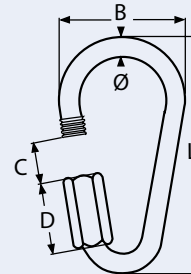

Karabinerhaken, asymmetrisch mit Kausche / A4-AISI 316

Asymmetric spring hook with eyelet / Mousqueton pompier asymétrique avec œil

8322

Bestell-Nr. Order no.	Ø	L	C	D	B	BL/Kg	Box	*€/Stück *€/piece
8322408_80	8	80	13	11	45	870	10	7,00
8322410_100	10	100	18	14	58	1350	5	9,00
8322411_120	11	120	24	18	70	1500	5	12,00

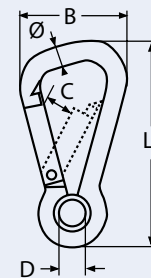

Karabinerhaken / A4-AISI 316

Spring hook / Mousqueton à œil

8251

Bestell-Nr. Order no.	L	B	C	D	BL/Kg	Box	*€/Stück *€/piece
82514050	50	24	10	10,5	200	10	4,00
82514070	70	31	12	13,0	700	10	5,00
82514100	100	46	22	21,0	1800	5	6,00

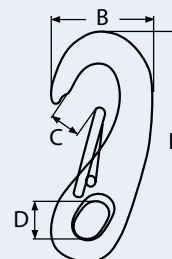

1

Schäkel, Karabinerhaken und Wirbel

Shackles, spring hooks and swivels

Manilles, mousquetons, emerillons

8293

Karabinerhaken mit Spezialverschluss / A4-AISI 316

Spring hook with special closure / Mousqueton pompier grand passage

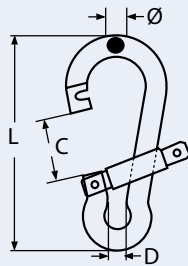

Bestell-Nr. Order no.	Ø	L	D	C	BL/Kg	Box	*€/Stück *€/piece
8293408_80	8	80	8,0	15	800	10	6,00
8293410_100	10	100	10,5	17	1200	5	8,20
8293411_120	11	120	15,0	23	2000	5	11,70

8294

Karabinerhaken mit Spezialverschluss und Kausche / A4-AISI 316

Snap hook with special closure and eyelet / Mousqueton pompier à œil grand passage

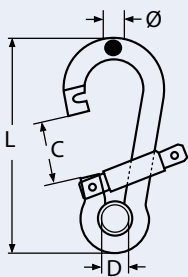

Bestell-Nr. Order no.	Ø	L	C	D	BL/Kg	Box	*€/Stück *€/piece
8294408_80	8	80	19	10	800	10	5,80
8294410_100	10	100	22	14	1200	5	9,20
8294411_120	11	120	26	17	2000	5	11,60

8257

Schnapphaken mit Wirbelauge / A4-AISI 316

Swivel eye snap / Mousqueton à emerillon

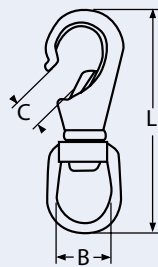

Bestell-Nr. Order no.	C	B	L	BL/Kg	Box	*€/Stück *€/piece
8257416	11	21	86,0	150	5	6,70
8257419	12	21	99,5	250	5	7,00
8257422	16	21	117,5	350	5	8,40

8303

Wirbelkarabiner / A4-AISI 316

Swivel eye bolt snap / Mousqueton targette à émerillon

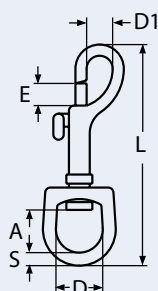

Bestell-Nr. Order no.	D	D1	S	A	L	E	Box	*€/Stück *€/piece
8303409	9	7	3	10,5	62	7	10	5,00
8303412	12	8	4	13,5	75	8	10	5,10
8303416	16	9	4	15,5	87	9	5	5,40
8303419	19	9	5	19,0	90	9	5	5,80

Schäkel, Karabinerhaken und Wirbel

Shackles, spring hooks and swivels
Manilles, mousquetons, emerillons

1

1

Schnapphaken mit Wirbel / A4-AISI 316

Trigger snap with eye bail / Mousqueton gachette à émerillon

8534

Bestell-Nr. Order no.	D	L	L1	Box	*€/Stück *€/piece
8534413	13	65	16	5	6,80
8534416	16	65	19	5	7,80

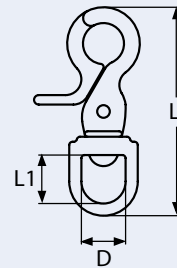

Doppelkarabiner / A4-AISI 316

Double snap hook / Mousqueton à targette double

8416

Bestell-Nr. Order no.	L	C	D	BL/Kg	Box	*€/Stück *€/piece
84164115	115	10	11	200	5	8,00

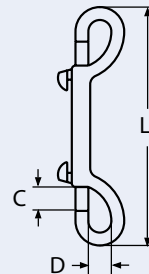

Sicherheitskarabinerhaken mit zweifacher Sperre / A4-AISI 316

Safety spring hook with double locking equipment / Mousqueton de sécurité avec double fermeture

8338

Bestell-Nr. Order no.	L	D	C	B	BL/Kg	Box	*€/Stück *€/piece
8338410_110	110	20	19	62	1400	5	14,00

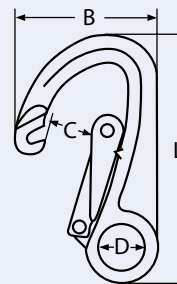

Schnappschäkel mit Wirbelschäkel / A4-AISI 316

Swivel snap shackle / Mousqueton de drisse à chape

8262

Bestell-Nr. Order no.	L	H	C	B	A	BL/Kg	Box	*€/Stück *€/piece
82624070	70	9	12	33	12	1900	5	15,00
82624087	87	15	16	42	13	2900	5	17,00
82624128	128	20	22	58	22	3900	5	22,00

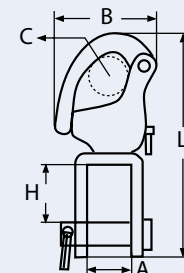

1

Schäkel, Karabinerhaken und Wirbel

Shackles, spring hooks and swivels

Manilles, mousquetons, emerillons

8252

Schnappschäkel mit Wirbelauge / A4-AISI 316

Swivel snap shackle / Mousqueton de drisse à émerillon

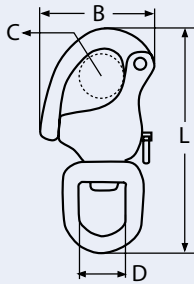

Bestell-Nr. Order no.	L	C	D	B	BL/Kg	Box	*€/Stück *€/piece
82524070	70	12	12	33	1400	5	12,40
82524087	87	16	16	42	2400	5	15,00
82524128	128	22	22	58	3500	5	18,00

8288

Schnappschäkel / A4-AISI 316

Fixed snap shackle / Mousqueton de drisse à œil fixe

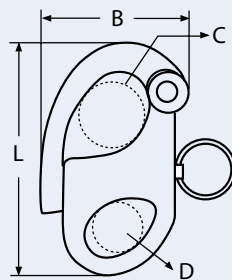

Bestell-Nr. Order no.	L	C	D	B	BL/Kg	Box	*€/Stück *€/piece
8288435	35	9	6	23	800	5	11,00
8288445	45	10	8	29	1500	5	11,00
8288452	52	12	9	35	1500	5	11,00
8288466	66	16	12	45	2700	5	12,00
8288496	96	22	16	60	4600	5	14,00

8290

Schotschäkel / A4-AISI 316

Sheet snap shackle / Mousqueton d'écoute

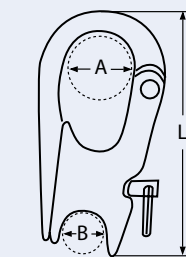

Bestell-Nr. Order no.	L	B	A	Box	*€/Stück *€/piece
8290452	52	12	10	5	9,00
8290466	66	15	14	5	14,00
8290496	96	25	18	5	18,00

8289

Schnappschäkel mit Schraube / A4-AISI 316

Snap shackle with screw / Mousqueton de drisse à vis

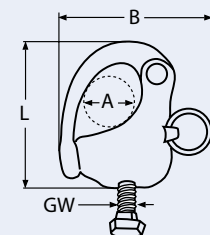

Bestell-Nr. Order no.	GW	A	L	B	Box	*€/Stück *€/piece
8289406	M6	12	42	30	5	13,00
8289408	M8	16	53	40	5	15,00
8289410	M10	22	75	62	5	18,00

Schäkel, Karabinerhaken und Wirbel

Shackles, spring hooks and swivels

Manilles, mousquetons, emerillons

1

1

Schnappschäkel mit Wirbelauge / A4-AISI 316

Swivel snap shackle / Mousqueton de largage rapide à émerillon

8661

Bestell-Nr. Order no.	L	A	B	BL/Kg	Box	*€/Stück *€/piece
86614085	85	18	12	1500	1	19,00
86614105	105	24	14	2500	1	24,00
86614125	125	27	18	3500	1	31,00

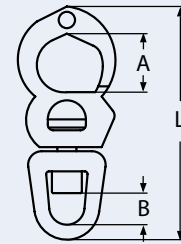

Stagreiter / A4-AISI 316

Knock on piston hank / Bague de foc à materillon

8533

Bestell-Nr. Order no.	L	A	B	BL/Kg	Box	*€/Stück *€/piece
8533450	50	6,5	25	250	10	4,00
8533465	65	10	35	550	10	6,00
8533490	90	13	49	1000	5	9,70

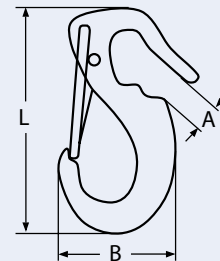

Wirbel, Auge-Auge / A4-AISI 316

Eye and eye swivel / Emerillon œil / œil

8254

Bestell-Nr. Order no.	Ø	L	B	A	BL/Kg	Box	*€/Stück *€/piece
8254405	5	60	13	13	820	10	3,60
8254406	6	65	15	15	1350	10	3,80
8254408	8	90	22	20	2500	10	6,00
8254410	10	115	27	24	3500	5	9,00
8254413	13	154	35	32	6000	1	21,00
8254416	16	188	45	39	10800	1	43,00
8254419	19	231	50	41	16100	1	73,00

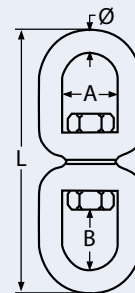

Wirbelschäkel, Auge-Gabel / A4-AISI 316

Eye and jaw swivel shackle / Emerillon œil / manille

8255

Bestell-Nr. Order no.	Ø	L	B	A	BL/Kg	Box	*€/Stück *€/piece
8255405	5	60	10	11,5	640	10	5,50
8255406	6	66	12	11	1350	10	5,50
8255408	8	94	16	16	2500	10	6,20
8255410	10	118	22	22	3500	5	13,00
8255413	13	152	28	28	6000	1	22,00
8255416	16	188	34	37	9800	1	48,00
8255419	19	229	38	45	15000	1	87,00

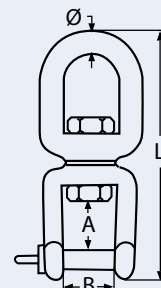

1

Schäkel, Karabinerhaken und Wirbel

Shackles, spring hooks and swivels

Manilles, mousquetons, emerillons

8256

Wirbelschäkel, Gabel-Gabel / A4-AISI 316

Jaw and jaw swivel shackle / Emerillon à manille double

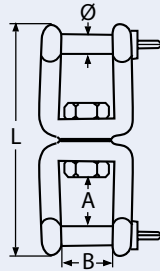

Bestell-Nr. Order no.	Ø	L	B	A	BL/Kg	Box	*€/Stück *€/piece
8256405	5	60	10	11	600	10	3,20
8256406	6	66	12	11	1350	10	6,50
8256408	8	94	16	16	2500	10	8,00
8256410	10	118	20	22	3500	5	13,00
8256413	13	152	28	28	6000	1	26,00
8256416	16	188	34	37	9800	1	46,50
8256419	19	229	38	45	15000	1	82,00

8535

Wirbelschäkel, Gabel-Gabel mit Innensechskant / A4-AISI 316

Jaw and jaw swivel shackle with hexagon socket / Emerillon à manille double avec vis six pans creux

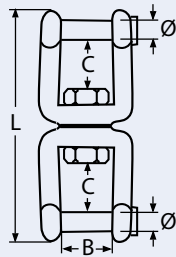

Bestell-Nr. Order no.	Ø	L	B	C	BL/Kg	Box	*€/Stück *€/piece
8535405	5	60	10	11	600	10	3,50
8535406	6	66	12	11	1350	10	8,30
8535408	8	94	16	16	2500	10	11,70
8535410	10	118	20	22	3500	5	18,00
8535413	13	152	26	28	6000	1	29,80
8535416	16	188	34	37	10800	1	56,00
8535419	19	229	38	45	16100	1	82,20

8364

Wirbelschäkel, flach, Gabel-Gabel / A2-AISI 304

Jaw and jaw flat swivel shackle / Emerillon à 2 chapes

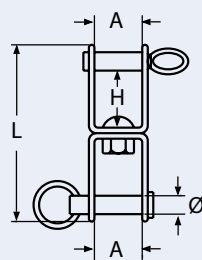

Bestell-Nr. Order no.	Ø	A	L	H	Box	*€/Stück *€/piece
8364212_47	5	12	47	10	10	8,20
8364214_55	6	14	62	11	10	9,00

Yacht- und Bootszubehör
auf Blisterkarten

Fasteners and nautical
accessories on blister cards



Schäkel, Karabinerhaken und Wirbel

Shackles, spring hooks and swivels

Manilles, mousquetons, emerillons

1

1

Wirbelschäkel, Auge-Gabel mit Innensechskant / A4-AISI 316

Eye and jaw swivel shackle with hexagon socket / Emerillon à œil et manille avec vis six pans creux

814105

Bestell-Nr. Order no.	Ø	L	A	B	BL/Kg	Box	*€/Stück *€/piece
814105405	5	60	11	10	400	10	3,40
814105406	6	66	12	12	600	10	4,20
814105408	8	92	16	16	1200	10	8,50
814105410	10	118	22	20	2000	5	15,40
814105413	13	152	28	26	4000	1	32,00
814105416	16	188	34	32	6000	1	62,00
814105419	19	229	44	38	8000	1	71,00

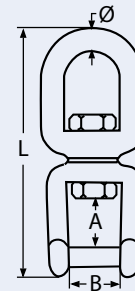

Wasserskihaken / A4-AISI 316

Waterski hook / Crochet pour ski nautique

8485

Bestell-Nr. Order no.	C	L	B	BL/Kg	Box	*€/Stück *€/piece
8485460	16	60	36,5	800	5	14,50

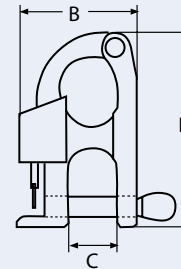

Karabinerhaken, Alu - verschiedene Farben

Alu snap hook, different colors / Mousqueton en Alu - couleurs différente

8488

Bestell-Nr. Order no.	Ø	L	A1	A	C	BL/Kg	Box	*€/Stück *€/piece
848805_50	5	50	6	10	8	100	10	1,10
848806_60	6	60	8	11	9	160	10	1,20
848808_80	8	80	8	13	9	350	10	1,40

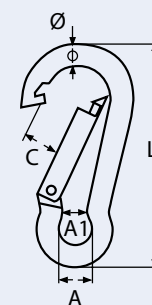

Simplex - Karabinerhaken / A2-AISI 304

Simplex spring hook / Mousqueton simple

814387

Bestell-Nr. Order no.	L	D	E	F	Box	*€/Stück *€/piece
814387230	30	5,6	1,4	3,6	100	0,40
814387240	40	8,2	1,5	5,0	100	0,60
814387250	50	9,2	2,4	6,3	50	1,00
814387260	60	11,3	3,0	7,1	50	1,30

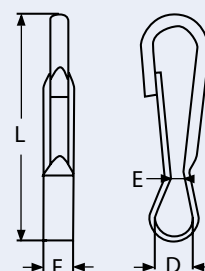

1

Schäkel, Karabinerhaken und Wirbel

Shackles, spring hooks and swivels

Manilles, mousquetons, emerillons

814656

Brummelhaken / A4-AISI 316

Eye hook / Crochet Accélérateur

NEW

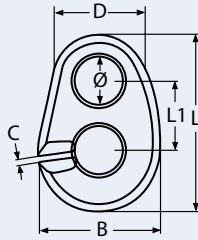

Bestell-Nr. Order no.	Ø	L	B	D	L1	C	Box	*€/Stück *€/piece
814656406	16	57,5	38	27	22,3	2	10	4,40

814668

Karabinerhaken / Alu

Spring hook / Mousqueton Alu

NEW

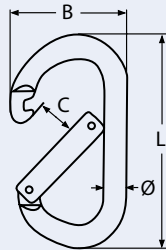

Bestell-Nr. Order no.	Ø	L	B	C	BL/Kg	Box	*€/Stück *€/piece
814668012 113	12	113	62,5	22	2400	5	8,60

814669

Karabinerhaken mit Sicherungsmutter / Alu

Spring hook with safety screw / Mousqueton Alu

NEW

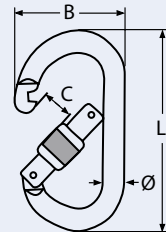

Bestell-Nr. Order no.	Ø	L	B	C	BL/Kg	Box	*€/Stück *€/piece
814669012 113	12	113	62,5	19	2400	5	10,20

814670

Karabinerhaken / Alu

Spring hook / Mousqueton Alu

NEW

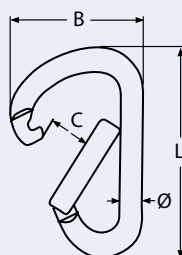

Bestell-Nr. Order no.	Ø	L	B	C	BL/Kg	Box	*€/Stück *€/piece
814670012 116	12	116,5	74,5	24,5	2400	5	9,60

Schäkel, Karabinerhaken und Wirbel

Shackles, spring hooks and swivels
Manilles, mousquetons, emerillons

1

1

NEW

Karabinerhaken / Alu
Spring hook / Mousqueton Alu

814671

Bestell-Nr. Order no.	Ø	L	B	C	BL/Kg	Box	*€/Stück *€/piece
814671011 100	11	100	58,5	25	2200	5	7,50

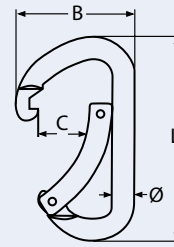

NEW

Karabinerhaken / Alu
Spring hook / Mousqueton Alu

814672

Bestell-Nr. Order no.	Ø	L	B	C	BL/Kg	Box	*€/Stück *€/piece
814672012 111	12	111,5	66,8	21,5	2600	5	8,50

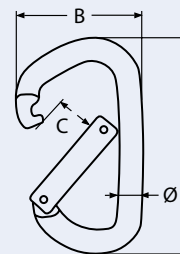

NEW

Karabinerhaken mit Sicherungsmutter / Alu
Spring hook with safety screw / Mousqueton Alu

814673

Bestell-Nr. Order no.	Ø	L	B	C	BL/Kg	Box	*€/Stück *€/piece
814673012 111	12	111,5	66,8	19	2600	5	10,00

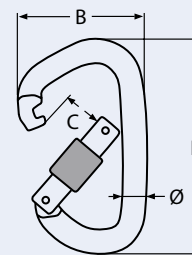

NEW

Karabinerhaken mit Sicherungsmutter / Alu
Spring hook with safety screw / Mousqueton Alu

814674

Bestell-Nr. Order no.	Ø	L	B	C	BL/Kg	Box	*€/Stück *€/piece
814674012 116	12	116,5	74,5	22	2400	5	11,10

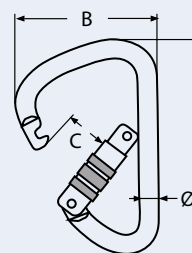

1

Schäkel, Karabinerhaken und Wirbel

Shackles, spring hooks and swivels

Manilles, mousquetons, emerillons

8493

Karabinerhaken mit Einpunkt-Sicherung / Alu

Single point alu spring hook / Mousqueton en Alu, 1 point de protection

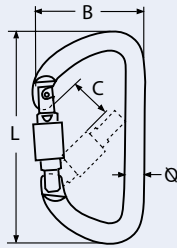

Bestell-Nr. Order no.	Ø	L	B	C	BL/Kg	Box	*€/Stück *€/piece
8493011_116	11	116	64	22	2200	5	13,00

8494

Sicherungskarabinerhaken / Alu

Safety spring hook / Mousqueton de sécurité en Alu à œil

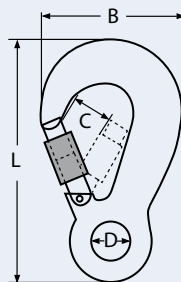

Bestell-Nr. Order no.	L	D	C	B	BL/Kg	Box	*€/Stück *€/piece
84940130	130	21	21	80	2000	5	12,20

8490

Karabinerhaken mit Einpunkt-Sicherung, 1/4 Drehung / Alu

1/4 turn single point spring hook / Mousqueton en Alu - 1 point de protection - 1/4 de tour

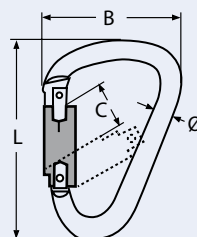

Bestell-Nr. Order no.	Ø	L	B	C	BL/Kg	Box	*€/Stück *€/piece
8490012_120	12	120	80	25	2400	5	12,70
8490014_190	14	190	104	46	2600	5	22,20

8492

Abseilachter / Alu

Alu figure eight descender / Crochet en huit

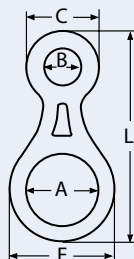

Bestell-Nr. Order no.	L	A	B	C	E	BL/Kg	Box	*€/Stück *€/piece
84920145	145	51	26	48	76	3000	5	9,90

8491

Steigklemme, Fallsicherung / A2-AISI 304

Rope shortener / Kit d'ascension

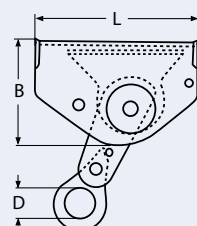

Bestell-Nr. Order no.	Seil-Ø Rope-Ø	L	B	D	Box	*€/Stück *€/piece
8491212	12	122	78	22	1	38,00
8491216	16	122	78	22	1	39,50

Kapitel 2 Chapter 2

Spannschlösser, Terminals und Drahtseile Turnbuckles, terminals and wire ropes

2



Spannschlösser, Terminals und Drahtseile

Turnbuckles, terminals and wire ropes

Tendeurs, ridoirs, embouts à sertir et câbles

8245

Wantenspanner Gabel-Gabel / A4-AISI 316

Turnbuckle with two forks / Ridoir corps fermé chape fixes

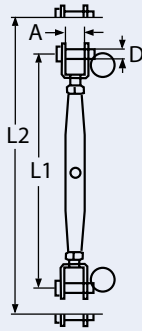

Bestell-Nr. Order no.	GW	L1	L2	A	D	BL/Kg	Box	*€/Stück *€/piece
8245404	M4	110	170	5,5	4	650	10	5,00
8245405	M5	130	190	6,5	5	900	10	6,00
8245406	M6	150	220	7,5	6	1250	10	7,00
8245408	M8	165	240	11	8	1750	10	12,00
8245410	M10	190	280	12	9	3500	5	16,00
8245412	M12	245	360	14	12	5100	5	28,00
8245414	M14	270	390	15	12	5900	1	34,00
8245416	M16	310	450	17	16	8000	1	60,00
8245420	M20	360	510	20	19	13000	1	104,00

8275

Wantenspanner Gabel-Terminal / A4-AISI 316

Turnbuckle with fork and terminal / Ridoir corps fermé chape fixe terminaison à sertir

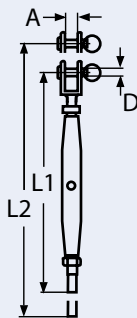

Bestell-Nr. Order no.	GW	DS-Ø	L1	L2	A	D	Box	€/Stück *€/piece
8275405/25	M5	2,5	155	215	6	5	10	6,00
8275406/3	M6	3	175	245	7,5	6	10	7,00
8275406/4	M6	4	185	255	7,5	6	10	8,00
8275408/4	M8	4	200	275	11	8	10	10,00
8275408/5	M8	5	205	280	11	8	10	11,00
8275410/5	M10	5	230	320	12	9	5	15,00
8275410/6	M10	6	245	335	12	9	5	20,00
8275412/6	M12	6	285	400	14	12	5	26,00
8275412/8	M12	8	305	420	14	12	5	34,00
8275414/7	M14	7	315	435	15	15	1	35,00
8275416/8	M16	8	360	500	17	17	1	55,00
8275416/10	M16	10	370	510	17	16	1	58,00
8275420/10	M20	10	410	560	20	20	1	83,00
8275420/12	M20	12	410	560	20	20	1	97,00

Weitere Größen auf Anfrage.

Other sizes available on request.

Spannschlösser, Terminals und Drahtseile

Turnbuckles, terminals and wire ropes
Tendeurs, ridoirs, embouts à sertir et câbles

2

Wantenspanner Toggle-Terminal / A4-AISI 316

Turnbuckle with toggle and terminal / Ridoir corps fermé chape articulé à sertir

8276

Bestell-Nr. Order no.	GW WR-Ø	DS-Ø	L1	L2	A	D	Box	€/Stück *€/piece
8276406/3	M6	3	180	250	7	6	10	9,00
8276406/4	M6	4	190	260	7	6	10	10,00
8276408/4	M8	4	210	285	10	8	10	12,00
8276408/5	M8	5	215	290	10	8	10	13,00
8276410/5	M10	5	250	340	12	9	5	20,00
8276410/6	M10	6	265	355	12	9	5	24,00
8276412/6	M12	6	300	410	13	12	5	34,00
8276412/8	M12	8	320	430	13	12	5	41,00
8276414/7	M14	7	328	453	15	14	1	45,00
8276416/8	M16	8	390	530	17	16	1	77,00
8276416/10	M16	10	400	540	17	16	1	87,00
8276420/10	M20	10	450	590	20	19	1	115,00

Weitere Größen auf Anfrage.
Other sizes available on request.

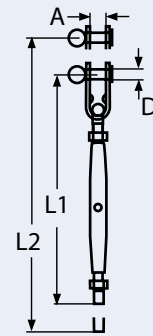

2

Sliphaken mit Ring / A4-AISI 316

Slip hook with ring / Crochet coulissant à anneau

814167

Bestell-Nr. Order no.	L	D1	Ø	Kopfbreite Thickness of head	Box	€/Stück *€/piece
8141674132_5	132	5,1	5	7,1	5	2,20
8141674142_6	142	6,2	6	9,6	5	3,30
8141674192_8	192	8,5	8	11,3	2	8,00
8141674235_12	235	13,0	12	14,4	2	18,00

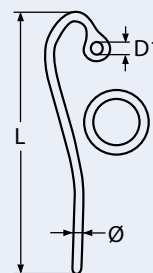

2

Spannschlösser, Terminals und Drahtseile

Turnbuckles, terminals and wire ropes

Tendeurs, ridoirs, embouts à sertir et câbles

8418

Spannschlossmutter ähnlich DIN 1478 / A4-AISI 316

Turnbuckle sleeve / Cage fermé de ridoir

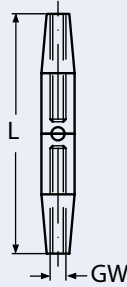

Bestell-Nr. Order no.	GW	L	Box	*€/Stück *€/piece
8418405	M5	80	10	1,80
8418406	M6	95	10	2,50
8418408	M8	105	10	3,70
8418410	M10	125	5	6,20
8418412	M12	150	5	9,60
8418414	M14	165	1	12,30
8418416	M16	190	1	17,70
8418420	M20	210	1	29,40

Weitere Größen auf Anfrage.

Other sizes available on request.

8246

Spannschloss / A4-AISI 316

Turnbuckle / Tendeur oeil/oeil - oeil/crochet - crochet/crochet

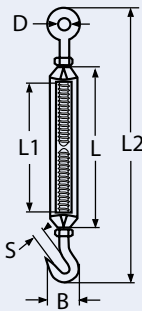

Bestell-Nr. Order no.	GW	L	L1	L2	B	D	S	BL/Kg	Box	*€/Stück *€/piece
82464 ¹ X04	M4	58	44	90	13	6	6	120	10	1,80
82464 ¹ X05	M5	70	52	120	13	8	9	160	10	2,30
82464 ¹ X06	M6	90	66	160	16	10	10	320	10	3,20
82464 ¹ X08	M8	120	94	200	20	14	11	560	10	5,60
82464 ¹ X10	M10	150	120	240	28	16	12	880	5	9,40
82464 ¹ X12	M12	200	168	300	36	18	14	1200	5	16,00
82464 ¹ X16	M16	250	210	390	40	26	16	2400	1	35,00
82464 ¹ X20	M20	300	245	440	50	30	18	3600	1	66,00

¹X: A = Öse-Öse / A = Eye-Eye

B = Haken-Haken / B = Hook-Hook

C = Öse-Haken / C = Eye-Hook

8339

Wantenspanner Gabel-Gabel / A4-AISI 316

Turnbuckle with two forks / Tendeur à chape fixe

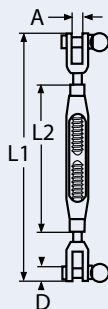

Bestell-Nr. Order no.	GW	L1	L2	A	D	BL/Kg	Box	*€/Stück *€/piece
8339405	M5	120	70	6,5	5	500	10	6,00
8339406	M6	140	90	7,5	6	600	10	7,00
8339408	M8	180	120	11	8	1100	10	12,00
8339410	M10	220	150	12	9	1750	5	19,00
8339412	M12	300	200	14	12	2300	5	32,00
8339414	M14	325	220	15	12	3600	1	46,00
8339416	M16	375	250	17	16	6800	1	70,00
8339420	M20	450	300	20	19	8200	1	110,00

Spannschlösser, Terminals und Drahtseile

Turnbuckles, terminals and wire ropes
Tendeurs, ridoirs, embouts à sertir et câbles

2

Wantenspanner Gabel-Gabel, Gabelkopf aus gedrehtem Material / A4-AISI 316 Turnbuckle with two forks, milled forkhead / Ridoirs corps fermé chape fixe usinée terminaison à sertir

814065

Bestell-Nr. Order no.	GW	L1	L2	A	D	BL/Kg	Box	*€/Stück *€/piece
814065405	M5	135	195	6,5	5	460	10	8,00
814065406	M6	160	230	7,5	6	910	10	12,00
814065408	M8	180	255	11	8	1330	10	20,00
814065410	M10	210	300	12	9	2180	5	30,00
814065412	M12	270	380	14	12	2300	5	50,00
814065414	M14	295	415	15	12	2190	1	64,00
814065416	M16	340	480	17	16	5310	1	120,00

Weitere Größen auf Anfrage.
Other sizes available on request.

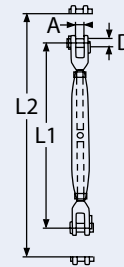

2

Wantenspanner Gabel-Terminal, Gabelkopf aus gedrehtem Material / A4-AISI 316 Turnbuckle fork-terminal, milled forkhead / Ridoirs corps fermé chape fixe usinée terminaison à sertir

814066

Bestell-Nr. Order no.	GW	DS-Ø WR-Ø	L1	L2	A	D	Box	*€/Stück *€/piece
814066405/25	M5	2,5	155	215	6,5	5	10	7,00
814066406/3	M6	3	180	250	7,5	6	10	9,00
814066406/4	M6	4	190	260	7,5	6	10	11,00
814066408/4	M8	4	210	285	11	8	10	15,00
814066408/5	M8	5	215	290	11	8	10	16,00
814066410/5	M10	5	240	330	12	9	5	23,00
814066410/6	M10	6	255	345	12	9	5	27,00
814066412/6	M12	6	300	410	14	12	5	35,00
814066412/8	M12	8	320	430	14	12	5	48,00
814066414/7	M14	7	330	450	15	12	1	34,00
814066416/8	M16	8	370	510	17	16	1	86,00
814066416/10	M16	10	380	520	17	16	1	93,00

Weitere Größen auf Anfrage.
Other sizes available on request.

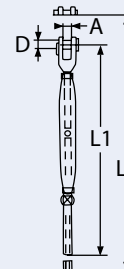

Spannschlösser, Terminals und Drahtseile

Turnbuckles, terminals and wire ropes

Tendeurs, ridoirs, embouts à sertir et câbles

8417

Spannschlossmutter ähnlich DIN 1480 / A4-AISI 316

Turnbuckle sleeve / Cage ouverte de ridoir



Bestell-Nr. Order no.	GW	L	Box	*€/Stück *€/piece
8417406	M6	90	10	2,00
8417408	M8	120	10	3,00
8417410	M10	150	5	5,00
8417412	M12	200	5	8,00
8417416	M16	250	1	18,00
8417420	M20	300	1	34,00

8307

Gewindeterminal mit Mutter, rechts / A4-AISI 316

Swage stud with nut, right thread / Terminaison filetée à sertir, pas à droite

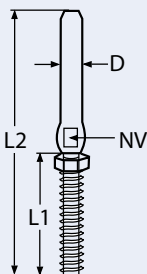
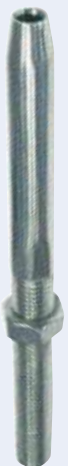

Bestell-Nr. Order no.	GW	DS-Ø WR-Ø	L1	L2	NV	D	Box	*€/Stück *€/piece
8307405/25	M5	2,5	40	86	4	5,5	10	2,00
8307406/3	M6	3	48	100	5	6,5	10	2,40
8307406/4	M6	4	48	110	6	7,5	10	3,00
8307408/4	M8	4	57	117	6	7,5	10	3,60
8307408/5	M8	5	57	124	7	9,0	10	4,00
8307410/5	M10	5	63	130	7	9,0	5	4,40
8307410/6	M10	6	63	145	10	12,5	5	8,50
8307412/6	M12	6	80	162	10	12,5	5	9,50
8307412/8	M12	8	80	180	14	16,0	5	16,00
8307414/7	M14	7	90	180	12	14,2	1	18,00
8307416/8	M16	8	100	200	14	16,0	1	19,50
8307416/10	M16	10	100	210	15	18,0	1	23,50
8307420/10	M20	10	119	230	15	18,0	1	28,50
8307420/12	M20	12	120	245	17	20,0	1	33,90
8307422/14	M22	14	140	308	22	25,0	1	65,00
8307424/16	M24	16	170	363	24	28,0	1	87,00

Weitere Größen auf Anfrage.

Other sizes available on request.

Spannschlösser, Terminals und Drahtseile

Turnbuckles, terminals and wire ropes
Tendeurs, ridoirs, embouts à sertir et câbles

2

Gewindeterminal mit Mutter, links / A4-AISI 316

Swage stud with nut, left thread / Terminaison filetée à sertir inox, pas à gauche

8467

Bestell-Nr. Order no.	GW	DS-Ø WR-Ø	L1	L2	NV	D	Box	€/Stück *€/piece
8467405/25	M5	2,5	40	86	4	5,5	10	2,00
8467406/3	M6	3	48	100	5	6,5	10	2,40
8467406/4	M6	4	48	110	6	7,5	10	3,00
8467408/4	M8	4	57	117	6	7,5	10	3,60
8467408/5	M8	5	57	124	7	9,0	10	4,00
8467410/5	M10	5	63	130	7	9,0	5	4,40
8467410/6	M10	6	63	145	10	12,5	5	8,50
8467412/6	M12	6	80	162	10	12,5	5	9,50
8467412/8	M12	8	80	180	14	16,0	5	16,00
8467414/7	M14	7	90	180	12	14,2	1	18,00
8467416/8	M16	8	100	200	14	16,0	1	19,50
8467416/10	M16	10	100	210	15	18,0	1	23,50
8467420/10	M20	10	119	230	15	18,0	1	28,50
8467420/12	M20	12	120	245	17	20,0	1	33,90

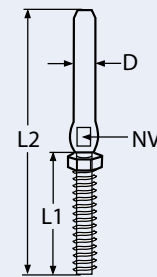

2

Terminal mit Holzgewinde, rechts / A4-AISI 316

Swage stud with wood thread, right / Terminaison avec filetage bois pas à droite

814087

Bestell-Nr. Order no.	DS-Ø WR-Ø	D	L	L1	L2	K	H	Box	€/Stück *€/piece
814087403	3	6	97	48	38	5	8	10	2,10
814087404	4	8	115	54	45	6	10	10	2,70
814087405	5	10	128	61	52	7	10	5	5,40
814087406	6	12	162	79	63	10	10	5	11,60

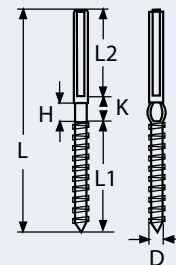

Terminal mit Holzgewinde, links / A4-AISI 316

Swage stud with wood thread, left / Terminaison avec filetage bois pas à gauche

814088

Bestell-Nr. Order no.	DS-Ø WR-Ø	D	L	L1	L2	K	H	Box	€/Stück *€/piece
814088403	3	6	97	48	38	5	8	10	2,20
814088404	4	8	115	54	45	6	10	10	2,80
814088405	5	10	128	61	52	7	10	5	7,50
814088406	6	12	162	79	63	10	10	5	13,60

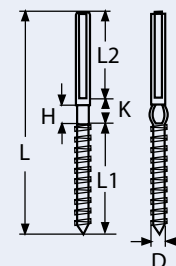

2

Spannschlösser, Terminals und Drahtseile

Turnbuckles, terminals and wire ropes

Tendeurs, ridoirs, embouts à sertir et câbles

8484

Anschweißenden, rechts / A4-AISI 316

Bult ends, right thread / Terminaison à souder avec filetage pas à droite

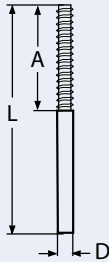

Bestell-Nr. Order no.	GW	L	A	D	Box	*€/Stück *€/piece
8484405	M5	85	40	4,4	10	1,50
8484406	M6	100	45	5,2	10	1,80
8484408	M8	112	52	7,0	10	2,00
8484410	M10	127	62	8,8	5	5,90
8484412	M12	140	75	10,7	5	7,00
8484414	M14	150	82	12,5	1	12,00
8484416	M16	170	95	14,2	1	15,00
8484420	M20	185	105	18,1	1	17,80

8511

Anschweißenden, links / A4-AISI 316

Bult ends, left thread / Terminaison à souder avec filetage pas à gauche

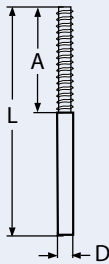

Bestell-Nr. Order no.	GW	L	A	D	Box	*€/Stück *€/piece
8511405	M5	85	40	4,4	10	1,50
8511406	M6	100	45	5,2	10	1,80
8511408	M8	112	52	7,0	10	2,00
8511410	M10	127	62	8,8	5	5,90
8511412	M12	140	75	10,7	5	7,00
8511414	M14	150	82	12,5	1	12,00
8511416	M16	170	95	14,2	1	15,00
8511420	M20	185	105	18,1	1	17,80

8281

Augterminal / A4-AISI 316

Eye terminal / Embout à œil à sertir

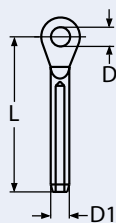

Bestell-Nr. Order no.	DS-Ø WR-Ø	D	D1	L	Box	*€/Stück *€/piece
82814025	2,5	5,4	5,5	48,5	10	1,50
8281403	3	6,5	6,35	55	10	1,80
8281404	4	8,5	7,5	65	10	2,40
8281405	5	10,5	9,0	80	5	2,90
8281406	6	12,5	12,5	94	5	5,80
8281407	7	12,7	14,0	105	5	7,90
8281408	8	14,5	16,0	124	1	12,00
8281410	10	16,4	17,8	142	1	17,00
8281412	12	19,3	19,5	160	1	23,00

Spannschlösser, Terminals und Drahtseile

Turnbuckles, terminals and wire ropes
Tendeurs, ridoirs, embouts à sertir et câbles

2

T-Terminal / A4-AISI 316

T-terminal / Embout en T, à sertir

8282

Bestell-Nr. Order no.	DS-Ø WR-Ø	L	Box	*€/Stück *€/piece
8282403	3	85	10	2,60
8282404	4	100	10	6,60
8282405	5	115	10	6,80
8282406	6	140	5	7,10
8282407	7	145	5	13,00
8282408	8	185	1	14,00
8282410	10	215	1	28,00

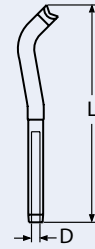

2

Halteplatte für T-Terminal / A4-AISI 316

Back plate for T-terminal / Plaque d'ancrage pour terminal en T

8302

Bestell-Nr. Order no.	DS-Ø WR-Ø	L	L1	D1	D	B	Box	*€/Stück *€/piece
8302404	4	88	27	9,9	5,0	27	10	1,60
8302405	5	88	27	9,9	5,0	27	10	2,80
8302406	6	122	35	15,6	6,3	39	5	4,80
8302407	7	122	35	15,9	6,4	39	5	5,10
8302408	8	151	41	18,8	6,5	39	1	9,40
8302410	10	151	41	18,8	6,5	39	1	12,30

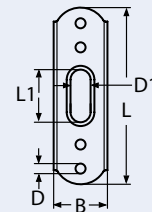

Toggle-Terminal / A4-AISI 316

Toggle terminal / Embout à chape articulée à sertir

8483

Bestell-Nr. Order no.	DS-Ø WR-Ø	L	D	A	H	Box	*€/Stück *€/piece
8483403	3	75	6	7	15	5	10,30
8483404	4	89	8	10	20	5	11,30
8483405	5	104	9	12	25	5	13,10
8483406	6	127	12	13	30	5	16,00
8483408	8	163	16	17	40	1	32,50
8483410	10	184	19	20	45	1	54,00

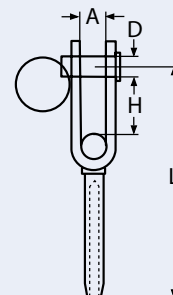

2

Spannschlösser, Terminals und Drahtseile

Turnbuckles, terminals and wire ropes

Tendeurs, ridoirs, embouts à sertir et câbles

8280

Gabelterminal / A4-AISI 316

Fork terminal / Embout à chape fixe à sertir

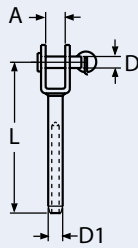

Bestell-Nr. Order no.	DS-Ø WR-Ø	D	D1	A	L	Box	*€/Stück *€/piece
82804025	2,5	5	5,5	6,5	55	10	2,00
8280403	3	6	6,4	7,5	65	10	2,30
8280404-6	4	7,5	6	10	77	10	4,00
8280404	4	8	7,5	11	77	10	4,00
8280405	5	9	9,0	12	88	5	5,40
8280406	6	12	12,5	14	106	5	8,50
8280407	7	12	14,3	15	116	5	12,30
8280408	8	16	16,1	17	145	5	21,50
8280410	10	18	20,6	20	150	1	33,00
8280412	12	19	24,8	23	195	1	41,00
8280414	14	22	25,0	30	232	1	81,00
8280416	16	25	28,0	30	264	1	110,00

814067

Gabelterminal, Gabelkopf aus gedrehtem Material / A4-AISI 316

Milled fork terminal / Embout à chape fixe usinée à sertir

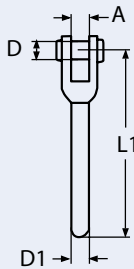

Bestell-Nr. Order no.	DS-Ø WR-Ø	L1	A	D	D1	Box	*€/Stück *€/piece
814067403	3	73	7,5	6	6,5	10	4,90
814067404	4	86	11	8	7,5	10	8,20
814067405	5	100	12	9	9,0	5	10,00
814067406	6	128	14	12	12,5	5	20,00
814067407	7	135	15	12	14,2	5	22,00
814067408	8	155	17	16	16,0	5	46,00

8278

Toggle / A4-AISI 316

Toggle for turnbuckles / Chape à œil

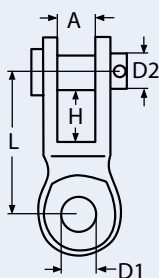

Bestell-Nr. Order no.	D1	D2	A	L	H	Box	*€/Stück *€/piece
8278405	5,5	5,2	6	22	7	5	2,00
8278406	6,6	6,3	7	27	9	5	2,20
8278408	8,5	8,3	10	31	10	5	2,70
8278410	10,0	9,3	12	36	12	1	3,80
8278412	13,0	12,4	13	50	17	1	6,00
8278414	14,3	15,0	15	60	20	1	10,50
8278416	17,0	17,0	14	80	29	1	16,30

8486

Toggle mit Gewinde, rechts / A4-AISI 316

Toggle with right thread / Embout à chape articulée fileté, pas à droite

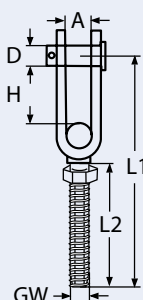

Bestell-Nr. Order no.	GW	L2	L1	D	A	H	Box	*€/Stück *€/piece
8486405	M5	42	62	5	6	13	10	3,00
8486406	M6	48	77	6	7	15	10	3,40
8486408	M8	56	94	8	10	20	5	5,60
8486410	M10	67	115	9	12	25	5	9,50
8486412	M12	81	136	12	13	30	5	14,50
8486414	M14	89	140	14	15	35	1	20,00
8486416	M16	103	163	16	17	40	1	33,00
8486420	M20	115	198	19	20	45	1	53,00

Spannschlösser, Terminals und Drahtseile

Turnbuckles, terminals and wire ropes
Tendeurs, ridoirs, embouts à sertir et câbles

2

Toggle mit Gewinde, links / A4-AISI 316

Toggle with left thread / Embout à chape articulée fileté, pas à gauche

8503

Bestell-Nr. Order no.	GW	L2	L1	D	A	H	Box	*€/Stück *€/piece
8503405	M5	42	62	5	6	13	10	3,20
8503406	M6	48	77	6	7	15	10	3,40
8503408	M8	56	94	8	10	20	5	5,60
8503410	M10	67	116	9	12	25	5	9,50
8503412	M12	81	136	12	13	30	5	14,50
8503414	M14	89	140	14	15	35	1	29,00
8503416	M16	103	163	16	17	40	1	33,00
8503420	M20	115	198	19	20	45	1	53,00

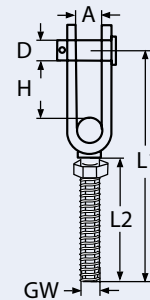

2

Wantenversteller / A2-AISI 304

Stay adjuster / Latte

8346

Bestell-Nr. Order no.	L	B	Bolzen Bolt	Box	*€/Stück *€/piece
83462104	104	15	5	5	3,00

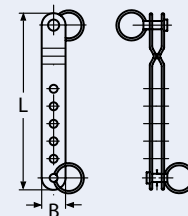

Wantenversteller / A2-AISI 304

Stay adjuster / Latte

8350

Bestell-Nr. Order no.	L	B	Bolzen Bolt	Box	*€/Stück *€/piece
83502100	100	15	5	5	5,10
83502155	155	15	5	5	6,40
83502200	200	15	5	5	8,40

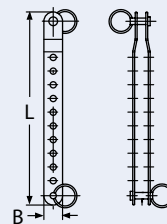

Pelikanhaken mit Gewinde / A4-AISI 316

Pelican hook with thread / Crochet pelican fileté

8283

Bestell-Nr. Order no.	GW	L	D	BL/Kg	Box	*€/Stück *€/piece
8283406	M6	75	18,5	1200	1	5,50
8283408	M8	100	27,0	1500	1	8,50
8283410	M10	144	35,0	3500	1	22,00
8283412	M12	150	39,0	3500	1	23,00

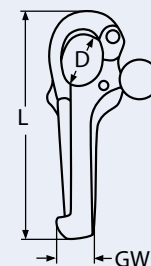

2

Spannschlösser, Terminals und Drahtseile

Turnbuckles, terminals and wire ropes

Tendeurs, ridoirs, embouts à sertir et câbles

814077

Pelikanhaken / A4-AISI 316

Pelikan hook / Crochet pélican

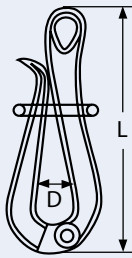

Bestell-Nr. Order no.	L	D	Box	*€/Stück *€/piece
8140774100	100	18	5	9,60
8140774150	150	22	5	17,20

8403

Montageaugterminal / A4-AISI 316

Quick attach eye terminal / Embout à œil à sertissage rapide

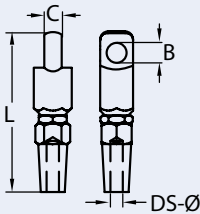

Bestell-Nr. Order no.	DS-Ø WR-Ø	B	C	L	Box	*€/Stück *€/piece
8403404	4	8	6,5	67	1	29,90
8403405	5	10	8	80	1	34,50
8403406	6	12	9	95	1	39,00
8403408	8	14	10	119	1	56,30

Für Seile: 1x19 – 7x7 – 7x19 · BL= 95% vom Seil

For wire: 1x19 – 7x7 – 7x19 · BL= 95% of wire

8404

Montagegabelterminal / A4-AISI 316

Quick attach jaw terminal / Embout à chape à sertissage rapide

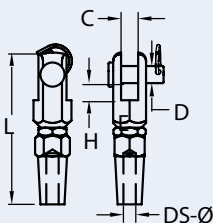

Bestell-Nr. Order no.	DS-Ø WR-Ø	D	C	L	H	Box	*€/Stück *€/piece
8404404	4	8	8	72	8	1	28,00
8404405	5	10	10	82	10	1	34,00
8404406	6	12	12	94	12	1	44,00
8404408	8	14	14	116	14	1	60,00

Für Seile: 1x19 – 7x7 – 7x19 · BL= 95% vom Seil

For wire: 1x19 – 7x7 – 7x19 · BL= 95% of wire

8406

Montagegewindeterminale / A4-AISI 316

Fast and bolt, quick attach thread terminal / Terminaison fileté à sertissage rapide

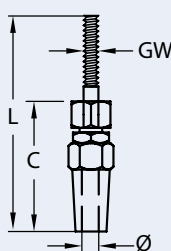

Bestell-Nr. Order no.	DS-Ø WR-Ø	GW	C	L	Box	€/Stück *€/piece
8406404	4	M8	57	100	1	32,00
8406405	5	M10	63	117	1	37,80
8406406	6	M12	80	145	1	60,00
8406408	8	M16	100	182	1	72,00

Für Seile: 1x19 – 7x7 – 7x19 · BL= 95% vom Seil

For wire: 1x19 – 7x7 – 7x19 · BL= 95% of wire

Spannschlösser, Terminals und Drahtseile

Turnbuckles, terminals and wire ropes
Tendeurs, ridoirs, embouts à sertir et câbles

2

Edelstahl-Drahtseil flexibel (mit 1.570 N/mm²) / A4-AISI 316 Wire rope for halyard, flexible / Câble extra souple

8382

Bestell-Nr. Order no.	DS-Ø WR-Ø	Gewicht Kg/m Weight	rechn. BL/kN Mathematical	mind. BL/kN Minimum	*€/Meter *€/metre
83824015	1,5	0,007	1,48	1,28	0,97
8382402	2	0,015	2,65	2,33	1,00
83824025	2,5	0,023	4,17	3,66	2,08
8382403	3	0,035	5,86	4,69	2,30
8382404	4	0,061	10,4	8,34	2,40
8382405	5	0,096	16,3	13,0	2,70
8382406	6	0,138	23,4	18,8	4,00
8382407	7	0,187	31,97	25,5	5,30
8382408	8	0,243	41,7	33,3	6,60
8382410	10	0,381	65,1	52,1	11,50
8382412	12	0,548	93,7	75,0	18,40
8382414	14	0,764	128,0	102,0	35,60
8382416	16	0,973	145,5	136,6	40,50

7x19

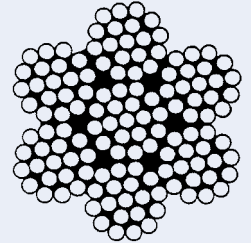

Die in der Tabelle erwähnten Meterpreise gelten bei Haspelabnahme
The prices per metre specified in the table are valid for complete rolls only.

Edelstahl-Drahtseil mittelweich (mit 1.570 N/mm²) / A4-AISI 316 Semi-soft wire rope / Câble souple

8379

Bestell-Nr. Order no.	DS-Ø WR-Ø	Gewicht Kg/m Weight	rechn. BL/kN Mathematical	mind. BL/kN Minimum	*€/Meter *€/metre
8379401	1	0,004	0,71	0,63	0,35
83794015	1,5	0,009	1,62	1,42	0,44
8379402	2	0,016	2,69	2,25	0,50
83794025	2,5	0,025	4,50	3,95	0,60
8379403	3	0,035	6,05	5,07	1,00
8379404	4	0,063	10,8	9,01	1,70
8379405	5	0,098	16,8	14,1	2,60
8379406	6	0,142	24,2	20,3	3,80
8379407	7	0,193	33,0	27,6	6,00
8379408	8	0,252	43,0	36,1	9,00
8379410	10	0,393	67,2	56,3	10,00
8379412	12	0,564	97,67	81,16	12,80

7x7

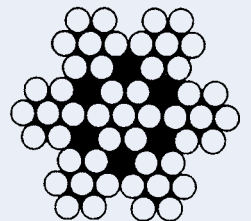

Die in der Tabelle erwähnten Meterpreise gelten bei Haspelabnahme
The prices per metre specified in the table are valid for complete rolls only.

Edelstahl-Drahtseil, PVC ummantelt (mit 1.570 N/mm²) / A4-AISI 316 PVC coated wire rope for guardrail / Câble souple gainé

8381

Bestell-Nr. Order no.	DS-Ø WR-Ø	Farbe Colour	*€/Meter *€/metre
838143/5	3/5	Weiß/White	1,30
838144/6	4/6	Weiß/White	2,80
838144/7	4/7	Weiß/White	3,00
838145/7	5/7	Weiß/White	3,90
838146/9	6/9	Weiß/White	4,40

7x7

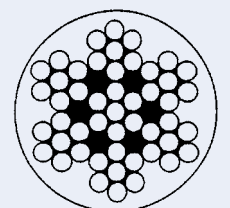

Die in der Tabelle erwähnten Meterpreise gelten bei Haspelabnahme
The prices per metre specified in the table are valid for complete rolls only.

2

Spannschlösser, Terminals und Drahtseile

Turnbuckles, terminals and wire ropes

Tendeurs, ridoirs, embouts à sertir et câbles

814593

Edelstahl-Drahtseil, PVC ummantelt (mit 1.570 N/mm²) / A4-AISI 316

PVC coated wire rope / Câble souple 7x7 gainé transparent

7x7

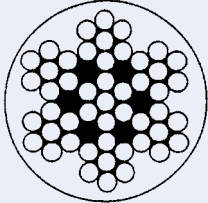

Bestell-Nr. Order no.	DS-Ø WR-Ø	Gewicht Kg/m Weight	rechn. BL/kN Mathematical	mind. BL/kN Minimum	Farbe Colour	*€/Meter *€/metre
81459341/15250	1/1,5	0,012	0,71	0,63	Transparent	0,30
8145934125/2250	1,25/2	0,014	1,05	0,88	Transparent	0,40
81459342/3250	2/3	0,023	2,69	2,25	Transparent	0,60
81459343/4250	3/4	0,044	6,05	5,07	Transparent	1,10
81459344/5250	4/5	0,072	10,80	9,01	Transparent	1,70
81459345/7250	5/7	0,117	16,80	14,10	Transparent	2,80

Die in der Tabelle erwähnten Meterpreise gelten bei Haspelabnahme
The prices per metre specified in the table are valid for complete rolls only.

8378

Edelstahl-Drahtseil hart (mit 1.570 N/mm²) / A4-AISI 316

Wire rope for shrouds / Câble monotonon

1x19

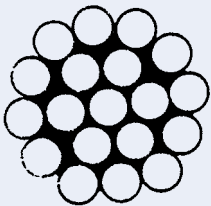

Bestell-Nr. Order no.	DS-Ø WR-Ø	Gewicht Kg/m Weight	rechn. BL/kN Mathematical	mind. BL/kN Minimum	*€/Meter *€/metre
8378401	1	0,005	0,94	0,83	0,26
83784015	1,5	0,012	2,11	1,86	0,38
8378402	2	0,020	3,75	3,30	0,57
83784025	2,5	0,031	5,86	5,15	0,84
8378403	3	0,045	8,43	7,42	1,20
8378404	4	0,080	15,0	13,2	2,90
8378405	5	0,124	23,4	20,6	3,20
8378406	6	0,178	33,7	29,7	4,71
8378407	7	0,243	45,9	40,4	7,40
8378408	8	0,317	60,0	52,8	10,90
8378410	10	0,495	93,7	82,5	11,95
8378412	12	0,713	135,0	119	22,95
8378414	14	0,971	184,0	162	42,50
8378416	16	1,270	240,0	211	56,50

Die in der Tabelle erwähnten Meterpreise gelten bei Haspelabnahme
The prices per metre specified in the table are valid for complete rolls only.

8636

Kausche mit Steg / A4-AISI 316

Thimble with bar / Cosse cœur soudé

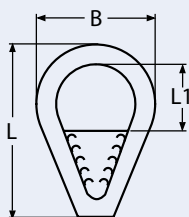

Bestell-Nr. Order no.	DS-Ø WR-Ø	B	L	L1	Box	*€/Stück *€/piece
8636406	6	23	37	11	10	5,50
8636408	8	31	50	15	10	6,00
8636410	10	39	53	21	10	9,00
8636412	12	42	60	25	5	11,00
8636414	14	51	74	30	5	13,60

Spannschlösser, Terminals und Drahtseile

Turnbuckles, terminals and wire ropes
Tendeurs, ridoirs, embouts à sertir et câbles

2

Kausche / A4-AISI 316
Wire thimble / Cosse cœur

8247

Bestell-Nr. Order no.	DS-Ø WR-Ø	B	C	S	Box	*€/Stück *€/piece
8247402	2	7	10	0,7	50	0,20
82474025	2,5	8	14	0,7	50	0,25
8247403	3	9	15	1,0	50	0,26
8247404	4	11	18	1,0	20	0,33
8247405	5	14	20	1,2	20	0,43
8247406	6	15	23	1,2	20	0,46
8247408	8	18	29	1,5	10	0,84
8247410	10	24	37	1,5	10	1,12
8247412	12	29	50	1,5	10	1,62
8247414	14	33	54	2,0	5	2,64
8247416	16	37	64	2,0	5	3,50
8247418	18	40	70	2,5	1	4,50
8247420	20	45	75	2,5	1	5,40
8247422_24	24	48	79	2,5	1	8,10

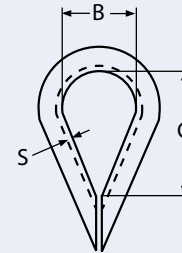

2

Kausche, schwere und geschlossene Form / A4-AISI 316
Thimble, heavy and closed / Cosse cœur forme arrondie

8536

Bestell-Nr. Order no.	DS-Ø WR-Ø	B	C	D	E	K	Box	*€/Stück *€/piece
8536402	2	5	15	21	15	6,4	10	1,10
8536403	3	6	20	26	18	8,4	10	1,30
8536404	4	7	25	32	21	11	10	1,50
8536405	5	9	31	42	28	12	10	2,00
8536406	6	11	32	43	28	12	10	2,40
8536408	8	10	41	58	43	13	5	3,70
8536410	10	13	50	72	51	14	5	5,00
8536412	12	16	60	86	62	16	5	8,50
8536416	16	20	75	110	82	21	1	13,30
8536419	19	24	90	124	94	31	1	18,00
8536422	22	28	100	130	100	38	1	24,00
8536425	25	32	116	148	115	48	1	38,00

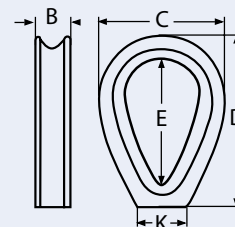

Nylon Kauschen
Nylon thimbles / Cosse cœur en nylon

814453

Bestell-Nr. Order no.	DS-Ø WR-Ø	B	C	S	Box	*€/Stück *€/piece
814453304	4	13	19	2	20	0,20
814453306	6	16	22	2	20	0,30
814453308	8	23	38	2	20	0,40
814453310	10	24	40	3	10	0,70
814453312	12	24	41	3	10	0,90
814453314	14	26	44	3	10	1,40
814453316	16	34	54	5	5	1,90
814453318	18	34	56	6	5	2,70
814453320	20	35	57	6	5	3,50

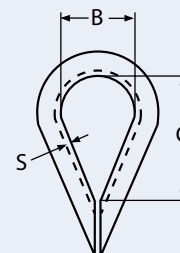

2

Spannschlösser, Terminals und Drahtseile

Turnbuckles, terminals and wire ropes

Tendeurs, ridoirs, embouts à sertir et câbles

8248

Drahtseilklemme / A4-AISI 316

Wire rope clip / Serre câble à etrier

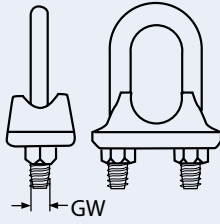

Bestell-Nr. Order no.	DS-Ø WR-Ø	GW	Box	*€/Stück *€/piece
8248402	2	M3	50	1,00
8248403	3	M3	50	1,10
8248404	4	M4	20	1,20
8248405	5	M5	20	1,30
8248406	6	M6	20	1,50
8248408	8	M6	10	2,30
8248410	10	M8	10	3,80
8248413	13	M10	5	5,70
8248416	16	M10	5	8,90
8248418	18 + 19	M12	1	12,70
8248422	22	M12	1	17,50

814391

Eiform-Drahtseilklemme / A4-AISI 316

Egg shaped wire rope clip / Serre câble forme œuf

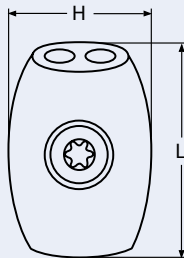

Bestell-Nr. Order no.	DS-Ø WR-Ø	L	H	TX	Box	*€/Stück *€/piece
814391402	2	28	11	20	10	5,50
814391403	3	28	12	25	10	5,70
814391404	4	34	14	30	10	6,10
814391405	5	34	15	30	5	7,40
814391406	6	35	15	30	5	8,60

8284

Duplex Drahtseilklemme / A4-AISI 316

Duplex wire rope clip / Serre câble plat double

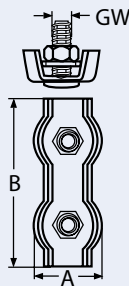

Bestell-Nr. Order no.	DS-Ø WR-Ø	GW	A	B	Box	*€/Stück *€/piece
8284402	2	M4	11,5	33	20	1,30
8284403	3	M4	14,5	38	20	1,30
8284404	4	M5	16,5	43	20	1,70
8284405	5	M5	20,0	51	10	2,50
8284406	6	M6	24,5	63	10	3,30
8284408	8	M8	31,5	78	5	5,60
8284410	10	M10	38,0	85	5	9,20

8304

Simplex Drahtseilklemme / A4-AISI 316

Simplex wire rope clip / Serre câble plat simple

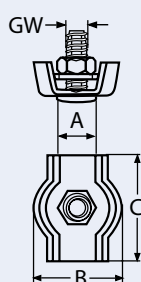

Bestell-Nr. Order no.	DS-Ø WR-Ø	GW	A	B	C	Box	*€/Stück *€/piece
8304402	2	M4	4	11,5	15	20	0,50
8304403	3	M4	6	14,5	18	20	0,60
8304404	4	M5	8	16,5	20	20	1,00
8304405	5	M5	10	20,0	24	10	1,20
8304406	6	M6	12	24,5	29	10	1,90
8304408	8	M8	16	31,5	35	5	3,50
8304410	10	M10	20	38,0	48	5	4,90

Spannschlösser, Terminals und Drahtseile

Turnbuckles, terminals and wire ropes
Tendeurs, ridoirs, embouts à sertir et câbles

2

Pressklemme aus Kupfer Copper ferrule / Manchon en cuivre

8285

Bestell-Nr. Order no.	DS-Ø WR-Ø	Klemmgröße Clamping size	A	B	S	L	Box	*€/Stück *€/piece
8285101	1	1,5	1,7	3,4	0,75	6	100	0,16
82851015	1,5	2,0	2,4	4,8	0,85	7	100	0,22
8285102	2	2,5	2,7	5,4	1,0	9	100	0,25
8285103	3	3,5	3,8	7,6	1,5	13	100	0,42
8285104	4	4,5	4,9	9,8	1,9	16	100	0,80
8285105	5	6,0	6,6	13,2	2,5	21	50	1,70
8285106	6	6,5	7,2	14,4	2,7	23	50	2,10
8285107	7	8,0	8,8	17,6	3,3	28	10	3,75
8285108	8	9,0	9,9	19,8	3,7	32	10	6,40
8285110	10	11,0	12,1	24,2	4,5	39	10	7,10
8285112	12	13,0	14,2	28,4	5,4	46	10	21,83
8285116	16	18,0	19,6	39,2	7,6	63	5	43,25

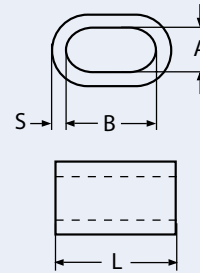

2

Pressklemme aus Edelstahl / A4-AISI 316 Stainless steel ferrule / Manchon en inox

8470

Bestell-Nr. Order no.	DS-Ø WR-Ø	Klemmgröße Clamping size	A	B	S	L	Box	*€/Stück *€/piece
8470401	1	1	1,2	2,4	0,65	5	10	1,20
84704015	1,5	1,5	1,7	3,4	0,85	6	10	1,30
8470402	2	2	2,5	4,5	1,0	9	10	1,40
8470403	3	3	3,5	7,5	1,0	11	10	1,90
8470404	4	4	4,5	9,2	1,5	14	10	1,90
8470405	5	5	5,6	11,5	2,0	18	10	4,00
8470406	6	6	6,8	13,5	2,5	21	10	4,90
8470407	7	7	8,0	16,5	2,5	25	5	7,20
8470408	8	8	9,0	18,0	3,0	28	5	7,10
8470410	10	10	11,5	22,5	3,2	35	1	10,60
8470412	12	12	14,2	28,5	4,0	42	1	14,40

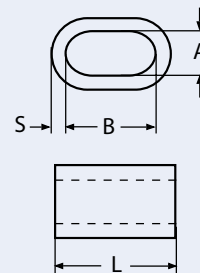

Pressklemme aus Aluminium - DIN 3093 Alu ferrule / Manchon en alu

8471

Bestell-Nr. Order no.	DS-Ø WR-Ø	Klemmgröße Clamping size	A	B	S	L	Box	*€/Stück *€/piece
8471001	1	1,5	1,7	3,4	0,75	6	100	0,10
84710015	1,5	2,0	2,4	4,8	0,85	7	100	0,10
8471002	2	2,5	2,7	5,4	1,0	9	100	0,10
8471003	3	3,5	3,8	7,6	1,5	13	100	0,20
8471004	4	4,5	4,9	9,8	1,9	16	100	0,35
8471005	5	6,0	6,6	13,2	2,5	21	50	1,00
8471006	6	6,5	7,2	14,4	2,7	23	50	1,25
8471007	7	8,0	8,8	17,6	3,3	28	10	1,75
8471008	8	9,0	9,9	19,8	3,7	32	10	2,25
8471010	10	11,0	12,1	24,2	4,5	39	10	3,00
8471012	12	13,0	14,2	28,4	5,4	46	5	5,00

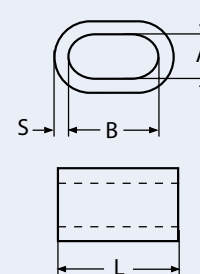

8279

Steckbolzen / A4-AISI 316

Steel pin / Axe pour ridoir

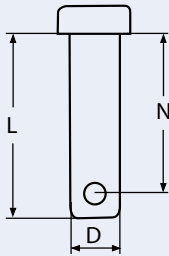

Bestell-Nr. Order no.	D	L	N	Box	*€/Stück *€/piece
8279404_14	4	14	11	5	1,05
8279404_20	4	20	16	5	1,10
8279405_15	5	15	11	5	1,15
8279405_18	5	18	14	5	1,20
8279405_21	5	21	17	5	1,25
8279406_15	6	15	11	5	1,35
8279406_20	6	20	16	5	1,65
8279406_24	6	24	20	5	1,70
8279406_25	6	25	21	5	1,80
8279406_29	6	29	25	5	1,85
8279406_34	6	34	30	5	1,85
8279406_36	6	36	32	5	1,90
8279406_44	6	44	40	5	1,95
8279406_45	6	45	41	5	1,95
8279406_54	6	54	50	5	2,00
8279406_64	6	64	60	5	2,10
8279408_21	8	21	17	2	2,10
8279408_24	8	24	20	2	2,40
8279408_27	8	27	23	2	2,45
8279408_32	8	32	28	2	2,50
8279408_34	8	34	30	2	2,55
8279408_44	8	44	40	2	2,60
8279408_54	8	54	50	2	2,65
8279408_64	8	64	60	2	2,70
8279408_74	8	74	70	2	2,80
8279408_84	8	84	80	2	2,85
82794095_26	9,5	26	22	1	2,90
82794095_30	9,5	30	26	1	2,95
8279410_34	10	34	30	1	3,10
8279410_44	10	44	40	1	3,15
8279410_54	10	54	50	1	3,20
8279410_64	10	64	60	1	3,50
8279410_74	10	74	70	1	3,60
8279410_84	10	84	80	1	3,65
8279410_94	10	94	90	1	3,70
8279410_104	10	104	100	1	3,90
8279411_29	11	29	25	1	5,15
8279412_30	12	30	26	1	5,25
8279412_45	12	45	40	1	5,30
8279412_55	12	55	50	1	5,65
8279412_65	12	65	60	1	5,75
8279412_75	12	75	70	1	5,90
8279412_85	12	85	80	1	5,95
8279412_95	12	95	90	1	6,10
8279412_105	12	105	100	1	6,25
8279412_115	12	115	110	1	6,30
8279412_125	12	125	120	1	6,40
8279414_41	14	41	36	1	9,50

Spannschlösser, Terminals und Drahtseile

Turnbuckles, terminals and wire ropes
Tendeurs, ridoirs, embouts à sertir et câbles

2

Klappsplint mit Ring / A4-AISI 316 Ring catch / Goupille Clips

814076

Bestell-Nr. Order no.	A	B	C	E	F	Box	*€/Stück *€/piece
8140764440	49,6	7,5	4,4	2,4	39,0	10	2,90
8140764600	56,2	8,0	6,0	3,2	44,8	10	3,60
8140764790	56,5	8,4	7,4	3,1	44,9	5	4,40
8140764106	56,5	10,7	10,6	3,2	43,4	5	5,80

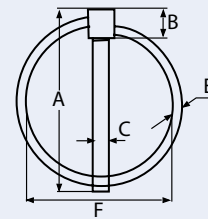

2

Klappbolzen / A2-AISI 304 Safety clevis pin / Axe pour ridoir avec languette

8356

Bestell-Nr. Order no.	D	L	L1	Box	*€/Stück *€/piece
8356206_20	6	20	12	5	6,00
8356206_26	6	26	18	5	6,50
8356206_31	6	31	23	5	7,00
8356206_56	6	56	48	5	8,00
8356206_65	6	65	57	5	9,00
8356208_28	8	28	20	2	7,00
8356208_34	8	34	25	2	7,50
8356208_38	8	38	30	2	8,00
8356208_43	8	43	35	2	8,50
8356210_35	10	35	25	1	9,00
8356210_45	10	45	35	1	9,50
8356210_55	10	55	45	1	10,00

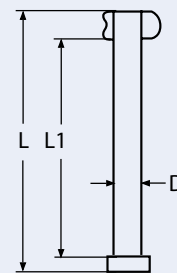

Steckbolzen mit Kugelsicherung / A2-AISI 304 Fast pin / Goupille à bille

8474

Bestell-Nr. Order no.	Ø	L	N	Box	*€/Stück *€/piece
847425_28	5	28	13	10	3,00
847426_35	6	35	22	10	3,50
847428_33	8	33	22	5	4,50
847428_46	8	53	38	5	5,00

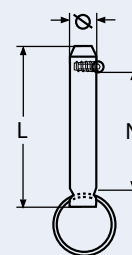

NEW

Steckbolzen mit manueller Kugelsicherung / A2-AISI 304 Fast pin with manual ball lock / Goupille à bille manuelle

814729

Bestell-Nr. Order no.	Ø	N	Box	*€/Stück *€/piece
814729206 25	6	25	1	32,20
814729206 40	6	40	1	35,30
814729208 25	8	25	1	33,20
814729208 40	8	40	1	35,70
814729210 25	10	25	1	36,50
814729210 40	10	40	1	40,90

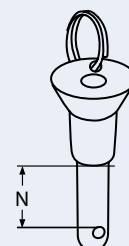

2

Spannschlösser, Terminals und Drahtseile

Turnbuckles, terminals and wire ropes

Tendeurs, ridoirs, embouts à sertir et câbles

8719

Sicherungsseil / A2-AISI 304

Security wire / Câble de sécurité

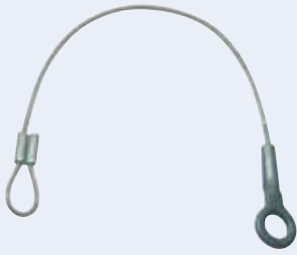

Bestell-Nr. Order no.	L	D	D1	Box	*€/Stück *€/piece
87192200	145	8	5,4	10	2,40

8590

Steckbolzen mit Sicherungsseil / A2-AISI 304

Plug-in bolt with security wire / Câble de sécurité avec goupille

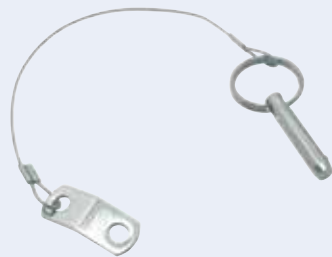

Bestell-Nr. Order no.	D	L	B	Box	*€/Stück *€/piece
859026_25	6,3	250	13	10	5,60

8273

Federstecker / A4-AISI 316

Spring cotter pin / Goupille beta

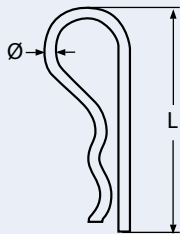

Bestell-Nr. Order no.	Ø	L	Box	*€/Stück *€/piece
827342	2,0	49	50	0,40
8273425	2,5	55	50	0,60
827343	3,0	70	50	0,80
827344	4,0	79	20	1,60
827345	5,0	101	20	2,80
827346	6,0	126	10	4,20

8431

Federstecker nach DIN 11024 / A4-AISI 316

Spring cotter pin / Goupille beta double à œil

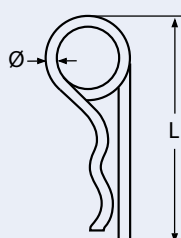

Bestell-Nr. Order no.	Ø	L	Box	*€/Stück *€/piece
8431425	2,25	54	10	3,00
8431432	2,8	61	10	4,00
8431440	3,6	78	10	5,00
8431450	4,5	97	5	6,00
8431463	5,6	115	5	11,00
8431470	6,3	146	1	17,00
8431480	7,0	172	1	23,00

Spannschlösser, Terminals und Drahtseile

Turnbuckles, terminals and wire ropes
Tendeurs, ridoirs, embouts à sertir et câbles

2

Ringsplint / A4-AISI 316 Ring pin / Anneau brisé

8383

Bestell-Nr. Order no.	Ø	D	Für Steckbolzen For fast bolt	Box	*€/Stück *€/piece
8383410_10	1,0	10	4	50	0,15
8383412_15	1,2	15	5 - 6	50	0,20
8383415_20	1,5	20	8 - 10	20	0,25
8383418_25	1,8	25	11 - 14	20	0,30

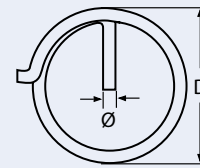

2

Sicherungsring mit 2,5 Drehungen / A2-AISI 304 Circle cotter / Anneau double brisé

8358

Bestell-Nr. Order no.	Ø	D	Box	*€/Stück *€/piece
8358210	1,5	10	50	0,25
8358216	1,5	16	50	0,35

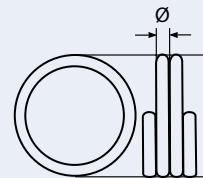

Drahtseilschere Wire rope cutter / Cisaille pour câble

8504

Bestell-Nr. Order no.	Max. Draht-Ø Max. wire Ø	L	Box	*€/Stück *€/piece
85041005	5	195	1	20,00
85041012	12	470	1	288,10
85041016	16	800	1	515,60
850410ERSATZ12	Ersatzmesser für 12, Replacement blade for 12			115,00
850410ERSATZ16	Ersatzmesser für 16, Replacement blade for 16			258,70



Presszange für Pressklemmen Hand swager and swaging die / Pince à sertir pour manchon

8505

Bestell-Nr. Order no.	Zange+Backen Hand swager+swaging dies	Klemmgröße Clamping size	Box	*€/Stück *€/piece
85051010_45	Presszange ohne Backen ¹	1,0 - 4,5	1	450,00
85051010	Pressbacken / Dies	1,0	1	490,00
85051015	Pressbacken / Dies	1,5	1	490,00
85051020	Pressbacken / Dies	2,0	1	490,00
85051025	Pressbacken / Dies	2,5	1	490,00
85051030	Pressbacken / Dies	3,0	1	490,00
85051035	Pressbacken / Dies	3,5	1	490,00
85051040	Pressbacken / Dies	4,0	1	490,00
85051045	Pressbacken / Dies	4,5	1	490,00

¹ Hand swager without dies



Kapitel 3

Chapter 3

Architektur und Design

Architecture and Design



Universal-Pfostenspanner mit Montageterminal / A4-AISI 316
Universal rail turnbuckle with quick attach terminal / **

8763

Bestell-Nr. Order no.	Für Pfosten For Stanchion	DS-Ø WR-Ø	L1	L2	A	Box	*€/Stück *€/piece
87634ECKIG	eckig/square	4	150	75	38	1	55,00
87634RUND	rund/round Ø50	4	150	75	38	1	55,00

Drahtseil einfach einlegen und zudrehen.
Just insert wire rope and turn. U.S. Pat.

**Tendeur de poteau universel avec embout sertissage rapide sur platine articulée

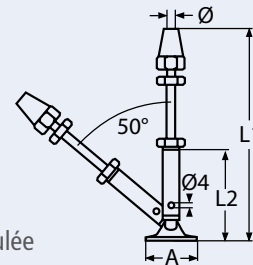

3

ESS Gewindeterminale, rechts / A4-AISI 316

ESS swage stud, right thread / Terminaison fileté, pas à droite

8445

Bestell-Nr. Order no.	DS-Ø WR-Ø	GW	D	A	A1	A2	Box	*€/Stück *€/piece
8445405/3	3	M5	6,3	50	18	27	10	2,50
8445406/4	4	M6	7,5	60	25	30	10	3,00
8445408/5	5	M8	9,0	70	31	31	5	3,50
8445410/6	6	M10	12,5	85	37	40	5	5,00

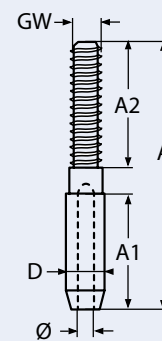

ESS Gewindeterminale, links / A4-AISI 316

ESS swage stud, left thread / Terminaison fileté, pas à gauche

8446

Bestell-Nr. Order no.	DS-Ø WR-Ø	GW	D	A	A1	A2	Box	*€/Stück *€/piece
8446405/3	3	M5	6,3	50	18	27	10	2,80
8446406/4	4	M6	7,5	60	25	30	10	3,30
8446408/5	5	M8	9,0	70	31	31	5	3,80
8446410/6	6	M10	12,5	85	37	40	5	5,30

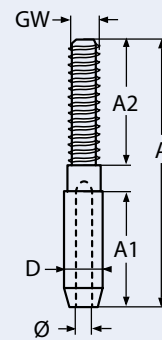

ESS Gewindeterminale mit Innengewinde, rechts / A4-AISI 316

ESS swage stud with internal thread, right thread / Terminaison avec filetage interne, pas à droite

8449

Bestell-Nr. Order no.	DS-Ø WR-Ø	GW	D	A	A1	A2	Box	*€/Stück *€/piece
8449405/3	3	M5	6,3	55	20	28	10	4,50
8449406/4	4	M6	7,5	65	22	36	10	5,00
8449406/5	5	M6	9,0	70	22	41	5	5,50
8449408/6	6	M8	12,5	85	25	53	5	6,60

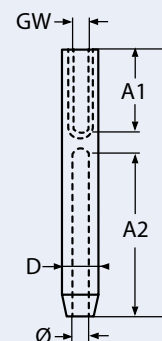

8450

ESS Gewindeternal mit Innengewinde, links / A4-AISI 316

ESS swage stud with internal thread, left thread / Terminaison avec filetage interne, pas à gauche

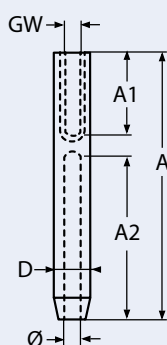

Bestell-Nr. Order no.	DS-Ø WR-Ø	GW	D	A	A1	A2	Box	*€/Stück *€/piece
8450405/3	3	M5	6,3	55	20	28	10	4,80
8450406/4	4	M6	7,5	65	22	36	10	5,30
8450406/5	5	M6	9,0	70	22	41	5	5,80
8450408/6	6	M8	12,5	85	25	53	5	7,30

8452

ESS Gabel mit Gewinde, rechts / A4-AISI 316

ESS threaded jaw, right thread / Embout à chape fixe, pas à droite

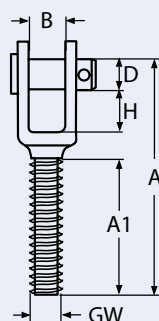

Bestell-Nr. Order no.	GW	A	A1	H	B	D	Box	*€/Stück *€/piece
8452405	M5	40	20	10	8	5	10	2,00
8452406	M6	47	25	10	8	6	10	2,80
8452408	M8	52	25	12	10	8	5	3,90
8452410	M10	72	45	14	12	10	5	4,50

8453

ESS Gabel mit Gewinde, links / A4-AISI 316

ESS threaded jaw, left thread / Embout à chape fixe, pas à gauche

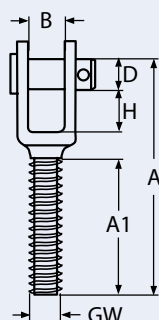

Bestell-Nr. Order no.	GW	A	A1	H	B	D	Box	*€/Stück *€/piece
8453405	M5	40	20	10	8	5	10	2,30
8453406	M6	47	25	10	8	6	10	3,50
8453408	M8	52	25	12	10	8	5	3,90
8453410	M10	72	45	14	12	10	5	4,60

8454

ESS Auge mit Gewinde, rechts / A4-AISI 316

ESS threaded eye, right thread / Embout à œil fixe, pas à droite

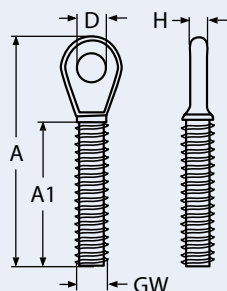

Bestell-Nr. Order no.	GW	A	A1	D	H	Box	*€/Stück *€/piece
8454405	M5	45	23	5,5	3	10	2,80
8454406	M6	47	28	6,5	4	10	3,00
8454408	M8	55	40	8,5	5	5	3,50
8454410	M10	65	47	10,5	6	5	4,50

ESS Auge mit Gewinde, links / A4-AISI 316

ESS threaded eye, left thread / Embout à œil fixe, pas à gauche

8458

Bestell-Nr. Order no.	GW	A	A1	D	H	Box	*€/Stück *€/piece
8458405	M5	45	23	5,5	3	10	3,00
8458406	M6	47	28	6,5	4	10	3,30
8458408	M8	55	40	8,5	5	5	3,80
8458410	M10	65	47	10,5	6	5	4,30

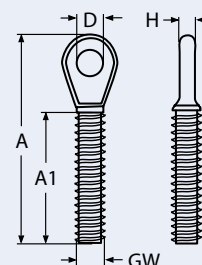

3

ESS Gabel mit Innengewinde, rechts / A4-AISI 316

ESS jaw with internal thread, right thread / Embout à chape fixe avec filetage interne, pas à droite

8455

Bestell-Nr. Order no.	GW	D	H	B	D1	A	A1	Box	*€/Stück *€/piece
8455405	M5	7,5	10	8	5	55	27	10	7,00
8455406	M6	8,0	10	9	6	60	30	10	8,00
8455408	M8	12,0	12	10	8	65	31	5	9,00
8455410	M10	14,0	12	12	10	75	40	5	13,00

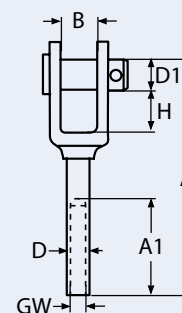

ESS Gabel mit Innengewinde, links / A4-AISI 316

ESS jaw with internal thread, left thread / Embout à chape fixe avec filetage interne, pas à gauche

8456

Bestell-Nr. Order no.	GW	D	H	B	D1	A	A1	Box	*€/Stück *€/piece
8456405	M5	7,5	10	8	5	55	27	10	7,50
8456406	M6	8,0	10	9	6	60	30	10	8,50
8456408	M8	12,0	12	10	8	65	31	5	9,50
8456410	M10	14,0	12	12	10	75	40	5	10,50

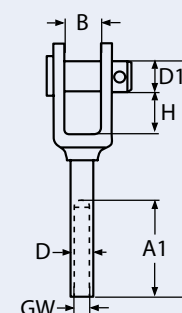

ESS Wantenspanner, Mittelstück / A4-AISI 316

ESS body of turnbuckle / Cage fermé à ridoir

8457

Bestell-Nr. Order no.	GW	A	Box	*€/Stück *€/piece
8457405	M5	55	10	2,80
8457406	M6	65	10	3,50
8457408	M8	70	5	4,00
8457410	M10	85	5	6,00

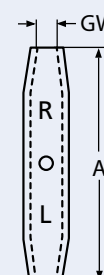

8451

ESS Schraubterminal zur Selbstmontage / A4-AISI 316

ESS screw terminal for self-assembly / Serre câble avec filetage interne, droite ou gauche

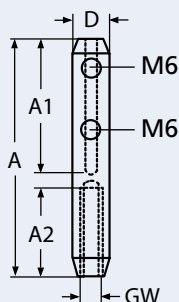

Bestell-Nr. Order no.	DS-Ø WR-Ø	GW	D	A	A1	A2	Box	*€/Stück *€/piece
8451434RE	3+4	M6 rechts	12	80	45	30	5	7,90
		M6 right						
8451434LI	3+4	M6 links	12	80	45	30	5	7,90
		M6 left						
8451405RE	5	M6 rechts	12	80	45	30	5	7,90
		M6 right						
8451405LI	5	M6 links	12	80	45	30	5	7,90
		M6 left						

8466

ESS Gewindestück, rechts und links / A4-AISI 316

ESS stud bolt, right and left thread / Terminaison fileté, pas à droite + pas à gauche

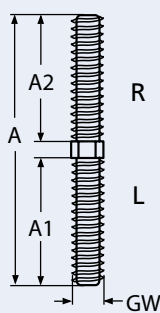

Bestell-Nr. Order no.	GW	A	A1	A2	Box	*€/Stück *€/piece
8466405	M5	65	30	30	10	1,00
8466406	M6	65	30	30	10	1,10
8466408	M8	65	30	30	5	1,60
8466410	M10	85	40	40	5	2,90
8466412	M12	105	50	50	5	4,50

8469

ESS Augterminal / A4-AISI 316

ESS eye terminal / Embout à œil à sertir inox

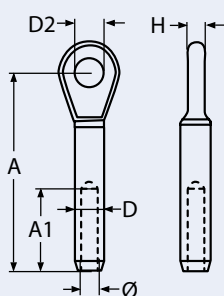

Bestell-Nr. Order no.	DS-Ø WR-Ø	D	D2	A	A1	H	Box	*€/Stück *€/piece
846943	3	6,3	6,5	40	18	5	10	2,50
846944	4	7,5	8,5	52	24	6	10	3,00
846945	5	9,0	9,5	62	30	7	5	3,70
846946	6	12,5	13	75	36	8	5	5,30

8447

ESS Gabelterminal / A4-AISI 316

ESS fork terminal / Embout à chape fixe à sertir

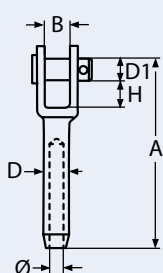

Bestell-Nr. Order no.	DS-Ø WR-Ø	D	D1	A	B	H	Box	*€/Stück *€/piece
844743	3	6,3	5	55	8	10	10	3,50
844744	4	7,5	6	65	8	10	10	4,00
844745	5	8,9	8	70	10	12	5	5,00
844746	6	12,4	10	85	12	14	5	7,50



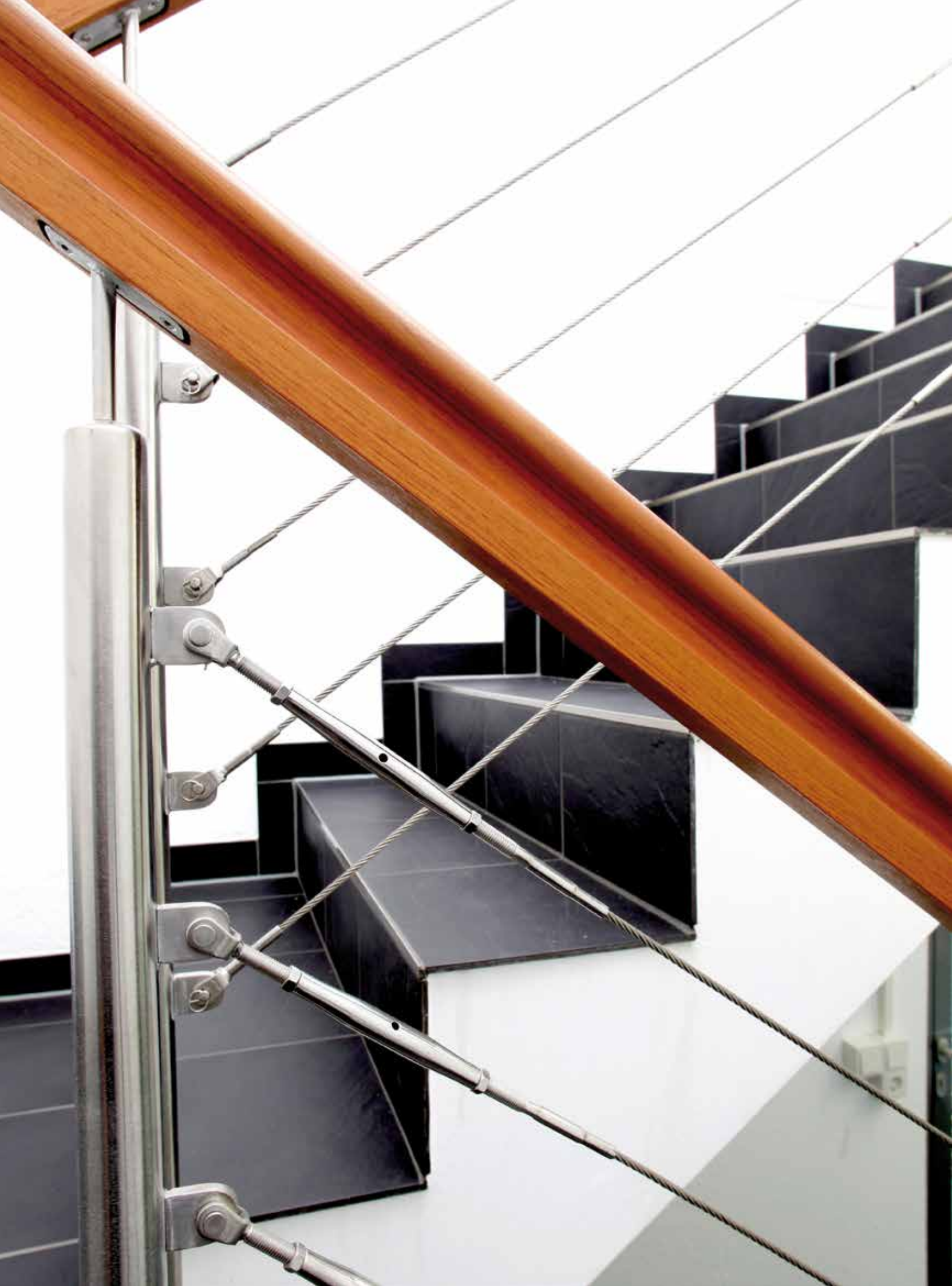

ESS Senkkopfterminal / A4-AISI 316

ESS cone terminal / Terminaison à tête plate à sertir

8459

Bestell-Nr. Order no.	DS-Ø WR-Ø	D	D1	A	A1	A2	Box	*€/Stück *€/piece
845943	3	8,0	6,3	34	27	2	10	1,40
845944	4	9,5	7,5	43	35	2	10	2,10
845945	5	13,0	9,0	50	40	3	5	2,90
845946	6	16,5	12,5	64	50	3	5	4,80

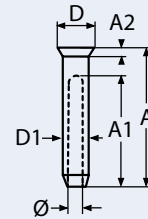

3

ESS Linsenkopfterminal / A4-AISI 316

ESS dome head terminal / Terminaison à tête cylindrique bombée à sertir

8448

Bestell-Nr. Order no.	DS-Ø WR-Ø	D	D1	D2	A	A1	A2	Box	*€/Stück *€/piece
844843	3	9	5,5	3,3	25	18	2,0	10	3,50
844844	4	11	6,5	4,3	30	24	2,0	10	4,00
844845	5	13	7,5	5,3	35	28	2,5	5	4,50
844846	6	16	9,0	6,3	40	32	3,0	5	5,00

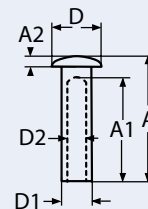

ESS Linsenkopfhülse mit Innengewinde und Inbus, rechts / A4-AISI 316

ESS dome case nut with internal thread and hexagon socket, right thread / **

8464

Bestell-Nr. Order no.	GW	D	D1	A	A1	A2	Box	*€/Stück *€/piece
8464405	M5	12	7,5	25	18	4	10	3,50
8464406	M6	12	8,0	30	24	4	10	4,00
8464408	M8	16	12	35	28	5	5	6,20
8464410	M10	20	14	40	32	6	5	9,10

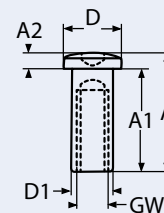

**Terminaison TBHC avec filetage interne pas à droite

Stockschraube mit Rechtsgewinde / A4-AISI 316

Dowel screw with right thread / Goujon double filet pas à droite

8515

Bestell-Nr. Order no.	GW	L	L1	L2	Box	*€/Stück *€/piece
8515405	M5	80	43	32	5	1,50
8515406	M6	90	50	35	5	1,80
8515408	M8	130	65	55	5	2,30
8515410	M10	150	75	55	5	4,30

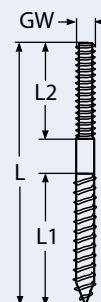

8516

Stockschraube mit Linksgewinde / A4-AISI 316

Dowel screw with left thread / Goujon double filet pas à gauche

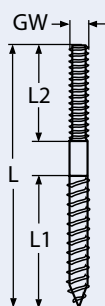

Bestell-Nr. Order no.	GW	L	L1	L2	Box	*€/Stück *€/piece
8516405	M5	80	43	32	5	1,70
8516406	M6	90	50	35	5	1,90
8516408	M8	130	65	55	5	2,60
8516410	M10	150	75	55	5	4,40

8468

Wantenspanner Kontermutter, rechts + links / A4-AISI 316

Nut for turnbuckle / Ecrous pour ridoir

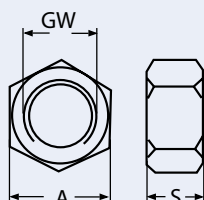

Bestell-Nr. Order no.	GW	Rechts Right	Links Left	A	S	Box	*€/Stück *€/piece
84684R05/L05	M5	R5	L5	7,9	3,8	10	0,25
84684R06/L06	M6	R6	L6	9,8	4,8	10	0,30
84684R08/L08	M8	R8	L8	10,0	5,0	10	0,60
84684R10/L10	M10	R10	L10	12,7	6,2	10	0,75
84684R12/L12	M12	R12	L12	17,0	8,0	10	1,10
84684R14/L14	M14	R14	L14	22,0	11,0	5	1,50
84684R16/L16	M16	R16	L16	24,0	13,0	5	2,70
84684R20/L20	M20	R20	L20	26,5	14,5	5	4,10

8424

ESS Kreuzklemme mit Sackbohrung / A4-AISI 316

ESS cross wire rope clip / Serre câble en croisillons inox

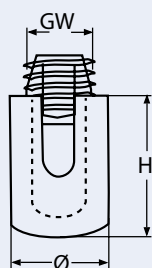

Bestell-Nr. Order no.	DS-Ø WR-Ø	GW	H	Ø	Box	*€/Stück *€/piece
842443	3	M12	19	20	10	4,90
842444	4	M12	21	20	10	5,50
842445	5	M12	23	20	5	5,60
842446	6	M12	25	20	5	6,00

814722

Klemmstopper / A4-AISI 316

Wire rope stopper / Bague d'arrêt pour câble

NEW

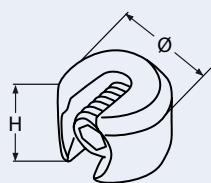

Bestell-Nr. Order no.	DS-Ø WR-Ø	GW	Ø	H	Box	*€/Stück *€/piece
814722402	2	M4	10	8	10	2,50
814722403	3	M6	15	12	10	2,70
814722404	4	M8	15	12	10	2,90
814722405	5	M10	20	15	10	3,20
814722406	6	M10	20	15	10	3,40

NEW

Drahtseil-Klemmring / A4-AISI 316
Wire rope clamp ring / Serre câble 2 parties (2 vis)

814700

Bestell-Nr. Order no.	DS-Ø	GW	H	Ø	Box	*€/Stück *€/piece
814700402	2	M3	10	15	10	3,00
814700403	3	M3	10	15	10	3,00
814700404	4	M3	10	15	10	3,00
814700405	5	M4	10	20	10	3,30
814700406	6	M4	10	20	10	3,30
814700408	8	M4	10	20	10	3,30

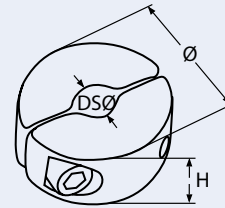

3

NEW

Drahtseil-Klemmring, schwere Ausführung / A4-AISI 316
Wire rope clamp ring, heavy duty / Serre câble 2 parties (4 vis)

814701

Bestell-Nr. Order no.	DS-Ø	GW	L	Ø	Box	*€/Stück *€/piece
814701403	3	M4	27	22	5	4,50
814701404	4	M4	27	22	5	4,50
814701405	5	M5	42	28	2	11,00
814701406	6	M5	42	28	2	11,00
814701408	8	M5	42	28	2	11,00

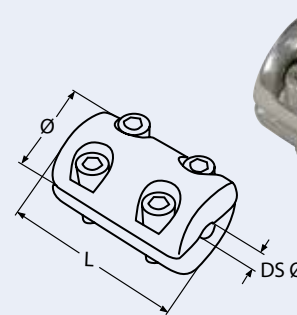

ESS Massivkugel mit Innengewinde, blank / A2-AISI 304
ESS massive ball with internal thread, blank / Boule massive mate avec filetage intérieur

8462

Bestell-Nr. Order no.	D	GW	A	Box	*€/Stück *€/piece
8462215	15	M6	6	10	5,50
8462220	20	M6	17	10	6,30
8462225	25	M6	17	10	9,90
8462230	30	M6	18	10	15,20
8462240	40	M8	24	5	26,30
8462250	50	M8	24	5	45,00

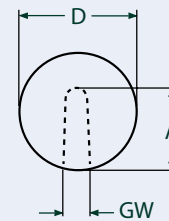

ESS Massivkugel mit Innengewinde, poliert / A2-AISI 304
ESS massive ball with internal thread, polished / Boule massive polie avec filetage intérieur

8463

Bestell-Nr. Order no.	D	GW	A	Box	*€/Stück *€/piece
8463215	15	M6	6	10	7,40
8463220	20	M6	17	10	9,80
8463225	25	M6	17	10	12,30
8463230	30	M6	18	10	15,80
8463240	40	M8	24	5	31,00
8463250	50	M8	24	5	55,00

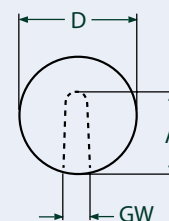

8499

ESS Kombi-Wandkonsole / A4-AISI 316

ESS combination wall bracket / Support mural pour câble



Typ A

Typ B

Bestell-Nr. Order no.	Typ Type	Abmessungen Dimensions	Box	*€/Stück *€/piece
84994A135_90	A	siehe technische Zeichnung see technical drawing	1	24,50
84994B135_90	B	siehe technische Zeichnung see technical drawing	1	24,50

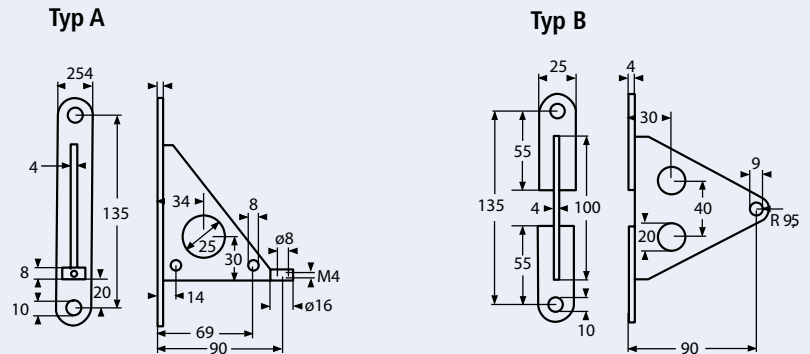

8502

ESS Wandkonsolen - Grundplatte / A2-AISI 304

ESS ground plate for wall bracket / Rondelle plate extra

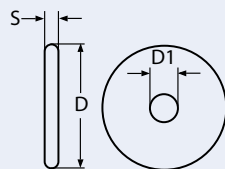

Bestell-Nr. Order no.	D	D1	S	Box	*€/Stück *€/piece
8502258	58	14	6	10	4,50

Kapitel 4

Chapter 4

Relingsbeschlage, Rohr und Zubehor

Rail fittings, tubing and accessories



4

Relingsbeschlage, Rohr und Zubehor

Rail fittings, tubing and accessories

Embases, platines, tubes et accessories

8762

Edelstahlrohr, geschweit, ungegluht-geburstedt / A4-AISI 316

Tube, welded, unannealed-brushed / Tube soude



Bestell-Nr. Order no.	Auen- Outside-	Materialstarke Material thickness	* /Meter * /Metre
876241_12	1 1/2 = 38 mm	2,0	34,80

Fr Fakalientank
For wastetank

Stangenlange 6m, Mindestbestellmenge 10 Langen, anderenfalls Frachtkosten
Length of tube 6m, minimum order quantity 10 tubes, freight charges for smaller quantities

8292

Edelstahlrohr, geschweit und poliert, biegefahig / A2-AISI 304 + A4-AISI 316

Tube - stainless steel welded and polished. bendable / Tube soude et poli



Bestell-Nr. A2 Order no. A2	Bestell-Nr. A4 Order no. A4	Auen- Outside 	Materialstarke Material thickness	* A2/m * A2/m	* A4/m * A4/m
8292219	8292419	19	1,5	13,00	--
8292220	8292420	20	1,5	13,50	31,60
8292222	8292422	22	1,5	15,00	17,30
8292225	8292425	25	1,5	16,00	16,50
8292230	8292430	30	1,5	21,00	21,90

Stangenlange 6m, Mindestbestellmenge 10 Langen, anderenfalls Frachtkosten
Length of tube 6m, minimum order quantity 10 tubes, freight charges for smaller quantities

8532

Haltegriffverbinder / A2-AISI 304

Grab handle connection / Fixation pour tube

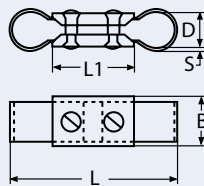

Bestell-Nr. Order no.	Rohr- Tube-	L	L1	B	D	S	Box	*/Stck */piece
8532222	22	90	44	27	24	1	1	18,50
8532225	25	96	44	27	27	1	1	19,00

814642

Haltegriffverbinder / A4-AISI 316

Grab handle connection / Fixation pour tube

NEW

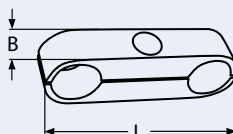

Bestell-Nr. Order no.	Rohr- (D) Tube- (D)	L	B	Box	*/Stck */piece
814642422	22	106	20	1	15,00
814642425	25	106	20	1	17,00

Relingsbeschläge, Rohr und Zubehör

Rail fittings, tubing and accessories

Embases, platines, tubes et accessoires

4

Rohrschnellverschluss / A2-AISI 304

Tube quick-release / Tube avec goupille

8531

Bestell-Nr. Order no.	Für Rohr-Ø For tube-Ø	D	L	L1	L2	Box	*€/Stück *€/piece
8531222	22 x 1,5	18,7	150	80	35	1	12,50
8531225	25 x 1,5	21,7	150	80	35	1	13,00

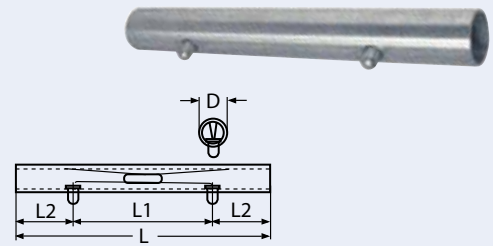

Relingstütze / A4-AISI 316

Stanchion / Chandelier

8546

Bestell-Nr. Order no.	L	L1	D	S	Box	*€/Stück *€/piece
85464410	410	1X	25	2	1	31,50
85464610	610	300	25	2	1	58,00
85464740	740	300	25	2	1	59,00

1X = ohne Loch / without hole

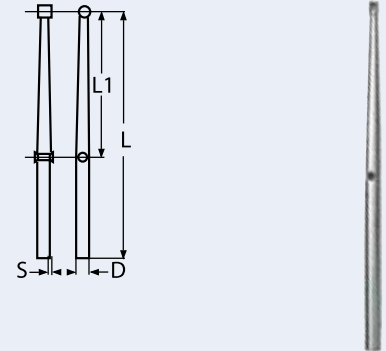

Pfortenstütze / A4-AISI 316

Rail gate stanchion / Support de porte

814316

Bestell-Nr. Order no.	L	L1	B	C	D	E	Box	*€/Stück *€/piece
8143164610	610	310	300	100	25	92	1	105,00
8143164740	740	440	300	100	25	92	1	109,00

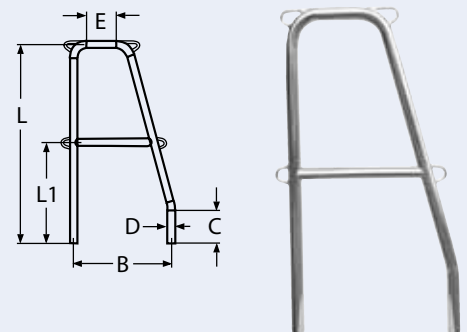

Relingfuß, 60° / A4-AISI 316

Stanchion base, 60° / Embase pour tube, 60°

814304

Bestell-Nr. Order no.	Rohr-Ø (D) Tube-Ø (D)	Sockel-Maß (S) Socket size (S)	GW	H	Box	*€/Stück *€/piece
814304425	25	52 x 44	M8	67	1	24,00
814304430	30	53 x 47	M8	86	1	35,00

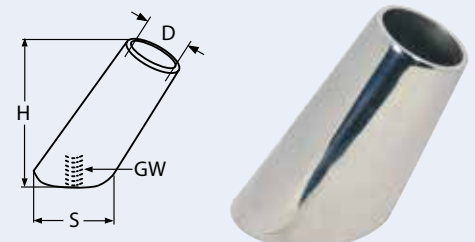

4

Relingsbeschläge, Rohr und Zubehör

Rail fittings, tubing and accessories

Embases, platines, tubes et accessoires

814305

Relingfuß, 90° / A4-AISI 316

Stanchion base, 90° / Embase pour tube, 90°

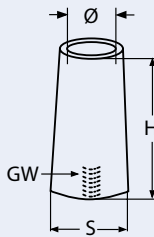

Bestell-Nr. Order no.	Rohr-Ø (D) Tube-Ø (D)	Sockel-Maß (S) Socket size (S)	GW	H	Box	*€/Stück *€/piece
814305425	25	45	M8	69	1	21,00
814305430	30	51	M8	78	1	38,00

814306

Relingfuß, 60° / A4-AISI 316

Stanchion base, 60° / Embase pour tube, 60°

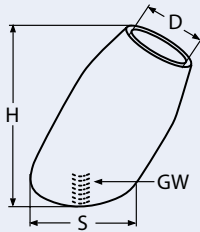

Bestell-Nr. Order no.	Rohr-Ø (D) Tube-Ø (D)	Sockel-Maß (S) Socket size (S)	GW	H	Box	*€/Stück *€/piece
814306425	25	45 x 50	M8	65	1	25,00
814306430	30	45 x 53	M8	67	1	41,60

814307

Relingfuß, 90° / A4-AISI 316

Stanchion base, 90° / Embase pour tube, 90°

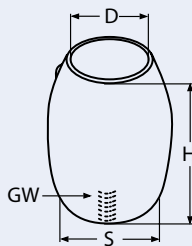

Bestell-Nr. Order no.	Rohr-Ø (D) Tube-Ø (D)	Sockel-Maß (S) Socket size (S)	GW	H	Box	*€/Stück *€/piece
814307425	25	40	M8	57	1	22,00
814307430	30	45	M8	62	1	35,80

8201

Relingfuß, 90° / A4-AISI 316

Round base, 90° / Platine de balcon ronde, 90°

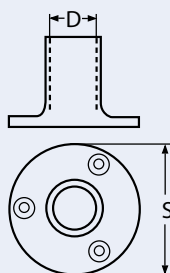

Bestell-Nr. Order no.	Rohr-Ø (D) Tube Ø (D)	Sockel-Ø (S) Socket-Ø (S)	Box	*€/Stück *€/piece
8201422	22	63,5	1	11,40
8201425	25	71,0	1	12,30

Relingsbeschläge, Rohr und Zubehör

Rail fittings, tubing and accessories

Embases, platines, tubes et accessoires

4

Relingfuß, 60° / A4-AISI 316

Round base, 60° / Platine de balcon ronde, 60°

8202

Bestell-Nr. Order no.	Rohr-Ø (D) Tube-Ø (D)	Sockel-Ø (S) Socket-Ø (S)	Box	*€/Stück *€/piece
8202422	22	63,5	1	11,40
8202425	25	71,0	1	12,50

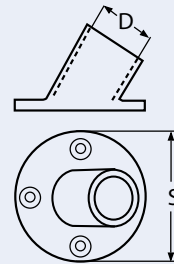

Relingfuß, 90° / A4-AISI 316

Rectangular base, 90° / Platine de balcon rectangulaire, 90°

8203

Bestell-Nr. Order no.	Rohr-Ø (D) Tube-Ø (D)	L	B	Box	*€/Stück *€/piece
8203422	22	78	43	1	11,40
8203425	25	81	48	1	11,50

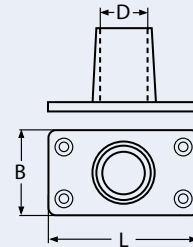

Relingfuß, 60° / A4-AISI 316

Rectangular base, 60° / Platine de balcon rectangulaire, 60°

8204

Bestell-Nr. Order no.	Rohr-Ø (D) Tube-Ø (D)	L	B	Box	*€/Stück *€/piece
8204422	22	78	43	1	11,00
8204425	25	81	48	1	12,00

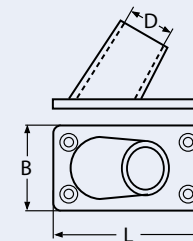

Relingfuß, 30° / A4-AISI 316

Round base, 30° / Platine de balcon ronde, 30°

8325

Bestell-Nr. Order no.	Rohr-Ø (D) Tube-Ø (D)	Sockel-Ø (S) Socket-Ø (S)	Box	*€/Stück *€/piece
8325422	22	63,5	1	12,10
8325425	25	71,0	1	12,80

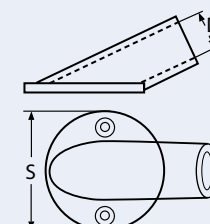



Relingsbeschläge, Rohr und Zubehör

Rail fittings, tubing and accessories

Embases, platines, tubes et accessoires

4

Persenning-Rohrhalter / A4-AISI316

Tarp tube holder / Support du tube

814607

Bestell-Nr. Order no.	Rohr-Ø (D) Tube-Ø (D)	D1	L	S	Box	*€/Stück *€/piece
814607420	20	63,5	68	4	1	17,50
814607422	22	63,5	68	4	1	18,00

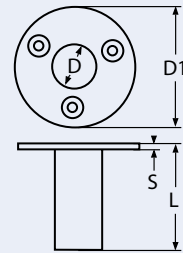

Relingfuß, 90° / A2-AISI 304

Stanchion base, 90° / Embase de chandelier, 90°

8360

Bestell-Nr. Order no.	Rohr-Ø (D) Tube-Ø (D)	L1	L2	Box	*€/Stück *€/piece
83602RECHTECK Rechteck Rectangle	25	64	90	1	18,10
83602DREIECK Dreieck Triangle	25	75	87	1	15,50

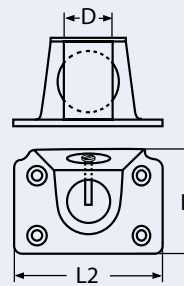

Rechteck / Rectangle

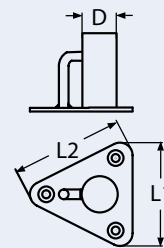

Dreieck / Triangle



Relingfuß, 3° / A4-AISI 316

Stanchion base, 3° / Support avec pontet pour tube, 3°

8632

Bestell-Nr.x Order no.	Rohr-Ø (D) Tube-Ø (D)	D1	A	A1	B	C	C1	S	Box	*€/Stück *€/piece
8632425	25	6,5	86	60	86	60	67	3	1	37,00

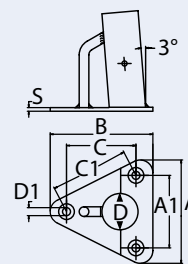

Relingfuß, 5° / A4-AISI 316

Stanchion base, 5° / Support avec pontet pour tube, 5°

8633

Bestell-Nr. Order no.	Rohr-Ø (D) Tube-Ø (D)	D1	A	A1	B	C	C1	S	Box	*€/Stück *€/piece
8633425	25	6,5	86	60	86	60	67	3	1	37,00

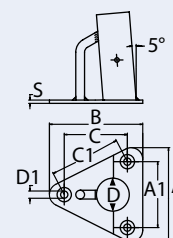

4

Relingsbeschläge, Rohr und Zubehör

Rail fittings, tubing and accessories

Embases, platines, tubes et accessories

8634

Relingfuß, 3° / A4-AISI 316

Stanchion base, 3° / Support avec pontet pour tube, 3°

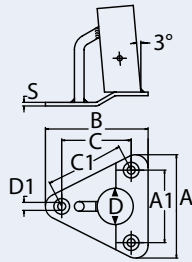

Bestell-Nr. Order no.	Rohr-Ø (D) Tube-Ø (D)	D1	A	A1	B	C	C1	S	Box	*€/Stück *€/piece
8634425	25	6,5	86	60	85	59	66	3	1	35,00

8635

Relingfuß, 5° / A4-AISI 316

Stanchion base, 5° / Support avec pontet pour tube, 5°

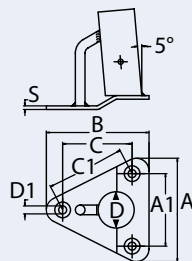

Bestell-Nr. Order no.	Rohr-Ø (D) Tube-Ø (D)	D1	A	A1	B	C	C1	S	Box	*€/Stück *€/piece
8635425	25	6,5	86	60	85	59	66	3	1	35,00

8907

Gegenplatte rund / A2-AISI 304

Counter plate, round / Plateau rond

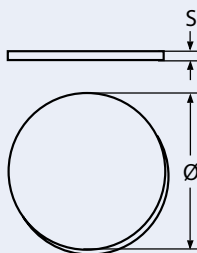

Bestell-Nr. Order no.	Ø	S	Box	*€/Stück *€/piece
8907275	75	3	5	11,70

8908

Gegenplatte oval / A2-AISI 304

Counter plate, oval / Plateau oval

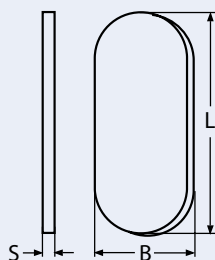

Bestell-Nr. Order no.	L	B	S	Box	*€/Stück *€/piece
8908275_30	75	30	3	5	9,50

Relingsbeschläge, Rohr und Zubehör

Rail fittings, tubing and accessories

Embases, platines, tubes et accessoires

4

Gegenplatte rechteckig / A2-AISI 304

Counter plate, rectangular / Plateau rectangulaire

8909

Bestell-Nr. Order no.	L	B	S	Box	*€/Stück *€/piece
8909280_45	80	45	3	5	10,50

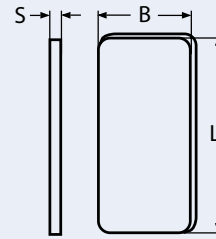

Relingschweißfuß, 45° / A4-AISI 316

Round base for welding, 45° / Platine ronde embouties à souder, 45°

8612

Bestell-Nr. Order no.	D	D1	D2	H	S	Box	*€/Stück *€/piece
8612422	22	75	8	15	3	1	9,50
8612425	25	75	8	15	3	1	13,50

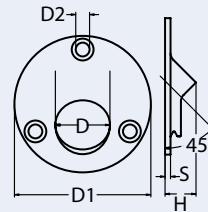

Relingschweißfuß, 60° / A4-AISI 316

Round base for welding, 60° / Platine ronde embouties à souder, 60°

8613

Bestell-Nr. Order no.	D	D1	D2	H	S	Box	*€/Stück *€/piece
8613422	22	75	8	14	3	1	10,60
8613425	25	75	8	14	3	1	13,50

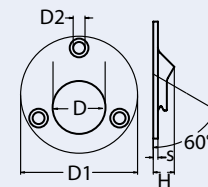

Relingschweißfuß, 90° / A4-AISI 316

Round base for welding, 90° / Platine ronde embouties à souder, 90°

8614

Bestell-Nr. Order no.	D	D1	D2	H	S	Box	*€/Stück *€/piece
8614422	22	69	8	10	3	1	11,50
8614425	25	75	8	10	3	1	14,00

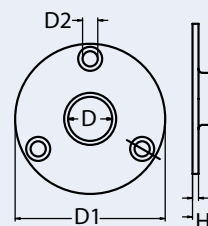

4

Relingsbeschläge, Rohr und Zubehör

Rail fittings, tubing and accessories

Embases, platines, tubes et accessoires

8615

Relingschweißfuß, 45° / A4-AISI 316

Round base for welding, 45° / Platine rectangulaire embouties à souder, 45°

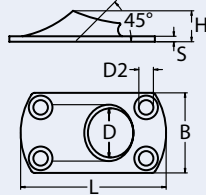

Bestell-Nr. Order no.	D	L	B	D2	H	S	Box	*€/Stück *€/piece
8615422	22	80	45	8	15	3	1	11,40
8615425	25	80	45	8	15	3	1	11,60

8616

Relingschweißfuß, 60° / A4-AISI 316

Rectangular base for welding, 60° / Platine rectangulaire embouties à souder, 60°

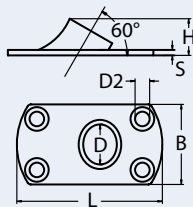

Bestell-Nr. Order no.	D	L	B	D2	H	S	Box	*€/Stück *€/piece
8616422	22	80	45	8	15	3	1	9,50
8616425	25	80	45	8	15	3	1	11,50

8617

Relingschweißfuß, 90° / A4-AISI 316

Rectangular base for welding, 90° / Platine rectangulaire embouties à souder, 90°

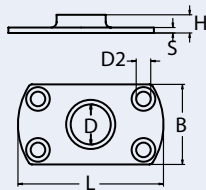

Bestell-Nr. Order no.	D	L	B	D2	H	S	Box	*€/Stück *€/piece
8617422	22	80	45	8	10	3	1	10,50
8617425	25	80	45	8	10	3	1	11,00

8205

T-Stück, 90° / A4-AISI 316

Tee, 90° / Té droit, 90°

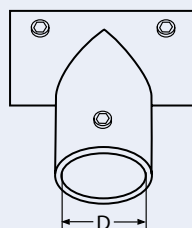

Bestell-Nr. Order no.	Rohr-Ø (D) Tube-Ø (D)	Box	*€/Stück *€/piece
8205422	22	1	12,00
8205425	25	1	13,40
8205430	30	1	17,90

Relingsbeschläge, Rohr und Zubehör

Rail fittings, tubing and accessories
Embases, platines, tubes et accessoires

4

T-Stück, 90°, klappbar / A4-AISI 316
Tee, 90° hinged / Té droit, 90° pliable

8822

Bestell-Nr. Order no.	Rohr-Ø (D) Tube-Ø (D)	Box	*€/Stück *€/piece
8822422	22	1	21,50
8822425	25	1	23,90

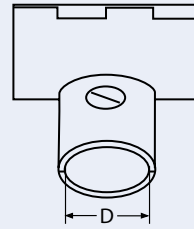

NEW

T-Stück, 60°, klappbar / A4-AISI 316
Tee, 60° hinged / Té 60° pliable

814699

Bestell-Nr. Order no.	Rohr-Ø (D) Tube-Ø (D)	Box	*€/Stück *€/piece
814699422	22	1	21,00
814699425	25	1	23,00

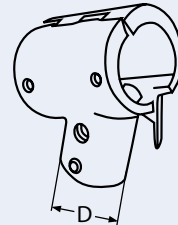

T-Stück, 60° / A4-AISI 316
Tee, 60° / Té incliné, 60°

8206

Bestell-Nr. Order no.	Rohr-Ø (D) Tube-Ø (D)	Box	*€/Stück *€/piece
82064R22	22 Rechts / Right	1	13,20
82064L22	22 Links / Left	1	13,20
82064R25	25 Rechts / Right	1	14,50
82064L25	25 Links / Left	1	14,50

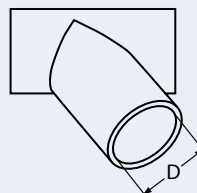
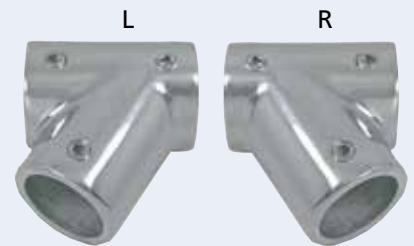

Relingverbindung, 90° / A4-AISI 316
Elbow, 90° / Coude angle, 90°

8210

Bestell-Nr. Order no.	Rohr-Ø (D) Tube-Ø (D)	Box	*€/Stück *€/piece
8210422	22	1	10,20
8210425	25	1	11,10

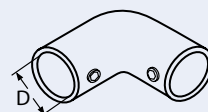



Relingsbeschläge, Rohr und Zubehör

Rail fittings, tubing and accessories
Embases, platines, tubes et accessoires

4

3-Wege-Relingverbindung / A4-AISI 316 3-way corner fitting / Angle 90° trois départs

8211

Bestell-Nr. Order no.	Rohr-Ø (D) Tube-Ø (D)	Box	*€/Stück *€/piece
8211422	22	1	15,50
8211425	25	1	17,30

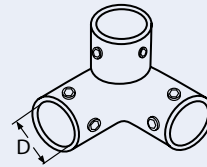

4-Wege-Relingverbindung / A4-AISI 316 4-way tee / Support en croix

8387

Bestell-Nr. Order no.	Rohr-Ø (D) Tube-Ø (D)	Box	*€/Stück *€/piece
8387425	25	1	21,00

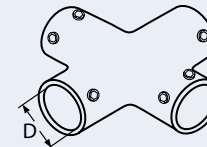

Relingverbindung, 110° / A4-AISI 316 Elbow, 110° / Coude, 110°

8565

Bestell-Nr. Order no.	Rohr-Ø (D) Tube-Ø (D)	L1	L2	S	Box	*€/Stück *€/piece
8565422	22	90	79	3	1	20,30
8565425	25	93	82	3	1	26,70

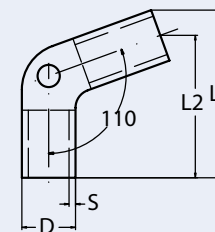

Relingverbindung, 140° / A4-AISI 316 Elbow, 140° / Coude, 140°

8562

Bestell-Nr. Order no.	Rohr-Ø (D) Tube-Ø (D)	L1	L2	S	Box	*€/Stück *€/piece
8562422	22	112	105	3	1	20,90
8562425	25	115	108	3	1	21,90

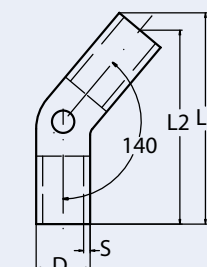

4

Relingsbeschlage, Rohr und Zubehor

Rail fittings, tubing and accessories

Embases, platines, tubes et accessories

8208

Handlaufendstuck, 60° / A4-AISI 316

Rail end, 60° / Embout main courante, 60°

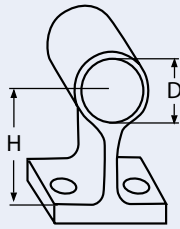

Bestell-Nr. Order no.	Rohr-Ø (D) Tube-Ø (D)	Hohe Mitte Rohr (H) Hight at tube centre (H)	Box	*€/Stuck *€/piece
8208422	22	38	1	9,00
8208425	25	45	1	10,00

8207

Handlaufdurchlass, 60° / A4-AISI 316

Centre rail, 60° / Passage main courante, 60°

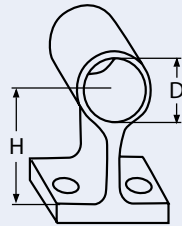

Bestell-Nr. Order no.	Rohr-Ø (D) Tube-Ø (D)	Hohe Mitte Rohr (H) Hight at tube centre (H)	Box	*€/Stuck *€/piece
8207422_38	22	38	1	8,80
8207422_50	22	50	1	10,50
8207425_45	25	45	1	11,00

814410

Handlaufdurchlass, 90° / A4-AISI 316

Centre rail, 90° / Passage pour tube, 90°

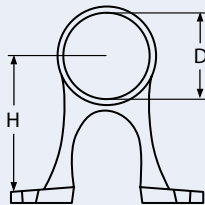

Bestell-Nr. Order no.	Rohr-Ø (D) Tube-Ø (D)	Hohe Mitte Rohr (H) Hight at tube centre (H)	Box	*€/Stuck *€/piece
814410425	25	45	1	15,40

Relingsbeschläge, Rohr und Zubehör

Rail fittings, tubing and accessories

Embases, platines, tubes et accessoires

4

Handlaufendstück / A4-AISI 316

Rail end / Embout main courante

8702

Bestell-Nr. Order no.	Rohr-Ø (D) Tube-Ø (D)	L1	L2	L3	GW	Box	*€/Stück *€/piece
87024022	22	58	55	27	M8	1	24,00
87024025	25	58	55	27	M8	1	26,00

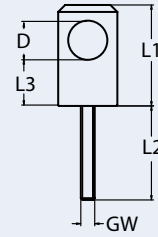

NEW

Handlaufhalter / A4-AISI 316

Hand rail holder / Fixation pour tube

814684

Bestell-Nr. Order no.	Ø	L	L1	Box	*€/Stück *€/piece
814684425	25	111	41	1	9,30

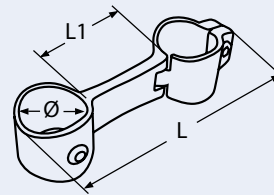

NEW

Handlaufendstück 60° / A4-AISI 316

Hand rail end / Fixation pour tube 60°

814685

Bestell-Nr. Order no.	Ø	L	L1	Box	*€/Stück *€/piece
814685425	25	118	44	1	11,00

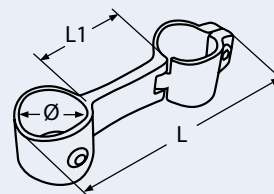

4

Relingsbeschlage, Rohr und Zubehor

Rail fittings, tubing and accessories

Embases, platines, tubes et accessories

814589

Spritzkappenhandlaufhalter Set fur 2 Handlaufe / A4-AISI 316

Sprayhood rail holder set for 2 hand rails / Kit main courante pour deux rampes



Bestell-Nr. Order no.	Spritzkappe Rohr-Ø Sprayhood Tube-Ø	Handlauf Handrail	Box	*€/Stuck *€/piece
814589422	22	22	1	144,00
814589425	25	22	1	146,00



Bestehend aus:
4 Halter fur 22mm Rohr
4 Halteringe fur 22 oder 25mm Rohr
Schrauben und Unterlegscheiben zur Befestigung

Consisting of:
4 end brackets for 22mm tube
4 holder rings for 22 or 25mm tube
Screws and washers for installation

814637

Spritzkappenhandlaufhalter Set mit Gelenk / A4-AISI 316

Sprayhood holder set with joint / Kit main courante avec joint



Bestell-Nr. Order no.	Spritzkappe Rohr-Ø Sprayhood Tube-Ø	Handlauf Handrail	Box	*€/Stuck *€/piece
814637422	22	22	1	126,00
814637425	25	22	1	128,00



Bestehend aus:
1 Halter fur 22mm Rohr
1 Gelenk fur 22mm Rohr (Schwenkwinkel 90° nach unten und 45° nach oben)
1 Haltering fur 22 oder 25mm Rohr
Schrauben und Unterlegscheibe zur Befestigung

Consisting of:
1 end brackets for 22mm tube
1 joint for 22mm tube (angle of slew 90° down and 45° up)
2 holder rings for 22 or 25mm tube.
Screws and washers for installation

814638

Rohrstutze fur Spritzkappenhandlaufhalter / A4-AISI 316

Tube holder for sprayhood holder set / Montant de tube pour main courante



Bestell-Nr. Order no.	Spritzkappe Rohr-Ø Sprayhood Tube-Ø	Handlauf Handrail	Box	*€/Stuck *€/piece
814638422	22	22	1	62,00
814638425	25	22	1	64,00

Bestehend aus:
1 Rohrstutze fur 22mm Rohr. 1 Haltering fur 22 oder 25mm Rohr. Schraube und Unterlegscheibe zur Befestigung

Consisting of:
1 tube holder for 22mm tube. 1 holderring for 22 or 25mm tube. Screw and washer for installation



Relingsbeschläge, Rohr und Zubehör

Rail fittings, tubing and accessories
Embases, platines, tubes et accessoires

4

Handlaufdurchlass / A4-AISI 316

Hand rail support / Passage main courante

8703

Bestell-Nr. Order no.	Rohr-Ø Tube-Ø	L1	L2	L3	GW	Box	*€/Stück *€/piece
87034022	22	58	55	27	M8	1	17,50
87034025	25	58	55	27	M8	1	22,40

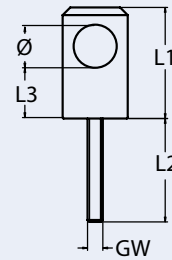

Handlaufdurchlass, 60° / A4-AISI 316

Hand rail support, 60° / Passage main courante, 60°

8209

Bestell-Nr. Order no.	Rohr-Ø Tube-Ø	H	Box	*€/Stück *€/piece
8209422	22	38	1	9,60
8209425	25	38	1	10,00

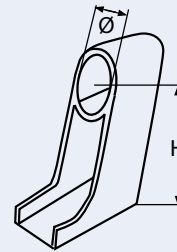

Handlaufendstück, 60° / A4-AISI 316

Rail end, 60° / Embout main courante, 60°

8213

Bestell-Nr. Order no.	Rohr-Ø Tube-Ø	H	Socket-Maß (L+B) Socket size (L+W)	Box	*€/Stück *€/piece
8213422	22	50	36 x 32	1	10,00

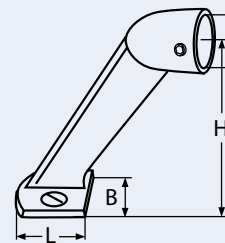

Handlaufendstück, 5 1/2° / A4-AISI 316

Rail end, 5 1/2° / Embout main courante, 5 1/2°

8215

Bestell-Nr. Order no.	Rohr-Ø Tube-Ø	L	Box	*€/Stück *€/piece
8215422	22	140	1	8,00

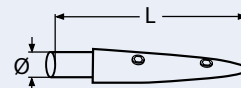

4

4

Relingsbeschläge, Rohr und Zubehör

Rail fittings, tubing and accessories

Embases, platines, tubes et accessoires

8214

Handlaufendstück, 5 1/2° / A4-AISI 316

Rail end, 5 1/2° / Embout main courante, 5 1/2°

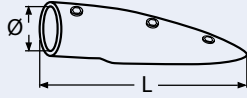

Bestell-Nr. Order no.	Rohr-Ø Tube-Ø	L	Box	*€/Stück *€/piece
8214422	22	125	1	13,20

8212

Handlaufendstück, 90° / A4-AISI 316

Rail end - bottom-mounted, 90° / Embout main courante, 90°

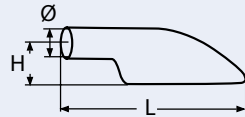

Bestell-Nr. Order no.	Rohr-Ø Tube-Ø	L	Höhe Mitte Rohr (H) Hight at tube centre (H)	Box	*€/Stück *€/piece
8212422	22	175	38	1	20,00
8212425	25	175	38	1	25,80

8310

Endkappe / A4-AISI 316

Top cap / Embout pour tube



Bestell-Nr. Order no.	Rohr-Ø Tube-Ø	Box	*€/Stück *€/piece
8310419	19	10	5,70
8310420	20	10	6,40
8310422	22	10	6,80
8310425	25	10	7,20
8310430	30	5	9,70

8662

Endkappe, verstärkt / A4-AISI 316

Heavy duty top cap / Embout pour tube renforcé



Bestell-Nr. Order no.	Rohr-Ø Tube-Ø	Box	*€/Stück *€/piece
8662422	22	10	8,70
8662425	25	10	10,00
8662430	30	5	10,50

Relingsbeschläge, Rohr und Zubehör

Rail fittings, tubing and accessories

Embases, platines, tubes et accessoires

4

Rohrendstück / A4-AISI 316

Bullet end plug / Bouchon pour tube

8216

Bestell-Nr. Order no.	Für Rohr-Ø For Tube-Ø	D	Box	*€/Stück *€/piece
8216419	19	16	10	6,80
8216420	20	17	10	8,30
8216422	22	19	10	9,20
8216425	25	22	10	9,50
8216430	30	27	5	9,80

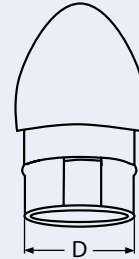

Rohrendstück / A4-AISI 316

Top insert / Embout pour tube

8327

Bestell-Nr. Order no.	Für Rohr-Ø For Tube-Ø	D	Box	*€/Stück *€/piece
8327419	19	16	10	12,50
8327422	22	19	10	13,00
8327425	25	22	10	13,50

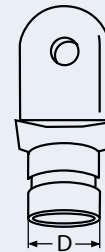

Rohrmittelstück, verstärkt / A4-AISI 316

Heavy duty top slide / Collier de capote renforcé pour tube

8663

Bestell-Nr. Order no.	Rohr-Ø Tube-Ø	Box	*€/Stück *€/piece
8663422	22	10	10,50
8663425	25	10	11,00
8663430	30	5	11,50

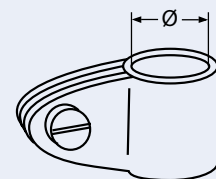

Verdeckbeschlag, Rohrmittelstück / A4-AISI 316

Top slide / Collier de capote pour tube

8309

Bestell-Nr. Order no.	Rohr-Ø Tube-Ø	Box	*€/Stück *€/piece
8309419	19	10	6,00
8309420	20	10	6,50
8309422	22	10	7,20
8309425	25	10	8,00
8309430	30	5	10,00

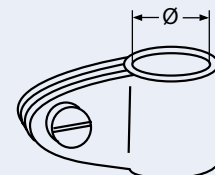

4

Relingsbeschläge, Rohr und Zubehör

Rail fittings, tubing and accessories

Embases, platines, tubes et accessories

8658

Rohrmittelstück / A4-AISI 316

Top slide / Collier de capote pour tube

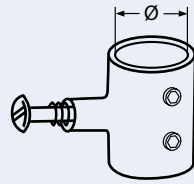

Bestell-Nr. Order no.	Rohr-Ø Tube-Ø	Box	*€/Stück *€/piece
8658422	22	10	12,80
8658425	25	10	13,00

8665

Rohrverlängerung / A4-AISI 316

Tubing extender / Prolongation de filière

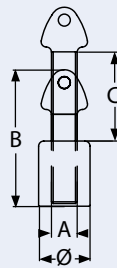

Bestell-Nr. Order no.	Rohr-Ø Tube-Ø	A	B	C	Box	*€/Stück *€/piece
8665422	22	16	65	40	1	15,50
8665425	25	16	65	40	1	16,50

8478

Rohrmittelstück, 2-teilig / A4-AISI 316

Top slide, two-part / Collier ouvrant pour tube

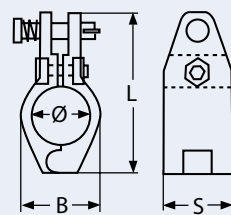

Bestell-Nr. Order no.	Rohr-Ø Tube-Ø	L	B	S	Box	*€/Stück *€/piece
8478422	22	68	30	28	5	15,50
8478425	25	70	33	28	5	14,50
8478430	30	74	38	28	5	19,00

814048

Rohrmittelstück mit Knebel / A4-AISI 316

Top slide with key / Collier de capote pour tube, avec clef

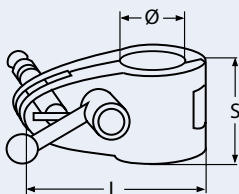

Bestell-Nr. Order no.	Rohr-Ø Tube-Ø	L	S	Box	*€/Stück *€/piece
814048422	22	59	21,5	1	19,10
814048425	25	66	24,0	1	24,90

Relingsbeschläge, Rohr und Zubehör

Rail fittings, tubing and accessories
Embases, platines, tubes et accessoires

4

Verdeckbeschlag, 90° mit Sicherungsbolzen / A4-AISI 316

Deck hinge, 90° with removable pin / Platine de capote, 90° avec vis de protection

8328

Bestell-Nr. Order no.	L	H	B	Box	*€/Stück *€/piece
8328456_17	60	35	22	5	8,20
83284ERSATZ	Ersatzbolzen / Replacement pin			1	2,60

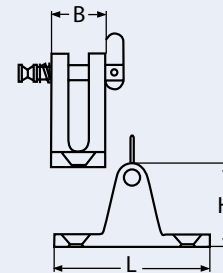

Verdeckbeschlag rund, 90° mit Sicherungsbolzen / A4-AISI 316

Deck hinge with concave base, 90°, removable pin / Platine de capote concave, 90° avec vis de protection

8329

Bestell-Nr. Order no.	L	H	B	Box	*€/Stück *€/piece
8329456_17	56	35	17	5	8,40
83294ERSATZ	Ersatzbolzen / Replacement pin				2,60

Für Rohr bis 25mm / For tube to 25mm

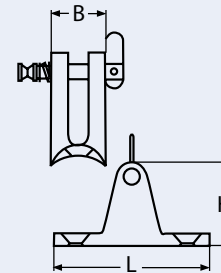

Verdeckbeschlag, 80° mit Sicherungsbolzen / A4-AISI 316

Deck hinge, 80°, removable pin / Platine de capote, 80° avec vis de protection

8856

Bestell-Nr. Order no.	L	H	B	Box	*€/Stück *€/piece
8856456_17	56	35	17	5	8,80
83294ERSATZ	Ersatzbolzen / Replacement pin				2,60

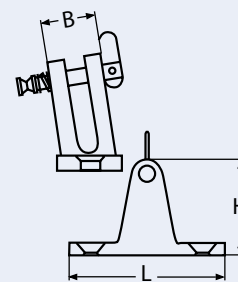

Verdeckbeschlagsplatte / A4-AISI 316

Deck hinge plate / Platine de capote plate

8853

Bestell-Nr. Order no.	L	B	H	Box	*€/Stück *€/piece
8853473_48	73	48	34	5	14,30

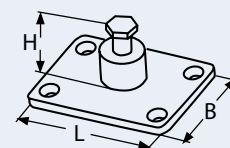

4

Relingsbeschlage, Rohr und Zubehor

Rail fittings, tubing and accessories

Embases, platines, tubes et accessories

8311

Verdeckbeschlag, 90° / A4-AISI 316

Deck hinge, 90° / Platine de capote, 90°

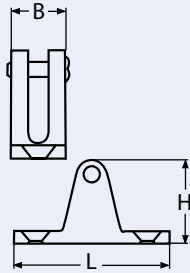

Bestell-Nr. Order no.	L	B	H	Box	*€/Stück *€/piece
8311456_17	56	17	35	5	6,00

8313

Verdeckbeschlag Unterteil, 80° / A4-AISI 316

Deck hinge angle base, 80° / Platine de capote, 80°

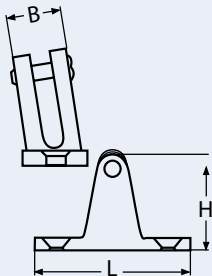

Bestell-Nr. Order no.	L	B	H	Box	*€/Stück *€/piece
8313456_20	56	20	36	5	7,00

8312

Verdeckbeschlag Seitenplatte / A4-AISI 316

Deck hinge side mounted / Platine de capote

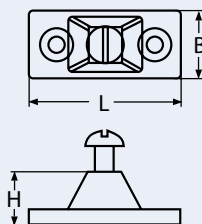

Bestell-Nr. Order no.	L	B	H	Box	*€/Stück *€/piece
8312450_23	50	23	33	5	6,00

814166

Teilbarer Verdeckbeschlag / A4-AISI 316

Removable deck hinge / Platine de capote amovible

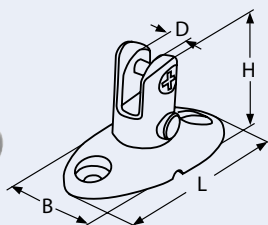

Bestell-Nr. Order no.	L	B	H	D	Box	*€/Stück *€/piece
814166475_35	75	35	47	8	1	35,00

Relingsbeschläge, Rohr und Zubehör

Rail fittings, tubing and accessories

Embases, platines, tubes et accessoires

4

Universal-Verdeckbeschlag / A4-AISI 316

Universal deck hinge / Platine de capote articulée universelle

8611

Bestell-Nr. Order no.	L	H	C	Box	*€/Stück *€/piece
8611425_70	70	45	17	5	15,20

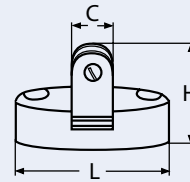

Bimini-Gelenk / A4-AISI 316

Bimini-joint / Joint de bimini à goupille

8652

Bestell-Nr. Order no.	Rohr-Ø Tube-Ø	L	B	C	H	Box	*€/Stück *€/piece
8652422	22	78	39	39	40	1	26,00
8652425	25	80	40	40	45	1	27,00

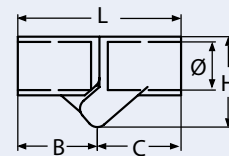

Bimini-Gelenk / A4-AISI 316

Bimini-joint / Joint de bimini articulé

8819

Bestell-Nr. Order no.	Rohr-Ø Tube-Ø	H	Box	*€/Stück *€/piece
8819422	22	97	5	35,20
8819425	25	97	5	36,20

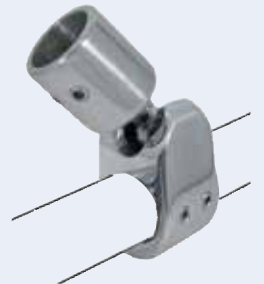
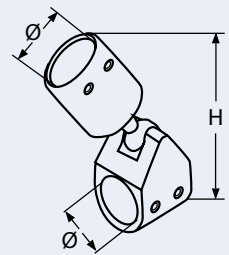

Bimini-Gelenk / A4-AISI 316

Bimini-joint / Joint de bimini articulé à goupille

8820

Bestell-Nr. Order no.	Rohr-Ø Tube-Ø	H	C	B	Box	*€/Stück *€/piece
8820422	22	82	30	42	5	48,20
8820425	25	82	30	42	5	49,20

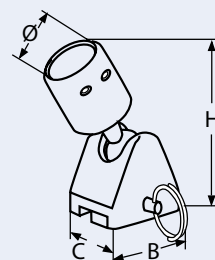

4

Relingsbeschlage, Rohr und Zubehor

Rail fittings, tubing and accessories

Embases, platines, tubes et accessories

814116

Biminispanner / A2-AISI 304

Adjustable Bimini pole / Poteau regable de bimini

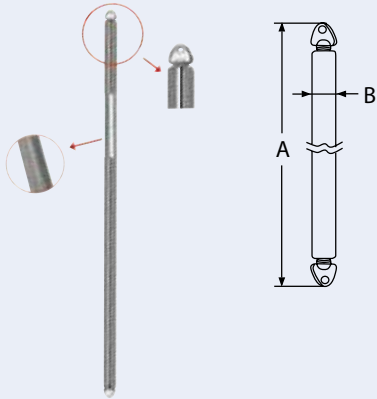

Bestell-Nr. Order no.	A-max.	A-min.	B	Box	*€/Stuck *€/piece
814116289	89	82	22	1	84,00
814116296	96	89	22	1	87,00
8141162103	103	97	22	1	90,00
8141162114	114	107	22	1	91,00

8542

Gurtbandbugel / A2-AISI 304

Strap fitting / Bride de maintien

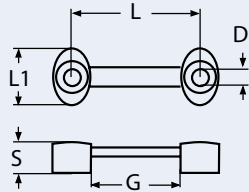
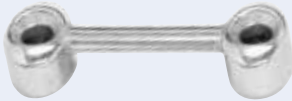

Bestell-Nr. Order no.	max. Gurtbreite (G) max. strap width (G)	L	L1	D	S	Box	*€/Stuck *€/piece
8542225	25	38	16	5	10	10	4,50

814207

Gurtbandbugel / A4-AISI 316

Strap fitting / Bride de maintien

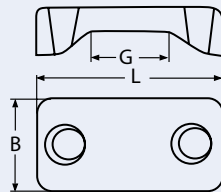

Bestell-Nr. Order no.	max. Gurtbreite (G) max. strap width (G)	L	B	Box	*€/Stuck *€/piece
814207425	25	50	15	5	7,60

8366

Riemenbugel / A4-AISI 316

Sling ring / Etrier plat pour sangle

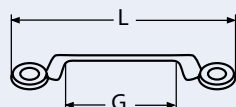

Bestell-Nr. Order no.	max. Gurtbreite (G) max. strap width (G)	L	Box	*€/Stuck *€/piece
8366426	30	68	10	4,40
8366436	40	75	10	4,80

Relingsbeschläge, Rohr und Zubehör

Rail fittings, tubing and accessories

Embases, platines, tubes et accessoires

4

Bügeltasche / A2-AISI 304 Flanges / Platine de pontet

8698

Bestell-Nr. Order no.	D	L	B	L1	B1	Box	*€/Stück *€/piece
8698220_35	30	20	3,5	29	24	5	8,90

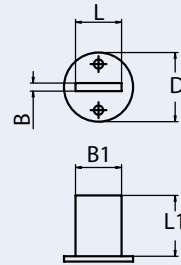

Bügeltasche / A2-AISI 304 Flanges / Platine de pontet

8699

Bestell-Nr. Order no.	L	B	L1	B1	Box	*€/Stück *€/piece
8699285_30	85	30	25	8	5	13,30

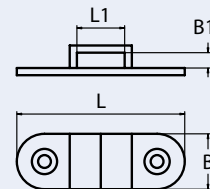

Bügeltasche / A2-AISI 304 Flanges / Platine de pontet

8697

Bestell-Nr. Order no.	L	B	L1	B1	Box	*€/Stück *€/piece
8697245_25	45	25	20	1,8	5	7,90

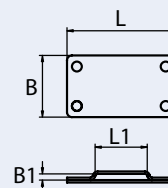

Loxx-Knopf Loxx knob / Bouton Loxx

8666

Bestell-Nr. Order no.	Oberteil Upper part	Material Material	Feder Spring	Gewindelänge Length of thread	Box	*€/Stück *€/piece
86666GROSS	Groß Large	Messing, vernickelt Brass, nickel plated	Stahl, vern. Steel, nickel pl.	4,9	50	3,50
86666GROSSXL	Groß Large	Messing, vernickelt Brass, nickel plated	Stahl, vern. Steel, nickel pl.	6,9	50	5,30
86662GROSS	Groß Large	Edelstahl Stainless steel	Edelstahl Stainless steel	4,9	50	6,50
86667GROSS	Groß Large	Messing, verchromt Brass, chrome plated	Stahl, vern. Steel, nickel pl.	4,9	50	4,60



LOXX[®]
Made in Germany

4

Relingsbeschläge, Rohr und Zubehör

Rail fittings, tubing and accessories

Embases, platines, tubes et accessories

8668

Loxx-Knopf für Tuch

Loxx knob for cloth / Bouton Loxx pour tissu



Bestell-Nr. Order no.	Unterteil Bottom part	Material Material	Box	*€/Stück *€/piece
86686STOFFE	Für Stoffe For fabric	Messing, vernickelt Brass, nickel plated	50	2,20

LOXX[®]
Made in Germany

8667

Schraube für Loxx-Knopf

Screw for Loxx knob / Vis pour bouton Loxx



Bestell-Nr. Order no.	Ø	Gewindelänge Length of thread	Material Material	Box	*€/Stück *€/piece
8667642_10	4,2	10	Messing/Stahl, vern. ¹	50	1,14
8667642_12	4,2	12	Messing/Stahl, vern. ¹	50	1,14
8667642_16	4,2	16	Messing/Stahl, vern. ¹	50	1,14
8667242_10	4,2	10	Edelstahl ²	50	1,70
8667242_12	4,2	12	Edelstahl ²	50	1,70
8667242_16	4,2	16	Edelstahl ²	50	1,70

¹ Brass/steel, nickel plated, ² Stainless steel

8696

Schraube für Loxx-Knopf

Screw for Loxx knob / Vis pour bouton Loxx



Bestell-Nr. Order no.	GW	Gewindelänge Length of thread	Material Material	Box	*€/Stück *€/piece
8696610VERN	M5	10	Messing, vernickelt ¹	50	1,60
8696710VERC	M5	10	Messing, verchromt ³	50	1,80
8696210	M5	10	Edelstahl ²	50	6,24

¹ Brass/steel, nickel plated, ² Stainless steel,

³ Brass, chrome plated

8839

Loxx Unterteil verschraubbar / Messing verchromt

Loxx bottom part for screw joint / Barre de vissage inférieur Loxx - Laiton Chromé

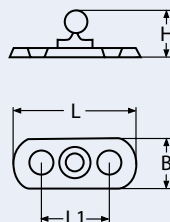

Bestell-Nr. Order no.	L	B	H	L1	Box	*€/Stück *€/piece
8839727_11	27	11	8,9	15,1	50	1,90

LOXX[®]
Made in Germany

Passend für 3,5mm Linsensenkschrauben
Fitting for 3.5mm countersunk head screws

Relingsbeschläge, Rohr und Zubehör

Rail fittings, tubing and accessories

Embases, platines, tubes et accessoires

4

NEW

Loxx Unterteil für Windschutzscheiben / Edelstahl C1-AISI 410

Loxx windshield clip stainless steel C1 / Loxx AISI 410

814693

Bestell-Nr. Order no.	Clipgröße Clip size	Box	*€/Stück *€/piece
814693234	3/4"	50	1,10
814693278	7/8"	50	1,25

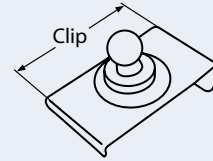

LOXX[®]
Made in Germany

Loxx Schlüssel Loxx key / Clé pour Loxx

814392

Bestell-Nr. Order no.	Box	*€/Stück *€/piece
81439210	10	5,00

LOXX[®]
Made in Germany



NEW

Loxx Schlüssel mit Holzgriff

Loxx key with wood handle / Clé pour Loxx avec manche en bois

814728

Bestell-Nr. Order no.	L	Box	*€/Stück *€/piece
81472810135	135	5	20,00

LOXX[®]
Made in Germany

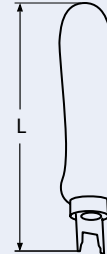

Durable Dot Kappe / Messing, vernickelt

Durable dot cap, brass, nickel finish / Pièce pour fixation de capote - Laiton nickelé

814035

Bestell-Nr. Order no.	Ø	Schaftlänge Shaft length	Box	*€/Stück *€/piece
814035615_44	15	4,4	100	0,20
814035615_61	15	6,1	100	0,30
814035615_80	15	8,0	100	0,35



Durable Dot Sockel / Messing, vernickelt

Durable dot socket, brass, nickel finish / Pièce pour fixation de capote - Laiton nickelé

814036

Bestell-Nr. Order no.	Ø	Box	*€/Stück *€/piece
814036615	15	100	0,20



4

Relingsbeschläge, Rohr und Zubehör

Rail fittings, tubing and accessories

Embases, platines, tubes et accessoires

814037

Durable Dot Zapfen / Messing, vernickelt

Durable dot stud, brass, nickel finish / Pièce pour fixation de capote - Laiton nickelé



Bestell-Nr. Order no.	Ø	Box	*€/Stück *€/piece
814037615	15	100	0,16

814038

Durable Dot Unterteil / Messing, vernickelt

Durable dot post, brass, nickel finish / Pièce pour fixation de capote - Laiton nickelé



Bestell-Nr. Order no.	Ø	Schaftlänge Shaft length	Box	*€/Stück *€/piece
814038614_61	14	6,1	100	0,12
814038614_75	14	7,5	100	0,18
814038614_94	14	9,4	100	0,21

814039

Durable Dot Unterteil für Windschutzscheiben / Messing, vernickelt

Durable dot windshield clip, brass, nickel finish / Socle pour fixation de capote - Laiton nickelé

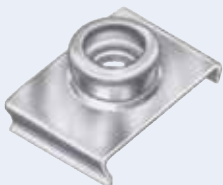

Bestell-Nr. Order no.	Clip Größe Clip size	Box	*€/Stück *€/piece
814039634	3/4"	100	0,80
814039678	7/8"	100	1,00

814040

Durable Dot Unterteil m. Edelstahlschraube, selbstschneidend / Messing, vernickelt

Durable dot screw stud with stainless steel screw self drilling, brass, nickel finish / **



Bestell-Nr. Order no.	Ø	Gewindelänge Length of thread	Box	*€/Stück *€/piece
814040615_095	15	9,5	100	0,90
814040615_159	15	15,9	100	1,00

** Socle pour fixation de capote avec vis inox auto-perçante - Laiton nickelé

Relingsbeschläge, Rohr und Zubehör

Rail fittings, tubing and accessories

Embases, platines, tubes et accessoires

4

Durable Dot Unterteil m. Edelstahlschraube / Messing, vernickelt

Durable dot srew stud with stainless steel screw, brass, nickel finish / **

814041

Bestell-Nr. Order no.	Ø	Gewindelänge Length of thread	Box	*€/Stück *€/piece
814041615_095	15	9,5	100	0,80
814041615_159	15	15,9	100	0,85

**Socle pour fixation de capote avec vis inox - Laiton nickélé



Lift-The-Dot Socket / Messing, vernickelt

Lift-The-Dot socket, brass, nickel finish / Système de fermeture - Lift the Dot - Finition nickel - cuivre

814228

Bestell-Nr. Order no.	Flügelänge Wing length	Box	*€/Stück *€/piece
814228656	5,6	100	1,00
814228670	7,0	100	1,50



4

Lift-The-Dot Gegenplatte / Messing, vernickelt

Lift-The-Dot back plate, brass, nickel finish / **

814229

Bestell-Nr. Order no.	Box	*€/Stück *€/piece
8142296	Für / For 814228	100 0,30

**Système de fermeture - Lift the Dot - Finition nickel - cuivre



Lift-The-Dot Unterteil zur Stoffmontage / Messing, vernickelt

Lift-The-Dot stud for textile mounting, brass, nickel finish / **

814230

Bestell-Nr. Order no.	Flügelänge Wing length	Box	*€/Stück *€/piece
814230643	4,3	100	0,90

**Système de fermeture - Lift the Dot - Finition nickel - cuivre



4

Relingsbeschläge, Rohr und Zubehör

Rail fittings, tubing and accessories

Embases, platines, tubes et accessoires

814231

Lift-The-Dot Gegenplatte / Messing, vernickelt

Lift-The-Dot washer, brass, nickel finish / **



Bestell-Nr. Order no.	Für / For	Box	*€/Stück *€/piece
8142316	814230	100	1,25

**Système de fermeture - Lift the Dot - Finition nickel - cuivre

814232

Lift-The-Dot Unterteil / Messing, vernickelt

Lift-The-Dot stud, brass, nickel finish / Système de fermeture - Lift the Dot - Finition nickel - cuivre

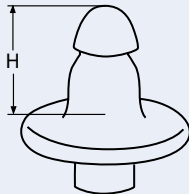

Bestell-Nr. Order no.	H	Box	*€/Stück *€/piece
8142326105	10,5	100	1,70

814233

Lift-The-Dot Gegenplatte / Messing, vernickelt

Lift-The-Dot washer, brass, nickel finish / **



Bestell-Nr. Order no.	Für / For	Box	*€/Stück *€/piece
8142336	814232	100	0,30

**Système de fermeture - Lift the Dot - Finition nickel - cuivre

814234

Lift-The-Dot Unterteil mit Messing-Holzschraube / Messing, vernickelt

Lift-The-Dot screw stud with wood thread, brass, nickel finish / **

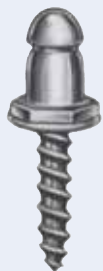

Bestell-Nr. Order no.	Kopfhöhe Height of stud	Gewindelänge Length of thread	Box	*€/Stück *€/piece
8142346133_95	13,3	9,5	100	1,40
8142346133_169	13,3	16,9	100	1,40

**Système de fermeture - Lift the Dot - Finition nickel - cuivre

Relingsbeschläge, Rohr und Zubehör

Rail fittings, tubing and accessories
Embases, platines, tubes et accessoires

4

Lift-The-Dot Unterteil mit Gewindeschraube / Messing, vernickelt Lift-The-Dot screw stud with thread screw, brass, nickel finish / **

814236

Bestell-Nr. Order no.	Kopfhöhe Height of stud	Gewindelänge Length of thread	Box	*€/Stück *€/piece
8142366133	13,3	9	100	1,20

**Système de fermeture - Lift the Dot - Finition nickel - cuivre



Lift-The-Dot Unterteil für Windschutzscheiben / Messing, vernickelt Lift-The-Dot windshield clip - brass, nickel finish / **

814249

Bestell-Nr. Order no.	Clipgröße Clip size	Box	*€/Stück *€/piece
814249634	3/4"	100	1,30
814249678	7/8"	100	1,40

**Système de fermeture - Lift the Dot - Finition nickel - cuivre



4

Lift-The-Dot Unterteil zum Verschrauben / Messing, vernickelt Lift-The-Dot stud for screwing - brass, nickel finish / **

814315

Bestell-Nr. Order no.	H	Box	*€/Stück *€/piece
814315610	10	100	3,00

**Système de fermeture - Lift the Dot - Finition nickel - cuivre



Dot Common Sense Drehverschluss / Messing, vernickelt Common Sense Dot turn button - brass, nickel finish / **

814237

Bestell-Nr. Order no.	H	H1	Box	*€/Stück *€/piece
814237620	20	7	100	2,80
814237622	22	9	100	2,90

**Système de fermeture - Common Sense - Finition nickel - cuivre

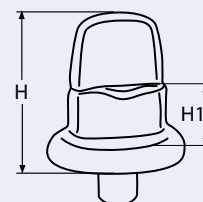

4

Relingsbeschläge, Rohr und Zubehör

Rail fittings, tubing and accessories

Embases, platines, tubes et accessoires

814238

Dot Common Sense Gegenplatte / Messing, vernickelt

Common Sense Dot back plate - brass, nickel finish / **



Bestell-Nr. Order no.	Für / For	Box	*€/Stück *€/piece
8142386	Für / For 814237	100	0,40

**Système de fermeture - Common Sense - Finition nichel - cuivre

814239

Dot Common Sense Drehverschluss mit zwei Zapfen / Messing, vernickelt

Common Sense Dot turn button with two cones - brass, nickel finish / **

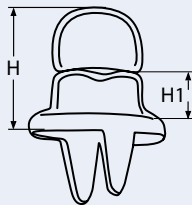

Bestell-Nr. Order no.	H	H1	Box	*€/Stück *€/piece
814239618	18	6	100	1,30
814239621	21	8	100	1,70

**Système de fermeture - Common Sense - Finition nichel - cuivre

814240

Dot Common Sense Gegenplatte / Messing, vernickelt

Common Sense Dot back plate - brass, nickel finish / **



Bestell-Nr. Order no.	Für / For	Box	*€/Stück *€/piece
8142406	Für / For 814239	100	0,30

**Système de fermeture - Common Sense - Finition nichel - cuivre

814241

Dot Common Sense Drehverschluss zum Verschrauben / Messing, vernickelt

Common Sense Dot turn button for screwing - brass, nickel finish / **



Bestell-Nr. Order no.	H	Box	*€/Stück *€/piece
8142416173	17,3	100	1,30
8142416200	20,0	100	1,60

**Système de fermeture - Common Sense - Finition nichel - cuivre

Relingsbeschläge, Rohr und Zubehör

Rail fittings, tubing and accessories

Embases, platines, tubes et accessoires

4

Dot Common Sense Drehverschluss mit Messingschraube, selbstschneidend / MS, vernickelt Common Sense Dot turn button with brass screw, self drilling - brass, nickel finish / **

814242

Bestell-Nr. Order no.	H	Gewindelänge Length of thread	Box	*€/Stück *€/piece
814242620	20	14,8	100	5,20

**Système de fermeture - Common Sense - Finition nickel - cuivre

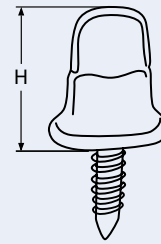

Dot Common Sense Drehverschluss mit Messing-Holzschraube / Messing, vernickelt Common Sense Dot turn button with wood thread - brass, nickel finish / **

814243

Bestell-Nr. Order no.	H	Gewindelänge Length of thread	Box	*€/Stück *€/piece
814243620	20	14,9	100	5,30

**Système de fermeture - Common Sense - Finition nickel - cuivre



Dot Common Sense Öse mit Zapfen / Messing, vernickelt Common Sense Dot grommet - brass, nickel finish / **

814244

Bestell-Nr. Order no.	Flügelänge Wing length	Box	*€/Stück *€/piece
814244685	8,5	100	0,40
814244698	9,8	100	0,60

**Système de fermeture - Common Sense - Finition nickel - cuivre

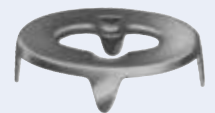

Dot Common Sense Gegenplatte / Messing, vernickelt Common Sense Dot washer - brass, nickel finish / **

814245

Bestell-Nr. Order no.	Box	*€/Stück *€/piece
8142456	Für / For 814244	100 0,40

**Système de fermeture - Common Sense - Finition nickel - cuivre



4

Relingsbeschläge, Rohr und Zubehör

Rail fittings, tubing and accessories

Embases, platines, tubes et accessories

814246

Dot Common Sense Gegenplatte, schwere Ausführung / Messing, vernickelt

Common Sense Dot washer, heavy duty - brass, nickel finish / **



Bestell-Nr. Order no.	Für / For	Box	*€/Stück *€/piece
8142466	814244	100	0,40

**Système de fermeture - Common Sense - Finition nickel - cuivre

814247

Dot Öse / Messing, vernickelt

Dot sheet grommet - brass, nickel finish / Système de fermeture - Finition Nickel - cuivre



Bestell-Nr. Order no.	Nr.	Innen-Ø Inside-Ø	Schaftlänge Shaft length	Box	*€/Stück *€/piece	
8142476044	44	1	4,4	4,4	100	0,08
8142476063	53	2	6,3	5,3	100	0,11
8142476073	53	3	7,3	5,3	100	0,15
8142476092	58	4	9,2	5,8	100	0,16
8142476110	85	5	11,0	8,5	100	0,19
8142476124	102	6	12,4	10,2	100	0,42

814248

Dot Gegenplatte / Messing, vernickelt

Dot plain washer - brass, nickel finish / Système de fermeture - Finition Nickel - cuivre



Bestell-Nr. Order no.	Für/For Nr. 814247	Innen-Ø Inside-Ø	Box	*€/Stück *€/piece
8142486055	1	5,5	100	0,04
8142486074	2	7,4	100	0,08
8142486090	3	9,0	100	0,11
8142486117	4	11,7	100	0,13
8142486134	5	13,4	100	0,12
8142486150	6	15,0	100	0,20

814411

Minax Oberteil / Plastik

Minax upper part / Bouton pression femelle supérieur en plastique



Bestell-Nr. Order no.	D	H	Box	*€/Stück *€/piece
814411323_11	23	11	100	2,15

Relingsbeschläge, Rohr und Zubehör

Rail fittings, tubing and accessories

Embases, platines, tubes et accessoires

4

Minax Unterteil / Plastik

Minax lower part / Bouton pression mâle inférieur en plastique

814412

Bestell-Nr. Order no.	D	Box	*€/Stück *€/piece
814412323	23	100	1,50



Minax Schraube mit Kreuzschlitz / A2-AISI 304

Minax cross slot screw / Bouton pression vis en inox

814413

Bestell-Nr. Order no.	Gewinde Thread	L	Box	*€/Stück *€/piece
814413235_25	3,5 x 14	25	100	2,70
814413235_32	3,5 x 22	32	100	2,70



4

Minax Schraube / Messing, vernickelt

Minax screw, brass, nickel-plated / Bouton pression vis en laiton nickelé

814414

Bestell-Nr. Order no.	Gewinde Thread	L	Box	*€/Stück *€/piece
814414643_25	4,3 x 13	25	100	2,15



Minax Maschinenschraube / Messing, vernickelt

Minax machine screw, brass, nickel-plated / Bouton pression vis pour machine en laiton nickelé

814415

Bestell-Nr. Order no.	Gewinde Thread	L	Box	*€/Stück *€/piece
81441564_20	M4 x 8	20	100	2,15
81441564_24	M4 x 12	24	100	2,15
81441564_32	M4 x 20	32	100	2,15



4

Relingsbeschläge, Rohr und Zubehör

Rail fittings, tubing and accessories

Embases, platines, tubes et accessoires

814210

Gummiseilhalter / „Persenning Knöpfe“ / A4-AISI 316

Norwegian knob / Taquet avec Système ressort

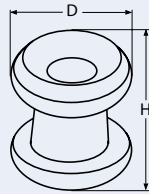

Bestell-Nr. Order no.	Für Schrauben Ø For screws Ø	D	H	Box	*€/Stück *€/piece
814210411_10	3,9	11	10	10	0,90

8226

Fenderöse / A2-AISI 304

Eye strap / Pontet

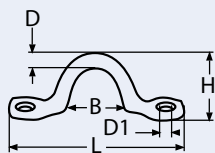

Bestell-Nr. Order no.	D	L	H	D1	B	Box	*€/Stück *€/piece
8226204	4	40	16	3,2	17,0	20	0,50
8226205	5	50	18	4,2	18,5	20	0,60
8226206	6	60	22	5,0	17,0	20	0,70
8226208	8	63	24	6,0	16,5	20	1,00
8226210	10	75	28	8,2	24,5	10	1,80

8227

Fenderöse, verstärkt / A4-AISI 316

Reinforced eye strap / Pontet renforcé

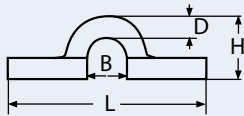

Bestell-Nr. Order no.	D	L	H	B	Box	*€/Stück *€/piece
8227405	5	48	15	15,5	10	2,50

8855

Augbügel / A4-AISI 316

Eye strap / Pontet plat

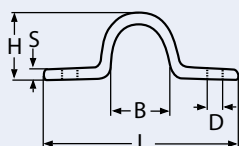

Bestell-Nr. Order no.	L	H	S	B	D	Box	*€/Stück *€/piece
8855445	45	11	1,2	13	4	10	3,20
8855448	48	14	1,2	16	4	10	3,40

Relingsbeschläge, Rohr und Zubehör

Rail fittings, tubing and accessories

Embases, platines, tubes et accessoires

4

NEW

Augbügel / A4-AISI 316
Eye strap / Pontet plat

814658

Bestell-Nr. Order no.	L	L1	L2	B	Ø	S	D	Box	*€/Stück *€/piece
814658466	66	56,0	26,0	11	4,2	1,2	10	10	0,50
814658469	69	57,5	25,5	11	4,2	1,2	13	10	0,60
814658472	72	59,0	35,0	11	4,2	1,2	16	5	0,70

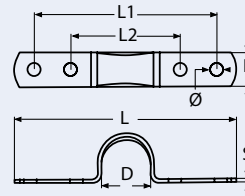

Flachbügel / A4-AISI 316
Sheet eye strap / Pontet renforcé plat

8860

Bestell-Nr. Order no.	L	H	D	B	Box	*€/Stück *€/piece
8860437	37	13	4	12,0	10	0,80
8860446	46	15	6	17,5	10	0,90
8860456	56	21	7	24,0	10	1,10

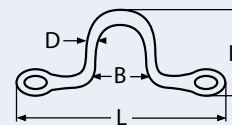

Gurthaken mit Wirbel (Bimini) / A4-AISI 316

Strap clip with swivel (Bimini) / Attache rapide à émerillon pour sangle

8540

Bestell-Nr. Order no.	A	B	L	S	Box	*€/Stück *€/piece
8540465_37	25	37	65	10	5	7,20

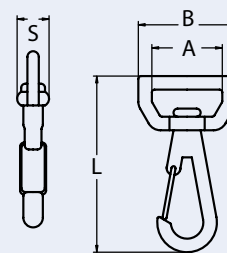

Gurthaken (Bimini) / A2-AISI 304

Fixed clip (Bimini) / Attache rapide fixe pour sangle

8541

Bestell-Nr. Order no.	A	B	L	C	S	Box	*€/Stück *€/piece
8541250_37	25	36	48	8	12	5	2,50

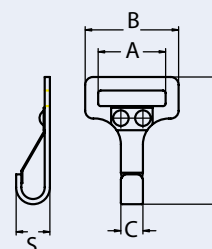

4

Relingsbeschläge, Rohr und Zubehör

Rail fittings, tubing and accessories

Embases, platines, tubes et accessories

NEW

814655

Gurthaken / A4-AISI 316
Straphook / Crochet de griffe

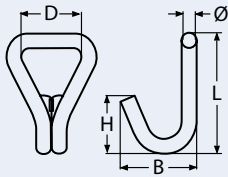

Bestell-Nr. Order no.	Ø	L	H	B	D	Box	*€/Stück *€/piece
814655407	7	56	27	35,5	28	5	16,50

8496

Gurtschnalle / A4-AISI 316
Strap latch / Double passant pour sangle

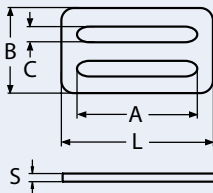

Bestell-Nr. Order no.	A	B	L	C	S	Box	*€/Stück *€/piece
8496462_34	50	34	62	5	3	10	2,90

8543

Gurtschnalle / A2-AISI 304
Strap latch / Double passant pour sangle

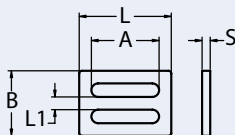

Bestell-Nr. Order no.	A	B	L	L1	S	Box	*€/Stück *€/piece
8543225_35	25	25	35	5	3	10	1,50

8764

Gurtschnalle / A2-AISI 304
Strap latch / Double passant ajustable pour sangle

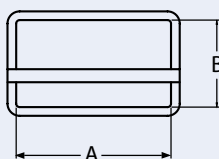

Bestell-Nr. Order no.	A	B	Box	*€/Stück *€/piece
8764225_25	25	25	10	4,60
8764243_28	40	28	10	5,90
8764250_30	50	30	10	6,60

Relingsbeschläge, Rohr und Zubehör

Rail fittings, tubing and accessories

Embases, platines, tubes et accessoires

4

Gurtschnalle / A4-AISI 316

Strap latch / Passant pour sangle

8497

Bestell-Nr. Order no.	A	B	L	C	S	Box	*€/Stück *€/piece
8497465_40	50	40	65	22	4	10	3,90

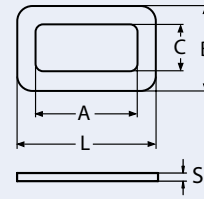

Spanngurt mit Wirbelverschluss / A4-AISI 316

Swivel webbing buckle kit / Sangle + Kit complet

8831

Bestell-Nr. Order no.	Gurtbreite Strap width	Länge Length	BL/Kg	Box	*€/Stück *€/piece
88314230	25	2300	400	1	49,00



Spanngurtverschluss / A4-AISI 316

Buckle / Boucle pour sangle

8829

Bestell-Nr. Order no.	A	H	L	Box	*€/Stück *€/piece
8829425	25	16	52	10	11,00

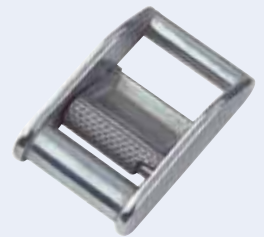
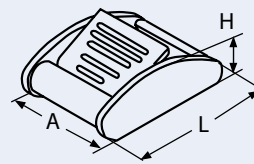

2 Spanngurte mit Verschluss / A4-AISI 316

2 tension belts with closure / 2 Sangles avec boucles

8823

Bestell-Nr. Order no.	Gurtbreite Strap width	Länge Length	Box	*€/Stück *€/piece
8823425	25	2300	1	35,00



4

Relingsbeschlage, Rohr und Zubehor

Rail fittings, tubing and accessories

Embases, platines, tubes et accessories

814106

Batteriehaltegurt / A4-AISI 316

Battery hold-down strap / Sangle pour maintien de batterie



Bestell-Nr. Order no.	Gurtbreite Strap width	Lange Length	Box	*€/Stuck *€/piece
814106496_25	25	960	5	42,50

8824

Spanngurt mit Ratsche / A2-AISI 304

Tension belts with ratchet / Sangle et crochet



Bestell-Nr. Order no.	Gurtbreite Strap width	Lange Length	BL/Kg	Box	*€/Stuck *€/piece
8824225	25	4500	650	1	42,00

8814

Gurtspanner / A2-AISI 304

Ratchet buckle / Tendeur pour sangles



Bestell-Nr. Order no.	Fur Gurtbreite For Strap width	Box	*€/Stuck *€/piece
8814225	25	1	15,50
8814240	40	1	53,50
8814250	50	1	67,00

8223

Decksplatte / A4-AISI 316

Pad eye diamond base / Pontet sur platine diamant

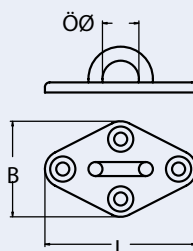
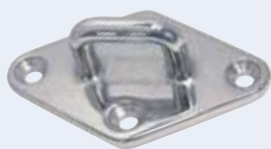

Bestell-Nr. Order no.	L	sen- Eye-	B	Box	*€/Stuck *€/piece
82234080	80	19 x 11	50	5	7,80
82234090	90	22 x 13	55	5	10,70
82234100	100	25 x 16	62	5	15,00

Relingsbeschläge, Rohr und Zubehör

Rail fittings, tubing and accessories

Embases, platines, tubes et accessoires

4

Decksplatte / A4-AISI 316

Pad eye oblong base / Pontet sur platine oblongue

8224

Bestell-Nr. Order no.	L	Ösen-Ø Eye-Ø	B	Box	*€/Stück *€/piece
82244075	75	16	22	5	6,50
82244088	88	19	32	5	10,30
82244100	100	22	36	5	14,20

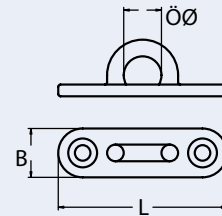

Decksplatte / A2-AISI 304

Eye plate / Pontet sur platine carrée

8225

Bestell-Nr. Order no.	L	B	D	Ösen-Ø Eye-Ø	Box	*€/Stück *€/piece
8225205	35	30	5	12	10	1,70
8225206	40	35	6	18	10	2,20
8225208	50	40	8	28	10	2,70

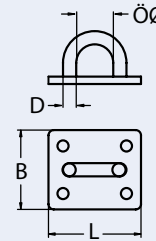

Mastplatte / A2-AISI 304

Pad eye / Pontet sur platine

8266

Bestell-Nr. Order no.	L	Ösen-Ø Eye-Ø	B	Box	*€/Stück *€/piece
82662045	45	11 x 12	16	10	2,50
82662065	60	14 x 18	19	10	3,80
82662081	81	19 x 22	25	10	5,00
82662100	100	24 x 28	36	10	6,00

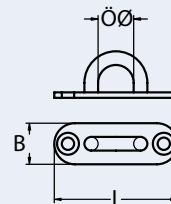

Mastplatte / A2-AISI 304

Diamond pad eye / Pontet sur platine diamant

8264

Bestell-Nr. Order no.	D	L	B	H	Ösen-Ø Eye-Ø	Box	*€/Stück *€/piece
8264205	5	60	36	20	16 x 13	5	4,00
8264206	6	65	40	26	19 x 16	5	4,50
8264208	8	80	50	32	22 x 19	5	5,80

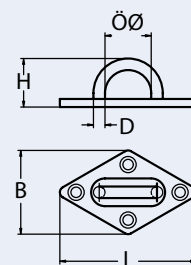

4

Relingsbeschlage, Rohr und Zubehor

Rail fittings, tubing and accessories

Embases, platines, tubes et accessories

8265

Mastplatte mit Ring / A2-AISI 304

Diamond ring pad eye / Pontet sur platine diamant

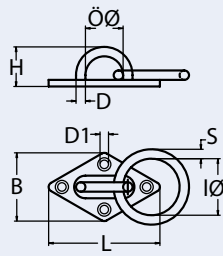

Bestell-Nr. Order no.	D	L	B	H	sen- Eye-	Innen- Inside-	Starke Strength	Box	*/Stuck */piece
8265205	5	60	36	20	16 x 13	30	5	5	5,20
8265206	6	65	40	26	19 x 16	35	6	5	6,20
8265208	8	80	50	32	22 x 19	45	8	5	9,00

8365

Mastplatte, gewolbt fur ca. 60 - 70 mm  / A2-AISI 304

Eye plate, concave / Pontet sur platine concave

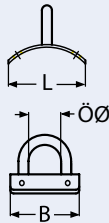

Bestell-Nr. Order no.	Auge Eye	L	B	sen- Eye-	Box	*/Stuck */piece
83652465_42	Senkrecht Vertical	46,5	42	20	5	5,00
8365251_39	Waagerecht Horizontal	51,0	39	20	5	5,00

8397

Augplatte mit Wirbel und Ring / A2-AISI 304

Swivel ring plate / Anneau mobile sur platine carree avec anneau

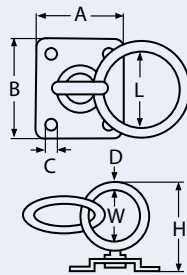

Bestell-Nr. Order no.	D	L	A	B	H	W	C	Box	*/Stuck */piece
839725	5	30	30	35	41	15	4,2	5	5,00
839726	6	40	35	40	45	18	4,2	5	6,00
839728	8	50	40	50	50	19	5,2	5	8,00

8396

Augplatte mit Wirbel / A2-AISI 304

Swivel eye plate / Anneau mobile sur platine carree

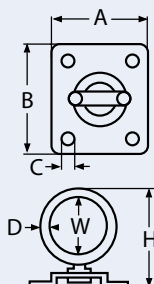

Bestell-Nr. Order no.	D	A	B	W	H	C	Box	*/Stuck */piece
839625	5	30	35	15	41	4,2	5	3,00
839626	6	35	40	18	45	4,2	5	4,00
839628	8	40	50	19	50	5,7	5	6,00

Relingsbeschläge, Rohr und Zubehör

Rail fittings, tubing and accessories

Embases, platines, tubes et accessoires

4

Augplatte, rund / A2-AISI 304

Eye plate, round / Pontet sur platine ronde

8353

Bestell-Nr. Order no.	D	A1	A2	H	h	W	C	Box	*€/Stück *€/piece
835325	5	33	19,5	20	12	13	4,2	10	2,20
835326	6	40	23	26	17	17	4,2	10	2,50
835328	8	50	29,5	32	21	20	5,2	10	3,30

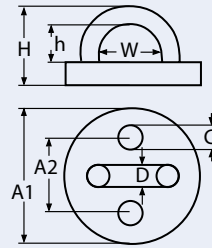

Augplatte, rund mit Gewinde / A2-AISI 304

Eye plate, round with thread / Pontet sur platine ronde avec tige filetée

8368

Bestell-Nr. Order no.	D	A	H	h	W	B	GW	Box	*€/Stück *€/piece
836825	5	33	20	12	13	20	M6	10	2,70
836826	6	40	26	17	17	23	M8	10	3,30
836828	8	50	32	20	20	25	M10	10	3,90

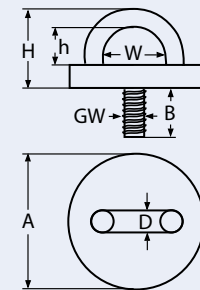

Augplatte mit Haken / A4-AISI 316

Round plate with hook / Platine ronde avec crochet

8972

Bestell-Nr. Order no.	D	A	B	C	BL/Kg	Box	*€/Stück *€/piece
8972405	5	33	8	4,5	200	10	1,90
8972406	6	40	12	4,5	220	10	2,50
8972408	8	50	14	5,5	250	10	4,30

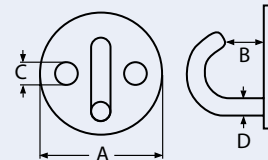

NEW

Augplatte mit Haken / A4-AISI 316

Eye plate with hook / Pontet crochet sur platine

814657

Bestell-Nr. Order no.	Ø	L	D	L1	B	BL/Kg	Box	*€/Stück *€/piece
814657405	5	54	8	38	16	200	5	1,90
814657406	6	65	12	46	19	220	5	2,50
814657408	8	81	13	55	26	250	2	4,30
814657409	9	100	16	62	32	280	2	7,20

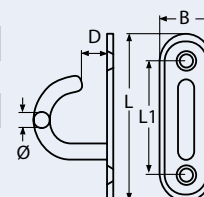

4

Relingsbeschlage, Rohr und Zubehor

Rail fittings, tubing and accessories

Embases, platines, tubes et accessories

814117

Augverschluss, gerade / A4-AISI 316

Swivel locking eye, straight / Couvercle  oeil droit

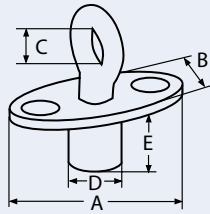

Bestell-Nr. Order no.	A	B	C	D	E	Box	*€/Stuck *€/piece
814117444	44	22	10	12	14	5	12,70

814118

Augverschluss, 90 / A4-AISI 316

Swivel locking eye, 90 angle / Couvercle  oeil avec angle de 90

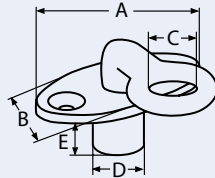

Bestell-Nr. Order no.	A	B	C	D	E	Box	*€/Stuck *€/piece
814118444	44	22	10	12	14	5	13,10

8344

Fallenaustritt / A2-AISI 304

Bush / Sortie de drisse

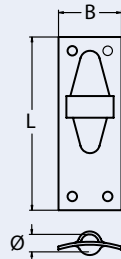

Bestell-Nr. Order no.	Typ Type	L	B	 bis max.	Box	*€/Stuck *€/piece
83442GEBOGEN	Gebogen Curved	83	32	12	10	4,00
83442GERADE	Gerade Straight	83	32	12	10	4,00

8354

Rohrschelle / A2-AISI 304

Clip / Collier de serrage



Bestell-Nr. Order no.	Ausfuhrung Design	Fur Rohr- For tube-	Box	*€/Stuck *€/piece
83542HALB	Halbschale Half circle	25	10	2,00
83542VOLL	Vollschale Full circle	25	10	2,00

Relingsbeschläge, Rohr und Zubehör

Rail fittings, tubing and accessories
Embases, platines, tubes et accessoires

4

Doppelschelle / A2-AISI 304
Clamp / Collier de serrage

8357

Bestell-Nr. Order no.	Ausführung Construction	für Rohr-Ø for tube-Ø	Box	*€/Stück *€/piece
83572SINGLE	Single /Single	25	5	5,00
83572FEST	Doppel, feststehend Double fixed	25	5	10,00
83572WIRBEL	Doppel mit Wirbel Double with swivel	25	5	11,00



Scheuerleiste, halbrund, poliert / A4-AISI 316
Rub strakes, half-round, polished / Liston de protection

8263

Bestell-Nr. Order no.	B	H	L	Bohrung Drilling	Lochabst. Hole spacing	Qualität Quality	*€/Meter *€/metre
8263410_35POL	10	3,5	3100			poliert ¹	25,00
8263410_35GEB	10	3,5	3100	3,0	122	poliert+gebohrt ²	40,00
8263414_4POL	14	4	3100			poliert ¹	30,50
8263414_4GEB	14	4	3100	3,0	122	poliert+gebohrt ²	48,00
8263420_4POL	20	4	3100			poliert ¹	37,50
8263420_4GEB	20	4	3100	3,0	150	poliert+gebohrt ²	57,50
8263430_9POL	30	9	3100			poliert ¹	147,00
8263430_9GEB	30	9	3100	4,5	200	poliert+gebohrt ²	180,00
8263440_8POL	40	8	3100			poliert ¹	193,00
8263440_8GEB	40	8	3100	optional		poliert+gebohrt ²	255,00
8263450_12POL	50	12	3100			poliert ¹	342,00
8263450_12GEB	50	12	3100	optional		poliert+gebohrt ²	380,00

¹ polished, ² polished and drilled

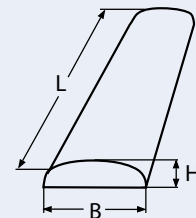

Scheuerleiste, flach, poliert / A4-AISI 316
Rub strakes, flat, polished / Liston de protection plat

814100

Bestell-Nr. Order no.	B	H	L	Bohrung Hole	Lochabst. Hole spacing	Qualität Quality	Box	*€/Meter *€/metre
814100414p	14	4	3100			poliert ¹	1	29,50
814100414pg	14	4	3100	3,8	150	poliert+gebohrt ²	1	47,00
814100420p	20	4	3100			poliert ¹	1	50,00
814100420pg	20	4	3100	4,5	150	poliert+gebohrt ²	1	60,00

¹ polished, ² polished and drilled

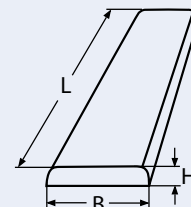

4

Relingsbeschlage, Rohr und Zubehor

Rail fittings, tubing and accessories

Embases, platines, tubes et accessories

814601

Scheuerleiste halbrund, hohl, poliert , gebohrt / A4-AISI 316

Rub strakes half-round, hollow, polished, drilled / Liston de protection semi arrondi poli et percee

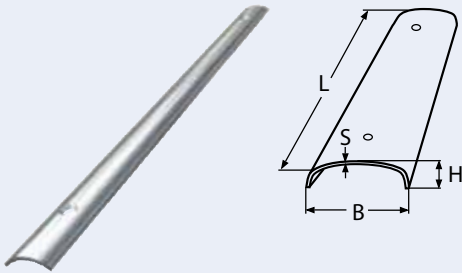

Bestell-Nr. Order no.	B	H	L	S	Bohrung Hole	Lochabst. Hole spacing	Box	*€/Meter *€/metre
814601419	19	6	3000	2	5,8	148	1	25,00
814601432	32	8	3000	2	7,5	148	1	34,00

814115

Scheuerleistenendstucke / A4-AISI 316

Rub end caps / Embout de liston de protection

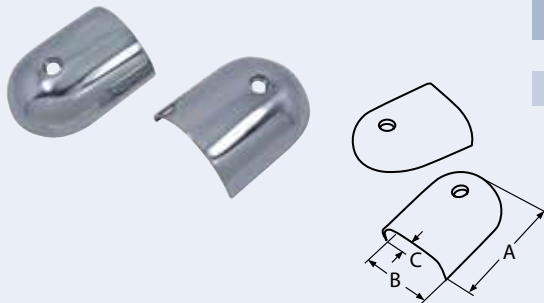

Bestell-Nr. Order no.	A	B	C	Box	*€/Stuck *€/piece
814115445	60	45	19	2	11,30
814115447	60	47	19	2	11,60
814115457	73	57	25	2	14,50

8439

Kratzerstop, halbrund und hohl / A2-AISI 304

Rub strakes, half-round and hollow / Liston de protection  moiti en rond - Version creuse

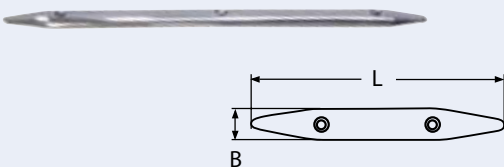

Bestell-Nr. Order no.	L	B	Box	*€/Stuck *€/piece
84392200	200	20	5	9,00
84392300	300	20	5	12,00
84394450	450	20	5	13,80
84394600	600	20	5	19,10

8440

Kratzerstop, halbrund und massiv / A4-AISI 316

Rub strakes, half-round and solid / Liston de protection  moiti en rond - Version lourde

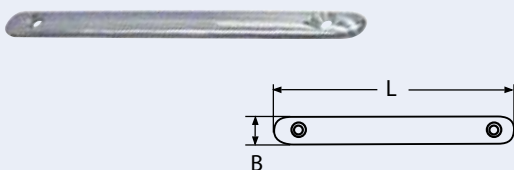

Bestell-Nr. Order no.	L	B	Box	*€/Stuck *€/piece
84404150	150	13	5	8,20

Relingsbeschläge, Rohr und Zubehör

Rail fittings, tubing and accessories

Embases, platines, tubes et accessoires

4

Handlauf mit LEDs / A4-AISI 316

Handrail with LEDs / Main courante avec LED

814595

Bestell-Nr. Order no.	L	D	LED's	Box	*€/Stück *€/piece
8145954200	200	22	1	1	24,50
8145954300	300	22	2	1	32,80
8145954500	500	22	2	1	37,50
8145954800	800	22	3	1	47,00
81459541000	1000	22	4	1	64,30

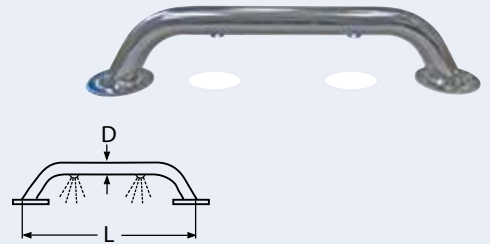

NEW

Handlauf / A4-AISI 316

Handrail / Poignée

814721

Bestell-Nr. Order no.	L	D	Box	*€/Stück *€/piece
81472140200	200	22	1	23,00
81472140300	300	22	1	26,80
81472140500	500	22	1	32,60
81472140800	800	22	1	42,90
81472141000	1000	22	1	48,20

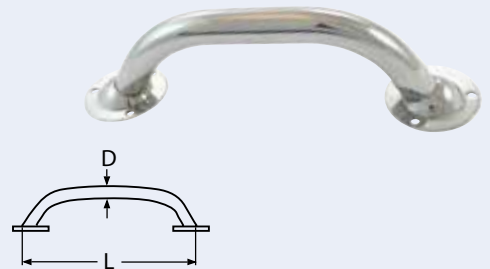

Handlauf / A2-AISI 304

Handrail / Poignée inox

8507

Bestell-Nr. Order no.	L	D	H	Box	*€/Stück *€/piece
85072225	260	25	75	1	27,00
85072300	340	25	75	1	32,00
85072400	440	25	75	1	62,00
85072600	640	25	75	1	77,00

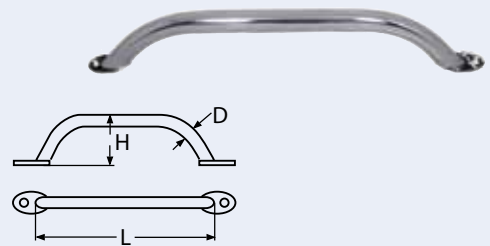

Handlauf / A2-AISI 304

Handrail / Poignée inox

8442

Bestell-Nr. Order no.	L	D	H	GW	Box	*€/Stück *€/piece
84422220	220	25	50	5/16" UNC	1	21,00
84422300	300	25	50	5/16" UNC	1	25,00
84422460	460	25	50	5/16" UNC	1	34,00
84422610	610	25	50	5/16" UNC	1	35,00

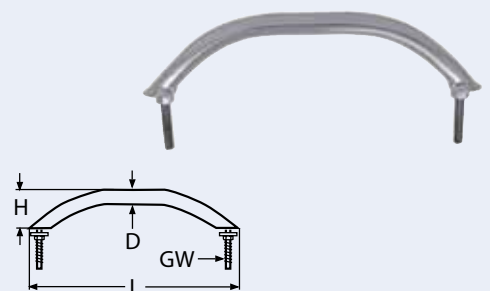

4

Relingsbeschlage, Rohr und Zubehor

Rail fittings, tubing and accessories

Embases, platines, tubes et accessories

814189

Handlauf mit Innengewinde / A4-AISI 316

Handrail with internal thread / Poignee inox

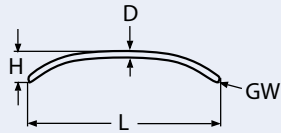

Bestell-Nr. Order no.	L	D	H	GW	Box	*€/Stuck *€/piece
8141894300	300	13 x 33	50	M6	1	43,00
8141894450	450	13 x 33	50	M6	1	53,00
8141894610	610	13 x 33	50	M6	1	65,00

814190

Handlauf / A2-AISI 304

Handrail / Poignee inox

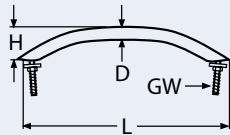
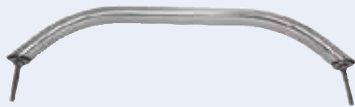

Bestell-Nr. Order no.	L	D	H	GW	Box	*€/Stuck *€/piece
8141902300	300	25	50	5/16" UNC	1	23,00
8141902460	460	25	50	5/16" UNC	1	25,00
8141902610	610	25	50	5/16" UNC	1	31,00

8587

Flaggenstockhalter / A4-AISI 316

Pennant pole holder / Support de hampe

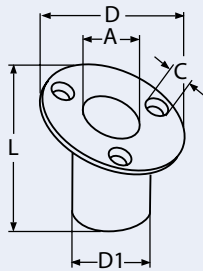

Bestell-Nr. Order no.	A	D	D1	C	L	Box	*€/Stuck *€/piece
8587470	32	70	36	6,5	55	1	29,00

8586

Flaggenstockhalter / A2-AISI 304

Pennant pole holder / Support de hampe

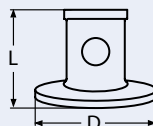
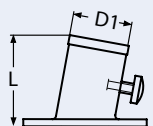

Bestell-Nr. Order no.	D1	D	L	Box	*€/Stuck *€/piece
8586226	26	67	50	1	29,00

Relingsbeschläge, Rohr und Zubehör

Rail fittings, tubing and accessories

Embases, platines, tubes et accessoires

4

Antennenfuß / A4-AISI 316

Antenna base / Embase d'antenne

8603

Bestell-Nr. Order no.	GW	D	D1	C	L	L1	S	Box	*€/Stück *€/piece
8603425	3/4"	70	18	8	40	30	5	1	23,00

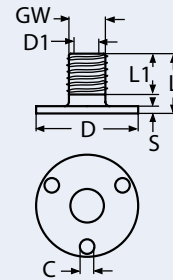

Antennenfuß / A2-AISI 304

Antenna base / Embase d'antenne

8604

Bestell-Nr. Order no.	GW	D	D1	C	L	L1	Box	*€/Stück *€/piece
8604225	3/4"	70	18	8	105	22	1	18,30

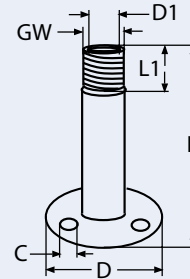

Antennenfuß / A4-AISI 316

Antenna base / Raccord d'antenne pour tube

8720

Bestell-Nr. Order no.	GW	D	L	Box	*€/Stück *€/piece
8720425	3/4"	25	50	1	12,50

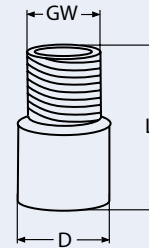

Lukenfederhalter / A2-AISI 304

Hatch spring holder / Compas inox à ressort

8472

Bestell-Nr. Order no.	L	L1	Ø	Box	*€/Stück *€/piece
84722235	235	220	10	1	9,20
84722295	295	265	15	1	14,20

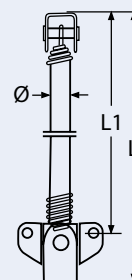

Kapitel 5

Chapter 5

Ketten und Verbinder

Chains and connectors

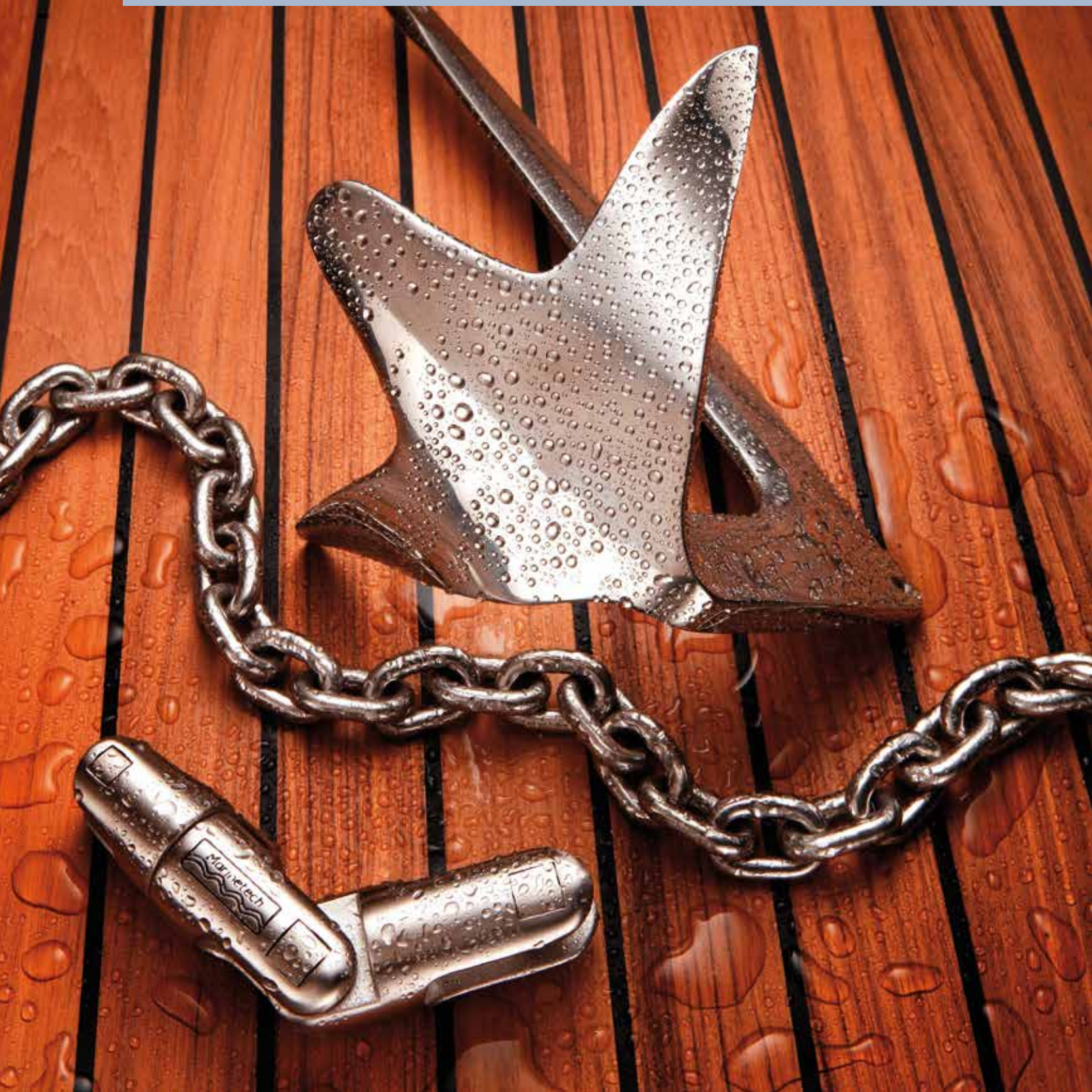

Rundstahlkette, Form und Maße gemäß DIN 766 / A4-AISI 316
Chain, Design and dimensions according to DIN 766 / Chaîne maillon court selon DIN 766

8300

Bestell-Nr. Order no.	Ø	Bund/m Bundle/m	P	b2	BL/Kg	*€/Meter *€/metre
8300402	2	100	12	8	125	3,80
8300403	3	100	16	11	280	4,40
8300404	4	50	16	14	800	8,30
8300405	5	50	18,5	17	1250	14,60
8300406	6	50/100	18,5	20	1600	18,40
8300407	7	50	22	23	2500	33,00
8300408	8	30/50/100	24	26	3200	36,10
8300410	10	30/50/60/100	28	34	5000	59,20
8300413	13	50	36	44	8000	101,30
8300416	16	1	46	51,7	13000	126,60

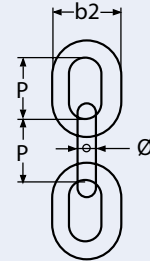

Rundstahlkette, Form und Maße gemäß DIN 763 / A4-AISI 316
Chain, Design and dimensions according to DIN 763 / Chaîne maillon long selon DIN 763

8301

Bestell-Nr. Order no.	Ø	Bund/m Bundle/m	P	b2	BL/Kg	*€/Meter *€/metre
83014015	1,5	100	12	6	90	2,00
8301402	2*	100	22	8	125	2,00
8301403	3*	100	26	12	280	3,70
8301404	4	50	32	16	630	6,80
8301405	5	50	35	20	1000	10,00
8301406	6	50	42	24	1250	15,60
8301408	8	50	52	32	2500	27,30
8301410	10	50	65	40	4000	43,20
8301413	13	50	82	52	6300	73,30

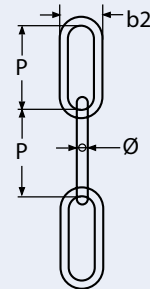

* Form und Maße gemäß DIN 5685 / * Form and measure to DIN 5685

Rundstahlkette, Form und Maße gemäß ISO 4565 / A4-AISI 316
Chain, Design and dimensions according to ISO 4565 / Chaîne maillon court selon ISO 4565

8747

Bestell-Nr. Order no.	Ø	Bund/m Bundle/m	P	b2	BL/Kg	*€/Meter *€/metre
8747410	10	50	30	34	5000	60,00

Achtung: Unterschied zu 8300-10mm ist hier das Maß P 30mm
Attention: difference to 8300-10mm is the size of P = 30mm

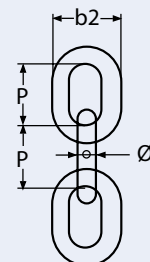

5

Ketten und Verbinder

Chains and connectors

Chaînes, maillons rapides et jonctions

8695

Knotenkette / A4-AISI 316

Knotted chain / Chaîne à maillons noués

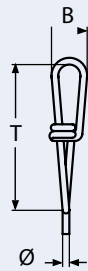

Bestell-Nr. Order no.	Ø	T	B	BL/Kg	Bund/m Bundle/m	Kg/100m	*€/Meter *€/metre
86954016	1,6	23	7,0	22	30	6,0	2,50
86954018	1,8	26	8,0	30	30	7,3	2,90
86954020	2,0	28	9,0	40	30	9,0	3,90
86954022	2,2	31	10,0	50	30	11,0	4,10
86954025	2,5	35	11,0	70	30	14,0	4,60
86954028	2,8	39	12,5	90	30	17,0	5,40

8821

Kettenmarkierung für Ankerketten

Chain mark for anchor chain / Marquage de chaîne pour chaîne d'ancre.

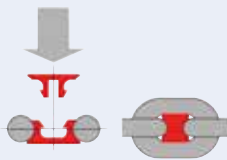

Bestell-Nr. Order no.	Ketten Ø Chain Ø	Box	*€/Stück *€/piece
8821306	6	50	0,60
8821308	8	50	0,62
8821310	10	50	0,66
8821313	13	50	0,76

Seewasserbeständig und schlagfest - grün-blau-pink-weiß-gelb,
je 10 Stück pro Farbe in einer Box.

Seawater resistant and shockproof - green-blue-pink-white-yellow,
10 pcs of each colour per box.

814654

Schraubverbinder quadratisch / A4-AISI 316

Square shape quick link / Maillon rapide forme carrée

NEW

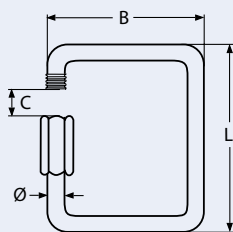

Bestell-Nr. Order no.	Ø	L	B	C	BL/Kg	Box	*€/Stück *€/piece
814654404	4	39,5	33	5,5	1000	10	1,60
814654405	5	47,5	38	6,5	1625	10	2,10
814654406	6	55,0	43	7,5	2250	10	3,10
814654408	8	71,0	53	10	3850	5	5,60
814654410	10	88,5	63	12	6250	5	10,50

8253

Schraubverbinder / A4-AISI 316

Quick link for chains / Maillon rapide

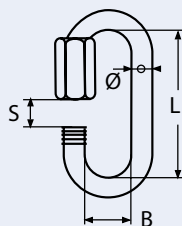

Bestell-Nr. Order no.	Ø	L	B	S	Box	*€/Stück *€/piece
8253403	3	27	9	4,3	20	1,70
8253404	4	32	12	5,5	20	2,10
8253405	5	39	13	6,5	20	2,40
8253406	6	45	14	7,5	10	2,50
8253408	8	58	18	9,5	10	4,10
8253410	10	69	22	12	5	9,60
8253412	12	81	24	14,5	5	12,40

Ketten und Verbinder

Chains and connectors

Chaînes, maillons rapides et jonctions

5

Schraubverbinder, lange Form / A4-AISI 316

Quick link, long / Maillon rapide, forme longue

8838

Bestell-Nr. Order no.	Ø	L	B	S	BL/Kg	Box	*€/Stück *€/piece
8838403	3,5	40	8,5	8,5	1000	20	1,55
8838404	4	45	11,5	11,5	1250	20	1,80
8838405	5	52	13,0	13,0	2000	20	2,50
8838406	6	58	14,5	14,5	2900	10	2,80
8838408	8	74	17,5	17,5	7900	10	4,90
8838410	10	85	20,5	20,5	8000	5	10,30
8838412	12	100	23,5	23,5	11000	5	14,50

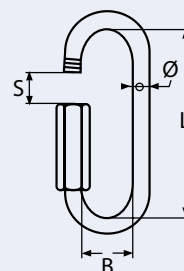

Delta-Schraubverbinder / A4-AISI 316

Delta quick link / Maillon - delta droite inox

8489

Bestell-Nr. Order no.	Ø	A	B	C	D	E	Box	*€/Stück *€/piece
8489404	4	34	26	39	31	5,5	10	2,30
8489405	5	39	30	47	38	6	10	2,80
8489406	6	47	34	55	44	7	10	3,30
8489408	8	55	39	72	56	9	5	6,00
8489410	10	66	46	86	66	12	5	10,00

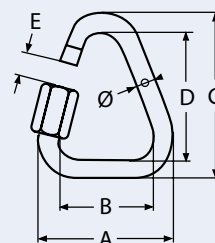

5

Kettenotglied zum Einnieten / A4-AISI 316

Security chain link / Maillon rapide à river

8363

Bestell-Nr. Order no.	für Kette mm For chain	b2	P	d	BL/Kg	Box	*€/Stück *€/piece
8363405	5	19	17,5	5	1200	10	2,40
8363406	6	24	21	6	2100	10	2,50
8363408	8	28	24	8	3000	5	2,80
8363410	10	34	29	10	4600	1	3,30

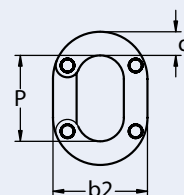

C-Ring / A4-AISI 316

C-ring / Maillon plat ouvert

8286

Bestell-Nr. Order no.	Ø	A	B	L	L1	BL/Kg	Box	*€/Stück *€/piece
8286405	5	8	17,5	20	30	300	10	1,40
8286406	6	9	21	24	36	450	10	1,50
8286408	8	12	28	32	48	650	5	1,60
8286410	10	15	35	40	60	900	5	3,40
8286413	13	20	46	52	78	1600	1	7,60
8286416	16	24	56	64	96	3000	1	13,60

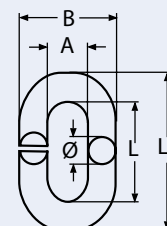

5

Ketten und Verbinder

Chains and connectors

Chaînes, maillons rapides et jonctions

8385

Pflugscharanker, hochglanzpoliert / A4-AISI 316

Plough anchor, highly polished / Ancre charrue polie

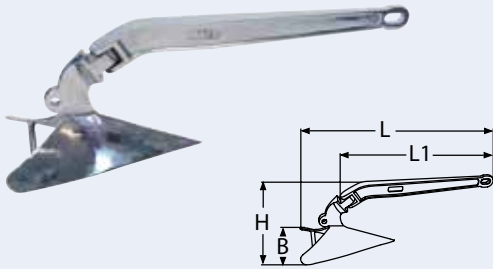

Bestell-Nr. Order no.	Kg	L	L1	H	B	Box	*€/Stück *€/piece
8385407	7	710	520	245	230	1	385,00
8385409	9	740	560	310	290	1	415,00
8385412	12	860	670	340	270	1	575,00
8385415	15	860	670	390	300	1	760,00
8385422	22	880	690	420	330	1	1220,00
8385427	27	880	690	450	340	1	1485,00

8414

„Lee“ Anker, hochglanzpoliert / A4-AISI 316

Lee anchor, mirror polished / Ancre FHD

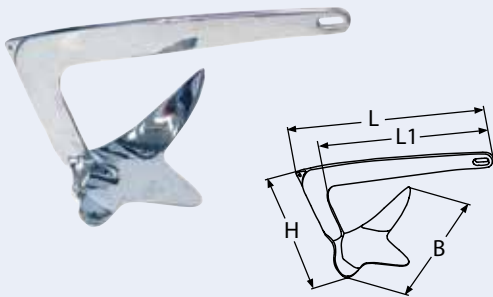

Bestell-Nr. Order no.	Kg	L	L1	H	B	Box	*€/Stück *€/piece
84144010	1	260	210	100	170	1	65,00
84144020	2	345	280	135	230	1	130,00
84144050	5	470	375	180	300	1	295,00
84144075	7,5	540	430	220	360	1	445,00
84144100	10	580	460	230	390	1	555,00
84144150	15	665	530	260	440	1	765,00
84144200	20	640	510	260	500	1	1170,00
84144300	30	810	640	325	530	1	1425,00

8376

Klappdraggen, hochglanzpoliert / A4-AISI 316

Draggen anchor, highly polished / Grappin

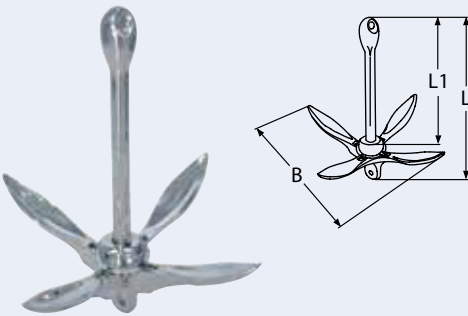

Bestell-Nr. Order no.	Kg	L	L1	B	Box	*€/Stück *€/piece
8376415	1,5	300	225	260	1	105,00
8376425	2,5	335	270	290	1	150,00
8376440	4	430	320	375	1	265,00

8530

Wurfanker / A4-AISI 316

Four flukes anchor / Grappin

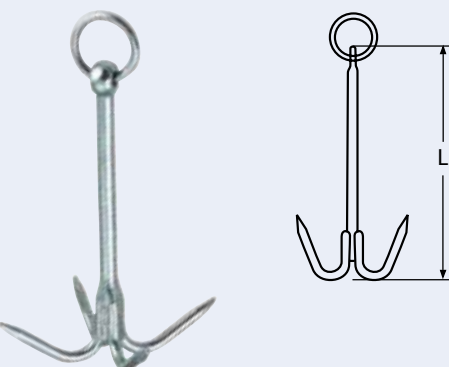

Bestell-Nr. Order no.	L	Kg	Box	*€/Stück *€/piece
85304200	200	0,5	1	21,00
85304240	240	1,0	1	43,00
85304315	315	1,9	1	74,50
85304375	375	3,0	1	112,00

Ketten und Verbinder

Chains and connectors

Chaînes, maillons rapides et jonctions

5

Bodenanker / A4-AISI 316
Bottom anchor / Ancre de rive

8547

Bestell-Nr. Order no.	L	Ø	D	S	Box	*€/Stück *€/piece
85474420	420	8	27	4	1	25,00

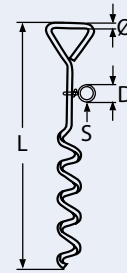

Anker Typ Danforth, hochglanzpoliert / A4-AISI 316
Anchor type Danforth, mirror polished / Ancre type Danforth

814072

Bestell-Nr. Order no.	Kg	L	L1	L2	B	Box	*€/Stück *€/piece
814072407	7	630	530	315	320	1	416,00
814072410	10	710	590	430	340	1	475,00
814072412	12	780	660	420	390	1	499,00
814072415	15	760	650	450	380	1	912,00
814072420	20	1.030	700	510	475	1	1136,00
814072430	30	900	760	540	590	1	1495,00

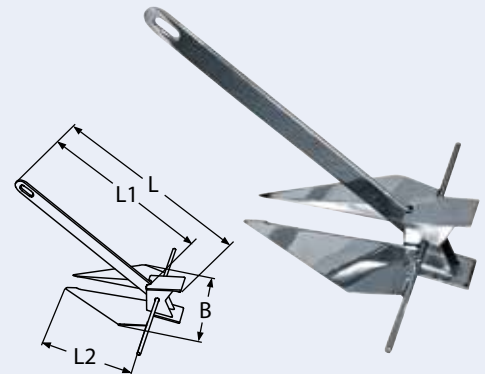

5

Kettenklüse / A4-AISI 316
Deck pipe / Charnière

8460

Bestell-Nr. Order no.	Ketten-Ø Chain-Ø	D	D1	B	H	Box	*€/Stück *€/piece
8460406_08	6 - 8	60	95	105	110	1	61,00
8460410_13	10 - 13	60	95	130	110	1	70,00

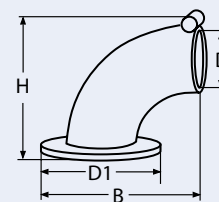

Ankerkettenstopper / A4-AISI 316
Mooring device with anchor chain lock / Bloqueur de chaîne d'ancre

814302

Bestell-Nr. Order no.	Für Kette-Ø For chain-Ø	Box	*€/Stück *€/piece
814302406_08	6 - 8	1	20,00
814302410_12	10 - 13	1	47,00



5

Ketten und Verbinder

Chains and connectors
Chaînes, maillons rapides et jonctions

8506

Kettenstopper / A4-AISI 316
Chain stopper / Bloqueur de chaîne

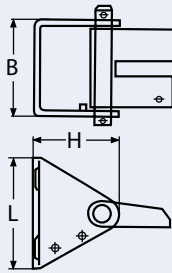

Bestell-Nr. Order no.	Ketten-Ø Chain-Ø	L	B	H	Box	*€/Stück *€/piece
8506408/10	8 +10	80	70	60	1	50,00

8352

Power-Ankerwirbel / A4-AISI 316
Power anchor connector / Jonction chaîne pour ancre

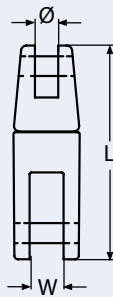

Bestell-Nr. Order no.	L	W	Für Ketten-Ø For chain-Ø	BL/Kg	Box	*€/Stück *€/piece
8352406_08	84	15	6 - 8	4250	1	33,50
8352410_12	96	21	10 - 13	6750	1	59,00

8608

Power-Ankerdoppelwirbel / A4-AISI 316
Power anchor connector - double swivel / Double jonction de chaîne pour ancre

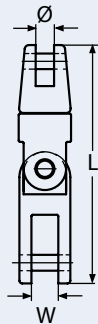

Bestell-Nr. Order no.	L	W	Für Ketten-Ø For chain-Ø	BL/Kg	Box	*€/Stück *€/piece
8608406/08	134	15	6 - 8	4250	1	50,00
8608410/12	154	21	10 - 13	6750	1	77,00

814652

Ankerwirbel / A4-AISI 316
Anchor connector / Jonction pour ancrés

NEW

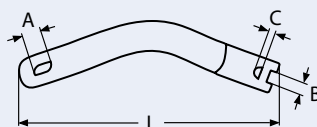

Bestell-Nr. Order no.	L	A	B	C	BL/Kg	Für Ketten-Ø For Chain-Ø	Box	*€/Stück *€/piece
814652406 08	220	20,5	11,1	9,3	2850	6-8	1	76,00
814652408 10	290	27,5	13,5	11,7	5680	8-10	1	190,00

NEW

Ankerwirbeladapter / A4-AISI 316

Anchor connector adaptor / Adaptateur de jonction pour ancrés

814663

Bestell-Nr. Order no.	L	B	C	D	E	Box	*€/Stück *€/piece
814663467	67	16	37	8	25	1	20,50

Für Ankerwirbel Artikel 8352 406.08
For anchor connector article 8352 406.08

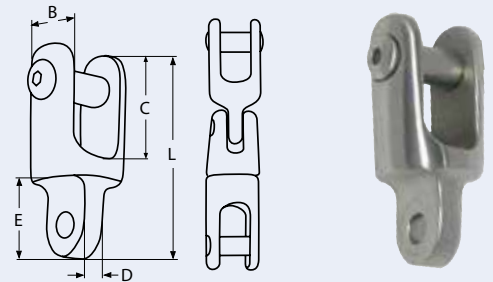

Kettenhaken, selbstklemmend / A4-AISI 316

Clavis grab hook / Croc de palan

8388

Bestell-Nr. Order no.	Für Kette For chain	A	E	B	R	BL/Kg	Box	*€/Stück *€/piece
8388406	6	11	9	9	46	2300	5	8,50
8388408	8	13	11	11	54	3650	5	14,50
8388410	10	15	13	12	62	4640	5	19,00

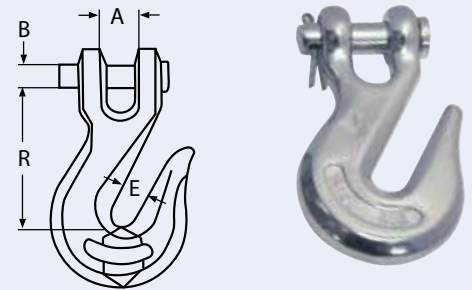

5

Kettenkarabinerhaken / A2-AISI 304

Chain-catch-snap / Mousqueton inox

8487

Bestell-Nr. Order no.	D	L	B	S1	S2	D1	BL/Kg	Box	*€/Stück *€/piece
848728_81	8	81	28	11	9	15	280	5	10,50

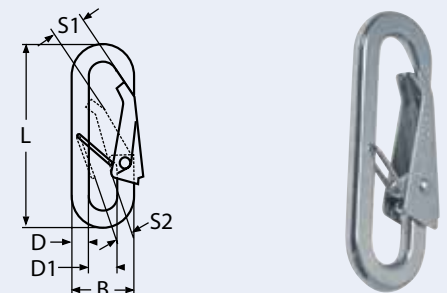

Bugrolle / A4-AISI 316

Bow roller / Davier fixe

8560

Bestell-Nr. Order no.	L	L1	B	Box	*€/Stück *€/piece
85604500	500	410	70	1	220,00

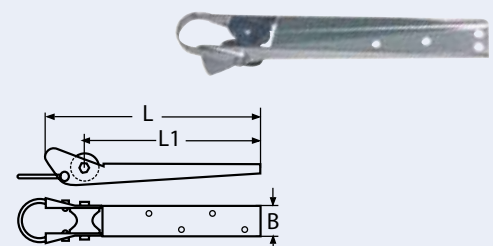

Ketten und Verbinder

Chains and connectors

Chaînes, maillons rapides et jonctions

8595

Ankerrolle mit Bolzen / A2-AISI 304

Anchor roller with pin / Davier avec verrouillage

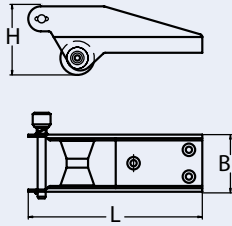

Bestell-Nr. Order no.	L	B	H	Box	*€/Stück *€/piece
85952200	200	60	80	1	60,00
85952250	250	60	80	1	72,00

8566

Bugrolle / A2-AISI 304

Bow roller / Davier simple

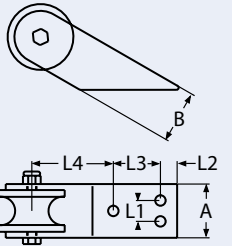

Bestell-Nr. Order no.	A	B	L1	L2	L3	L4	Box	*€/Stück *€/piece
8566250	50	52	20	17	62	50	1	29,00

814091

Bugrolle mit Wippe / A4-AISI 316

Bow roller with rocker plate / Davier à bascule

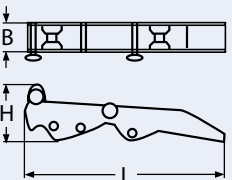

Bestell-Nr. Order no.	L	B	H	Box	*€/Stück *€/piece
8140914380	325	56	95	1	106,00

Ketten und Verbinder

Chains and connectors
Chaînes, maillons rapides et jonctions

5

Bugrolle mit Wippe / A2-AISI 304

Bow roller with rocker plate / Davier à bascule

814084

Bestell-Nr. Order no.	A	B	C	D	E	F	Box	*€/Stück *€/piece
8140842432	432	150	66	77	3,5	9	1	353,00
8140842577	577	160	66	77	3,5	9	1	399,00

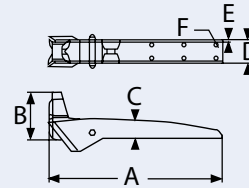

Heckankerausleger / A4-AISI 316

Stern anchor outtrigger / Support d'ancre

814386

Bestell-Nr. Order no.	L	B	Box	*€/Stück *€/piece
8143864535	535	150	1	210,00

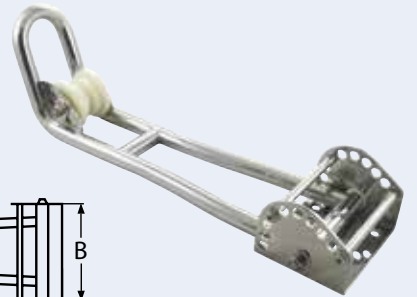
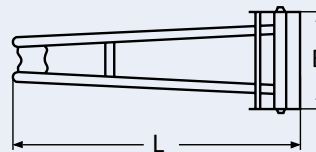

Ankergurtbandrolle mit Gurt / A4-AISI 316

Flat line spool with nylon webbing / Enrouleur de sangles

8551

Bestell-Nr. Order no.	D	Für Rohr-Ø For tube-Ø	B	Gurtbreite Strap width	Gurtlänge Strap length	Box	*€/Stück *€/piece
85514340	340	22 - 25	37	35	30m	1	288,00
85514430	430	22 - 25	37	35	50m	1	413,00

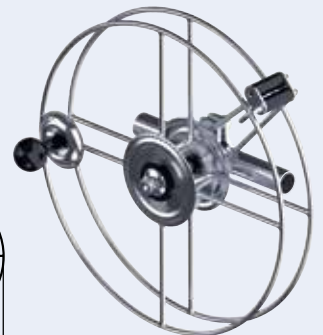
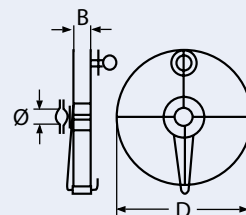

5

Ketten und Verbinder

Chains and connectors
Chaînes, maillons rapides et jonctions

8308

Tau- und Kettendurchlass (Klüse) / A4-AISI 316
Rope/deck pipe / Ecubier

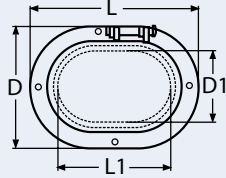

Bestell-Nr. Order no.	L	D	L1	D1	Box	*€/Stück *€/piece
83084140_100	140	100	95	60	1	73,50

8889

Klüse, dreieckig / A4-AISI 316
Hawse pipe, triangular / Tête de tuyau rectangulaire

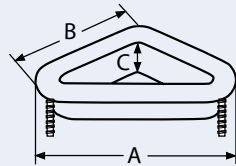

Bestell-Nr. Order no.	A	B	C	Box	*€/Stück *€/piece
88894180	180	150	49	1	66,50

8890

Klüse, oval / A4-AISI 316
Hawse pipe, oval / Tête de tuyau ovale

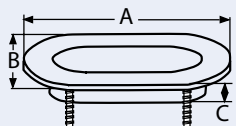

Bestell-Nr. Order no.	A	B	C	Box	*€/Stück *€/piece
88904138	138	63	25	1	45,00
88904145	145	97	32	1	50,00

Kapitel 6

Chapter 6

Scharniere, Griffe, Haken und Ringe

Hinges, handles, hooks and rings



6

Scharniere, Griffe, Haken und Ringe

Hinges, handles, hooks and rings

Charnières, poignées, crochets et anneaux

8231

Scharnier / A4-AISI 316

Door hinge / Charnière

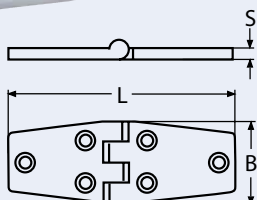

Bestell-Nr. Order no.	L	B	S	Box	*€/Stück *€/piece
82314076	76	38	4	5	6,80
82314100	100	38	4	5	8,70

8234

Scharnier / A4-AISI 316

Door hinge / Charnière

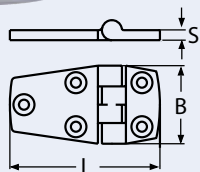

Bestell-Nr. Order no.	L	B	S	Box	*€/Stück *€/piece
8234456_38	56	38	4	5	6,30
8234476_38	76	38	4	5	7,80

8235

Scharnier / A4-AISI 316

Strap hinge / Charnière

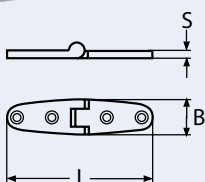

Bestell-Nr. Order no.	L	B	S	Box	*€/Stück *€/piece
82354100_25	100	25	4	5	6,80

8236

Scharnier / A4-AISI 316

Strap hinge / Charnière

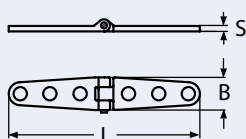

Bestell-Nr. Order no.	L	B	S	Box	*€/Stück *€/piece
82364160_27	160	27	4	5	11,00

Scharniere, Griffe, Haken und Ringe

Hinges, handles, hooks and rings
Charnières, poignées, crochets et anneaux

6

Scharnier / A4-AISI 316

Offset hinge / Charnière déportée

8237

Bestell-Nr. Order no.	L	B	S	H	Box	*€/Stück *€/piece
8237456_38	52	38	4	20	5	8,00
8237470_38	68	38	4	20	5	8,30

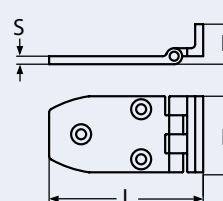

Scharnier / A4-AISI 316

Butt hinge / Charnière

8233

Bestell-Nr. Order no.	L	B	S	Box	*€/Stück *€/piece
8233438_38	38	38	4	5	6,00
8233450_50	50	50	4	5	6,50

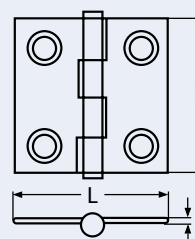

Motorhauben-Scharnier / A4-AISI 316

Take-apart motor box hinge / Charnière démontable

8239

Bestell-Nr. Order no.	L	B	S	Box	*€/Stück *€/piece
8239490_38	90	38	3	5	11,60

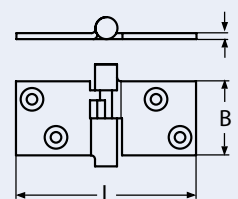

Scharnier / A4-AISI 316

Hatch hinge, standard / Charnière articulée

8238

Bestell-Nr. Order no.	L	B	S	Box	*€/Stück *€/piece
8238474_65	74	65	6	2	15,00

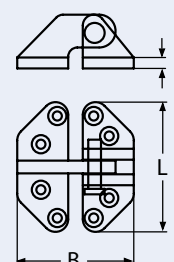

6

Scharniere, Griffe, Haken und Ringe

Hinges, handles, hooks and rings

Charnières, poignées, crochets et anneaux

8514

Scharnier, schwere Ausführung / A2-AISI 304

Hinge, heavy duty / Charnière lourde inox

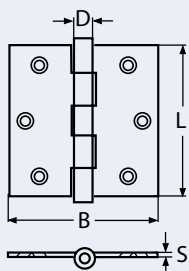

Bestell-Nr. Order no.	D	L	B	S	Box	*€/Stück *€/piece
8514275_75	10	75	75	2	5	11,00

8513

Scharnier, schwere Ausführung - Lagerringe / A2-AISI 304

Hinge, heavy duty / Charnière lourde inox

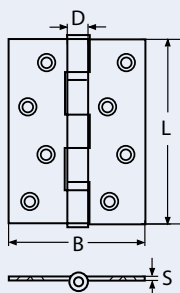

Bestell-Nr. Order no.	D	L	B	S	Box	*€/Stück *€/piece
85132100_75	11	100	75	2,5	5	13,00

814045

Scharnier, schwere Ausführung / A4-AISI 316

Hinge, heavy duty / Charnière lourde

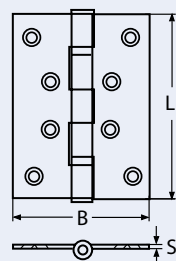

Bestell-Nr. Order no.	L	B	S	Box	*€/Stück *€/piece
8140454100_96	100	96	3	2	36,00

8512

Zweiteiliges Türscharnier, rechts oder links / A2-AISI 304

Two-part door hinge, right or left / Paumelle inox

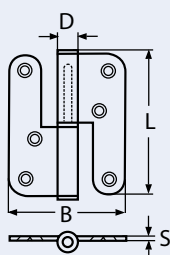

Bestell-Nr. Order no.	D	L	B	S	Box	*€/Stück *€/piece	
85122100_80RE	Rechts	14	100	80	3	2	19,50
	Right						
85122100_80LI	Links	14	100	80	3	2	19,50
	Left						

Scharniere, Griffe, Haken und Ringe

Hinges, handles, hooks and rings
Charnières, poignées, crochets et anneaux

6

Scharnier, zweiteilig, rechts oder links / A4-AISI 316

Two-part hinge right or left / Paumelle inox

814033

Bestell-Nr. Order no.	L	B	S	L1	C	D	Box	*€/Stück *€/piece
814033437_37RE	Rechts 37	37	2,6	23	12,5	13,5	5	10,00
	Right							
814033437_37LI	Links 37	37	2,6	23	12,5	13,5	5	10,00
	Left							

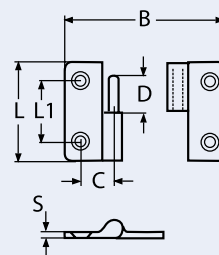

Scharnier / A2-AISI 304

Hinge / Charnière découpée

8429

Bestell-Nr. Order no.	Form Design	L	B	L1	S	D	S1	Box	*€/Stück *€/piece
84292129_40A	A	129	40	38	2	5	9	5	8,40
84292129_40B	B	129	40	38	2	5	9	5	9,00

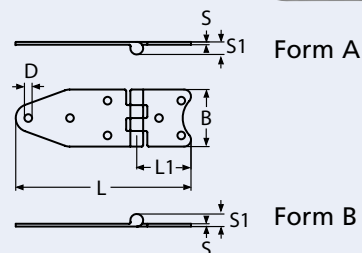

Scharnier / A2-AISI 304

Hinge / Charnière découpée

8430

Bestell-Nr. Order no.	Form Design	L	B	D	S	S1	Box	*€/Stück *€/piece
84302180_40A	A	180	40	5	2	9	5	8,70
84302180_40B	B	180	40	5	2	9	5	10,20

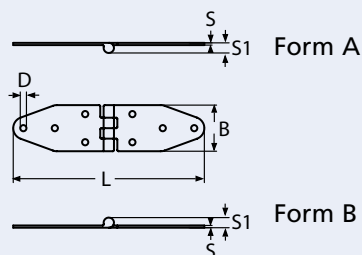

Scharnier / A2-AISI 304

Hinge / Charnière

8573

Bestell-Nr. Order no.	L	L1	B	D	S	S1	Box	*€/Stück *€/piece
85732160_28	160	80	28	4,5	3	8	5	7,20

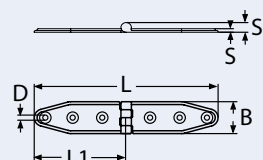

6

Scharniere, Griffe, Haken und Ringe

Hinges, handles, hooks and rings

Charnières, poignées, crochets et anneaux

8574

Scharnier / A2-AISI 304

Hinge / Charnière

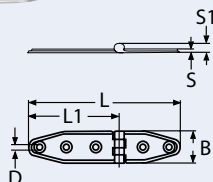

Bestell-Nr. Order no.	L	L1	B	D	S	S1	Box	*€/Stück *€/piece
85742133_28	133	80	28	4,5	3	8	5	6,50

8575

Scharnier / A2-AISI 304

Hinge / Charnière

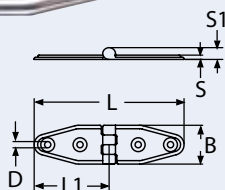

Bestell-Nr. Order no.	L	L1	B	D	S	S1	Box	*€/Stück *€/piece
85752105_28	105	53	28	4,5	3	8	5	4,95

8569

Scharnier / A2-AISI 304

Hinge / Charnière

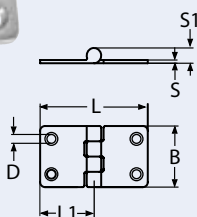

Bestell-Nr. Order no.	L	L1	B	D	S	S1	Box	*€/Stück *€/piece
8569238_38	38	19	38	5,5	2	9	5	6,00
8569268_38	68	34	38	5,5	2	9	5	7,60

814158

Scharnier / A2-AISI 304

Hinge / Charnière

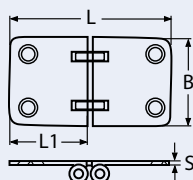

Bestell-Nr. Order no.	L	L1	B	S	Box	*€/Stück *€/piece
814158271_40	71	35,5	40	2	5	10,90

Scharniere, Griffe, Haken und Ringe

Hinges, handles, hooks and rings

Charnières, poignées, crochets et anneaux

6

Scharnier / A2-AISI 304
Hinge / Charnière

814159

Bestell-Nr. Order no.	L	L1	B	S	Box	*€/Stück *€/piece
814159249_37	49	24,5	37	2	5	8,90

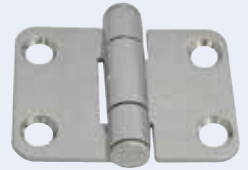
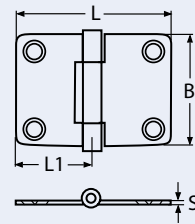

Scharnier / A2-AISI 304
Hinge / Charnière

814160

Bestell-Nr. Order no.	L	L1	B	S	Box	*€/Stück *€/piece
814160250_50	50	25	50	2	5	8,00

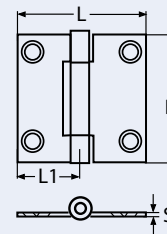

Scharnier / A2-AISI 304
Hinge / Charnière

814161

Bestell-Nr. Order no.	L	L1	B	S	Box	*€/Stück *€/piece
814161250_50	50	25	50	2	5	7,50

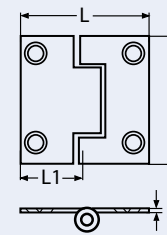

Scharnier / A2-AISI 304
Hinge / Charnière déportée

814162

Bestell-Nr. Order no.	L	L1	B	S	Box	*€/Stück *€/piece
8141624152_76	152	22	76	3	1	55,00

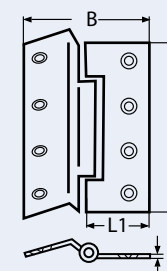

6

6

Scharniere, Griffe, Haken und Ringe

Hinges, handles, hooks and rings

Charnières, poignées, crochets et anneaux

814163

Scharnier / A4-AISI 316

Hinge / Charnière

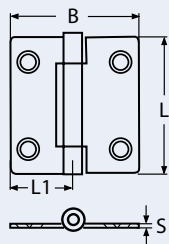

Bestell-Nr. Order no.	L	L1	B	S	Box	*€/Stück *€/piece
814163475_70	75	35	70	3	2	25,00

814164

Scharnier / A4-AISI 316

Hinge / Charnière

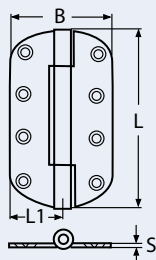

Bestell-Nr. Order no.	L	L1	B	S	Box	*€/Stück *€/piece
8141644152_71	152	35,5	71	3,5	2	41,50

814165

Scharnier / A4-AISI 316

Hinge / Charnière déportée

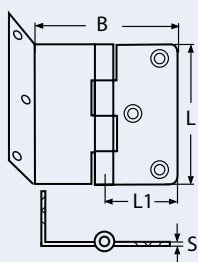

Bestell-Nr. Order no.	L	L1	B	S	Box	*€/Stück *€/piece
8141654100_102	100	33	87	3	1	43,00

8568

Scharnier / A2-AISI 304

Hinge / Charnière

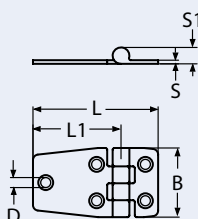

Bestell-Nr. Order no.	L	L1	B	D	S	S1	Box	*€/Stück *€/piece
8568258_38	58	40	38	5,5	2	9	5	7,10
8568268_38	68	49	38	5,5	2	9	5	8,00

Scharniere, Griffe, Haken und Ringe

Hinges, handles, hooks and rings

Charnières, poignées, crochets et anneaux

6

Scharnier / A2-AISI 304
Hinge / Charnière

8578

Bestell-Nr. Order no.	L	L1	B	D	S	S1	Box	*€/Stück *€/piece
8578287_38	87	38	38	5,5	2	9	5	7,80
8578297_38	97	40	38	5,5	2	9	5	8,80

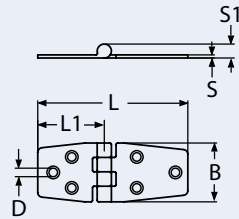

Scharnier / A2-AISI 304
Hinge / Charnière

8572

Bestell-Nr. Order no.	L	L1	B	D	S	S1	Box	*€/Stück *€/piece
8572275_38	75	37,5	38	5,5	2	9	5	7,50

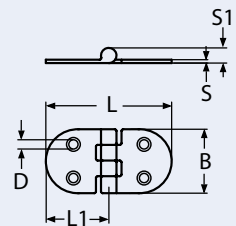

Scharnier / A2-AISI 304
Hinge / Charnière

8571

Bestell-Nr. Order no.	L	L1	B	D	S	S1	Box	*€/Stück *€/piece
85712110_38	110	38	38	5,5	2	9	5	10,00

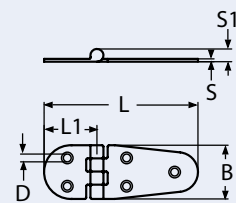

Scharnier / A2-AISI 304
Hinge / Charnière

8570

Bestell-Nr. Order no.	L	L1	B	D	S	S1	Box	*€/Stück *€/piece
85702145_38	145	72,5	38	5,5	2	9	5	9,60

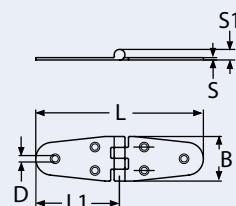

6

Scharniere, Griffe, Haken und Ringe

Hinges, handles, hooks and rings

Charnières, poignées, crochets et anneaux

8576

Scharnier / A2-AISI 304

Hinge / Charnière

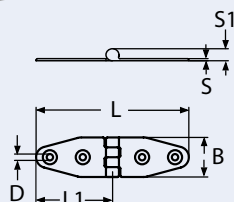

Bestell-Nr. Order no.	L	L1	B	D	S	S1	Box	*€/Stück *€/piece
85762100_28	100	50	28	5,5	2	9	5	7,20

8577

Scharnier / A2-AISI 304

Hinge / Charnière

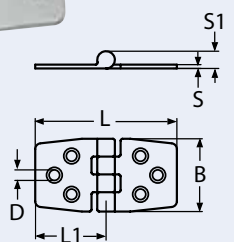

Bestell-Nr. Order no.	L	L1	B	D	S	S1	Box	*€/Stück *€/piece
8577275_38	75	37,5	38	5,5	2	9	5	7,00
8577297_38	97	48,5	38	5,5	2	9	5	7,90

8567

Scharnier / A2-AISI 304

Hinge / Charnière

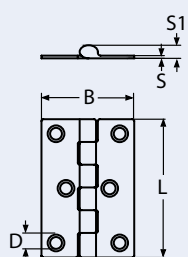

Bestell-Nr. Order no.	L	B	D	S	S1	Box	*€/Stück *€/piece
85672050_35	50	35	3,3	1,7	8	5	5,50
85672062_40	62	40	3,3	1,7	8	5	8,00
85672075_48	75	48	5,5	1,7	8	5	10,00
85672100_54	100	54	6,6	1,7	8	5	11,50

8896

Scharnier / A4-AISI 316

Hinge / Charnière triple

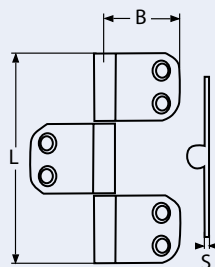

Bestell-Nr. Order no.	L	B	S	Box	*€/Stück *€/piece
8896498_37	98	37	1,5	1	22,00

Scharniere, Griffe, Haken und Ringe

Hinges, handles, hooks and rings

Charnières, poignées, crochets et anneaux

6

Anschweißscharnier / A2-AISI 304
Weld-on hinge / Charnière triple à souder

8859

Bestell-Nr. Order no.	L	B	S	Box	*€/Stück *€/piece
8859285	85	30	1,5	5	8,40

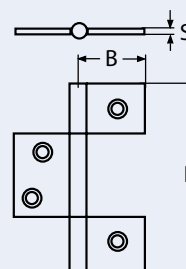

Scharnier / A4-AISI 316
T-strap hinge / Charnière en T

8858

Bestell-Nr. Order no.	L	L1	B	S	Box	*€/Stück *€/piece
88584100_54	100	60	54	4	1	12,50
88584152_75	152	110	75	4	1	16,00
88584197_98	197	140	98	4	1	22,00

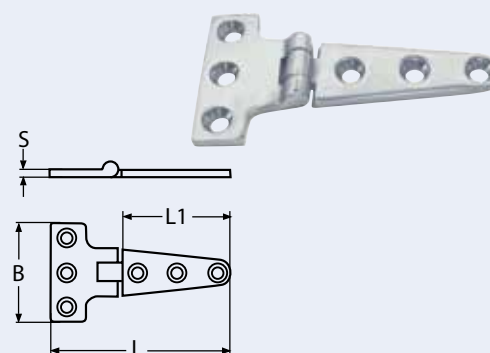

Scharnier / A4-AISI 316
Hinge / Charnière

8897

Bestell-Nr. Order no.	L	L1	B	S	Box	*€/Stück *€/piece
8897466_30	66	33	30	2	5	9,60

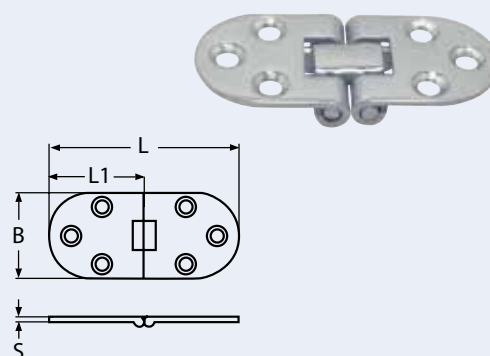

Scharnier / A2-AISI 304
Hinge / Charnière

8900

Bestell-Nr. Order no.	L	L1	B	S	D	Box	*€/Stück *€/piece
89002102_27	102	51	27	2	3,8	5	6,20

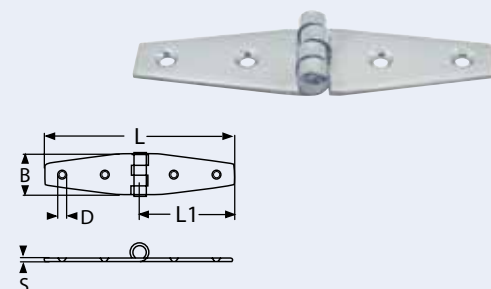

6

Scharniere, Griffe, Haken und Ringe

Hinges, handles, hooks and rings

Charnières, poignées, crochets et anneaux

8981

Scharnier / A2-AISI 304

Hinge / Charnière

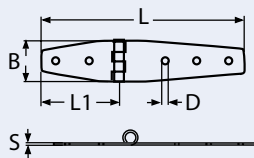

Bestell-Nr. Order no.	L	L1	B	S	D	Box	*€/Stück *€/piece
89812135_27	135	50	27	2	3,8	5	8,10

8901

Scharnier / A2-AISI 304

Hinge / Charnière

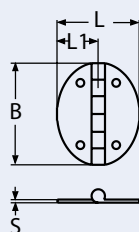

Bestell-Nr. Order no.	L	L1	B	S	Box	*€/Stück *€/piece
8901278_56	56	28	78	2	5	6,50

8902

Scharnier / A2-AISI 304

Hinge / Charnière

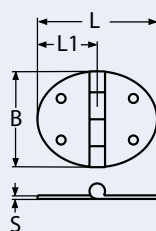

Bestell-Nr. Order no.	L	L1	B	S	Box	*€/Stück *€/piece
8902267_48	67	36,5	48	2	5	11,50

8903

Scharnier / A2-AISI 304

Hinge / Charnière

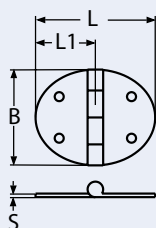

Bestell-Nr. Order no.	L	L1	B	S	Box	*€/Stück *€/piece
8903251_35	51	25,5	35	2	5	4,00

Scharniere, Griffe, Haken und Ringe

Hinges, handles, hooks and rings

Charnières, poignées, crochets et anneaux

6

Scharnier / A2-AISI 304

Hinge / Charnière

8982

Bestell-Nr. Order no.	L	L1	B	S	Box	*€/Stück *€/piece
89822180_38	180	60	38	2	5	12,00

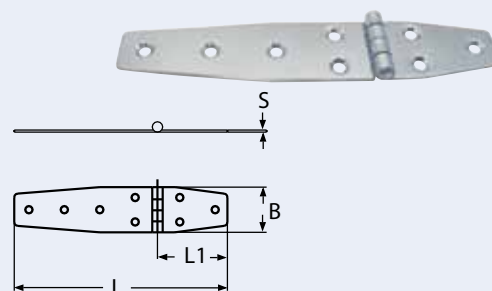

Scharnier / A2-AISI 304

Hinge / Charnière

8904

Bestell-Nr. Order no.	L	L1	B	S	Box	*€/Stück *€/piece
8904270_38	70	35	38	2	5	6,60

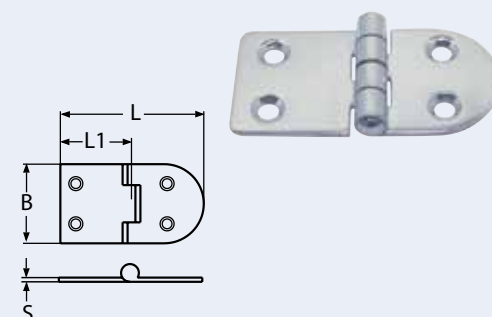

Scharnier / A2-AISI 304

Hinge / Charnière

8905

Bestell-Nr. Order no.	L	L1	B	H	S	Box	*€/Stück *€/piece
89052127_47	127	98	47	41	2,5	5	18,00

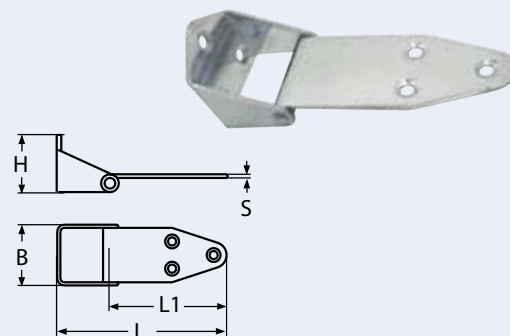

Scharnier / A2-AISI 304

Hinge / Charnière

8906

Bestell-Nr. Order no.	L	L1	B	H	S	Box	*€/Stück *€/piece
8906265_3821	65	50	15	19	2	5	8,40
8906265_3835	76	50	16	20	2	5	9,00

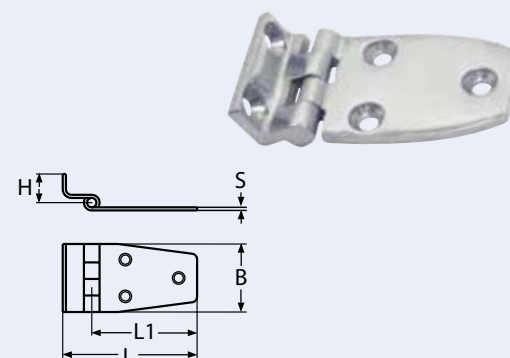

6

Scharniere, Griffe, Haken und Ringe

Hinges, handles, hooks and rings

Charnières, poignées, crochets et anneaux

8952

Scharnier / A2-AISI 304

Hinge / Charnière

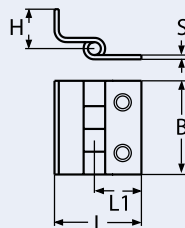

Bestell-Nr. Order no.	L	L1	B	H	S	Box	*€/Stück *€/piece
8952235_38	35	15	38	20	2	5	7,90

8910

Scharnier, Guss / A4-AISI 316

Hinge, cast / Charnière, coulée

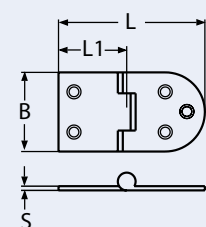

Bestell-Nr. Order no.	L	L1	B	S	Box	*€/Stück *€/piece
8910476_40	76	30	40	4	2	11,60

8911

Scharnier mit Gewinde, Guss / A4-AISI 316

Hinge with thread, cast / Charnière avec filetage, coulée

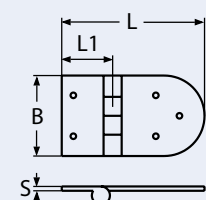

Bestell-Nr. Order no.	L	L1	B	S	Gewindelänge Length of thread	GW	Box	*€/Stück *€/piece
8911476_40	76	30	40	4	45	M6	2	18,70

8912

Scharnier, Guss / A4-AISI 316

Hinge, cast / Charnière, coulée

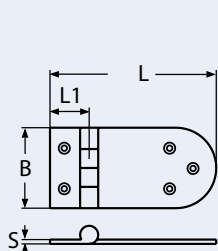

Bestell-Nr. Order no.	L	L1	B	S	Box	*€/Stück *€/piece
89124134_65	134	21	65	4	2	19,80

Scharniere, Griffe, Haken und Ringe

Hinges, handles, hooks and rings
Charnières, poignées, crochets et anneaux

6

Scharnier mit Gewinde, Guss / A4-AISI 316

Hinge with thread, cast / Charnière avec filetage, coulée

8913

Bestell-Nr. Order no.	L	L1	B	S	Gewindelänge Length of thread	GW	Box	*€/Stück *€/piece
89134134_65	134	21	65	4	45	M6	2	26,90

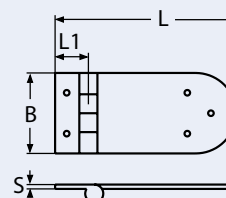

Scharnier, Guss / A4-AISI 316

Hinge, cast / Charnière, coulée

8914

Bestell-Nr. Order no.	L	L1	B	S	Box	*€/Stück *€/piece
89144146_65	146	51	65	4	2	19,90

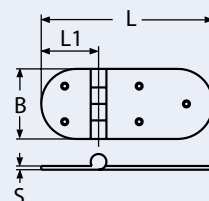

Scharnier mit Gewinde, Guss / A4-AISI 316

Hinge with thread, cast / Charnière avec filetage, coulée

8915

Bestell-Nr. Order no.	L	L1	B	S	Gewindelänge Length of thread	GW	Box	*€/Stück *€/piece
89154146_65	146	51	65	4	45	M6	2	27,00

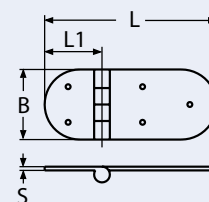

Scharnier, Guss / A4-AISI 316

Hinge, cast / Charnière, coulée

814125

Bestell-Nr. Order no.	L	L1	B	S	Box	*€/Stück *€/piece
8141254190_95	190	95	65	4	2	31,00

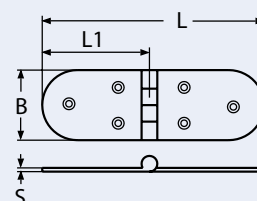

6

Scharniere, Griffe, Haken und Ringe

Hinges, handles, hooks and rings

Charnières, poignées, crochets et anneaux

8917

Scharnier mit Gewinde, Guss / A4-AISI 316

Hinge with thread, cast / Charnière avec filetage, coulée

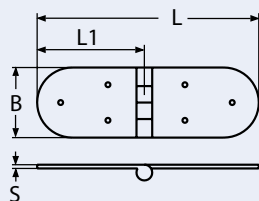

Bestell-Nr. Order no.	L	L1	B	S	Gewindelänge Length of thread	GW	Box	*€/Stück *€/piece
89174190_65	190	95	65	4	45	M6	2	46,00

8918

Scharnier, Guss / A4-AISI 316

Hinge, cast / Charnière, coulée

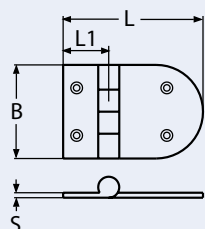

Bestell-Nr. Order no.	L	L1	B	S	Box	*€/Stück *€/piece
8918483_65	83	32	65	4	2	13,50

8919

Scharnier mit Gewinde, Guss / A4-AISI 316

Hinge with thread, cast / Charnière avec filetage, coulée

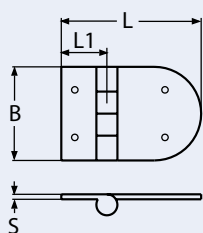

Bestell-Nr. Order no.	L	L1	B	S	Gewindelänge Length of thread	GW	Box	*€/Stück *€/piece
8919483_65	83	32	65	4	45	M6	2	21,50

8920

Scharnier, Guss / A4-AISI 316

Hinge, cast / Charnière, coulée

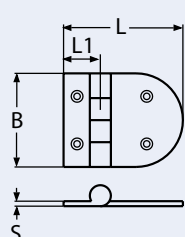

Bestell-Nr. Order no.	L	L1	B	S	Box	*€/Stück *€/piece
8920472_65	72	21	65	4	2	12,70

Scharniere, Griffe, Haken und Ringe

Hinges, handles, hooks and rings

Charnières, poignées, crochets et anneaux

6

Scharnier mit Gewinde, Guss / A4-AISI 316

Hinge with thread, cast / Charnière avec filetage, coulée

8921

Bestell-Nr. Order no.	L	L1	B	S	Gewindelänge Length of thread	GW	Box	*€/Stück *€/piece
8921472_65	72	21	65	4	45	M6	2	18,70

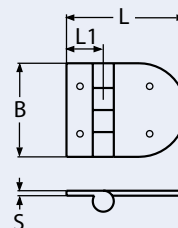

Scharnier, Guss / A4-AISI 316

Hinge, cast / Charnière, coulée

8922

Bestell-Nr. Order no.	L	L1	B	S	Box	*€/Stück *€/piece
89224103_65	103	21	65	4	2	17,50

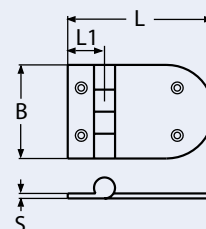

Scharnier mit Gewinde, Guss / A4-AISI 316

Hinge with thread, cast / Charnière avec filetage, coulée

8923

Bestell-Nr. Order no.	L	L1	B	S	Gewindelänge Length of thread	GW	Box	*€/Stück *€/piece
89234103_65	103	21	65	4	45	M6	2	22,60

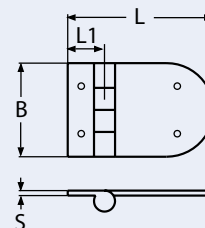

Scharnier, Guss / A4-AISI 316

Hinge, cast / Charnière, coulée

8924

Bestell-Nr. Order no.	L	L1	B	S	Box	*€/Stück *€/piece
8924452_61	52	19	61	4	2	11,60

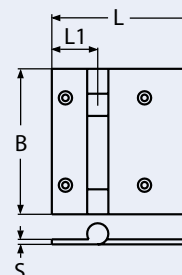

6

Scharniere, Griffe, Haken und Ringe

Hinges, handles, hooks and rings

Charnières, poignées, crochets et anneaux

8925

Scharnier mit Gewinde, Guss / A4-AISI 316

Hinge with thread, cast / Charnière avec filetage, coulée

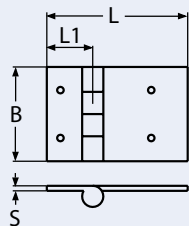

Bestell-Nr. Order no.	L	L1	B	S	Gewindelänge Length of thread	GW	Box	*€/Stück *€/piece
8925452_61	52	19	61	4	45	M6	2	20,40

8926

Scharnier, Guss / A4-AISI 316

Hinge, cast / Charnière, coulée

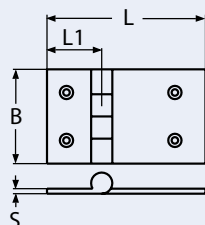

Bestell-Nr. Order no.	L	L1	B	S	Box	*€/Stück *€/piece
8926480_65	80	33	65	4	2	14,70

8927

Scharnier mit Gewinde, Guss / A4-AISI 316

Hinge with thread, cast / Charnière avec filetage, coulée

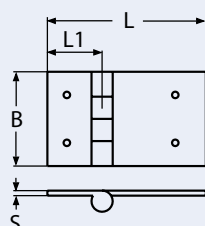

Bestell-Nr. Order no.	L	L1	B	S	Gewindelänge Length of thread	GW	Box	*€/Stück *€/piece
8927480_65	80	33	65	4	45	M6	2	26,50

8928

Scharnier, Guss / A4-AISI 316

Hinge, cast / Charnière, coulée

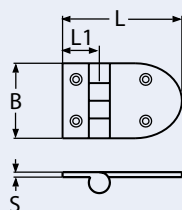

Bestell-Nr. Order no.	L	L1	B	S	Box	*€/Stück *€/piece
8928470_40	70	30	40	3,5	2	10,00

Scharniere, Griffe, Haken und Ringe

Hinges, handles, hooks and rings
Charnières, poignées, crochets et anneaux

6

Scharnier mit Gewinde, Guss / A4-AISI 316

Hinge with thread, cast / Charnière avec filetage, coulée

8929

Bestell-Nr. Order no.	L	L1	B	S	Gewindelänge Length of thread	GW	Box	*€/Stück *€/piece
8929470_40	70	30	40	3,5	45	M6	2	16,20

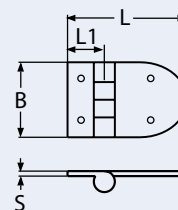

Scharnier, Guss / A4-AISI 316

Hinge, cast / Charnière, coulée

8930

Bestell-Nr. Order no.	L	L1	B	S	Box	*€/Stück *€/piece
89304126_40	126	40	40	3,5	2	12,20

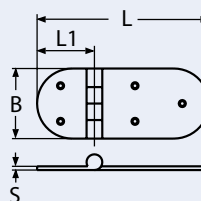

Scharnier mit Gewinde, Guss / A4-AISI 316

Hinge with thread, cast / Charnière avec filetage, coulée

8931

Bestell-Nr. Order no.	L	L1	B	S	Gewindelänge Length of thread	GW	Box	*€/Stück *€/piece
89314126_40	126	40	40	3,5	45	M6	2	29,00

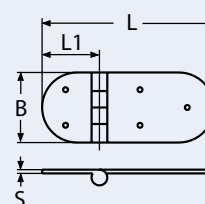

Scharnier, Guss / A4-AISI 316

Hinge, cast / Charnière, coulée

8932

Bestell-Nr. Order no.	L	L1	B	S	Box	*€/Stück *€/piece
89324127_65	127	32	65	4	2	17,60

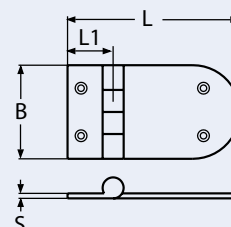

6

Scharniere, Griffe, Haken und Ringe

Hinges, handles, hooks and rings

Charnières, poignées, crochets et anneaux

8933

Scharnier mit Gewinde, Guss / A4-AISI 316

Hinge with thread, cast / Charnière avec filetage, coulée

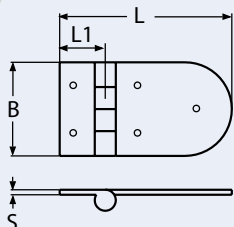

Bestell-Nr. Order no.	L	L1	B	S	Gewindelänge Length of thread	GW	Box	*€/Stück *€/piece
89334127_65	127	32	65	4	45	M6	2	24,00

8670

Scharnier / A4-AISI 316

Hinge / Charnière

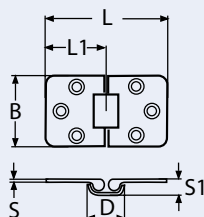

Bestell-Nr. Order no.	L	L1	B	D	S	S1	Box	*€/Stück *€/piece
86704070_42	70	35	42	6	2	7,5	5	15,00

8671

Scharnier / A4-AISI 316

Hinge / Charnière

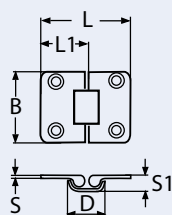

Bestell-Nr. Order no.	L	L1	B	D	S	S1	Box	*€/Stück *€/piece
86714052_42	52	26	42	6	2,2	7,5	5	18,80

8678

Scharnier mit Abdeckung / A4-AISI 316

Covered hinge / Charnière avec cache de vis

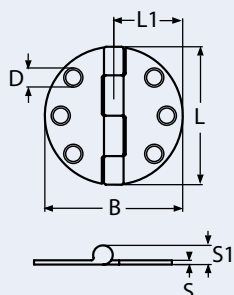

Bestell-Nr. Order no.	L	L1	B	D	S	S1	Box	*€/Stück *€/piece
86784065_65	65	32,5	65	7,5	2	9	5	22,00

Scharniere, Griffe, Haken und Ringe

Hinges, handles, hooks and rings
Charnières, poignées, crochets et anneaux

6

Scharnier mit Abdeckung / A4-AISI 316

Covered hinge / Charnière avec cache de vis

8676

Bestell-Nr. Order no.	L	L1	B	D	S	S1	Box	*€/Stück *€/piece
86764074_40	74	37	40	5,5	2	9	5	13,50

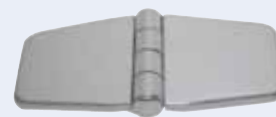
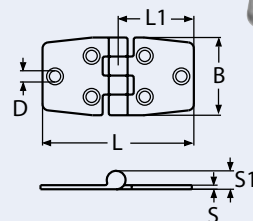

Scharnier mit Abdeckung / A4-AISI 316

Covered hinge / Charnière avec cache de vis

8677

Bestell-Nr. Order no.	L	L1	B	D	S	S1	Box	*€/Stück *€/piece
86774075_74	74	37	75	7,5	2	9	5	22,50

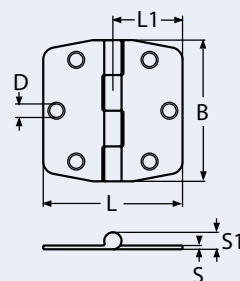

Scharnier mit Abdeckung / A4-AISI 316

Covered hinge / Charnière avec cache de vis

8675

Bestell-Nr. Order no.	L	L1	B	D	S	S1	Box	*€/Stück *€/piece
86754057_37	57	18	37	6	2	9	5	13,00

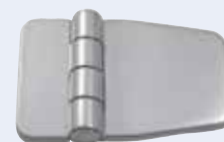
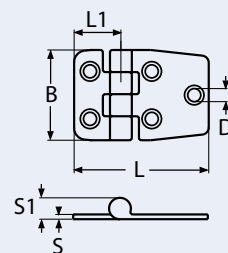

Scharnier mit Abdeckung / A4-AISI 316

Covered hinge / Charnière avec cache de vis

8674

Bestell-Nr. Order no.	L	L1	B	D	S	S1	Box	*€/Stück *€/piece
86744036_36	36	18	36	6	2	9	5	12,50

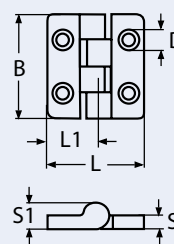



Scharniere, Griffe, Haken und Ringe

Hinges, handles, hooks and rings

Charnières, poignées, crochets et anneaux

6

Stangenscharnier / A2-AISI 304

Continuous hinge / Charnière à piano

8321

Bestell-Nr. Order no.	B	S	L	*€/Meter *€/metre
8321207_16	16	0,7	3500	16,00
8321207_18	18	0,7	3500	17,00
8321207_20	20	0,7	3500	17,50
8321207_25	25	0,7	3500	18,00
8321207_32	32	0,7	3500	19,00
8321207_40	40	0,7	3500	20,00
8321215_32	32	1,5	2000	29,00
8321215_40	40	1,5	2000	32,00

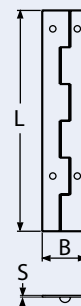

Überfallscharnier / A2-AISI 304

Swivel hasp / Fermeture à cadenas

8428

Bestell-Nr. Order no.	L	B	Box	*€/Stück *€/piece
8428271_24	67	24	5	12,00

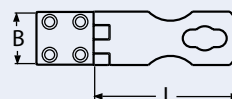

Überfallscharnier mit Schloss / A2-AISI 304

Swivel hasp with lock / Fermeture avec serrure

8588

Bestell-Nr. Order no.	A	B	C	L	L1	Box	*€/Stück *€/piece
8588230	30	42	30	98	78	1	15,00

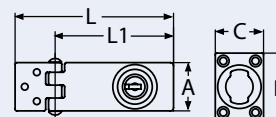
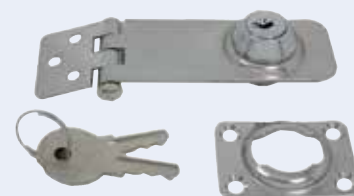

Überfallscharnier / A4-AISI 316

Swivel hasp / Fermeture

8854

Bestell-Nr. Order no.	L	B	Box	*€/Stück *€/piece
8854480_28	80	28	1	25,00

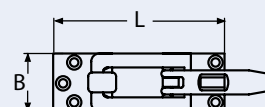

6

Scharniere, Griffe, Haken und Ringe

Hinges, handles, hooks and rings

Charnières, poignées, crochets et anneaux

8519

Überfallscharnier / A4-AISI 316

Swivel hasp / Grenouillère fixation equerre inox

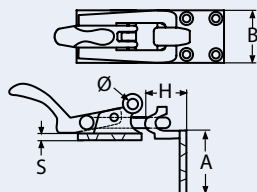

Bestell-Nr. Order no.	A	B	H	S	Ø	Box	*€/Stück *€/piece
8519437_37	37	37	20	4	6,3	1	32,00

8518

Überfallscharnier / A4-AISI 316

Swivel hasp / Poignée avec serrure

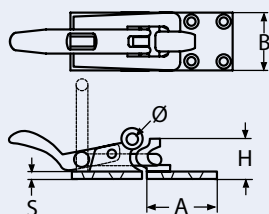

Bestell-Nr. Order no.	A	B	S	H	Ø	Box	*€/Stück *€/piece
8518437_37	37	37	4	20	6,3	1	29,50

8717

Überfallscharnier / A4-AISI 316

Swivel hasp / Fermeture à sauterelle

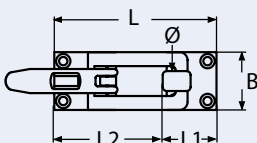

Bestell-Nr. Order no.	L	L1	L2	B	Ø	Box	*€/Stück *€/piece
8717480_28	75	25	50	28	6,3	1	25,00

814666

Überfallscharnier / A4-AISI 316

Swivel hasp / Fermeture à sauterelle / Grenouillère

NEW

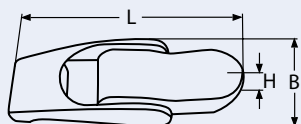

Bestell-Nr. Order no.	L	B	H	Box	*€/Stück *€/piece
8146664105	82	25	14	1	35,00

Scharniere, Griffe, Haken und Ringe

Hinges, handles, hooks and rings
Charnières, poignées, crochets et anneaux

6

NEW

Überfallscharnier mit Schloss / A4-AISI 316
Swivel hasp with lock / Grenouillère avec fermeture à clé

814667

Bestell-Nr. Order no.	L	B	H	Box	*€/Stück *€/piece
8146674105	82	25	14	1	45,00

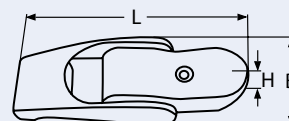

Einlassgriff mit Schloss / A4-AISI 316
Lifting ring with lock / Fermeture de panneau

8818

Bestell-Nr. Order no.	Form Shape	D	A	L	Box	*€/Stück *€/piece
8818463_63RUND	Rund Round	63	73	60	1	59,00
8818463_63RECHTECKIG	Rechteckig Rectangular	63	73	60	1	62,00

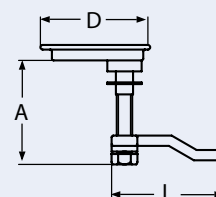

6

Einlassgriff, wettergeschützt / A4-AISI 316
Weatherproof lifting ring / Poignée étanche

8834

Bestell-Nr. Order no.	A	B	C	D	Box	*€/Stück *€/piece
8834460	60	41	50	33	1	52,80

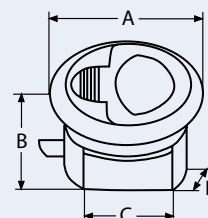

6

Scharniere, Griffe, Haken und Ringe

Hinges, handles, hooks and rings

Charnières, poignées, crochets et anneaux

8648

Einlassgriff / A4-AISI 316

Lifting ring / Poignée

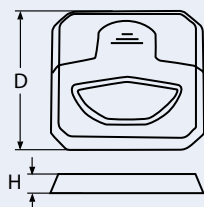
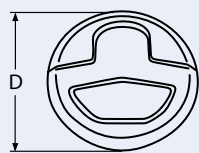

Bestell-Nr. Order no.	Form Shape	D	H	Box	*€/Stück *€/piece
8648450RUND	Rund / Round	50	19	1	27,00
8648450ECKIG	Eckig / Square	50	19	1	27,00

814060

Einlassgriff mit Schloss / A4-AISI 316

Lifting ring with lock / Poignée avec serrure

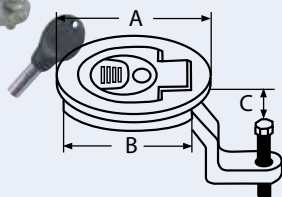

Bestell-Nr. Order no.	A	B	C	Box	*€/Stück *€/piece
814060461	61	50	33	1	45,00

814726

Einlassgriff / A4-AISI 316

Lifting ring / Poignée encastrable

NEW

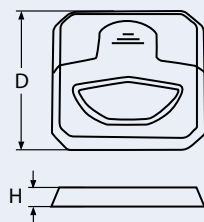
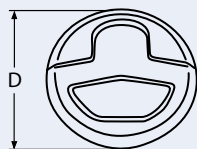

Bestell-Nr. Order no.	Form Shape	D	H	Box	*€/Stück *€/piece
814726451RUND	Rund / Round	51	12	1	27,00
814726451ECKIG	Eckig / Square	51	12	1	27,00

Scharniere, Griffe, Haken und Ringe

Hinges, handles, hooks and rings
Charnières, poignées, crochets et anneaux

6

NEW

Einlassgriff, wettergeschützt / A4-AISI 316
Weatherproof lifting ring / Poignée étanche

814731

Bestell-Nr. Order no.	Form	Model	A	B	C	D	E	F	Box	*€/Stück *€/piece
814731450R	Rund Round	Ohne Schloss Without lock	8	22-76	62	50	71	54	1	72,00
814731450RS	Rund Round	Mit Schloss With lock	8	22-76	62	50	71	54	1	79,00
814731450E	Eckig Angular	Ohne Schloss Without lock	8	22-76	62	50	71	54	1	75,00
814731450ES	Eckig Angular	Mit Schloss With lock	8	22-76	62	50	71	54	1	83,00

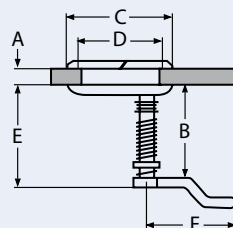

Kabinenhaken / A4-AISI 316
Cabin hook / Crochet de cabine

8650

Bestell-Nr. Order no.	L	B	D	Box	*€/Stück *€/piece
8650450	50	33	4,4	5	11,70
8650470	70	33	4,4	5	12,50
8650490	90	33	4,4	5	13,00

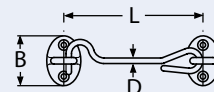

Kabinenhaken / A4-AISI 316
Cabin hook / Crochet de cabine

8384

Bestell-Nr. Order no.	L	B	Box	*€/Stück *€/piece
83844100	100	37,5	1	12,00

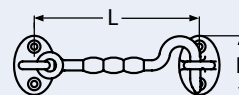

Türriegel, federgelagert / A4-AISI 316
Spring loaded door latch / Verrou à ressort

8892

Bestell-Nr. Order no.	A	B	D	Box	*€/Stück *€/piece
8892472	72	27	30	1	49,00

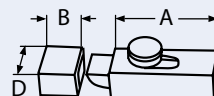



Scharniere, Griffe, Haken und Ringe

Hinges, handles, hooks and rings
Charnières, poignées, crochets et anneaux

6

Schiebeschloss, federgelagert / A4-AISI 316

Spring loaded slide latch / Verrou à ressort de glissière

814064

Bestell-Nr. Order no.	A	B	C	D	E	Box	*€/Stück *€/piece
814064491	91	56	9	16	54	1	46,00

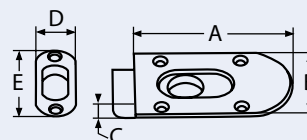

NEW

Vorreiber / A4-AISI 316

Closure / Fermeture

814650

Bestell-Nr. Order no.	Ø	Box	*€/Stück *€/piece
814650445	45	1	8,00

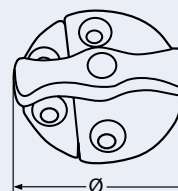

NEW

Magnet-Schieberiegel / A4-AISI 316

Magnet slide latch / Loquet magnétique

814691

Bestell-Nr. Order no.	Montage Mounting	A	B	C	D	E	Box	*€/Stück *€/piece
8146914SURF	Aufbau Surface	91	56	9	15	70	1	80,00
8146914INST	Einbau Installation	91	56	9	21	70	1	74,00



Aufbau / Surface

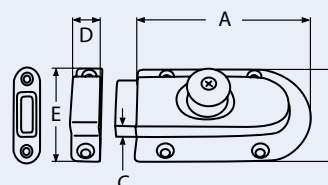

Einbau / Installation

Verschlusscharnier / A4-AISI 316

Locking hinge / Fermeture targette

8413

Bestell-Nr. Order no.	A	B	C	D	Materialstärke Material thickness	Box	*€/Stück *€/piece
8413415_45	45	30	15	9,5	2,3	1	11,70
8413436_76	76	38	36	9,5	4,0	1	13,50

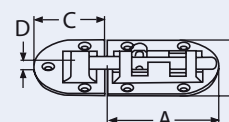

6

6

Scharniere, Griffe, Haken und Ringe

Hinges, handles, hooks and rings

Charnières, poignées, crochets et anneaux

8862

Spannverschluss, abschließbar / A2-AISI 304

Tensor latch, lockable / Fermeture a levier

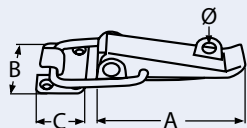

Bestell-Nr. Order no.	A	B	C	Ø	Box	*€/Stück *€/piece
8862270	72	35	24	6,5	1	10,30

8427

Hebelverschluss / A2-AISI 304

Snag / Attache exentrique

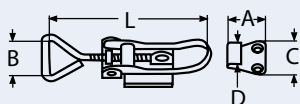

Bestell-Nr. Order no.	L	B	A	C	D	Box	*€/Stück *€/piece
84272065_75	65 - 75	18	20	26	14	1	9,50
84272085_95	75 - 90	18	20	26	15	1	10,50
84272115_125	115 - 125	25	29	30	18	1	15,00
84272165_185	165 - 185	35	30	30	18	1	20,60

8318

Sturmhaken mit Ösen / A2-AISI 304

Gate hook with eyes / Crochet de porte



Bestell-Nr. Order no.	Länge Length	Draht-Ø Wire-Ø	Box	*€/Stück *€/piece
83182080	80	3,9	5	3,00
83182120	120	4,4	5	4,25

8241

Einlassgriff / A4-AISI 316

Small flush lifting ring / Poignée

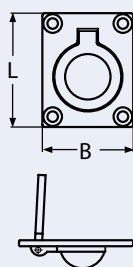

Bestell-Nr. Order no.	L	B	Box	*€/Stück *€/piece
8241447_38	47	38	1	7,50

Scharniere, Griffe, Haken und Ringe

Hinges, handles, hooks and rings
Charnières, poignées, crochets et anneaux

6

Einlassgriff / A4-AISI 316

Lifting ring / Poignée

8242

Bestell-Nr. Order no.	L	B	Box	*€/Stück *€/piece
8242463_44	63	44	1	9,00

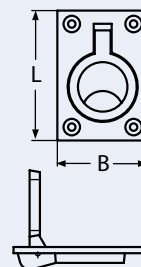

Einlassgriff / A4-AISI 316

Lifting ring / Poignée

8243

Bestell-Nr. Order no.	L	B	Box	*€/Stück *€/piece
8243475_56	75	56	1	10,70

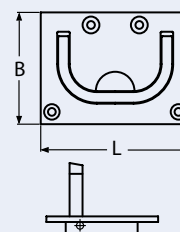

Einlassgriff mit Schloss / A2-AISI 304

Lifting ring with lock / Poignée avec serrure

8589

Bestell-Nr. Order no.	A	B	L	L1	L2	Box	*€/Stück *€/piece
8589250	50	55	32	30	65	1	19,80

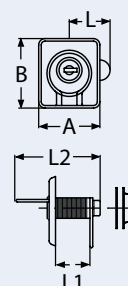

Einlassgriff / A2-AISI 304

Lifting ring / Poignée

8527

Bestell-Nr. Order no.	L	B	S	S1	Box	*€/Stück *€/piece
8527290	90	25	3	33	1	11,30

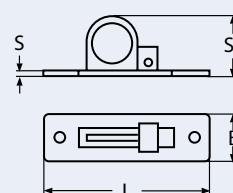

6

6

Scharniere, Griffe, Haken und Ringe

Hinges, handles, hooks and rings

Charnières, poignées, crochets et anneaux

8348

Haken, poliert / A2-AISI 304

Hook, polished / Crochet poli

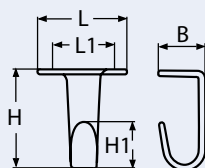

Bestell-Nr. Order no.	B	L	L1	H	H1	Box	*€/Stück *€/piece
83482325	17	32,5	20	32,5	14	10	3,10
83482430	22	43	30	47,5	21	10	5,90

8347

Haken, poliert / A2-AISI 304

Hook, polished / Crochet poli

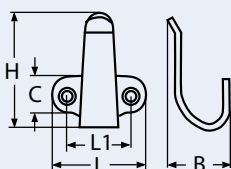

Bestell-Nr. Order no.	L	L1	B	C	H	Box	*€/Stück *€/piece
8347235	35	21,5	23	16	44	10	3,80
8347243	43	30,0	25	18	56	10	4,80

8361

Haken, poliert / A2-AISI 304

Hook, polished / Crochet poli

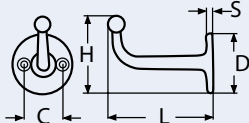

Bestell-Nr. Order no.	L	H	D	S	C	Box	*€/Stück *€/piece
8361247	47	37	28	3	18,5	10	6,50
8361265	65	44	35	4	22,5	10	7,00

8399

Kleiderhaken, poliert / A2-AISI 304

Coat hook, polished / Crochet porte vêtement poli

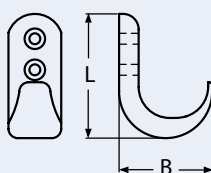

Bestell-Nr. Order no.	B	L	Box	*€/Stück *€/piece
8399240_30	30	40	10	4,50

Scharniere, Griffe, Haken und Ringe

Hinges, handles, hooks and rings
Charnières, poignées, crochets et anneaux

6

Kleiderhaken, poliert / A2-AISI 304
Coat hook, polished / Crochet porte vêtement poli

8400

Bestell-Nr. Order no.	B	L	Box	*€/Stück *€/piece
8400230_25	30	40	10	4,50

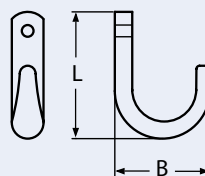

Kleiderhaken, poliert / A2-AISI 304
Coat hook, polished / Crochet porte vêtement poli

8401

Bestell-Nr. Order no.	B	L	Box	*€/Stück *€/piece
8401235_33	33	35	10	9,10

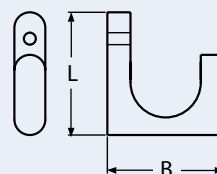

Kleiderhaken / A2-AISI 304
Coat hook / Crochet porte-vêtements

814081

Bestell-Nr. Order no.	A	B	L	Box	*€/Stück *€/piece
814081210	10	60	35	10	4,00

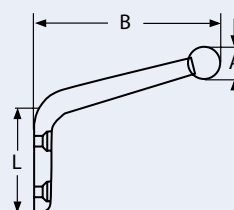

NEW

Kleiderhaken / A4-AISI 316
Coat hook / Crochet simple

814659

Bestell-Nr. Order no.	L	B	T	D	H	Box	*€/Stück *€/piece
814659440	40	13	5,9	16,5	17	10	3,00

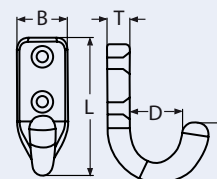

6

Scharniere, Griffe, Haken und Ringe

Hinges, handles, hooks and rings

Charnières, poignées, crochets et anneaux

814660

Kleiderhaken / A4-AISI 316

Coat hook / Crochet simple

NEW

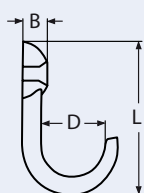

Bestell-Nr. Order no.	L	B	D	Box	*€/Stück *€/piece
814660440	40	5,9	22	10	2,90

814664

Kleiderhaken klappbar / A4-AISI 316

Coat hook foldable / Crochet triple

NEW

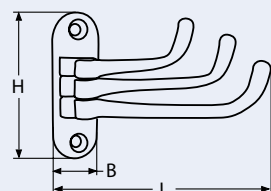
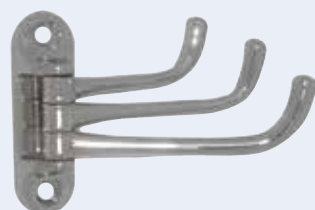

Bestell-Nr. Order no.	L	B	H	Box	*€/Stück *€/piece
814664475	106	25	75	1	40,00

814665

Wirbel Kleiderhaken / A4-AISI 316

Swivel coat hook / Crochet triple

NEW

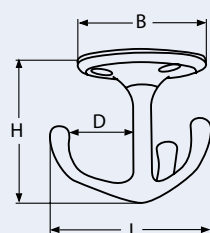

Bestell-Nr. Order no.	L	B	H	D	Box	*€/Stück *€/piece
814665457	66	50	57	21	1	30,00

814082

Kleiderhaken / A2-AISI 304

Coat hook / Crochet porte-vêtements

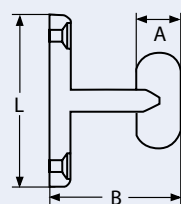

Bestell-Nr. Order no.	A	L	B	Box	*€/Stück *€/piece
814082212	12	48	36	10	5,00

Scharniere, Griffe, Haken und Ringe

Hinges, handles, hooks and rings
Charnières, poignées, crochets et anneaux

6

Kleiderhaken / A2-AISI 304
Coat hook / Crochet porte-vêtements

814083

Bestell-Nr. Order no.	A	B	Box	*€/Stück *€/piece
814083206	6	30	10	4,50

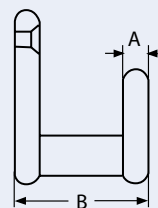

Plünnenhalter „klappweg“ / A2-AISI 304
Movable hook / Crochet mobile

8476

Bestell-Nr. Order no.	L	B	C	Box	*€/Stück *€/piece
8476255_38	55	43	20	5	26,90

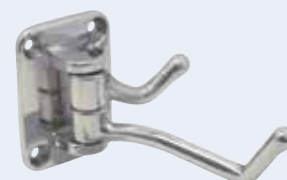
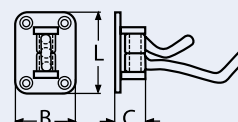

Kleiderhaken, klappbar / A4-AISI 316
Coat hook, foldable / Crochet porte vêtement pliant

8830

Bestell-Nr. Order no.	A	B	C	D	Box	*€/Stück *€/piece
8830450	50	50	28	10	5	14,30

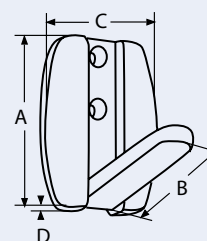

Kleiderhaken / A2-AISI 304
Coat hook / Crochet porte-vêtements

814079

Bestell-Nr. Order no.	A	B	C	D	Box	*€/Stück *€/piece
814079240	40	17	8	20	10	5,70

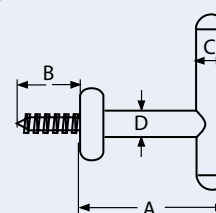

6

Scharniere, Griffe, Haken und Ringe

Hinges, handles, hooks and rings

Charnières, poignées, crochets et anneaux

814080

Kleiderhaken / A2-AISI 304

Coat hook / Crochet porte-vêtements

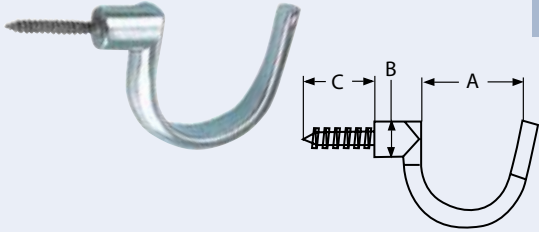

Bestell-Nr. Order no.	A	B	C	Box	*€/Stück *€/piece
814080226	26	9	18	10	3,20

8398

S-Haken, asymmetrisch / A2-AISI 304

S-hook, asymmetric / Crochet en S Asymétrique

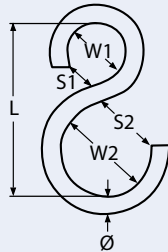

Bestell-Nr. Order no.	Ø	L	W1	W2	S1	S2	Box	*€/Stück *€/piece
839823	3	30	9	16	5	10	20	0,50
839824	4	36	12	19	6	12	20	0,70
839825	5	43	14	21	6	12	20	0,80
839826	6	50	15	25	7	15	10	0,90
839828	8	67	20	33	9	20	10	1,80

814070

S-Haken, symmetrisch / A2-AISI 304

S-hook, symmetric / Crochet en S symétrique

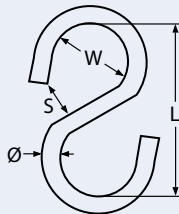

Bestell-Nr. Order no.	Ø	L	W	S	Box	*€/Stück *€/piece
814070203	3	24	9	4	20	0,25
814070204	4	32	12	6	20	0,40
814070205	5	40	15	8	20	0,60
814070206	6	48	17	9	10	0,90
814070208	8	64	24	12	10	2,10
814070210	10	80	30	13	5	4,00

8968

S-Haken mit Sicherung / A4-AISI 316

S-hook with gate / Crochet en S avec mécanisme de sécurité

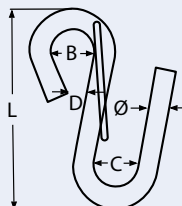

Bestell-Nr. Order no.	Ø	L	B	C	D	Box	*€/Stück *€/piece
89684095	9,5	90	17,0	19,5	6,9	5	5,80
89684110	11,0	100	16,5	22,0	7,0	5	6,60
89684130	13,0	112	17,0	22,0	8,0	5	9,40

Scharniere, Griffe, Haken und Ringe

Hinges, handles, hooks and rings

Charnières, poignées, crochets et anneaux

6

S-Haken / A4-AISI 316

S-hook / Crochet - S

8966

Bestell-Nr. Order no.	Ø	L	B	C	D	Box	*€/Stück *€/piece
8966405	5	52	9	9	2	10	1,10
8966406	6	64	10	10	5	10	1,60
8966408	8	75	16	17	5	10	3,00
8966410	10	95	20	20	8	5	5,60

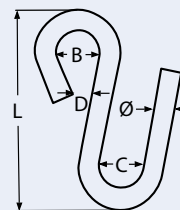

Schraubhaken, gebogen / A4-AISI 316

Plain cup hook / Crochet

8317

Bestell-Nr. Order no.	Ø	L	W	Box	*€/Stück *€/piece
8317429_40	2,9	40	12	100	0,60
8317433_50	3,3	50	16	100	0,70
8317433_60	3,3	60	16	100	0,90
8317444_50	4,4	50	16	50	1,10
8317448_65	4,8	65	22	50	1,60
8317452_80	5,2	80	26	20	2,10
8317458_100	5,8	100	26	20	3,30

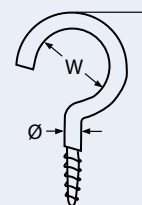

Verdecktauge / A4-AISI 316

Awning hook / Crochet de auvent

8539

Bestell-Nr. Order no.	D	D1	A	B	L	L1	Box	*€/Stück *€/piece
8539410	10	4,5	30	35	20	22	10	2,10

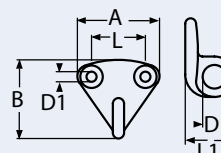

Fenderhaken / A4-AISI 316

Fender hook / Crochet

8291

Bestell-Nr. Order no.	A	H	L	B	Box	*€/Stück *€/piece
8291405	8	24	36	34	5	5,00
8291410	10	34	42	34	5	5,50

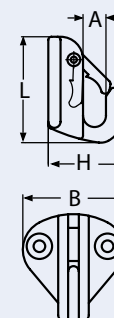

6

Scharniere, Griffe, Haken und Ringe

Hinges, handles, hooks and rings

Charnières, poignées, crochets et anneaux

NEW

814661

Fenderhaken / A4-AISI 316

Fender hook / Crochet simple

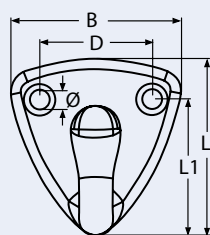

Bestell-Nr. Order no.	L	B	L1	D	Ø	Box	*€/Stück *€/piece
8146614258	25,8	24,4	20	16,5	2,8	10	2,20

8340

Winkel, poliert / A2-AISI 304

Bracket, polished / Equerre poli

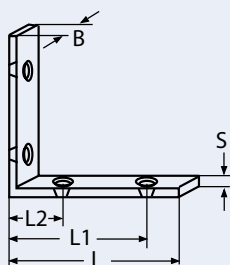

Bestell-Nr. Order no.	L	L1	L2	B	S	Box	*€/Stück *€/piece
8340231_12	31	25	12	12	3	10	3,90
8340246_13	46	38	18	13	3	10	4,70
8340261_15	61	51	21	15	3	10	5,00

8341

Winkel, poliert / A2-AISI 304

Bracket, polished / Equerre poli

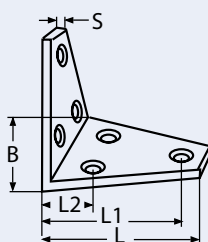

Bestell-Nr. Order no.	L	L1	L2	B	S	Box	*€/Stück *€/piece
8341241_25	41	35,0	18,0	25	3	10	5,10
8341256_35	56	47,5	18,5	35	3	10	7,50
8341280_50	80	71,0	24,0	50	3	10	12,20

814085

Winkel / A2-AISI 304

Bracket / Equerre

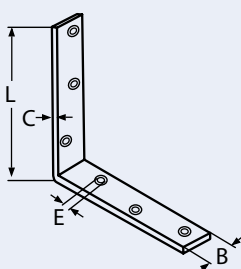

Bestell-Nr. Order no.	L	B	C	E	Box	*€/Stück *€/piece
8140852150	150	30	5	5	2	16,50
8140852200	200	30	5	5	2	20,00
8140852250	250	30	5	5	2	23,00
8140852300	300	30	5	5	2	25,00

Scharniere, Griffe, Haken und Ringe

Hinges, handles, hooks and rings

Charnières, poignées, crochets et anneaux

6

Spiralhaken / A2-AISI 304

Shock cord hook / Crochet de corde

8523

Bestell-Nr. Order no.	Für Seile-Ø For rope-Ø	Box	*€/Stück *€/piece
8523206	6	20	1,50
8523208	8	20	1,70
8523210	10	20	2,10



Haken mit Gewinde / A4-AISI 316

Hook with thread / Crochet à vis

814089

Bestell-Nr. Order no.	GW	A	B	L	D	Box	*€/Stück *€/piece
814089408	5/16"	36	16	89	41	10	3,70

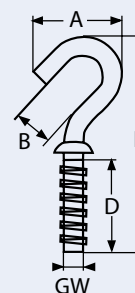

Wasserskihaken / A4-AISI 316

Transom mount ski tow / Crochet pour ski-nautique

8559

Bestell-Nr. Order no.	L	L1	GW	Ø	D	Box	*€/Stück *€/piece
85594100_60	100	50	M10	9	60	1	33,90
85594125_90	125	65	M12	12	90	1	48,50

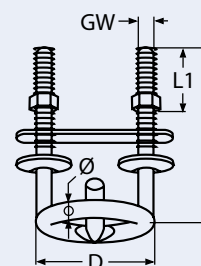

Wasserskihaken / A4-AISI 316

Ski tow ring / Chrochet pour ski-nautique

8891

Bestell-Nr. Order no.	L	B	C	GW	Box	*€/Stück *€/piece
8891492_62	92	62	50	M8	1	59,00

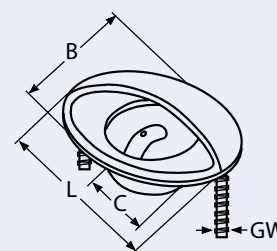

6

Scharniere, Griffe, Haken und Ringe

Hinges, handles, hooks and rings

Charnières, poignées, crochets et anneaux

8592

Türhalter / A2-AISI 304

Door holder / Bloqueur de porte

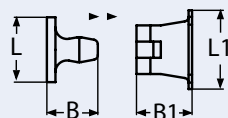
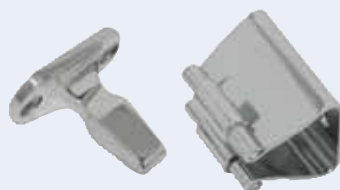

Bestell-Nr. Order no.	L	L1	B	B1	Box	*€/Stück *€/piece
8592229	29	34,0	22	25	5	14,00
8592242	42	41,0	40	31	5	16,50
8592241	41	40,5	70	31	5	19,60

8521

Kugelschnapper / A4-AISI 316

Ball catch / Bloqueur de porte à bille

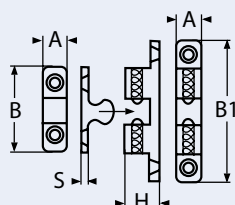

Bestell-Nr. Order no.	A	B	B1	S	H	Box	*€/Stück *€/piece
852149_50	9	29	50	2	12	5	12,30

8825

Magnet-Türhalter schwenkbar, mit Einbauplatte / A4-AISI 316

Magnet door holder, swiveling, with flush mount plate / Bloqueur de porte aimanté

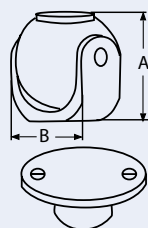

Bestell-Nr. Order no.	A	B	Box	*€/Stück *€/piece
8825434_34	34	34	1	65,00

814599

Magnet-Türhalter, schwenkbar, mit Aufbauplatte / A4-AISI 316

Magnet door holder, swiveling, with surface mount plate / Bloqueur de porte magnétique

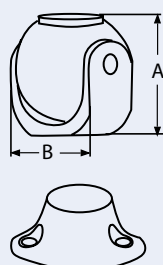

Bestell-Nr. Order no.	A	B	Box	*€/Stück *€/piece
814599434_34	34	34	1	85,00

Scharniere, Griffe, Haken und Ringe

Hinges, handles, hooks and rings
Charnières, poignées, crochets et anneaux

6

Magnet-Türhalter, schwenk- und höhenverstellbar, mit Eibauplatte / A4-AISI 316

Magnet door holder, swiveling and adjustable in height, with flush mount plate / *

8826

Bestell-Nr. Order no.	L	B	C	Box	*€/Stück *€/piece
8826451	90-115	51	25	1	100,00

*Bloqueur de porte aimanté et réglable



Magnet-Türhalter, schwenk- und höhenverstellbar mit Aufbauplatte / A4-AISI 316

Magnet door holder, swiveling and adjustable in height, with surface mount plate / *

814598

Bestell-Nr. Order no.	L	B	C	Box	*€/Stück *€/piece
814598460_89	90-115	51	25	1	86,00

*Bloqueur de porte magnétique et ajustable

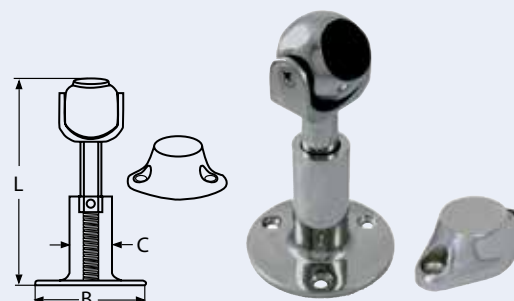

Magnet-Türhalter, schwenkbar / Messing verchromt

Magnet door holder, swiveling, brass chrome plated / Bloqueur de porte magnétique, orientable, laiton chromé

814206

Bestell-Nr. Order no.	L	L1	Box	*€/Stück *€/piece
814206780	40	60	1	67,50

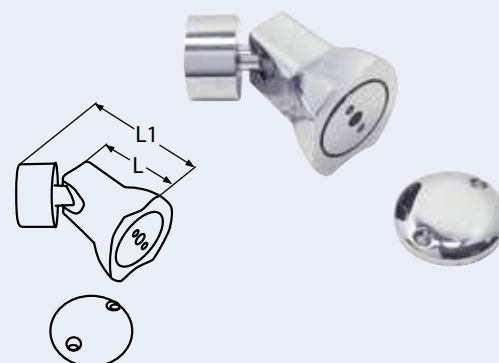

NEW

Magnet-Türhalter / Messing verchromt

Magnet door holder brass chrome plated / Bloqueur de porte magnétique

814682

Bestell-Nr. Order no.	Ø	H	Box	*€/Stück *€/piece
814682740	40	25	1	50,00

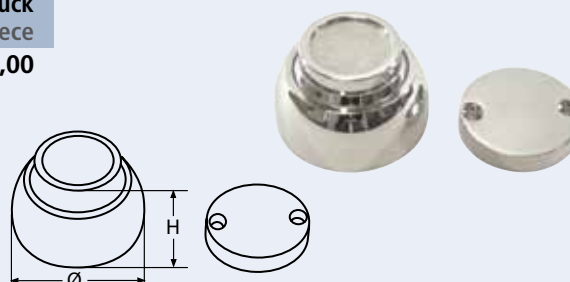

6

Scharniere, Griffe, Haken und Ringe

Hinges, handles, hooks and rings

Charnières, poignées, crochets et anneaux

8584

Bootshakenhalter / A2-AISI 304

Boat hook holder / Support de cordage

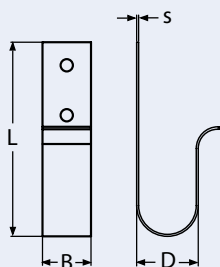

Bestell-Nr. Order no.	L	B	D	S	Box	*€/Stück *€/piece
85842100	100	25	32	1	10	3,70

8593

Bootshakenhalter / A2-AISI 304

Boat hook holder / Fixation à plat

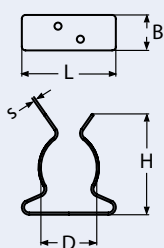

Bestell-Nr. Order no.	L	B	D	H	S	Box	*€/Stück *€/piece
8593235	35	19	20	38	1,3	10	3,00
8593250	50	19	28	54	1,3	10	3,80

8579

Klappauge / A2-AISI 304

Folding pad eye / Poignée

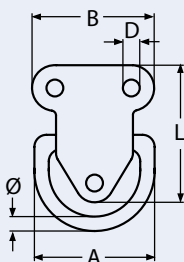

Bestell-Nr. Order no.	Ø	B	D	L	A	Box	*€/Stück *€/piece
8579206	6	50	7	58	55	5	9,50
8579208	8	50	7	58	55	5	14,00

814662

Klappauge / A4-AISI 316

Foldaway pad eye / Poignée

NEW

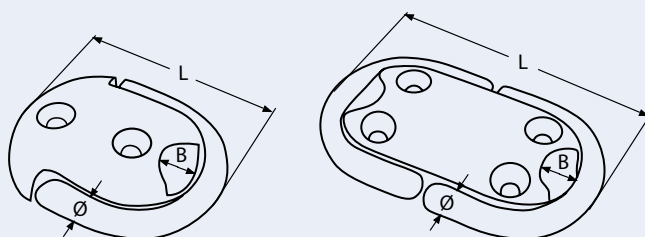

Bestell-Nr. Order no.	Type	L	B	Ø	Box	*€/Stück *€/piece
8146624SINGLE	single	70	12	8	2	26,00
8146624DOUBLE	double	100	12	8	2	40,00

Scharniere, Griffe, Haken und Ringe

Hinges, handles, hooks and rings
Charnières, poignées, crochets et anneaux

6

Kistengriffe, ähnlich DIN 3136 / A2-AISI 304

Box handle / Poignée pour caisse

8857

Bestell-Nr. Order no.	L	H	S	Box	*€/Stück *€/piece
88572100_80	100	80	1,5	1	9,90

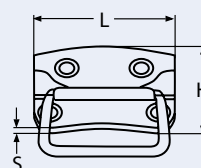

Triangel-Ring, geschweißt und poliert / A2-AISI 304

Triangle ring, welded and polished / Anneau triangle, soudé et poli

8349

Bestell-Nr. Order no.	Ø	L	Innenwinkel Interior angle	Box	*€/Stück *€/piece
834926_40	6	40	60°	10	1,40
834926_45	6	45	60°	10	1,60
834926_50	6	50	60°	5	1,70
834928_45	8	45	60°	5	2,20
834928_50	8	50	60°	5	2,40

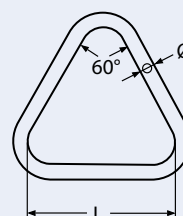

Ring, geschweißt und poliert / A4-AISI 316

Ring, welded and polished / Anneau rond, soudé et poli

8229

Bestell-Nr. Order no.	Ø	H	Box	*€/Stück *€/piece
8229403_15	3	15	50	0,45
8229403_20	3	20	50	0,50
8229403_30	3	30	50	0,55
8229404_25	4	25	50	0,65
8229404_30	4	30	50	0,70
8229404_35	4	35	50	0,80
8229405_30	5	30	20	0,95
8229405_40	5	40	20	1,05
8229406_35	6	35	20	1,40
8229406_40	6	40	20	1,50
8229406_45	6	45	20	1,55
8229408_40	8	40	10	2,00
8229408_50	8	50	10	3,20
8229410_50	10	50	10	5,20
8229410_60	10	60	10	5,30
8229412_70	12	70	5	8,40

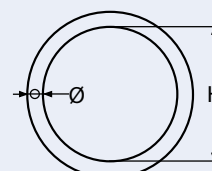

6

Scharniere, Griffe, Haken und Ringe

Hinges, handles, hooks and rings

Charnières, poignées, crochets et anneaux

8274

D-Ring, geschweißt und poliert / A2-AISI 304

D-ring, welded and polished / Anneau semi circulaire, soudé et pol

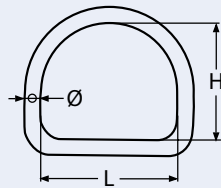

Bestell-Nr. Order no.	Ø	L	H	Box	*€/Stück *€/piece
8274203_15	3	15	15	10	0,60
8274203_20	3	20	18	10	0,70
8274204_20	4	20	18	10	0,80
8274204_25	4	25	23	10	0,90
8274205_25	5	25	23	10	1,10
8274205_30	5	30	26	10	1,30
8274206_30	6	30	27	10	1,60
8274206_40	6	40	36	10	1,80
8274206_50	6	50	47	5	2,00
8274208_50	8	50	36	5	3,10

8963

Ring mit Steg / A4-AISI 316

D-ring with bar / Anneau semi circulaire à barette

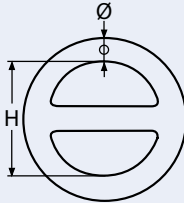

Bestell-Nr. Order no.	Ø	H	BL/Kg	Box	*€/Stück *€/piece
8963406040	6	40	2700	10	2,40
8963408050	8	50	5000	10	4,20
8963410060	10	60	8500	5	6,90
8963412080	12	80	10000	5	12,50

8975

Ring mit Doppelsteg / A4-AISI 316

Double layer D-ring / Anneau barette double

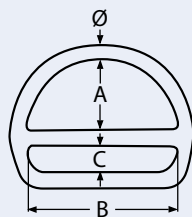

Bestell-Nr. Order no.	Ø	A	B	C	BL/Kg	Box	*€/Stück *€/piece
8975406050	6	28	40	10	1800	10	3,20
8975408050	8	28	40	10	2800	10	5,60

8965

Triangel mit Steg / A4-AISI 316

Triangle with cross bar / Triangle à barré

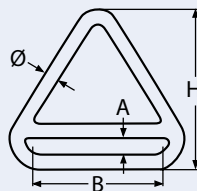

Bestell-Nr. Order no.	Ø	A	B	H	BL/Kg	Box	*€/Stück *€/piece
8965405	5	5	53	52	1300	10	3,00
8965406	6	5	54	53	2000	10	3,20
8965408	8	5	56	62	2800	10	4,50

Scharniere, Griffe, Haken und Ringe

Hinges, handles, hooks and rings

Charnières, poignées, crochets et anneaux

6

Ring, zweiteilig mit Schraube / A2-AISI 304

Two-part ring with screw / Anneau, 2 parties

8964

Bestell-Nr. Order no.	Ø	A	B	Box	*€/Stück *€/piece
8964206	6	42	30	10	4,00
8964208	8	51	35	10	6,40

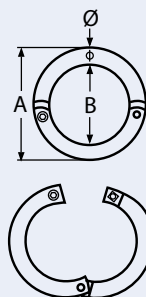

Ring, zweiteilig mit Schnapp-Schnellverschluss / A2-AISI 304

Two-part ring, with snap fastener / Anneau, deux parties, avec fermoir rapide

814188

Bestell-Nr. Order no.	Ø	A	B	Box	*€/Stück *€/piece
814188206	6	42	30	10	3,10
814188208	8	51	35	10	4,30

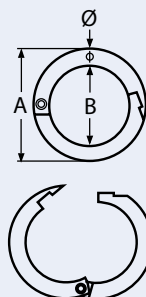

Schlüsselring / 1.4034-AISI 420 C

Key ring / Anneau brisé

8501

Bestell-Nr. Order no.	D	Ø	Box	*€/Stück *€/piece
8501220	20	1,4	100	0,20
8501230	30	2,0	100	0,50

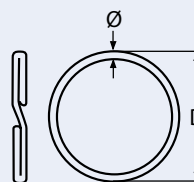

Ovalring, schwere Ausführung / A4-AISI 316

Oval ring, heavy duty / Anneau ovale version lourde

814071

Bestell-Nr. Order no.	Ø	L	B	BL/Kg	Box	*€/Stück *€/piece
814071413	13	120	63	3600	5	15,50
814071416	16	146	76	5440	5	39,00
814071419	19	165	89	7250	5	49,00

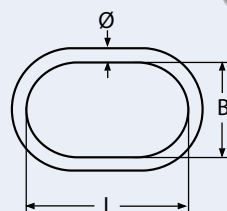

6

Scharniere, Griffe, Haken und Ringe

Hinges, handles, hooks and rings

Charnières, poignées, crochets et anneaux

8270

Ringnagel, geschweißt und poliert / A4-AISI 316

Ring nail, welded and polished / Anneau rond avec pointe, soudé et poli

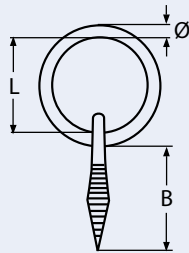

Bestell-Nr. Order no.	Ø	L	B	Box	*€/Stück *€/piece
827043	3	25	35	10	1,50
827044	4	30	35	10	2,10
827045	5	35	38	10	2,70
827046	6	40	40	10	3,40
827048	8	45	40	5	4,50

8335

Griff, poliert / A2-AISI 304

Handle, polished / Poignée poli

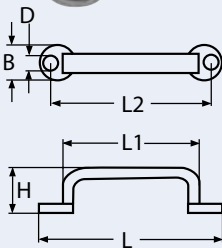

Bestell-Nr. Order no.	L	L1	L2	H	B	D	Box	*€/Stück *€/piece
83352065	65	48	57	16	13	7	5	6,00
83352080	80	64	72	20	14	8	5	6,50
83352100	100	75	88	25	18	10	5	7,00

8336

Griff, poliert / A2-AISI 304

Handle, polished / Poignée poli

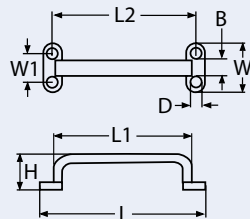

Bestell-Nr. Order no.	L	L1	L2	W1	H	W	B	D	Box	*€/Stück *€/piece
83362118	118	100	105	26	27	36	12	5,5	5	10,50
83362152	152	130	135	35	32	43	18	5,5	2	12,00

814078

Griff / A4-AISI 316

Handle / Poignée

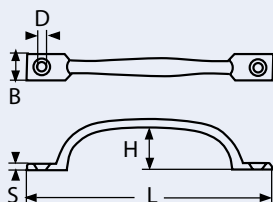

Bestell-Nr. Order no.	L	H	S	B	D	Box	*€/Stück *€/piece
8140784106	150	27,5	3,6	17	6,5	5	5,80

Scharniere, Griffe, Haken und Ringe

Hinges, handles, hooks and rings
Charnières, poignées, crochets et anneaux

6

NEW

Handgriff / A4-AISI 316
Handle / Poignée

814724

Bestell-Nr. Order no.	L	H	Box	*€/Stück *€/piece
8147244124	124	32	1	30,70

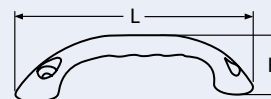

NEW

Handgriff mit Gewinde / A4-AISI 316
Handle with thread / Poignée

814725

Bestell-Nr. Order no.	L	H	C	GW	Box	*€/Stück *€/piece
8147254124	124	32	37	M6	1	38,80

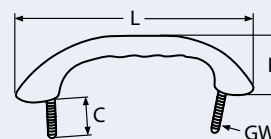

NEW

Handgriff / A2-AISI 304
Handle / Poignée

814680

Bestell-Nr. Order no.	Ø	L	L1	H	GW	Box	*€/Stück *€/piece
8146802142	16	142	110	53	M8	5	15,00
8146802215	19	215	175	56	M8	5	20,00

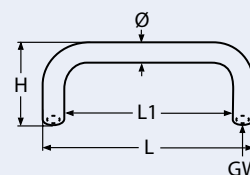
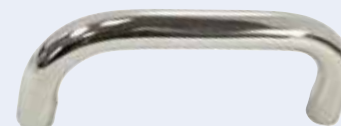

Kapitel 7

Chapter 7

Klampen, Blöcke und Bolzen

Cleats, blocks and bolts



Klappen, Blöcke und Bolzen

Cleats, blocks and bolts

Taquets, poulies et cadènes

7

Belegklampe rund, mit 4 Bohrungen / A4-AISI 316

Hollow base cleat / Taquet avec 4 trous

8217

Bestell-Nr. Order no.	H	S	B	A	L	L1	D	Box	*€/Stück *€/piece
82174100	24	16	36	100	40	18	5,4	1	8,30
82174125	27	19	40	124	50	25	4,8	1	11,00
82174150	31	20	46	151	74	40	6,5	1	14,00
82174200	39	24	55	200	93	53	6,5	1	22,50
82174250	45	31	64	243	109	70	7,6	1	36,20
82174300	55	31	71	303	122	78	7,6	1	53,00

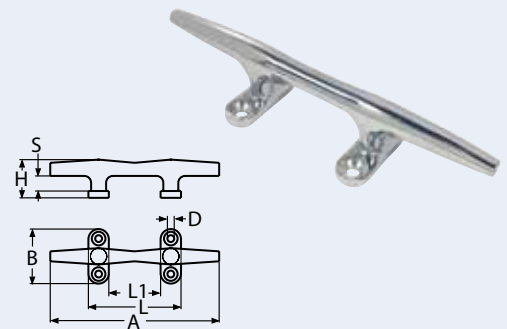

Belegklampe flach, mit 4 Bohrungen / A4-AISI 316

Low flat cleat / Taquet avec 4 trous

8218

Bestell-Nr. Order no.	H	S	B	A	L	L1	D	Box	*€/Stück *€/piece
82184100	22	15	36	98	42	17	4,6	1	10,00
82184125	25	19	46	124	26	56	5,5	1	12,00
82184150	29	20	60	150	70	33	6,1	1	21,30
82184200	40	29	60	200	80	34	6,5	1	30,80
82184250	41	28	65	250	78	29	7,6	1	51,00

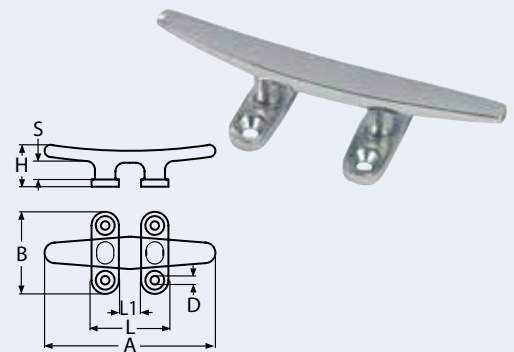

Belegklampe flach, mit 2 Bohrungen / A4-AISI 316

Low flat cleat / Taquet avec 2 trous

8221

Bestell-Nr. Order no.	A	B	H	L	D	Box	*€/Stück *€/piece
82214100	100	14	23,5	50	4,4	1	10,00
82214125	125	15	30	65	4,4	1	13,00
82214150	150	20	32	75	5,3	1	17,00
82214200	200	23	42	80	6,6	1	26,00
82214250	250	25	52	105	8,3	1	34,00

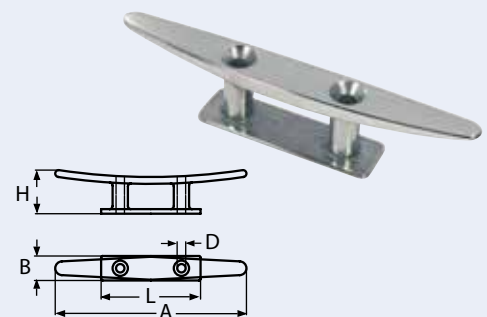

Klampe / A4-AISI 316

Cleat / Taquet taraudé

8680

Bestell-Nr. Order no.	L	L1	B	H	GW	Box	*€/Stück *€/piece
86804150_30	150	90	30	45	M6	1	28,00
86804200_35	200	120	35	54	M6	1	30,00
86804250_40	250	150	40	70	M8	1	74,00
86804300_50	300	160	50	80	M14	1	80,00

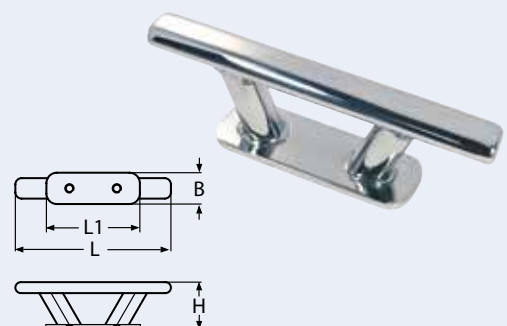

Klappen, Blöcke und Bolzen

Cleats, blocks and bolts

Taquets, poulies et cadènes

8529

Horn-Poller / A4-AISI 316

Horn bollard / Bille d'amarrage taraudée

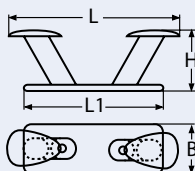

Bestell-Nr. Order no.	L	L1	B	H	GW	Box	*€/Stück *€/piece
85294160	160	150	60	65	M10	1	56,00
85294200	200	165	65	70	M10	1	78,00
85294240	220	200	70	85	M10	1	128,00
85294300	300	255	80	100	M12	1	145,00
85294350	340	310	90	115	M18	1	185,00

814303

Klüsenklampe / A4-AISI 316

Fairlead roller / Chaumards à galets

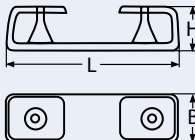
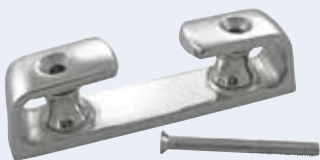

Bestell-Nr. Order no.	Für Seil For rope	L	B	H	Box	*€/Stück *€/piece
8143034205_40	16 - 22	205	40	55	1	107,00
8143034260_45	24 - 30	260	45	75	1	148,00

8827

Klampe, versenkbar / A4-AISI 316

Pull out flat cleat / Taquet coulissant

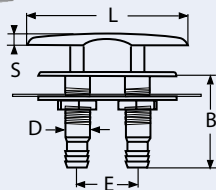

Bestell-Nr. Order no.	L	B	S	E	D	Box	*€/Stück *€/piece
88274100	100	50	4	45	19	1	85,00
88274150	150	60	4	57	22	1	131,00
88274200	200	70	5	70	25	1	175,00
88274250	250	95	6	87	31	1	275,00

814218

Klampe, versenkbar mit Federautomatik / A4-AISI 316

Automatic pull out cleat, spring loaded / Taquet avec Système ressort

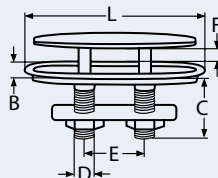

Bestell-Nr. Order no.	L	B	C	D	E	F	Box	*€/Stück *€/piece
8142184120	120	32	75	22	44	19	1	128,00
8142184170	170	38	94	25	58	22	1	163,00
8142184224	224	46	113	35	76	25	1	258,00
8142184278	278	50	132	38	87	30	1	338,00

Klappen, Blöcke und Bolzen

Cleats, blocks and bolts

Taquets, poulies et cadènes

7

NEW

Klappklampe "X" Typ mit Gewinde / A4-AISI 316
Folding cleat "X" type / Taquet encastrable type „X“ avec filetage

814639

Bestell-Nr. Order no.	L	B	H	L1	A	GW	Box	*€/Stück *€/piece
8146394150	150	22	60	52	54	M10	1	85,00
8146394200	200	30	80	56	70	M10	1	164,00
8146394250	250	36	100	60	90	M10	1	272,00

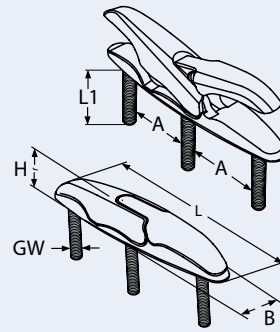

NEW

Klappklampe mit Gewinde / A4-AISI 316
Folding cleat with thread / Taquet encastrable avec filetage

814640

Bestell-Nr. Order no.	L	B	H	L1	A	GW	Box	*€/Stück *€/piece
8146404155	155	54	13,5	51	35	M10	1	72,00
8146404200	200	73	15,0	63	47	M10	1	95,00

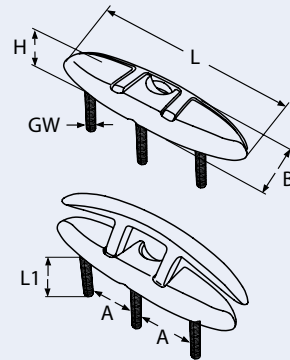

NEW

Klappklampe / A4-AISI 316
Folding cleat / Taquet encastrable à visser

814641

Bestell-Nr. Order no.	L	B	H	Box	*€/Stück *€/piece
8146414155	155	54	13,5	1	62,00
8146414200	200	73	15,0	1	92,00

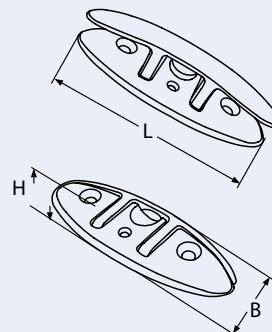

Klampen, Blöcke und Bolzen

Cleats, blocks and bolts

Taquets, poulies et cadènes

8508

Poller / A2-AISI 304

Bollard / Bitte d'amarrage

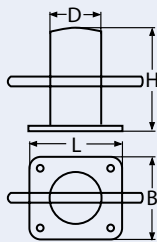

Bestell-Nr. Order no.	B	L	H	D	Box	*€/Stück *€/piece
85082090	80	90	100	50	1	56,00
85082120	95	120	120	60	1	64,50

8557

Poller mit Konterplatte / A2-AISI 304

Bollard with balance plate / Bitte d'amarrage avec contre plaque

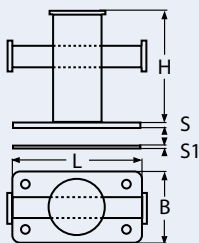

Bestell-Nr. Order no.	L	B	H	S	S1	Box	*€/Stück *€/piece
85572200	200	110	180	6	3	1	172,00

8885

Kreuzpoller / A4-AISI 316

Cross bollard / Bitte d'amarrage en croix

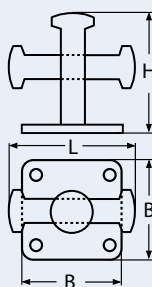

Bestell-Nr. Order no.	B	H	L	Box	*€/Stück *€/piece
8885460_60	60 x 60	85	83	1	63,00

8886

Doppelkreuzpoller / A4-AISI 316

Double cross bollard / Bitte d'amarrage double croix

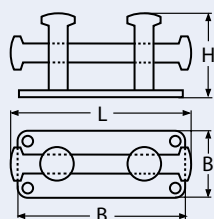

Bestell-Nr. Order no.	B	H	L	Box	*€/Stück *€/piece
88864150_60	150 x 60	85	170	1	113,00

Klappen, Blöcke und Bolzen

Cleats, blocks and bolts

Taquets, poulies et cadènes

7

Notklampe / A4-AISI 316

Self-setting cleat / Porte taquet

8517

Bestell-Nr. Order no.	L	B	H	D	Box	*€/Stück *€/piece
85174180_155	188	155	85	8	4	18,00

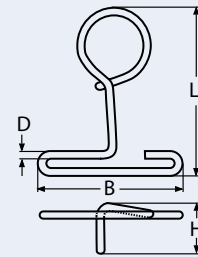

Flaggenklampe / A2-AISI 304

Flag pole cleat / Taquet pour fanion

8367

Bestell-Nr. Order no.	L	B	A	H	D	Box	*€/Stück *€/piece
8367250	50	10	22	10	3,7	10	1,80
8367280	80	10	38	19	5	10	3,00

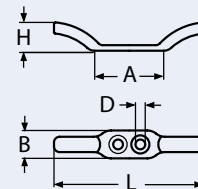

Flaggenklampe / A4-AISI 316

Flag pole cleat / Taquet pour fanion

8973

Bestell-Nr. Order no.	L	D	A	Box	*€/Stück *€/piece
89734068	68	4,5	10	10	1,80
89734114	114	5,8	21	10	2,70
89734150	150	6,7	24	10	4,10

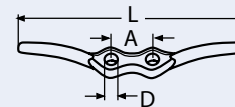

Flaggenklampe mit gewölbter Grundplatte / A4-AISI 316

Flag pole cleat with curved plate / Taquet ovale pour fanion

814137

Bestell-Nr. Order no.	L	H	A	B	Box	*€/Stück *€/piece
814137459	59	20	25	18	5	3,40

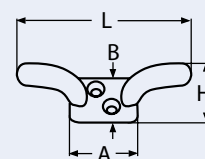

Klampen, Blöcke und Bolzen

Cleats, blocks and bolts

Taquets, poulies et cadènes

8219

Lippklampe / A4-AISI 316

Skene bow chocks / Chaumard croisé

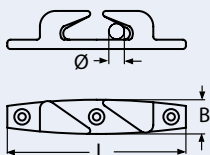

Bestell-Nr. Order no.	L	B	Tau-Ø Rope-Ø	Box	*€/Stück *€/piece
82194L115	115 L	23	10	1	10,60
82194R115	115 R	23	10	1	10,60
82194L150	150 L	35	16	1	17,00
82194R150	150 R	35	16	1	17,00
82194P115	115 L+R	23	10	2	10,60
82194P150	150 L+R	35	16	2	17,00

8220

Lippklampe / A4-AISI 316

Straight chocks / Chaumard droit

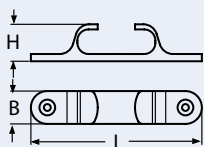

Bestell-Nr. Order no.	L	B	H	Box	*€/Stück *€/piece
82204125	125	23	27	1	14,90
82204155	155	23	27	1	16,00

8865

Tauklemme für Seil 4-6 mm / A4-AISI 316

Rope clamp for rope 4-6 mm / Bride de corde de 4-6 mm

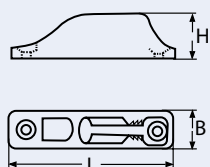
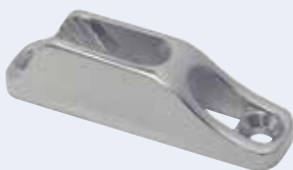

Bestell-Nr. Order no.	L	B	H	Box	*€/Stück *€/piece
8865455_17	55	15	18,5	10	11,00
8865470_15	70	17	18,7	10	11,40
8865482_18	82	18	23,2	10	13,00

Klampen, Blöcke und Bolzen

Cleats, blocks and bolts

Taquets, poulies et cadènes

7

Mini Block mit Kunststoffrolle und Bügel / A2-AISI 304

Single block with nylon sheave and bracket / Poulie simple avec réa en nylon

8840

Bestell-Nr. Order no.	Rollen-Ø Reels-Ø	Rille Groove	Box	*€/Stück *€/piece
8840225	25	6	1	2,90



Mini-Block mit Kunststoffrolle und austauschbarem Bolzen und Bügel / A4-AISI 316

Single block with removable pin and bracket on top, nylon sheave / Poulie simple avec réa en nylon

8391

Bestell-Nr. Order no.	Rollen-Ø Reels-Ø	Rille/mm Groove/mm	Box	*€/Stück *€/piece
8391425	25	6	1	4,60



Mini-Block mit Kunststoffrolle und austauschbarem Bolzen / A4-AISI 316

Single block with removable pin, nylon sheave / Poulie simple avec réa en nylon

8407

Bestell-Nr. Order no.	Rollen-Ø Reels-Ø	Rille/mm Groove/mm	Box	*€/Stück *€/piece
8407425	25	6	1	4,50



7

Klampen, Blöcke und Bolzen

Cleats, blocks and bolts

Taquets, poulies et cadènes

814608



1



2



3

814609



1



2



3



4



5



6



7



8



9



10



11

Klampen, Blöcke und Bolzen

Cleats, blocks and bolts
Taquets, poulies et cadènes

7

Sprenger Super Miniblock / A2-AISI 304

Sprenger super mini block / Sprenger poulie super mini

814608

Bestell-Nr. Order no.	Beschreibung Description	Seil-Ø Rope-Ø	Rollen-Ø Sheaves-Ø	L	BL/Kg	Box	*€/Stück *€/piece
1 8146082-01	Drahtwirbel Wire swivel	10	20 x 10	55	150	10	8,00
2 8146082-02	Hundsfott Becket	10	20 x 10	53	500	10	11,40
3 8146082-03	Drahtwirbel und Fenderöse Wire swivel and fender cleat	10	20 x 10	64	150	10	12,00

Sprenger Micro XS Block mit Kugellager / A2-AISI 304

Sprenger micro XS block with ball bearing / Sprenger poulie micro XS avec plastic et palier à billes

814609

Bestell-Nr. Order no.	Beschreibung Description	Rollen Sheaves	Seil-Ø Rope-Ø	Rollen-Ø Sheaves-Ø	BL/Kg	Box	*€/Stück *€/piece
1 8146092-01	Bügel Bow	1	max. 6	19	450	3	14,00
2 8146092-02	Wirbel Swivel	1	max. 6	19	450	3	28,00
3 8146092-03	Bügel und Hundsfott Bow and becket	1	max. 6	19	450	3	19,00
4 8146092-04	Wirbel und Hundsfott Swivel and becket	1	max. 6	19	450	3	35,00
5 8146092-05	Bügel Bow	2	max. 6	19	450	3	37,00
6 8146092-06	Bügel und Hundsfott Bow and becket	2	max. 6	19	450	3	44,00
7 8146092-07	Bügel Bow	3	max. 6	19	450	3	50,00
8 8146092-08	Bügel und Hundsfott Bow and becket	3	max. 6	19	450	3	62,00
9 8146092-09	Bügel und Schotklemme Bow and cam cleat	3	max. 6	19	450	3	110,00
10 8146092-10	Bügel, Schotklemme und Hundsfott Bow, cam cleat and becket	3	max. 6	19	450	3	113,00
11 8146092-11	Liegeblock mit Lasche Block with strap	1	max. 6	19	450	3	26,00

7

Klampen, Blöcke und Bolzen

Cleats, blocks and bolts

Taquets, poulies et cadènes

814610



1



2



3



4



5



6



7



8



9



10



11



12

Sprenger Blöcke für 6mm Schot Kunststoffrollen mit Gleitlager/ A2-AISI 304

Sprenger blocks for 6mm sheet with plastic sheaves and slide bearing / **

814610

Bestell-Nr. Order no.	Beschreibung Description	Rollen Sheaves	Seil-Ø Rope-Ø	Rollen-Ø Sheaves-Ø	BL/Kg	Box	*€/Stück *€/piece
1 8146102-01	Bügel Bow	1	max. 6	25 x 9,2	700	10	14,00
2 8146102-02	Wirbel Swivel	1	max. 6	25 x 9,2	700	10	25,00
3 8146102-03	Hohlachse Hollow axle	1	max. 6	25 x 9,2	700	10	16,00
4 8146102-04	Drehbare Grundplatte Swiveling base	1	max. 6	25 x 9,2	700	10	27,00
5 8146102-05	Bügel Bow	2	max. 6	25 x 9,2	700	10	23,00
6 8146102-06	Wirbel Swivel	2	max. 6	25 x 9,2	700	10	35,00
7 8146102-07	Bügel Bow	3	max. 6	25 x 9,2	700	10	30,00
8 8146102-08	Bügel und Hundsfott Bow and becket	3	max. 6	25 x 9,2	700	10	39,00
9 8146102-09	Niederholer Block mit V-Klemme Jamming block with V-cleat	1	max. 6	25 x 9,2	700	3	23,00
10 8146102-10	Niederholer Block mit V-Klemme Jamming block with V-cleat	2	max. 6	25 x 9,2	700	3	28,00
11 8146102-11	Niederholer Block mit V-Klemme Jamming block with V-cleat	3	max. 6	25 x 9,2	700	3	36,00
12 8146102-12	Niederholer Block mit Schotklemme Jamming block with cam-cleat	2	max. 6	35 x 11 22 x 9,2	700	3	58,00

**Sprenger poulie pour cordage 6mm avec r a plastic et palier   billes

Klampen, Blöcke und Bolzen

Cleats, blocks and bolts

Taquets, poulies et cadènes

814613



1



2



3



4



5



6



7



8



9



10



11



12



13



14



15



16



17

Sprenger Blöcke für 8mm Schot mit Kunststoffseitenteilen und Kugellager

Sprenger blocks for 8mm sheet with plastic sides and ball bearing / **

814613

Bestell-Nr. Order no.	Beschreibung Description	Rollen Sheaves	Seil-Ø Rope-Ø	Rollen-Ø Sheaves-Ø	BL/Kg	Box	*€/Stück *€/piece
1 8146133-01	Bügel Bow	1	8	27 x 11,5	600	5	20,00
2 8146133-02	Wirbel Swivel	1	8	27 x 11,5	600	5	26,00
3 8146133-03	U-Wirbel U-swivel	1	8	27 x 11,5	600	5	34,00
4 8146133-04	Hohlachse Hollow axle	1	8	27 x 11,5	600	5	24,00
5 8146133-05	Bügel und Hundsfott Bow and becket	1	8	27 x 11,5	600	5	25,00
6 8146133-06	Wirbel und Hundsfott Swivel and becket	1	8	27 x 11,5	600	5	31,00
7 8146133-07	Bügel Bow	2	8	27 x 11,5	600	5	28,00
8 8146133-08	Bügel und Hundsfott Bow and becket	2	8	27 x 11,5	600	5	35,00
9 8146133-09	Wirbel und Hundsfott Swivel and becket	2	8	27 x 11,5	600	5	43,00
10 8146133-10	Bügel Bow	3	8	27 x 11,5	600	5	52,00
11 8146133-11	Wirbel Swivel	3	8	27 x 11,5	600	5	57,00
12 8146133-12	Bügel und Hundsfott Bow and becket	3	8	27 x 11,5	600	5	61,00
13 8146133-13	Wirbel und Schotklemme Swivel and cam cleat	3	8	27 x 11,5	600	5	136,00
14 8146133-14	Travellerblock	2	8	27 x 11,5	600	5	39,00
15 8146133-15	Mit Fenderöse und Feder With fender cleat and spring	1	8	27 x 11,5	600	5	28,00
16 8146133-16	Relingstützen-Block Rail stanchion block	1	8	27 x 11,5	600	5	36,00
17 8146133-17	Wirbel für 8 mm Blöcke Swivel for 8 mm blocks					5	13,00

**Sprenger poulie pour cordage 8MM avec pièce latérale plastique et palier à billes

7

Klappen, Blöcke und Bolzen

Cleats, blocks and bolts

Taquets, poulies et cadènes

814614



1



2



3



4



5



6



7



8



9



10



11



12



13



14



15

Sprenger Blöcke für 10mm Schot mit Kunststoffseitenteilen und Kugellager

Sprenger blocks for 10mm sheet with plastic sides and ball bearing / **

814614

Bestell-Nr. Order no.	Beschreibung Description	Rollen Sheaves	Seil-Ø Rope-Ø	Rollen-Ø Sheaves-Ø	BL/Kg	Box	*€/Stück *€/piece
1 8146143-01	Bügel Bow	1	10	35 x 12	850	5	24,00
2 8146143-02	Wirbel Swivel	1	10	35 x 12	850	5	38,00
3 8146143-03	Bügel und Hundsfott Bow and becket	1	10	35 x 12	850	5	31,00
4 8146143-04	Wirbel und Hundsfott Swivel and becket	1	10	35 x 12	850	5	51,00
5 8146143-05	Mit Fenderöse und Feder With fender cleat and spring	1	10	35 x 12	850	5	34,00
6 8146143-06	Bügel Bow	2	10	35 x 12	850	5	50,00
7 8146143-07	Wirbel Swivel	2	10	35 x 12	850	5	70,00
8 8146143-08	Bügel Bow	3	10	35 x 12	850	5	78,00
9 8146143-09	Bügel und Hundsfott Bow and becket	3	10	35 x 12	850	5	90,00
10 8146143-10	Wirbel und Hundsfott Swivel and becket	3	10	35 x 12	850	5	102,00
11 8146143-11	Violinenblock mit Bügel Violin shaped block with bow	2	10	44 x 12 26 x 12	850	5	47,00
12 8146143-12	Violinenblock mit Schotklemme Violin shaped block with cam cleat	2	10	46 x 12 26 x 12	850	5	124,00
13 8146143-13	Grossschotblock mit Wirbel und Hundsfott Mainsheet block with swivel and becket	1	10	35 x 12	850	5	119,00
14 8146143-14	Grossschotblock mit Wirbel und Hundsfott Mainsheet block with swivel and becket	3	10	35 x 12	850	5	164,00
15 8146143-15	Wirbel für 10mm Blöcke Swivel for 10mm blocks					1	19,00

**Sprenger poulie pour cordage 10mm avec pièce latérale plastique et palier à billes

7

Klappen, Blöcke und Bolzen

Cleats, blocks and bolts

Taquets, poulies et cadènes

814615



Sprenger Blöcke für 12mm Schot mit Kunststoffseitenteilen und Kugellager

Sprenger blocks for 12mm sheet with plastic sides and ball bearing / **

814615

Bestell-Nr. Order no.	Beschreibung Description	Rollen Sheaves	Seil-Ø Rope-Ø	Rollen-Ø Sheaves-Ø	BL/Kg	Box	*€/Stück *€/piece
1 8146153-01	Bügel Bow	1	12	50 x 14	1000	5	35,00
2 8146153-02	Wirbel Swivel	1	12	50 x 14	1000	5	45,00
3 8146153-03	Bügel und Hundsfott Bow and becket	1	12	50 x 14	1000	5	41,00
4 8146153-04	Bügel Bow	2	12	50 x 14	1000	5	62,00
5 8146153-05	Bügel Bow	3	12	50 x 14	1000	5	100,00
6 8146153-06	Bügel und Hundsfott Bow and becket	2	12	50 x 14	1000	5	71,00
7 8146153-07	Bügel und Hundsfott Bow and becket	3	12	50 x 14	1000	5	98,00
8 8146153-08	Violinenblock mit Bügel Violin shaped block with bow	2	12	50 x 14 29 x 14	1000	5	52,00
9 8146153-09	Violinenblock mit Hundsfott und Wirbel Violin shaped block with swivel and becket	2	12	50 x 14 29 x 14	1000	5	68,00
10 8146153-10	Violinenblock mit Schnappschäkel Violin shaped block with snap shackle	2	12	50 x 14 29 x 14	1000	5	93,00
11 8146153-11	Mit Schnappschäkel With snap shackle	1	12	50 x 14	1000	5	68,00
12 8146153-12	Grossschotblock mit Wirbel und Hundsfott Mainsheet block with swivel and becket	1	12	50 x 14	1000	5	143,00
13 8146153-13	Grossschotblock mit Wirbel und Hundsfott Mainsheet block with swivel and becket	3	12	50 x 14	1000	5	210,00
14 8146153-14	Wirbel für 12 mm Blöcke Swivel for 12 mm blocks					1	20,00

**Sprenger poulie pour cordage 12 mm avec pièce latérale plastique et palier à billes

Klampen, Blöcke und Bolzen

Cleats, blocks and bolts

Taquets, poulies et cadènes

814611

Sprenger Blöcke für 8mm Schot Kunststoffrollen und Gleitlager / A2-AISI 304

Sprenger blocks for 8mm sheet with plastic sheaves and slide bearing / **

Bestell-Nr. Order no.	Beschreibung Description	Rollen Sheaves	Seil-Ø Rope-Ø	Rollen-Ø Sheaves-Ø	BL/Kg	Box	*€/Stück *€/piece
1 8146112-01	Ohne Bügel Without bow	1	8	30 x 10	800	10	14,00
2 8146112-02	Bügel Bow	1	8	30 x 10	800	10	16,00
3 8146112-03	Bügel und Hundsfott Bow and becket	1	8	30 x 10	800	10	25,00
4 8146112-04	Bügel und Hundsfott Bow and becket	2	8	30 x 10	800	10	42,00

** Sprenger poulie pour cordage 8mm avec r a plastic et palier lisse

1



2



3



4



814616

Sprenger Stehblock mit Gleitlager / A2-AISI 304

Sprenger standing block with slide bearing / **



Bestell-Nr. Order no.	Rollen Sheaves	Seil-Ø Rope-Ø	Rolle-Ø Sheave-Ø	BL/Kg	Box	*€/Stück *€/piece
8146162-01	1	8	30 x 10	1200	10	17,60

** Sprenger simple   plat pont r as vertical avec palier lisse

Klampen, Blöcke und Bolzen

Cleats, blocks and bolts

Taquets, poulies et cadènes

7

Sprenger Blöcke für 10mm Schot Kunststoffrollen und Gleitlager / A2-AISI 304

Sprenger blocks for 10mm sheet with plastic sheaves and slide bearing / **

814612

Bestell-Nr. Order no.	Beschreibung Description	Rollen Sheaves	Seil-Ø Rope-Ø	Rollen-Ø Sheaves-Ø	BL/Kg	Box	*€/Stück *€/piece
1 8146122-01	Bügel Bow	1	10	35 x 11	850	10	18,00
2 8146122-02	Bügel und Hundsfott Bow and becket	1	10	35 x 11	850	10	25,00
3 8146122-03	Bügel Bow	2	10	35 x 11	850	10	31,00

** Sprenger poulie pour cordage 10mm avec rœa plastic et palier lisse

1



2



3



Sprenger Einlassblock mit Kugellager / A2-AISI 304

Sprenger thru deck block with ball bearing / Sprenger poulies a encastrer avec palier à billes

814617

Bestell-Nr. Order no.	Rollen Sheaves	Seil-Ø Rope-Ø	Rollen-Ø Sheaves-Ø	Box	*€/Stück *€/piece
8146172-01	1	8	27 x 11	10	43,00



Sprenger Liegeblock mit Gleitlager / A2-AISI 304

Sprenger cheek block with slide bearing / Sprenger poulies de renovi avec palier lisse

814618

Bestell-Nr. Order no.	Rollen Sheaves	Seil-Ø Rope-Ø	Rollen-Ø Sheaves-Ø	Box	*€/Stück *€/piece
8146182-01	1	12	50 x 14	10	35,00



Klampen, Blöcke und Bolzen

Cleats, blocks and bolts

Taquets, poulies et cadènes

814619

Sprenger Liegblock mit Gleitlager / Alu

Sprenger cheek block with slide bearing / Sprenger poulies de renovi avec palier lisse



01

Bestell-Nr. Order no.	Rollen Sheaves	Seil-Ø Rope-Ø	Rollen-Ø Sheaves-Ø	BL/Kg	Box	*€/Stück *€/piece
8146190-01	1	12	29 x 14	900	2	49,00
8146190-02	2	12	29 x 14	900	2	63,00



02

814620

Sprenger Seilrollen / A2-AISI 304

Sprenger rope sheaves/ Sprenger réas



Bestell-Nr. Order no.	Beschreibung Description	Seil-Ø Rope-Ø	Rollen-Ø Sheaves-Ø	Box	*€/Stück *€/piece
8146203-25	Kugellager Ball bearing	4 - 5	25 x 6,6	10	17,80
8146203-27	Kugellager Ball bearing	8	27 x 10,5	10	46,90

814621

Sprenger Seilrollen / Plastik

Sprenger rope sheaves/ Sprenger réas



Bestell-Nr. Order no.	Beschreibung Description	Nabe Hub	Seil-Ø Rope-Ø	Rollen-Ø Sheaves-Ø	Box	*€/Stück *€/piece
8146213-05	Kugellager Ball bearing	5	8	27 x 11	10	14,50
8146213-06	Kugellager Ball bearing	6	8	27 x 11	10	14,50

814623

Sprenger Seilrollen / Plastik

Sprenger rope sheaves/ Sprenger réas



Bestell-Nr. Order no.	Beschreibung Description	Achse Pivot	Seil-Ø Rope-Ø	Rollen-Ø Sheaves-Ø	Box	*€/Stück *€/piece
8146233-08_30	Gleitlager Slide bearing	8,2	8	30 x 10,5	10	6,20
8146233-10_35	Gleitlager Slide bearing	8,2	10	35 x 11,5	10	6,50
8146233-10_46	Gleitlager Slide bearing	8,2	10	46 x 11,5	10	7,80
8146233-12_50	Gleitlager Slide bearing	8,2	12	50 x 13,8	10	8,30

Clampen, Blöcke und Bolzen

Cleats, blocks and bolts

Taquets, poulies et cadènes

7

Sprenger Schotklemmen

Sprenger cam cleats / Sprenger taquet coniceur

814633

Bestell-Nr. Order no.	Seil-Ø Rope-Ø	A	Box	*€/Stück *€/piece
814633303	3 - 6	29	1	26,00
814633308	8 - 13	40	1	36,00

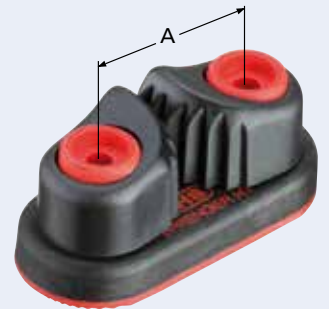

Sprenger Schotklemmen mit Führung

Sprenger cam cleats with fairlead / Sprenger taquet coniceur avec filoir

814634

Bestell-Nr. Order no.	Seil-Ø Rope-Ø	A	Box	*€/Stück *€/piece
814634303	3 - 6	29	1	38,00
814634308	8 - 13	40	1	51,00

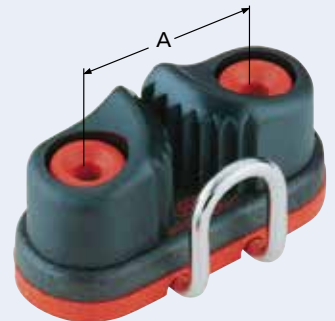

Sprenger Schotklemmen mit Spezial-Führung

Sprenger cam cleats with special lead / Sprenger taquet coniceur avec guide spécial

814635

Bestell-Nr. Order no.	Seil-Ø Rope-Ø	A	Box	*€/Stück *€/piece
814635303	3 - 6	29	1	51,00
814635308	8 - 13	40	1	62,00

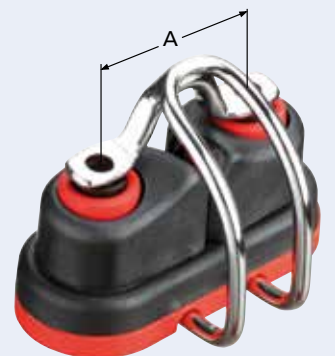

HS SPRENGER

NEW

Schotklemme / A4-AISI 316

Cam cleat / coinqueur pour cordage Ø 3 à 6 mm

814716

Bestell-Nr. Order no.	Seil-Ø Rope-Ø	A	Box	*€/Stück *€/piece
814716403	3 - 6	40	2	53,00

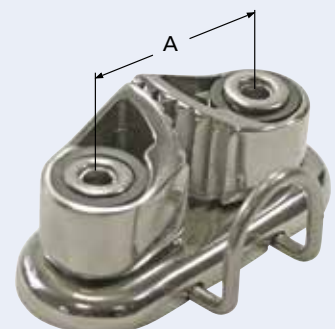

Klappen, Blöcke und Bolzen

Cleats, blocks and bolts

Taquets, poulies et cadènes

814636

Sprenger Unterlegkeil für Schotklemme, 15°

Sprenger wedge for cam cleats, 15° / Sprenger cône pour taquet coniqueur, 15°

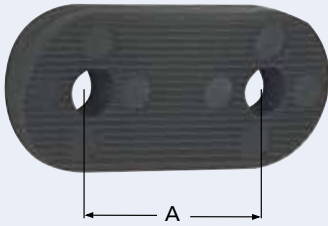

Bestell-Nr. Order no.	Für Schotklemme For cam cleat	A	Box	*€/Stück *€/piece
814636303	3 - 6	29	1	7,00
814636308	8 - 13	40	1	8,00

814624

Sprenger Genua Schiene / Alu eloxiert

Sprenger track rail, anodized / Sprenger rail anodisé

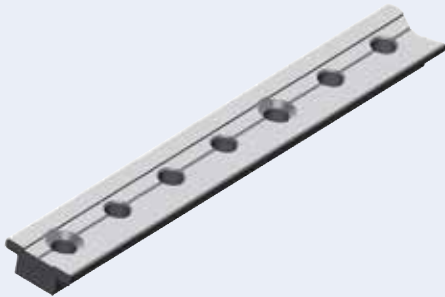

Bestell-Nr. Order no.	Profil Profile	Länge Length	Box	*€/Stück *€/piece
81462400300	20 x 3	300	4	13,60
81462400400	20 x 3	400	4	16,40
81462400500	20 x 3	500	4	21,60
81462401000	20 x 3	1000	4	37,50
81462401500	20 x 3	1500	4	56,30

814625

Sprenger Genua Schiene / Alu eloxiert

Sprenger track rail, anodized / Sprenger rail anodisé

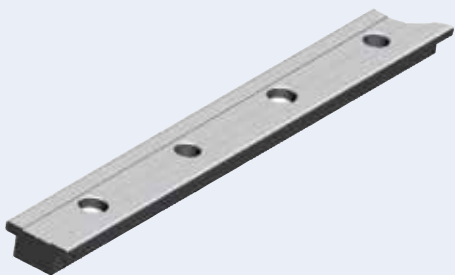

Bestell-Nr. Order no.	Profil Profile	Länge Length	Box	*€/Stück *€/piece
81462501000	25 x 4	1000	4	40,50
81462501500	25 x 4	1500	4	60,30
81462502000	25 x 4	2000	4	81,00

814626

Sprenger Schienenendstücke / Plastik

Sprenger track rail end stops/ Sprenger rail embout



Bestell-Nr. Order no.	Für Profil For profile	Box	*€/Stück *€/piece
814626320	20 x 3	10	3,30
814626325	25 x 4	10	4,60

Klampen, Blöcke und Bolzen

Cleats, blocks and bolts

Taquets, poulies et cadènes

7

Sprenger Genuaschlitten / Alu

Sprenger adjustable sheet slider / Sprenger chariot i'avale tout

814627

Bestell-Nr. Order no.	Ausführung Type	Für Profile For profile	Rollen-Ø Sheaves-Ø	L	Box	*€/Stück *€/piece
8146270S	Silber eloxiert Silver anodized	20 x 3	30 x 20	65	1	65,00
8146270B	Schwarz Kunststoff beschichtet Black plastic coated	20 x 3	30 x 20	65	1	71,00



8146270S



8146270B

Sprenger Genuaschlitten / A2-AISI 304

Sprenger adjustable sheet slider / Sprenger chariot i'avale tout

814628

Bestell-Nr. Order no.	Ausführung Type	Für Profile For profile	L	Box	*€/Stück *€/piece
814628220	Mit Bügel With bow	20 x 3	65	1	36,00



Sprenger Genuaschlitten / A2-AISI 304

Sprenger adjustable sheet slider / Sprenger chariot i'avale tout

814629

Bestell-Nr. Order no.	Ausführung Type	Für Profile For profile	L	Box	*€/Stück *€/piece
814629220	Mit Wirbel With swivel	20 x 3	45	1	36,00



Sprenger Genuaschlitten / Alu

Sprenger adjustable sheet slider / Sprenger chariot i'avale tout

814630

Bestell-Nr. Order no.	Ausführung Type	Für Profile For profile	Rollen-Ø Sheaves-Ø	L	Box	*€/Stück *€/piece
8146300S	Silber eloxiert Silver anodized	25 x 4	40 x 25	88	1	113,00
8146300B	Schwarz Kunststoff beschichtet Black plastic coated	25 x 4	40 x 25	88	1	93,00



8146300S



8146300B

7

Klampen, Blöcke und Bolzen

Cleats, blocks and bolts

Taquets, poulies et cadènes

814631

Sprenger Genuaschlitten / A2-AISI 304

Sprenger adjustable sheet slider / Sprenger chariot i'avale tout



Bestell-Nr. Order no.	Ausführung Type	Für Profil For profile	L	Box	*€/Stück *€/piece
814631225	Mit Bügel With bow	25 x 4	65	1	65,00

HS SPRENGER

814632

Sprenger Genuaschlitten / A2-AISI 304

Sprenger adjustable sheet slider / Sprenger chariot i'avale tout



Bestell-Nr. Order no.	Ausführung Type	Für Profil For profile	L	Box	*€/Stück *€/piece
814632225	Mit Wirbel With swivel	25 x 4	65	1	75,00

HS SPRENGER

8564

Schlitten mit Auge / A4-AISI 316

Genova slide with eye / Pontet sur coulisseau + stoppeur

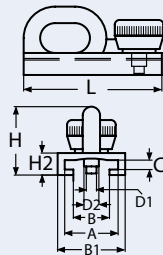

Bestell-Nr. Order no.	A	B	C	D1	D2	B1	H2	L	Box	*€/Stück *€/piece
8564427	27	20	4	6	9,5	33	7	81	1	21,00
8564434	34	23	5,5	7,8	9,5	43	14	88	1	24,00

8872

Genua-Schlitten, arretierbar / A4-AISI 316

Genova slide, adjustable / Chape sur coulisseau + stoppeur



Bestell-Nr. Order no.	Für Profil For profile	L	Box	*€/Stück *€/piece
8872425	25 x 4	64	1	21,90

Klappen, Blöcke und Bolzen

Cleats, blocks and bolts

Taquets, poulies et cadènes

7

Block mit Messingbuchsen / A2-AISI 304

Single block with brass bushing / Poulie dériveur avec émerillon

8369

Bestell-Nr. Order no.	¹ Ø	² mm	A	B	C	D	L	S.W.L.	*€/Stück *€/piece
8369225	25	9	27	20	13	5	88	300	14,80
8369232	32	10	35	22	17	6	104	300	17,00
8369250	50	13	54	29	19	8	143	500	25,90

¹Rollen-Ø / Reel-Ø ²Rille mm / Groove mm

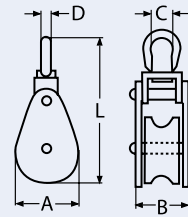

Block mit Messingbuchse (kleine Rolle) / A2-AISI 304

Single block with brass bushing and small sheave / Poulie simple avec émerillon

8393

Bestell-Nr. Order no.	¹ Ø	² mm	A	B	C	D	L	S.W.L.	Box	*€/Stück *€/piece
8393225	25	12	30	24	14	6	83	600	1	14,00
8393232	32	12	36	24	14	6	96	700	1	15,00
8393250	50	15	54	28	20	8	130	1000	1	22,60

¹Rollen-Ø / Reel-Ø ²Rille mm / Groove mm

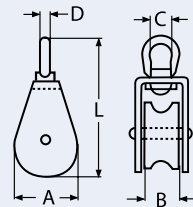

Block mit Messingbuchse, Doppelrolle / A2-AISI 304

Double block with brass bushing / Poulie double avec émerillon

8390

Bestell-Nr. Order no.	¹ Ø	² mm	A	B	C	D	L	S.W.L.	Box	*€/Stück *€/piece
8390225	25	8	27	37	13	5	88	300	1	21,90
8390232	32	8	35	42	17	6	104	300	1	24,90
8390250	50	14	54	54	19	8	143	500	1	38,30

¹Rollen-Ø / Reel-Ø ²Rille mm / Groove mm

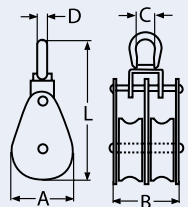

Block mit Messingbuchse / A2-AISI 304

Single block with brass bushing / Poulie simple avec émerillon

8392

Bestell-Nr. Order no.	¹ Ø	² mm	A1	B	D	S.W.L.	Box	*€/Stück *€/piece
83922050	50	14	52	21	16	1000	1	21,00
83922075	75	14	78	19	16	1600	1	38,00
83922100	100	16	104	24	19	2600	1	66,80

¹Rollen-Ø / Reel-Ø ²Rille mm / Groove mm

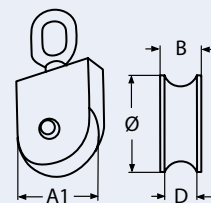

Klampen, Blöcke und Bolzen

Cleats, blocks and bolts

Taquets, poulies et cadènes

8402

Sicherheitsklappblock / A4-AISI 316

Single block with safety latch / Poulie simple avec émerillon/ Réas passage rapide

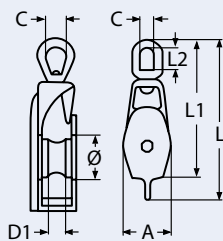

Bestell-Nr. Order no.	¹ Ø	² mm	D1	A	C	L2	L1	L	S.W.L.	Box	*€/Stück *€/piece
84024050	50	14	14	52	22	30	151	171	1000	1	39,00
84024075	75	16	16	78	25	39	211	231	1650	1	82,00

¹Rollen-Ø / Reel-Ø ²Rille mm / Groove mm

8395

Block mit Messingbuchse / A2-AISI 304

Single block with brass bushing / Poulie avec crochet

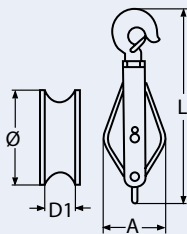

Bestell-Nr. Order no.	¹ Ø	² mm	D1	A	L	S.W.L.	Box	*€/Stück *€/piece
83952075	75	16	16	80	256	1400	1	62,00
83952100	100	19	19	108	315	2500	1	107,00

¹Rollen-Ø / Reel-Ø ²Rille mm / Groove mm

8526

Reffleinenrolle / A2-AISI 304

Furling block / Poulie avec collier de serrage

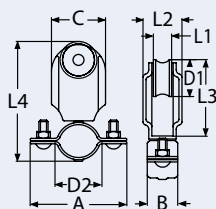

Bestell-Nr. Order no.	Ausführung Design	A	B	C	D1	D2	L1	L2	L3	L4	Box	*€/Stück *€/piece
85262FEST	Feststehend Fixed	63	20	36	25	25	14	26	40	65	1	24,00
85262WIRBEL	Mit Wirbel With swivel	63	20	36	25	25	14	26	50	80	1	26,00

8651

U-Bolzen mit zwei Gegenplatten / A4-AISI 316

U-bolt with two counter plates / Cadène avec double plaque

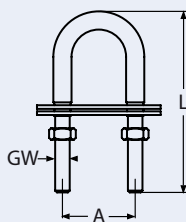

Bestell-Nr. Order no.	GW	L	A	Box	*€/Stück *€/piece
8651408_100	M8	100	40	1	14,30
8651410_100	M10	100	40	1	18,20
8651412_120	M12	120	47	1	25,70

Klappen, Blöcke und Bolzen

Cleats, blocks and bolts

Taquets, poulies et cadènes

7

U-Bolzen mit 2 Gegenplatten und Abreissmuttern / A4-AISI 316

U-bolt with counter plates and pull-off nuts / Cadène avec double plaque et écrou inviolable

814223

Bestell-Nr. Order no.	GW	L	L1	D	A	Box	*€/Stück *€/piece
814223408_100	M8	100	60	10	40	5	16,00
814223410_100	M10	100	48	12	40	5	20,00
814223412_120	M12	120	58	14	50	2	30,00

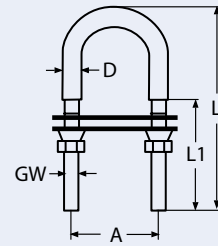

U-Bolzen / A2-AISI 304

U-bolt bow eye / Cadène à fil

8230

Bestell-Nr. Order no.	GW	L	A	L1	Box	*€/Stück *€/piece
8230204_064	M4	64	30	30	10	2,70
8230205_080	M5	80	35	40	10	3,00
8230206_090	M6	90	35	40	10	3,80
8230208_080	M8	80	35	40	10	4,10
8230208_100	M8	100	35	50	10	4,50
8230210_090	M10	90	50	40	5	7,30
8230210_130	M10	130	50	55	5	8,40
8230212_150	M12	150	60	65	5	14,00

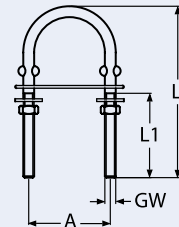

U-Bolzen mit zwei Gegenplatten, Kopf gewinkelt / A4-AISI 316

U-bolt with two counter plates, angled head / Cadène à fil double forme "V"

8979

Bestell-Nr. Order no.	W	GW	L	L1	A	H	Box	*€/Stück *€/piece
897940800	0°	M8	100	50	33	40	10	10,00
897940808	8°	M8	100	50	33	40	10	10,00
897940818	18°	M8	100	50	33	40	10	10,00
897941000	0°	M10	120	60	40	40	5	16,00
897941008	8°	M10	120	60	40	40	5	16,00
897941018	18°	M10	120	60	40	40	5	16,00

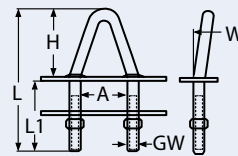

U-Bolzen / A4-AISI 316

Bow eye / Cadène avec levage

814112

Bestell-Nr. Order no.	Ø	L1	L2	D	GW	Box	*€/Stück *€/piece
814112425	25	114	64	30	M10	5	18,60

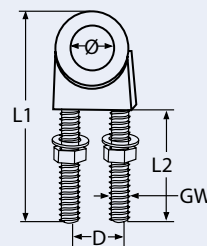

Klappen, Blöcke und Bolzen

Cleats, blocks and bolts

Taquets, poulies et cadènes

8267

Augbolzen mit metrischem Gewinde / A4-AISI 316

Eye bolt with metric thread / Piton à œil vis métrique

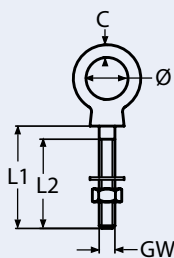

Bestell-Nr. Order no.	GW	L1	L2	C	Ø	BL/Kg	Box	*€/Stück *€/piece
8267406_040	M6	40	34	5	16	1150	20	2,90
8267406_060	M6	60	54	5	16	1150	20	3,20
8267406_080	M6	80	70	5	16	1150	20	3,30
8267408_080	M8	80	70	6	19	1300	20	4,20
8267408_100	M8	100	90	6	19	1300	20	4,30
8267410_100	M10	100	88	8	25	1800	10	6,50
8267412_120	M12	120	105	10	30	2500	10	10,80

814318

Augbolzen mit Kragen und metrischem Gewinde / A4-AISI 316

Eye bolt with plate and metric thread / Piton à œil avec Embase vis métrique

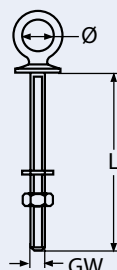

Bestell-Nr. Order no.	GW	L	Ø	Box	*€/Stück *€/piece
814318406_30	M6	30	12,0	10	4,00
814318406_60	M6	60	12,0	10	4,70
814318408_35	M8	35	14,0	10	5,10
814318408_80	M8	80	14,0	10	6,00
814318410_050	M10	50	16,0	5	7,00
814318410_100	M10	100	16,0	5	7,60
814318412_100	M12	100	18,5	5	9,00
814318412_160	M12	160	18,5	5	9,90

814319

Augbolzen mit Kragen und Holzgewinde / A4-AISI 316

Eye bolt with plate and wood thread / Piton à œil avec Embase vis bois

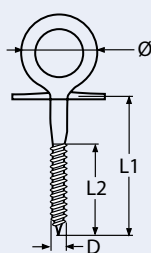

Bestell-Nr. Order no.	D	L1	L2	Ø	Box	*€/Stück *€/piece
814319406_52	6	52	38	20,5	10	5,10
814319406_58	6	58	38	20,5	10	5,30
814319408_80	8	80	55	24,8	5	6,10

8271

Augbolzen mit Holzgewinde / A2-AISI 304

Eye bolt with wood thread / Piton à œil vis bois

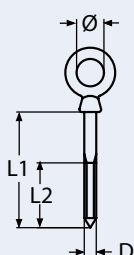

Bestell-Nr. Order no.	D	L1	L2	Ø	Box	*€/Stück *€/piece
8271205_50	5	50	30	11	10	5,00
8271206_60	6	60	35	14	10	5,30
8271208_80	8	80	50	18	10	7,10
8271210_100	10	100	60	22	5	10,00

Klappen, Blöcke und Bolzen

Cleats, blocks and bolts

Taquets, poulies et cadènes

7

Augbolzen mit Holzgewinde / A4-AISI 316

Eye bolt with wood thread / Piton à œil fermé filetage bois

8974

Bestell-Nr. Order no.	Ø	D	B	L1	L2	Box	*€/Stück *€/piece
8974406040	6	6,3	7	40	30	10	3,00
8974406050	6	6,3	7	50	35	10	3,20
8974406060	6	6,3	7	60	40	10	3,50
8974408060	8	8,4	9	60	40	10	4,00
8974408080	8	8,4	9	80	55	10	4,50
8974408100	8	8,4	9	100	65	10	5,00
8974410080	10	10,2	11	80	55	5	6,00
8974410100	10	10,2	11	100	65	5	6,50
8974410120	10	10,2	11	120	80	5	7,50
8974412100	12	12,1	13	100	65	5	8,00
8974412120	12	12,1	13	120	80	5	8,20

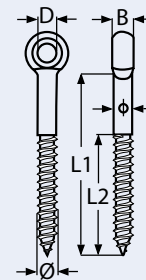

Augbolzen mit Ring / A4-AISI 316

Eye bolt with ring / Piton à œil fermé filtage bois + anneau

814086

Bestell-Nr. Order no.	Ø	L	C	D	Box	*€/Stück *€/piece
814086404045	4	45	30	25	10	3,90
814086405050	5	50	35	30	10	4,20
814086406060	6	60	40	30	10	4,70
814086408080	8	80	55	50	10	7,00
814086410100	10	100	65	60	5	12,80
814086412120	12	120	80	75	5	21,80

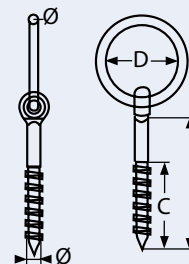

Ösenschaube / A2-AISI 304

Screw eye / Vis à œil métrique

8473

Bestell-Nr. Order no.	GW	L	L1	D	Box	*€/Stück *€/piece
8473205_30	M5	30	27	8	10	0,85
8473205_40	M5	40	37	8	10	1,00
8473205_50	M5	50	47	8	10	1,15
8473206_20	M6	20	18	10	10	1,05
8473206_30	M6	30	27	10	10	1,10
8473206_40	M6	40	37	10	10	1,25
8473206_60	M6	60	57	10	10	1,50
8473208_60	M8	60	57	10	5	2,30
8473208_80	M8	80	77	10	5	2,60
8473210_70	M10	70	65	15	5	3,80

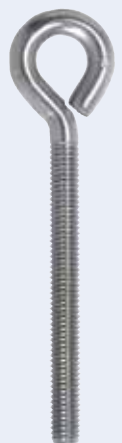
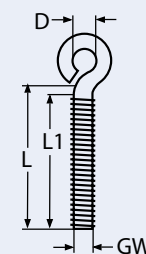

Klampen, Blöcke und Bolzen

Cleats, blocks and bolts

Taquets, poulies et cadènes

8316

Ösenschraube / A4-AISI 316

Screw eye / Piton à œil filetage bois

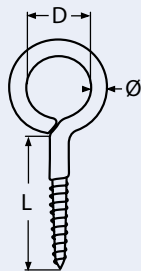

Bestell-Nr. Order no.	L	D	Ø	Box	*€/Stück *€/piece
8316416_8	16	8	3,3	10	0,60
8316420_10	20	10	3,3	10	0,70
8316425_12	25	12	3,9	10	0,80
8316430_14	30	14	3,9	10	1,00

8976

Ösenschraube, schwere Ausführung / A4-AISI 316

Screw eye, heavy duty / Piton à œil filetage bois

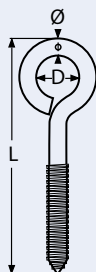

Bestell-Nr. Order no.	Ø	L	D	Box	*€/Stück *€/piece
8976406060	6	62	16	10	1,20
8976406100	6	100	14	10	1,60
8976408085	8	84	20	5	2,60
8976408110	8	108	20	5	3,10
8976410125	10	122	30	5	4,70

814110

Bügelmutter / A4-AISI 316

Lifting eye / Ecrou à oeil de levage

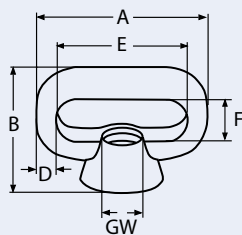

Bestell-Nr. Order no.	GW	A	B	D	E	F	Box	*€/Stück *€/piece
814110412	M12	57	47	10	36	19	5	15,00

814111

Bügel schraube / A4-AISI 316

Lifting eye bolt / Vis à oeil de levage

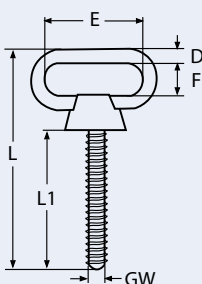

Bestell-Nr. Order no.	GW	L	L1	D	E	F	Box	*€/Stück *€/piece
814111412_98	M12	98	51	10	36	19	5	18,50
814111412_123	M12	123	76	10	36	19	5	23,50
814111412_149	M12	149	102	10	36	19	2	24,00
814111412_174	M12	174	127	10	36	19	2	24,50

Klappen, Blöcke und Bolzen

Cleats, blocks and bolts

Taquets, poulies et cadènes

7

Ringmutter ähnlich DIN 582 / A4-AISI 316

Lifting eye nut / Ecrrou à anneau

8268

Bestell-Nr. Order no.	GW	D	L	D1	Box	*€/Stück *€/piece
8268405	M5	15	25	25	20	3,00
8268406	M6	16	31	27	20	2,00
8268408	M8	20	36	36	20	3,80
8268410	M10	25	45	45	10	4,00
8268412	M12	30	53	54	10	6,00

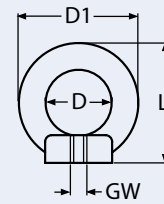

Ringmutter, geschmiedet, ähnlich DIN 582 / A4-AISI 316

Lifting eye nut, drop forged / Ecrrou à anneau forgé

814123

Bestell-Nr. Order no.	GW	D	L	D1	Box	*€/Stück *€/piece
814123408	M8	20	36	36	20	6,00
814123410	M10	25	45	45	10	10,00
814123412	M12	30	53	54	10	11,00
814123416	M16	35	62	63	5	21,30
814123420	M20	40	71	72	5	27,00
814123424	M24	50	90	90	2	64,00

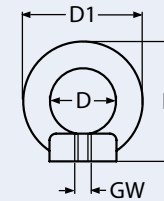

Ringschraube, ähnlich DIN 580 / A4-AISI 316

Lifting eye bolt / Vis à anneau

8272

Bestell-Nr. Order no.	GW	D	L	H	D1	Box	*€/Stück *€/piece
8272405	M5	15	10	25	25	20	4,00
8272406	M6	16	13	31	27	20	3,00
8272408	M8	20	14	36	36	20	3,50
8272410	M10	25	16	45	45	10	4,50
8272412	M12	30	21	53	54	10	8,00

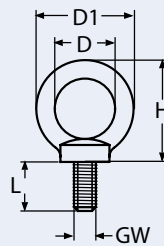

Ringschraube, geschmiedet, ähnlich DIN 580 / A4-AISI 316

Lifting eye bolt, drop forged / Vis à anneau forgé

814122

Bestell-Nr. Order no.	GW	D	L	H	D1	Box	*€/Stück *€/piece
814122408	M8	20	13	36	36	20	5,20
814122410	M10	25	17	45	45	10	8,30
814122412	M12	30	20	53	54	10	10,50
814122416	M16	35	27	62	63	5	22,70
814122420	M20	40	30	71	72	5	29,00
814122424	M24	50	36	90	90	1	68,00

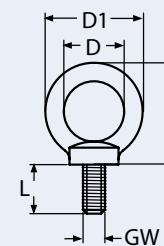

Klampen, Blöcke und Bolzen

Cleats, blocks and bolts

Taquets, poulies et cadènes

8228

Ringbolzen / A2-AISI 304

Ring bolt / Piton avec anneau

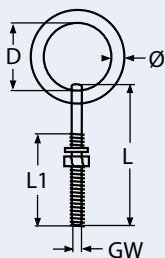

Bestell-Nr. Order no.	GW	Ø	D	L	L1	Box	*€/Stück *€/piece
8228206	M6	6	35	75	50	5	3,10
8228208	M8	8	45	75	50	5	6,00
8228210	M10	9	50	100	75	5	10,00
8228212	M12	12	60	120	80	5	12,00

8537

Langaugenmutter / A4-AISI 316

Long eye nut / Ecrou à anneau

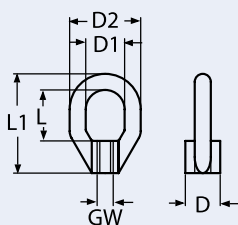

Bestell-Nr. Order no.	GW	L	L1	D	D1	D2	Box	*€/Stück *€/piece
853748	M8	19	37	13	15	27	10	3,60

8538

Doppellangaugenmutter / A4-AISI 316

Double-long eye nut / Double écrou à anneau

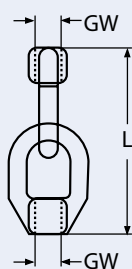

Bestell-Nr. Order no.	GW	L	Box	*€/Stück *€/piece
853848	M8	60	5	8,00

8481

Krampe / A2-AISI 304

U-bar / Crampillon inox

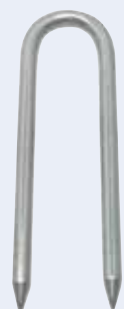

Bestell-Nr. Order no.	Ø	L	Box	*€/Stück *€/piece
848126_100	6	100	10	2,50

Kapitel 8 Chapter 8

Yachtzubehör, Ausrüstung und Spezielles Yachting accessoires, equipment and highlights



Yachtzubehör, Ausrüstung und Spezielles

Yachting accessories, equipment and highlights

Equipement et accessoires exclusifs pour yachts

8465

Handy-Halter für Wandbefestigung / A4-AISI 316

Mobile phone bracket for wall mounting / Support pour téléphone mobile

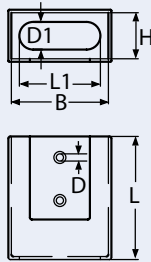

Bestell-Nr. Order no.	L	L1	B	H	D	D1	Box	*€/Stück *€/piece
8465460_48	60	40	48	24	3,5	14	1	12,00

Geschmacksmuster geschützt / patented
Auch in Blister-Skin-Verpackung lieferbar /
Also available in blister packets

8553

Handy-Halter mit Fuß / A4-AISI 316

Mobile phone bracket with base / Support pour téléphone mobile

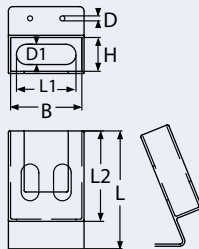

Bestell-Nr. Order no.	L	L1	L2	B	H	D1	Box	*€/Stück *€/piece
8553480_48	80	40	60	48	24	14	1	24,50

Geschmacksmuster geschützt / patented
Auch in Blister-Skin-Verpackung lieferbar /
Also available in blister packets

814690

Universal Handy-Halter / Plastik

Universal mobile phone-holder / Support universel pour téléphone

NEW



Bestell-Nr. Order no.	Klemmbereich Cleaming area	Box	*€/Stück *€/piece
814690355 80	55 - 80	1	12,00

- Befestigung per Saugnapf oder Klebeplatte
- Halter um 360° drehbar
- Selbsteinstellend für die gängigsten Handys
- Mountable by suction cup or adhesive plate
- Holder can be rotated 360°
- Self-adjusting for the most popular mobile phones

814689

Universal Tablet-Halter / Plastik

Universal tablet-holder / Support unviersel pour tablette

NEW



Bestell-Nr. Order no.	Klemmbereich Cleaming area	Box	*€/Stück *€/piece
8146893110 200	110 - 200	1	20,00

- Einfache Saugnapf Befestigung
- Universell einstellbar für jedes Tablet
- Halter um 360° drehbar
- Easy-to-use suction cup mount
- Universally adjustable for any tablet
- Holder can be rotated 360°

NEW

Wasserfeste iPad Hülle / PVC

Waterproof iPad bag / Housse imperméable pour Ipad

814695

Bestell-Nr. Order no.	H	B	Box	*€/Stück *€/piece
8146953275	275	210	5	25,00

Passend für alle iPad Generationen.
 Fitting for all iPad generations.

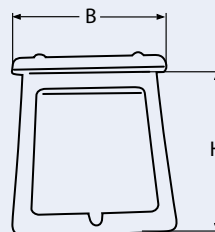

NEW

Wasserfeste Smartphone Hülle / PVC

Waterproof smartphone bag / Housse imperméable pour Smartphone

814696

Bestell-Nr. Order no.	H	B	Box	*€/Stück *€/piece
8146963140	140	100	5	15,00

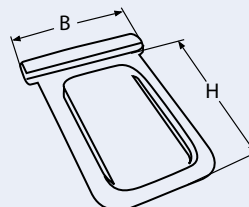

NEW

Faltbares Solarladegerät mit 5000 mAh USB Akku

Foldable solar charger with 5000 mAh USB battery / Sac à dos solaire pliable avec batterie 5000 mA

814736

Bestell-Nr. Order no.	Maße ausgeklappt Size opened	Maße gefaltet Size folded	Box	*€/Stück *€/piece
8147363	480 x 230	230 x 160	5	150,00

Zum laden von mobilen Geräten unterwegs.
 Faltbar zur einfachen Verstauung.
 Mit Schlaufen zur Rucksack- oder Zeltbefestigung.
 For charging portable devices on the go.
 Foldable for easy stowing.
 With loops for attachment to backpacks or tents.

Solar Panel:

Leistung: 7Watt / 6.5 V
 Max Ausgang: 5V / 1.1 Ah
 Anschlüsse: 1 x USB Ausgang

Solar Panel:

Power: 7 Watt/6.5 V
 Max Output: 5V/ 1.1 Ah
 Connections: 1 x USB output

USB Akku:

Kapazität: 5000 mAh
 Ausgangsleistung: 5V / 1 Ah
 Anschlüsse: 2 x USB Ausgang , 1 x Micro USB Ausgang, 1 x USB Eingang
 Batterietyp: Lithium Polymer

USB battery:

Capacity: 5000 mAh
 Output: 5V/ 1 Ah
 Connections: 2 x USB outputs, 1 micro USB output, 1 USB input
 Batterytype: Lithium Polymer



8

8524

Wind King mit Reflektoren / A2-AISI 304

Wind King with reflectors / Girouette

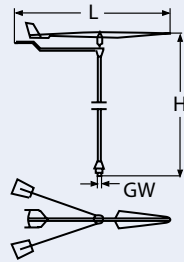

Bestell-Nr. Order no.	L	H	GW	Box	*€/Stück *€/piece
85242400	400	335	M8	1	37,00

8642

LED Beleuchtung für Wind King / A2-AISI 304

LED light for Wing King / LED pour girouette avec Wind King

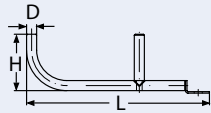

Bestell-Nr. Order no.	D	H	L	Volt	Ampère	Watt	Box	*€/Stück *€/piece
864228_15	11	55	180	8 - 15	0,02	0,33	1	49,50

Für alle gängigen Anzeiger mit 8 mm Gewinde am Sockelende.
Absolut wasserdicht. Leuchtleistung 30.000 Stunden.

Usable with 8 mm socket. 100% waterproof.

Operating life more than 30.000 hours.

Auch in Blister-Skin-Verpackung lieferbar / also available in blister packets

8631

Verkllicker / A4-AISI 316

Masthead fly / Girouette à pavillon

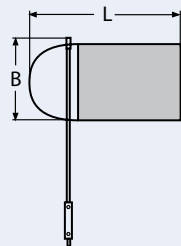

Bestell-Nr. Order no.	L	B	Farbe Colour	Box	*€/Stück *€/piece
86314100_130	130	100	Rot / Red	1	8,00
86314125_175	175	125	Rot / Red	1	8,50
86314150_190	190	150	Rot / Red	1	9,00
86314200_235	235	200	Rot / Red	1	10,00

8528

Tauwerkschneider für Antriebswelle / A4-AISI 316

Line cutter for shaft / Coupe orin inox

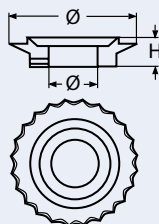

Bestell-Nr. Order no.	Wellen-Ø Shaft-Ø	Außen-Ø Outside-Ø	H	Box	*€/Stück *€/piece
8528425	25	79	18	1	120,00
8528430	30	79	18	1	120,00
8528435	35	79	18	1	120,00
8528440	40	79	18	1	120,00

Kein Verkauf nach Frankreich

No sale to France

Yachtzubehör, Ausrüstung und Spezielles

Yachting accessories, equipment and highlights
 Equipement et accessoires exclusifs pour yachts

8

Relingdrahtset, zur Selbstmontage / A4-AISI 316

Guardrail set, for self mounting / Kit de montage pour filière

8475

Bestell-Nr. Order no.	Bezeichnung Name	Ausführung Design	Box	*€/Stück *€/piece
8475477	Komplettsset Complete set	Rechts / Links Right / Left	1	49,50
84754RECHTS	¹ Ersatzset ¹ Replacement set	Rechts / Right	1	19,50
84754LINKS	¹ Ersatzset ¹ Replacement set	Links / Left	1	19,50



Komplettsset:

- 10 m Edelstahlseil, PVC weiß, ummantelt, 7 x 7 - 4 / 7mm
- 1 Montageterminal mit Rechtsgewinde
- 1 Montageterminal mit Linksgewinde
- 1 Gabel mit Rechtsgewinde und Mutter
- 1 Gabel mit Linksgewinde und Mutter
- 6 Inbusschrauben und 1 Schlüssel

Complete set:

- 10 m wire rope, PVC white, covered, 7 x 7 - 4 / 7 mm
- 1 quick attach terminal with right thread
- 1 quick attach terminal with left thread
- 1 threaded jaw with right thread and nut
- 1 threaded jaw with left thread and nut
- 6 hexagon socket screws and 1 key

Ersatzset, rechts:

- 1 Montageterminal mit Rechtsgewinde
- 1 Gabel mit Rechtsgewinde und Mutter
- 3 Inbusschrauben und 1 Schlüssel

Replacement set, right:

- 1 quick attach terminal with right thread
- 1 threaded jaw with right thread and nut
- 3 hexagon socket screws and 1 key

Ersatzset, links:

- 1 Montageterminal mit Linksgewinde
- 1 Gabel mit Linksgewinde und Mutter
- 3 Inbusschrauben und 1 Schlüssel

Replacement set, left:

- 1 quick attach terminal with left thread
- 1 threaded jaw with left thread and nut
- 3 hexagon socket screws and 1 key

Universaleimer, hochglanzpoliert / A2-AISI 304

Universal bucket, mirror polished / Seau universel

8942

Bestell-Nr. Order no.	Liter	Box	*€/Stück *€/piece
8942206	6	1	40,00
8942210	10	1	50,00



8

NEW

Falteimer / Plastik

Folding bucket / Seau pliable

814718

Bestell-Nr. Order no.	Liter	Box	*€/Stück *€/piece
81471839	9	5	9,90



8

Yachtzubehör, Ausrüstung und Spezielles

Yachting accessories, equipment and highlights

Équipement et accessoires exclusifs pour yachts

8660

Heckleiter, klappbar / A4-AISI 316

Transom folding steps / Échelle 6 marches

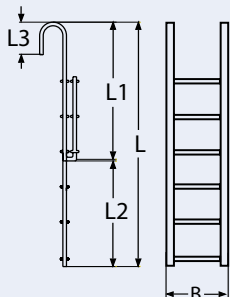

Bestell-Nr. Order no.	Stufen Steps	L	L1	L2	L3	B	Box	*€/Stück *€/piece
866046	3 + 3	1550	950	600	90	283	1	246,00

8887

Heckleiter, klappbar / A4-AISI 316

Stern mount foldable steps / Échelle pliable

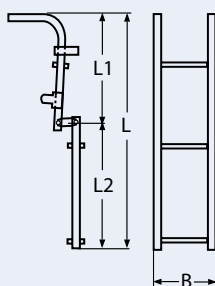

Bestell-Nr. Order no.	Stufen Steps	L	L1	L2	B	Box	*€/Stück *€/piece
888743	3	630	235	395	254	1	96,00

8867

Teleskop Heckleiter / A4-AISI 316

Stern mount telescope steps / Échelle télescopique

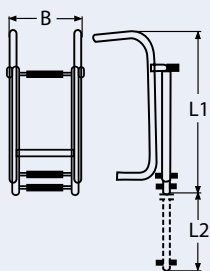

Bestell-Nr. Order no.	Stufen Steps	L1	L2	B	Box	*€/Stück *€/piece
886743	3	450	700	200	1	135,00

8868

Teleskop Badeleiter, Montage unter Plattform / A4-AISI 316

Telescope boarding steps for under platform mounting / Échelle télescopique

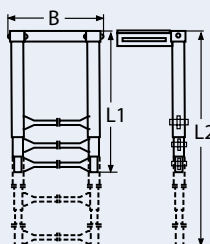

Bestell-Nr. Order no.	Stufen Steps	L1	L2	B	Box	*€/Stück *€/piece
886843	3	310	700	250	1	208,00

Teleskop-Badeleiter zur Plattformmontage / A4-AISI 316

Telescope boarding steps for top of platform mounting / Échelle 3 marches inox télescopique

8437

Bestell-Nr. Order no.	Stufen Steps	L1	L2	B	Box	*€/Stück *€/piece
843742	2	370	570	280	1	132,00
843743	3	410	870	305	1	178,00
843744	4	415	1115	305	1	240,00

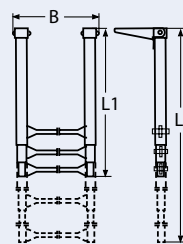

Teleskop Badeleiter, Montage unter Plattform, breite Form / A4-AISI 316

Telescope boarding steps for under platform mounting, wide / Échelle télescopique, forme large

8869

Bestell-Nr. Order no.	Stufen Steps	L1	L2	B	Box	*€/Stück *€/piece
886943	3	370	880	480	1	193,00

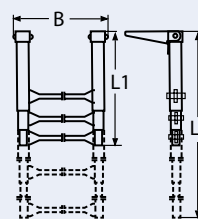

Bugleiter mit versenkbaren Einhängbügeln / A4-AISI 316

Bow ladder with sinkable bows / Echelle de poue avec étriers de suspension abaissables

814044

Bestell-Nr. Order no.	Stufen Steps	L	B	Box	*€/Stück *€/piece
81404443	3	1080	250	1	155,00

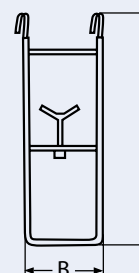

8

Badeleiter / A4-AISI 316

Dive platform ladder / Echelle pour plateforme

814270

Bestell-Nr. Order no.	Stufen Steps	L	B	Box	*€/Stück *€/piece
81427042	2	600	285	1	90,00

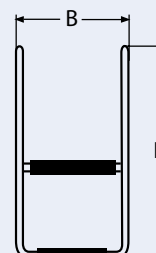

814271

Heckleiter, klappbar / A4-AISI 316

Stern mount foldable steps / Echelle fixe pliante

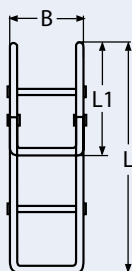

Bestell-Nr. Order no.	Stufen Steps	L	B	L1	Box	*€/Stück *€/piece
81427144	4	1100	250	500	1	135,00
81427145	5	1240	290	750	1	155,00

814272

Teleskop Badeleiter in Kasette / A4-AISI 316

Covered telescope steps / Echelle escamotable télescopique

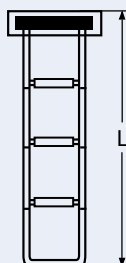

Bestell-Nr. Order no.	Stufen Steps	L	Kastenmaße Measurements	Box	*€/Stück *€/piece
81427243	3	890	330 – 470 – 46	1	400,00
81427244	4	1160	330 – 470 – 46	1	468,00

814273

Heckleiter mit Holzstufen, klappbar / A4-AISI 316

Stern mount foldable ladder with wood steps / Echelle pliante fixation sur tableau

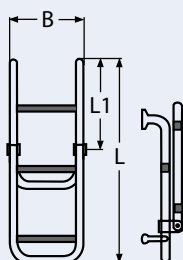

Bestell-Nr. Order no.	Stufen Steps	L	B	L1	Box	*€/Stück *€/piece
81427343	3	800	250	580	1	137,00
81427344	4	1050	250	580	1	163,00
81427345	5	1340	290	580	1	178,00

814274

Heckleiter / Alu

Transom steps / Echelle amovible

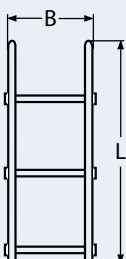

Bestell-Nr. Order no.	Stufen Steps	L	B	Box	*€/Stück *€/piece
81427403	3	880	350	1	70,00
81427404	4	1180	350	1	90,00

Yachtzubehör, Ausrüstung und Spezielles

Yachting accessories, equipment and highlights
 Equipement et accessoires exclusifs pour yachts

8

Schlauchbootleiter / Alu

Ladder for inflatable boats / Echelle amovible pour pneumatique

814275

Bestell-Nr. Order no.	Stufen Steps	L	B	L1	Box	*€/Stück *€/piece
81427502	2	900	250	450	1	65,00
81427503	3	1100	250	470	1	85,00

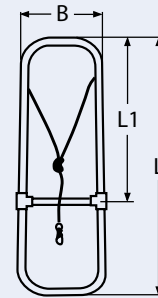

Gangway, klappbar / Alu

Folding gangway / Passerelle - Echelle

814277

Bestell-Nr. Order no.	L	L1	Gewicht (kg) Weight (kg)	Box	*€/Stück *€/piece
8142770180	1800	1000	13	1	800,00
8142770230	2300	1250	16	1	960,00
8142770260	2600	1400	18	1	1020,00

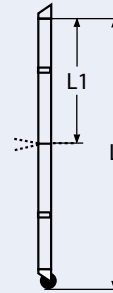

Handlauf für Gangway / A2-AISI 304

Hand rail for gangway / Main courante pour passerelle

814278

Bestell-Nr. Order no.	H	Box	*€/Stück *€/piece
8142782	Für / For 814277	1	65,00

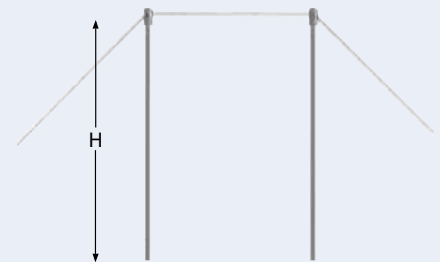

Base für Gangway / Alu

Base for gangway / Platine pour passerelle

814279

Bestell-Nr. Order no.	Box	*€/Stück *€/piece
8142790	Für / For 814277	1 12,00



8

8443

Marinefluppy / A2-AISI 304

Ashtray / Cendrier inox



Bestell-Nr. Order no.	Farbe Colour	Box	*€/Stück *€/piece
84432FLUPPY	Blau / Blue	1	10,30

8585

Fenderhalter, klappbar / A2-AISI 304

Fender holder, foldable / Support de pare-battage amovible

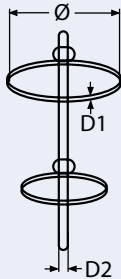

Bestell-Nr. Order no.	Fender-Ø max. Fender-Ø max.	D1	D2	Box	*€/Stück *€/piece
85852200	200	5	22 - 25	1	39,50
85852250	250	5	22 - 25	1	42,00

Der Fenderhalter ist in vier verschiedenen Stufen montierbar.
Can be used on vertical or raked stanchions.

8618

Fenderhalter mit Wirbel, klappbar / A4-AISI 316

Fender holder with swivel, foldable / Support de pare-battage amovible

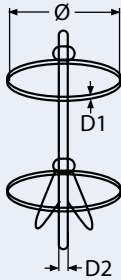

Bestell-Nr. Order no.	Fender-Ø max. Fender-Ø max.	D1	D2	Box	*€/Stück *€/piece
86184230	200	8	22 - 25	1	102,00
86184265	250	8	22 - 25	1	110,00

Der Fenderhalter ist stufenlos montierbar. Schwere Ausführung.
Eine Montage am 30-mm Rohr ist möglich.
This unique design folds nearly flat against your rail and is suitable also for 30-mm tube. Can be used on vertical or raked stanchions.

8607

Fenderhalter, doppelt, klappbar / A2-AISI 304

Fender holder, double, foldable / Support double pare-battage amovible

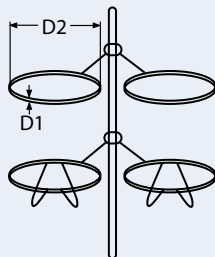

Bestell-Nr. Order no.	Fender-Ø max. Fender-Ø max.	D1	D2	Box	*€/Stück *€/piece
86072200	200	5	22 - 25	1	55,00
86072250	250	5	22 - 25	1	60,00

Yachtzubehör, Ausrüstung und Spezielles

Yachting accessories, equipment and highlights
 Equipement et accessoires exclusifs pour yachts

8

Fenderhalter, doppelt, feststehend / A2-AISI 304

Double fender holder, fixed / Support double pare-battage fixe

8641

Bestell-Nr. Order no.	Fender-Ø max. Fender-Ø max.	A	B	C	D	E	Box	*€/Stück *€/piece
86412140	140	166	340	116	258	367	1	105,00
86412200	200	233	476	175	283	428	1	183,00
86412300	300	340	706	282	321	508	1	220,00

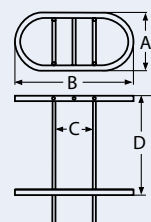

Fenderkorb, doppelt, gerade / A4-AISI 316

Double fender holder, straight / Support droit double pare-battage

814602

Bestell-Nr. Order no.	Fender-Ø max. Fender-Ø max.	L	B	H	Box	*€/Stück *€/piece
8146024180	180	375	190	320	1	81,00
8146024220	220	470	240	315	1	105,00
8146024300	300	670	330	580	1	157,00

Fenderkorb Drahtstärke 8mm mit Befestigung für 22 - 25mm Reling.
 Fender holder wire diameter 8mm with fixing for 22 - 25mm rail.

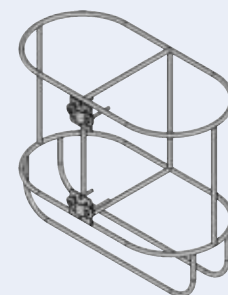
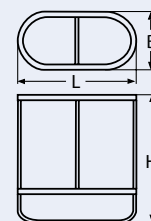

Fenderkorb, doppelt, links / A4-AISI 316

Double fender holder, left / Support double pare-battage „gauche“

814603

Bestell-Nr. Order no.	Fender-Ø max. Fender-Ø max.	L	B	H	Box	*€/Stück *€/piece
8146034180	180	551	190	285	1	96,00
8146034220	220	696	240	328	1	117,00
8146034300	300	962	330	580	1	147,00

Fenderkorb Drahtstärke 8mm mit Befestigung für 22 - 25mm Reling.
 Fender holder wire diameter 8mm with fixing for 22 - 25mm rail.

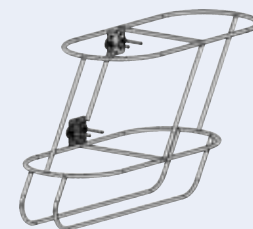
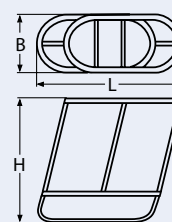

Fenderkorb, doppelt, rechts / A4-AISI 316

Double fender holder, right / Support double pare-battage „droit“

814604

Bestell-Nr. Order no.	Fender-Ø max. Fender-Ø max.	L	B	H	Box	*€/Stück *€/piece
8146044180	180	551	190	285	1	85,00
8146044220	220	696	240	328	1	120,00
8146044300	300	962	330	580	1	145,00

Fenderkorb Drahtstärke 8mm mit Befestigung für 22 - 25mm Reling.
 Fender holder wire diameter 8mm with fixing for 22 - 25mm rail.

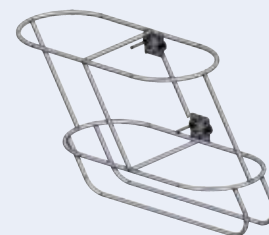
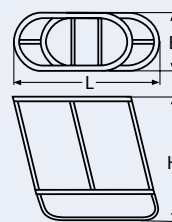

8

Yachtzubehör, Ausrüstung und Spezielles

Yachting accessories, equipment and highlights

Equipement et accessoires exclusifs pour yachts

814119

Fenderhalter / A4-AISI 316

Fender holder / Support de pare-battage

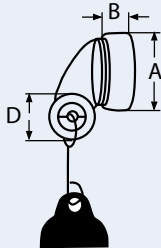

Bestell-Nr. Order no.	A	B	D	Box	*€/Stück *€/piece
814119440	40	8	15	5	14,00

814132

Fenderhalter, drehbar / A4-AISI 316

Swivel fender holder / Soufflage rotatif de pare battage

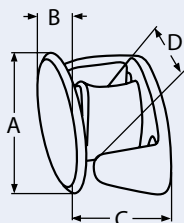

Bestell-Nr. Order no.	A	B	C	D	Box	*€/Stück *€/piece
8141324	63	25	27	18	1	30,00

814298

Bootsmannstuhl

Force chair / Chaise de mât



Bestell-Nr. Order no.	Farbe Colour	Box	*€/Stück *€/piece
8142983	Rot / Red	1	45,00

814291

Retterring

Life saver / Bouée de sauvetage



Bestell-Nr. Order no.	Außen-Ø Outside-Ø	Innen-Ø Inside-Ø	Gewicht Weight	Box	*€/Stück *€/piece
814291325	720	450	2,5 kg	1	88,00
814291343	720	450	4,3 kg	1	110,00

CE-zertifiziert / CE-approved

Yachtzubehör, Ausrüstung und Spezielles

Yachting accessories, equipment and highlights
 Equipement et accessoires exclusifs pour yachts

8

Rettungsset: Hufeisenring, Halterung, Rettungsleuchte

Set composed of horse shoe, bracket, light / **

814292

Bestell-Nr. Order no.	Farbe Colour	Box	*€/Stück *€/piece
8142923G	Gelb / Yellow	1	80,00
8142923O	Orange / Orange	1	80,00
8142923W	Weiß / White	1	80,00

** Assortiments de sauvetage : Bouée der a cheval + feu à retournement + support.



Hufeisenring

Horse shoe / Bouée fer à cheval

814293

Bestell-Nr. Order no.	Farbe Colour	Box	*€/Stück *€/piece
8142933G	Gelb / Yellow	1	54,00
8142933O	Orange / Orange	1	54,00
8142933W	Weiß / White	1	54,00



Rettungsleuchte

Life buoy light / Feu à retournement

814294

Bestell-Nr. Order no.	Box	*€/Stück *€/piece
8142943	1	17,00

CE-zertifiziert
CE-approved



Rettungsinselhalter / A4-AISI 316

Bracket for life raft / Support de radeaux

814300

Bestell-Nr. Order no.	L	B	H	Box	*€/Stück *€/piece
8143004750	700 - 900	520	200	1	260,00

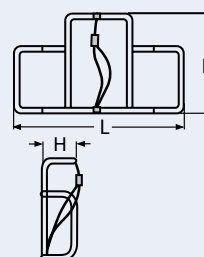

8

8582

Rettungsringhalter / A2-AISI 304

Life ring holder / Support de bouée fer à cheval et de feu de retournement

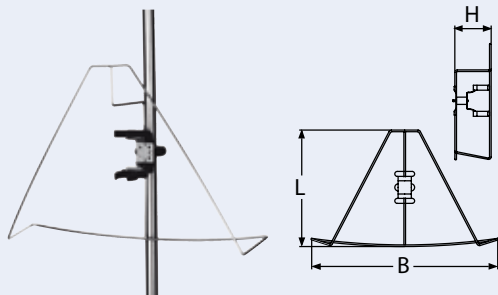

Bestell-Nr. Order no.	L	B	H	Box	*€/Stück *€/piece
85822365	365	570	135	1	29,00

8581

Rettungsringhalter / A2-AISI 304

Life ring holder / Support de bouée avec support de feu de retournement

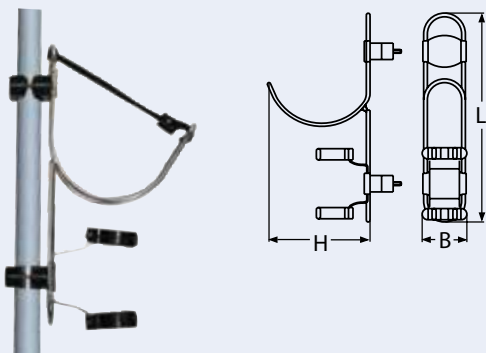

Bestell-Nr. Order no.	L	B	H	Box	*€/Stück *€/piece
85812290	290	50	140	1	24,00

8609

Rettungsringhalter / A2-AISI 304

Life ring holder / Support de bouée

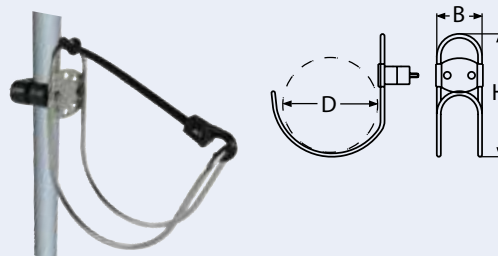

Bestell-Nr. Order no.	D	B	H	Box	*€/Stück *€/piece
86092140	140	55	170	1	18,00

8580

Rettungsbeleuchtungshalterung / A2-AISI 304

Marker light mounting bracket / Support de feu de retournement

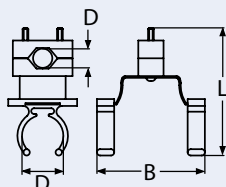

Bestell-Nr. Order no.	D	Rohr-Ø (D) Tube-Ø (D)	L	B	Box	*€/Stück *€/piece
8580222/25	37	22 - 25	120	100	1	9,00

Spinnakerbaumhalter / A4-AISI 316
 Spinnaker pole holder / Support de spinnaker

8461

Bestell-Nr. Order no.	Rohr-Ø (D) Tube-Ø (D)	L	L1	L2	H	S	Box	*€/Stück *€/piece
8461490	25	107	61	21	150	8	1	62,00

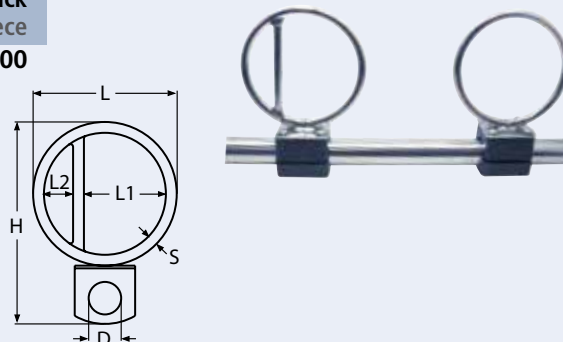

Rettungsleinenhalter / A2-AISI 304
 Life line holder / Enrouleur de cordage

8422

Bestell-Nr. Order no.	Halterung Posture	Rolle-Ø Reel-Ø	Breite Width	Rohrschelle max. Ø Pipe clip max. Ø	Box	*€/Stück *€/piece
84222WAAG	Waagrecht ¹	160	270	30	1	150,00
84222SENK	Senkrecht ²	160	270	30	1	180,00

¹ Horizontal / ² Vertical

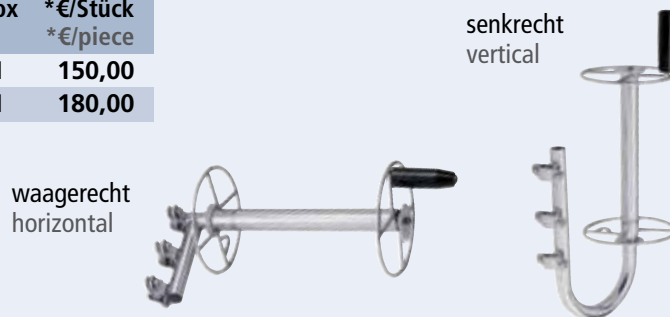

Flaggenstock / A2-AISI 304
 Pennant pole / Porte fanion

8444

Bestell-Nr. Order no.	Rohr-Ø (D) Tube-Ø (D)	H	Box	*€/Stück *€/piece
8444222-25	22 - 25	430	1	33,50

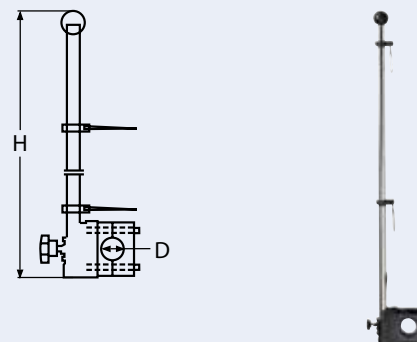

Flaggenstock / A2-AISI 304
 Pennant pole / Porte fanion inox

8438

Bestell-Nr. Order no.	Rohr-Ø (D) Tube-Ø (D)	H	Box	*€/Stück *€/piece
8438222	22	455	1	39,00
8438225	25	455	1	42,00

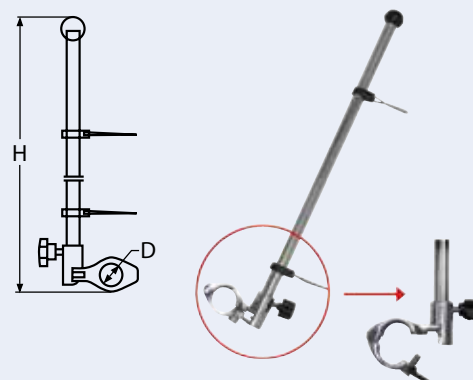

8

Yachtzubehör, Ausrüstung und Spezielles

Yachting accessories, equipment and highlights

Equipement et accessoires exclusifs pour yachts

814133

15° Flaggenstockset, magnetisch / A4-AISI 316

15° magnetic flag pole set / Set de supports de magnétiques pour fanion 15°

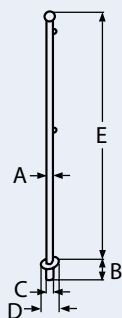

Bestell-Nr. Order no.	A	B	C	D	E	Box	*€/Stück *€/piece
8141334	25	69	31	70	968	1	150,00

8653

Flaggenstock / A2-AISI 304

Flag pole / Porte fanion inox



Bestell-Nr. Order no.	L	L1	Ø	Box	*€/Stück *€/piece
8653219	600	520	19	1	38,00

814717

Flaggenstock / A4-AISI 316

Flag pole / Porte fanion

NEW



Bestell-Nr. Order no.	L	Ø	Box	*€/Stück *€/piece
8147174620	620	25	1	33,60

8654

Flaggenstockhalter / A4-AISI 316

Flag pole socket / Embase de fanion

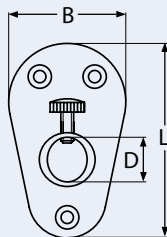

Bestell-Nr. Order no.	D	B	L	Box	*€/Stück *€/piece
8654419	19	50	85	1	29,00

Für 8653 / For 8653

Yachtzubehör, Ausrüstung und Spezielles

Yachting accessories, equipment and highlights
 Equipement et accessoires exclusifs pour yachts

8

Flaggenstockhalter für Reling / A4-AISI 316

Rail mount flag pole socket / Support de hampe pour rail

814114

Bestell-Nr. Order no.	Rohr-Ø (D) Tube-Ø (D)	A	L	L1	Box	*€/Stück *€/piece
814114425	25	25	80	47	1	46,00

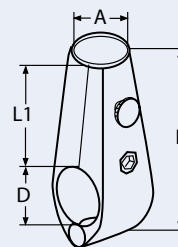

Beck's Halter / A2-AISI 304

Beck's holder / Porte verre

8355

Bestell-Nr. Order no.	Innen-Ø Inside Ø	Höhe Height	Box	*€/Stück *€/piece
8355274	74	260	1	9,50



Flaschenhalter / A2-AISI 304

Bottle holder / Support de bouteille

8525

Bestell-Nr. Order no.	L	B	H	Box	*€/Stück *€/piece
85252140	140	100	120	1	16,00

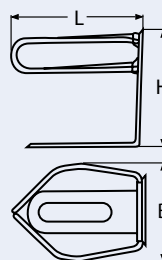

Schwanenhals / A4-AISI 316

Gooseneck / Passe-câble

8599

Bestell-Nr. Order no.	D	D1	D2	B	Box	*€/Stück *€/piece
85994195	19,5	51	114	150	1	15,00
8599438	38	78	120	150	1	52,00

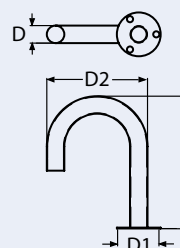

8



Windhutze / A4-AISI 316
 Vent / Manche à air

814217

Bestell-Nr. Order no.	H	L	D	H1	Box	*€/Stück *€/piece
8142174105	105	190	125	70	1	125,00

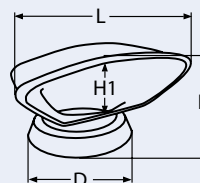

Inspektionsflansch mit Deckel / A4-AISI 316
 Inspection port / Obturateur

8556

Bestell-Nr. Order no.	Aussen-Ø Outside-Ø	Innen-Ø Inside-Ø	Box	*€/Stück *€/piece
85564100	140	100	1	70,00
85564SCHLÜSSEL	Schlüssel / Key		1	9,00

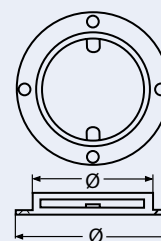

NEW

Inspektionsflansch mit Deckel / A4-AISI 316
 Inspection port / Obturateur avec bouchon

814653

Bestell-Nr. Order no.	Aussen-Ø Outside-Ø	Innen-Ø Inside-Ø	Box	*€/Stück *€/piece
8146534130	175	130	1	125,00

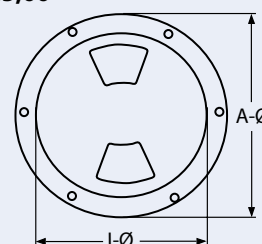

8

NEW

Inspektionsflansch mit Deckel / Plastik
 Inspection port plastic / Obturateur avec bouchon en plastic

814681

Bestell-Nr. Order no.	Aussen-Ø Outside-Ø	Innen-Ø Inside-Ø	Farbe Colour	Box	*€/Stück *€/piece
8146813146W	146	105	Weiß / White	1	8,00
8146813146B	146	105	Schwarz / Black	1	8,00
8146813175W	17	140	Weiß / White	1	9,00
8146813175B	175	140	Schwarz / Black	1	9,00
8146813205W	205	150	Weiß / White	1	10,00
8146813205B	205	150	Schwarz / Black	1	10,00

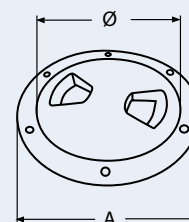

- Mit Bajonettverschluss
- With one-click lock

8370

Kiemenblech / A4-AISI 316

Vent / Grille d'aération

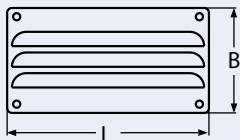

Bestell-Nr. Order no.	L	B	Box	*€/Stück *€/piece
83704127_66	127	66	1	4,50

8371

Kiemenblech / A4-AISI 316

Vent / Grille d'aération

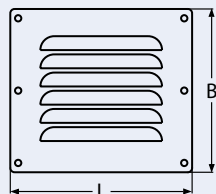

Bestell-Nr. Order no.	L	B	Box	*€/Stück *€/piece
83714127_115	127	115	1	7,00

8372

Kiemenblech / A4-AISI 316

Vent / Grille d'aération

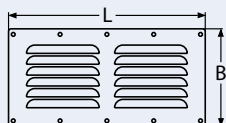

Bestell-Nr. Order no.	L	B	Box	*€/Stück *€/piece
83724230_115	230	115	1	9,50

8373

Kiemenblech / A4-AISI 316

Vent / Grille d'aération

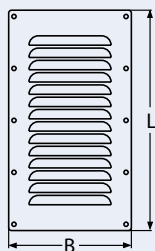

Bestell-Nr. Order no.	L	B	Box	*€/Stück *€/piece
83734228_127	228	127	1	11,20

Yachtzubehör, Ausrüstung und Spezielles

Yachting accessories, equipment and highlights
 Equipement et accessoires exclusifs pour yachts

8

Kiemenblech / A4-AISI 316

Round transom vent / Grille d'aération

8374

Bestell-Nr. Order no.	Ø	Box	*€/Stück *€/piece
83744100	100	1	5,70
83744153	153	1	12,00

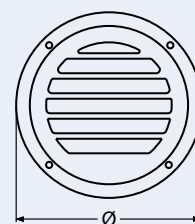

Lüftungsgitter / A2-AISI 304

Ventilation grid / Grille d'aération

814225

Bestell-Nr. Order no.	L	B	Box	*€/Stück *€/piece
8142252212	212	57	1	5,00

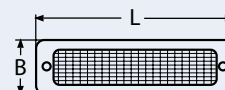

Lüftungsblech / A4-AISI 316

Vent / Grille d'aération

814073

Bestell-Nr. Order no.	Schlitze Slots	L	B	H	Box	*€/Stück *€/piece
814073406	6	327	76	32	5	25,20
814073407	7	378	76	32	5	28,00
814073408	8	427	76	32	5	30,00
814073410	10	527	76	32	5	36,50

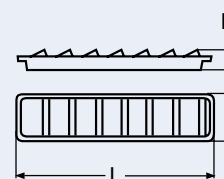

Lüftungsblech / A4-AISI 316

Vent / Grille d'aération

814074

Bestell-Nr. Order no.	Schlitze Slots	L	B	H	Box	*€/Stück *€/piece
814074404	4	206	113	38	5	23,00
814074406	6	327	113	38	5	27,50
814074410	10	528	113	38	5	43,00

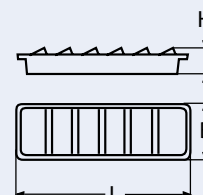

8

8342

Deckslüfter mit Edelstahlkappe / A2-AISI 304

Dome vent / Aérateur de pont

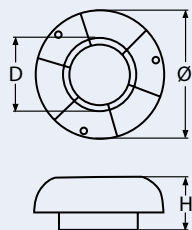

Bestell-Nr. Order no.	Durchlass (D) Outlet (D)	Gesamt-Ø Total-Ø	H	Box	*€/Stück *€/piece
83422100	100	200	55	1	48,00

8713

Deckslüfter mit Edelstahlkappe / A2-AISI 304

Dome vent / Aérateur de pont

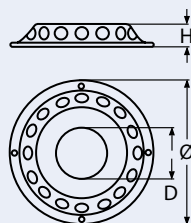

Bestell-Nr. Order no.	Durchlass (D) Outlet (D)	Gesamt-Ø Total-Ø	H	Box	*€/Stück *€/piece
87132225	90	225	30	1	44,00

8657

Lüfter mit Haube / A2-AISI 304

Flanged cowl ventilator / Aérateur scirocco

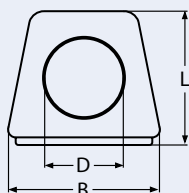

Bestell-Nr. Order no.	L	B	D	Box	*€/Stück *€/piece
86572125	125	145	76	1	35,00

8701

Deckslüfter / A2-AISI 304

Dome vent / Aérateur avec fermeture

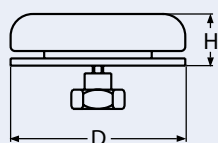

Bestell-Nr. Order no.	Lüftung-Ø Ventilation-Ø	Außen-Ø (D) Outside-Ø (D)	H	Box	*€/Stück *€/piece
87012075	75	115	35	1	100,00
87012100	100	150	35	1	110,00

Yachtzubehör, Ausrüstung und Spezielles

Yachting accessories, equipment and highlights
 Equipement et accessoires exclusifs pour yachts

8

Solar Deckslüfter / A2-AISI 304

Solar dome vent / VMC solaire

814047

Bestell-Nr. Order no.	Ø	Box	*€/Stück *€/piece
8140472210	210	1	140,00

Inkl. Akku und 2 Ventilatorenblätter (1 x zum Ansaugen und 1 x zum Absaugen der Luft).
 Incl. accumulator and 2 propeller (1 for intake and 1 for exhaust of air).

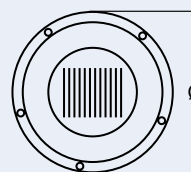

Rundlüfter, verschliessbar / A4-AISI 316

Round vent, lockable / Grille papillon ouverture réglable

8375

Bestell-Nr. Order no.	Ø	Box	*€/Stück *€/piece
83754100	100	1	13,25
83754125	125	1	14,50

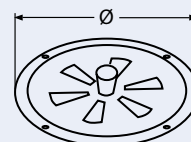

Minilenzer / A2-AISI 304

Vent / Event

8345

Bestell-Nr. Order no.	L	B	H	Box	*€/Stück *€/piece
8345240_44_12	40	44	12	1	1,30
8345255_53_16	55	53	16	1	2,00

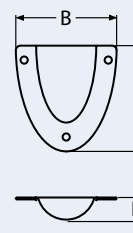

8

Tankentlüfter, 90° / A4-AISI 316

Flush tank vent, 90° / Aération pour réservoir

8894

Bestell-Nr. Order no.	A	B	C	D	E	F	Box	*€/Stück *€/piece
8894416	16	70	35	46	29	75	1	34,00
8894419	19	75	38	49	29	80	1	35,00

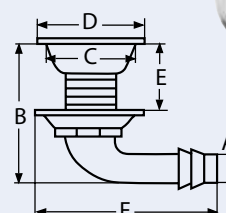

8895

Tankentlüfter / A4-AISI 316

Flush tank vent / Aération pour réservoir

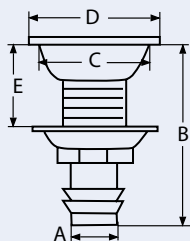

Bestell-Nr. Order no.	A	B	C	D	E	Box	*€/Stück *€/piece
8895416	16	76	35	46	29	1	22,50
8895419	19	77,5	38	49	29	1	31,00

8861

Tankentlüfter, 90° / A4-AISI 316

Tank vent, 90° / Aération pour réservoir 90°

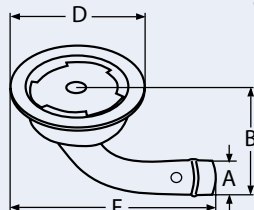

Bestell-Nr. Order no.	A	B	D	F	Box	*€/Stück *€/piece
8861450	19	56	65	95	1	17,00

8319

Tankentlüfter, 90° / A4-AISI 316

Tank vent, 90° / Reniflard coudé

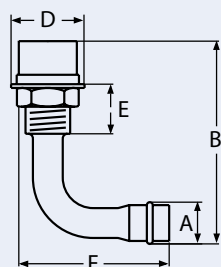

Bestell-Nr. Order no.	A	B	D	E	F	Box	*€/Stück *€/piece
8319416	16	85	31	25	60	1	23,00
8319419	19	105	33	27	80	1	25,00

8320

Tankentlüfter / A4-AISI 316

Tank vent / Reniflard droit gaz-oil

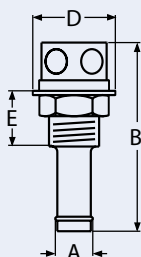

Bestell-Nr. Order no.	A	B	D	E	Box	*€/Stück *€/piece
8320416	16	70	31	25	1	14,00
8320419	19	76	35	27	1	24,00

NEW

Tankentlüfter / Plastik

Tank vent / Event nylon pour tuyau Ø int/ 16mm

814719

Bestell-Nr. Order no.	A	B	D	Box	*€/Stück *€/piece
814719316	16	70	30	5	8,10

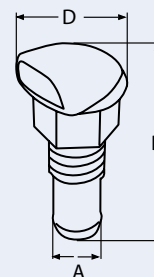

NEW

Tankentlüfter / Plastik

Tank vent / Event nylon pour tuyau Ø int/ 16mm

814720

Bestell-Nr. Order no.	A	B	D	Box	*€/Stück *€/piece
814720316	16	75	33	5	8,10

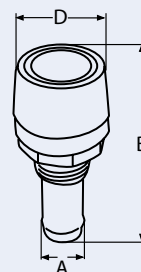

Auspuffdurchlass mit Klappe, 25° / A4-AISI 316

Exhaust thru hull with flap, 25° / Passe-coque d'échappement avec clapet angle de 25°

814063

Bestell-Nr. Order no.	A	B	C	D	E	Box	*€/Stück *€/piece
814063450	50	152	57	80	33	1	116,00

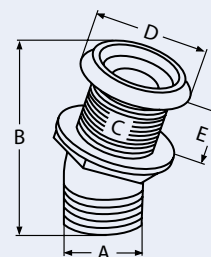

Auspuffdurchlass mit Klappe / A4-AISI 316

Exhaust thru hull with flap / Passe-coque d'échappement avec clapet

814062

Bestell-Nr. Order no.	A	B	C	D	E	Box	*€/Stück *€/piece
814062450	50	138	57	80	33	1	103,50

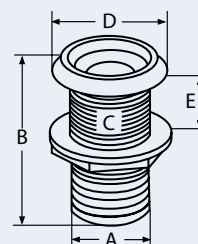

8836

Einfüllstutzen mit Deckelentlüftung / A4-AISI 316

Vented deck fill / Nable de pont avec aération

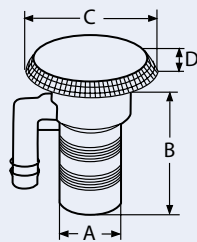

Bestell-Nr. Order no.	Zoll Inch	Für For	A	B	C	D	Box	*€/Stück *€/piece
88364WATER1_12	1 1/2	Wasser/Water	38	93	79,5	12,5	1	61,00
88364DIESEL1_12	1 1/2	Diesel/Diesel	38	93	79,5	12,5	1	61,00
88364GAS1_12	1 1/2	Benzin/Gas	38	93	79,5	12,5	1	61,00
88364WASTE1_12	1 1/2	Abwasser/Waste	38	93	79,5	12,5	1	61,00
88364DIESEL2	2	Diesel/Diesel	50	114	79,5	12,5	1	47,00
88364GAS2	2	Benzin/Gas	50	114	79,5	12,5	1	79,00

8837

30° Einfüllstutzen mit Deckelentlüftung / A4-AISI 316

30° stalon vented deck fill / Nable de pont avec aération

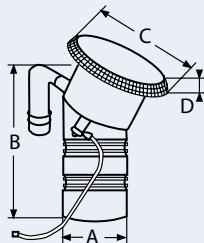

Bestell-Nr. Order no.	Zoll Inch	Für For	A	B	C	D	Box	*€/Stück *€/piece
88374WATER1_12	1 1/2	Wasser/Water	38	98	79,5	12,5	1	52,00
88374DIESEL1_12	1 1/2	Diesel/Diesel	38	98	79,5	12,5	1	52,00
88374GAS1_12	1 1/2	Benzin/Gas	38	98	79,5	12,5	1	52,00
88374WASTE1_12	1 1/2	Abwasser/Waste	38	98	79,5	12,5	1	52,00

8314

Einfüllstutzen mit Deckel, Kette und Schlüssel / A4-AISI 316

Hose deck fills with key / Nable de pont embout cannelé

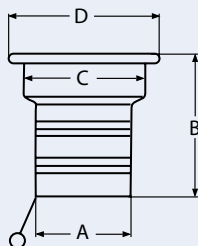

Bestell-Nr. Order no.	Zoll Inch	Für For	A	B	C	D	Box	*€/Stück *€/piece
83144DIESEL1_12	1 1/2	Diesel/Diesel	38	76	45	76	1	33,00
83144WATER1_12	1 1/2	Wasser/Water	38	76	45	76	1	33,00
83144GAS1_12	1 1/2	Benzin/Gas	38	76	45	76	1	33,00
83144WASTE1_12	1 1/2	Abwasser/Waste	38	76	45	76	1	33,00
83144GAS2	2	Benzin/Gas	50	76	54	84	1	47,00
83144DIESEL2	2	Diesel/Diesel	50	76	54	84	1	47,00

Abwasser/Waste = ohne Kette/without chain

83144SCHLUESSEL	Ersatzschlüssel/Replacement key							3,00
83144ERSATZ_D-G-W	Deckel + Kette Lid + chain	1 1/2		Diesel/Wasser/Gas Diesel/Water/Gas				12,00
83144ERSATZ_WASTE	Deckel/Lid	1 1/2		Abwasser/Waste				12,00
83144ERSATZ_D-G	Deckel o. Kette Lid without chain	2		Benzin + Diesel Gas + Diesel				12,00

Einfüllstutzen, Pop up / A4-AISI 316
 Hose deck fills, pop up / Nable de pont

8673

Bestell-Nr. Order no.	Zoll Inch	Für For	A	B	C	D	Box	*€/Stück *€/piece
86734DIESEL1_12	1 1/2	Diesel	38	102	54	84	1	90,00
86734WATER1_12	1 1/2	Water	38	102	54	84	1	90,00
86734GAS1_12	1 1/2	Gas	38	102	54	84	1	90,00
86734WASTE1_12	1 1/2	Waste	38	102	54	84	1	90,00
86734WATER2	2	Water	50	102	54	84	1	90,00
86734GAS2	2	Gas	50	102	54	84	1	90,00
86734DIESEL2	2	Diesel	50	102	54	84	1	90,00

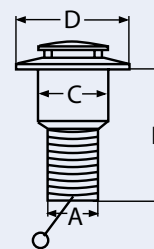

Einfüllstutzen, Pop up, mit Schloss / A4-AISI 316
 Hose deck fill, pop up - with lock / Nable de pont avec serrure

814058

Bestell-Nr. Order no.	Zoll Inch	Für For	A	B	C	D	Box	*€/Stück *€/piece
8140584D1_12	1 1/2	Diesel	38	76	45	76	1	85,00
8140584W1_12	1 1/2	Water	38	76	45	76	1	85,00
8140584G1_12	1 1/2	Gas	38	76	45	76	1	85,00
8140584WS1_12	1 1/2	Waste	38	76	45	76	1	85,00
8140584D2	2	Diesel	50	76	54	84	1	95,00
8140584W2	2	Water	50	76	54	84	1	95,00
8140584G2	2	Gas	50	76	54	84	1	95,00
814058SCHLUESSEL	Ersatzschlüssel / Replacement key						1	6,50

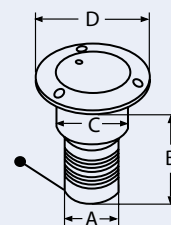

Wasserablauf / A4-AISI 316
 Drain grate pipe thread / Bouloire

8835

Bestell-Nr. Order no.	Gewinde Thread	B	C	Box	*€/Stück *€/piece
883541	1	50	45	1	34,00
883541_12	1 1/2	50	75	1	46,00

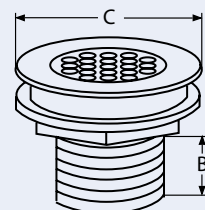

8

Wasserablauf mit Schlauchanschluss / A4-AISI 316
 Deck drain scupper with hose connection / Bombe d'évacuation avec raccord de tuyau

814061

Bestell-Nr. Order no.	A	B	C	D	Box	*€/Stück *€/piece
814061438_57	38	57	79	91	1	100,00
814061450_73	50	73	104	108	1	120,00
814061SCHLUESSEL	Schlüssel / Key				1	6,80

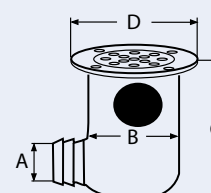

8

Yachtzubehör, Ausrüstung und Spezielles Yachting accessories, equipment and highlights Equipement et accessoires exclusifs pour yachts

814107

Wasserauslass / A4-AISI 316
Water outlet / Evacuation d'eau

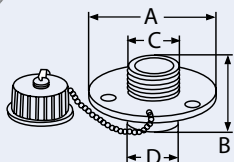

Bestell-Nr. Order no.	A	B	C	D	Box	*€/Stück *€/piece
814107470	70	35	27	26	1	38,50

814108

Wassereinlass / A4-AISI 316
Water inlet / Arrivée d'eau

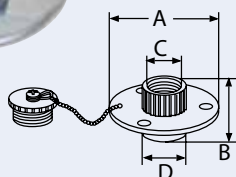

Bestell-Nr. Order no.	A	B	C	D	Box	*€/Stück *€/piece
814108470	70	35	24	26	1	53,00

814121

Cockpitdurchlass / A4-AISI 316
Cockpit drain scupper / Dalot de cockpit

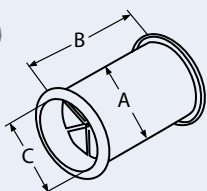

Bestell-Nr. Order no.	A	B	C	Box	*€/Stück *€/piece
814121476	76	102	70	1	35,00

814687

Handpumpe für Bilge / Messing
Manual bilge pump / Pompe à main

NEW

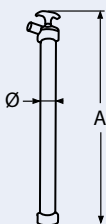

Bestell-Nr. Order no.	A	Ø	Box	*€/Stück *€/piece
8146875380	380	32	1	55,00

Yachtzubehör, Ausrüstung und Spezielles

Yachting accessories, equipment and highlights
 Equipement et accessoires exclusifs pour yachts

8

Handpumpe für Öl / Messing

Hand pump for oil - brass / Pompe à main pour laiton

8833

Bestell-Nr. Order no.	Schlauch Hose	A	Ø	Box	*€/Stück *€/piece
88335225	6 - 8 - 12	225	32	5	31,00

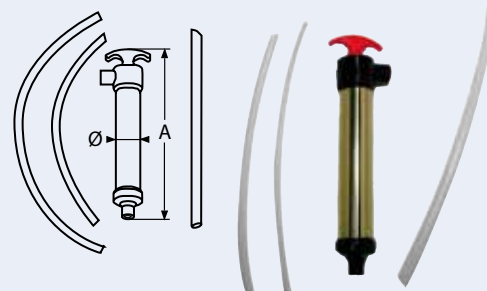

Angelrutenhalter / A4-AISI 316

Fishing rod holder / Porte canne orientable

8421

Bestell-Nr. Order no.	Für Rohr-Ø For tube-Ø	D	L	Box	*€/Stück *€/piece
8421422-25	22 - 25	40	230	1	53,00

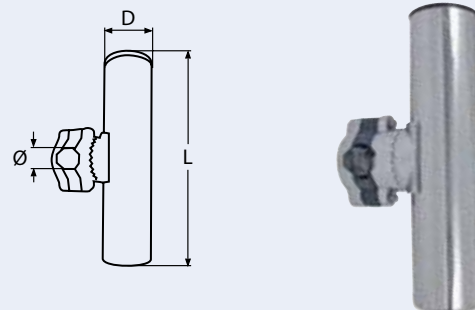

Angelrutenhalter mit Gummikappe / A2-AISI 304

Fishing rod holder with rubber cap / Porte canne fixe avec bouchon

8550

Bestell-Nr. Order no.	L	A	B	D	Box	*€/Stück *€/piece
85502245	245	115	90	50	1	24,50

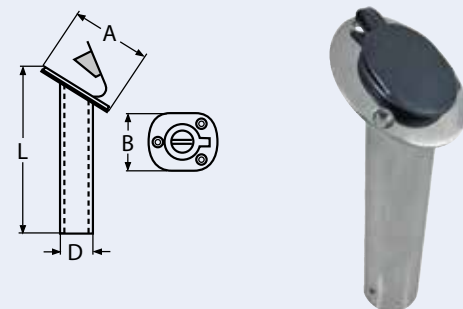

Angelrutenhalter, abnehmbar / A2-AISI 304

Fishing rod holder, removable / Porte canne amovible

8718

Bestell-Nr. Order no.	D	L	Grundplatte Groundplate	Box	*€/Stück *€/piece
8718250	50	240	93 x 100	1	46,50

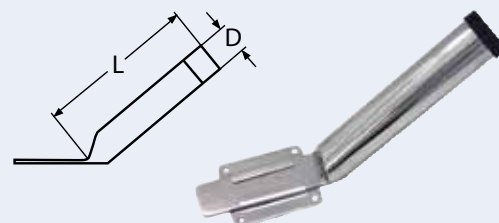

8

814054

Angelrutenhalter

Rod storage rack / Support de tube



Bestell-Nr. Order no.	Montage Mounting	L	B	Box	*€/Stück *€/piece
8140543340 130Vertical	Vertical	340	130	5	13,30
8140543340 130Horizontal	Horizontal	340	130	5	13,30

8330

Antennenhalter mit 2 mm-EPDM-Dichtung, Schrauben, Stopfmutter und Unterlegscheibe / A4-AISI 316

Antenna base with 2 mm-EPDM-sealing (sea water resistant), screws, nut and washer / **

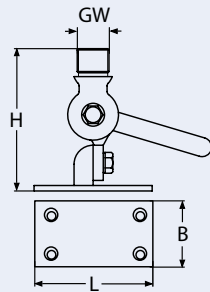

Bestell-Nr. Order no.	L	B	H	GW	Box	*€/Stück *€/piece
8330492_64	92	64	108	3/4"	1	60,00

**Support d'antenne inclinable

8332

Antennenhalter für Relingsbefestigung / A4-AISI 316

Antenna base for rail fixing / Support d'antenne pour tube

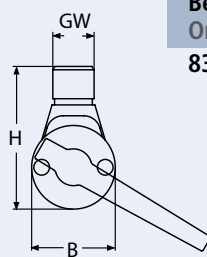

Bestell-Nr. Order no.	Für Rohr For tube	B	H	GW	Box	*€/Stück *€/piece
8332422/25	22 - 25	50	85	3/4"	1	35,50

814113

Antennenhalter für Relingsbefestigung / A2-AISI 304

Antenna base for rail fixing / Support d'antenne pour rail

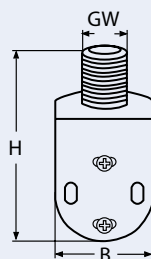

Bestell-Nr. Order no.	Für Rohr For tube	H	B	GW	Box	*€/Stück *€/piece
8141132225	22 - 25	89	50	3/4"	5	16,00

Yachtzubehör, Ausrüstung und Spezielles

Yachting accessories, equipment and highlights
 Equipement et accessoires exclusifs pour yachts

8

Maststufe / A4-AISI 316

Mast step / Marchepied pliant

8244

Bestell-Nr. Order no.	L	B1	H	B	Box	*€/Stück *€/piece
82444108_53	110	55	117	50	1	44,00

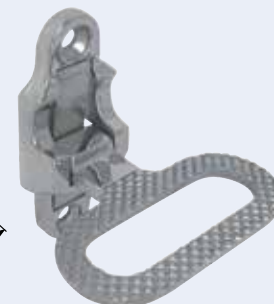
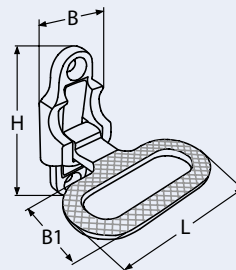

Antirutschplatte / A4-AISI 316

Anti-slip step plate / Panneau antidérapant

814109

Bestell-Nr. Order no.	A	B	S	Box	*€/Stück *€/piece
8141094180	180	40	3,5	2	22,00

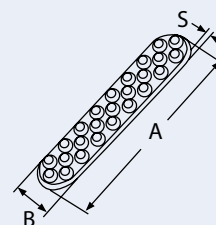

Radar Reflektor / Alu

Radar reflector / Réflecteur radar en alu

814149

Bestell-Nr. Order no.	Ø	Box	*€/Stück *€/piece
814149029	290	5	22,00
814149041	410	5	34,00
814149047	470	5	64,00



Radar Reflektor

Radar reflector / Feu de radar

814295

Bestell-Nr. Order no.	L	Ø	Box	*€/Stück *€/piece
8142953500_50	500	50	1	30,00

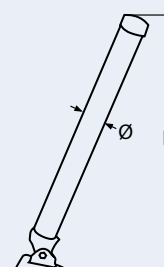

8

814296

Signalball / Plastik

Signal ball / Marque de signalisation boule noire

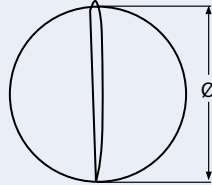

Bestell-Nr. Order no.	Ø	Box	*€/Stück *€/piece
8142963300	300	1	8,80
8142963350	350	1	8,80

814297

Signalkegel / Plastik

Signal cone / Marque de signalisation cône noir

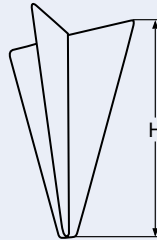

Bestell-Nr. Order no.	H	Box	*€/Stück *€/piece
8142973470	470	1	8,00

8351

Aufsteller / A2-AISI 304

Hatch adjuster / Compas d'ouverture réglable

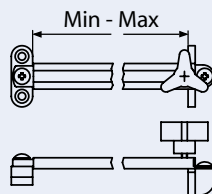

Bestell-Nr. Order no.	Min. - Max.	Box	*€/Stück *€/piece
83512200_366	200 - 366	1	16,00
83512260_484	260 - 484	1	19,50

8610

Tischplattenhalter / A2-AISI 304

Table bracket / Support de table

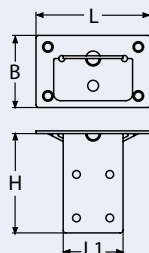

Bestell-Nr. Order no.	L	L1	B	H	Box	*€/Stück *€/piece
8610255_85	85	45	55	75	1	21,00

Tischplattenhalterung, klappbar / A2-AISI 304
 Folding table bracket / Compas d'ouverture en inox

8522

Bestell-Nr. Order no.	B	H	Box	*€/Stück *€/piece
85222165_305	165	305	1	26,00

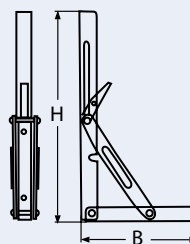

NEW

Tischbein mit Füßen / Aluminium eloxiert, silber
 Table leg with bases alu anodized silver / Pied de table alu anodisé argent

814649

Bestell-Nr. Order no.	L	Ø1	Ø2	Rohr-Ø Tube-Ø	Box	*€/Stück *€/piece
8146490600	600	160	170	55	1	57,00
8146490700	700	160	170	55	1	60,00

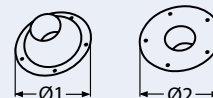
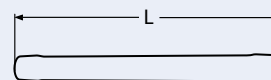
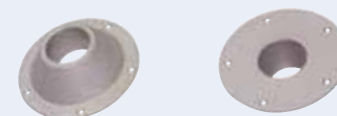
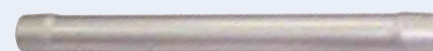

Türstopper / A2-AISI 304
 Door stopper / Bloquer de porte

8477

Bestell-Nr. Order no.	L	D	Box	*€/Stück *€/piece
8477260	60	50	1	30,50

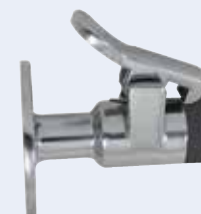
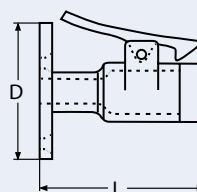

Türstopper / A4-AISI 316
 Door stopper / Bloqueur de porte

814099

Bestell-Nr. Order no.	L	Box	*€/Stück *€/piece
814099470	70	5	16,00

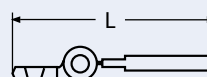



Yachtzubehör, Ausrüstung und Spezielles

Yachting accessories, equipment and highlights
 Equipement et accessoires exclusifs pour yachts

8

Allzweckpuffer / A4-AISI 316

Allround buffer / Butoir inox

8520

Bestell-Nr. Order no.	D	H	Box	*€/Stück *€/piece
8520448	48	18	1	8,30

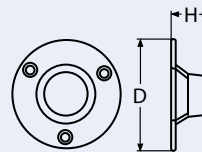

Außenborderhalterung / A2-AISI 304

Motor bracket / Chaise inox relevable pour moteur

8706

Bestell-Nr. Order no.	PS max. HP max.	L	A	B	C	D	Box	*€/Stück *€/piece
8706220	20	520	260	210	190	160	1	267,00

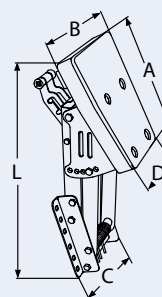

Außenborderhalterung mit Holzplatte / A2-AISI 304

Motor bracket with wood plate / Fixation pour moteur

8934

Bestell-Nr. Order no.	PS max. HP max.	L	A	B	C	Box	*€/Stück *€/piece
8934210	10	450	245	180	115	1	135,00

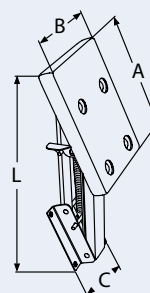

Außenborderhalterung mit Kunststoffplatte / A2-AISI 304

Motor bracket with plastic plate / Support moteur réglable, Support en inox, Plaque en plastique

814596

Bestell-Nr. Order no.	PS max. HP max.	L	A	B	C	E	Box	*€/Stück *€/piece
814596210	10	490	265	208	110	160	1	120,00

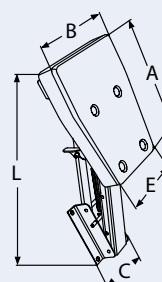

8

8

Yachtzubehör, Ausrüstung und Spezielles Yachting accessories, equipment and highlights Equipement et accessoires exclusifs pour yachts

814224

Außenborderschloss / A4-AISI 316
Outboard lock / Antivol

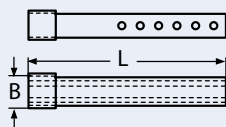

Bestell-Nr. Order no.	L	B	Box	*€/Stück *€/piece
8142244320	300	40	1	23,80

8554

Außenborderschloss / A4-AISI 316
Outboard lock / Antivol pour moteur

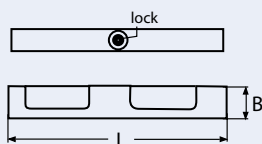

Bestell-Nr. Order no.	L	B	Box	*€/Stück *€/piece
85544270	300	35	1	72,00

8591

Schloss mit Schlüssel / A2-AISI 304
Lock with key / Serrure avec clés

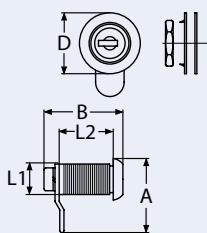

Bestell-Nr. Order no.	A	B	D	L1	L2	Box	*€/Stück *€/piece
8591240	40	42	33	18	29	5	16,30

814093

Schlüsselanhänger, schwimmfähig
Key chain, floating / Porte-clé, flottante



Bestell-Nr. Order no.	Box	*€/Stück *€/piece
8140933000	10	5,80

Yachtzubehör, Ausrüstung und Spezielles

Yachting accessories, equipment and highlights
 Equipement et accessoires exclusifs pour yachts

8

Diskus-Schloss / A2-AISI 304

Discus padlock / Cadenas inox

8498

Bestell-Nr. Order no.	A	B	C	D	Box	*€/Stück *€/piece
8498270	70	17,5	23	9,5	5	16,00

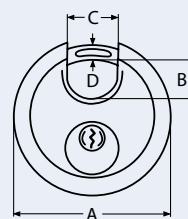

Marine Vorhängeschloss, Messing, verchromt; Bügel: A4-AISI 316, Innenteile: Messing-vernickelt

Marine padlock, brass, chrome-plated shackle, AISI 316, inside: brass, nickle-plated / **

8500

Bestell-Nr. Order no.	A	B	C	D	E	F	Box	*€/Stück *€/piece
8500730	30	27,3	17,0	4,8	15,8	12,7	5	16,30
8500740	40	33,0	23,8	6,4	22,6	14,2	5	19,50
8500750	50	40,3	27,9	7,9	29,5	16,5	5	27,50

Achtung: 1.000 Std. Seewassersprühtest bestanden
 please note: passed 1000h seawater spray test

** Cadenas, anse d'accrochage en laiton chromé plaqué,
 étrier: AISI 316 Intérieur en laiton nickelé plaqué

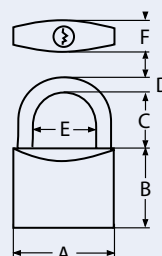

NEW

Vorhängeschloss mit langem Bügel, Körper aus Messing, Bügel aus Edelstahl

Pad lock with long bow body made of brass bow made of stainless steel / Cadenas pour Art. 814224

814651

Bestell-Nr. Order no.	A	B	C	D	E	Box	*€/Stück *€/piece
814651539 32	39	32	45	6	21	3	16,00

Für Außenboarderschloß Artikel 814224
 For outboard lock article 814224

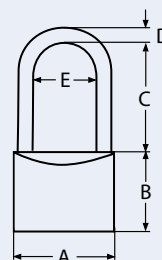

8

Türschloss, magnetisch / A4-AISI 316

Magnetic door latch / Verrou magnétique pour porte

8828

Bestell-Nr. Order no.	A	B	C	D	Türstärke Door size	Box	*€/Stück *€/piece
8828419_25	62	75	92	70	19 - 25	1	130,00
8828428_34	62	75	92	70	28 - 34	1	130,00

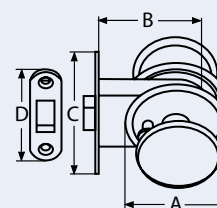

21

27

24

26

27



Yachtzubehör, Ausrüstung und Spezielles

Yachting accessories, equipment and highlights
 Equipement et accessoires exclusifs pour yachts

8

Druckknopfschloss / Kunststoff

Pushlock, plastic / Serrure à bouton-poussoir, en plastique

814187

Bestell-Nr. Order no.	Farbe Colour	L	B	H	Box	*€/Stück *€/piece
8141873S	Silber / Silver	53	44	19,9	1	19,00
8141873G	Gold / Gold	53	44	19,9	1	25,00

Für Türstärken max. 16 mm incl. Schliessblech (für 3,0 mm Schrauben)
 For door thickness max. 16 mm incl. strike plate (for 3.0 mm screws)

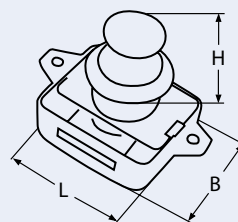

Harpunenspitze, Dreieck / A4-AISI 316

Triple fishhook / Embout d'harpon trident

8479

Bestell-Nr. Order no.	GW	L	Box	*€/Stück *€/piece
847946	M6	110	5	9,90

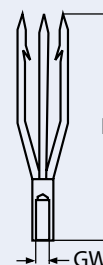

Harpunenspitze, Dreizack / A4-AISI 316

Triple fishhook / Embout d'harpon trident

8480

Bestell-Nr. Order no.	GW	L	Box	*€/Stück *€/piece
848046	M6	125	5	12,50

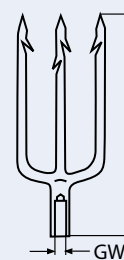

Ruckdämpfer / Kautschuk

Mooring spring, rubber / Ressort de mouillage en caoutchouc

814156

Bestell-Nr. Order no.	Für Seil-Ø For rope-Ø	L	Box	*€/Stück *€/piece
814156306	6 - 12	440	1	23,50
814156314	14 - 18	500	1	29,50
814156320	20 - 22	540	1	43,00



8

8377

Ruckdämpfer / A2-AISI 304

Mooring spring / Ressort de mouillage

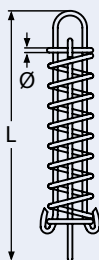

Bestell-Nr. Order no.	Draht-Ø Wire-Ø	L	Box	*€/Stück *€/piece
8377205_270	5	270	1	16,40
8377206_335	6	335	1	20,40
8377206_370	6	370	1	25,60
8377211_400	11	400	1	98,00

814208

Ruckdämpfer / A2-AISI 304

Mooring spring / Ressort de mouillage

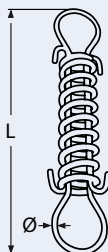

Bestell-Nr. Order no.	Draht-Ø Wire-Ø	L	Box	*€/Stück *€/piece
814208235_200	3,5	180	1	16,00

814702

Gasdruckfeder / A4-AISI 316

Gas spring / Ressort à gaz

NEW



Made in Germany

Bestell-Nr. Order no.	A	B	C	D	E	F	Box	*€/Stück *€/piece
81470240450	6	15	150	355	M5	450 N	1	110,00
81470240750	8	19	200	470	M8	750 N	1	136,00
814702401100	10	23	300	637	M8	1100 N	1	170,00

A = Kolben Ø / Piston Ø
 B = Zylinder Ø / Cylinder Ø
 C = Hub / Lift
 D = Länge / Length
 E = Gewinde / Thread
 F = Max. Kraft / Max. Force

Angegebene Kraft (in Newton) ist die Maximalbefüllung der Feder.
 Bitte bei Bestellung Kraft in Newton oder Gewicht der Luke mit angeben,
 um richtige Befüllung für Sie zu bestimmen.
 Federn werden dann auf Kundenwunsch befüllt.

The specified force (in Newtons) is the maximum inflation of the spring.
 Please specify the force in Newtons or the weight of the hatch when
 ordering so we can determine the proper inflation.
 Springs are then inflated according to the customer's needs.

NEW

Auge für Gasdruckfeder / A4-AISI 316
 Eye for gas spring / Embout à œil pour ressort à gaz

814705

Bestell-Nr. Order no.	L	B	Auge Ø/ Eye Ø	GW	Für Art. For Art.	Box	*€/Stück *€/piece
814705405	21	10	6,1	M5	81470240450	1	10,20
814705408	26	14	8,1	M8	81470240750 81470241100	1	16,80

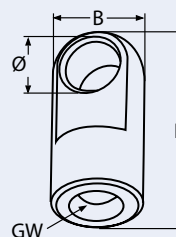

Made in Germany

NEW

Winkelgelenk für Gasdruckfeder / A4-AISI 316
 Angle joint for gas spring / Angle articulé pour ressort à gaz

814706

Bestell-Nr. Order no.	L	B	GW	Für Art. For Art.	Box	*€/Stück *€/piece
814706405	25	29	M5	81470240450	1	63,90
814706408	38	40	M8	81470240750/ 81470241100	1	83,90

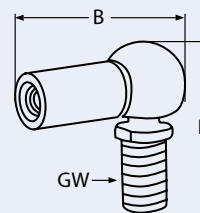

Made in Germany

NEW

Befestigungsbeschlag für Gasdruckfeder / A4-AISI 316
 Mounting hinge for gas spring / Chape pour ressort à gaz

814707

Bestell-Nr. Order no.	L	H	B	Für Art. For Art.	Box	*€/Stück *€/piece
814707470	70	30	18	814705408	1	52,30
814707495	95	28	18	814705408	1	52,70

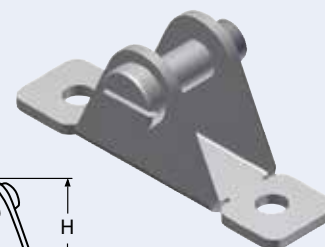
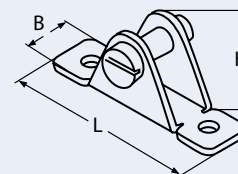

Made in Germany

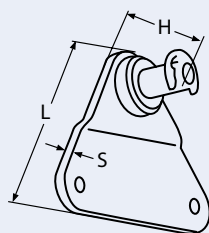
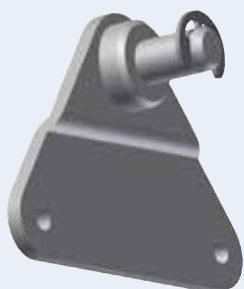
814708
Befestigungsbeschlag für Gasdruckfeder / A4-AISI 316
 Mounting hinge for gas spring / Platine pour ressort à gaz
NEW

Bestell-Nr. Order no.	L	H	S	Für Art. For Art.	Box	*€/Stück *€/piece
814708447	47	21	3	814705408	1	31,00

Made in Germany

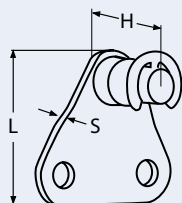
814709
Befestigungsbeschlag für Gasdruckfeder / A4-AISI 316
 Mounting hinge for gas spring / Platine pour ressort à gaz
NEW

Bestell-Nr. Order no.	L	H	S	Für Art. For Art.	Box	*€/Stück *€/piece
814709426	26	13	3	814705405	1	30,90

Made in Germany

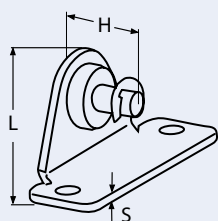
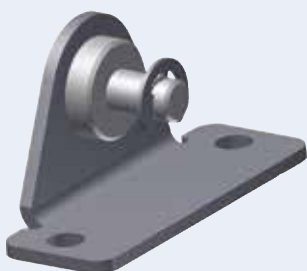
814710
Befestigungsbeschlag für Gasdruckfeder / A4-AISI 316
 Mounting hinge for gas spring / Platine pour ressort à gaz
NEW

Bestell-Nr. Order no.	L	H	S	Für Art. For Art.	Box	*€/Stück *€/piece
814710427	27	18	3	814705408	1	24,60

Made in Germany

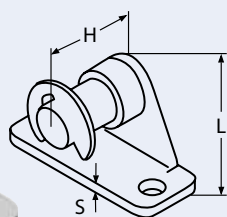
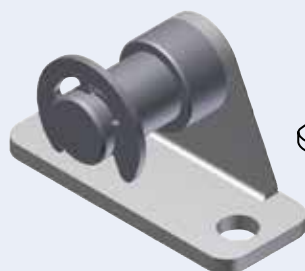
814711
Befestigungsbeschlag für Gasdruckfeder / A4-AISI 316
 Mounting hinge for gas spring / Platine pour ressort à gaz
NEW

Bestell-Nr. Order no.	L	H	S	Für Art. For Art.	Box	*€/Stück *€/piece
814711415	15	13	3	814705405	1	23,80

Made in Germany

Yachtzubehör, Ausrüstung und Spezielles

Yachting accessories, equipment and highlights
 Equipement et accessoires exclusifs pour yachts

8

Abdeckkappe für 220 Volt-Anschluss / A4-AISI 316

Cover for shore socket / Cache prise inox

8441

Bestell-Nr. Order no.	L	L1	B	B1	D	Box	*€/Stück *€/piece
84414115_125	115	81	125	100	5,5	1	25,00

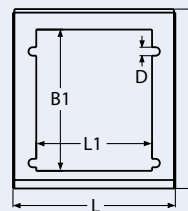

Wasserdichte PVC Tasche

Waterproof bag / Etui en pvc étanche

8704

Bestell-Nr. Order no.	L	B	Box	*€/Stück *€/piece
87043370	370	115	1	11,80



Bootshakenhalter / Nylon

Boat hook holder / Support universel pour bateau

8710

Bestell-Nr. Order no.		D	Rohr-Ø Tube-Ø	Box	*€/Stück *€/piece
87103WAND	Wandbefestigung Wall mounting	22-36	-	1	8,80
87103RELING	Relingsbefestigung Rail mounting	22-36	22-25	1	14,50



Reling / rail

Wand / wall

Dosenhalter / Plastik

Plastic drink holder / Porte verre en plastique

8711

Bestell-Nr. Order no.	Farbe Colour	L	B	H	Box	*€/Stück *€/piece
87113WEISS	Weiß / White	100	105	24	1	6,30
87113SCHWARZ	Schwarz / Black	100	105	24	1	6,30

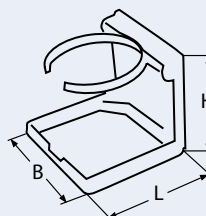

8

814136

Becherhalter mit Edelstahlfront / A2-AISI 304

Cup holder, stainless steel surface / Porte-gobelet à surface en inox

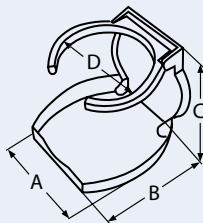

Bestell-Nr. Order no.	Farbe Colour	A	B	C	D	Box	*€/Stück *€/piece
8141362W	Weiß / White	95	93	92	70	2	28,40
8141362B	Schwarz / Black	95	93	92	70	2	26,00

814135

Becher und Flaschenhalter / A2-AISI 304

Cup and bottle holder / Porte-gobelet et bouteille

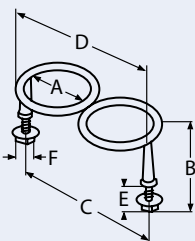

Bestell-Nr. Order no.	Modell Model	A	B	C	D	E	F	Box	*€/Stück *€/piece
81413521	Single	88	100	105	106	51	8	2	24,00
81413522	Double	88	100	205	210	51	8	2	34,80
81413523	Triple	88	100	105	310	51	8	2	44,40

8832

Flaschenhalter / A2-AISI 304

Bottle holder / Support pour bouteilles

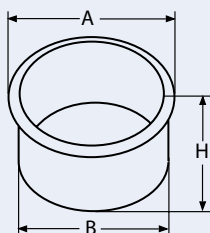

Bestell-Nr. Order no.	A	B	H	Box	*€/Stück *€/piece
88322109	109	95	83	5	24,00

8935

Isolierkanne / Edelstahl

Vacuum flask, stainless steel / Thermos



Bestell-Nr. Order no.	Liter	Box	*€/Stück *€/piece
8935210	1,0	1	31,60
8935215	1,5	1	29,50

Yachtzubehör, Ausrüstung und Spezielles

Yachting accessories, equipment and highlights
 Equipement et accessoires exclusifs pour yachts

8

Isolierflasche / Edelstahl

Vacuum flask, stainless steel / Thermos

8936

Bestell-Nr. Order no.	Liter	Box	*€/Stück *€/piece
8936205	0,5	1	13,00
8936207	0,7	1	19,80
8936210	1,0	1	20,80



Isolierbecher / Edelstahl

Vacuum mug, stainless steel / Mug Thermos

8937

Bestell-Nr. Order no.	Liter	Box	*€/Stück *€/piece
89372035	0,35	1	12,30

Doppelwandig / Double walled



Isolierbecher, hochglanzpoliert / Edelstahl

Vacuum mug, mirror polished, stainless steel / Gobelet Thermos

8938

Bestell-Nr. Order no.	Liter	Box	*€/Stück *€/piece
89382030	0,3	1	10,50

Doppelwandig / Double walled



Isolierbecher mit Deckel / Edelstahl

Vacuum mug with lid, stainless steel / Gobelet Thermos

8939

Bestell-Nr. Order no.	Liter	Box	*€/Stück *€/piece
89392040	0,4	1	12,80

Doppelwandig / Double walled



8

8

Yachtzubehör, Ausrüstung und Spezielles

Yachting accessories, equipment and highlights

Equipement et accessoires exclusifs pour yachts

814597

Isolierter Lebensmittelbehälter 1,5l / Edelstahl

Vacuum food container 1.5 l, stainless steel / Boite alimentaire isotherme



Bestell-Nr. Order no.	Liter	Box	*€/Stück *€/piece
814597215	1,5	1	40,00

8940

Bierkrug, hochglanzpoliert / Edelstahl

Beer mug, mirror polished, stainless steel / Choqe à bière poli briant



Bestell-Nr. Order no.	Liter	Box	*€/Stück *€/piece
89402040	0,4	1	22,50

Doppelwandig / Double walled

8941

Cappuccino Becher, hochglanzpoliert / Edelstahl

Cappuccino cup, mirror polished, stainless steel / Tasse à cappuccino poli briant



Bestell-Nr. Order no.	Liter	Box	*€/Stück *€/piece
89412030	0,3	1	11,80

Doppelwandig / Double walled

814457

Kochtopfset, 7-teilig / Edelstahl

Saucepan set, small, stainless steel / Assortiment de 5 casseroles



Bestell-Nr. Order no.	Box	*€/Stück *€/piece
8144572	1	89,00

Set besteht aus:

- Kochtopf Ø 21,5 cm
- Kochtopf Ø 18,0 cm
- Pfanne Ø 22,0 cm
- Deckel Ø 21,5 cm
- Deckel Ø 18,5 cm
- Sauciere Ø 12,5 cm
- Griff

Set includes:

- Saucepan Ø 21.5 cm
- Saucepan Ø 18.0 cm
- Pan Ø 22.0 cm
- Lid Ø 21.5 cm
- Lid Ø 18.5 cm
- Sauce boat Ø 12.5 cm
- Handle

Yachtzubehör, Ausrüstung und Spezielles

Yachting accessories, equipment and highlights
 Equipement et accessoires exclusifs pour yachts

8

Kochtopfset, 10-teilig / Edelstahl

Saucepan set, big, stainless steel / Assortiment de 10 casseroles

814458

Bestell-Nr. Order no.	Box	*€/Stück *€/piece
8144582	1	138,00

Set besteht aus:

- Kochtopf Ø 23,5 cm
- Kochtopf Ø 19,5 cm
- Kochtopf Ø 17,5 cm
- Pfanne Ø 22,0 cm
- Deckel Ø 23,5 cm
- Deckel Ø 19,5 cm
- Sauciere Ø 12,5 cm
- Nudelsieb Ø 21,0 cm
- Schale
- Griff

Set includes:

- Saucepan Ø 23.5 cm
- Saucepan Ø 19.5 cm
- Saucepan Ø 17.5 cm
- Pan Ø 22.0 cm
- Lid Ø 23.5 cm
- Lid Ø 19.5 cm
- Sauce boat Ø 12.5 cm
- Noodle sieve Ø 21.0 cm
- Bowl
- Handle



Handwaschbecken / A2-AISI 304

Washbasin / Lavabo

8866

Bestell-Nr. Order no.	D	D2	H	Box	*€/Stück *€/piece
88662260	260	52	140	1	89,00

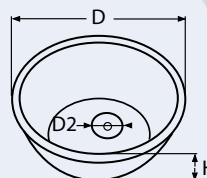

Handwaschbecken, hochglanzpoliert / A2-AISI 304

Washbasin, mirror polished / Lavabo poli

814075

Bestell-Nr. Order no.	D	D1	H	D2	Box	*€/Stück *€/piece
8140752125	290	260	125	62	1	86,30
8140752180	290	260	180	62	1	98,30

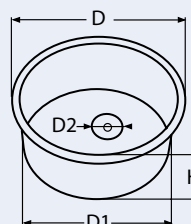

814280

Bootshaken / Alu

Boat hook / Gaffe en alu



Bestell-Nr. Order no.	Farbe Colour	L	Ø	Box	*€/Stück *€/piece
8142800W	Weiß / White	1200 - 2100	30	1	23,50
8142800R	Rot / Red	1200 - 2100	30	1	21,00
8142800B	Blau / Blue	1200 - 2100	30	1	23,30

814281

Bootshaken, Holz mit Edelstahlhaken / A2-AISI 304

Wooden boat hook with stainless steel hook



Bestell-Nr. Order no.	L	Ø	Box	*€/Stück *€/piece
8142812180	1800	28	1	55,00
8142812210	2100	28	1	62,00

8707

Teleskop-Bootshaken / Alu

Telescoping boat hook / Gaffe télescopique alu



Bestell-Nr. Order no.	Ø	L	Box	*€/Stück *€/piece
8707029	29	1175 - 2000	1	26,80

8708

Segelzeising, Gummi-Zeising / A2-AISI 304

Sail ties / Sandow avec crochets

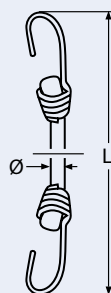

Bestell-Nr. Order no.	Ø	L	Box	*€/Stück *€/piece
870820300	8	300	10	3,50
870820500	8	500	10	3,40
870820800	8	800	10	6,80
870821000	8	1000	10	7,30

Yachtzubehör, Ausrüstung und Spezielles

Yachting accessories, equipment and highlights
 Equipement et accessoires exclusifs pour yachts

8

Lenzstopfen / A4-AISI 316

Drain plug / Bouchon

8700

Bestell-Nr. Order no.	D	D1	A	B	Box	*€/Stück *€/piece
8700426_16	50	20	14	16	1	15,50

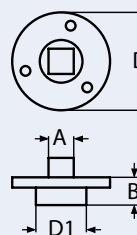

Lenzstopfen / A4-AISI 316

Drain plug / Bouchon

8669

Bestell-Nr. Order no.	A	B	C	Box	*€/Stück *€/piece
8669439	39	25	12	1	17,00

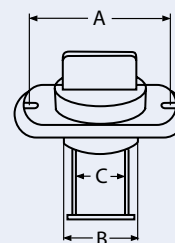

Lenzstopfen / A2-AISI 304

Drain plug / Bouchon pour réservoir

8596

Bestell-Nr. Order no.	D	L	L1	Box	*€/Stück *€/piece
8596225	25	50	33	1	4,70

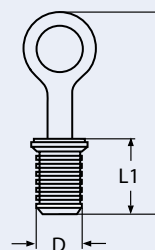

Lenzstopfen / A4-AISI 316

Drain plug / Bouchon

814120

Bestell-Nr. Order no.	A	B	C	Box	*€/Stück *€/piece
814120454	54	24	12	2	18,80
814120464	64	31	19	2	22,50

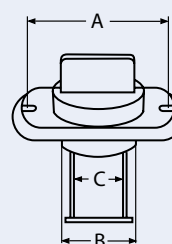

8

8

Yachtzubehör, Ausrüstung und Spezielles

Yachting accessories, equipment and highlights

Equipement et accessoires exclusifs pour yachts

8880

Kielrolle mit Buchse / Gummi

Keel roller with pipe, rubber / Rouleau avec douille en caoutchouc



Bestell-Nr. Order no.	Länge Length	Schaft-Ø Shaft-Ø	Außen-Ø Outside-Ø	Box	*€/Stück *€/piece
88803100	100	13	75	5	3,60
88803130	130	13	75	5	4,90
88803200	190	16	75	5	6,30

8881

Bugrolle mit Buchse / Gummi

Bow roller with pipe, rubber / Rouleau, caoutchouc



Bestell-Nr. Order no.	Länge Length	Schaft-Ø Shaft-Ø	Außen-Ø Outside-Ø	Box	*€/Stück *€/piece
88813075	75	13	75	5	3,80

8882

V-Kielrolle mit Buchse / Gummi

V-Keel roller with pipe, rubber / Rouleau-V avec douille en caoutchouc



Bestell-Nr. Order no.	Länge Length	Schaft-Ø Shaft-Ø	Außen-Ø Outside-Ø	Box	*€/Stück *€/piece
88823200	200	16	80	5	11,00
88823250	250	16	80	5	13,30

8883

Seitenrolle mit Buchse / Gummi

Side guide roller with pipe, rubber / Rouleau avec douille en caoutchouc



Bestell-Nr. Order no.	Länge Length	Schaft-Ø Shaft-Ø	Außen-Ø Outside-Ø	Box	*€/Stück *€/piece
88833100	100	16	62	5	6,80
88833150	150	16	62	5	8,00

Yachtzubehör, Ausrüstung und Spezielles

Yachting accessories, equipment and highlights
 Equipement et accessoires exclusifs pour yachts

8

Bugpuffer / Gummi

Bow guard, rubber / amortisseur proue en caoutchouc

8884

Bestell-Nr. Order no.	Basis Basis	Höhe Height	Box	*€/Stück *€/piece
88843050	50 x 50	50	5	3,50
88843100	100 x 75	80	5	8,50



Bugpuffer / Polyurethan

Bow guard, polyurethan / Arrêt, proue, polymethane

8943

Bestell-Nr. Order no.	Schaft-Ø Shaft-Ø	Länge Length	Box	*€/Stück *€/piece
8943313	12,5	150	2	20,20



Bugrolle / Polyurethan

Bow roller, polyurethan / Davier simple - polymethane

8944

Bestell-Nr. Order no.	Schaft-Ø Shaft-Ø	Länge Length	Box	*€/Stück *€/piece
8944313	13	67	2	19,00



8

Kielrolle / Polyurethan

Keel roller, polyurethan / Quille - polymethane

8945

Bestell-Nr. Order no.	Schaft-Ø Shaft-Ø	Länge Length	Box	*€/Stück *€/piece
8945316	16	95	2	28,00



8

Yachtzubehör, Ausrüstung und Spezielles

Yachting accessories, equipment and highlights

Equipement et accessoires exclusifs pour yachts

8946

Kielrolle / Polyurethan

Keel roller, polyurethan / Rouleau - polymethane



Bestell-Nr. Order no.	Schaft-Ø Shaft-Ø	Länge Length	Box	*€/Stück *€/piece
8946316	16	125	2	25,00

8947

Kielrolle / Polyurethan

Keel roller, polyurethan / Rouleau - polymethane



Bestell-Nr. Order no.	Schaft-Ø Shaft-Ø	Länge Length	Box	*€/Stück *€/piece
8947316	16	190	1	50,00

8847

Frischwasserspüler für Aussenborder

Motor flusher for outboard motor / Appareil de rinçage - extérieur



Bestell-Nr. Order no.	Box	*€/Stück *€/piece
88473	1	9,00

814301

Batterie Box / PVC

Battery box / Bacs à batterie

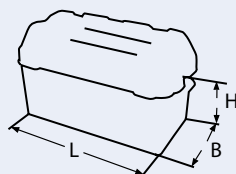
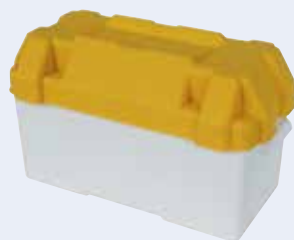

Bestell-Nr. Order no.	L	B	H	Box	*€/Stück *€/piece
8143013410	415	200	200	1	30,00

Yachtzubehör, Ausrüstung und Spezielles

Yachting accessories, equipment and highlights
 Equipement et accessoires exclusifs pour yachts

8

Marine Batteriebox / PVC

Marine battery box, PVC / Batterie marine - PVC

8848

Bestell-Nr. Order no.	L	B	H	Box	*€/Stück *€/piece
88483270	270	180	295	1	16,50
88483330	350	200	295	1	18,50

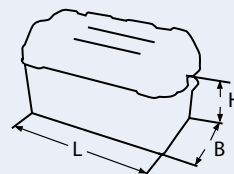

Lichtmast / A2-AISI 304

Mast light tower / Support de lumière pour Mât

814092

Bestell-Nr. Order no.	L	B	H	Box	*€/Stück *€/piece
8140922730	730	350	460	1	100,00

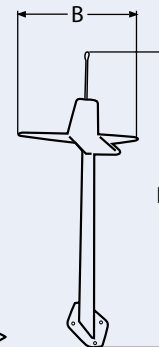
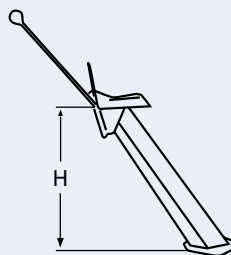

Schleusenhaken / A4-AISI 316

Sluice hook / Crochet

8998

Bestell-Nr. Order no.	L	Ø	Box	*€/Stück *€/piece
89984245_10	245	10	5	9,30

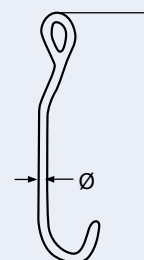

Schleusenhaken / A4-AISI 316

Sluice hook / Crochet d'écluse

814126

Bestell-Nr. Order no.	L	Ø	Box	*€/Stück *€/piece
8141264560_10	560	10	2	25,00

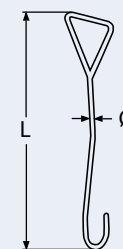

8

8

Yachtzubehör, Ausrüstung und Spezielles Yachting accessories, equipment and highlights Équipement et accessoires exclusifs pour yachts

814127

Bojenhaken / A4-AISI 316
Buoy hook / Crochet de bouée

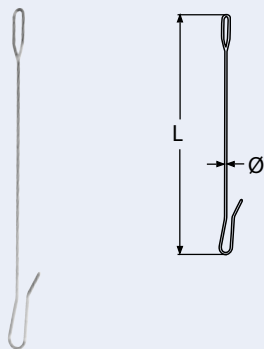

Bestell-Nr. Order no.	L	Ø	Box	*€/Stück *€/piece
8141274116_10	1160	10	2	43,00

814688

Bojenhaken mit Sicherung / A4-AISI 316
Buoy hook with safeguard / Longe de sécurité

NEW

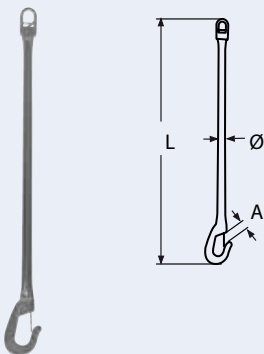

Bestell-Nr. Order no.	A	L	Ø	Box	*€/Stück *€/piece
8146884900	30	900	25	1	90,00
81468841400	40	1400	30	1	135,00

814043

Schleusenhaken mit P.P.-Seil / A4-AISI 316
Sluice hook with p.p. rope / Crochet avec corde



Bestell-Nr. Order no.	Hakenlänge Length of hook	Seil-Ø Rope-Ø	Seillänge Length of rope	Box	*€/Stück *€/piece
81404343245_10	245	10	5 Mtr.	1	43,00

814029

Universal Edelstahlband / A2-AISI 304
Universal stainless steel band / Bande en acier inoxydable - universel

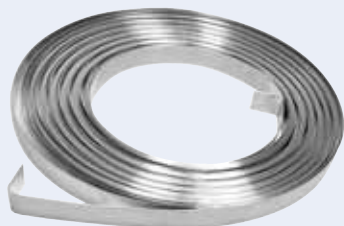

Bestell-Nr. Order no.	B	Bund/m Bundle/m	S	*€/Meter *€/metre
814029219	19	30	0,75	4,50

Yachtzubehör, Ausrüstung und Spezielles

Yachting accessories, equipment and highlights
 Equipement et accessoires exclusifs pour yachts

8

Einbindeschlaufen für Edelstahlband / A2-AISI 304

Loop for stainless steel band / Passant pour bandeau inox

814030

Bestell-Nr. Order no.	B	Box	*€/Stück *€/piece
814030219	19	10	0,90



Spann- und Schneidewerkzeug für Edelstahlband

Stretch and cutting tool for stainless steel band / Outil pour coupage et tension bandeau en inox

814031

Bestell-Nr. Order no.		Box	*€/Stück *€/piece
81403110		1	242,00



Windenkurbel, schwimmfähig / Plastik

Lock-in floating winch handle, plastic / Manivelle de treuil flottante en plastique

814151

Bestell-Nr. Order no.	L	Box	*€/Stück *€/piece
8141513250	250	2	26,70



Windenkurbel / Alu

Winch handle / Manivelle de treuil en alu

814152

Bestell-Nr. Order no.	L	Box	*€/Stück *€/piece
8141520250	250	2	42,00

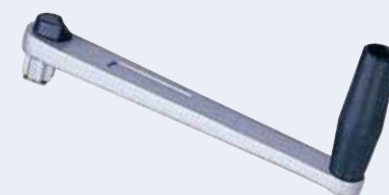

8

Yachtzubehör, Ausrüstung und Spezielles

Yachting accessories, equipment and highlights

Équipement et accessoires exclusifs pour yachts

814730

Gabel mit Winchaufnahme / A4-AISI 316

Fork with winchdrive / Chape de fixation pour Bimini

NEW

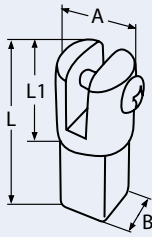

Bestell-Nr. Order no.	L	L1	A	B	Box	*€/Stück *€/piece
814730461	61	30	8	10	2	12,70

814692

Ausziehbare Wäscheleine / A2-AISI 304

Retractable clothes line / Corde à linge rétractable

NEW

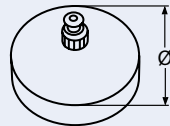

Bestell-Nr. Order no.	Ø	Länge der Leine Length of line	Box	*€/Stück *€/piece
814692290	90	2,5 m	1	19,50

814032

Maritime Wäscheklammer mit Edelstahlfeder / A2-AISI 304

Maritime clothes peg with stainless steel spring / Épingle à linge maritime avec ressort en inox

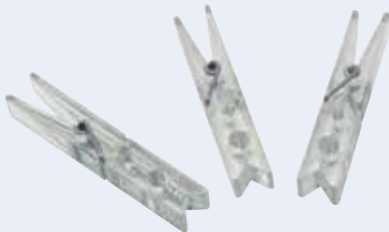

Bestell-Nr. Order no.	L	B	Box	*€/Stück *€/piece
81403229_72	72	9	20	0,25

814101

Bullauge mit Sicherheitsglas / A2-AISI 304

Porthole with safety glass / Hublot avec verre de sûreté

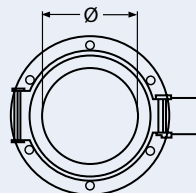

Bestell-Nr. Order no.	Ø	Box	*€/Stück *€/piece
8141012100	100	1	178,00
8141012125	125	1	206,00
8141012150	150	1	242,00

Für Wandstärken von 4-15 mm. Absolut wasserdicht.
For wall thickness 4-15 mm. Absolutely waterproof.

Erweiterungsrosette für Wandstärke bis 40mm
Enlargement for wall thickness 40mm

8141012100R	100	1	29,00
8141012125R	125	1	29,00
8141012150R	150	1	29,50

Yachtzubehör, Ausrüstung und Spezielles

Yachting accessories, equipment and highlights
 Equipement et accessoires exclusifs pour yachts

8

Rundfenster mit Sicherheitsglas / A2-AISI 304

Round window with safety glass / Fenêtre ronde avec verre de sûreté

814102

Bestell-Nr. Order no.	Innen-Ø Inside-Ø	Außen-Ø Outside-Ø	Box	*€/Stück *€/piece
8141022125	125	190	1	140,00
8141022150	150	215	1	175,00
8141022200	200	265	1	310,00

Für Wandstärken von 4-20 mm. Absolut wasserdicht.
 For wall thickness 4-20 mm. Absolutely waterproof.

Erweiterungsrosette für Wandstärke bis 40mm
 Enlargement for wall thickness 40mm

8141022125R	125		1	29,00
8141022150R	150		1	29,50
81410212200R	200		1	39,00

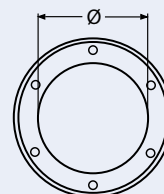

Lenkradknopf / A4-AISI 316

Handle bar for steering / Boule de volant

814098

Bestell-Nr. Order no.	max. Ø	Box	*€/Stück *€/piece
814098420	20	2	34,00



Wasserskiseil mit Griff

Waterski rope with handle / Corde de ski nautique avec poignée

814055

Bestell-Nr. Order no.	Seillänge Length of rope	Griffbreite Width of handle	Box	*€/Stück *€/piece
814055323	23 mtr.	220	1	45,00



Wasserskispiegel

Waterski mirror / Rétroviseur pour ski nautique

814056

Bestell-Nr. Order no.	L	H	Box	*€/Stück *€/piece
8140563	300	100	1	33,00



8

8

Yachtzubehör, Ausrüstung und Spezielles

Yachting accessories, equipment and highlights

Equipement et accessoires exclusifs pour yachts

814095

Uhr, Messing, blank, lackiert

Clock, brass, polished, lacquered / Horloge en laiton brillant, laqué



Bestell-Nr. Order no.	Ø	H	Box	*€/Stück *€/piece
8140955113	113	54	1	134,70

814096

Barometer, Messing, blank, lackiert

Barometer, brass, polished, lacquered / Baromètre en laiton brillant, laqué



Bestell-Nr. Order no.	Ø	H	Box	*€/Stück *€/piece
8140965113	113	54	1	164,20

814097

Bullaugenspiegel, Messing blank

Brass porthole mirror / Miroir hublot en laiton brillant



Bestell-Nr. Order no.	Ø	Box	*€/Stück *€/piece
8140975200	200	1	79,90
8140975300	300	1	110,00

814094

Kompass

Compass / Boussole



Bestell-Nr. Order no.	Box	*€/Stück *€/piece
8140943000	5	19,30

Yachtzubehör, Ausrüstung und Spezielles

Yachting accessories, equipment and highlights
 Equipement et accessoires exclusifs pour yachts

8

Manuelle Winch / A2-AISI 304

Manual Winch / Treuil manuel

814129

Bestell-Nr. Order no.	Zugkraft max. Kg Traction max. kg	Grundplatte Groundplate	Box	*€/Stück *€/piece
8141292270	270	108 x 90	1	278,00
8141292540	540	135 x 90	1	298,00



Decksreinigungsset

Deck cleaning set / Set de nettoyage pour pont

814124

Bestell-Nr. Order no.	Schaftlänge Length	Box	*€/Stück *€/piece
8141243	1,22 m	1	36,00



Propeller-Schutzhülle für Aussenborder

Propeller cover for outboard motor / Couverture pour moteur à propulsion

814590

Bestell-Nr. Order no.	L	B	H	Box	*€/Stück *€/piece
8145903560	560	660	260	1	35,00

Farbe: Rot, 100 % wasserabweisend, UV-Beständig
 Colour: Red, 100 % waterproof, UV resistant
 Material: Terylene

Das Abdecken der Schiffsschraube während des Transports ist in Deutschland Pflicht! (StVO § 32 Abs. 2) sofern er über die Lichtleiste ragt.



Verlängerungsgasgriff für Außenborder / Alu

Extension handle for outboard motor / Rallonge de barre franche télescopique

814282

Bestell-Nr. Order no.	Auszugslänge Extension length	Box	*€/Stück *€/piece
8142820600	600 - 1000	1	44,60

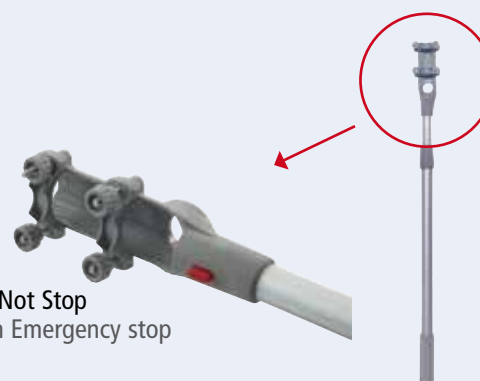

Mit Not Stop
With Emergency stop

8

814286

Transporträder für Schlauchboote / A2-AISI 304

Rubber boat carrier / Roues de halage



Bestell-Nr. Order no.	Rad-Ø Wheel-Ø	Max. Kg	Box	*€/Stück *€/piece
8142862260	260	130	2	90,00

814287

Motor-Bock

Engine holder / Support moteur fixe pliable



Bestell-Nr. Order no.	H	Für PS For HP	Box	*€/Stück *€/piece
81428710900	900	bis 25 / till 25	1	70,00



8

Yachtzubehör, Ausrüstung und Spezielles

Yachting accessories, equipment and highlights

Equipement et accessoires exclusifs pour yachts

814288

Transportwagen für Außenborder

Engine holding trolley / Chariot support moteur



Bestell-Nr. Order no.	H	Für PS For HP	Box	*€/Stück *€/piece
81428810900	900	bis 25 / till 25	1	116,00

814289

Heckschutzplatte

Transom plate / Plaque de protection

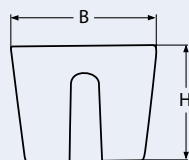

Bestell-Nr. Order no.	B	H	Box	*€/Stück *€/piece
8142893430_350	430	350	5	7,30

814290

Heckschutzplatte, gewinkelt, 22° - 1°

Transom plate, angled, 22° - 1° / Plaque de protection incliné 22° - 1°

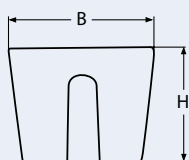

Bestell-Nr. Order no.	B	H	Box	*€/Stück *€/piece
8142903420_340	420	340	5	12,00

814647

Bugsriet / Teak / A4-AISI 316

Bow spring / Delphinière

NEW

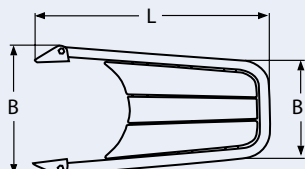
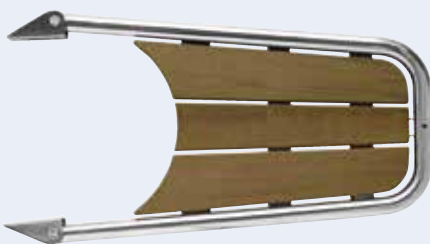

Bestell-Nr. Order no.	L	B	B1	Box	*€/Stück *€/piece
8146474280	650	330	280	1	297,00

NEW

Bugsprriet mit Ankerrolle / Teak / A4-AISI 316

Bow spring with anchor roller / Delphinrière avec davier pour ancrés

814648

Bestell-Nr. Order no.	L	B	B1	Box	*€/Stück *€/piece
8146484580	1200	580	330	1	1300,00

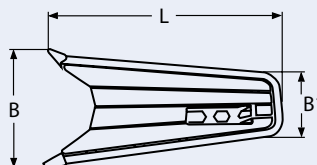

Möwenschreck / Plastik

Anti seagull crow / Corbeau contre mouettes

814333

Bestell-Nr. Order no.	L	H	Box	*€/Stück *€/piece
8143333380	380	220	1	12,00



Schöpfeimer / Plastik

Plastic bailer / Ecope en plastique

814299

Bestell-Nr. Order no.	L	B	Box	*€/Stück *€/piece
8142993180_90	180	90	5	3,30

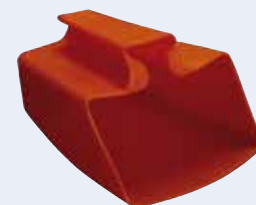

8

Zubehör Tasche / Nylon

Accessory bag / Sac (vide)

814317

Bestell-Nr. Order no.	Farbe Colour	L	B	H	Box	*€/Stück *€/piece
8143173B	Blau / Blue	700	340	380	1	35,00
8143173G	Gelb / Yellow	700	340	380	1	35,00

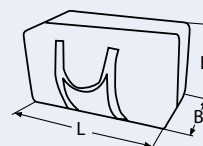

Keine Hydraulik Keine elektrischen Schalter

Die SMART TABS sind komplett selbsteinstellend; keine Benutzereinstellung erforderlich.
Die Nitrogengasdruckdämpfer sorgen dafür, dass sich das Boot vorne nicht hebt, indem sie die Trimmklappen unten halten.

Geschwindigkeitsregulierung

Bei Beginn der Fahrt stellen sich die SMART TABS auf einen abwärtigen Winkel ein. Bei höheren Geschwindigkeiten drückt das Wasser die Trimmklappen nach oben, um das Boot wieder in eine horizontale Lage zu bringen.

Bootstabilisatoren

Selbst beim Cruisen setzen die SMART TABS ihre Arbeit fort. Sie wirken dann wie Schockabsorber. Die konstante Einstellung auf die Wasserbedingungen erlaubt den SMART TABS, beim Wenden und Wellen überqueren Stabilität in das Boot zu bringen.

Das Einzige seiner Art

Das einzigartige System ist das Einzige seiner Art in der Branche. Das eingebaute Gasdruckdämpfersystem ist einzigartig in seinem Design.

- Es erhöht die Gleitgeschwindigkeit um 33%
- Es erhöht den Fahrkomfort bei langsamer Geschwindigkeit
- Es verbessert die Wirtschaftlichkeit, das Handling und die Sicherheit

Einfache Installation

Mit einem Akkuschauber und 2 Philips-Bits kann jeder die SMART TABS in weniger als einer halben Stunde anbringen.

- Alle Montageteile und Anleitungen inkl.
- SMART TABS erfordern für die Montage kein Durchbohren!

SMART

8995



Vorher / Before



8996



TABS



Automatische Trimmklappen ohne Strom / A2-AISI 304 Automatic trim tabs without electricity

8995

Bestell-Nr. Order no.	Bootslänge/Fuss Boat length/feet	Bootslänge/m Boat length/m	PS HP	Box	*€/Stück *€/piece
89952008_18	10'; 11'; 12'	3,0; 3,4; 3,6	8-18	2	115,00
89952020_25	10'; 11'; 12'	3,0; 3,4; 3,6	20-25	2	115,50
89952030_50	12'; 13'; 14'; 15'	3,6; 4,0; 4,3; 4,6	30-50	2	149,00
89952060_150	15'; 16'; 17'; 18'	4,6; 4,9; 5,2; 5,5	60-150	2	185,00
89952150_240	17'; 18'; 19'; 20'; 21'; 22'	5,2; 5,5; 5,8; 6,1	150-240	2	185,00

Automatische Trimmklappen ohne Strom / A2-AISI 304 Automatic trim tabs without electricity

8996

Bestell-Nr. Order no.	Bootslänge Fuss Boat length feet	Bootslänge Meter Boat length metre	Max.Bootsbreite Fuss Max. boat width feet	Max. Bootsbreite Meter Max. boat width metre	Max. Gewicht Max. weight	Box	*€/Stück *€/piece
899622945	23' - 30'	7,0 - 9,1	9'	2,7	2945 kg	2	278,00
899623850	23' - 30'	7,0 - 9,1	9'	2,7	3850 kg	2	278,00



Boat stabilizers

Even when cruising, SMART TABS continue to work like shock absorbers. The constant adjustments to sea conditions allow SMART TABS to provide remarkable stability in turns, while crossing waves, while cruising and while running at maximum speeds. No more sliding, porpoising or chine walking!

No hydraulics No electric switches

SMART TABS are completely automatic, requiring no operator adjustment while underway. The nitrogen gas actuator provides LIFT at the stern of the boat by holding the trim plate down during acceleration. The amount of LIFT is determined by the actuator load rating and the trim plate adjustment, which is done at the time of installation (see installation instructions).

Speed regulation

SMART TABS start at a downward angle to maximize lift at slow speeds. As the boat accelerates, the water pushes up on the trim plates, providing lift to the stern, which minimizes bow rise and allows the boat to plane quickly. Once the water pressure exceeds the actuator load rating (maximum lift), the trim plates move up to a horizontal position eliminating any drag.

Unique

This unique system is the only one of its kind in the market. The internal valve system is truly "smart" in its design for controlling your boats performance.

- Reduces the minimum planing speed by 33%
- Provides a more comfortable ride at lower speeds
- Improves economy, handling and safety

Speed regulation

With an electric drill, two drill bits (1/8" and 3/16"), a Phillips screwdriver and two wrenches just about anyone can install SMART TABS in less than 30 minutes.

- All mounting hardware, instructions and templates are included.
- SMART TABS require NO THROUGH HULL DRILLING

ANLEGERUTEN als Set

Anlegeruten

Die Anlegeruten sind ein sicherer und preiswerter Weg, Ihr Boot vor kostspieligen Stegschäden zu schützen. Das Anlegerutensystem hält das Boot in einem bequemen und sicheren Abstand zum Steg. Dabei schützt es das Boot vor Wellen-, Wind- und Gezeitenschäden.

Die Anlegeruten sind aus einem soliden, hoch qualitativen Fiberglas gefertigt. Die FüÙe bestehen aus einer Aluminium-Magnesiumlegierung. Das Set enthält weiterhin die benötigten Anlegeleinen. Die Anlegeruten werden als Paar verkauft. Sie können sehr einfach zum Verstauen entfernt werden.



Mooring whips

Mooring whips are an economical and safe way to protect your boat against costly dockside and seawall damage. The Mooring whips system pulls your boat a safe, convenient distance away from the dock, thereby protecting it from the damaging forces of waves, wind, tides and wakes.

Mooring whips are made of high quality solid fiberglass poles, aluminium-magnesium base units, roller tips and Mooring whip lines. Each set will be delivered with all of the hardware necessary for installation. Mooring whips and Premium Mooring whips are sold in pairs. The PWC Mooring whip is a one-pole system with a flush mount base and is commonly used on swim platforms. Whips can be easily removed for storage.



8997

Anlegeruten, Fiberglas
 Mooring whips, fiberglass

Bestell-Nr. Order no.	Länge/m Length/m	Ø Ø	Bootslänge max. Boat length max.	Gewicht Weight	Box	*€/Stück *€/piece
8997300_20	2,44	26-27 mm	-20'	- 1130 kg	2	510,00
8997318_23	3,65	26-27 mm	18' - 23'	1130 kg - 2270 kg	2	645,00
8997324_28	4,27	26-27 mm	24' - 28'	2270 kg - 4540 kg	2	695,00
8997329_33	4,88	26-27 mm	29' - 33'	4540 kg - 9070 kg	2	740,00

Tender- und Jetskihalter variabel, Alu

Jetskihalter variabel

Der neue Marinetech Tender- und Jetskihalter aus eloxiertem Aluminium (seewasserbeständig).

Durch diverse Verstellmöglichkeiten lässt sich der Halter optimal auf die verschiedenen Boots- und Jetskitypen einstellen.

Anstellwinkel der Auflageblöcke: 10° - 54°
 Obere Öffnungsweite bei 10° 775mm - 975mm
 Obere Öffnungsweite bei 54° 445mm - 645mm

Inklusive Schäkkel zur Befestigung von Spanngurten.
 Nutzlast pro Halter ca. 300 kg.
 Schrauben zur Montage auf Plattform nicht im Set enthalten.



Jetski holder, variable

The new Marinetech tender- and Jetski holder made of anodized aluminium (seawater resistant)

The adjustable ensures an optimum holder fit with several boat and jet ski types.

Setting angle of the onlay plate 10° - 54°
 Upper opening width at 10° 775mm – 975mm
 Upper opening width at 54° 445mm – 645mm

Shackles for fastening belts included.
 Working load of each holder ca. 300 kg.
 Screws for mounting on platform not included in set.

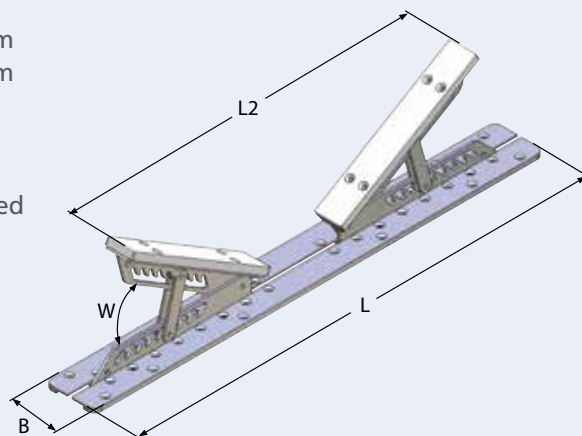
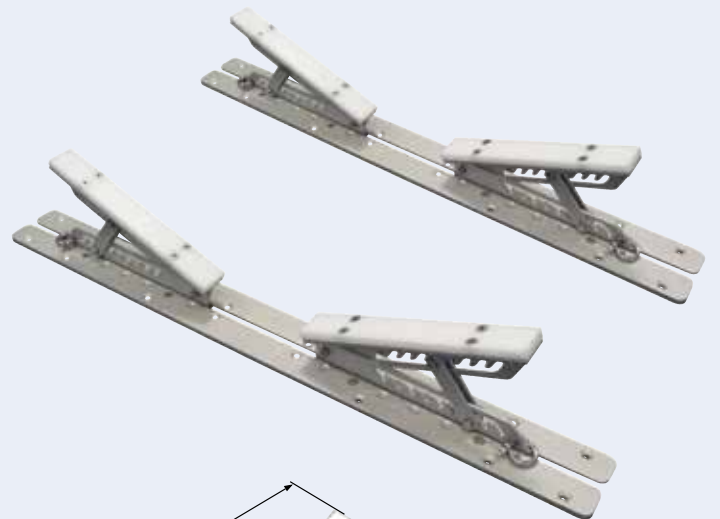

Tender- und Jetskihalter, variabel / Alu
 Tender and Jetski holder, variable

814335

Bestell-Nr. Order no.	L	B	L2	W	Box	*€/Stück *€/piece
8143350995	995	110	445 - 975	10° - 54°	2	895,00

Bimini Awning

814309**Bimini, dreiarmlig / Alu**
Awning, 3 arms / Bimini avec 3 arceaux en Alu

Bestell-Nr. Order no.	Farbe Colour	B	L	H	Box	*€/Stück *€/piece
8143090160_180W	weiß/white	1600 - 1800	1800	1100	1	210,00
8143090160_180B	blau/blue	1600 - 1800	1800	1100	1	210,00
8143090185_215W	weiß/white	1850 - 2150	1800	1100	1	220,00
8143090185_215B	blau/blue	1850 - 2150	1800	1100	1	220,00
8143090215_235W	weiß/white	2150 - 2350	1800	1100	1	235,00
8143090215_235B	blau/blue	2150 - 2350	1800	1100	1	235,00

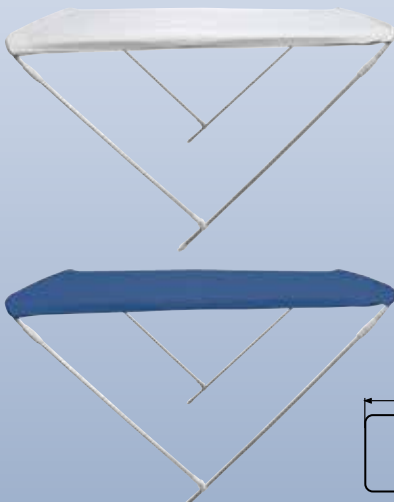
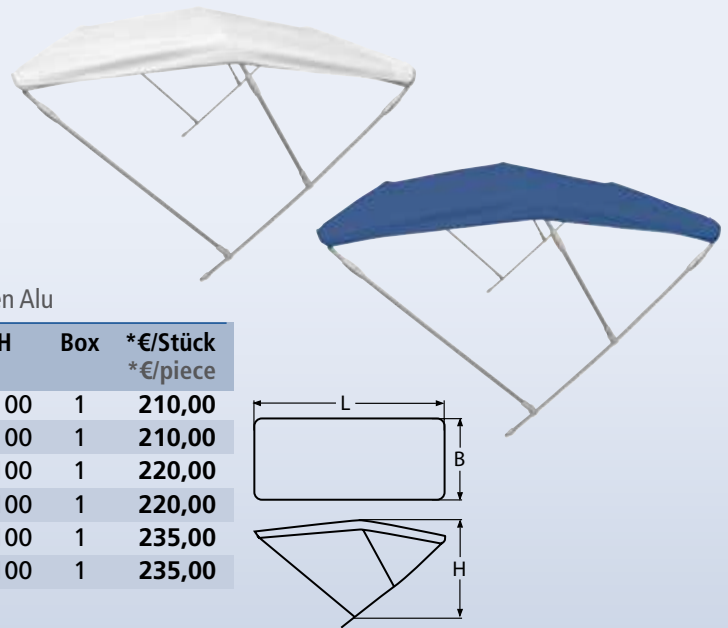
**814310****Bimini, zweiarmlig / Alu**
Awning, 2 arms / Bimini avec 2 arceaux en Alu

Bestell-Nr. Order no.	Farbe Colour	B	L	H	Box	*€/Stück *€/piece
8143100120_140W	weiß/white	1200 - 1400	1800	1100	1	140,00
8143100120_140B	blau/blue	1200 - 1400	1800	1100	1	140,00
8143100140_165W	weiß/white	1400 - 1650	1800	1100	1	155,00
8143100140_165B	blau/blue	1400 - 1650	1800	1100	1	155,00
8143100165_185W	weiß/white	1650 - 1850	1800	1100	1	170,00
8143100165_185B	blau/blue	1650 - 1850	1800	1100	1	170,00

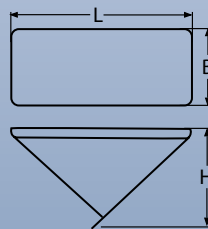
**814311****Bimini, dreiarmlig / Alu**
Awning, 3 arms / Bimini avec 3 arceaux en Alu

Bestell-Nr. Order no.	Farbe Colour	B	L	H	Box	*€/Stück *€/piece
8143110150W	weiß/white	1500	1800	1400	1	195,00
8143110150B	blau/blue	1500	1800	1400	1	195,00
8143110170W	weiß/white	1700	1800	1400	1	210,00
8143110170B	blau/blue	1700	1800	1400	1	210,00
8143110185W	weiß/white	1850	1800	1400	1	220,00
8143110185B	blau/blue	1850	1800	1400	1	220,00
8143110200W	weiß/white	2000	1800	1400	1	220,00
8143110200B	blau/blue	2000	1800	1400	1	220,00
8143110225W	weiß/white	2250	1800	1400	1	250,00
8143110225B	blau/blue	2250	1800	1400	1	250,00

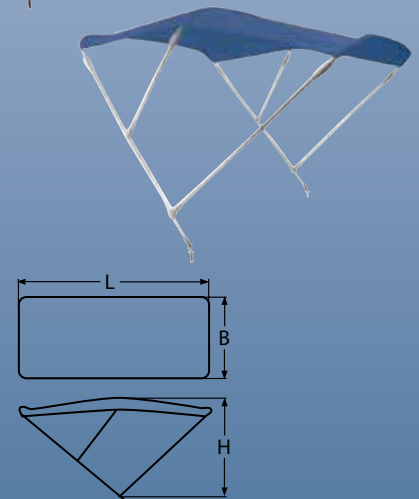

Material: Terylene, Farbe: weiß, blau, 100% wasserabweisend, UV-Beständig
 Material: Terylene, colour: white, blue, 100% waterproof, UV resistant

Bimini Awning

814644

Sonnensegel
Sun awning / Bimini

NEW

Bestell-Nr. Order no.	L	B	Box	*€/Stück *€/piece
81464433100	3100	2400	1	180,00

Farbe: Weiß, 100% wasserabweisend, UV-Beständig
Colour: White, 100% waterproof, UV resistant
Mit Kunststoffösen / with plastic eyelet
Material: Terylene

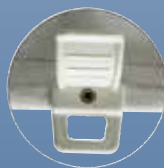

814645	Sonnenrollo		NEW	
Bestell-Nr. Order no.	L	B	Box	*€/Stück *€/piece
8146453360	400	360	1	51,00
8146453450	500	450	1	58,00
8146453500	600	500	1	65,00
8146453550	650	550	1	67,00
8146453680	780	680	1	70,00

Farbe außen: Silber / Colour outside: silver
Farbe innen: Grau / Colour inside: grey

* Store pour panneau de pont

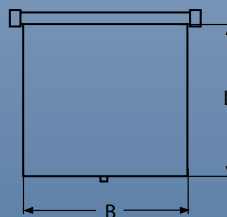

Persenning Boat cover

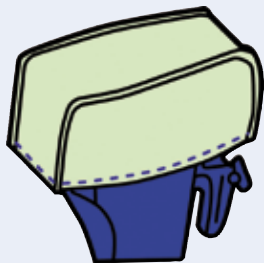
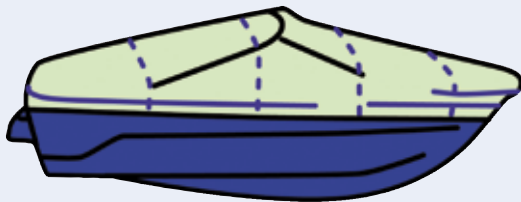
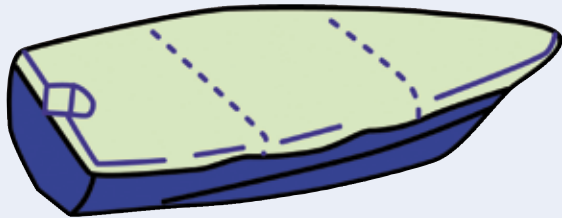

¹ Farbe: Weiß, 100% wasserabweisend, UV-Beständig
¹ Colour: White, 100% waterproof, UV resistant
Material: Terylene

814266

Persenning für offene Boote¹
Boat cover for open boats¹ / **

Bestell-Nr. Order no.	Größe Size	Box	*€/Stück *€/piece
8142663385	3850 x 1600	1	160,00
8142663420	4200 x 1600	1	170,00
8142663430	4300 x 1600	1	190,00
8142663450	4500 x 1700	1	225,00
8142663470	4700 x 1800	1	235,00
8142663500	5000 x 1900	1	245,00

**Bache pour bateaux ouverts

814267

Persenning für Kabinenboote¹
Boat cover for cabin boats¹ / **

Bestell-Nr. Order no.	Größe Size	Box	*€/Stück *€/piece
8142673545	5450 x 3100	1	250,00
8142673650	6500 x 3900	1	285,00

**Bache pour bateaux avec Cabine

814268

Persenning für Day Cruiser¹
Boat cover for day cruiser¹ / **

Bestell-Nr. Order no.	Größe Size	Box	*€/Stück *€/piece
8142683475	4750 x 2400	1	215,00
8142683525	5250 x 2600	1	270,00
8142683570	5700 x 2800	1	280,00
8142683610	6100 x 2800	1	320,00
8142683650	6500 x 3000	1	360,00
8142683700	7000 x 3150	1	380,00

**Bache pour bateaux équipés d'un pare-brise

814269

Persenning für Aussenborder¹
Boat cover for outboard motor¹ / **

Bestell-Nr. Order no.	PS HP	Box	*€/Stück *€/piece
814269303_05	3 - 5	1	19,00
814269306_08	6 - 8	1	20,00
814269309_15	9 - 15	1	21,00
814269315_20	15 - 20	1	22,00
814269320_30	20 - 30	1	23,00
814269335_60	35 - 60	1	24,00
814269365_90	65 - 90	1	25,00

**Bache pour moteur hors-bord

814265

Aufsteller für Abdeckplane / Alu
Pole for boat cover

Bestell-Nr. Order no.	Auszugslänge Extension length	Box	*€/Stück *€/piece
8142650600_1000	600 - 1000	1	12,30
8142650900_1500	900 - 1500	1	15,50

NEW

Ruderdolle / A4-AISI 316
 Oarlock / Dame de nage

814712

Bestell-Nr. Order no.	D	Box	*€/Stück *€/piece
814712450	50	2	20,00



NEW

Ruderdolle rund / A4-AISI 316
 Oarlock round / Dame de nage

814723

Bestell-Nr. Order no.	Innen-Ø Inside-Ø	Box	*€/Stück *€/piece
814723449	49	2	26,00
814723457	57	2	27,00

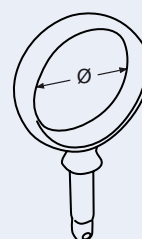

NEW

Ruderdollensockel / A4-AISI 316
 Oarlock socket / Support de dame de nage (pour Art.Nr.814712 + 814723)

814713

Bestell-Nr. Order no.	Für Artikel For article	Box	*€/Stück *€/piece
8147134	814712 + 814723	2	15,00



NEW

Ruderdollensockel / A4-AISI 316
 Oarlock socket / Support de dame de nage (pour Art.Nr.814712 + 814723)

814714

Bestell-Nr. Order no.	Für Artikel For article	Box	*€/Stück *€/piece
8147144	814712 + 814723	2	13,00

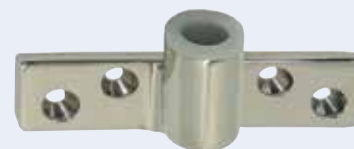

NEW

Ruderdollensockel / A4-AISI 316
 Oarlock socket / Support de dame de nage (pour Art.Nr.814712 + 814723)

814715

Bestell-Nr. Order no.	Für Artikel For article	Box	*€/Stück *€/piece
8147154	814712 + 814723	2	15,00



8

Kapitel 9

Chapter 9

Werkzeug, Reparatur und Pflege

Tools, repair and maintenance



Schlauchschellen Sortimentsbox / A4-AISI 316

Hose clamps assortment box / Boîte d'assortiment de collier de serrage pour tuyau

814209

Bestell-Nr. Order no.	Box	*€/Stück *€/piece
8142094912	1	400,00

	Inhalt:							
	9 mm				12 mm			
Bandbreite	9 mm				12 mm			
Abmessung	8 - 16	12-22	16-27	20-32	25-40	32-50	40-60	50-70
Menge	75	60	20	15	10	10	8	6

Beinhaltet biegsamen 1 x 7 mm sechskant Schraubendreher

	Content:							
	9 mm				12 mm			
Width	9 mm				12 mm			
Size	8 - 16	12-22	16-27	20-32	25-40	32-50	40-60	50-70
Quantity	75	60	20	15	10	10	8	6

Includes flexible 1 x 7 hexagon screwdriver



NEW

Bit-Sortiment 122-teilig

Bit assortment 122 pcs. / Bit assortiment de 122 pcs

814733

Bestell-Nr. Order no.	Box	*€/Stück *€/piece
81473310122	1	38,00



NEW

Edelstahl Bit-Sortiment 18-teilig

Stainless steel bit assortment 18 pcs. / Bit assortiment de 18 pcs en inox

814734

Bestell-Nr. Order no.	Box	*€/Stück *€/piece
814734218	1	44,00

- Ideal zum verschrauben von Edelstahlschrauben zur Vermeidung von Fremdrost.
- Ideal for screwing in stainless steel screws to prevent external rust.



9

3016

Halteschelle DIN 3016 mit Gummieinlage / A2-AISI 304

Fastening clamps DIN 3016 with rubber inlay / Colliers de fixation caoutchoutés

NEW



Bestell-Nr. Order no.	Ø	Bandbreite Band with	Box	*€/Stück *€/piece
301620812	8	12	100	0,60
301621012	10	12	100	0,60
301621212	12	12	100	0,80
301621512	15	12	100	0,80
301621812	18	12	100	0,80
301622015	20	15	50	0,90
301622215	22	15	50	1,10
301622515	25	15	50	1,10
301622815	28	15	50	1,10
301623015	30	15	50	1,10
301623220	32	20	25	2,40
301623520	35	20	25	2,40
301623820	38	20	25	2,40
301624020	40	20	25	2,40
301624820	48	20	10	2,80
301625020	50	20	10	2,80

814455

Edelstahl Schlauch- und Kabelschelle / A4-AISI 316

Stainless steel hose and cable clamp / Collier de serrage en inox



Bestell-Nr. Order no.	B	L	BL/Kg	Box	*€/Stück *€/piece
814455446_201	4,6	201	46	20	1,40
814455446_360	4,6	360	46	20	1,70
814455446_520	4,6	520	46	20	2,00
814455479_259	7,9	259	113	20	2,10
814455479_520	7,9	520	113	20	3,00
814455479_838	7,9	838	113	20	4,20

814456

Schellenzange für Kabelschelle

Hose tie for cable clamp / Prise à sertir pour collier de serrage en inox



Bestell-Nr. Order no.	Für Art. 814455 For art 814455	Box	*€/Stück *€/piece
81445610		1	299,00

NEW

Hydraulische Presszange, 12 Tonnen für Terminals
Hydraulic crimping pliers 12 tons for terminals / *

814678

Bestell-Nr. Order no.	Max. Presskraft Max. pressing force	Box	*€/Stück *€/piece
8146781012	12 Tonnen / 12 tons	1	225,00

Mit einer Kraft von 12 Tonnen und einer Werkzeugbreite von 12mm, ist die hydraulische Presszange optimal geeignet das Marineteck ESS-Programm schnell und kostengünstig direkt vor Ort zu verpressen. Lieferung im Kunststoffkoffer ohne Presseinsätze.

With a force of 12 tons and a width of 12mm, the hydraulic pliers are ideally suited for quickly and inexpensively crimping the Marineteck ESS range directly on site. Supplied in a plastic case without crimping dies.

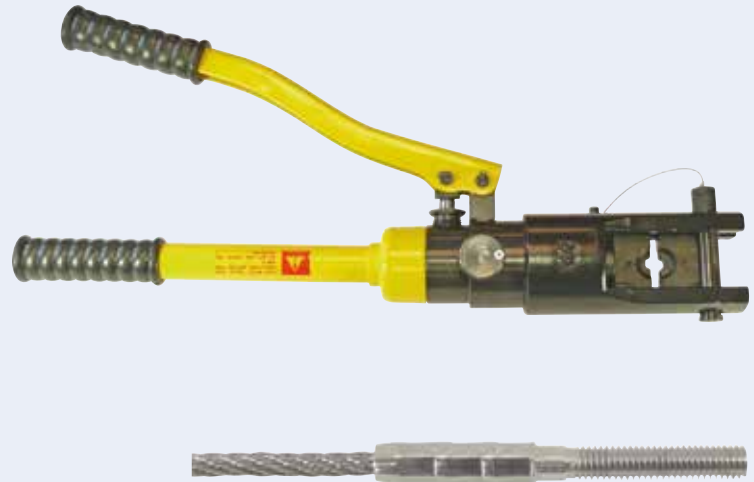

* Pince Hydrolique (12 tonnes) à sertir pour terminaison et embout „ESS“

NEW

Presseinsätze für hydraulische Presszange
Crimping dies for hydraulic crimping pliers / Machoir pour pince hydrolique „8146781012“

814679

Bestell-Nr. Order no.	Für ESS Terminals For ESS terminal	Terminal Außen-Ø Terminal outside-Ø	Box	*€/Stück *€/piece
81467912-03	3MM	6,4	1	160,00
81467912-04	4MM	7,5	1	160,00
81467912-05	5MM	9,0	1	160,00
81467912-06	6MM	12,5	1	160,00

Gefertigt aus hochwertigem Werkzeugstahl mit optimaler Härte und Zähigkeit. Qualität made in Germany gewährleistet maximale Lebensdauer.

Made from high quality tool steel with optimum hardness and toughness. Quality made in Germany ensures maximum durability



814643

Automatische Abisolierzange für 0,2 - 6,0mm² KabelAutomatic wire stripper for 0,2 – 6,0mm² wire / Cisaille pour Câble

NEW



Bestell-Nr.
Order no.
8146433

Box *€/Stück
*€/piece
1 24,00

Beschreibung

- ergonomische, automatische Abisolierzange, für Leiter von 0,2 bis 6,0 mm²,
- automatisches Abtastsystem, keine Einstellung auf den Kabelquerschnitt notwendig,
- optimal positionierter Seitenschneider bis 2,5 mm²,
- verstellbarer Längenanschlag 5 bis 15 mm,
- mit Befestigungsvorrichtung am Griffende,
- TÜV / GS-geprüft

Description

- ergonomic, automatic wire stripper for wires from 0.2 - 6.0 mm² (AWG 24 - 10),
- for speedy and precise stripping of wires even where access is difficult,
- wire cutter for diameters of up to 2.5 mm²,
- length stopper adjustable from 6 to 15 mm,
- plier-handle design with lockable design,
- TÜV / GS approved

8993

Sortimentskasten, 7 Fächer

Assortment Box, 7 compartments / Valise avec 7 compartiments

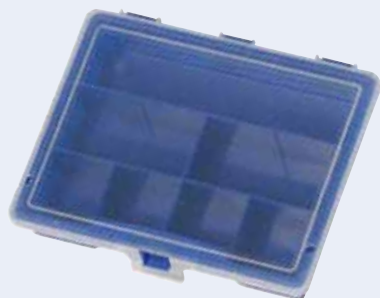

Bestell-Nr. Order no.	Länge Length	Breite Width	Höhe Height	Box	*€/Stück *€/piece
89933180_140	180	140	40	10	4,50

8994

Sortimentskasten, 9 Fächer

Assortment Box , 9 compartiments / Valise avec 9 compartiments



Bestell-Nr. Order no.	Länge Length	Breite Width	Höhe Height	Box	*€/Stück *€/piece
89943290_185	290	185	46	10	16,00

Skipper-Einhand-Messer / A2 / Alu
Skipper-knife, one hand / Couteau manche en alu

8637

Bestell-Nr. Order no.	L	Box	*€/Stück *€/piece
86372110	170	10	14,90



Messer / Alu
Knife / Couteau

814153

Bestell-Nr. Order no.	L	B	Box	*€/Stück *€/piece
8141530	185	30	5	6,00



Messer / Plastik
Knife / Couteau plastique

814154

Bestell-Nr. Order no.	L	B	Box	*€/Stück *€/piece
8141543	175	25	5	3,00



Fischmesser mit Köcher / A2-AISI 304
Fishknife with quiver / Couteau avec etuis

814226

Bestell-Nr. Order no.	L	Box	*€/Stück *€/piece
8142262210	210	5	11,60



9

Werkzeug, Reparatur und Pflege

Tools, repair and maintenance

Outils de réparations et de maintenance

814227

Filetierreter mit Köcher / A2-AISI 304

Filleting knife with quiver / Couteau avec etuis



Bestell-Nr. Order no.	L	Box	*€/Stück *€/piece
8142272280	280	5	15,50

814250

2-Schritt-Messerschärfer

2 step sharpener / Marchepied



Bestell-Nr. Order no.	Box	*€/Stück *€/piece
814250	1	15,50

Mehrfacher Testsieger / Multiple test winner

8415

Original „Marineman“ / A2-AISI 304

Multitool / Couteau avec pochette



Bestell-Nr. Order no.	Ausstattung Configuration	Box	*€/Stück *€/piece
84152TASCHE	Mit Tasche / With case	10	14,00
84152BITS	Mit Tasche + Bits / With case + bits	10	24,00

8277

Takelmesser / A2-AISI 304

Rigging knife / Couteau



Bestell-Nr. Order no.	L	Box	*€/Stück *€/piece
82772105	95	10	17,00

Kapitel 10

Chapter 10

Fittinge

Fittings



8748

Borrdurchlass mit Schlauchanschluss / A4-AISI 316
Thru-hull with hose connection / Passe-coque

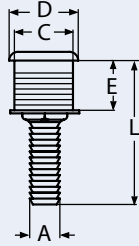

Bestell-Nr. Order no.	Größe Size	A	L	C	D	E	Box	*€/Stück *€/piece
8748458	5/8"	16	81	33	48	28	1	10,00
8748434	3/4"	19	86	33	48	86	1	11,00
874841	1"	26	103	33	48	28	1	12,00
874841_14	1 1/4"	32	133	41	60	33	1	15,00
874841_12	1 1/2"	38	144	56	60	44	1	16,00

Mit Edelstahl Oberteil – Borrdurchlass Stalon / thru-hull with stainless steel-upper part

8605

Borrdurchlass mit Außengewinde / A4-AISI 316
Thru-hull with external thread / Passe-coque

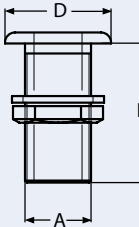

Bestell-Nr. Order no.	Größe (A) Size (A)	L	D	Box	*€/Stück *€/piece
8605438	3/8"	54	35	1	17,00
8605412	1/2"	59	40	1	18,00
8605434	3/4"	65	47	1	18,00
860541	1"	73	55	1	33,00
860541_14	1 1/4"	77	64	1	36,00
860541_12	1 1/2"	83	75	1	45,00

8620

Borrdurchlass mit Schlauchanschluss / A4-AISI 316
Thru-hull with hose connection / Passe-coque

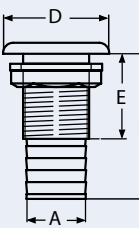

Bestell-Nr. Order no.	Größe Size	A	L	D	E	Box	*€/Stück *€/piece
8620438	3/8"	10	52	35	26	1	10,50
8620412	1/2"	12	52	35	26	1	13,00
8620434	3/4"	19	59	39	26	1	18,50
862041	1"	26	68	49	40	1	20,00
862041_14	1 1/4"	32	72	55	41	1	22,00
862041_12	1 1/2"	38	77	64	43	1	27,50

8639

Wassereinlass mit Außengewinde / A4-AISI 316
Water intake with external thread / Crépine passe-coque

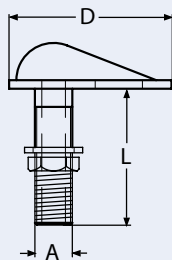

Bestell-Nr. Order no.	Größe (A) Size (A)	D	L	Box	*€/Stück *€/piece
8639438	3/8"	78	67	1	14,50
8639412	1/2"	90	72	1	22,50
8639434	3/4"	103	80	1	24,00
863941	1"	107	75	1	27,50
863941_14	1 1/4"	116	77	1	30,00
863941_12	1 1/2"	133	81	1	44,50

Borddurchlass, 90° mit Schlauchanschluss / A4-AISI 316
Thru-hull, 90° with hose connection / Pass-coque à 90°

8749

Bestell-Nr. Order no.	Größe Size	A	L	C	D	E	Box	*€/Stück *€/piece
8749434	3/4"	19	81	33	48	28	1	14,50
874941_12	1 1/2"	38	119	40	60	33	1	16,00

Mit Edelstahl Oberteil – Borddurchlass Stalon
With stainless steel upper part - Stalon thru-hull

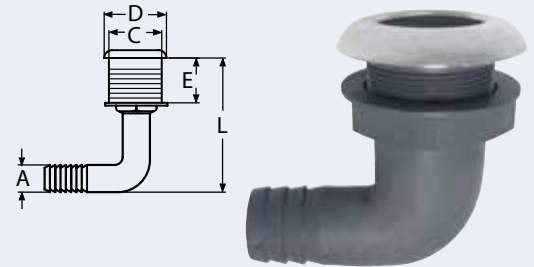

Borddurchlass, 90° mit Schlauchanschluss / A4-AISI 316
Thru-hull, 90° with hose connection / Pass-coque à 90°

8893

Bestell-Nr. Order no.	Größe Size	A	L	C	D	E	Box	*€/Stück *€/piece
8893434	3/4"	19	65	32	41	19	1	29,00
889341	1"	25	69	32	41	19	1	33,00
889341_12	1 1/2"	38	89	40	60	19	1	52,00

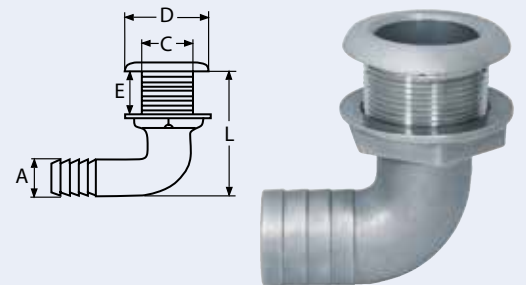

Kugelventil / A4-AISI 316
Ball valve / Vanne 1/4 de tour

8621

Bestell-Nr. Order no.	Größe Size	Box	*€/Stück *€/piece
8621438	3/8"	1	20,00
8621412	1/2"	1	24,00
8621434	3/4"	1	30,50
862141	1"	1	48,50
862141_14	1 1/4"	1	67,00
862141_12	1 1/2"	1	93,50



3-Wege Kugelventil / A4-AISI 316
Three-way ball valve / Vanne 1/4 de tour 3 voies

8745

Bestell-Nr. Order no.	Größe Size	Box	*€/Stück *€/piece
874541_12	1 1/2"	1	120,00



8638

T-Stück mit Innengewinde / A4-AISI 316

Tee with internal thread / Té femelle -femelle en laiton



Bestell-Nr. Order no.	Größe Size	Box	*€/Stück *€/piece
8638438	3/8"	1	5,70
8638412	1/2"	1	7,00
8638434	3/4"	1	8,00
863841	1"	1	10,50
863841_14	1 1/4"	1	24,10
863841_12	1 1/2"	1	27,40

8606

Anschlußstück mit Innengewinde / A4-AISI 316

Connector with internal thread / Raccord



Bestell-Nr. Order no.	Größe Size	Box	*€/Stück *€/piece
8606438	3/8"	1	2,90
8606412	1/2"	1	3,40
8606434	3/4"	1	5,30
860641	1"	1	6,80
860641_14	1 1/4"	1	14,20
860641_12	1 1/2"	1	15,00

8623

Rohrbogen, 45° mit Innengewinde / A4-AISI 316

Elbow, 45° with internal thread / Coude femelle 45° - femelle en laiton



Bestell-Nr. Order no.	Größe Size	Box	*€/Stück *€/piece
8623438	3/8"	1	3,10
8623412	1/2"	1	3,60
8623434	3/4"	1	6,00
862341	1"	1	7,00
862341_14	1 1/4"	1	11,40
862341_12	1 1/2"	1	12,50

8625

Rohrbogen, 90°, mit Innen- und Außengewinde / A4-AISI 316

Elbow, 90°, with internal and external thread / Coude mâle-femelle 90°



Bestell-Nr. Order no.	Größe Size	Box	*€/Stück *€/piece
8625438	3/8"	1	3,00
8625412	1/2"	1	4,30
8625434	3/4"	1	7,60
862541	1"	1	9,00
862541_14	1 1/4"	1	12,20
862541_12	1 1/2"	1	16,60

Rohrbogen, 90°, mit Innengewinde / A4-AISI 316
Elbow, 90°, with internal thread / Coude femelle 90° femelle en laiton

8624

Bestell-Nr. Order no.	Größe Size	Box	*€/Stück *€/piece
8624438	3/8"	1	2,70
8624412	1/2"	1	3,80
8624434	3/4"	1	4,50
862441	1"	1	7,00
862441_14	1 1/4"	1	9,80
862441_12	1 1/2"	1	14,10



Schlauchanschluss mit Außengewinde / A4-AISI 316
Hose connection with external thread / Embout mâle

8622

Bestell-Nr. Order no.	Größe Size	Schlauch-Ø innen Hose-Ø inside	Box	*€/Stück *€/piece
8622438	3/8"	10	1	4,30
8622412	1/2"	12	1	6,10
8622434	3/4"	19	1	7,20
862241	1"	26	1	10,50
862241_14	1 1/4"	32	1	13,30
862241_12	1 1/2"	38	1	20,50



Schlauchanschluss mit Innengewinde / A4-AISI 316
Hose connection with internal thread / Embout femelle

8640

Bestell-Nr. Order no.	Größe Size	Schlauch-Ø innen Hose-Ø inside	Box	*€/Stück *€/piece
8640438	3/8"	10	1	4,20
8640412	1/2"	12	1	5,00
8640434	3/4"	19	1	13,50
864041	1"	26	1	18,50
864041_14	1 1/4"	32	1	20,50
864041_12	1 1/2"	38	1	22,50



Doppelgewindestück / A4-AISI 316
Double thread / Mamelon

8627

Bestell-Nr. Order no.	Größe Size	Box	*€/Stück *€/piece
8627438	3/8"	1	2,00
8627412	1/2"	1	2,80
8627434	3/4"	1	5,80
862741	1"	1	6,00
862741_14	1 1/4"	1	8,80
862741_12	1 1/2"	1	10,50



8626
Reduziergewindestück mit Innen- und Außengewinde / A4-AISI 316
 Reducer with internal and external thread / Réduction mâle-femelle

Bestell-Nr. Order no.	Außengewinde External thread	Innengewinde Internal thread	Box	*€/Stück *€/piece
8626412	1/2"	3/8"	1	4,20
8626434	3/4"	1/2"	1	5,10
862641	1"	3/4"	1	6,10
862641_14	1 1/4"	1"	1	7,50
862641_12	1 1/2"	1 1/4"	1	9,00

8659
Wasserhahn / A4-AISI 316
 Water faucet / Robinet de cockpit

Bestell-Nr. Order no.	Wandanschluss Wall connection	Schlauchanschluss Hose connection	Box	*€/Stück *€/piece
8659434_1	1/2"	3/4"	1	80,00

8761
Schweißbogen, 90° / A4-AISI 316
 Welding bend 90° / Coude à souder 90°

Bestell-Nr. Order no.	Größe Size	Materialstärke Tension thickness	Box	*€/Stück *€/piece
876141_12	1 1/2" (42,4 mm)	2,0	1	32,70

814563
Reduziergewindestück mit Innen- und Außengewinde / Messing
 Reducer with internal and external thread - brass / Réducteur mâle -femelle en laiton

Bestell-Nr. Order no.	Innengewinde Internal thread	Außengewinde External thread	Box	*€/Stück *€/piece
814563514_38	1/4"	3/8"	1	2,90
814563538_12	3/8"	1/2"	1	5,00
814563512_34	1/2"	3/4"	1	5,50
814563534_1	3/4"	1"	1	6,80
81456351_112	1"	1 1/2"	1	21,50
8145635114_112	1 1/4"	1 1/2"	1	22,50

Doppelgewindestück mit Außengewinde / Messing
Double thread with external thread, brass / Mamelon en laiton

814564

Bestell-Nr. Order no.	Größe Size	Box	*€/Stück *€/piece
814564514	1/4"	1	3,30
814564538	3/8"	1	3,60
814564512	1/2"	1	4,00
814564534	3/4"	1	5,00
81456451	1"	1	10,00
81456451_14	1 1/4"	1	11,90
81456451_12	1 1/2"	1	15,50



Reduziergewindestück mit Außengewinde / Messing
Reducer with external thread, brass / Réducteur mâle -mâle en laiton

814565

Bestell-Nr. Order no.	Größe 1 Size 1	Größe 2 Size 2	Box	*€/Stück *€/piece
814565514	1/4"	3/8"	1	3,50
814565538	3/8"	1/2"	1	4,40
814565512	1/2"	3/4"	1	5,50
814565534	3/4"	1"	1	8,00
81456551	1"	1 1/4"	1	11,90
81456551_14	1 1/4"	1 1/2"	1	14,20



Anschlußstück mit Innengewinde / Messing
Connector with internal thread, brass / Manchon femelle en laiton

814566

Bestell-Nr. Order no.	Größe Size	Box	*€/Stück *€/piece
814566538	3/8"	1	3,80
814566512	1/2"	1	7,60
814566534	3/4"	1	8,00
81456651	1"	1	10,00
81456651_14	1 1/4"	1	12,50
81456651_12	1 1/2"	1	15,70



Rohrbogen, 90° mit Innen- und Außengewinde / Messing
Elbow, 90° with internal and external thread, brass / Coude 90° mâle- femelle en laiton

814567

Bestell-Nr. Order no.	Größe Size	Box	*€/Stück *€/piece
814567514	1/4"	1	3,70
814567538	3/8"	1	6,50
814567512	1/2"	1	7,10
814567534	3/4"	1	11,40
81456751	1"	1	14,20
81456751_14	1 1/4"	1	31,80
81456751_12	1 1/2"	1	38,80



814568

Rohrbogen, 90° mit Innengewinde / Messing

Elbow, 90° with internal thread, brass / Coude 90° femelle - femelle en laiton



Bestell-Nr. Order no.	Größe Size	Box	*€/Stück *€/piece
814568514	1/4"	1	2,40
814568538	3/8"	1	4,80
814568512	1/2"	1	7,10
814568534	3/4"	1	9,00
81456851	1"	1	30,00
81456851_14	1 1/4"	1	43,00
81456851_12	1 1/2"	1	73,00

814569

T-Stück mit Innengewinde / Messing

Tee with internal thread, brass / Tê femelle - femelle en laiton



Bestell-Nr. Order no.	Größe Size	Box	*€/Stück *€/piece
814569514	1/4"	1	4,40
814569538	3/8"	1	5,50
814569512	1/2"	1	9,80
814569534	3/4"	1	10,20
81456951	1"	1	24,30
81456951_14	1 1/4"	1	25,00
81456951_12	1 1/2"	1	52,00

814572

Schlauchanschluss mit Innengewinde / Messing

Hose connection with internal thread, brass / Embout filetage - femelle en laiton



Bestell-Nr. Order no.	Größe Size	Schlauch-Ø innen Hose-Ø inside	Box	*€/Stück *€/piece
814572514_10	1/4"	10	1	4,00
814572514_13	1/4"	13	1	5,20
814572538_10	3/8"	10	1	4,70
814572538_13	3/8"	13	1	4,90
814572512_13	1/2"	13	1	6,90
814572512_19	1/2"	19	1	7,10
814572534_20	3/4"	20	1	7,60
81457251_25	1"	25	1	8,10
8145725114_32	1 1/4"	32	1	13,50
8145725112_38	1 1/2"	38	1	9,30
81457252_50	2"	50	1	27,50

Schlauchanschluss mit Außengewinde / Messing

Hose connection with external thread, brass / Embout filetage mâle en laiton

814573

Bestell-Nr. Order no.	Größe Size	Schlauch-Ø innen Hose-Ø inside	Box	*€/Stück *€/piece
814573514_08	1/4"	8	1	3,80
814573514_10	1/4"	10	1	3,90
814573514_13	1/4"	13	1	4,00
814573538_10	3/8"	10	1	4,10
814573538_13	3/8"	13	1	4,40
814573512_13	1/2"	13	1	5,00
814573512_16	1/2"	16	1	5,10
814573512_20	1/2"	20	1	5,40
814573534_19	3/4"	19	1	6,70
814573534_25	3/4"	25	1	7,60
814573510_25	1"	25	1	7,80
8145735114_32	1 1/4"	32	1	10,00
8145735112_38	1 1/2"	38	1	16,30
81457352_50	2"	50	1	19,50



Endkappe mit Außengewinde / Messing

End cap with external thread, brass / Bouchon mâle en laiton

814574

Bestell-Nr. Order no.	Größe Size	Box	*€/Stück *€/piece
814574514	1/4"	1	1,90
814574538	3/8"	1	3,20
814574512	1/2"	1	3,80
814574534	3/4"	1	3,90
81457451	1"	1	4,10
8145745114	1 1/4"	1	5,80

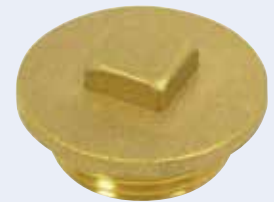

Borddurchlass mit Außengewinde / Messing

Thru-hull with external thread, brass / Passe coque fileté en laiton

814576

Bestell-Nr. Order no.	Größe Size	Box	*€/Stück *€/piece
814576538	3/8"	1	7,00
814576512	1/2"	1	14,40
814576534	3/4"	1	21,00
81457651	1"	1	27,80
81457651_14	1 1/4"	1	31,70
81457651_12	1 1/2"	1	48,00
81457652	2"	1	81,00



Wassereinlass mit Außengewinde / Messing

Water intake with external thread, brass / Crépine passe coque en laiton

814577

Bestell-Nr. Order no.	Größe Size	Box	*€/Stück *€/piece
814577512	1/2"	1	35,40
814577534	3/4"	1	44,10
81457751	1"	1	53,30
81457751_14	1 1/4"	1	65,70
81457751_12	1 1/2"	1	84,00
81457752	2"	1	129,90



Kapitel 11

Chapter 11

Beleuchtung und Elektrik

Cabin lighting and electrical equipment





Die Lampe verwendet Halogenglühbirnen
The light uses halogen bulbs



Besonders leistungsstarke LED-Klasse, die mit satten Strömen von 350 - 1000 mA befeuert werden kann.
Especially powerful LED class which can be operated with high currents of 350 - 1000 mA. This allows a very high light yield.



Lampe wird inkl. Batterien geliefert
Light delivered incl. batteries.



Anzahl der LED's
Number of LED's



Als Lumen wird die Einheit des Lichtstromes bezeichnet. Dies ist die gesamte sichtbare Lichtmenge, die eine Lampe verlässt.
The unit of luminous flux is called lumen.
This is the total amount of visible light that leaves a lamp.



Lampe ist wasserdicht
Light is waterproof



Lampe ist spritzwassergeschützt
Light is protected against splash water



Leuchtdauer per Batterieladung
Working time with fresh batteries

8645

Toplicht / A2-AISI 304
Stern light / Feu sur hampe

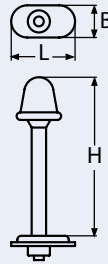

Bestell-Nr. Order no.	H	L	B	Volt	Box	*€/Stück *€/piece
86452580	580	95	45	12	1	58,00

Herausnehmbar / Detachable



8646

Toplicht / A2-AISI 304
Stern light / Feu sur hampe

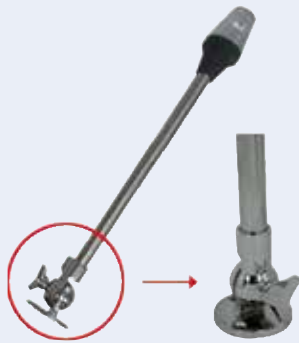

Bestell-Nr. Order no.	H	D	Volt	Box	*€/Stück *€/piece
86462660	660	55	12	1	62,00

Verstellbar / Adjustable



8644

Toplicht / A2-AISI 304
Stern light / Feu sur hampe



Bestell-Nr. Order no.	H	L	B	Volt	Box	*€/Stück *€/piece
86442630	630	85	50	12	1	51,00



8643

Toplicht / A2-AISI 304
Stern light / Feu sur hampe

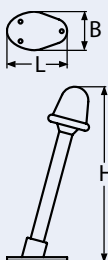

Bestell-Nr. Order no.	H	L	B	Volt	Box	*€/Stück *€/piece
86432250	250	85	50	12	1	42,00



Positionslampen für Boote bis 12m

Navigation lights for boats up to 12m / Feux de navigation pour bateaux jusqu'à 12m.

814103

Bestell-Nr. Order no.	Position Position	Farbe Colour	Grad° Degrees°	Volt	Watt	Box	*€/Stück *€/piece
8141033SG	Seite/Side	Grün/Green	112,5	12	10	1nm	1 16,00
8141033SR	Seite/Side	Rot/Red	112,5	12	10	1nm	1 16,00
8141033TW	Top	Weiß/White	225,0	12	10	2nm	1 16,00
8141033HW	Heck	Weiß/White	135,0	12	10	2nm	1 16,00
8141033KRG	Kombi	Rot/Grün Red/Green	112,5	12	10	1nm	1 16,00



Ohne BGH-Zulassung

Positionslampen für Boote bis 20m

Navigation lights for boats up to 20m / Feux de navigation pour bateaux jusqu'à 20m.

814104

Bestell-Nr. Order no.	Position Position	Farbe Colour	Grad° Degrees°	Volt	Watt	Box	*€/Stück *€/piece
8141043SG	Seite/Side	Grün/Green	112,5	12	25	2nm	1 44,50
8141043SR	Seite/Side	Rot/Red	112,5	12	25	2nm	1 44,50
8141043TW	Top	Weiß/White	225,0	12	10	3nm	1 44,50
8141043HW	Heck	Weiß/White	135,0	12	10	2nm	1 44,50
8141043KRG	Kombi	Rot/Grün Red/Green	122,5	12	25	2nm	1 44,50



Ohne BGH-Zulassung

NEW

LED Positionslampe für Boote bis 12m, schwarz

LED Navigation lights for boats up to 12m black / Feu bicolore boîtier noir - pour bateau jusqu'à 12 Mètres

814675

Bestell-Nr. Order no.	Position Position	Farbe Colour	Grad° Degrees°	Volt	Sichtbarkeit Visibility	LM	Box	*€/Stück *€/piece
8146753SG	Seite/Side	Grün/Green	112,5	12	1nm	1,67	1	22,00
8146753SR	Seite/Side	Rot/Red	112,5	12	1nm	2,89	1	22,00
8146753TW	Top	Weiß/White	225,0	12	2nm	42,5	1	22,00
8146753HW	Heck/Stern	Weiß/White	135,0	12	2nm	42,5	1	22,00
8146753KRG	Kombie	Rot-Grün Red-Green	112,5	12	2nm	2,2	1	22,00



= 8146753KRG

Ohne BGH-Zulassung

NEW

LED Positionslampe für Boote bis 12m, weiß

LED Navigation lights for boats up to 12m white / Feu bicolore boîtier blanc - pour bateau jusqu'à 12 Mètres

814676

Bestell-Nr. Order no.	Position Position	Farbe Colour	Grad° Degrees°	Volt	Sichtbarkeit Visibility	LM	Box	*€/Stück *€/piece
8146763SG	Seite/Side	Grün/Green	112,5	12	1nm	1,67	1	22,00
8146763SR	Seite/Side	Rot/Red	112,5	12	1nm	2,89	1	22,00
8146763TW	Top	Weiß/White	225,0	12	2nm	42,5	1	22,00
8146763HW	Heck/Stern	Weiß/White	135,0	12	2nm	42,5	1	22,00
8146763KRG	Kombie	Rot-Grün Red-Green	112,5	12	2nm	2,2	1	22,00



= 8146763KRG

Ohne BGH-Zulassung

8692

Halogen-Salingleuchte, wasserdicht / A2-AISI 304

Halogen spreader light, waterproof / Projecteur pour bar de flèche étanche

Ohne Gelenk
Without joint



Mit Gelenk
With joint

Bestell-Nr. Order no.	Socket Socket	Ø	Volt	Watt	Box	*€/Stück *€/piece
86922115	Ohne Gelenk Without joint	115	12	55	1	48,00
86922115GELENK	Mit Gelenk With joint	115	12	55	1	52,00



8594

Halogen Decksleuchte / A2-AISI 304

Halogen deck light / Plafonnier

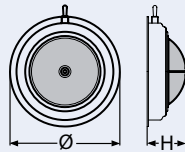

Bestell-Nr. Order no.	Ø	H	Volt	Watt	Licht Light	Box	*€/Stück *€/piece
85942172	172	45	12	20	Rot/Weiß Red/White	1	38,50



814148

Cockpit Beleuchtung / A2-AISI 304

Cockpit light / Lampe de cabine

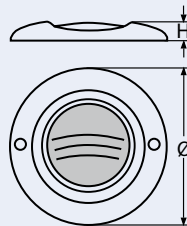

Bestell-Nr. Order no.	Ø	H	Volt	Watt	Box	*€/Stück *€/piece
8141482	80	15	12	10	1	17,80

8841

Halogen Deckslicht

Halogen deck light / Plafonnier halogène

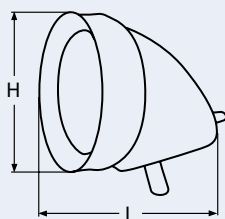

Bestell-Nr. Order no.	Material	L	H	Volt	Watt	Box	*€/Stück *€/piece
88413W	PVC Weiß/White	150	130	12	35	1	39,00
88413S	PVC Schwarz/Black	150	130	12	35	1	39,00



Halogen Leselampe

Halogen reading light / Lampe de cabine

8842

Bestell-Nr. Order no.	Material	Ø	H	Volt	Watt	Box	*€/Stück *€/piece
88427S	Messing, verchr. Brass, chrome plated	100	170	12	10	1	29,50
88427G	Messing Brass	100	170	12	10	1	29,50

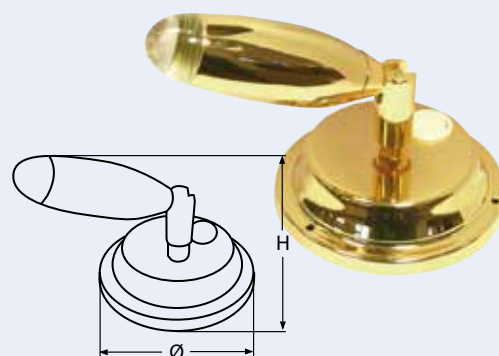

Halogen Leselampe

Halogen reading light / Lampe de cabine

8843

Bestell-Nr. Order no.	Material	Ø	H	Volt	Watt	Box	*€/Stück *€/piece
88437S	Messing verchr. Brass, chrome plated	75	120	12	10	1	41,50
88437G	Messing Brass	75	120	12	10	1	41,50

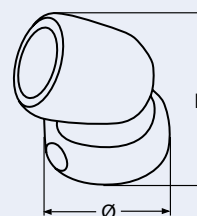

Halogen Leselampe, flexibel

Halogen reading light flexible / Lampe de cabine

8844

Bestell-Nr. Order no.	Material	Ø	H	Volt	Watt	Box	*€/Stück *€/piece
88447S	Messing verchr. Brass, chrome plated	80	200	12	10	1	45,00
88447G	Messing Brass	80	200	12	10	1	45,00

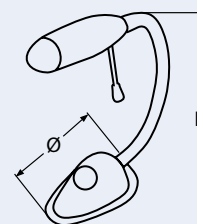

Halogen Leselampe

Halogen reading light / Lampe de cabine

8845

Bestell-Nr. Order no.	Material	Ø	H	Volt	Watt	Box	*€/Stück *€/piece
88457S	Messing verchr. Brass, chrome plated	70	100	12	10	1	53,00
88457G	Messing Brass	70	100	12	10	1	53,00

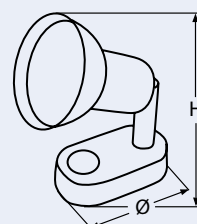

Beleuchtung und Elektrik

Cabin lighting and electrical equipment

Lampes de cabines - électricité

8738

Halogen Wandlampe

Halogen interior light / Applique halogène

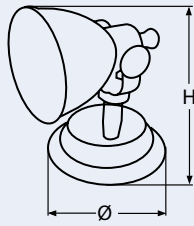

Bestell-Nr. Order no.	Material	Ø	H	Volt	Watt	Box	*€/Stück *€/piece
87385	Messing/Brass	85	100	12	10	1	49,90



8736

Halogen Wandlampe

Halogen interior light / Luminaire

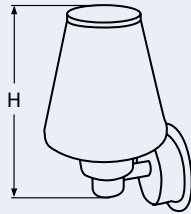

Bestell-Nr. Order no.	Material	H	Volt	Watt	Box	*€/Stück *€/piece
87365	Messing/Brass	190	12	10	1	33,00



8741

Halogen Deckenlampe, Aufbau

Halogen ceiling light, surface mount / Plafonnier halogène

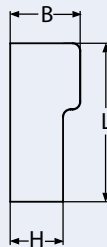

Bestell-Nr. Order no.	Material	L	B	H	Volt	Watt	Box	*€/Stück *€/piece
8741390_25	Plastik/Plastic	90	25	20	12	10	1	16,80



8740

Halogen Deckenlampe, Aufbau

Halogen ceiling light, surface mount / Plafonnier halogène

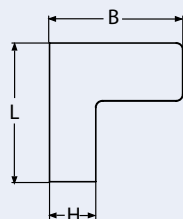

Bestell-Nr. Order no.	Material	L	B	H	Volt	Watt	Box	*€/Stück *€/piece
8740380_50	Plastik Plastic	80	50	18	12	10	1	23,00



Halogen Deckenlampe, Einbau

Halogen ceiling light, flush mount / Plafonnier halogène

814199

Bestell-Nr. Order no.	Ø	Volt	Watt	Box	*€/Stück *€/piece
814199375	75	12	5	1	6,90

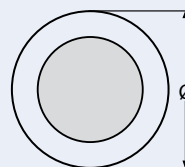

Halogen Deckenlamp, Einbau

Halogen ceiling light, flush mount / Plafonnier halogène

814200

Bestell-Nr. Order no.	Ø	Volt	Watt	Box	*€/Stück *€/piece
8142003125	125	12	5	1	9,50

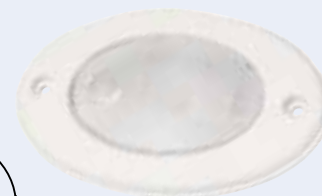
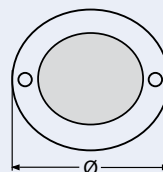

Deckenlampe, Aufbau

Ceiling light, surface mount / Plafonnier

814204

Bestell-Nr. Order no.	L	B	Volt	Watt	Box	*€/Stück *€/piece
8142043190_110	190	110	12	18	1	6,00

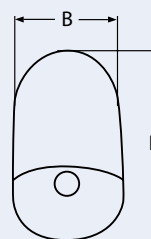

Halogen Deckenlampe, Einbau

Halogen ceiling light, flush mount / Spot halogène

8758

Bestell-Nr. Order no.	Material	Ø	H	Volt	Watt	Box	*€/Stück *€/piece
87587	Messing verchr. Brass chrome plated	80	28	12	10	1	12,00

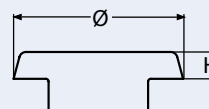

8694

Innenleuchte, Aufbau / A2-AISI 304

Dome light, surface mount / Plafonnier

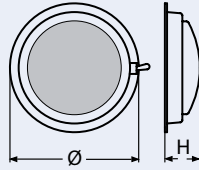

Bestell-Nr. Order no.	Ø	H	Volt	Watt	Box	*€/Stück *€/piece
86942110	110	35	12	8	1	24,00
86942140	140	35	12	15	1	26,00

8693

Innenleuchte, Aufbau / A2-AISI 304

Dome light, surface mount / Plafonnier avec 2 positions d'éclairage

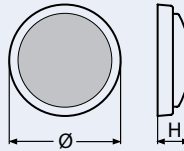

Bestell-Nr. Order no.	Ø	H	Volt	Watt	Box	*€/Stück *€/piece
86932105	105	30	12	10	1	29,00
86932145	145	30	12	10 + 20	1	31,00

Ein/Aus und Sparschaltung (10 + 20 Watt)
On/off and economy circuit (10 + 20 Watt)

8739

Halogen Deckenlampe, Einbau

Halogen ceiling light, flush mount / Plafonnier halogène

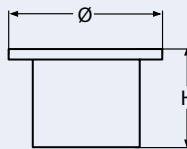

Bestell-Nr. Order no.	Material	Ø	H	Volt	Watt	Box	*€/Stück *€/piece
8739565_32	Messing/Brass	65	32	12	20	1	25,00
8739765_32	Messing verchr. Brass, chrome plated	65	32	12	20	1	29,00



8759

Halogen Deckenlampe, Einbau

Halogen ceiling light, flush mount / Spot halogène

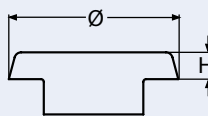

Bestell-Nr. Order no.	Material	Ø	H	Volt	Watt	Box	*€/Stück *€/piece
8759570_25	Messing/Brass	70	25	12	5	1	14,00



Halogen Deckenlampe, Aufbau

Halogen ceiling light, surface mount / Plafonnier halogène

8742

Bestell-Nr. Order no.	Material	Ø	H	Volt	Watt	Box	*€/Stück *€/piece
8742365_20	Plastik/Plastic	65	20	12	10	1	11,40

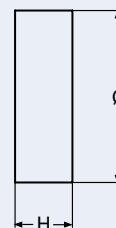

Halogen Deckenlampe, Aufbau

Halogen ceiling light, surface mount / Plafonnier halogène

814205

Bestell-Nr. Order no.	Ø	H	Volt	Watt	Box	*€/Stück *€/piece
814205380	80	45	12	10	1	11,00

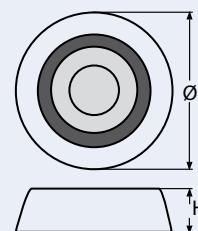

Halogen Deckenlampe, variabel

Halogen ceiling light, variable / Plafonnier halogène à éclairage réglable

814051

Bestell-Nr. Order no.	Ø	H	H1	Volt	Watt	Box	*€/Stück *€/piece
814051385_27	85	26	12	12	10	1	11,20

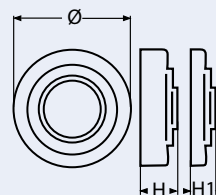

Halogen Deckenlampe, oval, variabel / Plastik

Halogen ceiling light, oval, variable / Plafonnier halogène ovale variable en plastique

814259

Bestell-Nr. Order no.	L	B	Volt	Watt	Box	*€/Stück *€/piece
8142593119	119	100	12	5	1	13,60

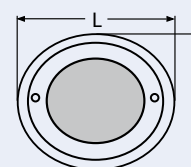



Halogen Deckenlampe, Aufbau / Plastik

Halogen ceiling light, surface mount / Plafonier halogène - Plastique

814262

Bestell-Nr. Order no.	Ø	Volt	Watt	Box	*€/Stück *€/piece
8142623110	110	12	10	1	11,70

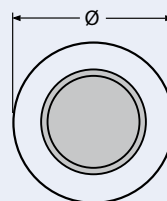

Halogenleuchte / A2-AISI 304

Halogen light / Lampe halogène

8655

Bestell-Nr. Order no.	H	Ø	B	C	Volt	Watt	Box	*€/Stück *€/piece
86552120_85	120	85	75	30	12	10	1	34,00

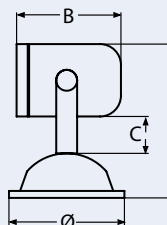

Einbaulampe, oval / Messing verchromt

Installation light oval, chrome plated brass / Eclairage oval - Laiton chromé plaqué

814251

Bestell-Nr. Order no.	L	B	Volt	Watt	Box	*€/Stück *€/piece
814251754_40	54	40	12	5	1	12,60

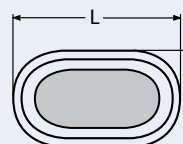

Einbaulampe, eckig / Messing verchromt

Installation light, square, chrome plated brass / Eclairage carré - Laiton chromé plaqué

814252

Bestell-Nr. Order no.	L	B	Volt	Watt	Box	*€/Stück *€/piece
814252739_39	39	39	12	5	1	12,60

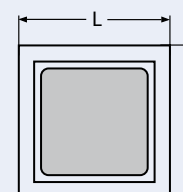

814253

Einbaulampe, rund / Messing verchromt

Installation light round, chrome plated brass / Eclairage rond - Laiton chromé plaqué

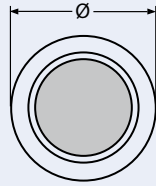

Bestell-Nr. Order no.	Ø	Volt	Watt	Box	*€/Stück *€/piece
814253738	38	12	5	1	12,00

814332

Halogen Spotlight mit Fernbedienung / Plastik

Halogen spotlight with remote control / Projecteur halogène avec télécommande - plastique

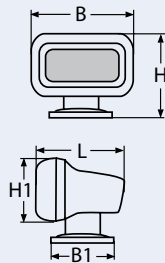

Bestell-Nr. Order no.	L	B	H	B1	H1	Volt	Watt	Box	*€/Stück *€/piece
8143323265	230	210	200	150	145	12	55	1	440,00

- Wasserfest
- Mit magnetischem Fuß
- Rotation: 420°
- Neigungswinkel: 120°
- Inkl. 2 Anschlusskabel: Zigarettenanzünder und Bordnetz-kabel
- Waterproof
- With magnetic foot
- Rotation: 420°
- Angle of dip: 120°
- Incl. 2 connection cables: cigarette jack and harness cable



814698

High power LED Scheinwerfer 9 LEDs / Alu

High Power LED spotlight 9 LED's / Projecteur 9 LED

NEW

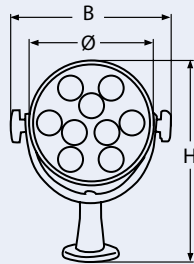

Bestell-Nr. Order no.	Ø	H	B	Volt	Watt	Box	*€/Stück *€/piece
8146980140	140	257,5	179	12	9 x 3	1	250,00



814203

Flexible LED Lampe

Flexible LED light / Lampe LED flexible



Bestell-Nr. Order no.	L	Volt	Box	*€/Stück *€/piece
8142030420	420	12	1	18,20



LED Schienenlampe, Aufbau

LED rail light, surface mount / Lampe LED sur rail

814202

Bestell-Nr. Order no.	L	B	H	Volt	Box	*€/Stück *€/piece
8142023173_30	173	30	30	12	1	20,80

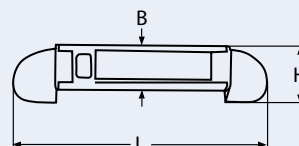

LED Leuchte, wassergeschützt, Einbau

LED light, water protected, flush mount / Lampe de cabine étanche

8760

Bestell-Nr. Order no.	LED	H	B	Volt	Watt	Box	*€/Stück *€/piece
87603WEISS	Weiß/White	80	28	12	6	1	14,00
87603ROT	Rot/Red	80	28	12	6	1	14,00



weiß/white rot/red

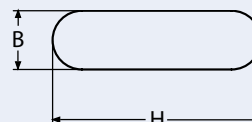

LED Leuchte, wassergeschützt, Einbau

LED light, water protected, flush mount / Spot étanche

8691

Bestell-Nr. Order no.	LED	Farbe Colour	Ø	D	H	Volt	Watt	Box	*€/Stück *€/piece
86913WEISS	Weiß/ ¹	Weiß/ ¹	75	49	25	12	10	1	16,80
86913ROT	Rot/ ²	Weiß/ ¹	75	49	25	12	10	1	16,80

¹ White, ² Red



weiß/white rot/red

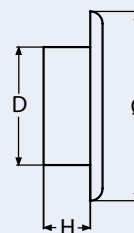

Kabellose LED Lampe / Plastik

Wireless LED light / Lampe LED sans fil

814191

Bestell-Nr. Order no.	Ø	H	Box	*€/Stück *€/piece
814191370	70	20	5	3,60

Inkl. 3 x AAA Batterie
Incl. 3 x AAA battery

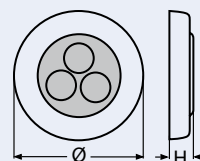

Beleuchtung und Elektrik

Cabin lighting and electrical equipment

Lampes de cabines - électricité

8755

LED Leselampe

LED reading light / Lampe de cabine

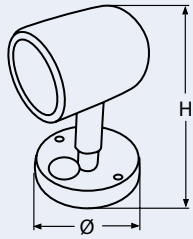

Bestell-Nr. Order no.	Material	Ø	H	Volt	Box	*€/Stück *€/piece
8755540	Messing/Brass	85	100	12	1	63,00
8755740	Messing-verchr. Brass, chrome plated	85	100	12	1	64,00



8737

LED Wandlampe

LED interior light / Applique

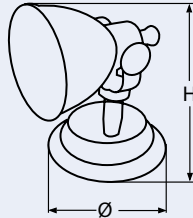

Bestell-Nr. Order no.	Material	Ø	H	Volt	Box	*€/Stück *€/piece
87375	Messing/Brass	85	100	12	1	62,00
8737ERSATZ	Ersatzlampe Replacement light	85	100	12	1	18,00



814201

LED Deckenlampe, Einbau

LED ceiling light, flush mount / Plafonnier LED

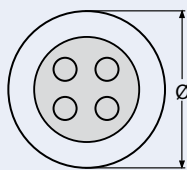

Bestell-Nr. Order no.	Ø	Volt	Box	*€/Stück *€/piece
814201375	75	12	1	19,90



814219

LED Deckenlampe, 6 LEDs, variabel

Led ceiling light, 6 LEDs, variable / Eclairage 6 Lampes LED

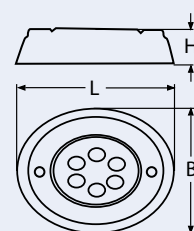

Bestell-Nr. Order no.	L	B	H	Volt	Box	*€/Stück *€/piece
8142193130	130	90	30	12	1	22,20



NEW

High Power LED Minideckenlampe / Alu
LED High power mini ceiling light

814677

Bestell-Nr. Order no.	Ø	H	Volt	Watt	Box	*€/Stück *€/piece
814677040	40	17	12	1	1	34,00

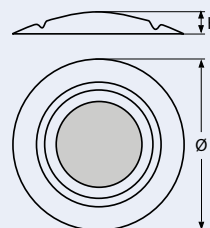

High Power LED Deckenlampe, verstellbar, Einbau / Alu
High power LED ceiling light, adjustable, flush mount / Plafonnier ultra-puissant et réglable en alu. Éclairage par LED

814140

Bestell-Nr. Order no.	Ø	H	Volt	Watt	Box	*€/Stück *€/piece
814677040	84	20	12	3	1	66,00

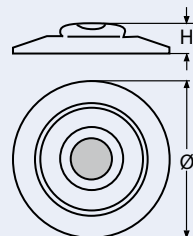

High Power LED Deckenlampe / Alu
High power LED ceiling light / Plafonnier ultra-puissant en alu. Éclairage par LED

814141

Bestell-Nr. Order no.	Ø	H	Volt	Watt	Box	*€/Stück *€/piece
8141410	85	20	12	3	1	66,00

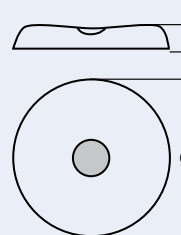

High Power LED Deckenlampe, Einbau / Alu
High power LED ceiling light, flush mount / Plafonnier ultra-puissant en alu. Éclairage par LED

814138

Bestell-Nr. Order no.	Ø	H	Volt	Watt	Box	*€/Stück *€/piece
8141380	54	40	12	1	1	40,00

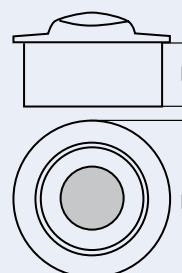

11

814144

High Power LED Deckenlampe, Einbau / Alu

High power LED ceiling light, flush mount / Plafonnier ultra-puissant en alu. Éclairage par LED

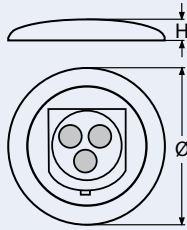

Bestell-Nr. Order no.	Ø	H	Volt	Watt	Box	*€/Stück *€/piece
8141440	130	75	12	3	1	118,00



814145

High Power LED Deckenlampe, Einbau / Alu

High power LED ceiling light, flush mount / Plafonnier ultra-puissant en alu. Éclairage par LED

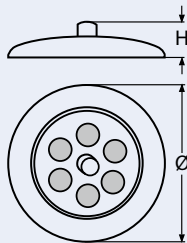

Bestell-Nr. Order no.	Ø	H	Volt	Watt	Box	*€/Stück *€/piece
8141450	130	43	12	6	1	176,00



814257

High Power LED Deckenlampe, extra flach, Einbau / Alu

High power LED ceiling light, flat type, flush mount / Eclairage LED ultra puissant en Alu

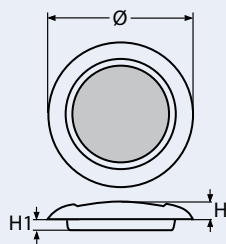

Bestell-Nr. Order no.	Ø	H	H1	Volt	Watt	Box	*€/Stück *€/piece
8142570	85	7	5	12	3	1	53,00



814050

LED Deckenlampe, Aufbau / Plastik

LED ceiling light, surface mount / Plafonnier à LED

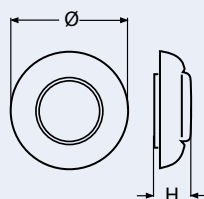

Bestell-Nr. Order no.	Ø	H	Volt	Box	*€/Stück *€/piece
8140503100_45	100	45	12	1	34,60



LED Deckenlampe, Einbau / Plastik
LED ceiling light, flush mount / Plafonnier à LED

814049

Bestell-Nr. Order no.	Ø	H	Volt	Box	*€/Stück *€/piece
8140493100_45	100	45	12	1	32,00

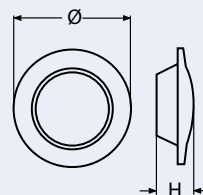

High Power LED 6 Farben Deckenlampe, Einbau / Plastik

6 colour high power LED ceiling light, flush mount / Plafonnier en plastique. Éclairage par LED 6 couleurs

814142

Bestell-Nr. Order no.	Ø	H	Volt	Watt	Box	*€/Stück *€/piece
8141420	60	20	12	1.5	1	65,00

LED Farben: Rot – Grün – Blau – Orange – Pink – Weiß
LED Colours : Red – Green – Blue – Orange – Pink - White

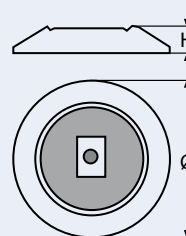

High Power LED Deckenlampe, Einbau / Messing verchromt

High power LED ceiling light, flush mount, brass, chrome plated / Plafonnier ultra-puissant, chromé

814146

Bestell-Nr. Order no.	Ø	H	Volt	Watt	Box	*€/Stück *€/piece
8141463	70	40	12	1	1	44,00

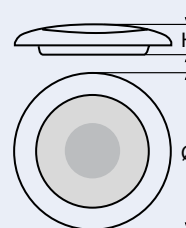

High Power LED Deckenlampe, Einbau / Plastik

High power LED ceiling light, flush mount / Plafonnier en plastique ultra-puissant. Éclairage par LED

814147

Bestell-Nr. Order no.	Ø	H	Volt	Watt	Box	*€/Stück *€/piece
8141473	60	20	12	1	1	33,00

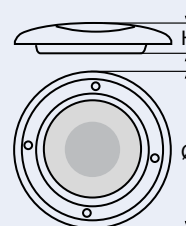

814261

High Power LED Deckenlampe, Aufbau / Plastik

High power LED ceiling light, surface mount / Eclairage LED Grande puissance - plastique

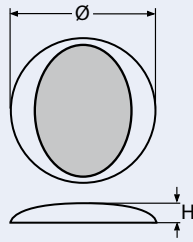

Bestell-Nr. Order no.	Ø	H	Volt	Watt	Box	*€/Stück *€/piece
8142613	130	25	12	3	1	64,00



814263

LED Deckenlampe, variabel / Plastik

LED ceiling light, variable / Eclairage LED variable - Plastique

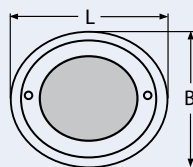

Bestell-Nr. Order no.	L	H	Volt	Box	*€/Stück *€/piece
8142633119	119	100	12	1	22,00



814322

LED Deckenlampe, variabel, 12 LEDs / Plastik

LED ceiling light, variable 12 LED's / Eclairage variable 12 lampes LED - plastique

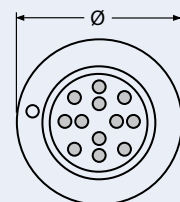

Bestell-Nr. Order no.	Ø	Volt	Box	*€/Stück *€/piece
814322380	80	12	1	24,60



814404

High Power LED 4 Farben Deckenlampe, Einbau / Plastik

4 colours High power LED ceiling light, flush mount / Eclairage LED ultra puissant en plastique

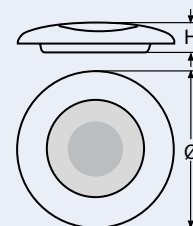

Bestell-Nr. Order no.	Ø	H	Volt	Watt	Box	*€/Stück *€/piece
814404370_25	70	25	12	1	1	59,00

LED Farben: Rot - Grün - Blau - Weiß
LED Colours: Red - Green - Blue - White



High Power LED Deckenlampe, schwenkbar, Einbau / Messing verchromt
High Power LED swivel ceiling light, flush mount, brass, chrome-plated / **

814388

Bestell-Nr. Order no.	Ø	H	Volt	Watt	Box	*€/Stück *€/piece
814388778	78	26	12	1	1	59,00

** Plafonnier pivotant ultra puissant en laiton chrome

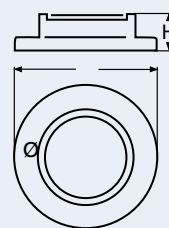

LED Deckenlampe, 3 LEDs, Einbau / A2-AISI 304
LED ceiling light, 3 LED's, flush mount / Plafonnier 3 lampes LED

814405

Bestell-Nr. Order no.	Ø	H	Volt	Box	*€/Stück *€/piece
814405270_25	70	25	12	1	21,00

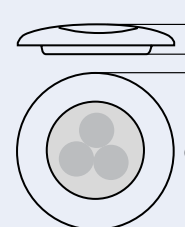

LED Aufbau Deckenlampe, extra flach, 16 LEDs / A2-AISI 304
LED ceiling light, flat type, 16 LEDs, surface mount / Plafonnier 16 lampes LED

814406

Bestell-Nr. Order no.	Ø	H	Volt	Box	*€/Stück *€/piece
814406294_11	94	11	12	1	35,00

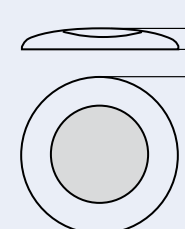

LED Lampe, 6 LEDs, Einbau / Plastik
LED light, 6 LEDs, flush mount / Eclairage encastrable en plastique avec 6 lampes LED

814221

Bestell-Nr. Order no.	L	B	H	Volt	Box	*€/Stück *€/piece
8142213140	140	20	30	12	1	15,50

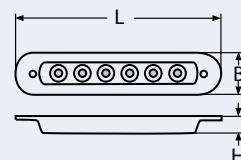

814254

LED Lampe, oval, 4 LEDs, Einbau / verchromt

LED light, oval, 4 LEDs, flush mount, chrome plated / Eclairage oval 4 lampes LED - chromé plaqué

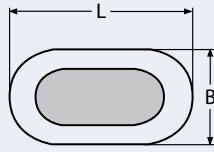

Bestell-Nr. Order no.	L	B	Volt	Box	*€/Stück *€/piece
814254372_39	72	39	12	1	19,00



814256

LED Lampe, oval, 1 LED, Einbau / verchromt

LED light, oval, 1 LED, flush mount, chrome plated / Eclairage oval 1 lampe LED - chrome plaqué

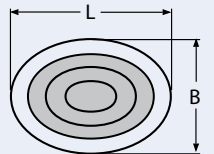

Bestell-Nr. Order no.	L	B	Volt	Box	*€/Stück *€/piece
814256343_30	43	30	12	1	12,80



814324

LED Lampe, 3 LEDs, Einbau / A2-AISI 304

LED light, 3 LEDs, flush mount / Eclairage 3 lampes LED - A2

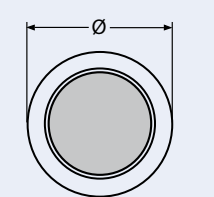

Bestell-Nr. Order no.	Ø	Volt	Box	*€/Stück *€/piece
814324270	70	12	1	20,80



814325

LED Lampe, 2 LEDs, Einbau / A2-AISI 304

LED light, 2 LEDs, flush mount / Eclairage 2 lampes LED - A2

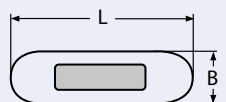

Bestell-Nr. Order no.	L	B	Volt	Box	*€/Stück *€/piece
814325285_30	85	30	12	1	16,70



LED Minilampe, 2 LEDs, Aufbau / Plastik

Mini LED light, 2 LEDs, surface mount / Mini Eclairage 2 lampes LED - plastique

814323

Bestell-Nr. Order no.	L	B	Volt	Box	*€/Stück *€/piece
814323344_20	44	20	12	1	9,00

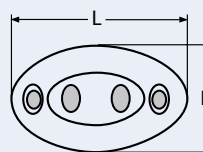

LED Lampe, oval, 5 LEDs, Aufbau / Plastik

LED light, oval, 5 LED's, surface mount / Eclairage oval 5 lampes LED - en plastique

814255

Bestell-Nr. Order no.	L	B	Volt	Box	*€/Stück *€/piece
814255371_38	71	38	12	1	16,50

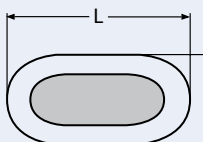

LED Lampe, 3 LEDs, Aufbau / Plastik

LED light, 3 LEDs, surface mount / Eclairage 3 lampe LED en plastique

814258

Bestell-Nr. Order no.	Ø	Volt	Box	*€/Stück *€/piece
814258389	89	12	1	20,00

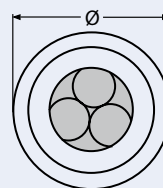

LED Lampe, 6 LEDs, Aufbau / Plastik

LED light, 6 LEDs, surface mount / Eclairage 6 lampes LED en plastique

814260

Bestell-Nr. Order no.	L	B	H	Volt	Box	*€/Stück *€/piece
8142603140	140	17	24	12	1	16,10

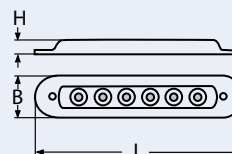

814326

LED Lampe, 20 LEDs, Silber, Aufbau / Plastik

LED light, 20 LEDs, silver, surface mount / Eclairage 20 lampes LED - argent plastique

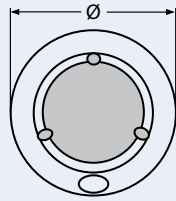

Bestell-Nr. Order no.	Ø	Volt	Box	*€/Stück *€/piece
8143263140	140	12	1	38,00



814686

High Power LED Lampe 6 LEDs / Plastik

High Power LED light 6 LED's / Eclairage LED

NEW

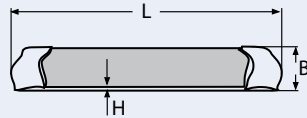

Bestell-Nr. Order no.	L	B	H	Volt	Watt	Box	*€/Stück *€/piece
8146863380	380	66	19	12	6 x 1	1	110,00



814327

LED Lampe, oval, 12 LEDs, variabel / Plastik

LED light, oval, 12 LEDs, variable / Eclairage oval 12 lampes LED - plastique

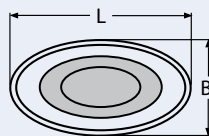

Bestell-Nr. Order no.	L	B	Volt	Box	*€/Stück *€/piece
8143273190	190	110	12	1	53,00



814321

LED Minispot, 360° drehbar, 8 LEDs, Aufbau / Plastik

LED mini spot, 360° turnable, 8 LEDs, surface mount / Mini spot Eclairage orientable 8 lampes LED - plastique

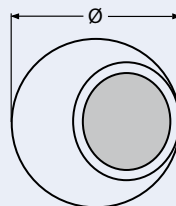

Bestell-Nr. Order no.	Ø	Volt	Box	*€/Stück *€/piece
814321340	40	12	1	16,40



High Power LED Unterwasserlicht, 4 LEDs, Aufbau / A4-AISI 316
High power-underwater LED light, 4 LEDs, surface mount / Plafonnier ultra puissant

814605

Bestell-Nr. Order no.	Ø	H	LED Farbe LED Colour	Volt	Watt	Box	*€/Stück *€/piece
814605494W	94	18	Weiß/White	12	4 x 3	1	230,00
814605494B	94	18	Blau/Blue	12	4 x 3	1	230,00

Lampe arbeitet mit Wasserkühlung.
Montage nur unter der Wasserlinie.
This light has a water cooling system.
Installation under the waterline only.

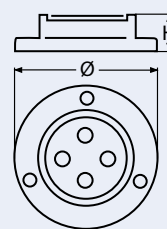

weiß/white blau/blue

NEW

LED Highpower LED / Alu
High Power LED / Eclairage LED

814683

Bestell-Nr. Order no.	L	H	B	LED'S	Volt	Watt	Box	*€/Stück *€/piece
8146830210	210	10	25	3	12	3 x 1	1	45,00
8146830400	400	10	25	6	12	6 x 1	1	90,00

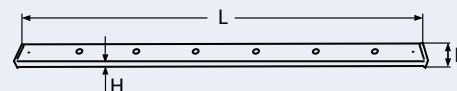

Dimmer / Plastik
Dimmer / Interrupteur

814320

Bestell-Nr. Order no.	L	B	Volt	Watt	Box	*€/Stück *€/piece
814320360	60	60	12	max. 80W	1	51,60

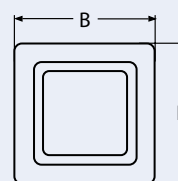

Petroleum Wandlampe
Pertroleum wall lamp / Lampe à pétrole

8744

Bestell-Nr. Order no.	Material	H	Box	*€/Stück *€/piece
87445	Messing, lackiert Brass, varnished	250	1	124,00



Beleuchtung und Elektrik

Cabin lighting and electrical equipment

Lampes de cabines - électricité

814193**Messing Petroleum-Kabinenlampe**

Brass petroleum cabin light / Lampe de cabine à pétrole



Bestell-Nr. Order no.	H	Box	*€/Stück *€/piece
8141935200	200	1	126,00

814194**Messing Petroleum-Kabinenlampe**

Brass petroleum cabin light / Lampe de cabine à pétrole



Bestell-Nr. Order no.	H	Box	*€/Stück *€/piece
8141945200	280	1	166,00

814195**Messing Petroleum-Kabinenlampe**

Brass petroleum cabin light / Lampe de cabine à pétrole



Bestell-Nr. Order no.	H	Box	*€/Stück *€/piece
8141955480	480	1	166,00

814196**Messing Petroleum-Kabinenlampe**

Brass petroleum cabin light / Lampe de cabine à pétrole



Bestell-Nr. Order no.	H	Box	*€/Stück *€/piece
8141965350	350	1	245,00

Messing Petroleum-Kabinenlampe

Brass petroleum cabin light / Lampe de cabine à pétrole

814197

Bestell-Nr. Order no.	H	Box	*€/Stück *€/piece
8141975380	280	1	240,00



Halogen Handlampe, verchromt

Halogen hand spot light, chrome plated / Lampe à main - chromé

8898

Bestell-Nr. Order no.	Volt	Watt	Box	*€/Stück *€/piece
8898355	12	55	1	39,00

Kabellänge 2 m / Cable length 2 m



NEW

Teleskoptaschenlampe mit magnetischem Kopf, 3 LEDs

Telescope flashlight with magnetic head / Lampe torche télescopique avec tête magnétique

814735

Bestell-Nr. Order no.	L	Länge ausgezogen Length extracted	Box	*€/Stück *€/piece
8147350550	170	550	1	15,00

inkl. 3 x AAA Batterien / incl. 3 x AAA battery

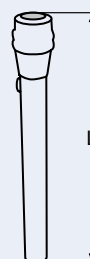

814600

12 Volt LED Akku-Taschenlampe

12 Volt LED rechargeable torch / Lampe de poche rechargeable 12 volt



Bestell-Nr. Order no.	Ø	L	Box	*€/Stück *€/piece
8146003	21	55	1	16,00



814157

LED Stirnleuchte, 7 LEDs

LED headlight, 7 LEDs / Lampe de tête 7 LED



Bestell-Nr. Order no.	Box	*€/Stück *€/piece
8141573	1	6,00



8743

Leuchtstoffröhrenlampe, Aufbau

Fluorescent light, surface mount / Applique néon



Bestell-Nr. Order no.	Material	L	B	H	Volt	Watt	Box	*€/Stück *€/piece
87430375_075	Alu-Ms	375	75	37	12	16	1	67,50
Alu brass								

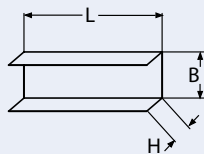

814328

Leuchtstoffröhrendeckenlampe, Aufbau / Plastik

Fluorescent ceiling light, surface mount / Eclairage fluorescent - plastique



Bestell-Nr. Order no.	L	B	Volt	Watt	Box	*€/Stück *€/piece
8143283200	200	120	12	9	1	33,00

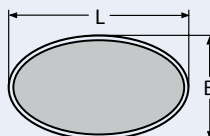

Leuchtstoffröhrendeckenlampe, Aufbau / Plastik

Fluorescent ceiling light, surface mount / Eclairage fluorescent - plastique

814329

Bestell-Nr. Order no.	L	B	Volt	Watt	Box	*€/Stück *€/piece
8143293180	180	180	12	2 X 7	1	49,00

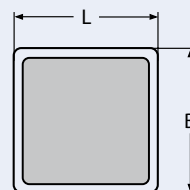

Leuchtstoffröhrenlampe, Aufbau / Plastik

Fluorescent light, surface mount / Eclairage fluorescent - plastique

814330

Bestell-Nr. Order no.	L	B	Volt	Watt	Box	*€/Stück *€/piece
8143303595	595	65	12	15	1	27,20

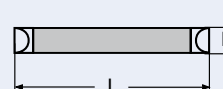

Leuchtstoffröhrenlampe, Aufbau / Plastik

Fluorescent light, surface mount / Eclairage fluorescent - plastique

814331

Bestell-Nr. Order no.	L	B	Volt	Watt	Box	*€/Stück *€/piece
8143313485	595	65	12	15	1	27,00

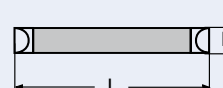

LED Magic Light, 100% wasserdicht / A2-AISI 304

LED magic light, 100% waterproof / Diode LED 100% étanche

8544

Bestell-Nr. Order no.	Ø	D	L	S	Volt	Watt	Box	*€/Stück *€/piece
8544212	8	6,5	22	2	8 - 15	0,33	1	13,00

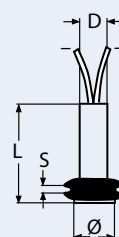

8687

3er Schalttafel, wassergeschützt

3 gang water protected switch panel / Tableau à 3 fusibles et interrupteurs étanches

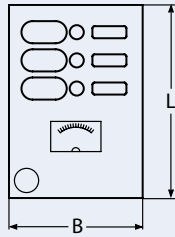

Bestell-Nr. Order no.	L	B	Volt	Box	*€/Stück *€/piece
86870190_135	190	135	12	1	97,00

Steckdose. LED-Kontrollleuchte. Voltmeter für Batterie 1 und 2.
Socket. LED control lamp. Voltmeter for batteries 1 and 2.

8685

4er Schalttafel, wassergeschützt

4 gang water protected switch panel / Tableau à 4 fusibles et interrupteurs étanches

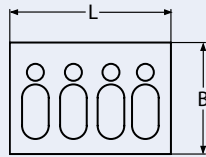

Bestell-Nr. Order no.	L	B	Volt	Box	*€/Stück *€/piece
86850130_95	130	95	12	1	78,50

Glassicherung. LED-Kontrollleuchte
Glass fuse. LED control lamp

814198

5er Schalttafel, wassergeschützt

5 gang water protected switch panel / Tableau à 5 fusibles et interrupteurs étanches

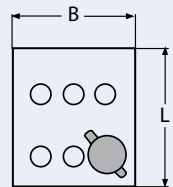

Bestell-Nr. Order no.	L	B	Volt	Box	*€/Stück *€/piece
8141983110_125	125	110	12	1	46,60

8756

4er Schalttafel, wassergeschützt

4 gang water protected switch panel / Tableau automatique à 4 fusibles et interrupteurs

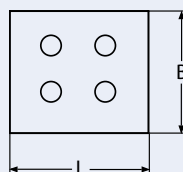

Bestell-Nr. Order no.	Farbe Colour	L	B	Volt	Box	*€/Stück *€/piece
87563100_85SCHWARZ	Schwarz/Black	100	85	12	1	31,80
87563100_85WEISS	Weiß/White	100	85	12	1	35,00

Flachsicherung
Fuse

6er Schalttafel, wassergeschützt

6 gang water protected switch panel / Tableau à 6 fusibles et interrupteurs étanches

8686

Bestell-Nr. Order no.	L	B	Volt	Box	*€/Stück *€/piece
86860190_135	190	135	12	1	89,00

Glassicherung, LED-Kontrolleuchte
Glass fuse, LED control lamp

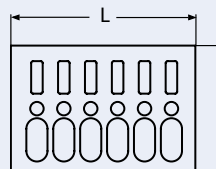

6er Schalttafel

6 gang switch panel / Tableau à 6 fusibles et interrupteurs étanches

8688

Bestell-Nr. Order no.	L	B	Volt	Box	*€/Stück *€/piece
86880170_115	170	115	12	1	36,00

Glassicherung
Glass fuse

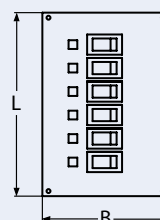

6er Schalttafel

6 gang switch panel / Tableau automatique à 6 fusibles et interrupteurs

8689

Bestell-Nr. Order no.	L	B	Volt	Box	*€/Stück *€/piece
86890170_115	165	115	12	1	36,00

Glassicherung
Glass fuse

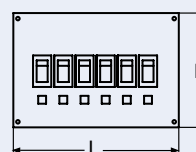

6er Schalttafel, wassergeschützt

6 gang water protected switch panel / Tableau à 6 fusibles et interrupteurs étanches

8757

Bestell-Nr. Order no.	Farbe Colour	B	L	Volt	Box	*€/Stück *€/piece
87573105_120SCHWARZ	Schwarz/Black	120	105	12	1	38,30
87573105_120WEISS	Weiß/White	120	105	12	1	38,60

Automatische Sicherung
Automatic fuse

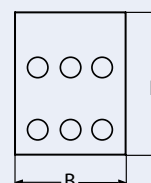

814052

3er Schalttafel, wassergeschützt mit automatischen Sicherungen
3 gang water protected switch panel with automatic fuses / **

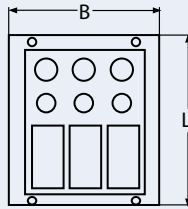

Bestell-Nr. Order no.	L	B	Volt	Box	*€/Stück *€/piece
8140523130_110	130	110	12	1	56,00

** Tableau à six fusibles automatiques et interrupteurs étanches

814053

6er Schalttafel, wassergeschützt mit automatischen Sicherungen
6 gang water protected switch panel with automatic fuses / **

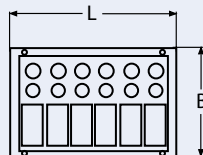

Bestell-Nr. Order no.	L	B	Volt	Box	*€/Stück *€/piece
8140533190_130	190	130	12	1	93,00

** Tableau à six fusibles automatiques et interrupteurs étanches

814402

4er Schalttafel wassergeschützt mit automatischer Sicherung und LED-Anzeige
4 gang water protected switch panel with automatic fuses and LED indicator / **

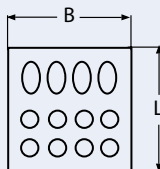

Bestell-Nr. Order no.	L	B	Box	*€/Stück *€/piece
8144023105_105	105	105	1	79,00

** Tableaux électriques étanches 4 interrupteurs + voyant lumineux

814403

6er Schalttafel wassergeschützt mit automatischer Sicherung und LED-Anzeige
6 gang water protected switch panel with automatic fuses and LED indicator / **

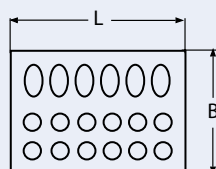

Bestell-Nr. Order no.	L	B	Box	*€/Stück *€/piece
8144033105_150	150	105	1	95,00

** Tableaux électriques étanches 6 interrupteurs+ voyant lumineux

Schalter für Ankerwinde

Windlass switch / Interrupteur pour guindeau

814090

Bestell-Nr. Order no.	L	B	Box	*€/Stück *€/piece
814090375	75	50	1	11,00

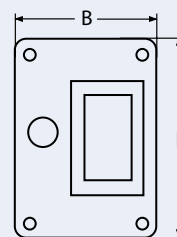

Batterie Hauptschalter mit Schlüssel

Battery main switch with key / Coupe batterie avec clés

8725

Bestell-Nr. Order no.	Ampere	max. Ampere	Volt	Box	*€/Stück *€/piece
87253100	100	500	12	1	21,25
87253ERSATZ	Ersatzschlüssel / Replacement key			1	1,50



Batterie Hauptschalter

Battery main switch / Commutateur central pour batterie

8899

Bestell-Nr. Order no.	Ampere	Ampere/10 sec.	Volt	Box	*€/Stück *€/piece
88993300	300	1000	12	1	34,40



Batterieumschalter

Battery switch / Coupe batterie

8724

Bestell-Nr. Order no.	Ampere	max. Ampere	Ø	H	Volt	Box	*€/Stück *€/piece
87243250	250	360	130	56	12	1	49,50

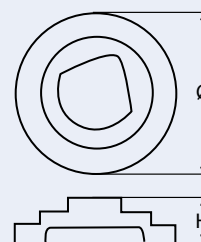

Beleuchtung und Elektrik

Cabin lighting and electrical equipment

Lampes de cabines - électricité

8723

Batterieumschalter

Battery switch / Coupe batterie

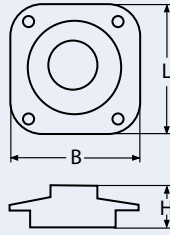

Bestell-Nr. Order no.	Ampere	max. Ampere	L	B	H	Volt	Box	*€/Stück *€/piece
87233350	350	800	125	125	85	12	1	75,40

8722

Batterieumschalter

Battery switch / Coupe batterie

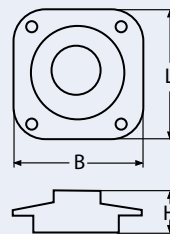

Bestell-Nr. Order no.	Ampere	max. Ampere	L	B	H	Volt	Box	*€/Stück *€/piece
87223280	280	380	100	100	65	12	5	62,00

8734

Kippschalter

Flip switch / Intérupteur à levier



Bestell-Nr. Order no.	Ampere	Volt	Box	*€/Stück *€/piece
87343	15	12	5	5,50

8733

Kippschalter

Flip switch / Intérupteur à levier



Bestell-Nr. Order no.	Ampere	Volt	Box	*€/Stück *€/piece
87333	5	12	5	2,60

Kippschalter on-off-on
Flip switch / Inverseur à levier

8732

Bestell-Nr. Order no.	Ampere	Volt	Box	*€/Stück *€/piece
87323	10	12	5	3,00



Drucktaster
Push button / Bouton d'impression

8730

Bestell-Nr. Order no.	Ampere	Volt	Box	*€/Stück *€/piece
87303	10	12	1	2,50



Marine Zündschloss mit Abdeckung, 3 Anschlüsse / Messing
Marine ignition starter switch with cap, 3 poles, brass / **

814407

Bestell-Nr. Order no.	max. Ampere	Box	*€/Stück *€/piece
814407515	15	1	29,00

** Contacteurs à clé 3 positions en laiton



Marine Zündschloss mit Abdeckung, 3 Anschlüsse / Plastik
Marine ignition starter switch with cap, 3 poles / Contacteurs à clé 3 positions en plastique

814408

Bestell-Nr. Order no.	max. Ampere	Box	*€/Stück *€/piece
814408315	15	1	19,90



814409

Marine Zündschloss mit Abdeckung, 5 Anschlüsse / Plastik

Marine ignition starter switch with cap, 5 poles / Contacteurs à clé 5 positions en plastique



Bestell-Nr. Order no.	max. Ampere	Box	*€/Stück *€/piece
814409315	15	1	20,10

8681

Schalter für Bilgepumpe, wassergeschützt

Water protected bilge pump switch / Tableau pour pompe de cale étauiché

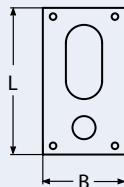

Bestell-Nr. Order no.	L	B	Ampere	Volt	Box	*€/Stück *€/piece
8681090_50	90	50	15	12	1	21,00

Alutafel mit Glassicherung, automatisch und manuell.
Alu panel with glass fuse, automatic and manual.

8683

Schalter für Bilgewasseralarm

Bilge water alarm switch / Tableau pour pompe de cale avec alarme

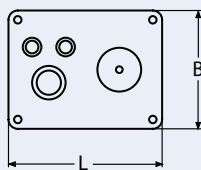

Bestell-Nr. Order no.	L	B	Volt	Box	*€/Stück *€/piece
8683082_64	82	64	12 + 24	1	22,50

Mit akustischem Alarm. Glassicherung, automatisch.
With acoustic signal. Glass fuse, automatic.

8684

Schalter für Bilgepumpe, wassergeschützt

Water protected bilge pump switch / Tableau pour pompe de cale étauiché

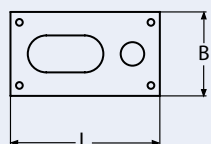

Bestell-Nr. Order no.	L	B	Ampere	Volt	Box	*€/Stück *€/piece
8684090_50	90	50	15	12	1	18,70

Glassicherung, automatisch und manuell.
Glass fuse, automatic and manual.

Schalter für Bilgepumpe mit Alarm

Bilge pump switch with alarm / Tableau pour pompe de cale avec alarme

8682

Bestell-Nr. Order no.	L	B	Volt	Box	*€/Stück *€/piece
86820115_64	115	64	12 + 24	1	34,00

Mit akustischem Alarm. Glassicherung, autom. und manuell.
With acoustic signal. Glass fuse, automatic and manual.

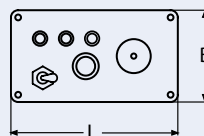

Killschalter

Kill switch / Coupe circuit

8729

Bestell-Nr. Order no.	Ampere	Volt	Box	*€/Stück *€/piece
87293	15	12	5	10,00



Killschalter

Kill switch / Coupe circuit

8728

Bestell-Nr. Order no.	Ampere	Volt	Box	*€/Stück *€/piece
87283	15	12	5	21,50



Schwimmschalter

Float switch / Contacteur pour pompe

8716

Bestell-Nr. Order no.	L	B	Ampere	Volt	Box	*€/Stück *€/piece
8716312-32	112	80	15	12 - 32	1	23,30

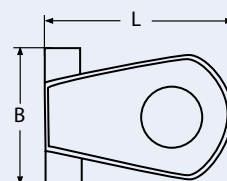

8731

Kontrolllichtschalter

Push pull with pilot lamp / contrôler



Bestell-Nr. Order no.	Farbe Colour	Ampere	Volt	Box	*€/Stück *€/piece
87313ROT	Rot/Red	15	12	5	8,10
87313GRÜN	Grün/Green	15	12	5	5,30

8509

Horn / A2-AISI 304

Horn / Cornet

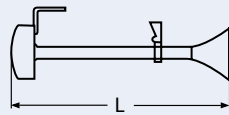

Bestell-Nr. Order no.	L	dB	Ampere	Volt	Box	*€/Stück *€/piece
85092410	410	115	3	12	1	78,50

8510

Fanfare / A2-AISI 304

Fanfare / Double cornet

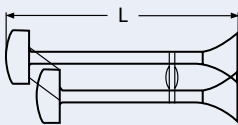
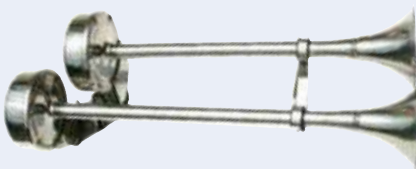

Bestell-Nr. Order no.	L	dB	Ampere	Volt	Box	*€/Stück *€/piece
85102465	465	115	6	12	1	145,00

8672

Horn / A2-AISI 304

Horn / Cornet

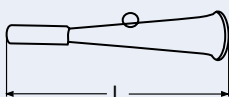

Bestell-Nr. Order no.	L	Box	*€/Stück *€/piece
86722200	200	1	33,60

Minihorn / A2-AISI 304
Mini horn / Corne de brume

8583

Bestell-Nr. Order no.	L	B	S	H	dB	Volt	Box	*€/Stück *€/piece
8583295	95	85	2	55	105	12	1	35,00

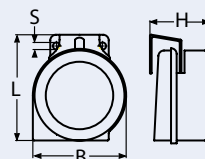

Bilgepumpe / Plastik
Bilge pump / Pompe de cale d'assèchement

8712

Bestell-Nr. Order no.	Typ	Volt	Liter/Std. Liter/hour	Ø	Box	*€/Stück *€/piece
871230500-12	500	12	1900	19	1	37,00
871230700-12	700	12	2600	19	1	40,00
871230700-24	700	24	2600	19	1	38,00
871231500-12	1500	12	5640	32	1	70,80
871231500-24	1500	24	5640	32	1	79,00
871231800-12	1800	12	6800	32	1	58,00
871232000-12	2000	12	7500	32	1	88,00
871232000-24	2000	24	7500	32	1	112,00



Manuelle Fußpumpe
Manual foot pump / Pompe à pied double effet

8714

Bestell-Nr. Order no.	Schlauch Hose	Liter/min.	Box	*€/Stück *€/piece
87143	13	9	1	70,20



Elektrische Luftpumpe
Electric air pump / Pompe à air, 12 Volt

8705

Bestell-Nr. Order no.	Adapter	Volt	Watt	Box	*€/Stück *€/piece
8705312	3	12	120	1	30,30



Beleuchtung und Elektrik

Cabin lighting and electrical equipment

Lampes de cabines - électricité

8726

Kabeldecksdurchführung, Messing, verchromt

Cable outlet, brass, chrome plated / Passe câble

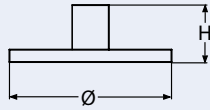

Bestell-Nr. Order no.	Kabel-Ø Cable-Ø	Ø	H	Box	*€/Stück *€/piece
8726706	6	32	15	5	5,70
8726708	8	32	15	5	5,70
8726710	10	38	20	5	8,60
8726712	12	38	20	5	8,60

814059

Kabeldecksdurchführung / A4 AISI 316

Cable outlet / Sortie de câble

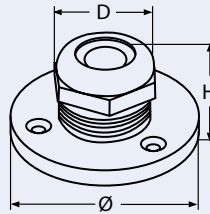

Bestell-Nr. Order no.	Kabel-Ø Cable-Ø	D	Ø	H	Box	*€/Stück *€/piece
814059404_11	4-11	22	49	21	1	26,00
814059412_20	12-20	32	62	28	1	33,50

8721

Wasserfilter

Water filter / Filtre à eau



Bestell-Nr. Order no.	Schlauch Hose	Filter Filter	Box	*€/Stück *€/piece
87213-13GROB	13 - 3/4 Gewinde/Thread	Grob/Coarse	1	12,00
87213-19GROB	19 - 1/2 Gewinde/Thread	Grob/Coarse	1	12,00
87213-13FEIN	13 - 3/4 Gewinde/Thread	Fein/Fine	1	12,00

8690

Klemmleisten

Copper bus bar / Barre de cuivre omnibus



Bestell-Nr. Order no.	Anschlüsse Connections	L	B	Ampere	Box	*€/Stück *€/piece
8690110_31	10	150	31	150	1	22,00
8690120_31	20	228	31	150	1	30,00

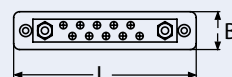

Steckverbindung, Messing, verchromt, wasserdicht

Deck connector, brass, chrome plated, water resistant / Prise de pont étanché

8727

Bestell-Nr. Order no.	Pole	Ampere	Volt	Ø	H	Box	*€/Stück *€/piece
872772-3	2	3	12	38	55	1	22,00
872773-3	3	3	12	38	55	1	23,20
872774-3	4	3	12	38	55	1	23,30
872772-5	2	5	12	45	65	1	29,80
872773-5	3	5	12	45	65	1	26,00
872774-5	4	5	12	45	65	1	33,50

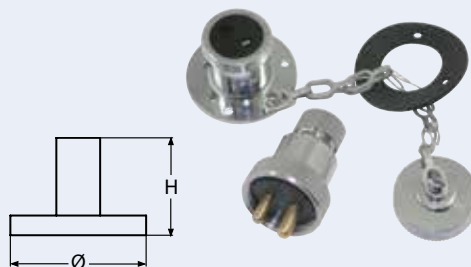

12 Volt 3-Wege Abzweig / Plastik

12 Volt 3-way adapter / Prise allume cigare triple 12 Volt en plastique

814393

Bestell-Nr. Order no.	Volt	Box	*€/Stück *€/piece
814393312	12	1	18,00



12 Volt Steckdose mit LED-Indikator / Plastik

12 Volt socket with LED indicator / **

814394

Bestell-Nr. Order no.	Volt	Box	*€/Stück *€/piece
814394312	12	1	13,50

** Prise encastrée pour fiches allume cigare avec fiche simple 12 Volt avec voyant lumineux en plastique



12 Volt Steckdose / A2-AISI 304

12 Volt socket / Prise encastrée pour fiches allume cigare 12 Volt

814395

Bestell-Nr. Order no.	Volt	Box	*€/Stück *€/piece
814395212	12	1	14,80



Beleuchtung und Elektrik

Cabin lighting and electrical equipment

Lampes de cabines - électricité

814192

12 Volt Steckdose / Plastik

12 Volt socket / Prise encastrée pour fiches allume cigare 12 Volt



Bestell-Nr. Order no.	H	Box	*€/Stück *€/piece
814192380	80	1	12,80

814042

Marine Batterie Schnellverbinder

Marine battery quick connectors / Raccords rapides pour batteries marines



Bestell-Nr. Order no.	Max. Ampere	Box	*€/Stück *€/piece
8140424800	800	2	10,00

Geeignet für alle SAE-batteries, DIN-, Marine-, Auto- und Bootsbatterien.

Fits for all SAE-batteries and DIN, marine batteries, car batteries, and deep-cycle batteries.

814308

Bronze Batterie Verbindung

Bronze battery connection / Colliers de batteries en bronze



Bestell-Nr. Order no.	Gewindelänge Length of thread	Box	*€/Stück *€/piece
8143082	16	2	6,80

8735

Flachstecksicherung

Flat connector fuse/ Fusibles enfichables



Bestell-Nr. Order no.	Ampere	Box	*€/Stück *€/piece
8735303	3	100	0,14
8735305	5	100	0,14
8735310	10	100	0,14
8735315	15	100	0,14
8735320	20	100	0,15
8735325	25	100	0,15
8735330	30	100	0,15

Visaton Breitbandlautsprecher zur Außenmontage, 60 Watt

Visaton wide range speaker for outdoor mounting, 60 Watt / Visaton - haut parleur montage extérieur

8874

Bestell-Nr. Order no.	Ø	Watt	Übertragung	Farbe Colour	Box	*€/Stück *€/piece
88743604W	130	60	4 Ohm	Weiß/White	1	38,10
88743604S	130	60	4 Ohm	Schwarz/Black	1	38,10

Seewasserbeständiger Breitbandlautsprecher, UV-beständig und bruchsicher. Optimal für den Außeneinbau auf Booten.
Seawaterproof wide range speaker, UV-resistant and breakproof, optimal for outer mounting on boats.

VISATON
GERMANY



Visaton Breitbandlautsprecher zur Außenmontage, 80 Watt

Visaton wide range speaker for outdoor mounting, 80 Watt / Visaton - haut parleur montage extérieur

8875

Bestell-Nr. Order no.	Ø	Watt	Übertragung	Farbe Colour	Box	*€/Stück *€/piece
88753804W	160	80	4 Ohm	Weiß/White	1	46,00
88753804S	160	80	4 Ohm	Schwarz/Black	1	46,00

Seewasserbeständiger Breitbandlautsprecher, UV-beständig und bruchsicher. Optimal für den Außeneinbau auf Booten.
Seawaterproof wide range speaker, UV-resistant and breakproof, optimal for outer mounting on boats.

VISATON
GERMANY



Umwandler 12 Volt zu 220 Volt, inkl. USB-Anschluss

Inverter 12 Volt to 220 Volt, incl. USB port / Inverseur 12 V en 220 V ind. Port USB

814334

Bestell-Nr. Order no.	Watt max.	Volt	Ø	H	Box	*€/Stück *€/piece
814334150	150	12 - 220	73	170	1	46,60

Umwandler 12 Volt Bordnetz auf 220 Volt (2 poliger Stecker) für Geräte bis max. 150 Watt Leistung. Inkl. Überhitzungs- und Überladungsschutz, inkl. Lüfterkühlung. USB-Anschluss mit 5 Volt 500mA Ausgangsleistung (zum Betreiben von USB-Geräten, MP3 Player...)

Inverter 12 Volt harness to 220 Volt (2 pole plug) for devices to a max. of 150 Watt. Includes overheating and overload protection and ventilator cooling. USB port with 5 Volt 500mA output (for USB devices, MP3 player...)



Anti Mücken Liquid, 12 Volt

Anti mosquito liquid, 12 Volt / Liquide Anti moustique

814220

Bestell-Nr. Order no.		Box	*€/Stück *€/piece
8142203		5	14,00
814220ERSATZ	Ersatzflasche / Replacement bottle	5	7,50





Rost- und säurebeständige Verbindungselemente und Schiffszubehör auf Blisterkarten

Corrosion and acid resistant fasteners and nautical accessories on blister cards

Lochung für sichere Befestigung

Perforation for secure fastening

Euro-Standard Lochung
Euro standard pressing

Ausführliche Artikelbeschreibung mit Artikelnummer

Detailed description with article number



EAN-Code
EAN-Code

Produkte offen auf stabiler Blisterkarte sicher befestigt
Products are safety attached to a solid blister card



Blisterverkaufswand



Das SB-Programm für Ihre Verkaufsausstellung
Zur Erweiterung Ihres Sortiments bieten wir Ihnen eine Vielfalt der bewährten Marinetechnik-Produkte auf Blisterkarten an. Das SB-Programm reicht von rostfreiem Bootszubehör über Schrauben bis hin zu Tauwerk, Ketten und Drahtseil.
Sie stellen sich Ihre Verkaufswand zusammen und wählen die gewünschten Produkte aus unserem Hauptkatalog aus oder erfragen sie bei unseren Verkäufern. Wir liefern Ihnen Ihr SB-Programm komplett fertig konfektioniert mit stabiler offener Blisterkarte inkl. Artikelbeschreibung, Artikelnummer und dem EAN-Code.

The self service program for your sales exhibition
To expand your offers we can provide a variety of approved Marinetechnik products on blister cards. The self service program reaches from nautical accessories ranges screws to chains, ropes and wire ropes. You arrange your exhibition and we provide products from our catalogue or you may request them directly from our sellers. We deliver the self service program completely assembled with a solid open blister card incl. article description, article number and EAN-code.



Kapitel 12

Chapter 12

Schrauben in SB-Verpackungen

Screws in self-service packages



A4-Verkaufsständer

- Exklusiver, drehbarer Verkaufsständer mit einer Grundfläche von nur 1 qm und einer Höhe von 2,20 m
- Exclusive rotating display with a base area of only 1sqm and a height of 2.20 m
- 261 verschiedene und gängige Schraubenabmessungen auf engstem Raum
- 261 different and common screw dimensions displayed
- Keine unterschiedlichen Preisgruppen im EK- und VK-Preis
- No different cost price and sales categories
- EAN-Code auf allen Packungen
- EAN-code on all packages
- Jede Verpackung mit Sichtfenster und Produktabbildung
- Each package with window and product illustration
- Einfache Nachbestellung im 10er-Karton
- Simple repeat order in cartons of 10



Das Sortiment besteht aus: The assortment contains:

- | | | |
|------------|-----------|---|
| • DIN 963 | • DIN 571 | • DIN 127 |
| • DIN 964 | • DIN 603 | • DIN 9021 |
| • DIN 84 | • DIN 95 | • DIN 1587 |
| • DIN 7981 | • DIN 97 | • DIN 94 |
| • DIN 7982 | • DIN 934 | • DIN 315 |
| • DIN 7983 | • DIN 985 | • DIN 97 (Kupfer-Bronze /
Copper-bronze) |
| • DIN 933 | • DIN 125 | |

Art.-Nr.

- | | |
|------|---|
| 1001 | Stabdeckschrauben / Marine woodfloor screws |
| 1004 | Hülsenmuttern / Case nuts |
| 1005 | Spanplattenschrauben / Chipboard screws |
| 1008 | Scharnierbandschrauben / Hinge tape chipboard screws |
| 1011 | Rosetten / Turned full bodies |
| 1014 | Blindnieten / Blind rivets |
| 3001 | Kupferbootsnägel inkl. Nietscheibe /
Copper boat nails incl. rivetwasher |
| 7337 | Monell-Blindnieten / Monell blind rivets |

Ständer komplett bestückt
Display completely stocked

2390,- €
netto + MwSt. · net value plus VAT

DIN 84

Blister Pack DIN 84 + DIN 934 / A4-AISI 316

Zylinderschraube mit Schlitz und Mutter

Blister pack DIN 84 + DIN 934, slotted cheese head screw with nut



Bestell-Nr. Order no.	Abmessung Dimensions	Stück Pieces	Box Box	1 Box VK A4*
9008443_10	M3 x 10	10	10	3,05
9008443_16	M3 x 16	10	10	3,05
9008443_20	M3 x 20	8	10	3,05
9008444_16	M4 x 16	8	10	3,05
9008444_20	M4 x 20	8	10	3,05
9008444_30	M4 x 30	6	10	3,05
9008444_40	M4 x 40	6	10	3,05
9008445_20	M5 x 20	6	10	3,05
9008445_30	M5 x 30	6	10	3,05
9008445_40	M5 x 40	4	10	3,05
9008445_50	M5 x 50	4	10	3,05
9008446_20	M6 x 20	4	10	3,05
9008446_30	M6 x 30	4	10	3,05
9008446_40	M6 x 40	4	10	3,05
9008446_60	M6 x 60	4	10	3,05
9008448_60	M8 x 60	2	10	3,05
9008448_80	M8 x 80	2	10	3,05
9008448_100	M8 x 100	2	10	3,05

DIN 603

Blister Pack DIN 603 + DIN 934 / A4-AISI 316

Flachrundschaube mit Vierkantanstaz und Mutter

Blister pack DIN 603 + DIN 934, mushroom head square neck bolt with nut

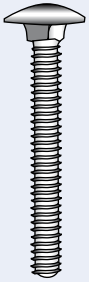

Bestell-Nr. Order no.	Abmessung Dimensions	Stück Pieces	Box Box	1 Box VK A4*
9060346_25	6 x 25	4	10	3,05
9060346_30	6 x 30	4	10	3,05
9060346_40	6 x 40	4	10	3,05
9060346_50	6 x 50	4	10	3,05
9060346_60	6 x 60	2	10	3,05
9060348_40	8 x 40	2	10	3,05
9060348_60	8 x 60	2	10	3,05
9060348_70	8 x 70	2	10	3,05
9060348_80	8 x 80	2	10	3,05



A4 Schrauben in SB-Verpackungen

Screws in self-service packages
Blister A2 - A4

12



Blister Pack DIN 963 + DIN 934 / A4-AISI 316

Senkschraube mit Schlitz und Mutter

Blister pack DIN 963 + DIN 934, slotted countersunk head screw with nut

DIN 963

Bestell-Nr. Order no.	Abmessung Dimensions	Stück Pieces	Box Box	1 Box VK A4*
9096343__10	3 x 10	10	10	3,05
9096343__16	3 x 16	10	10	3,05
9096343__20	3 x 20	8	10	3,05
9096344__16	4 x 16	8	10	3,05
9096344__20	4 x 20	8	10	3,05
9096344__30	4 x 30	6	10	3,05
9096344__40	4 x 40	6	10	3,05
9096345__16	5 x 16	6	10	3,05
9096345__20	5 x 20	6	10	3,05
9096345__30	5 x 30	6	10	3,05
9096345__40	5 x 40	6	10	3,05
9096345__50	5 x 50	4	10	3,05
9096346__20	6 x 20	4	10	3,05
9096346__30	6 x 30	4	10	3,05
9096346__40	6 x 40	4	10	3,05
9096346__50	6 x 50	4	10	3,05
9096346__60	6 x 60	4	10	3,05
9096348__60	8 x 60	2	10	3,05
9096348__80	8 x 80	2	10	3,05
9096348__100	8 x 100	2	10	3,05

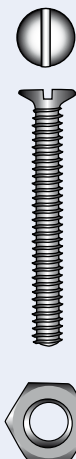

Blister Pack DIN 933 + DIN 934 / A4-AISI 316

Sechskant-Gewindeschraube mit Mutter

Blister pack DIN 933 + DIN 934, hexagon head screws

DIN 933

Bestell-Nr. Order no.	Abmessung Dimensions	Stück Pieces	Box Box	1 Box VK A4*
9093345__16	5 x 16	8	10	3,05
9093345__20	5 x 20	8	10	3,05
9093345__25	5 x 25	6	10	3,05
9093345__30	5 x 30	6	10	3,05
9093345__40	5 x 40	6	10	3,05
9093345__50	5 x 50	4	10	3,05
9093346__20	6 x 20	6	10	3,05
9093346__25	6 x 25	6	10	3,05
9093346__30	6 x 30	4	10	3,05
9093346__40	6 x 40	4	10	3,05
9093346__60	6 x 60	4	10	3,05
9093348__30	8 x 30	4	10	3,05
9093348__40	8 x 40	4	10	3,05
9093348__50	8 x 50	2	10	3,05
9093348__60	8 x 60	2	10	3,05
9093348__80	8 x 80	2	10	3,05
9093348__100	8 x 100	2	10	3,05

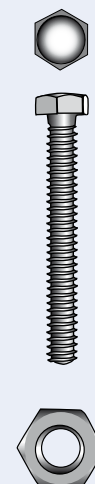

DIN 964

Blister Pack DIN 964 + DIN 934 / A4-AISI 316

Linsensenkschraube mit Schlitz und Mutter / Blister pack
DIN 964 + DIN 934, slotted raised countersunk head screw with nut

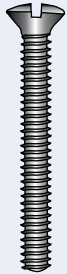

Bestell-Nr. Order no.	Abmessung Dimensions	Stück Pieces	Box Box	1 Box VK A4*
9096443_10	3 x 10	10	10	3,05
9096443_16	3 x 16	10	10	3,05
9096443_20	3 x 20	8	10	3,05
9096444_16	4 x 16	8	10	3,05
9096444_20	4 x 20	8	10	3,05
9096444_30	4 x 30	6	10	3,05
9096444_40	4 x 40	6	10	3,05
9096445_16	5 x 16	6	10	3,05
9096445_20	5 x 20	4	10	3,05
9096445_30	5 x 30	4	10	3,05
9096445_40	5 x 40	4	10	3,05
9096445_50	5 x 50	4	10	3,05
9096446_20	6 x 20	4	10	3,05
9096446_30	6 x 30	4	10	3,05
9096446_40	6 x 40	4	10	3,05
9096446_50	6 x 50	4	10	3,05
9096446_60	6 x 60	4	10	3,05
9096448_60	8 x 60	2	10	3,05
9096448_80	8 x 80	2	10	3,05
9096448_100	8 x 100	2	10	3,05

DIN 571

Blister Pack DIN 571 / A4-AISI 316

Sechskant-Holzschraube
Blister pack DIN 571, hexagon head wood screw

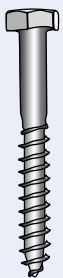

Bestell-Nr. Order no.	Abmessung Dimensions	Stück Pieces	Box Box	1 Box VK A4*
9057146_50	6 x 50	4	10	3,05
9057146_60	6 x 60	4	10	3,05
9057146_70	6 x 70	2	10	3,05
9057146_80	6 x 80	2	10	3,05
9057148_60	8 x 60	2	10	3,05
9057148_70	8 x 70	2	10	3,05
9057148_80	8 x 80	2	10	3,05

Art.Nr.
7337

Blister Pack Art.-Nr. 7337

Monell-Blindniete
Blister pack art. no. 7337, monell blind rivet



Bestell-Nr. Order no.	Abmessung Dimensions	Stück Pieces	Box Box	1 Box VK A4*
97337932_102	3,2 x 10,2	5	10	3,05
9733794_114	4 x 11,4	4	10	3,05
97337948_19	4,8 x 19	2	10	3,05



A4 Schrauben in SB-Verpackungen

Screws in self-service packages
Blister A2 - A4

12



Blister Pack DIN 7981 / A4-AISI 316 Blechschaube, Linsenkopf

Blister pack DIN 7981, cross recessed tapping screw, pan head

DIN 7981

Bestell-Nr. Order no.	Abmessung Dimensions	Stück Pieces	Box Box	1 Box VK A4*
97981429_95	2,9 x 9,5	20	10	3,05
97981429_13	2,9 x 13	20	10	3,05
97981429_16	2,9 x 16	20	10	3,05
97981435_13	3,5 x 13	15	10	3,05
97981435_16	3,5 x 16	12	10	3,05
97981435_19	3,5 x 19	12	10	3,05
97981435_25	3,5 x 25	12	10	3,05
97981442_13	4,2 x 13	12	10	3,05
97981442_16	4,2 x 16	12	10	3,05
97981442_19	4,2 x 19	12	10	3,05
97981442_25	4,2 x 25	10	10	3,05
97981442_32	4,2 x 32	10	10	3,05
97981448_13	4,8 x 13	10	10	3,05
97981448_19	4,8 x 19	10	10	3,05
97981448_25	4,8 x 25	10	10	3,05
97981448_32	4,8 x 32	6	10	3,05
97981455_16	5,5 x 16	6	10	3,05
97981455_25	5,5 x 25	6	10	3,05
97981455_32	5,5 x 32	6	10	3,05
97981455_38	5,5 x 38	6	10	3,05

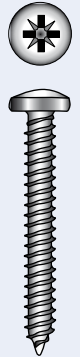

Blister Pack DIN 97 / A4-AISI 316 Senk-Holzschraube mit Schlitz

Blister pack DIN 97, slotted countersunk head wood screw

DIN 97

Bestell-Nr. Order no.	Abmessung Dimensions	Stück Pieces	Box Box	1 Box VK A4*
9009743_12	3,0 x 12	10	10	3,05
9009743_16	3,0 x 16	10	10	3,05
9009743_20	3,0 x 20	10	10	3,05
9009743_25	3,0 x 25	8	10	3,05
9009743_30	3,0 x 30	8	10	3,05
9009744_20	4,0 x 20	8	10	3,05
9009744_30	4,0 x 30	6	10	3,05
9009744_40	4,0 x 40	6	10	3,05
9009744_50	4,0 x 50	6	10	3,05
9009745_30	5,0 x 30	4	10	3,05
9009745_40	5,0 x 40	4	10	3,05
9009745_50	5,0 x 50	4	10	3,05
9009745_60	5,0 x 60	4	10	3,05
9009746_60	6,0 x 60	2	10	3,05
9009746_70	6,0 x 70	2	10	3,05

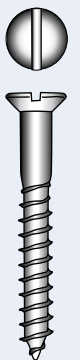

12

DIN 7982

Blister Pack DIN 7982 / A4-AISI 316
 Blechschraube, Senkkopf / Blister pack DIN 7982,
 cross recessed tapping screw, countersunk head

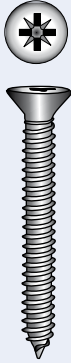

Bestell-Nr. Order no.	Abmessung Dimensions	Stück Pieces	Box Box	1 Box VK A4*
97982429_95	2,9 x 9,5	20	10	3,05
97982429_13	2,9 x 13	20	10	3,05
97982429_16	2,9 x 16	20	10	3,05
97982435_13	3,5 x 13	15	10	3,05
97982435_16	3,5 x 16	12	10	3,05
97982435_19	3,5 x 19	12	10	3,05
97982435_25	3,5 x 25	12	10	3,05
97982442_13	4,2 x 13	12	10	3,05
97982442_16	4,2 x 16	12	10	3,05
97982442_19	4,2 x 19	12	10	3,05
97982442_25	4,2 x 25	10	10	3,05
97982442_32	4,2 x 32	10	10	3,05
97982448_13	4,8 x 13	10	10	3,05
97982448_19	4,8 x 19	10	10	3,05
97982448_25	4,8 x 25	10	10	3,05
97982448_32	4,8 x 32	6	10	3,05
97982455_16	5,5 x 16	6	10	3,05
97982455_25	5,5 x 25	6	10	3,05
97982455_32	5,5 x 32	6	10	3,05
97982455_38	5,5 x 38	6	10	3,05



A4 Schrauben in SB-Verpackungen

Screws in self-service packages
Blister A2 - A4

12



Blister Pack DIN 7983 / A4-AISI 316
Blechschaube, Linsensenkopf / Blister pack DIN 7983,
cross recessed tapping screw, raised countersunk head

DIN 7983

Bestell-Nr. Order no.	Abmessung Dimensions	Stück Pieces	Box Box	1 Box VK A4*
97983429_95	2,9 x 9,5	20	10	3,05
97983429_13	2,9 x 13	20	10	3,05
97983429_16	2,9 x 16	20	10	3,05
97983435_13	3,5 x 13	15	10	3,05
97983435_16	3,5 x 16	12	10	3,05
97983435_19	3,5 x 19	12	10	3,05
97983435_25	3,5 x 25	12	10	3,05
97983442_13	4,2 x 13	12	10	3,05
97983442_16	4,2 x 16	12	10	3,05
97983442_19	4,2 x 19	12	10	3,05
97983442_25	4,2 x 25	10	10	3,05
97983442_32	4,2 x 32	10	10	3,05
97983448_13	4,8 x 13	10	10	3,05
97983448_19	4,8 x 19	10	10	3,05
97983448_25	4,8 x 25	10	10	3,05
97983448_32	4,8 x 32	6	10	3,05
97983455_16	5,5 x 16	6	10	3,05
97983455_25	5,5 x 25	6	10	3,05
97983455_32	5,5 x 32	6	10	3,05
97983455_38	5,5 x 38	6	10	3,05

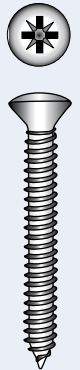

Blister Pack DIN 95 / A4-AISI 316
Linsensenk-Holzschraube mit Schlitz / Blister pack DIN 95,
slotted raised countersunk head wood screw

DIN 95

Bestell-Nr. Order no.	Abmessung Dimensions	Stück Pieces	Box Box	1 Box VK A4*
90095425_12	2,5 x 12	10	10	3,05
90095425_16	2,5 x 16	10	10	3,05
90095430_12	3,0 x 12	10	10	3,05
90095430_16	3,0 x 16	10	10	3,05
90095430_20	3,0 x 20	10	10	3,05
90095430_25	3,0 x 25	8	10	3,05
90095430_30	3,0 x 30	8	10	3,05
90095440_20	4,0 x 20	8	10	3,05
90095440_30	4,0 x 30	6	10	3,05
90095440_40	4,0 x 40	6	10	3,05
90095440_50	4,0 x 50	4	10	3,05
90095450_30	5,0 x 30	4	10	3,05
90095450_40	5,0 x 40	4	10	3,05
90095450_50	5,0 x 50	4	10	3,05
90095450_60	5,0 x 60	4	10	3,05
90095460_60	6,0 x 60	2	10	3,05
90095460_70	6,0 x 70	2	10	3,05

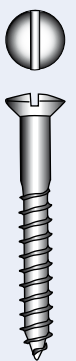

Art.-Nr.
1005

Blister Pack Art.-Nr. 1005 / A4-AISI 316
Spanplattenschraube Senkkopf mit Pozidrive-Kreuzschlitz
(gleitbeschichtet) / Blister pack art. no. 1005, **

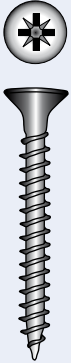

Bestell-Nr. Order no.	Abmessung Dimensions	Stück Pieces	Box Box	1 Box VK A4*
91005430_20	3,0 x 20	10	10	3,05
91005430_30	3,0 x 30	8	10	3,05
91005440_30	4,0 x 30	8	10	3,05
91005440_40	4,0 x 40	6	10	3,05
91005450_40	5,0 x 40	4	10	3,05
91005450_50	5,0 x 50	4	10	3,05
91005460_60	6,0 x 60	2	10	3,05

** countersunk head cross recessed chipboard screw (pozidrive)

Art.-Nr.
1001

Blister Pack Art.-Nr. 1001 / A4-AISI 316
Stabdeckschraube mit TORX-Antrieb, Flachsenkopf
Blister pack art. no. 1001, **



Bestell-Nr. Order no.	Abmessung Dimensions	Stück Pieces	Box Box	1 Box VK A4*
910014T48_19	4,8 x 19	15	10	3,05

** marine-woodfloor-screw with TORX-drive

DIN 125

Blister Pack DIN 125 / A4-AISI 316
Unterlegscheibe
Blister pack DIN 125, washer

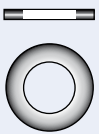

Bestell-Nr. Order no.	Abmessung Dimensions	Stück Pieces	Box Box	1 Box VK A4*
90125432	3,2	20	10	3,05
90125443	4,3	20	10	3,05
90125453	5,3	20	10	3,05
90125464	6,4	20	10	3,05
90125484	8,4	20	10	3,05

DIN 127

Blister Pack DIN 127 / A4-AISI 316
Federring
Blister pack DIN 127, spring lock washer

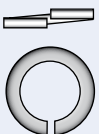

Bestell-Nr. Order no.	Abmessung Dimensions	Stück Pieces	Box Box	1 Box VK A4*
9012743	3	20	10	3,05
9012744	4	20	10	3,05
9012745	5	20	10	3,05
9012746	6	20	10	3,05
9012748	8	20	10	3,05



A4 Schrauben in SB-Verpackungen

Screws in self-service packages
Blister A2 - A4

12

Blister Pack DIN 315 / A4-AISI 316 Flügelmutter

Blister pack DIN 315, wing nut

DIN 315

Bestell-Nr. Order no.	Abmessung Dimensions	Stück Pieces	Box Box	1 Box VK A4*
9031543	M3	4	10	3,05
9031544	M4	4	10	3,05
9031545	M5	4	10	3,05
9031546	M6	2	10	3,05
9031548	M8	2	10	3,05

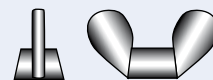

Blister Pack Art.-Nr. 1008 / A4-AISI 316 Scharnierbandschraube, 5 mm Kopf / Blister pack

art. no. 1008, hinge tape chipboard screw, head 5 mm

Art.-Nr. 1008

Bestell-Nr. Order no.	Abmessung Dimensions	Stück Pieces	Box Box	1 Box VK A4*
9100843_12	3,0 x 12	10	10	3,05
9100843_16	3,0 x 16	10	10	3,05
9100843_20	3,0 x 20	10	10	3,05

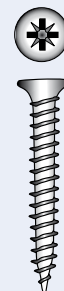

Blister Pack DIN 985 / A4-AISI 316 Poly-Stopmutter

Blister pack DIN 985, evailing torque type hexagon nut

DIN 985

Bestell-Nr. Order no.	Abmessung Dimensions	Stück Pieces	Box Box	1 Box VK A4*
9098543	M3	6	10	3,05
9098544	M4	6	10	3,05
9098545	M5	6	10	3,05
9098546	M6	4	10	3,05
9098548	M8	4	10	3,05



Blister Pack DIN 9021 / A4-AISI 316 Unterlegscheibe, groß

Blister pack DIN 9021, washer, large

DIN 9021

Bestell-Nr. Order no.	Abmessung Dimensions	Stück Pieces	Box Box	1 Box VK A4*
99021432	3,2	20	10	3,05
99021443	4,3	20	10	3,05
99021453	5,3	20	10	3,05
99021464	6,4	20	10	3,05
99021484	8,4	10	10	3,05



12

DIN 1587

Blister Pack DIN 1587 / A4-AISI 316
 Hutmutter
 Blister pack DIN 1587, dome cap nut



Bestell-Nr. Order no.	Abmessung Dimensions	Stück Pieces	Box Box	1 Box VK A4*
9158743	M3	4	10	3,05
9158744	M4	4	10	3,05
9158745	M5	4	10	3,05
9158746	M6	3	10	3,05
9158748	M8	3	10	3,05

DIN 97

Blister Pack DIN 97 / Bronze
 Bronze-Holzschraube, Senkkopf / Blister pack DIN 97,
 lotted head wood screw, bronze, countersunk head

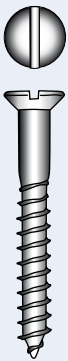

Bestell-Nr. Order no.	Abmessung Dimensions	Stück Pieces	Box Box	1 Box VK A4*
9009713__20	3 x 20	8	10	3,05
9009714__40	4 x 40	6	10	3,05
9009715__50	5 x 50	4	10	3,05
9009716__60	6 x 60	2	10	3,05

Art.-Nr. 1011

Blister Pack Art.-Nr. 1011 / A4-AISI 316
 Rosette, aus Vollmaterial, gedreht
 Blister pack art. no. 1011, rosette turned full body

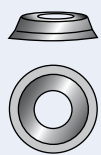

Bestell-Nr. Order no.	Abmessung Dimensions	Stück Pieces	Box Box	1 Box VK A4*
9101143	M3	5	10	3,05
9101144	M4	4	10	3,05
9101145	M5	4	10	3,05
9101146	M6	3	10	3,05
9101148	M8	2	10	3,05

DIN 94

Blister Pack DIN 94 / A4-AISI 316
 Splint
 Blister pack DIN 94, splint pin

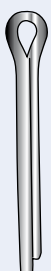

Bestell-Nr. Order no.	Abmessung Dimensions	Stück Pieces	Box Box	1 Box VK A4*
90094420_20	2,0 x 20	12	10	3,05
90094425_20	2,5 x 20	10	10	3,05
90094432_25	3,2 x 25	8	10	3,05
90094432_40	3,2 x 40	6	10	3,05
90094440_50	4,0 x 50	4	10	3,05



Blister Pack Art.-Nr. 3001 / Kupfer
Bootsnagel inkl. Nietscheibe

Blister pack art. no. 3001, copper boat nail, incl. rivet washer

Art.-Nr.
3001

Bestell-Nr. Order no.	Abmessung Dimensions	Stück Pieces	Box Box	1 Box VK*
9300112_25	2 x 25	20	10	3,05
93001127_32	2,7 x 32	10	10	3,05
93001132_38	3,2 x 38	6	10	3,05
9300114_70	4 x 70	3	10	3,05

Blister Pack DIN 934 / A4-AISI 316
Sechskantmutter

Blister pack DIN 934, hexagon nut

DIN 934

Bestell-Nr. Order no.	Abmessung Dimensions	Stück Pieces	Box Box	1 Box VK A4*
9093443	M3	15	10	3,05
9093444	M4	15	10	3,05
9093445	M5	15	10	3,05
9093446	M6	10	10	3,05
9093448	M8	5	10	3,05

Blister Pack Art.-Nr. 1004 / A4-AISI 316
Hülsenmutter mit Linsensenkopf und Schlitz / Blister pack
art. no. 1004, raised countersunk head sleeve nuts with slotArt.-Nr.
1004

Bestell-Nr. Order no.	Abmessung Dimensions	Stück Pieces	Box Box	1 Box VK A4*
9100424	M4	4	10	3,05
9100425	M5	4	10	3,05
9100426	M6	3	10	3,05
9100428	M8	2	10	3,05

Blister Pack Art.-Nr. 1014 / A2-AISI 304
Blindniete

Blister pack art. no. 1014, blind rivet

Art.-Nr.
1014

Bestell-Nr. Order no.	Abmessung Dimensions	Stück Pieces	Box Box	1 Box VK A2*
9101423_12	3 x 12	5	10	2,35
9101424_16	4 x 16	4	10	2,35
9101424_18	4 x 18	4	10	2,35
9101425_20	5 x 20	2	10	2,35
9101425_25	5 x 25	2	10	2,35
91014264_20	6,4 x 20	1	10	2,35
91014264_25	6,4 x 25	1	10	2,35



A2-Verkaufsständer



Ständer komplett bestückt
Display completely stocked

1890,- €

netto + MwSt. · net value plus VAT

- Exklusiver, drehbarer Verkaufsständer mit einer Grundfläche von nur 1 qm und einer Höhe von 2,20 m
- Exclusive rotating display with a base area of only 1sqm and a height of 2.20 m
- 246 verschiedene und gängige Schraubenabmessungen auf engstem Raum
- 246 different and common screw dimensions displayed
- Keine unterschiedlichen Preisgruppen im EK- und VK-Preis
- No different cost price and sales categories
- EAN-Code auf allen Packungen
- EAN-code on all packages
- Jede Verpackung mit Sichtfenster und Produktabbildung
- Each package with window and product illustration
- Einfache Nachbestellung im 10er-Karton
- Simple repeat order in cartons of 10

Das Sortiment besteht aus: The assortment contains:

- | | | |
|------------|-----------|------------|
| • DIN 963 | • DIN 571 | • DIN 127 |
| • DIN 964 | • DIN 603 | • DIN 9021 |
| • DIN 84 | • DIN 95 | • DIN 1587 |
| • DIN 7981 | • DIN 97 | • DIN 94 |
| • DIN 7982 | • DIN 934 | • DIN 315 |
| • DIN 7983 | • DIN 985 | |
| • DIN 933 | • DIN 125 | |

Art.-Nr.

- | | |
|------|---|
| 1004 | Hülsenmuttern / Case nuts |
| 1005 | Spanplattenschrauben / Chipboard screws |
| 1011 | Rosetten / Turned full bodies |
| 1014 | Blindnieten / Blind rivets |

A2 Schrauben in SB-Verpackungen

Screws in self-service packages
Blister A2 - A4

12

Blister Pack DIN 84 + DIN 934 / A2-AISI 304

Zylinderschraube mit Schlitz und Mutter

Blister pack DIN 84 + DIN 934, slotted cheese head screw with nut

DIN 84

Bestell-Nr. Order no.	Abmessung Dimensions	Stück Pieces	Box Box	1 Box VK A2*
8008423__10	M3 x 10	10	10	2,35
8008423__16	M3 x 16	10	10	2,35
8008423__20	M3 x 20	8	10	2,35
8008424__16	M4 x 16	8	10	2,35
8008424__20	M4 x 20	8	10	2,35
8008424__30	M4 x 30	6	10	2,35
8008424__40	M4 x 40	6	10	2,35
8008425__20	M5 x 20	6	10	2,35
8008425__30	M5 x 30	6	10	2,35
8008425__40	M5 x 40	4	10	2,35
8008425__50	M5 x 50	4	10	2,35
8008426__20	M6 x 20	4	10	2,35
8008426__30	M6 x 30	4	10	2,35
8008426__40	M6 x 40	4	10	2,35
8008426__60	M6 x 60	4	10	2,35
8008428__60	M8 x 60	2	10	2,35
8008428__80	M8 x 80	2	10	2,35
8008428__100	M8 x 100	2	10	2,35

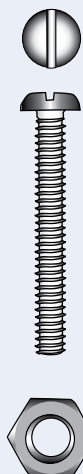

Blister Pack DIN 603 + DIN 934 / A2-AISI 304

Flachrundschaube mit Virkantansatz und Mutter / Blister

pack DIN 603 + DIN 934, mushroom head square neck bolt with nut

DIN 603

Bestell-Nr. Order no.	Abmessung Dimensions	Stück Pieces	Box Box	1 Box VK A2*
8060326__25	6 x 25	4	10	2,35
8060326__30	6 x 30	4	10	2,35
8060326__40	6 x 40	4	10	2,35
8060326__50	6 x 50	4	10	2,35
8060326__60	6 x 60	2	10	2,35
8060328__40	8 x 40	2	10	2,35
8060328__60	8 x 60	2	10	2,35
8060328__70	8 x 70	2	10	2,35
8060328__80	8 x 80	2	10	2,35

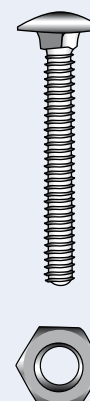

12

DIN 963

Blister Pack DIN 963 + DIN 934 / A2-AISI 304

Senkschraube mit Schlitz und Mutter / Blister pack

DIN 963 + DIN 934, slotted countersunk head screw with nut



Bestell-Nr. Order no.	Abmessung Dimensions	Stück Pieces	Box Box	1 Box VK A2*
8096323__10	3 x 10	10	10	2,35
8096323__16	3 x 16	10	10	2,35
8096323__20	3 x 20	8	10	2,35
8096324__16	4 x 16	8	10	2,35
8096324__20	4 x 20	8	10	2,35
8096324__30	4 x 30	6	10	2,35
8096324__40	4 x 40	6	10	2,35
8096325__16	5 x 16	6	10	2,35
8096325__20	5 x 20	6	10	2,35
8096325__30	5 x 30	6	10	2,35
8096325__40	5 x 40	4	10	2,35
8096325__50	5 x 50	4	10	2,35
8096326__20	6 x 20	4	10	2,35
8096326__30	6 x 30	4	10	2,35
8096326__40	6 x 40	4	10	2,35
8096326__50	6 x 50	4	10	2,35
8096326__60	6 x 60	4	10	2,35
8096328__60	8 x 60	2	10	2,35
8096328__80	8 x 80	2	10	2,35
8096328__100	8 x 100	2	10	2,35

DIN 933

Blister Pack DIN 933 + DIN 934 / A2-AISI 304

Sechskant-Gewindeschraube mit Mutter

Blister pack DIN 933 + DIN 934, hexagon head bolt

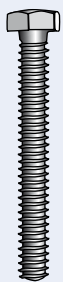

Bestell-Nr. Order no.	Abmessung Dimensions	Stück Pieces	Box Box	1 Box VK A2*
8093325__16	5 x 16	8	10	2,35
8093325__20	5 x 20	8	10	2,35
8093325__25	5 x 25	6	10	2,35
8093325__30	5 x 30	6	10	2,35
8093325__40	5 x 40	6	10	2,35
8093325__50	5 x 50	4	10	2,35
8093326__20	6 x 20	6	10	2,35
8093326__25	6 x 25	6	10	2,35
8093326__30	6 x 30	4	10	2,35
8093326__40	6 x 40	4	10	2,35
8093326__60	6 x 60	4	10	2,35
8093328__30	8 x 30	4	10	2,35
8093328__40	8 x 40	4	10	2,35
8093328__50	8 x 50	2	10	2,35
8093328__60	8 x 60	2	10	2,35
8093328__80	8 x 80	2	10	2,35
8093328__100	8 x 100	2	10	2,35





Blister Pack DIN 964 + DIN 934 / A2-AISI 304
Linsensenkschraube mit Schlitz und Mutter / Blister pack
DIN 964 + DIN 934, slotted raised countersunk head screw with nut

DIN 964

Bestell-Nr. Order no.	Abmessung Dimensions	Stück Pieces	Box Box	1 Box VK A2*
8096423__10	3 x 10	10	10	2,35
8096423__16	3 x 16	10	10	2,35
8096423__20	3 x 20	8	10	2,35
8096424__16	4 x 16	8	10	2,35
8096424__20	4 x 20	8	10	2,35
8096424__30	4 x 30	6	10	2,35
8096424__40	4 x 40	6	10	2,35
8096425__16	5 x 16	6	10	2,35
8096425__20	5 x 20	4	10	2,35
8096425__30	5 x 30	4	10	2,35
8093425__40	5 x 40	4	10	2,35
8096425__50	5 x 50	4	10	2,35
8096426__20	6 x 20	4	10	2,35
8096426__30	6 x 30	4	10	2,35
8096426__40	6 x 40	4	10	2,35
8096426__50	6 x 50	4	10	2,35
8096426__60	6 x 60	4	10	2,35
8096428__60	8 x 60	2	10	2,35
8096428__80	8 x 80	2	10	2,35
8096428__100	8 x 100	2	10	2,35

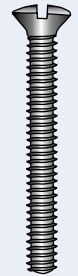

Blister Pack DIN 571 / A2-AISI 304
Sechskant-Holzschraube
Blister pack DIN 571, hexagon head wood screw

DIN 571

Bestell-Nr. Order no.	Abmessung Dimensions	Stück Pieces	Box Box	1 Box VK A2*
8057126__50	6 x 50	4	10	2,35
8057126__60	6 x 60	4	10	2,35
8057126__70	6 x 70	2	10	2,35
8057126__80	6 x 80	2	10	2,35
8057128__60	8 x 60	2	10	2,35
8057128__70	8 x 70	2	10	2,35
8057128__80	8 x 80	2	10	2,35

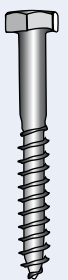

DIN 7981

Blister Pack DIN 7981 / A2-AISI 304

Blechschaube, Linsenkopf

Blister pack DIN 7981, cross recessed tapping screw, pan head

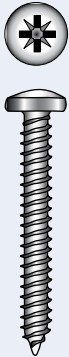

Bestell-Nr. Order no.	Abmessung Dimensions	Stück Pieces	Box Box	1 Box VK A2*
87981229_95	2,9 x 9,5	20	10	2,35
87981229_13	2,9 x 13	20	10	2,35
87981229_16	2,9 x 16	20	10	2,35
87981235_13	3,5 x 13	15	10	2,35
87981235_16	3,5 x 16	12	10	2,35
87891235_19	3,5 x 19	12	10	2,35
87891235_25	3,5 x 25	12	10	2,35
87981242_13	4,2 x 13	12	10	2,35
87981242_16	4,2 x 16	12	10	2,35
87981242_19	4,2 x 19	12	10	2,35
87981242_25	4,2 x 25	10	10	2,35
87981242_32	4,2 x 32	10	10	2,35
87981248_13	4,8 x 13	10	10	2,35
87981248_19	4,8 x 19	10	10	2,35
87981248_25	4,8 x 25	10	10	2,35
87981248_32	4,8 x 32	6	10	2,35
87981255_16	5,5 x 16	6	10	2,35
87981255_25	5,5 x 25	6	10	2,35
87981255_32	5,5 x 32	6	10	2,35
87981255_38	5,5 x 38	6	10	2,35

DIN 97

Blister Pack DIN 97 / A2-AISI 304

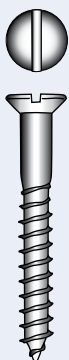
Senk-Holzschraube mit Schlitz / Blister pack DIN 97,
slotted countersunk head wood screw

Bestell-Nr. Order no.	Abmessung Dimensions	Stück Pieces	Box Box	1 Box VK A2*
8009723_12	3,0 x 12	10	10	2,35
8009723_16	3,0 x 16	10	10	2,35
8009723_20	3,0 x 20	10	10	2,35
8009723_25	3,0 x 25	8	10	2,35
8009723_30	3,0 x 30	8	10	2,35
8009724_20	4,0 x 20	8	10	2,35
8009724_30	4,0 x 30	6	10	2,35
8009724_40	4,0 x 40	6	10	2,35
8009724_50	4,0 x 50	6	10	2,35
8009725_30	5,0 x 30	4	10	2,35
8009725_40	5,0 x 40	4	10	2,35
8009725_50	5,0 x 50	4	10	2,35
8009725_60	5,0 x 60	4	10	2,35
8009726_60	6,0 x 60	2	10	2,35
8009726_70	6,0 x 70	2	10	2,35



Blister Pack DIN 7982 / A2-AISI 304
Blechschaube, Senkkopf / Blister pack DIN 7982,
cross recessed tapping screw, countersunk head

DIN 7982

Bestell-Nr. Order no.	Abmessung Dimensions	Stück Pieces	Box Box	1 Box VK A2*
87982229_95	2,9 x 9,5	20	10	2,35
87982229_13	2,9 x 13	20	10	2,35
87982229_16	2,9 x 16	20	10	2,35
87982235_13	3,5 x 13	15	10	2,35
87982235_16	3,5 x 16	12	10	2,35
87982235_19	3,5 x 19	12	10	2,35
87982235_25	3,5 x 25	12	10	2,35
87982242_13	4,2 x 13	12	10	2,35
87982242_16	4,2 x 16	12	10	2,35
87982242_19	4,2 x 19	12	10	2,35
87982242_25	4,2 x 25	10	10	2,35
87982242_32	4,2 x 32	10	10	2,35
87982248_13	4,8 x 13	10	10	2,35
87982248_19	4,8 x 19	10	10	2,35
87982248_25	4,8 x 25	10	10	2,35
87982248_32	4,8 x 32	6	10	2,35
87982255_16	5,5 x 16	6	10	2,35
87982255_25	5,5 x 25	6	10	2,35
87982255_32	5,5 x 32	6	10	2,35
87982255_38	5,5 x 38	6	10	2,35

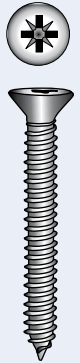



A2 Schrauben in SB-Verpackungen

Screws in self-service packages
Blister A2 - A4

12

Blister Pack DIN 7983 / A2-AISI 304
Blechschaube, Linsensenkkopf / Blister pack DIN 7983,
cross recessed tapping screw, raised countersunk head

DIN 7983

Bestell-Nr. Order no.	Abmessung Dimensions	Stück Pieces	Box Box	1 Box VK A2*
87983229_95	2,9 x 9,5	20	10	2,35
87983229_13	2,9 x 13	20	10	2,35
87983229_16	2,9 x 16	20	10	2,35
87983235_13	3,5 x 13	15	10	2,35
87983235_16	3,5 x 16	12	10	2,35
87983235_19	3,5 x 19	12	10	2,35
87983235_25	3,5 x 25	12	10	2,35
87983242_13	4,2 x 13	12	10	2,35
87983242_16	4,2 x 16	12	10	2,35
87983242_19	4,2 x 19	12	10	2,35
87983242_25	4,2 x 25	10	10	2,35
87983242_32	4,2 x 32	10	10	2,35
87983248_13	4,8 x 13	10	10	2,35
87983248_19	4,8 x 19	10	10	2,35
87983248_25	4,8 x 25	10	10	2,35
87983248_32	4,8 x 32	6	10	2,35
87983255_16	5,5 x 16	6	10	2,35
87983255_25	5,5 x 25	6	10	2,35
87983255_32	5,5 x 32	6	10	2,35
87983255_38	5,5 x 38	6	10	2,35

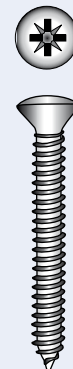

Blister Pack DIN 95 / A2-AISI 304
Linsensenk-Holzschraube mit Schlitz / Blister pack DIN 95,
slotted raised countersunk head wood screw

DIN 95

Bestell-Nr. Order no.	Abmessung Dimensions	Stück Pieces	Box Box	1 Box VK A2*
80095225_12	2,5 x 12	10	10	2,35
80095225_16	2,5 x 16	10	10	2,35
80095230_12	3,0 x 12	10	10	2,35
80095230_16	3,0 x 16	10	10	2,35
80095230_20	3,0 x 20	10	10	2,35
80095230_25	3,0 x 25	8	10	2,35
80095230_30	3,0 x 30	8	10	2,35
80095240_20	4,0 x 20	8	10	2,35
80095240_30	4,0 x 30	6	10	2,35
80095240_40	4,0 x 40	6	10	2,35
80085240_50	4,0 x 50	4	10	2,35
80095250_30	5,0 x 30	4	10	2,35
80095250_40	5,0 x 40	4	10	2,35
80095250_50	5,0 x 50	4	10	2,35
80095250_60	5,0 x 60	4	10	2,35
80095260_60	6,0 x 60	2	10	2,35
80095260_70	6,0 x 70	2	10	2,35

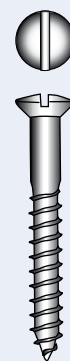

12

Art.-Nr. 1005

Blister Pack Art.-Nr. 1005 / A2-AISI 304
Spanplattenschraube Senkkopf mit Pozidrive-Kreuzschlitz
(gleitbeschichtet), Blister pack art. no. 1005, **

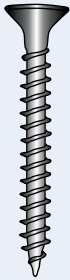

Bestell-Nr. Order no.	Abmessung Dimensions	Stück Pieces	Box Box	1 Box VK A2*
81005230_20	3,0 x 20	10	10	2,35
81005230_30	3,0 x 30	8	10	2,35
81005240_30	4,0 x 30	8	10	2,35
81005240_40	4,0 x 40	6	10	2,35
81005250_40	5,0 x 40	4	10	2,35
81005250_50	5,0 x 50	4	10	2,35
81005260_60	6,0 x 60	2	10	2,35

** countersunk head cross recessed chipboardscrew (pozidrive)

DIN 125

Blister Pack DIN 125 / A2-AISI 304
Unterlegscheibe
Blister pack DIN 125, washer



Bestell-Nr. Order no.	Abmessung Dimensions	Stück Pieces	Box Box	1 Box VK A2*
80125232	3,2	20	10	2,35
80125243	4,3	20	10	2,35
80125253	5,3	20	10	2,35
80125264	6,4	20	10	2,35
80125284	8,4	20	10	2,35

DIN 127

Blister Pack DIN 127 / A2-AISI 304
Federring
Blister pack DIN 127, spring lock washer



Bestell-Nr. Order no.	Abmessung Dimensions	Stück Pieces	Box Box	1 Box VK A2*
8012723	3	20	10	2,35
8012724	4	20	10	2,35
8012725	5	20	10	2,35
8012726	6	20	10	2,35
8012728	8	20	10	2,35



A2 Schrauben in SB-Verpackungen

Screws in self-service packages
Blister A2 - A4

12



Blister Pack DIN 315 / A2-AISI 304 Flügelmutter Blister pack DIN 315, wing nut

DIN 315

Bestell-Nr. Order no.	Abmessung Dimensions	Stück Pieces	Box Box	1 Box VK A2*
8031523	M3	4	10	2,35
8031524	M4	4	10	2,35
8031525	M5	4	10	2,35
8031526	M6	2	10	2,35
8031528	M8	2	10	2,35



Blister Pack DIN 985 / A2-AISI 304 Poly-Stopmutter Blister pack DIN 985, evailing torque type hexagon nut

DIN 985

Bestell-Nr. Order no.	Abmessung Dimensions	Stück Pieces	Box Box	1 Box VK A2*
8098523	M3	6	10	2,35
8098524	M4	6	10	2,35
8098525	M5	6	10	2,35
8098526	M6	4	10	2,35
8098528	M8	4	10	2,35



Blister Pack DIN 9021 / A2-AISI 304 Unterlegscheibe, groß Blister pack DIN 9021, washer, large

DIN 9021

Bestell-Nr. Order no.	Abmessung Dimensions	Stück Pieces	Box Box	1 Box VK A2*
89021232	3,2	20	10	2,35
89021243	4,3	20	10	2,35
89021253	5,3	20	10	2,35
89021264	6,4	20	10	2,35
89021284	8,4	10	10	2,35



DIN 1587

Blister Pack DIN 1587 / A2-AISI 304
 Hutmutter
 Blister pack DIN 1587, dome cap nut



Bestell-Nr. Order no.	Abmessung Dimensions	Stück Pieces	Box Box	1 Box VK A2*
8158723	M3	4	10	2,35
8158724	M4	4	10	2,35
8158725	M5	4	10	2,35
8158726	M6	3	10	2,35
8158728	M8	3	10	2,35

Art.-Nr.
1011

Blister Pack Art.-Nr. 1011 / A2-AISI 304
 Rosette, gedreht aus Vollmaterial
 Blister pack art. no. 1011, rosette turned full body

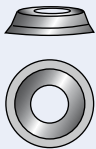

Bestell-Nr. Order no.	Abmessung Dimensions	Stück Pieces	Box Box	1 Box VK A2*
8101123	M3	5	10	2,35
8101124	M4	4	10	2,35
8101125	M5	4	10	2,35
8101126	M6	3	10	2,35
8101128	M8	2	10	2,35

DIN 94

Blister Pack DIN 94 / A2-AISI 304
 Splint
 Blister pack DIN 94, splint pin



Bestell-Nr. Order no.	Abmessung Dimensions	Stück Pieces	Box Box	1 Box VK A2*
80094220_20	2,0 x 20	12	10	2,35
80094225_20	2,5 x 20	10	10	2,35
80094232_25	3,2 x 25	8	10	2,35
80094232_40	3,2 x 40	6	10	2,35
80094240_50	4,0 x 50	4	10	2,35

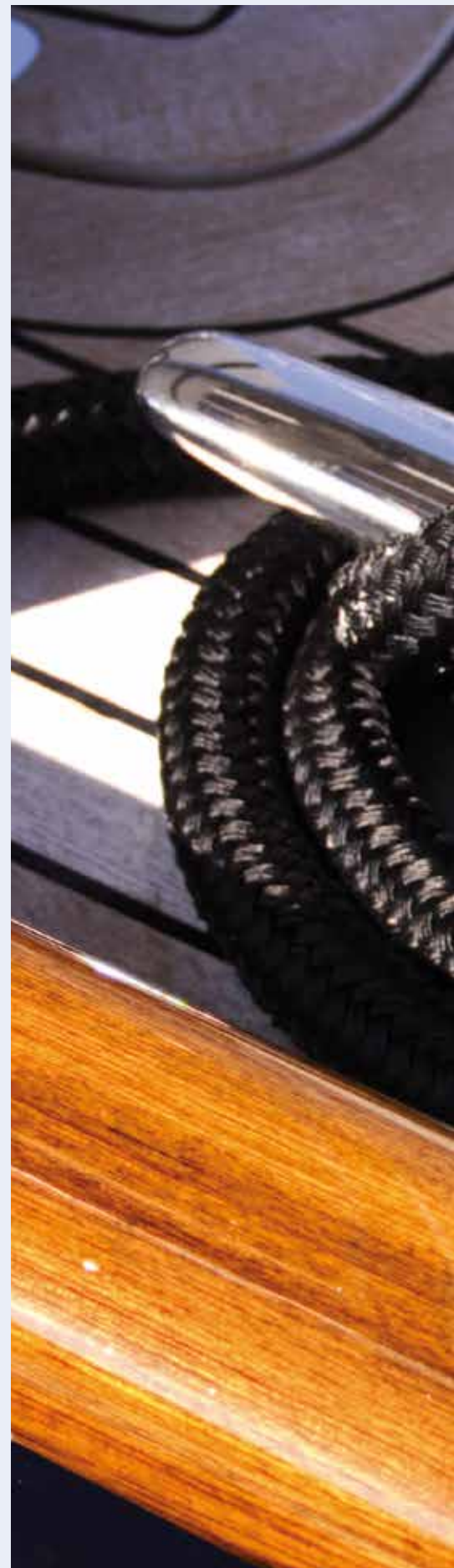

A2 Schrauben in SB-Verpackungen

Screws in self-service packages
Blister A2 - A4

12



Blister Pack DIN 934 / A2-AISI 304 Sechskantmutter Blister pack DIN 934, hexagon nut

DIN 934

Bestell-Nr. Order no.	Abmessung Dimensions	Stück Pieces	Box Box	1 Box VK A2*
8093423	M3	15	10	2,35
8093424	M4	15	10	2,35
8093425	M5	15	10	2,35
8093426	M6	10	10	2,35
8093428	M8	5	10	2,35



Blister Pack Art.-Nr. 1004 / A2-AISI 304 Hülsmutter mit Linsensenkopf und Schlitz / Blister pack art. no. 1004, raised countersunk head sleeve nuts with slot

Art.-Nr. 1004

Bestell-Nr. Order no.	Abmessung Dimensions	Stück Pieces	Box Box	1 Box VK A2*
8100424	M4	4	10	2,35
8100425	M5	4	10	2,35
8100426	M6	3	10	2,35
8100428	M8	2	10	2,35



Blister Pack Art.-Nr. 1014 / A2-AISI 304 Blindniete Blister pack art. no. 1014, blind rivet

Art.-Nr. 1014

Bestell-Nr. Order no.	Abmessung Dimensions	Stück Pieces	Box Box	1 Box VK A2*
8101423_12	3,0 x 12	5	10	2,35
8101424_16	4,0 x 16	4	10	2,35
8101424_18	4,0 x 18	4	10	2,35
8101425_20	5,0 x 20	2	10	2,35
8101425_25	5,0 x 25	2	10	2,35
81014264_20	6,4 x 20	1	10	2,35
81014264_25	6,4 x 25	1	10	2,35

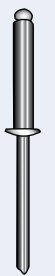

12

Kapitel 13

Chapter 13







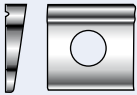
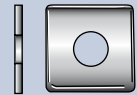
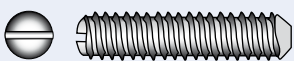

Schrauben in Großpackungen

Screws in bulk packs





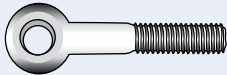
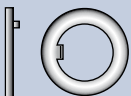





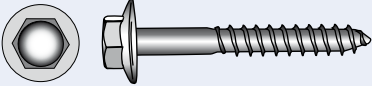
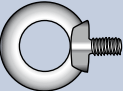

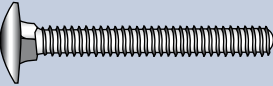
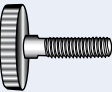
	DIN EN ISO	Bezeichnung Description	Werkstoff Material	
	DIN 1 ISO 2339	Kegelstifte Taper pins Goupilles coniques	A2	A4
	DIN 7 ISO 2338	Zylinderstifte, Form A (Toleranzfeld m 6) Parallel pins Goupilles cylindriques	A2	A4
	DIN 84 ISO 1207	Zylinderschrauben mit Schlitz Slotted cheese head screws Vis à tête cylindrique fendue	A2	A4
	DIN 85 ISO 1580	Flachkopfschrauben mit Schlitz Slotted pan head screws Vis à tête cylindrique à dépouille fendue	A2	A4
	DIN 93	Sicherheitsbleche mit 1 Lappen Tab washers with 1 tab Freins d'écrous à un aileron	A2	A4
	DIN 94 ISO 1234	Splinte Split pins Goupilles fendues	A2	A4
	DIN 95	Linsensenk-Holzschrauben mit Schlitz Slotted raised countersunk head wood screws Vis à bois à tête fendue fraisée bombée	A2	A4
	DIN 96	Halbrund-Holzschrauben mit Schlitz Slotted round head wood screws Vis à bois à tête ronde fendue	A2	A4
	DIN 97	Senk-Holzschrauben mit Schlitz Slotted countersunk head wood screws Vis à bois à tête fendue fraisée	A2	A4
	DIN 125 ISO 7089	Unterlegscheiben Form A (ohne Fase) Plain washers (without chamfer) Rondelles plates	A2	A4
	DIN 127	Federringe Form B (glatt) Flat spring lock washers Rondelle élastiques sans becs	A2	A4
	DIN 128	Federringe Form A (gewölbt) Curved spring lock washers Rondelles élastiques cintrées	A2	A4
	DIN 137 A	Federscheiben Form A (gewölbt) Curved spring washers Rondelles élastiques cintrées	A2	



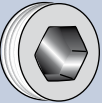

	DIN EN ISO	Bezeichnung Description	Werkstoff Material
	DIN 137 B	Federscheiben Form B (gewellt) Wave spring washers Rondelles élastiques ondulées	A2 A4
	DIN 315	Flügelmuttern, amerikanische Form Wing nuts, American Ecrous à oreilles, type américain	A2 A4
	DIN 315	Flügelmuttern, schwere Form Wing nuts, heavy duty Ecrous à oreilles	A2 A4
	DIN 316	Flügelschrauben, amerikanische Form Wing screws, American Vis à oreilles, type américain	A2 A4
	DIN 316	Flügelschrauben, schwere Form Wing screws, heavy duty Vis à oreilles	A2 A4
	DIN 404	Kreuzlochschrauben mit Schlitz Capstan screws, slotted Vis de plombage avec fente	A2
	DIN 417 ISO 7435	Gewindestifte mit Schlitz und Zapfen Slotted set screws with long dog point Vis sans tête, fendues, à téton long	A2
	DIN 427 ISO 2342	Schaftschrauben mit Schlitz und Kegelkuppe Slotted headless screws with chamfered end Vis sans tête, partiellement filetées, à bout chanfreiné	A2 A4
	DIN 431 B	Rohrmuttern Form B, Rohrgewinde nach DIN ISO 228 Pipe nuts with thread according to DIN ISO 228 Ecrous six pans, filet à gaz	A2 A4
	DIN 432	Sicherungsbleche mit Nase Washers with external tab Freins d'écrous avec ergot extérieur	A2 A4
	DIN 433 ISO 7092	Unterlegscheiben für Zylinderschrauben Washers for cheese head screws Rondelles pour vis à tête cylindrique	A2 A4
	DIN 434	Keilscheiben für U-Träger, Neigung 8% Square taper washers for U-sections Plaquette oblique pour profilés en U	A2 A4

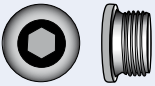
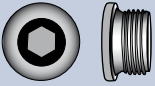
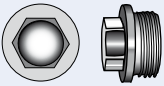
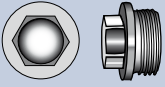

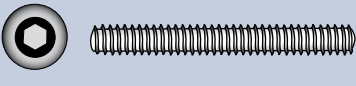
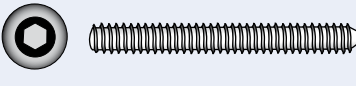
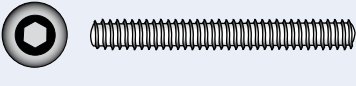
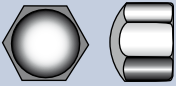
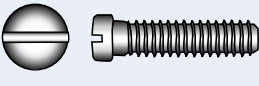

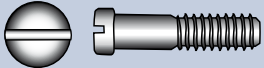
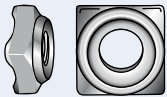
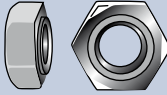
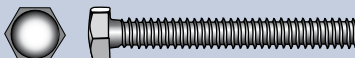
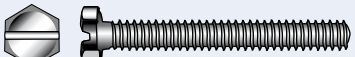
	DIN EN ISO	Bezeichnung Description	Werkstoff Material	
	DIN 435	Keilscheiben für I-Träger, Neigung 14% Square taper washers for I-sections Plaquette oblique pour profilés en I	A2	A4
	DIN 436	Vierkantscheiben für Holzkonstruktionen Square washers for wood constructions Rondelles carrées pour constructions en bois	A2	A4
	DIN 438 ISO 7436	Gewindestifte mit Schlitz und Ringschneide Slotted set screws with cup point Vis sans tête, fendues, à bout cuvette	A2	
	DIN 439 ISO 4035	Sechskantmuttern, niedrige Form, Form B (mit Fase) Hexagon thin nuts Ecrous bas hexagonaux	A2	A4
	DIN 439 ISO 4035	Sechskantmuttern, niedrige Form, Feingewinde, Form B (mit Fase) Hexagon thin nuts, fine pitch Ecrous bas hexagonaux, filet fin métrique	A2	A4
	DIN 439 ISO 4035	Sechskantmuttern, niedrige Form, Linksgewinde, Form B (mit Fase) Hexagon thin nuts left hand thread Ecrous bas hexagonaux à gauche	A2	A4
	DIN 440 R ISO 7094	Scheiben für Holzkonstruktionen, Form R = Rundloch Washers, especially for wood constructions Rondelles, principalement pour constructions en bois	A2	A4
	DIN 440 V ISO 7094	Scheiben für Holzkonstruktionen, Form V = Vierkantloch Washers, especially for wood constructions Rondelles, principalement pour constructions en bois	A2	A4
	DIN 444 B	Augenschrauben, Form B Eye bolts Vis à oeillet	A2	A4
	DIN 462	Sicherungsbleche mit Innennase für Nutmuttern DIN 1804 Tab washers with internal tab for nuts DIN 1804 Rondelles à ergot intérieur pour écrous rainés selon DIN 1804	A2	A4
	DIN 463	Sicherungsbleche mit 2 Lappen Tab washers with 2 tabs Freins D'écrous à 2 ailerons d'équerre	A2	A4

	DIN EN ISO	Bezeichnung Description	Werkstoff Material	
	DIN 464	Rändelschrauben, hohe Form Knurled thumb screws, high type Vis moletées, type haut	A2	
	DIN 465	Rändelschrauben, hohe Form, mit Schlitz Slotted knurled thumb screws, high type Vis moletées, type haute, avec fente	A2	
	DIN 466	Rändelmuttern, hohe Form Knurled thumb nuts, high type Ecrous moletées, type haut	A2	
	DIN 467	Rändelmuttern, niedrige Form Knurled thumb nuts, thin type Ecrous moletées, type bas	A2	
	DIN 471	Sicherungsringe für Wellen Retaining rings for shafts Circlips extérieurs	A2	
	DIN 472	Sicherungsringe für Bohrungen Retaining rings for bores Circlips intérieurs	A2	
	DIN 546	Schlitzmuttern Slotted round nuts Ecrous cylindriques à fente	A2	A4
	DIN 551 ISO 4766	Gewindestifte mit Schlitz und Kegelkuppe Slotted set screws with flat point Vis sans tête avec fente et chanfrein	A2	A4
	DIN 553 ISO 7434	Gewindestifte mit Schlitz und Spitze Slotted set screws with cone point Vis sans tête avec fente et pointe	A2	A4
	DIN 557	Vierkantmuttern Square nuts Ecrous carrés	A2	A4
	DIN 562	Vierkantmuttern, niedrige Form Square thin nuts Ecrous carrées bas	A2	A4
	DIN 571	Sechskant-Holzschrauben Hexagon head wood screws Vis à bois à tête hexagonale	A2	A4

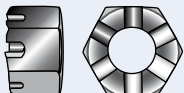



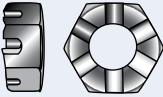

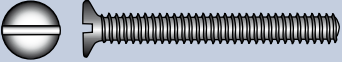
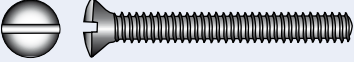
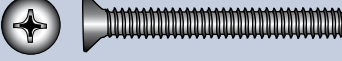
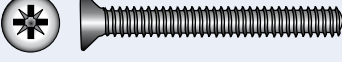
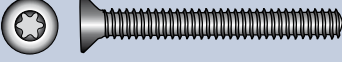
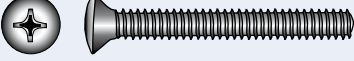
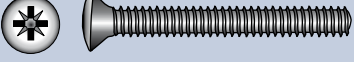
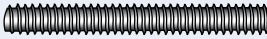

	DIN EN ISO	Bezeichnung Description	Werkstoff Material	
	Art.-Nr. 572	Sechskant-Holzschrauben mit Flansch Hexagon wood screws with flange Vis bois T.H. à embase	A2	
	DIN 580 Art.-Nr. 8272	Ringschrauben Lifting eye bolts Vis à anneau	A2	A4
	DIN 582 Art.-Nr. 8268	Ringmuttern Lifting eye nuts Ecrous à anneau	A2	A4
	DIN 603 ISO 8677	Flachrundschrauben mit Vierkantansatz Mushroom head square neck bolts Vis à tête bombée à collet carré	A2	A4
	DIN 653	Rändelschrauben , niedrige Form Knurled thumb screws, thin type Vis moletées, type bas	A2	
	DIN 660	Halbrundnieten Round head rivets Rivets à tête ronde	A2	A4
	DIN 661	Senknieten Countersunk head rivets Rivets à tête fraisée	A2	
	DIN 705	Stellringe Form A, mit Gewindestiften DIN 914 Adjusting rings with set screw DIN 914 Bagues d'arrêt	A2	
	DIN 835	Stiftschrauben, Einschraubende ~2 d Studs, metal end ~2 d Goujons-partie fileté e ~2 d	A2	A4
	DIN 906	Verschlusschrauben mit Innensechskant, kegeliges Gewinde metrisch nach DIN 158 Hexagon socket pipe plugs, conical thread according to DIN 158 · Bouchons filetés à six pans creux, filetage conique à la DIN 158	A2	A4
	DIN 906	Verschlusschrauben mit Innensechskant, WITHWORTH Rohrgewinde nach DIN 3858 Hexagon socket pipe plugs, conical thread according to DIN 3858 · Bouchons filetés à six pans creux, filetage conique à la DIN 3858	A2	A4





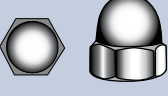
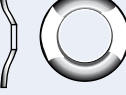

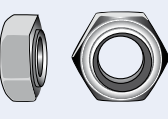
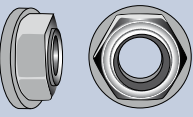
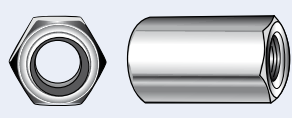
	DIN EN ISO	Bezeichnung Description	Werkstoff Material	
	DIN 908	Verschlusschrauben mit Bund und Innensechskant, metrisches Feingewinde nach DIN 13 Hexagon socket pipe plugs, metric fine pitch according to DIN 13 · Bouchons filetés avec épaulement et six pans creux, filet fin métrique à la DIN 13	A2	A4
	DIN 908	Verschlusschrauben mit Bund und Innensechskant, zylindrisches Gasgewinde nach DIN 228 Hexagon socket pipe plugs, cylindrical thread according to DIN 228 · Bouchons filetés cylindriques à collerette et à six pans creux, à la DIN 228	A2	A4
	DIN 910	Verschlusschrauben mit Bund und Außensechskant, metrisches Feingewinde nach DIN 13 Hexagon head pipe plugs, cylindrical thread metric fine pitch according to DIN 13 · Bouchons filetés cylindriques à tête hexagonale, à collerette, filet fin métrique à la DIN 13	A2	A4
	DIN 910	Verschlusschrauben mit Bund und Außensechskant, zylindrisches Gasgewinde nach DIN 228 Hexagon head pipe plugs, cylindrical thread, according to DIN 228 · Bouchons filetés cylindriques à tête hexagonale, à collerette; type large à la DIN 228	A2	A4
	DIN 912 ISO 4762	Zylinderschrauben mit Innensechskant Hexagon socket head cap screws Vis à six pans creux, tête cylindrique	A2	A4
	DIN 913 ISO 4026	Gewindestifte mit Innensechskant und Kegelkuppe Hexagon socket set screws with flat point Vis sans tête à six pans creux avec bout plat	A2	A4
	DIN 914 ISO 4027	Gewindestifte mit Innensechskant und Spitze Hexagon socket set screws with cone point Vis sans tête à six pans creux avec bout pointu	A2	A4
	DIN 915 ISO 4028	Gewindestifte mit Innensechskant und Zapfen Hexagon socket set screws with dog point Vis sans tête à six pans creux avec téton long	A2	A4
	DIN 916 ISO 4029	Gewindestifte mit Innensechskant und Ringschneide Hexagon socket set screws with cup point Vis sans tête à six pans creux avec cuvette	A2	A4
	DIN 917	Sechskant-Hutmuttern, niedrige Form Hexagon cap nuts, flat type Ecrous borgnes hexagonaux bas	A2	A4
	DIN 920	Flachkopfschrauben mit Schlitz und kleinem Kopf Slotted pan head screws with small head Vis à tête cylindrique à dépouille, fendue, réduite	A2	

	DIN EN ISO	Bezeichnung Description	Werkstoff Material
	DIN 921	Flachkopfschrauben mit Schlitz und großem Kopf Slotted pan head screws with large head Vis à tête cylindrique à dépouille, fendue, large	A2
	DIN 923	Flachkopfschrauben mit Schlitz und Ansatz Slotted pan head screws with shoulder · Vis à tête cylindrique à dépouille, fendue, à tige ajustable	A2
	DIN 928	Vierkant-Schweissmuttern Square weld nuts Ecrous carrés à souder	A2 A4
	DIN 929	Sechskant-Schweissmuttern Hexagon weld nuts Ecrous hexagonaux à souder	A2 A4
	DIN 931 ISO 4014	Sechskantschrauben mit Schaft Hexagon head bolts Vis à tête six pans	A2 A4
	DIN 933 ISO 4017	Sechskantschrauben mit Gewinde bis Kopf Hexagon head screws Vis à tête six pans	A2 A4
	DIN 933 SZ ISO 4017	Sechskantschrauben mit Schlitz Slotted hexagon head screws Vis à tête pans avec fente	A2 A4
	DIN 934	Sechskantmuttern Hexagon nuts Ecrous hexagonaux	A2 A4
	ISO 4032	Sechskantmuttern Hexagon nuts Ecrous hexagonaux	A2 A4
	DIN 934	Sechskantmuttern 1.4571 Hexagon nuts Ecrous hexagonaux	A5
	DIN 934	Sechskantmuttern mit Linksgewinde Hexagon nuts left hand thread Ecrous hexagonaux à gauche	A2 A4
	DIN 934	Sechskantmuttern mit Feingewinde Hexagon nuts, fine pitch Ecrous hexagonaux, filet fin métrique	A2 A4
	DIN 935 ISO 7035	Kronenmuttern Hexagon castle nuts, slotted Ecrous hexagonaux à créneaux	A2 A4

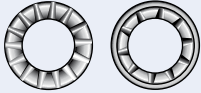
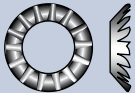
	DIN EN ISO	Bezeichnung Description	Werkstoff Material	
	DIN 936	Sechskantmuttern, niedrige Form Hexagon thin nuts Ecrus hexagonaux, bas	A2	A4
	DIN 936	Sechskantmuttern, niedrige Form, Feingewinde Hexagon thin nuts, fine pitch Ecrus hexagonaux, bas, filet fin métrique	A2	
	DIN 937	Kronenmuttern, niedrige Form Thin hexagon castle nuts, slotted Ecrus hexagonaux à créneaux, bas	A2	A4
	DIN 938	Stiftschrauben, Einschraubende ~ 1 d Studs, metal end ~ 1 d Goujons filetés, partie filetée ~ 1 d	A2	A4
	DIN 939	Stiftschrauben, Einschraubende ~ 1,25 d Studs, metal end ~ 1,25 d Goujons filetés, partie filetée ~ 1,25 d	A2	A4
	DIN 963 ISO 2009	Senkschrauben mit Schlitz Slotted countersunk head screws Vis à tête fraisée fendue	A2	A4
	DIN 964 ISO 2010	Linsensenkschrauben mit Schlitz Slotted raised countersunk head screws Vis à tête fraisée bombée fendue	A2	A4
	DIN 965 H ISO 7046	Senkschrauben mit Kreuzschlitz H-Phillips Cross recessed countersunk (flat) head screws - H Vis à tête fraisée à empreinte cruciforme - H	A2	A4
	DIN 965 Z ISO 7046	Senkschrauben mit Kreuzschlitz Z-Pozidrive Cross recessed countersunk (flat) head screws - Z Vis à tête fraisée à empreinte cruciforme - Z	A2	A4
	DIN 965 TX ISO 7046	Senkschrauben mit Innenvielzahn Countersunk (flat) head screws, six lobe drive Vis à tête conique, fraisée, à six lobes intérieurs	A2	A4
	DIN 966 H ISO 7047	Linsen-Senkschrauben mit Kreuzschlitz H-Phillips Cross recessed raised countersunk head screws - H Vis à tête fraisée bombée à empreinte cruciforme - H	A2	A4
	DIN 966 Z ISO 7047	Linsen-Senkschrauben mit Kreuzschlitz Z - Pozidrive Cross recessed raised countersunk head screws - Z Vis à tête fraisée bombée à empreinte cruciforme - Z	A2	A4
	DIN 976	Gewindestangen, Länge l = 1m, 2m, 3m Threaded rods Tiges filetées	A2	A4

	DIN EN ISO	Bezeichnung Description	Werkstoff Material	
	DIN 976	Gewindestangen mit Linksgewinde, Länge l = 1m Threaded rods left hand thread Tiges filetées à gauche	A2	A4
	DIN 979	Kronenmuttern, niedrige Form Hexagon slotted thin castle nuts Ecrus hexagonaux à créneaux, bas	A2	A4
	DIN 980	Sechskantmuttern, selbstsichernd mit Klemmteil, Ganzmetallmuttern verformt aus DIN 934 Prevailing torque type hexagon nuts, all-metal nuts Ecrus auto-freinés hexagonaux, écrous tout metal	A2	A4
	DIN 982	Sechskantmuttern, mit nichtmetallischem Klemmteil, hohe Form Prevailing torque type hexagon nuts with non-metallic insert, high · Ecrus auto-freinés hexagonaux avec insert non-metallique, type haut	A2	A4
	DIN 985	Sechskantmuttern, mit nichtmetallischem Klemmteil, niedrige Form Prevailing torque type hexagon nuts with non-metallic insert, low · Ecrus auto-freinés hexagonaux avec insert non-metallique, type bas	A2	A4
	DIN 986	Sechskant-Hutmuttern, mit nichtmetallischem Klemmteil Prevailing torque type hexagon domed cap nuts with nonmetallic insert · Ecrus auto-freinés hexago- naux borgnes à callottes avec insert non-metallique	A2	A4
	DIN 988	Passscheiben Shim rings Rondelles d'ajustage	A2	
	DIN 1052	Scheiben für Holzverbindungen Washers for wood constructions Rondelles pour constructions en bois	A2	A4
	DIN 1440 ISO 8738	Scheiben für Bolzen, Ausführung mittel Washers for clevis pins, medium Rondelles plates pour tourillons	A2	A4
	DIN 1441	Scheiben für Bolzen, Ausführung grob Washers for clevis pins, coarse Rondelles plates pour tourillons	A2	A4
	DIN 1471 ISO 8744	Kegelkerbstifte Grooved pins; full-length taper grooved Goupilles coniques cannelées	A2	

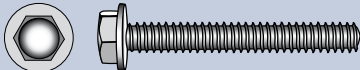
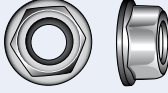
	DIN EN ISO	Bezeichnung Description	Werkstoff Material
	DIN 1472 ISO 8745	Passkerbstifte Grooved pin; half-length taper grooved Goupilles cannelées d'ajustable	A2
	DIN 1473 ISO 8740	Zylinderkerbstifte mit Fase Grooved pin; full-length parallel grooved with chamfer Goupilles cannelées calindriques	A2
	DIN 1474 ISO 8741	Steckkerbstifte Grooved pin; half-length reserve taper grooved Goupilles cannelées d'ajustage	A2
	DIN 1476 ISO 8746	Halbrundkerbnägel Grooved pin with round head Clous cannelées à tête demi-ronde	A2
	ISO 8752	Spannstifte (Spannhülsen), schwere Ausführung Slotted spring pins, heavy duty Goupilles cà ressort	A2
	DIN 1587	Sechskant-Hutmuttern, hohe Form Hexagon domed cap nuts, high type Ecrous borgnes à calotte hexagonaux, forme haute	A2 A4
	DIN 2093	Tellerfeder Disc spring Rondelles-ressort	A2
	DIN 3017	Schlauchschellen mit Schneckenantrieb, Form A Hose clamps Colliers de serrage	A2 A4
	DIN 6330	Sechskantmuttern, 1,5 d hoch, Form B Hexagon nuts 1.5 d high Ecrous hexagonaux 1,5 d	A2 A4
	DIN 6331	Sechskantmuttern, 1,5 d hoch, mit Bund Hexagon nuts 1.5 d high, with collar Ecrous hexagonaux 1,5 d à embase cylindrique	A2 A4
	DIN 6334	Sechskantmuttern (Langmuttern), Höhe = 3 d Hexagon nuts, m = 3 d Ecrous hexagonaux, m = 3 d	A2 A4
	DIN 6796	Spannscheiben für Schraubenverbindungen Conical spring washers for bolted connections Rondelles élastique en cuvette pour assemblages vissés	A2 A4
	DIN 6797	Zahnscheiben Form A und J Toothed lock washers Rondelles élastiques à dents espacées	A2

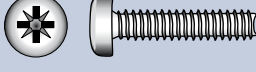
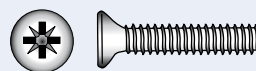
	DIN EN ISO	Bezeichnung Description	Werkstoff Material
	DIN 6798	Fächerscheiben Form A und J Serrated lock washers Rondelles élastique à dents chevanchantes	A2 A4
	DIN 6798	Fächerscheiben Form V Serrated countersunk lock washers Rondelles élastique à dents chevanchantes	A2
	DIN 6799	Sicherungsscheiben (Haltescheiben) für Wellen Retaining washers for shafts Bagues de frein pour arbres	A2
	DIN 6885 A	Passfedern, hohe Form (Form A) Parallel keys, high type Clavettes ajustées	A5
	DIN 6912	Zylinderschrauben mit Innensechskant, niedriger Kopf, mit Schlüsselführung Socket head cap screws, low head, pilot recess Vis à tête cylindrique à six pans creux avec tête basse et trou de guidage	A2 A4
	DIN 6921	Sechskantschrauben mit Flansch Hexagon head screws with flange Vis métaux tête hexagonale à embase lisse	A2 A4
	DIN 6923	Sechskantmuttern mit Flansch ohne Sperrverzahnung Hexagon flange nuts, without serration Ecrous hexagonaux à embase	A2 A4
	ISO 8750	Spiral-Spannstifte Spiral pins Goupilles élastiques en spirale	A2
	DIN 7349	Scheiben für Schrauben mit schweren Spannhülsen Washers for bolts with heavy spring pins Rondelles pour vis avec goupilles élastique lourdes	A2 A4
	DIN 7500 C-Z	Gewindefurchende Linsenschrauben Form C, Kopf nach DIN 7985, Kreuzschlitz Z - Pozidrive Thread rolling raised cheese head screws - Z · Vis format le filetage à tête cylindrique bombée, empreinte cruciforme - Z	A2
	DIN 7500 M-Z	Gewindefurchende Senkschrauben, Form M, Kopf nach DIN 965, Kreuzschlitz Z - Pozidrive Thread rolling countersunk head screws - Z · Vis formant le filetage à tête fraisée, empreinte cruciforme - Z	A2

	DIN EN ISO	Bezeichnung Description	Werkstoff Material
	DIN 7504 M-H	Bohrschrauben mit Linsenkopf, Form M, für Weichmetalle (z.B. Aluminium), Kreuzschlitz H - Pozidrive Self drilling screws with pan head -H Vis auto-perçantes, tête cylindrique bombée - H	A2
	DIN 7504 O-H	Bohrschrauben mit Senkkopf, Form O, für Weichmetalle (z.B. Aluminium), Kreuzschlitz H - Phillips Self drilling screws with countersunk head -H Vis auto-perçantes, tête fraisée - H	A2
	DIN 7504 K	Bohrschrauben mit Sechskantkopf und Bund, Form K, für Weichmetalle (z.B. Aluminium) Self drilling screws with hexagon head and flange Vis auto-perçantes, tête hexagonale	A2
	DIN 7504 KO	Bohrschrauben mit Sechskantkopf und Bund, Form K, für Weichmetalle (z.B. Aluminium) mit aufgesteckter A2 / EPDM- Dichtscheibe Ø 16 mm Self drilling screws with hexagon head and flange with assembled sealing washers 16mm Vis autopercantes, tête hexagonale avec rondelles	A2
	DIN 7967	Sicherungsmuttern Self locking counter nuts Ecrous de sécurité	A2 A4
	DIN 7971 C ISO 1481	Zylinder-Blechschauben mit Schlitz (Form C mit Spitze) Slotted pan head tapping screws Vis à tête cylindrique large, fendue	A2
	DIN 7972 C ISO 1482	Senk-Blechschauben mit Schlitz (Form C mit Spitze) Slotted countersunk head tapping screws Vis à tôle à tête fraisée, fendue	A2
	DIN 7973 C ISO 1483	Linsensenk-Blechschauben mit Schlitz (Form C mit Spitze) Slotted raised countersunk head tapping screws Vis à tôle à tête fraisée bombée, fendue	A2
	DIN 7976 C ISO 1479	Sechskant-Blechschauben (Form C mit Spitze) Hexagon head tapping screws Vis à tôle à tête hexagonal	A2
	DIN 7980	Federringe für Zylinderschrauben Spring lock washers for screws with cylindrical heads Rondelles élastique sans becs pour vis à tête cylindrique	A2 A4
	DIN 7981 C-H ISO 7049	Linsen-Blechschauben (Form C mit Spitze), Kreuzschlitz H - Phillips · Cross recessed pan head tapping screws - H · Vis à tôle à tête cylindrique bombée large à empreinte cruciforme - H	A2 A4





Schrauben in Großpackungen

Screws in bulk packs

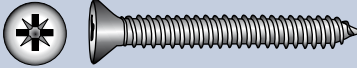

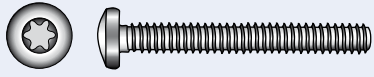
Visserie en gros conditionnement

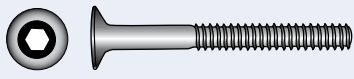
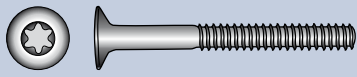
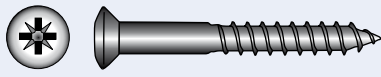
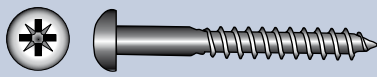
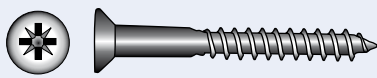

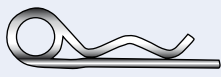
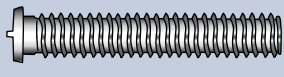
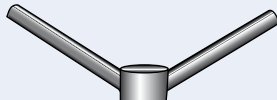
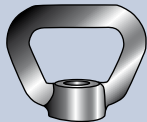

13

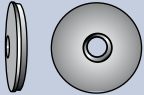
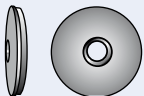
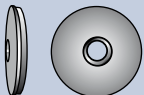
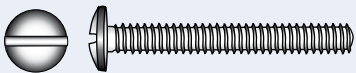
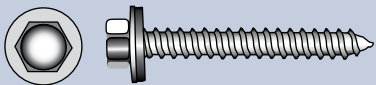
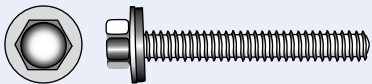
	DIN EN ISO	Bezeichnung Description	Werkstoff Material	
	DIN 7981 C-Z ISO 7049	Linsen-Blechschauben (Form C mit Spitze), Kreuzschlitz Z - Pozidrive · Cross recessed pan head tapping screws - Z · Vis à tôle à tête cylindrique bombée large à empreinte cruciforme - Z	A2	A4
	DIN 7981 C-TX ISO 7049	Linsen-Blechschauben (Form C mit Spitze), Innenvielzahn · Pan head tapping screws, six lobe drive Vis tôle T.C.L., à six lobes intérieurs	A2	A4
	DIN 7982 C-H ISO 7050	Senk-Blechschauben (Form C mit Spitze), Kreuzschlitz H - Phillips · Cross recessed countersunk head tapping screws - H · Vis à tôle à tête fraisée à empreinte cruciforme, à bout pointu - H	A2	A4
	DIN 7982 C-Z ISO 7050	Senk-Blechschauben (Form C mit Spitze), Kreuzschlitz Z - Pozidrive · Cross recessed countersunk head tapping screws - Z · Vis à tôle à tête fraisée à empreinte cruciforme, à bout pointu - Z	A2	A4
	DIN 7982 C-TX ISO 7050	Senk-Blechschauben (Form C mit Spitze), Innenvielzahn · Countersunk head tapping screws, six lobe drive · Vis tôle T.F., à lobes intérieurs	A2	A4
	DIN 7983 C-H ISO 7051	Linsensenk-Blechschauben (Form C mit Spitze), Kreuzschlitz H - Phillips · Cross recessed raised countersunk head tapping screws - H · Vis à tôle à tête fraisée bombée à empreinte cruciforme, à bout pointu - H	A2	A4
	DIN 7983 C-Z ISO 7051	Linsensenk-Blechschauben (Form C mit Spitze), Kreuzschlitz Z - Pozidrive · Cross recessed raised countersunk head tapping screws - Z · Vis à tôle à tête fraisée bombée à empreinte cruciforme, à bout pointu - Z	A2	A4
	DIN 7983 C-TX ISO 7051	Linsensenk-Blechschauben (Form C mit Spitze), Innenvielzahn · Raised countersunk head tapping screws, six lobe drive · Vis tôle T.F.B., à six lobes intérieurs	A2	A4
	DIN 7984	Zylinderschrauben mit Innensechskant und niedrigem Kopf · Hexagon socket head cap screws with low head · Vis à tête cylindrique à six pans creux avec tête basse	A2	A4
	DIN 7985 H ISO 7045	Linsenschrauben, Kreuzschlitz H - Phillips Cross recessed raised cheese head screws - H · Vis à tête cylindrique bombée à empreinte cruciforme - H	A2	A4
	DIN 7985 Z ISO 7045	Linsenschrauben, Kreuzschlitz Z - Pozidrive Cross recessed raised cheese head screws - Z · Vis à tête cylindrique bombée à empreinte cruciforme - Z	A2	A4

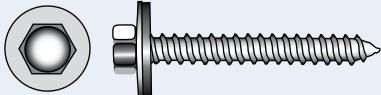
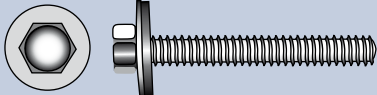
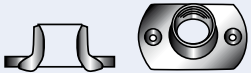
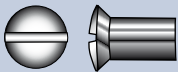

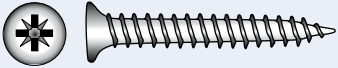
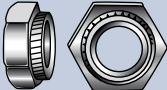
	DIN EN ISO	Bezeichnung Description	Werkstoff Material
	DIN 7985 TX ISO 7045	Linsenschrauben, Innenvielzahn Pan head screws, six lobe drive Vis à tête cylindrique bombée à six lobes intérieurs	A2 A4
	DIN 7989	Scheiben für Stahlkonstruktionen Washers for steel constructions Rondelles pour constructions en metal	A2 A4
	DIN 7991	Senkschrauben mit Innensechskant Hexagon socket countersunk head screws Vis à tête fraisée à six pans creux	A2 A4
	DIN 7991 TX	Senkschrauben, Innenvielzahn Countersunk head screws, six lobe drive Vis à tête fraisée à six lobes intérieurs	A2 A4
	DIN 7995 Z	Linsensenk-Holzschrauben, Kreuzschlitz Z - Pozidrive Cross recessed raised countersunk head wood screws - Z Vis à bois à tête fraisée bombée avec empreinte cruciforme - Z	A2
	DIN 7996 Z	Halbrund-Holzschrauben, Kreuzschlitz Z - Pozidrive Cross recessed round head wood screws - Z Vis à bois à tête ronde avec empreinte cruciforme - Z	A2
	DIN 7997 Z	Senk-Holzschrauben, Kreuzschlitz Z - Pozidrive Cross recessed countersunk head wood screws - Z Vis à bois à tête fraisée bombée avec empreinte cruciforme - Z	A2
	DIN 9021 ISO 7093	Unterlegscheiben, Außendurchmesser ~3 x Schraubendurchmesser · Washers with outside diameter ~3 x nominal thread diameter · Rondelles, diamètre extérieur ~3 x diamètre nominal de filetage	A2 A4
	DIN 11024	Federstecker, doppelte Ausführung Cotter pins Goupilles ressort double	A4
	DIN 32501/3	Schweissbolzen mit Aussengewinde Welding bolts Goujon à souder avec filetage extérieur	A2
	DIN 80701	Knebelmuttern Toggle nuts Ecrous papillon	A4
	DIN 80704	Korbmuttern Bow nuts Anneau pour sangle	A4

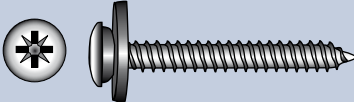
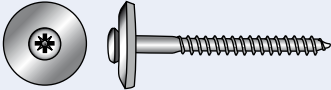
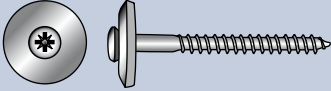
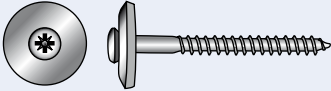
	DIN EN ISO	Bezeichnung Description	Werkstoff Material	
	Art.-Nr. 9044	Senkkopf-Spanplattenschrauben, Innenvielzahn und Bohrspitze, Fräsrippen, verstärkter Kopf, gleitbeschichtet · Countersunk head chipboard screws, six lobe drive and drilling-point, double head, waxed ribs under the head · Vis auto-perçantes pour agglomérés avec tête fraisée, à six lobes intérieurs	A2	
	Art.-Nr. 9045	Rundkopf-Spanplattenschrauben, gleitbeschichtet, Innenvielzahn Pan head chipboard screws, six lobe drive · Vis pour agglomérés avec tête cylindrique, à six lobes intérieurs	A2	A4
	Art.-Nr. 9046	Linsensenkkopf-Spanplattenschrauben, gleitbeschichtet, Innenvielzahn · Raised countersunk head chipboard screws, six lobe drive · Vis pour agglomérés avec tête fraisée bombée à six lobes intérieurs	A2	A4
	Art.-Nr. 9047	Senkkopf-Spanplattenschrauben, gleitbeschichtet, Innenvielzahn Countersunk head chipboard screws, six lobe drive Vis pour agglomérés avec tête fraisée, à six lobes intérieurs	A2	A4
	Art.-Nr. 9048	Rundkopf-Spanplattenschrauben, gleitbeschichtet, Kreuzschlitz Z - Pozidrive Coss recessed pan head chipboard screws - Z Vis pour agglomérés avec tête cylindrique - Z	A2	
	Art.-Nr. 9049	Linsensenkkopf-Spanplattenschrauben, gleitbeschichtet, Kreuzschlitz Z - Pozidrive Cross recessed raised chipboard screws - Z Vis pour agglomérés avec tête fraisée bombée - Z	A2	
	Art.-Nr. 9050	Senkkopf-Spanplattenschrauben, gleitbeschichtet, Kreuzschlitz Z - Pozidrive Cross recessed countersunk chipboard screws - Z Vis pour agglomérés avec tête fraisée - Z	A2	A4
	Art.-Nr. 9051	Blehschrauben mit Innensechskant-Zylinderkopf gem. DIN 912 · Tapping screws with head DIN 912 · Vis à tôle avec tête cylindrique DIN 912	A2	A4
	ISO 15983	Blindnieten mit Sollbruchdorn, ähnl. DIN 7337, Form A (Flachkopf) Blind rivets, with break mandrel · Rivets aveugles	A2	
	ISO 7380-1	Linsenkopfschrauben mit Innensechskant Button head screws Vis à tête bombée à six pans creux	A2	A4

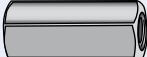
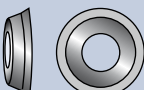

	DIN EN ISO	Bezeichnung Description	Werkstoff Material
	Art.-Nr. 9054	Karoscheiben Washers Rondelles de carrosserie	A2 A4
	Art.-Nr. 9055	Dichtscheiben für Senkschrauben, mit EPDM-Beschichtung · Sealing washers for countersunk screws with EPDM coating / Rondelles d'étanchéité	A2
	Art.-Nr. 9055	Dichtscheiben für Senkschrauben mit EPDM-Beschichtung, Kupfer · Sealing washers with EPDM coating, for countersunk screws, copper · Rondelles d'étanchéité	A2
	Art.-Nr. 9055	Dichtscheiben für Sechskantschrauben, mit EPDM-Beschichtung · Sealing washers for hexagon bolts, with EPDM coating · Rondelles d'étanchéité	A2
	Art.-Nr. 9056	Becherschrauben NF E 27-128 Slotted mushroom head screws Vis à tête bombée, fendue	A2
	Art.-Nr. 9057 A	Fassadenbauschrauben A (mit Spitze) mit aufgezogener U-Scheibe aus Edelstahl und aufvulkanisierter EPDM-Dichtung Self-sealing cladding screws · Vis de façades	A2
	Art.-Nr. 9057 BZ	Fassadenbauschrauben BZ (mit Zapfen) mit aufgezogener U-Scheibe aus Edelstahl und aufvulkanisierter EPDM-Dichtung Self-sealing cladding screws · Vis de façades	A2
	Art.-Nr. 9058	Gewindeeinsätze, selbstschneidend Selftapping inserts Douilles filetées, auto-taraudage	A2
	Art.-Nr. 9059 A	Fassadenbauschrauben A (mit Spitze) mit aufgezogener U-Scheibe aus Edelstahl und aufvulkanisierter EPDM-Dichtung Self-sealing cladding screws · Vis de façades	A2
	Art.-Nr. 9059 BZ	Fassadenbauschrauben BZ (mit Zapfen) mit aufgezogener U-Scheibe aus Edelstahl und aufvulkanisierter EPDM-Dichtung Self-sealing cladding screws · Vis de façades	A2
	Art.-Nr. 9060	Anschweissmuttern, Ausführung A, Schweissbuckel-Richtung unten Weld-on nuts - A · Ecrrous souder entièrement filetés - A	A2
	Art.-Nr. 9061	Hülsenmuttern mit Schlitz, Linsensenkopf Sleeve nuts, threaded inside Ecrrous à douille fendus	A2 A4

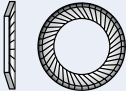
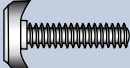
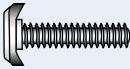
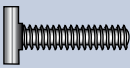
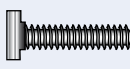
	DIN EN ISO	Bezeichnung Description	Werkstoff Material
	Art.-Nr. 9063	Scharnierbandschrauben, Kopf Ø 5,0 mm Hinge tape chipboard screws, head 5,0 mm Vis Agglo. T.F pour charnieres	A2 A4
	Art.-Nr. 9064	Setzmuttern Insert-press nuts Ecrous à sertir, six pans	A2
	Art.-Nr. 9065	Blechschrauben mit Kappenkopf, ähnlich DIN 7981,- Kreuzschlitz H - Phillips Self tapping screws with caphead, similar to DIN 7981 Vis à tôle avec tête de calotte	A2
	Art.-Nr. 9066	Fensterbankschrauben mit Blechschaubenge- winde fertig montiert mit Polyamid-Unterleg- scheiben, Kappenkopf ähnl. DIN 7981, Kreuz- schlitz Z - Pozidrive Special screws for window boards mounted with polyamid washers, self tapping thread - Z Vis spéciales pour fenêtres montée avec rondelles polyamid en version: filetage vis tôle - Z	A2
	Art.-Nr. 9067 TX 9087	Spenglerschrauben / 15, (DIN 7995 Z mit auf- vulkanisierter EPDM Dichtscheibe, fertig montiert) Cross recessed raised countersunk head wood screws (DIN 7995 Z) + sealing washers Vis bois (DIN 7995 Z) avec rondelles EPDM	A2
	Art.-Nr. 9068	Spenglerschrauben / 20, (DIN 7995 Z mit auf- vulkanisierter EPDM Dichtscheibe, fertig montiert) Cross recessed raised countersunk head wood screws (DIN 7995 Z) + sealing washers Vis bois (DIN 7995 Z) avec rondelles EPDM	A2
	Art.-Nr. 9069 TX 9089	Spenglerschrauben / 25, (DIN 7995 Z mit auf- vulkanisierter EPDM Dichtscheibe, fertig montiert) Cross recessed raised countersunk head wood screws (DIN 7995 Z) + sealing washers Vis bois (DIN 7995 Z) avec rondelles EPDM	A2
	Art.-Nr. 9070	Gewindemuffen mit durchgehendem Innenge- winde, runde Ausführung Round coupler nuts · Ecrous rondes de jonction	A2 A4
	Art.-Nr. 9071	Gewindemuffen mit durchgehendem Innenge- winde, Sechskant-Ausführung Hexagon coupler nuts · Ecrous hexagonaux de jonction	A2 A4
	Art.-Nr. 27-619	Rosetten, Vollmetall NF E 27-619 Rosettes, turned full body, 90° Rondelles cuvettes usince	A2 A4

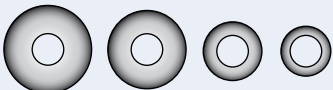
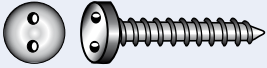
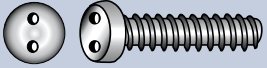
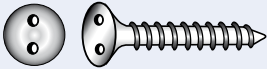
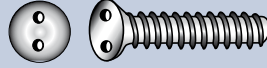
	DIN EN ISO	Bezeichnung Description	Werkstoff Material
	Art.-Nr. 9082	Stockschrauben mit Holz- und ISO-Gewinde Dowel screws with wood and ISO thread Vis sans tête avec filetage à bois et métaux (ISO)	A2 A4
	Art.-Nr. 9083	Türbandschrauben, Rundkopf, Innenvielzahn Hinge-strip screws Vis de penture	A2
	ISO 7380-2	Linsenkopfschrauben mit Innensechskant und Flansch ISO 7380 F · Flange button head socket screws Vis à creux, tête bombée à embase	A2 A4
	Art.-Nr. 9085	Kombimuttern mit beweglicher Scheibe Nut-and-washer assembly Ecrous sertis sur rondelle	A2
	Art.-Nr. 9086	Fassadenschrauben "Trespo" mit Innen- vielzahn TX 20 · Thrushead screws for wood constructions - TX 20 · Vis de façades - TX 20	A2
	Art.-Nr. 9087	Spenglerschrauben / 15, (DIN 7995 TX mit auf- vulkanisierter EPDM Dichtscheibe, fertig montiert), Innenvielzahn · Raised countersunk head wood screws (DIN 7995 TX) + sealing washers, six lobe drive · Vis bois (DIN 7995 TX) avec rondelles EPDM, à six lobes intérieurs	A2
	Art.-Nr. 9088	Spenglerschrauben / 20, (DIN 7995 TX mit auf- vulkanisierter EPDM Dichtscheibe, fertig montiert), Innenvielzahn · Raised countersunk head wood screws (DIN 7995 TX) + sealing washers, six lobe drive · Vis bois (DIN 7995 TX) avec rondelles EPDM, à six lobes intérieurs	A2
	Art.-Nr. 9089	Spenglerschrauben / 25, (DIN 7995 TX mit auf- vulkanisierter EPDM Dichtscheibe, fertig montiert), Innenvielzahn · Raised countersunk head wood screws (DIN 7995 TX) + sealing washers, six lobe drive · Vis bois (DIN 7995 TX) avec rondelles EPDM, à six lobes intérieurs	A2
	Art.-Nr. 9090	Schrauben für Thermoplaste (TP) mit Senkkopf, Kreuzschlitz H - Phillips TP screws, countersunk head, cross recessed - H Vis - TP - à tête fraisée avec empreinte cruciforme - H	A2
	Art.-Nr. 9091	Schrauben für Thermoplaste (TP) mit Linsenkopf, Kreuzschlitz H - Phillips TP screws, pan head, cross recessed - H Vis - TP - à tête bombée avec empreinte cruciforme - H	A2
	Art.-Nr. 9092	Fassadenschrauben, HI-LO Gewinde und Zentrierspitze, Kreuzschlitz H - Phillips Cladding screws, HI-LO thread and center point - H Vis de Bardage Double Filet - H	A2

	DIN EN ISO	Bezeichnung Description	Werkstoff Material
	Art.-Nr. 9093	Schnorr-Sicherungsscheiben "S" Schnorr safety-washers type "S" Rondelles de sécurité "S"	A2
	Art.-Nr. 9094	Ankerschienenschrauben für Profil 50/30 mit Sechskantmutter nach DIN 934 Hammer head screws for special purposes Vis de suspension avec écrou hexagonal	A4
	Art.-Nr. 9095	Ankerschienenschrauben für Profil 40/22 mit Sechskantmutter nach DIN 934 Hammer head screws for special purposes Vis de suspension avec écrou hexagonal	A4
	Art.-Nr. 9096	Ankerschienenschrauben für Profil 38/17 mit Sechskantmutter nach DIN 934 Hammer head screws for special purposes Vis de suspension avec écrou hexagonal	A4
	Art.-Nr. 9097	Ankerschienenschrauben für Profil 28/15 mit Sechskantmutter nach DIN 934 Hammer head screws for special purposes Vis de suspension avec écrou hexagonal	A2 A4
	NF E 25-511	AFNOR-Kontaktscheiben, Form M AFNOR contact washers, type M Rondelles de serrage AFNOR	A2
	NF E 25-514	AFNOR-Scheiben AFNOR washers Rondelles AFNOR	A2 A4
Art.- Nr.	Sicherheitsschrauben Security screws	Werkstoff Material	
	Art.-Nr. 9100	Blehschrauben mit ZWEILOCH-ANTRIEB, Linsenkopf Panhead Security screws TWO-HOLE-DRIVE · Vis métaux TC-2 trous	A2
	Art.-Nr. 9101	Metrische Schrauben mit ZWEILOCH-ANTRIEB, Linsenkopf Panhead · Security screws TWO-HOLE-DRIVE Vis métaux TC-2 trous	A2
	Art.-Nr. 9102	Blehschrauben mit ZWEILOCH-ANTRIEB, Senkkopf Flathead Security screws TWO-HOLE-DRIVE · Vis métaux TC-2 trous	A2
	Art.-Nr. 9103	Metrische Schrauben mit ZWEILOCH-ANTRIEB, Senkkopf Flathead Security screws TWO-HOLE-DRIVE · Vis métaux TC-2 trous	A2

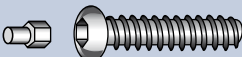
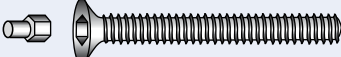
	Art.- Nr.	Sicherheitsschrauben Security screws	Werkstoff Material
	Art.-Nr. 9104	Blechschauben mit ZWEILOCH-ANTRIEB, Linsensenkkopf Ovalhead Security screws TWO-HOLE-DRIVE · Vis tôle TFB-2 trous	A2
	Art.-Nr. 9105	Blechschauben mit ZWEILOCH-ANTRIEB, Flachrundkopf Trusshead · Security screws TWO-HOLE-DRIVE · Vis tôle tête bombée - 2 trous	A2
	Art.-Nr. 9110	Blechschauben mit INNENSECHSKANT und SICHERHEITS-PIN, Flachrundkopf Buttonhead security screws PIN-HEXAGON Vis tôle tête bombée 6 pans creux + Téton	A2
	Art.-Nr. 9111	Metrische Schrauben (ISO 7380) mit INNENSECHS- KANT und SICHERHEITS-PIN, Flachrundkopf Buttonhead security screws PIN-HEXAGON Vis métaux tête bombée HC + Téton	A2
	Art.-Nr. 9112	Blechschauben mit INNENSECHSKANT und SICHERHEITS-PIN, Senkkopf, Flathead Security screws PIN-HEXAGON Vis tôle TF 6 pans creux + Téton	A2
	Art.-Nr. 9113	Metrische Schrauben (ISO 7991) mit INNENSECHS- KANT und SICHERHEITS-PIN, Senkkopf, Flathead Security screws PIN-HEXAGON · Vis métaux TFHC + Téton	A2
	Art.-Nr. 9120	Blechschauben mit INNENVIELZAHN und SICHERHEITS-PIN, Flachrundkopf, Buttonhead Security screws PIN-TX · Vis tôle tête bombée TX + Téton	A2
	Art.-Nr. 9121	Metrische Schrauben (ISO 7380) mit INNENVIEL- ZAHN und SICHERHEITS-PIN, Flachrundkopf, Buttonhead · Security screws PIN-TX Vis métaux tête bombée TX + Téton	A2
	Art.-Nr. 9122	Blechschauben mit INNENVIELZAHN und SICHERHEITS-PIN, Senkkopf, Flathead Security screws PIN-TX · Vis tôle TF TX + Téton	A2
	Art.-Nr. 9123	Metrische Schrauben (DIN 7991) mit INNENVIEL- ZAHN und SICHERHEITS-PIN, Senkkopf, Flathead Security screws PIN-TX · Vis métaux TF TX + Téton	A2
	Art.-Nr. 9130	Blechschauben mit EINWEGANTRIEB, Halbrund- kopf, Roundhead Security screws ONEWAY · Vis tôle TC fente SENS UNIQUE	A2
	Art.-Nr. 9131	Metrische Schrauben (DIN 7991) mit EINWEG- ANTRIEB, Halbrundkopf, Roundhead · Security screws ONEWAY · Vis métaux TC fente SENS UNIQUE	A2

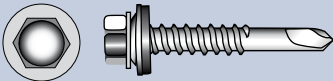
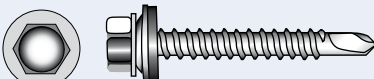
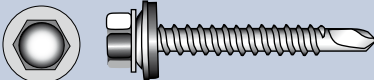
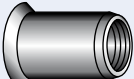
	Art.- Nr.	Sicherheitsschrauben Security screws	Werkstoff Material
	Art.-Nr. 9132	Blechschrauben mit EINWEGANTRIEB, Linsensenkopf, Ovalhead · Security screws ONEWAY · Vis tôle TFB fente SENS UNIQUE	A2
	Art.-Nr. 9140	Metrische Schrauben (ISO 7380) mit SCHLIESSKOPF, Flachrundkopf, Buttonhead · Hexagon socket screws with plug · Vis métaux bombée HC avec bouchon à téton blocage au marteau	A2
	Art.-Nr. 9141	Metrische Schrauben (ISO 7991) mit SCHLIESSKOPF, Senkkopf, Countersunk-head · Hexagon socket screws with plug · Vis métaux bombée HC avec bouchon à téton blocage au marteau	A2
	Art.-Nr. 9150	Abreissmuttern Inviolable nuts Ecrous autocassants	A2
	DIN EN ISO	Bezeichnung Description	Werkstoff Material
	Art.-Nr. 1001	A4 Stabdeckschrauben, Flachsenkkopf mit TORX-Antrieb · Marine-woodloor-screws with TORX-drive · Vis pour sol de bois	A4
	Art.-Nr. 1017	Bohrschrauben mit Sechskantkopf für kaltgewalzte Profile bis 3,5 mm Stärke Hexagon head self-drilling screws, drill capacity up to 3.5 mm material thickness · Visauto-percantes, tête hexagonale, profil épaisseur jusque à 3,5 mm	A2
	Art.-Nr. 1018	Bohrschrauben mit Sechskantkopf für kaltgewalzte Profile bis 6,0 mm Stärke Hexagon head self-drilling screws, drill capacity up to 6.0 mm material thickness · Visauto-percantes, tête hexagonale, profil épaisseur jusque à 6,0 mm	A2
	Art.-Nr. 1020	Bohrschrauben mit Sechskantkopf für warmgewalzte Profile bis 6,0 - 12,5 mm Stärke Hexagon head self-drilling screws, drill capacity from 6.0 up to 12.5 mm material thickness · Visauto-percantes, tête hexagonale, profil épaisseur 6,0mm jusque à 12,5 mm	A2
	Art.-Nr. 1021	Universal-Blind-Einnietmuttern, kleiner Senkkopf Blind rivet nuts, small flat head ecrous rivet aveugle	A2

Bolzenanker Wedge anchor



1024

Bolzenanker BZ für gerissenen und ungerissenen Beton / A4-AISI 316

Wedge anchor BZ for cracked and non-cracked concrete / Boulon d'ancrage

Bestell-Nr. Order no.	Bezeichnung Description	Bolzenanker Ø Wedge anchor Ø	Gesamtlänge Total length	Gewinde Thread	Klemmstärke Fixture thickness	Effektive Verankerungstiefe Effective anchorage depth	Bohrlochtiefe Depth of drill hole	Zulässige Zuglasten in KN in gerissemem Beton C 20/25 Permitted tension load in KN in cracked concrete C 20/25	Zulässige Zuglasten in KN in ungerissemem Beton C 20/25 Permitted tension load in KN in non-cracked concrete C 20/25	Box	*€/Stück *€/piece
1024408 10	BZ 8-10/75	8	75	M8x20	10	46	60	2,4	5,7	100	2,90
1024408 15	BZ 8-15/80	8	80	M8x25	15	46	60	2,4	5,7	100	3,00
1024410 10	BZ 10-10/90	10	90	M10x20	10	75	75	4,3	7,6	50	4,00
1024410 15	BZ 10-15/95	10	95	M10x25	15	60	75	4,3	7,6	50	4,20
1024410 30	BZ 10-30/110	10	110	M10x40	30	60	75	4,3	7,6	50	4,80
1024412 15	BZ 12-15/110	12	110	M12x30	15	65	90	5,7	9,5	25	6,80
1024412 30	BZ 12-30/125	12	125	M12x45	30	65	90	5,7	9,5	25	7,20
1024412 50	BZ 12-50/145	12	145	M12x65	50	65	90	5,7	9,5	25	8,80
1024416 25	BZ 16-25/145	16	145	M16x45	25	85	110	11,9	16,7	20	14,00

Bolzenanker Wedge anchor



1025

Bolzenanker B für ungerissenen Beton / A4-AISI 316

Wedge anchor B for non-cracked concrete / Boulon d'ancrage

Bestell-Nr. Order no.	Bezeichnung Description	Bolzenanker Ø Wedge anchor Ø	Gesamtlänge Total length	Gewinde Thread	Klemmstärke Fixture thickness	Verankerungstiefe Anchorage depth	Bohrlochtiefe Depth of drill hole	Zulässige Zuglasten in KN in ungerissemem Beton C 20/25 Permitted tension load in KN in non-cracked concrete C 20/25	Box	*€/Stück *€/piece
1025408 10	B 8-10-19/75	8	80	M8x22	10	44	50	5,7	100	2,90
1025408 15	B 8-15-24/80	8	85	M8x45	15	44	65	5,7	100	3,00
1025410 15	B 10-15-21/90	10	90	M10x45	15	48	70	7,6	100	4,00
1025412 15	B 12-15-30/110	12	110	M12x65	15	65	90	9,9	50	6,00
1025412 30	B 12-30-45/125	12	125	M12x70	30	65	90	9,9	25	7,20
1025416 30	B 16-30-46/150	16	150	M16x80	30	80	110	11,9	25	13,20

Einschlaganker Drop in anchor

Einschlaganker für ungerissenen Beton / A4-AISI 316
Drop-in anchor for non-cracked concrete

1026

Bestell-Nr. Order no.	Beschreibung Description	Bohrloch Ø x Tiefe Drill hole Ø x depth	Gewinde Thread	Box	*€/Stück *€/piece
1026406	E M 6	8x30	M6x13	100	2,70
1026408	E M 8	10x30	M8x13	100	3,30
1026410	E M 10	12x40	M10x15	50	4,80
1026412	E M 12	15x50	M12x18	50	8,00
1026416	E M 16	20x65	M16x23	25	15,90



Ankerstange und Mörtelpatrone Threaded stud and Chemical Capsule

Ankerstange für ungerissenen Beton / A4-AISI 316
Threaded stud for non-cracked concrete

1027

Bestell-Nr. Order no.	Beschreibung Description	Gewinde Thread	Bohrloch Ø x Tiefe Drill hole Ø x depth	Max. Klemmstärke Max. fixture thickness	Box	*€/Stück *€/piece
1027408	8-20/110	M8	10x80	20	10	2,80
1027410	10-30/130	M10	12x90	30	10	4,40
1027412	12-35/160	M12	14x110	35	10	6,80
1027416	16-20/165	M16	18x125	20	10	13,20



Mörtelpatrone für ungerissenen Beton
Chemical capsule for non-cracked concrete

1028

Bestell-Nr. Order no.	Beschreibung Description	Für Gewinde For thread	Box	*€/Stück *€/piece
102808	V-P 8	M8	10	1,60
102810	V-P 10	M10	10	1,70
102812	V-P 12	M12	10	1,80
102816	V-P 16	M16	10	2,30





Marinotech Edelstahlhandel GmbH & Co. KG

D-28777 Bremen · Am Rönnebecker Hain 6

Fon: +49-421-69056-0 · Fax: +49-421-69056-50

www.marinotech.de · info@marinotech.de